



Lista PVP - España

Updated Actualizada  
1 / 1 / 2024

## Intellectual Property Guarantee

All designs are original and to owned by Andreu World, S.L.

All models comprising furniture collections with the trademark "Andreu World" are protected by industrial design registries, design patents, copyrights and intellectual property rights worldwide. Only Andreu World, S.L. and persons or companies authorized by Andreu World have the right to use these protected designs.

With the aim of defending quality, protecting originality and emphasizing the value of each of these designs, Andreu World, S.L. with the interest of its customers, suppliers, employees, designers and stakeholders, will exercise any and all legal actions as may be necessary against anyone who manufactures, offers, uses, sells, purchases, imports or exports any products using Andreu World, S.L. designs without the company's express written permission.

To purchase furniture with the Andreu World trademark, please only address authorized dealers or distributors of Andreu World. If you are unsure of the origin of a furniture piece, please consult the official dealers and sale point list at [www.andreuworld.com](http://www.andreuworld.com) or contact us directly by phone on +34961805700 or e-mail us at: [aworld@andreuworld.com](mailto:aworld@andreuworld.com)

## Garantía de Propiedad Intelectual

Todos los diseños son originales y propiedad de Andreu World, S.L.

La totalidad de los modelos que componen las colecciones de muebles con marca "Andreu World" están protegidos por registros de diseño industrial, design patent, copyright y derechos de propiedad intelectual en todo el mundo. Sólo Andreu World, S.L. y las personas o mercantiles autorizadas por Andreu World tienen derecho a utilizar los diseños protegidos.

Con el objetivo de defender la calidad, reivindicar la originalidad y destacar el valor de cada uno de los diseños, Andreu World, S.L., en interés de sus clientes, proveedores, trabajadores, autores y accionistas, ejercerá las acciones legales oportunas contra todo aquel que, sin su autorización y de cualquier forma, fabrique, oferte, use, comercialice, compre, importe o exporte productos que incorporen sus diseños.

Para adquirir muebles de la marca "AndreuWorld" diríjase sólo a representantes autorizados o distribuidores oficiales de Andreu World. Si tiene alguna duda sobre la procedencia de la pieza, consulte el listado oficial de distribuidores y puntos de venta de Andreu World en [www.andreuworld.com](http://www.andreuworld.com) o contacte directamente con nosotros a través del teléfono: +34961805700 o vía e-mail: [aworld@andreuworld.com](mailto:aworld@andreuworld.com)

1	Fabrics Tapicerías	7	Fabrics Tapicerías		Woven Bands Cincha		Stackable on the floor Apilable sobre suelo
2	Fabrics Tapicerías	8	Fabrics Tapicerías	TP	Thermo-polymer Termopolímero		Stackable on trolley Apilable sobre carro
3	Fabrics Tapicerías	9	Fabrics Tapicerías				
4	Fabrics Tapicerías	10	Fabrics Tapicerías				
5	Fabrics Tapicerías	11	Fabrics Tapicerías				
6	Fabrics Tapicerías						

Seating Collection  
Colección de Asientos

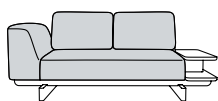

**Afuera Modular Sofa** 9  
**NEW**

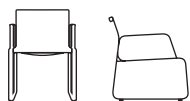

**Aire Outdoor** 33



**Costa Chair** 35

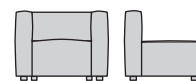

**Dado Outdoor** **NEW** 39



**Flex Outdoor** 45



**Gala Pure Eco** 47

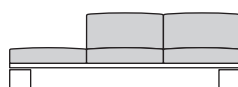

**Landscape Alu** 49



**Liceo Outdoor** **NEW** 53



**Marina** 55

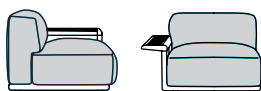

**Nilo Modular Sofa** 59  
**NEW**



**Nuez Outdoor** 81



**Ronda Outdoor** 85



**Sail** 87

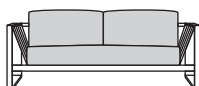

**Sand** 89

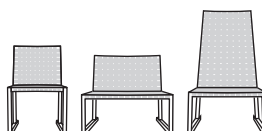

**Serena Iroko** 93



**Siesta** 97



**Trenza** 105

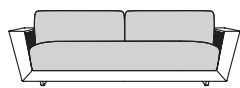

**Uves Sofa** **NEW** 109

**Base Collection**  
**Colección de bases**

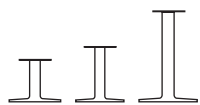

**Dual Outdoor** 113

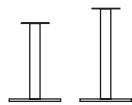

**Plaza** 117



**Quattro** 121



**Reverse** 125



**Solid** 129

**Table tops**  
**Sobres de mesa**



**Top Compacto HPL** 133



**Top Glass 10** 135



**Top Solid Surface** 137



**Top Iroko** 139



**Top Technical Stone** 141



**Top Terrazzo** 143

**Tables Occasional  
Mesas ocasionales**



**Dual Occasional** 147



**Quattro Occasional** 149



**Raglan Table** 151

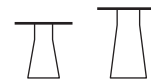

**Reverse Occasional** 153



**Reverse TP** 157

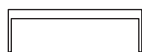

**Sand** 159

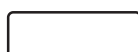

**Siesta Outdoor** 161

**Table Programs  
Programas de mesa**



**Wind Outdoor** 165

<b>Sales conditions/Remarks</b>	168
<b>Maintenance</b>	170
<b>Certificate</b>	172

<b>Condiciones venta/Obs.</b>	169
<b>Mantenimiento</b>	171
<b>Certificados</b>	172

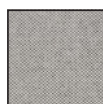

<b>Fabrics Tapicerías</b>	173
-------------------------------	-----





**Chairs**

**Sillas**





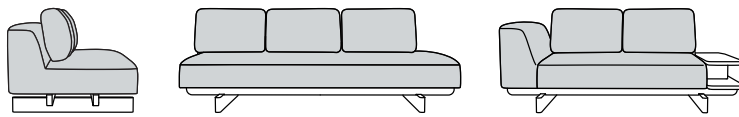

**Description**  
**Descripción**

Modular upholstered 2 and 3-seater sofa with solid iroko wood base and different module options: linear or angular, seat and backrest, open seat and backrest, with upholstered arm or solid iroko wood table available in 2 heights. Valid for outdoor use.

Sofá modular tapizado de 2 y 3 plazas con base de madera maciza de iroko y diferentes opciones de módulos: lineal o angular, de asiento y respaldo, asiento y respaldo abierto, con brazo tapizado o mesa de madera maciza de iroko disponible en 2 alturas. Válido para su uso en exterior.

**Upholstery**  
**Tapicería**

Andreu World collections use various types of upholstery in acrylic and faux leather that are especially designed for outdoor use. The covers and cushions are made of waterproof polyester fabric to protect the furniture from moisture, rain, and sun. For fabrics in our catalogue not specified in this box or customers own materials please contact our Customer Service Department.

En las colecciones de Andreu World Outdoor se han utilizado distintos tipos de tapicerías de fibra acrílica y ecopiel, especialmente concebidas para su uso en exterior. Los cojines y fundas están confeccionados con un tejido de máxima calidad que repele el agua, es resistente a los rayos UV y al moho.

**Fabrics / Telas**

- 1** Sand  
Reel One
- 2** Solid & Stripes  
Tack One
- 3** Natte  
Loom Two  
Mezzo  
Reel two
- 4** Heritage  
Savane  
Reel Three  
Reel Four

- 6** Chartres  
Zori  
Patio  
Tack Two  
Tack Three
- 7** Tack Five
- 8** Domino  
Lopi
- 9** Tack Four

**Faux Leather / Ecopiel**

- 2** Silvertex
- 3** Maglia
- 10** Coast

**Wood finish Iroko**  
**Acabado madera Iroko**

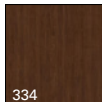

334

**Intellectual property Propiedad intelectual**

All our collections are protected by international industrial design registries, designs patents, copyrights and intellectual Property laws. Unauthorized use of AW International Property is a criminal offence and can lead to prosecution.

Todas nuestras colecciones están protegidas por registros de diseño industrial, diseño de patente, copyright y derechos de propiedad intelectual en todo el mundo. El uso no autorizado de los diseños y propiedad intelectual de AW supone un delito que puede ser sometido a acción judicial.



**SF2461** **NEW**

2-seater sofa with upholstered seat, back and arms. Solid iroko wood base. The sofa always has back cushions (x2 units).  
Sofá de 2 plazas con asiento, respaldo y brazos tapizados. Base de madera maciza de iroco. El sofá siempre lleva cojines de respaldo (x2uds).

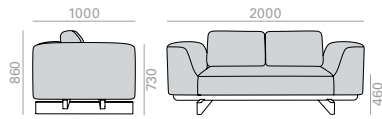

	COM cm. per unit
1 units	1040
10 units or more	1040

1'64 m3  
70 kg  
x1

COM	1	2	3	4	5	6	7	8	9	10	11	
€	4.210	4.465	4.577	4.666	4.818	4.969	5.121	5.274	5.426	5.577	5.731	5.882

**SF2462** **NEW**

2-seater sofa with upholstered seat, backrest and left arm. Base and right side table made of solid iroko wood. The sofa always has back cushions (x2 units).  
Sofá de 2 plazas con asiento, respaldo y brazo izquierdo tapizados. Base y mesa auxiliar derecha de madera maciza de iroco. El sofá siempre lleva cojines de respaldo (x2uds).

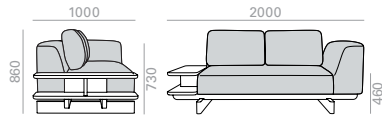

	COM cm. per unit
1 units	830
10 units or more	830

1'64 m3  
70 kg  
x1

COM	1	2	3	4	5	6	7	8	9	10	11	
€	4.445	4.648	4.739	4.810	4.931	5.052	5.174	5.295	5.416	5.537	5.660	5.781

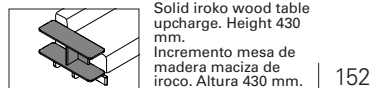

Solid iroko wood table upcharge. Height 430 mm. Incremento mesa de madera maciza de iroco. Altura 430 mm.

152

**SF2463** **NEW**

2-seater sofa with upholstered seat, backrest and right arm. Base and left side table made of solid iroko wood. The sofa always has back cushions (x2 units).  
Sofá de 2 plazas con asiento, respaldo y brazo derecho tapizados. Base y mesa auxiliar izquierda de madera maciza de iroco. El sofá siempre lleva cojines de respaldo (x2uds).

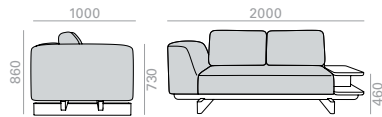

	COM cm. per unit
1 units	830
10 units or more	830

1'64 m3  
70 kg  
x1

COM	1	2	3	4	5	6	7	8	9	10	11	
€	4.445	4.648	4.739	4.810	4.931	5.052	5.174	5.295	5.416	5.537	5.660	5.781

**SF2464** **NEW**

2-seater terminal module with upholstered seat, backrest and left armrest. Solid iroko wood base. The sofa always has back cushions (x2 units).  
Módulo terminal de 2 plazas con asiento, respaldo y brazo izquierdo tapizados. Base de madera maciza de iroco. El sofá siempre lleva cojines de respaldo (x2uds).

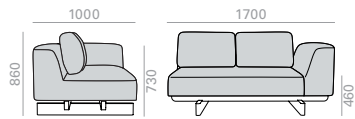

	COM cm. per unit
1 units	830
10 units or more	830

1'4 m3  
70 kg  
x1

COM	1	2	3	4	5	6	7	8	9	10	11	
€	3.690	3.894	3.984	4.055	4.176	4.298	4.419	4.540	4.661	4.784	4.905	5.026

**SF2465** **NEW**

2-seater terminal module with upholstered seat, backrest and right armrest. Solid iroko wood base. The sofa always has back cushions (x2 units).

Módulo terminal de 2 plazas con asiento, respaldo y brazo derecho tapizados. Base de madera maciza de iroco. El sofá siempre lleva cojines de respaldo (x2uds).

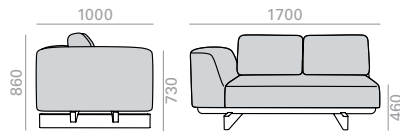

	COM cm. per unit
1 units	830
10 units or more	830

1'4 m3  
60 kg  
x1

COM	1	2	3	4	5	6	7	8	9	10	11	
€	3.690	3.894	3.984	4.055	4.176	4.298	4.419	4.540	4.661	4.784	4.905	5.026

**SF2466** **NEW**

2-seater terminal module with upholstered seat and backrest. Base and left side table made of solid iroko wood. The sofa always has back cushions (x2 units).

Módulo terminal de 2 plazas con asiento, respaldo tapizados. Base y mesa auxiliar izquierda de madera maciza de iroco. El sofá siempre lleva cojines de respaldo (x2uds).

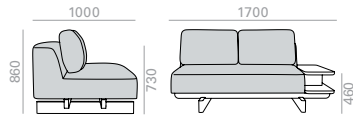

	COM cm. per unit
1 units	400
10 units or more	400

1'4 m3  
60 kg  
x1

COM	1	2	3	4	5	6	7	8	9	10	11	
€	3.927	4.079	4.147	4.200	4.290	4.381	4.471	4.561	4.653	4.744	4.834	4.924

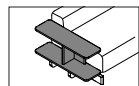

Solid iroko wood table upcharge. Height 430 mm. Incremento mesa de madera maciza de iroco. Altura 430 mm.

152

**SF2467** **NEW**

2-seater terminal module with upholstered seat and backrest. Base and right side table made of solid iroko wood. The sofa always has back cushions (x2 units).

Módulo terminal de 2 plazas con asiento, respaldo tapizados. Base y mesa auxiliar derecha de madera maciza de iroco. El sofá siempre lleva cojines de respaldo (x2uds).

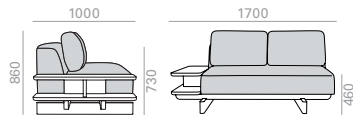

	COM cm. per unit
1 units	400
10 units or more	400

1'4 m3  
60 kg  
x1

COM	1	2	3	4	5	6	7	8	9	10	11	
€	3.927	4.079	4.147	4.200	4.290	4.381	4.471	4.561	4.653	4.744	4.834	4.924

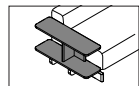

Solid iroko wood table upcharge. Height 430 mm. Incremento mesa de madera maciza de iroco. Altura 430 mm.

152

**SF2468** **NEW**

2-seater terminal module with upholstered seat and backrest. Solid iroko wood base. The sofa always has back cushions (x2 units).

Módulo terminal de 2 plazas con asiento y respaldo tapizados. Base de madera maciza de iroco. El sofá siempre lleva cojines de respaldo (x2uds).

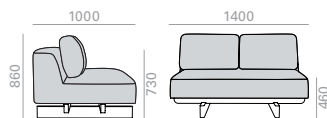

	COM cm. per unit
1 units	400
10 units or more	400

1'16 m3  
50 kg  
x1

COM	1	2	3	4	5	6	7	8	9	10	11	
€	3.156	3.308	3.376	3.429	3.519	3.610	3.700	3.792	3.882	3.973	4.063	4.153

SF2469 **NEW**

3-seater sofa with upholstered seat, back and arms. Solid iroko wood base. The sofa always has back cushions (x3 units).

Sofá de 3 plazas con asiento, respaldo y brazos tapizados. Base de madera maciza de iroco. El sofá siempre lleva cojines de respaldo (x3uds).

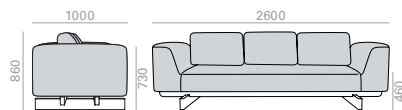

	COM cm. per unit
1 units	1265
10 units or more	1265

2'11 m3  
85 kg  
x1

COM	1	2	3	4	5	6	7	8	9	10	11	
€	5.018	5.327	5.465	5.573	5.758	5.942	6.127	6.313	6.498	6.682	6.868	7.053

SF2470 **NEW**

3-seater sofa with upholstered seat, backrest and left arm. Base and right side table made of solid iroko wood. The sofa always has back cushions (x3 units).

Sofá de 3 plazas con asiento, respaldo y brazo izquierdo tapizados. Base y mesa auxiliar derecha de madera maciza de iroco. El sofá siempre lleva cojines de respaldo (x3uds).

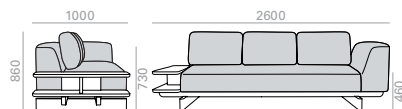

	COM cm. per unit
1 units	1055
10 units or more	1055

2'11 m3  
85 kg  
x1

COM	1	2	3	4	5	6	7	8	9	10	11	
€	5.273	5.531	5.645	5.735	5.889	6.044	6.197	6.352	6.506	6.660	6.815	6.969

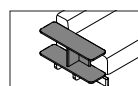

Solid iroko wood table upcharge. Height 430 mm. Incremento mesa de madera maciza de iroco. Altura 430 mm.

152

SF2471 **NEW**

3-seater sofa with upholstered seat, backrest and right arm. Base and left side table made of solid iroko wood. The sofa always has back cushions (x3 units).

Sofá de 3 plazas con asiento, respaldo y brazo derecho tapizados. Base y mesa auxiliar izquierda de madera maciza de iroco. El sofá siempre lleva cojines de respaldo (x3uds).

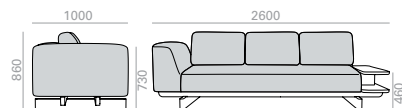

	COM cm. per unit
1 units	1055
10 units or more	1055

2'11 m3  
85 kg  
x1

COM	1	2	3	4	5	6	7	8	9	10	11	
€	5.273	5.531	5.645	5.735	5.889	6.044	6.197	6.352	6.506	6.660	6.815	6.969

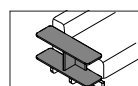

Solid iroko wood table upcharge. Height 430 mm. Incremento mesa de madera maciza de iroco. Altura 430 mm.

152

SF2472 **NEW**

3-seater terminal module with upholstered seat, backrest and left armrest. Solid iroko wood base. The sofa always has back cushions (x3 units).

Módulo terminal de 3 plazas con asiento, respaldo y brazo izquierdo tapizados. Base de madera maciza de iroco. El sofá siempre lleva cojines de respaldo (x3uds).

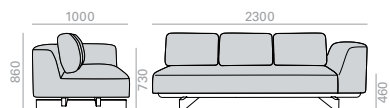

	COM cm. per unit
1 units	1055
10 units or more	1055

1'88 m3  
75 kg  
x1

COM	1	2	3	4	5	6	7	8	9	10	11	
€	4.469	4.727	4.842	4.932	5.085	5.240	5.395	5.548	5.703	5.858	6.011	6.166

SF2473 **NEW**

3-seater terminal module with upholstered seat, backrest and right armrest. Solid iroko wood base. The sofa always has back cushions (x3 units).

Módulo terminal de 3 plazas con asiento, respaldo y brazo derecho tapizados. Base de madera maciza de iroco. El sofá siempre lleva cojines de respaldo (x3uds).

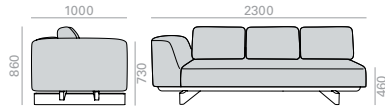

	COM cm. per unit
1 units	1055
10 units or more	1055

1'88 m3  
75 kg  
x1

COM	1	2	3	4	5	6	7	8	9	10	11	
€	4.469	4.727	4.842	4.932	5.085	5.240	5.395	5.548	5.703	5.858	6.011	6.166

SF2474 **NEW**

3-seater terminal module with upholstered seat, backrest and right armrest. Solid iroko wood base. The sofa always has back cushions (x3 units).

Módulo terminal de 3 plazas con asiento, respaldo tapizados. Base y mesa auxiliar izquierda de madera maciza de iroco. El sofá siempre lleva cojines de respaldo (x3uds).

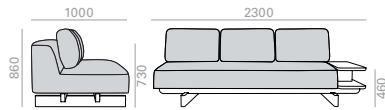

	COM cm. per unit
1 units	845
10 units or more	845

1'88 m3  
75 kg  
x1

COM	1	2	3	4	5	6	7	8	9	10	11	
€	4.627	4.835	4.927	4.998	5.123	5.247	5.369	5.494	5.616	5.740	5.865	5.987

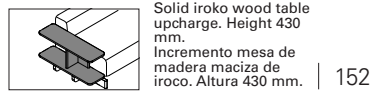

Solid iroko wood table upcharge. Height 430 mm. Incremento mesa de madera maciza de iroco. Altura 430 mm. | 152 |

SF2475 **NEW**

3-seater terminal module with upholstered seat and backrest. Base and left side table made of solid iroko wood. The sofa always has back cushions (x3 units).

Módulo terminal de 3 plazas con asiento, respaldo tapizados. Base y mesa auxiliar izquierda de madera maciza de iroco. El sofá siempre lleva cojines de respaldo (x3uds).

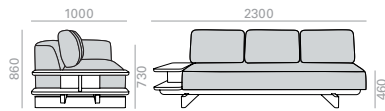

	COM cm. per unit
1 units	845
10 units or more	845

1'88 m3  
75 kg  
x1

COM	1	2	3	4	5	6	7	8	9	10	11	
€	4.627	4.835	4.927	4.998	5.123	5.247	5.369	5.494	5.616	5.740	5.865	5.987

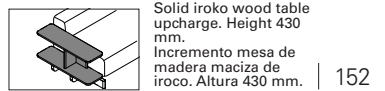

Solid iroko wood table upcharge. Height 430 mm. Incremento mesa de madera maciza de iroco. Altura 430 mm. | 152 |

SF2476 **NEW**

3-seater terminal module with upholstered seat and backrest. Base and right side table made of solid iroko wood. The sofa always has back cushions (x3 units).

Módulo terminal de 3 plazas con asiento, respaldo tapizados. Base de madera maciza de iroco. El sofá siempre lleva cojines de respaldo (x3uds).

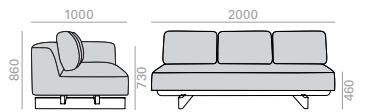

	COM cm. per unit
1 units	845
10 units or more	845

1'64 m3  
70 kg  
x1

COM	1	2	3	4	5	6	7	8	9	10	11	
€	3.932	4.140	4.231	4.303	4.427	4.550	4.674	4.798	4.921	5.045	5.168	5.292

SF2477 **NEW**

3-seater terminal module with upholstered seat and backrest. Solid iroko wood base. The sofa always has back cushions (x3 units).  
 Módulo terminal isla izquierdo de 3 plazas con asiento, respaldo y brazo izquierdo tapizados. Base de madera maciza de iroco. El sofá siempre lleva cojines de respaldo (x3uds).

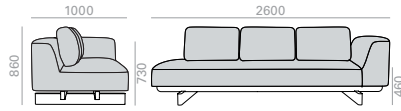

	COM cm. per unit
1 units	875
10 units or more	875

2'11 m3  
 80 kg  
 x1

COM	1	2	3	4	5	6	7	8	9	10	11	
€	4.773	4.987	5.082	5.156	5.285	5.413	5.540	5.669	5.797	5.924	6.053	6.181

SF2478 **NEW**

3-seater left island terminal module with upholstered seat, backrest and left armrest. Solid iroko wood base. The sofa always has back cushions (x3 units).  
 Módulo terminal isla izquierdo de 3 plazas con asiento y respaldo tapizados. Base y mesa auxiliar izquierda de madera maciza de iroco. El sofá siempre lleva cojines de respaldo (x3uds).

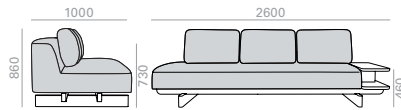

	COM cm. per unit
1 units	400
10 units or more	400

2'11 m3  
 80 kg  
 x1

COM	1	2	3	4	5	6	7	8	9	10	11
€	5.010	5.173	5.244	5.302	5.398	5.495	5.594	5.690	5.787	5.884	6.079

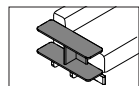

Solid iroko wood table upcharge. Height 430 mm. Incremento mesa de madera maciza de iroco. Altura 430 mm. | 152 |

SF2479 **NEW**

3-seater left island terminal module with upholstered seat and backrest. Base and left side table made of solid iroko wood. The sofa always has back cushions (x3 units).  
 Módulo terminal isla izquierdo de 3 plazas con asiento y respaldo tapizados. Base de madera maciza de iroco. El sofá siempre lleva cojines de respaldo (x3uds).

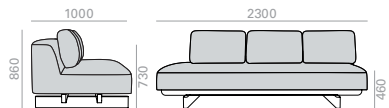

	COM cm. per unit
1 units	380
10 units or more	380

1'88 m3  
 75 kg  
 x1

COM	1	2	3	4	5	6	7	8	9	10	11	
€	4.240	4.403	4.476	4.532	4.629	4.727	4.824	4.921	5.018	5.116	5.213	5.310

SF2480 **NEW**

3-seater left island terminal module with upholstered seat and backrest. Solid iroko wood base. The sofa always has back cushions (x3 units).  
 Módulo terminal isla derecho de 3 plazas con asiento, respaldo y brazo derecho tapizados. Base de madera maciza de iroco. El sofá siempre lleva cojines de respaldo (x3uds).

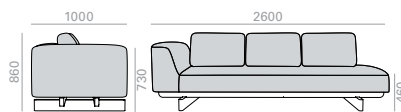

	COM cm. per unit
1 units	875
10 units or more	875

2'11 m3  
 80 kg  
 x1

COM	1	2	3	4	5	6	7	8	9	10	11	
€	4.773	4.987	5.082	5.156	5.285	5.413	5.540	5.669	5.797	5.924	6.053	6.181

SF2481 **NEW**

3-seater right island terminal module with upholstered seat and backrest. Base and right side table made of solid iroko wood. The sofa always has back cushions (x3 units).

Módulo terminal isla derecho de 3 plazas con asiento y respaldo tapizados. Base y mesa auxiliar derecho de madera maciza de iroco. El sofá siempre lleva cojines de respaldo (x3uds).

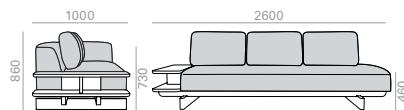

	COM cm. per unit
1 units	380
10 units or more	380

2'11 m3  
80 kg  
x1

COM	1	2	3	4	5	6	7	8	9	10	11	
€	5.010	5.173	5.244	5.302	5.398	5.495	5.594	5.690	5.787	5.884	5.982	6.079

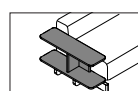

Solid iroko wood table upcharge. Height 430 mm. Incremento mesa de madera maciza de iroco. Altura 430 mm.

152

SF2482 **NEW**

3-seater right island terminal module with upholstered seat and backrest. Base and right side table made of solid iroko wood. The sofa always has back cushions (x3 units).

Módulo terminal isla derecho de 3 plazas con asiento y respaldo tapizados. Base de madera maciza de iroco. El sofá siempre lleva cojines de respaldo (x3uds).

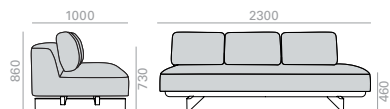

	COM cm. per unit
1 units	380
10 units or more	380

1'88 m3  
75 kg  
x1

COM	1	2	3	4	5	6	7	8	9	10	11	
€	4.240	4.403	4.476	4.532	4.629	4.727	4.824	4.921	5.018	5.116	5.213	5.310

SF2483 **NEW**

3-seater 45° angular terminal module with upholstered seat, backrest and left arm. Solid iroko wood base. The sofa always has back cushions (x3 units).

Módulo terminal angular de 45° de 3 plazas con asiento, respaldo y brazo izquierdo tapizados. Base de madera maciza de iroco. El sofá siempre lleva cojines de respaldo (x3uds).

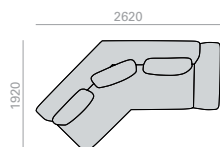

	COM cm. per unit
1 units	1145
10 units or more	1145

4 m3  
97 kg  
x1

COM	1	2	3	4	5	6	7	8	9	10	11	
€	5.285	5.515	5.616	5.695	5.832	5.969	6.105	6.242	6.379	6.516	6.653	6.789

SF2484 **NEW**

3-seater 45° angular terminal module with upholstered seat, backrest and right arm. Solid iroko wood base. The sofa always has back cushions (x3 units).

Módulo terminal angular de 45° de 3 plazas con asiento, respaldo y brazo derecho tapizados. Base de madera maciza de iroco. El sofá siempre lleva cojines de respaldo (x3uds).

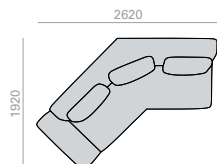

	COM cm. per unit
1 units	1145
10 units or more	1145

4 m3  
97 kg  
x1

COM	1	2	3	4	5	6	7	8	9	10	11	
€	5.821	6.102	6.226	6.324	6.492	6.658	6.826	6.994	7.161	7.329	7.495	7.663

**SF2485** **NEW**

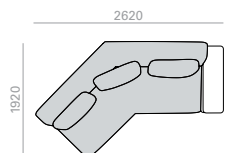

3-seater 45° angular terminal module with upholstered seat and backrest. Base and left side table made of solid iroko wood. The sofa always has back cushions (x3 units).

Módulo terminal angular de 45° de 3 plazas con asiento y respaldo tapizados. Base y mesa auxiliar izquierda de madera maciza de iroco. El sofá siempre lleva cojines de respaldo (x3uds).

	COM cm. per unit
1 units	935
10 units or more	935

4 m<sup>3</sup>  
97 kg  
x1

COM	1	2	3	4	5	6	7	8	9	10	11	
€	5.821	6.102	6.226	6.324	6.492	6.658	6.826	6.994	7.161	7.329	7.495	7.663

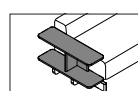

Solid iroko wood table upcharge. Height 430 mm. Incremento mesa de madera maciza de iroco. Altura 430 mm.

152

**SF2486** **NEW**

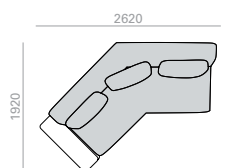

3-seater 45° angular terminal module with upholstered seat and backrest. Base and right side table made of solid iroko wood. The sofa always has back cushions (x3 units).

Módulo terminal angular de 45° de 3 plazas con asiento y respaldo tapizados. Base y mesa auxiliar derecha de madera maciza de iroco. El sofá siempre lleva cojines de respaldo (x3uds).

	COM cm. per unit
1 units	935
10 units or more	935

4 m<sup>3</sup>  
97 kg  
x1

COM	1	2	3	4	5	6	7	8	9	10	11	
€	6.056	6.285	6.385	6.466	6.603	6.739	6.876	7.013	7.150	7.287	7.423	7.560

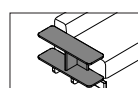

Solid iroko wood table upcharge. Height 430 mm. Incremento mesa de madera maciza de iroco. Altura 430 mm.

152

**SF2487** **NEW**

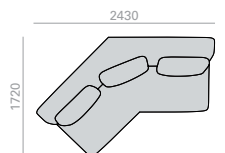

3-seater 45° angular terminal module with upholstered seat and backrest. Base and right side table made of solid iroko wood. The sofa always has back cushions (x3 units).

Módulo terminal angular de 45° de 3 plazas con asiento y respaldo tapizados. Base y mesa auxiliar derecha de madera maciza de iroco. El sofá siempre lleva cojines de respaldo (x3uds).

	COM cm. per unit
1 units	935
10 units or more	935

3'34 m<sup>3</sup>  
85 kg  
x1

COM	1	2	3	4	5	6	7	8	9	10	11	
€	6.056	6.285	6.385	6.466	6.603	6.739	6.876	7.013	7.150	7.287	7.423	7.560



Examples of modular configurations  
Ejemplos de combinaciones modulares

**Set 1 / Conjunto 1**

2 Modules 2 Módulos  
SF2465 + SF2464

	COM cm. per unit
1 units	1660
10 units or more	1660

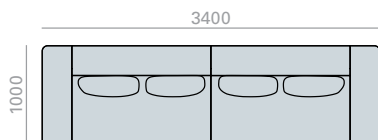

€	COM	1	2	3	4	5	6	7	8	9	10	11
	7.380	7.788	7.968	8.110	8.352	8.596	8.838	9.080	9.322	9.568	9.810	10.052

**Set 2 / Conjunto 2**

2 Modules 2 Módulos  
SF2473 + SF2472

	COM cm. per unit
1 units	2110
10 units or more	2110

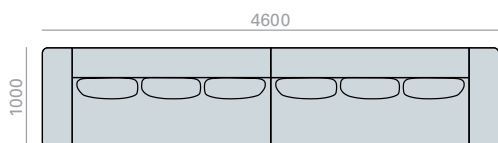

€	COM	1	2	3	4	5	6	7	8	9	10	11
	8.938	9.454	9.684	9.864	10.170	10.480	10.790	11.096	11.406	11.716	12.022	12.332

**Examples of modular configurations**  
**Ejemplos de combinaciones modulares**

**Set 3 / Conjunto 3**

3 Modules 3 Módulos  
 SF2473 + SF2468 + SF2472

	COM cm. per unit
1 units	2510
10 units or more	2510

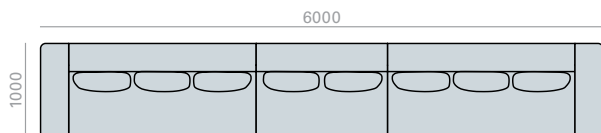

€	COM	1	2	3	4	5	6	7	8	9	10	11	
		12.094	12.762	13.060	13.293	13.689	14.090	14.490	14.888	15.288	15.689	16.085	16.485

**Set 4 / Conjunto 4**

2 Modules 2 Módulos  
 SF2467 + SF2466

	COM cm. per unit
1 units	800
10 units or more	800

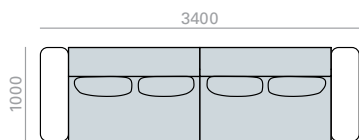

€	COM	1	2	3	4	5	6	7	8	9	10	11	
		7.854	8.158	8.294	8.400	8.580	8.762	8.942	9.122	9.306	9.488	9.668	9.848

**Examples of modular configurations**  
**Ejemplos de combinaciones modulares**

**Set 5 / Conjunto 5**

2 Modules 2 Módulos  
 SF2475 + SF2474

	COM cm. per unit
1 units	1690
10 units or more	1690

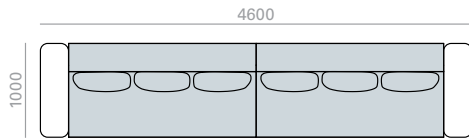

€	COM	1	2	3	4	5	6	7	8	9	10	11
	9.254	9.670	9.854	9.996	10.246	10.494	10.738	10.988	11.232	11.480	11.730	11.974

**Set 6 / Conjunto 6**

3 Modules 3 Módulos  
 SF2479 + SF2468 + SF2482

	COM cm. per unit
1 units	1160
10 units or more	1160

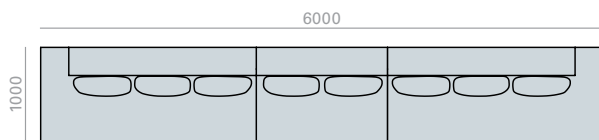

€	COM	1	2	3	4	5	6	7	8	9	10	11
	11.636	12.114	12.328	12.493	12.777	13.064	13.348	13.634	13.918	14.205	14.489	14.773

**Examples of modular configurations**  
**Ejemplos de combinaciones modulares**

**Set 7 / Conjunto 7**

2 Modules 2 Módulos  
 SF2465 + SF2472

	COM cm. per unit
1 units	1885
10 units or more	1885

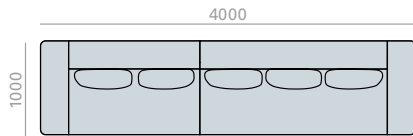

€	COM	1	2	3	4	5	6	7	8	9	10	11
	8.159	8.621	8.826	8.987	9.261	9.538	9.814	10.088	10.364	10.642	10.916	11.192

**Set 8 / Conjunto 8**

3 Modules 3 Módulos  
 SF2479 + SF2468 + SF2482

	COM cm. per unit
1 units	1160
10 units or more	1160

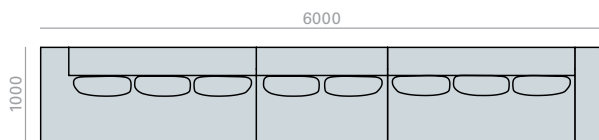

€	COM	1	2	3	4	5	6	7	8	9	10	11
	11.636	12.114	12.328	12.493	12.777	13.064	13.348	13.634	13.918	14.205	14.489	14.773

**Examples of modular configurations**  
**Ejemplos de combinaciones modulares**

**Set 9 / Conjunto 9**

2 Modules 2 Módulos  
 SF2463 + SF2472

	COM cm. per unit
1 units	1885
10 units or more	1885

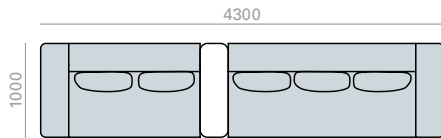

€	COM	1	2	3	4	5	6	7	8	9	10	11	
		8.914	9.375	9.581	9.742	10.016	10.292	10.569	10.843	11.119	11.395	11.671	11.947

**Set 10 / Conjunto 10**

2 Modules 2 Módulos  
 SF2471 + SF2472

	COM cm. per unit
1 units	2110
10 units or more	2110

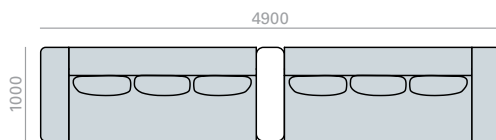

€	COM	1	2	3	4	5	6	7	8	9	10	11	
		9.742	10.258	10.487	10.667	10.974	11.284	11.592	11.900	12.209	12.518	12.826	13.135

**Examples of modular configurations**  
**Ejemplos de combinaciones modulares**

**Set 11 / Conjunto 11**

3 Modules 3 Módulos  
 SF2479 + SF2468 + SF2474

	COM cm. per unit
1 units	1625
10 units or more	1625

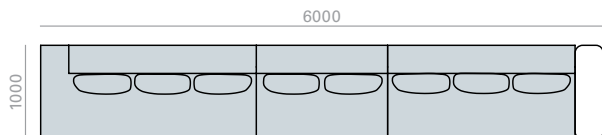

€	COM	1	2	3	4	5	6	7	8	9	10	11
	12.023	12.546	12.779	12.959	13.271	13.584	13.893	14.207	14.516	14.829	15.141	15.450

**Set 12 / Conjunto 12**

2 Modules 2 Módulos  
 SF2465 + SF2482

	COM cm. per unit
1 units	1210
10 units or more	1210

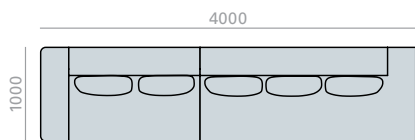

€	COM	1	2	3	4	5	6	7	8	9	10	11
	7.930	8.297	8.460	8.587	8.805	9.025	9.243	9.461	9.679	9.900	10.118	10.336

**Examples of modular configurations**  
**Ejemplos de combinaciones modulares**

**Set 13 / Conjunto 13**

2 Modules 2 Módulos  
SF2473 + SF2482

	COM cm. per unit
1 units	1435
10 units or more	1435

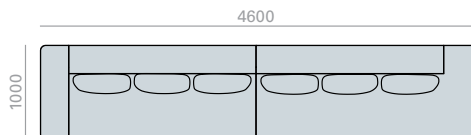

€	COM	1	2	3	4	5	6	7	8	9	10	11
	8.709	9.130	9.318	9.464	9.714	9.967	10.219	10.469	10.721	10.974	11.224	11.476

**Set 14 / Conjunto 14**

4 Modules 4 Módulos  
SF2482 + SF2479 + SF2479 + SF2482

	COM cm. per unit
1 units	1520
10 units or more	1520

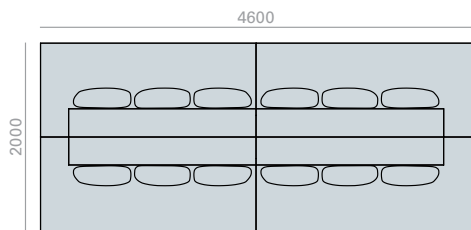

€	COM	1	2	3	4	5	6	7	8	9	10	11
	16.960	17.612	17.904	18.128	18.516	18.908	19.296	19.684	20.072	20.464	20.852	21.240

Examples of modular configurations  
Ejemplos de combinaciones modulares

**Set 15 / Conjunto 15**

6 Modules 6 Módulos

SF2482 + SF2468 + SF2479 + SF2479 + SF2468 + SF2482

	COM cm. per unit
1 units	2320
10 units or more	2320

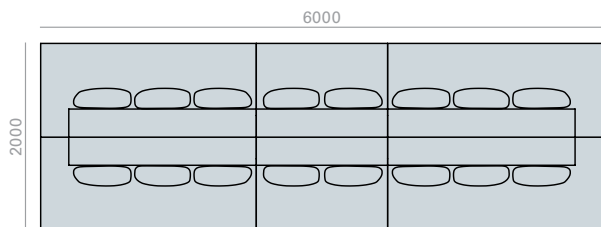

€	COM	1	2	3	4	5	6	7	8	9	10	11
	23.272	24.228	24.656	24.986	25.554	26.128	26.696	27.268	27.836	28.410	28.978	29.546

**Set 16 / Conjunto 16**

2 Modules 2 Módulos

SF2463 + SF2482

	COM cm. per unit
1 units	1210
10 units or more	1210

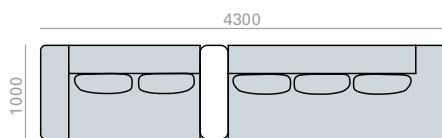

€	COM	1	2	3	4	5	6	7	8	9	10	11
	8.685	9.051	9.215	9.342	9.560	9.779	9.998	10.216	10.434	10.653	10.873	11.091



Examples of modular configurations  
Ejemplos de combinaciones modulares

**Set 17 / Conjunto 17**

2 Modules 2 Módulos  
SF2471 + SF2482

	COM cm. per unit
1 units	1435
10 units or more	1435

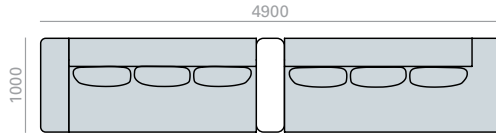

€	COM	1	2	3	4	5	6	7	8	9	10	11	
		9.513	9.934	10.121	10.267	10.518	10.771	11.021	11.273	11.524	11.776	12.028	12.279

**Set 18 / Conjunto 18**

2 Modules 2 Módulos  
SF2465 + SF2483

	COM cm. per unit
1 units	1975
10 units or more	1975

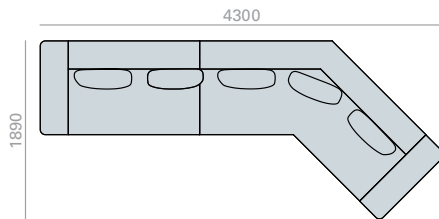

€	COM	1	2	3	4	5	6	7	8	9	10	11	
		8.975	9.409	9.600	9.750	10.008	10.267	10.524	10.782	11.040	11.300	11.558	11.815

Examples of modular configurations  
Ejemplos de combinaciones modulares

**Set 19 / Conjunto 19**

2 Modules 2 Módulos  
SF2473 + SF2483

	COM cm. per unit
1 units	2200
10 units or more	2200

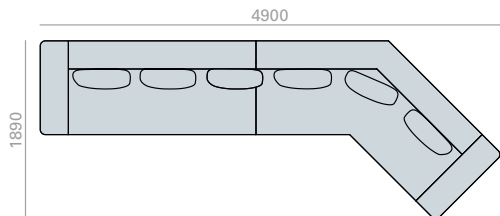

€	COM	1	2	3	4	5	6	7	8	9	10	11
	9.754	10.242	10.458	10.627	10.917	11.209	11.500	11.790	12.082	12.374	12.664	12.955

**Set 20 / Conjunto 20**

2 Modules 2 Módulos  
SF2463 + SF2483

	COM cm. per unit
1 units	1975
10 units or more	1975

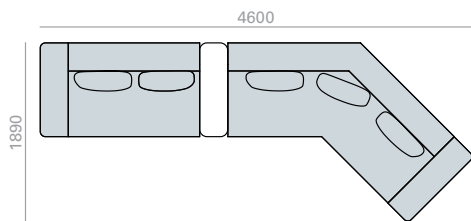

€	COM	1	2	3	4	5	6	7	8	9	10	11
	9.730	10.163	10.355	10.505	10.763	11.021	11.279	11.537	11.795	12.053	12.313	12.570

Examples of modular configurations  
Ejemplos de combinaciones modulares

**Set 21 / Conjunto 21**

2 Modules 2 Módulos  
SF2471 + SF2483

	COM cm. per unit
1 units	2200
10 units or more	2200

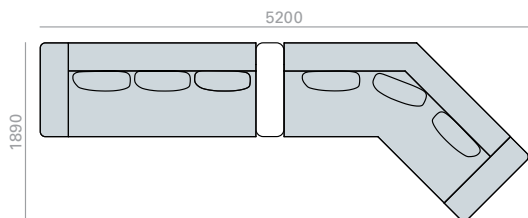

€	COM	1	2	3	4	5	6	7	8	9	10	11
	10.558	11.046	11.261	11.430	11.721	12.013	12.302	12.594	12.885	13.176	13.468	13.758

**Set 22 / Conjunto 22**

2 Modules 2 Módulos  
SF2473 + SF2469

	COM cm. per unit
1 units	2320
10 units or more	2320

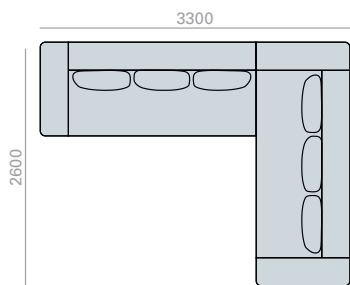

€	COM	1	2	3	4	5	6	7	8	9	10	11
	9.487	10.054	10.307	10.505	10.843	11.182	11.522	11.861	12.201	12.540	12.879	13.219

Examples of modular configurations  
Ejemplos de combinaciones modulares

**Set 23 / Conjunto 23**

5 Modules 5 Módulos

SF2473 + SF2473 + SF2468 + SF2472 + SF2472

	COM cm. per unit
1 units	4620
10 units or more	4620

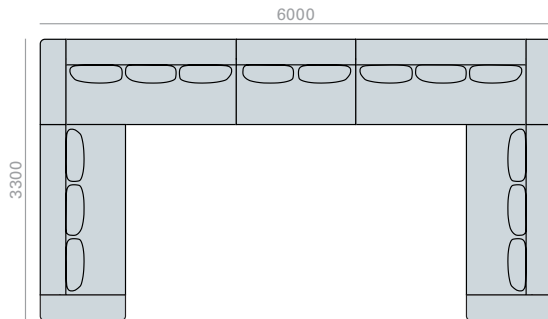

€	COM	1	2	3	4	5	6	7	8	9	10	11
	21.032	22.216	22.744	23.157	23.859	24.570	25.280	25.984	26.694	27.405	28.107	28.817

**Set 24 / Conjunto 24**

3 Modules 3 Módulos

SF2484 + SF2468 + SF2483

	COM cm. per unit
1 units	2690
10 units or more	2690

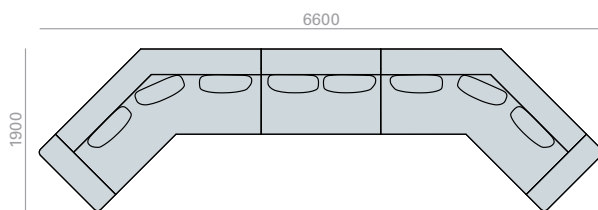

€	COM	1	2	3	4	5	6	7	8	9	10	11
	14.262	14.925	15.218	15.448	15.843	16.237	16.631	17.028	17.422	17.818	18.211	18.605

**Examples of modular configurations**  
**Ejemplos de combinaciones modulares**

**Set 25 / Conjunto 25**

2 Modules 2 Módulos  
 SF2469 + SF2483

	COM cm. per unit
1 units	2410
10 units or more	2410

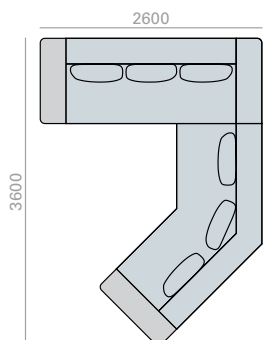

€	COM	1	2	3	4	5	6	7	8	9	10	11	
		10.303	10.842	11.081	11.268	11.590	11.911	12.232	12.555	12.877	13.198	13.521	13.842

**Set 26 / Conjunto 26**

5 Modules 5 Módulos  
 SF2479 + SF2473 + SF2468 + SF2472 + SF2482

	COM cm. per unit
1 units	3270
10 units or more	3270

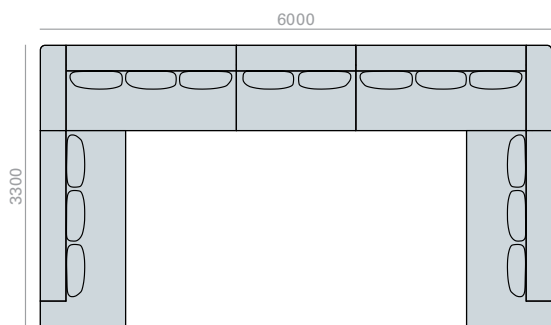

€	COM	1	2	3	4	5	6	7	8	9	10	11	
		20.574	21.568	22.012	22.357	22.947	23.544	24.138	24.730	25.324	25.921	26.511	27.105

Examples of modular configurations  
Ejemplos de combinaciones modulares

**Set 27 / Conjunto 27**

4 Modules 4 Módulos  
SF2473 + SF2487 + SF2487 + SF2472

	COM cm. per unit
1 units	3980
10 units or more	3980

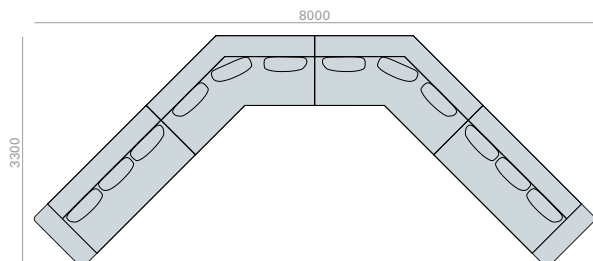

€	COM	1	2	3	4	5	6	7	8	9	10	11
	21.050	22.024	22.454	22.796	23.376	23.958	24.542	25.122	25.706	26.290	26.868	27.452

**Set 28 / Conjunto 28**

3 Modules 3 Módulos  
SF2473 + SF2487 + SF2472

	COM cm. per unit
1 units	3045
10 units or more	3045

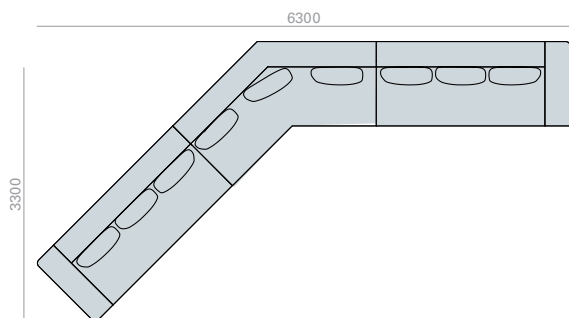

€	COM	1	2	3	4	5	6	7	8	9	10	11
	14.994	15.739	16.069	16.330	16.773	17.219	17.666	18.109	18.556	19.003	19.445	19.892

Examples of modular configurations  
Ejemplos de combinaciones modulares

**Set 29 / Conjunto 29**

5 Modules 5 Módulos

SF2473 + SF2487 + SF2487 + SF2487 + SF2472

	COM cm. per unit
1 units	4915
10 units or more	4915

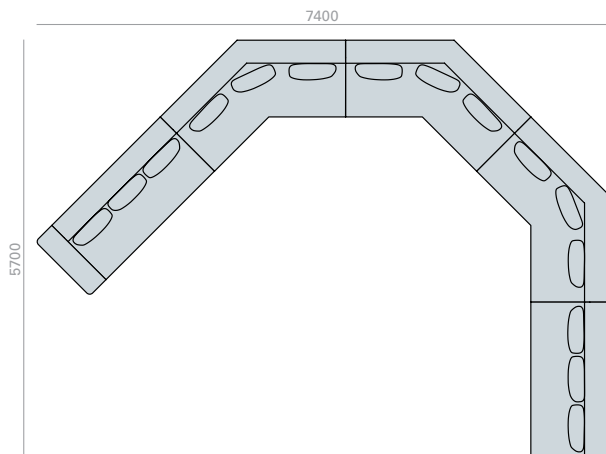

€	COM	1	2	3	4	5	6	7	8	9	10	11
	27.106	28.309	28.839	29.262	29.979	30.697	31.418	32.135	32.856	33.577	34.291	35.012

**Set 30 / Conjunto 30**

4 Modules 4 Módulos

SF2473 + SF2487 + SF2485 + SF2473

	COM cm. per unit
1 units	3980
10 units or more	3980

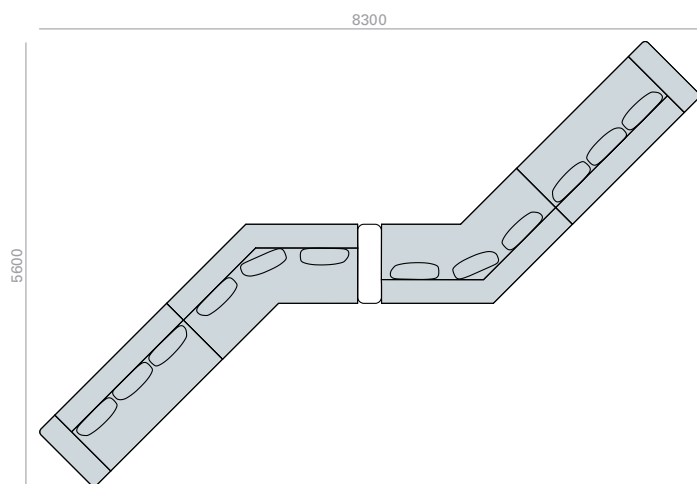

€	COM	1	2	3	4	5	6	7	8	9	10	11
	20.815	21.841	22.295	22.654	23.265	23.877	24.492	25.103	25.717	26.332	26.940	27.555

Examples of modular configurations  
Ejemplos de combinaciones modulares

**Set 31 / Conjunto 31**

4 Modules 4 Módulos  
SF2484 + SF2487 + SF2487 + SF2483

	COM cm. per unit
1 units	4160
10 units or more	4160

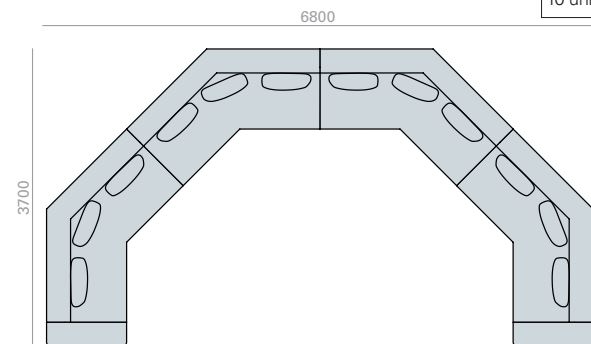

€	COM	1	2	3	4	5	6	7	8	9	10	11	
		23.218	24.187	24.612	24.951	25.530	26.105	26.683	27.262	27.840	28.419	28.994	29.572

**Set 32 / Conjunto 32**

6 Modules 6 Módulos  
SF2484 + SF2487 + SF2487 + SF2487 + SF2487 + SF2483

	COM cm. per unit
1 units	6030
10 units or more	6030

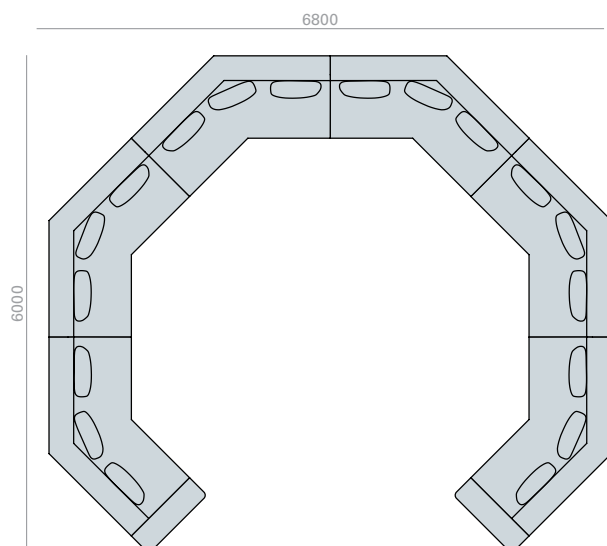

€	COM	1	2	3	4	5	6	7	8	9	10	11	
		35.330	36.757	37.382	37.883	38.736	39.583	40.435	41.288	42.140	42.993	43.840	44.692



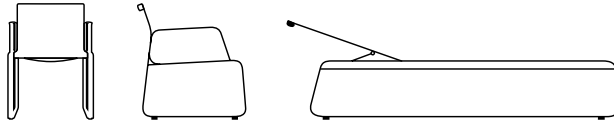

**Description**  
**Descripción**

Armchair, lounge chair and chaise lounge with reclining backrest with seat and back with aluminum frame and upholstered in Batyline and aluminum sled base available in different colors. Chaise lounge is available in wheeled version. Optional auxiliary cus  
Sillón, butaca y tumbona de respaldo reclinable con asiento y respaldo con estructura de aluminio y tapizado en Batyline® y base de patín de aluminio disponible en diferentes colores. Disponible versión de tumbona con ruedas. Disponible cojín auxiliar así

**Upholstery**  
**Tapicería**

Andreu World collections use various types of upholstery in acrylic and faux leather that are especially designed for outdoor use. The cushions and covers are made with a top quality fabric that repels water, is resistant to UV rays and mold. The Aire Outdoor collection supports following upholsteries of Andreu World Catalogue. For fabrics in our catalogue not specified in this box or customers own materials please contact our Customer Service Department.

En las colecciones de Andreu World Outdoor se han utilizado distintos tipos de tapicerías de fibra acrílica y ecopiel, especialmente concebidas para su uso en exterior. Los cojines y fundas están confeccionados con un tejido de máxima calidad que repele el agua, es resistente a los rayos UV y al moho. La colección Aire Outdoor admite las siguientes tapicerías del catálogo de Andreu World. Para las telas de nuestro catálogo no indicadas en este cuadro o telas cliente, consultar con nuestro Departamento Comercial.

Fabrics / Telas		Faux Leather / Ecopiel
1 Sand Reel One	6 Chartres Zori Patio Tack Two Tack Three	2 Silvertex 3 Maglia 10 Coast
2 Solid & Stripes Tack One	7 Tack Five	
3 Natte Loom Two Mezzo Reel two	8 Domino Lopi	
4 Heritage Savane Reel Three Reel Four	9 Tack Four	

**Batyline® finish**  
**Acabado de Batyline®**



**Aluminum finish**  
**Acabado aluminio**

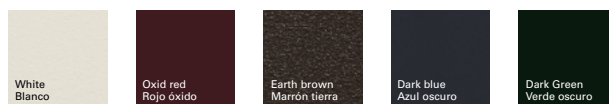

**Certificates**  
**Certificados**

<b>Aluminum</b> <b>Aluminio</b>	UNE CEN/TS 581-4
<b>Quality - Resistance</b> <b>Calidad - Resistencia</b>	UNE EN 16139:2013

**Intellectual property Propiedad intelectual**

All our collections are protected by international industrial design registries, designs patents, copyrights and intellectual Property laws. Unauthorized use of AW International Property is a criminal offence and can lead to prosecution.  
Todas nuestras colecciones están protegidas por registros de diseño industrial, diseño de patente, copyright y derechos de propiedad intelectual en todo el mundo. El uso no autorizado de los diseños y propiedad intelectual de AW supone un delito que puede ser sometido a acción judicial.



BU1281

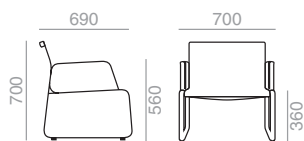

Lounge chair with aluminum frame and seat and back upholstered in Balyline® mesh. Aluminum sled base available in different colors. available loose cushion seat and backrest.

Butaca con asiento y respaldo con estructura de aluminio y tapizado en Balyline® y base de patín de aluminio disponible en diferente colores. Disponible cojín auxiliar asiento y respaldo.

	COM cm. per unit
1 units	120
10 units or more	110

0'39 m3  
10 kg  
x1

€ 467



Loose cushion  
Cojín auxiliar

COM	1	2	3	4	5	6	7	8	9	10	11	
	609	617	622	626	634	641	647	653	658	654	672	679

TU1282

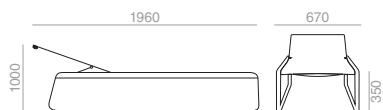

Chaise lounge with reclining back, aluminum frame and seat and backupholstered in Balyline® mesh. Aluminum base available in different colors. Available loose cushion seat and backrest.

Tumbona de respaldo reclinable con asiento y respaldo con estructura de aluminio y tapizado en Balyline® y base de patín de aluminio disponible en diferentes colores. Disponible cojín auxiliar asiento y respaldo.

	COM cm. per unit
1 units	220
10 units or more	110

0'59 m3  
23'5 kg  
x1

€ 927



Loose cushion  
Cojín auxiliar

COM	1	2	3	4	5	6	7	8	9	10	11	
	1.167	1.188	1.201	1.212	1.226	1.241	1.255	1.268	1.283	1.298	1.313	1.326



Casters up charge  
Incremento por ruedas | 123 |



**Description**  
**Descripción**

Stackable chair, armchair and lounge chairs with woven band seat and backrest and 4-legged aluminum base. Available in different finishes. Stool version in 2 different heights.

Silla, sillón y butacas apilables con asiento y respaldo cinchado y base de 4 patas de aluminio. Disponibles en diferentes acabados. Versión de banqueta en 2 alturas diferentes.

**Steel finish**

**Acabado de acero**

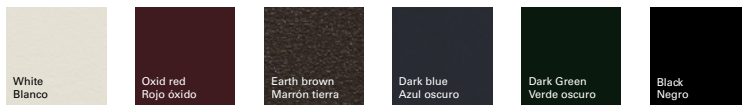

**Woven band finish**

**Acabado de cincha**



**Certificates**  
**Certificados**

<b>Aluminum</b> <b>Aluminio</b>	UNE CEN/TS 581-4
<b>Woven band</b> <b>Cincha</b>	ISO 105-B02, ISO 105-X12, ISO 105-E03
<b>Quality - Resistance</b> <b>Calidad - Resistencia</b>	UNE EN 16139:2013

**Intellectual property Propiedad intelectual**

All our collections are protected by international industrial design registries, designs patents, copyrights and intellectual Property laws. Unauthorized use of AW International Property is a criminal offence and can lead to prosecution.  
Todas nuestras colecciones están protegidas por registros de diseño industrial, diseño de patente, copyright y derechos de propiedad intelectual en todo el mundo. El uso no autorizado de los diseños y propiedad intelectual de AW supone un delito que puede ser sometido a acción judicial.



SI0276

Stackable chair with woven band seat and backrest and aluminum 4 legs base available in different colors.

Silla apilable con asiento y respaldo cinchado y base de 4 patas de aluminio disponible en diferentes colores.

0'28 m3

18 kg

x2



8

14

€ 499



SO0277

Stackable armchair with woven band seat and backrest and aluminum 4 legs base available in different colors.

Sillón apilable con asiento y respaldo cinchado y base de 4 patas de aluminio disponible en diferentes colores.

0'33 m3

27'5 kg

x2

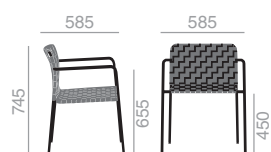

8

14

€ 532



BU0278

Stackable lounge chair with woven band seat and backrest and aluminum 4 legs base available in different colors.

Butaca apilable con asiento y respaldo cinchado y base de 4 patas de aluminio disponible en diferentes colores.

0'34 m3

19 kg

x2



6

6

€ 602



BU0279

Stackable lounge chair with arms, woven band seat and backrest and aluminum 4 legs base available in different colors.

Butaca apilable con brazos, asiento y respaldo cinchado y base de 4 patas de aluminio disponible en diferentes colores.

0'38 m3

21 kg

x2

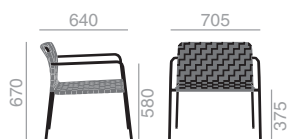

6

6

€ 626



**BQ0273**



Stool with webbing seat and backrest and 4-legged aluminum base. Available in different finishes.

Banqueta con asiento y respaldo cinchado y base de 4 patas de aluminio. Disponible en diferentes acabados.

0'33 m3

7 kg

x1

€ 578

**FU4924** Protective cover Funda protectora | 111 |

**BQ0274**



Counter stool with webbing seat and backrest and 4-legged aluminum base. Available in different finishes.

Banqueta baja con asiento y respaldo cinchado y base de 4 patas de aluminio. Disponible en diferentes acabados.

0'29 m3

6'7 kg

x1

€ 578

**FU4925** Protective cover Funda protectora | 111 |

**BQ0270**

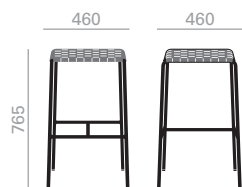

“ ” Barstool with webbing seat and backrest and 4-legged aluminum base. Available in different finishes.”

Banqueta con asiento y respaldo cinchado y base de 4 patas de aluminio. Disponible en diferentes acabados.

0'21 m3

5'6 kg

x1

€ 455

**BQ0271**

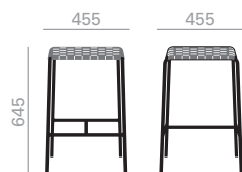

Counter stool with webbing seat and backrest and 4-legged aluminum base. Available in different finishes.

Banqueta baja con asiento y respaldo cinchado y base de 4 patas de aluminio. Disponible en diferentes acabados.

0'17 m3

5'3 kg

x1

€ 455



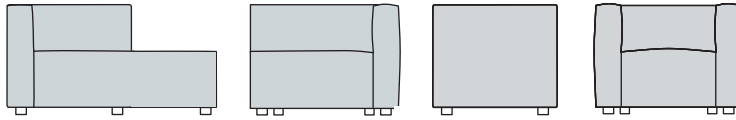

**Description**  
**Descripción**

Modular upholstered sofa available in different widths and versions: corner, chaise longue, and curved. Upholstered ottoman version available. Included connection system. Customizable interior stitching in various colors. Valid for outdoor use.

Sofá modular tapizado disponible en diferentes anchos y versiones: rinconero, chaise longue y curvo. Version de reposapiés tapizado. Sistema de unión incluido. Costura interior personalizable en diferentes colores. Válido para su uso en exterior.

**Upholstery**  
**Tapicería**

Andreu World collections use various types of upholstery in acrylic and faux leather that are especially designed for outdoor use. The covers and cushions are made of waterproof polyester fabric to protect the furniture from moisture, rain, and sun. For fabrics in our catalogue not specified in this box or customers own materials please contact our Customer Service Department.

En las colecciones de Andreu World Outdoor se han utilizado distintos tipos de tapicerías de fibra acrílica y ecopiel, especialmente concebidas para su uso en exterior. Los cojines y fundas están confeccionados con un tejido de máxima calidad que repele el agua, es resistente a los rayos UV y al moho.

**Fabrics / Telas**

- 1** Sand  
Reel One
- 2** Solid & Stripes  
Tack One
- 3** Natte  
Loom Two  
Mezzo  
Reel two
- 4** Heritage  
Savane  
Reel Three  
Reel Four

- 6** Chartres  
Zori  
Patio  
Tack Two  
Tack Three
- 7** Tack Five
- 8** Domino  
Lopi
- 9** Tack Four

**Faux Leather / Ecopiel**

- 2** Silvertex
- 3** Maglia
- 10** Coast

**Intellectual property Propiedad intelectual**

All our collections are protected by international industrial design registries, designs patents, copyrights and intellectual Property laws. Unauthorized use of AW International Property is a criminal offence and can lead to prosecution.  
Todas nuestras colecciones están protegidas por registros de diseño industrial, diseño de patente, copyright y derechos de propiedad intelectual en todo el mundo. El uso no autorizado de los diseños y propiedad intelectual de AW supone un delito que puede ser sometido a acción judicial.



**BU2370**

Armchair with upholstered seat and backrest.  
Butaca con asiento y respaldo tapizado.

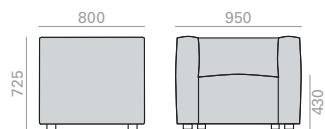

	COM cm. per unit
1 units	530
10 units or more	520

0'64 m3  
32'8 kg  
x1

COM	1	2	3	4	5	6	7	8	9	10	11	
€	1.684	1.801	1.854	1.894	1.964	2.036	2.106	2.176	2.246	2.316	2.387	2.458

**SF2371**

Sofa with upholstered seat and backrest.  
Sofá con asiento y respaldo tapizado.

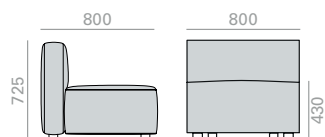

	COM cm. per unit
1 units	270
10 units or more	250

0'54 m3  
31'9 kg  
x1

COM	1	2	3	4	5	6	7	8	9	10	11	
€	1.461	1.521	1.548	1.571	1.606	1.644	1.681	1.716	1.753	1.790	1.826	1.863

**SF2372**

Corner sofa (right side) with upholstered seat and backrest.  
Sofá rinconero (lado derecho) con asiento y respaldo tapizado.

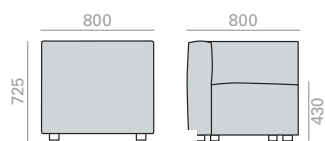

	COM cm. per unit
1 units	370
10 units or more	360

0'54 m3  
34'1 kg  
x1

COM	1	2	3	4	5	6	7	8	9	10	11	
€	1.734	1.821	1.860	1.890	1.944	1.997	2.048	2.102	2.155	2.206	2.260	2.313

**SF2373**

Corner sofa (left side) with upholstered seat and backrest.  
Sofá rinconero (lado izquierdo) con asiento y respaldo tapizado.

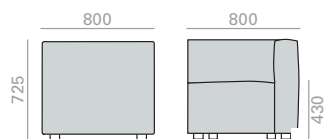

	COM cm. per unit
1 units	370
10 units or more	360

0'54 m3  
34'1 kg  
x1

COM	1	2	3	4	5	6	7	8	9	10	11	
€	1.734	1.821	1.860	1.890	1.944	1.997	2.048	2.102	2.155	2.206	2.260	2.313

**SF2374**

Corner sofa (right side) with upholstered seat and backrest. Wide version.  
Sofá rinconero (lado derecho) con asiento y respaldo tapizado. Versión ancha.

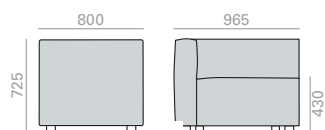

	COM cm. per unit
1 units	420
10 units or more	410

0'65 m3  
36'2 kg  
x1

COM	1	2	3	4	5	6	7	8	9	10	11	
€	1.774	1.874	1.919	1.955	2.015	2.074	2.134	2.194	2.255	2.315	2.374	2.434



SF2375

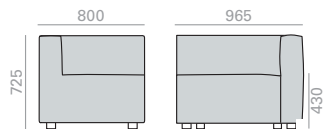

Sofá rinconero (lado izquierdo) con asiento y respaldo tapizado. Versión ancha.  
Sofá rinconero (lado izquierdo) con asiento y respaldo tapizado. Versión ancha.

	COM cm. per unit
1 units	420
10 units or more	410

0'65 m3  
36'2 kg  
x1

COM	1	2	3	4	5	6	7	8	9	10	11	
€	1.774	1.874	1.919	1.955	2.015	2.074	2.134	2.194	2.255	2.315	2.374	2.434

SF2376

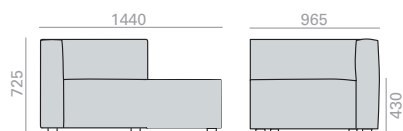

Corner sofa (left side) with upholstered seat and backrest. Wide version.  
Sofá rinconero (lado izquierdo) con asiento y respaldo tapizado. Versión ancha.

	COM cm. per unit
1 units	440
10 units or more	430

1'21 m3  
59 kg  
x1

COM	1	2	3	4	5	6	7	8	9	10	11	
€	2.208	2.313	2.361	2.397	2.460	2.523	2.585	2.648	2.711	2.774	2.837	2.900

SF2377

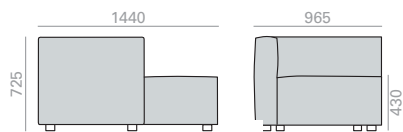

Corner sofa (right side) with upholstered seat and backrest. Wide version.  
Sofá rinconero (lado derecho) con asiento y respaldo tapizado. Versión ancha.

	COM cm. per unit
1 units	440
10 units or more	430

1'21 m3  
59 kg  
x1

COM	1	2	3	4	5	6	7	8	9	10	11	
€	2.208	2.313	2.361	2.397	2.460	2.523	2.585	2.648	2.711	2.774	2.837	2.900

SF2378

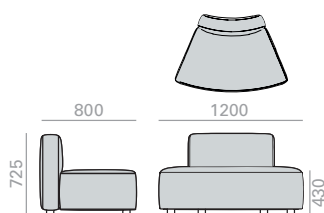

Curved modular sofa with upholstered seat and backrest. Open curved version.  
Sofá modular curvo con asiento y respaldo tapizados. Versión curva abierta.

	COM cm. per unit
1 units	360
10 units or more	320

0'86 m3  
48'7 kg  
x1

COM	1	2	3	4	5	6	7	8	9	10	11	
€	1.929	2.006	2.042	2.069	2.116	2.163	2.210	2.256	2.303	2.350	2.397	2.444

SF2379

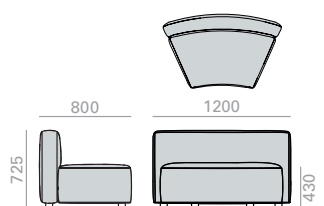

Curved modular sofa with upholstered seat and backrest. Closed curved version.  
Sofá modular curvo con asiento y respaldo tapizados. Versión curva cerrada.

	COM cm. per unit
1 units	420
10 units or more	390

0'86 m3  
54'65 kg  
x1

COM	1	2	3	4	5	6	7	8	9	10	11	
€	1.889	1.984	2.026	2.060	2.116	2.174	2.231	2.289	2.345	2.402	2.460	2.516

SF2380

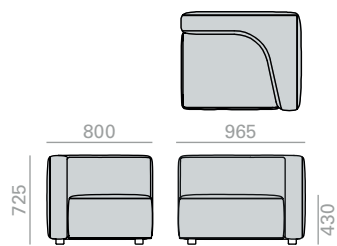

Modular corner sofa with upholstered seat and backrest.  
Left side corner.  
Sofá modular rinconero con asiento y respaldo tapizado.  
Esquina lado izquierdo.

	COM cm. per unit
1 units	390
10 units or more	380

0'63 m3  
31'6 kg  
x1

COM	1	2	3	4	5	6	7	8	9	10	11	
€	2.160	2.253	2.294	2.327	2.382	2.439	2.494	2.548	2.605	2.660	2.716	2.771

SF2381

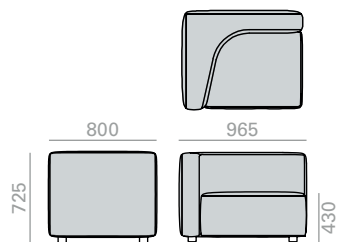

Modular corner sofa with upholstered seat and backrest.  
Right side corner.  
Sofá modular rinconero con asiento y respaldo tapizado.  
Esquina lado derecho.

	COM cm. per unit
1 units	390
10 units or more	380

0'63 m3  
31'6 kg  
x1

COM	1	2	3	4	5	6	7	8	9	10	11	
€	2.160	2.253	2.294	2.327	2.382	2.439	2.494	2.548	2.605	2.660	2.716	2.771

RS2382

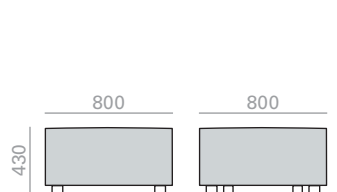

Upholstered footrest.  
Reposapiés tapizado.

	COM cm. per unit
1 units	180
10 units or more	170

0'35 m3  
12'5 kg  
x1

COM	1	2	3	4	5	6	7	8	9	10	11	
€	867	906	922	936	960	982	1.006	1.028	1.052	1.075	1.097	1.121

RS2383

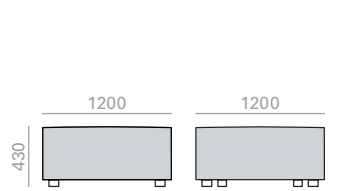

Upholstered footrest.  
Reposapiés tapizado.

	COM cm. per unit
1 units	380
10 units or more	300

0'78 m3  
25'6 kg  
x1

COM	1	2	3	4	5	6	7	8	9	10	11	
€	1.290	1.357	1.387	1.410	1.451	1.493	1.533	1.573	1.613	1.654	1.696	1.736

CJ2384

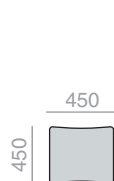

Auxiliary cushion  
Cojín auxiliar

	COM cm. per unit
1 units	65
10 units or more	650

0'02 m3  
2 kg  
x1

COM	1	2	3	4	5	6	7	8	9	10	11	
€	88	103	110	115	124	133	142	151	160	169	176	185

CJ2385

Auxiliary cushion  
Cojín auxiliar

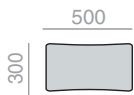

	COM cm. per unit
1 units	45
10 units or more	450

0'02 m3  
 1'6 kg  
 x1

COM	1	2	3	4	5	6	7	8	9	10	11	
€	87	96	101	104	110	116	124	130	136	142	148	154





**SI1320**

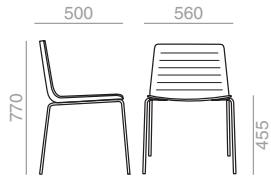

Outdoor stackable chair Eco thermo-polymer shell available in several colors or Pure Eco thermo-polymer (100% recycled) available in sand color and 4 steel legs finished in silver grey, white, earth brown or black.

Silla con asiento y respaldo de termopolímero y base de 4 patas de tubo de acero en acabado gris plata, blanco, marrón tierra o negro.

0'32 m3  
24 kg  
x4

10  
15

€ 223

**SI1322**

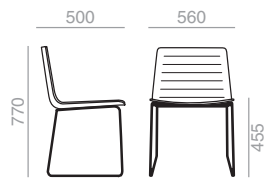

Outdoor stackable chair Eco thermo-polymer shell available in several colors or Pure Eco thermo-polymer (100% recycled) available in sand color and sled base finished in silver grey, white, earth brown or black.

Silla con asiento y respaldo de termopolímero y base de varilla de patín de acero en acabado gris plata, blanco, marrón tierra o negro.

0'37 m3  
112 kg  
x4

10  
20

€ 221

**BQ1328**

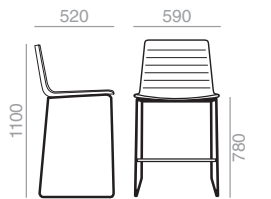

Outdoor barstool Eco thermo-polymer shell available in several colors or Pure Eco thermo-polymer (100% recycled) available in sand color and sled base finished in silver grey, white, earth brown or black.

Banqueta con asiento y respaldo de termopolímero y base de varilla de patín de acero en acabado gris plata, blanco, marrón tierra o negro.

0'38 m3  
43 kg  
x2

8  
25

€ 343

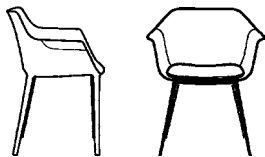

**Description**  
**Descripción**

Armchair with shell and 4-legged base in Pure Eco 100% recycled thermo-polymer available in different colors. Option of upholstered seat cushion.  
Sillón con carcasa y base de 4 patas de termopolímero Pure Eco 100% reciclado disponible en diferentes colores. Opción de cojín tapizado en asiento.

**Upholstery**  
**Tapicería**

Andreu World collections use various types of upholstery in acrylic and faux leather that are especially designed for outdoor use. The covers and cushions are made of waterproof polyester fabric to protect the furniture from moisture, rain, and sun. For fabrics in our catalogue not specified in this box or customers own materials please contact our Customer Service Department.

En las colecciones de Andreu World Outdoor se han utilizado distintos tipos de tapicerías de fibra acrílica y ecopiel, especialmente concebidas para su uso en exterior. Los cojines y fundas están confeccionados con un tejido de máxima calidad que repele el agua, es resistente a los rayos UV y al moho. La colección Treza admite las siguientes tapicerías del catálogo de Andreu World. Para las telas de nuestro catálogo no indicadas en este cuadro o telas cliente, consultar con nuestro Departamento Comercial.

**Fabrics / Telas**

- |  |  |
|--|--|
| <b>1</b> Sand<br>Reel One                              | <b>6</b> Chartres<br>Zori<br>Patio<br>Tack Two<br>Tack Three |
| <b>2</b> Solid & Stripes<br>Tack One                   | <b>7</b> Tack Five   |
| <b>3</b> Natte<br>Loom Two<br>Mezzo<br>Reel two        | <b>8</b> Domino<br>Lopi                                      |
| <b>4</b> Heritage<br>Savane<br>Reel Three<br>Reel Four | <b>9</b> Tack Four   |

**Faux Leather / Ecopiel**

- 2** Silvertex  
**3** Maglia  
**10** Coast

**Pure Eco Thermo-polymer finish**  
**Acabado de Termo-polímero Pure Eco**

<b>6000</b> RAL 9003 White Blanco	<b>6002</b> NCS 2005-Y20R Sand Arena	<b>6012</b> NCS 4005-Y20R Basalt grey Gris basalto	<b>6006</b> RAL 9005 Black Negro	<b>6013</b> NCS S 6502-B Dark grey Gris oscuro	<b>6015</b> NCS 4020-Y20R Camel brown Marrón camel	<b>6016</b> Pantone 5445U Water blue Azul agua	<b>6017</b> Pantone 5655U Marine green Verde Marina	<b>6018</b> Pantone 7526U Terracotta brown Marrón terracota	<b>6019</b> RAL 3009 Oxide red Rojo óxido
--	---	---	---	---	---	---	--	--	--

**Intellectual property Propiedad intelectual**

All our collections are protected by international industrial design registries, designs patents, copyrights and intellectual Property laws. Unauthorized use of AW International Property is a criminal offence and can lead to prosecution.  
Todas nuestras colecciones están protegidas por registros de diseño industrial, diseño de patente, copyright y derechos de propiedad intelectual en todo el mundo. El uso no autorizado de los diseños y propiedad intelectual de AW supone un delito que puede ser sometido a acción judicial.



SO0724

Armchair with shell and 4-legged base in Pure Eco thermopolymer available in various colors. Option of upholstered seat cushion.

Sillón con carcasa y base de 4 patas de termopolímero Pure Eco disponible en diferentes colores. Opción de cojín tapizado en asiento.

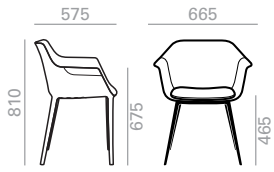

	COM cm. per unit
1 units	50
10 units or more	35

- 0'52 m3
- 42 kg
- x6

€ 120



Upholstered cushion  
Cojín tapizado

COM	1	2	3	4	5	6	7	8	9	10	11
224	231	236	239	242	246	253	256	260	265	270	273



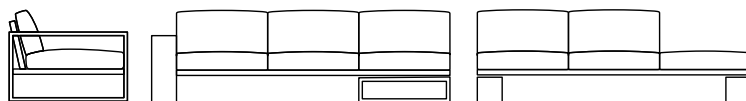

**Description**  
**Descripción**

Collection of – two and three seater sofas with and without armrests with aluminum frame finished in Earth Brown. Adjustable reclining chaise lounge available.

Colección de sofás de dos y tres plazas, con y sin brazos y tumbona de inclinación regulable con estructura de aluminio y acabado Marrón Tierra.

**Upholstery**  
**Tapicería**

Andreu World collections use various types of upholstery in acrylic and faux leather that are especially designed for outdoor use. The cushions and covers are made with a top quality fabric that repels water, is resistant to UV rays and mold. The Landscape Alu collection supports following upholsteries of Andreu World Catalogue. For fabrics in our catalogue not specified in this box or customers own materials please contact our Customer Service Department.

En las colecciones de Andreu World Outdoor se han utilizado distintos tipos de tapicerías de fibra acrílica y ecopiel, especialmente concebidas para su uso en exterior. Los cojines y fundas están confeccionados con un tejido de máxima calidad que repele el agua, es resistente a los rayos UV y al moho. La colección Landscape Alu admite las siguientes tapicerías del catálogo de Andreu World. Para las telas de nuestro catálogo no indicadas en este cuadro o telas cliente, consultar con nuestro Departamento Comercial.

**Fabrics / Telas**

- 1 Sand  
Reel One
- 2 Solid & Stripes  
Tack One
- 3 Natte  
Loom Two  
Mezzo  
Reel two
- 4 Heritage  
Savane  
Reel Three  
Reel Four

- 6 Chartres  
Zori  
Patio  
Tack Two  
Tack Three

- 7 Tack Five

- 8 Domino  
Lopi

- 9 Tack Four

**Faux Leather / Ecopiel**

- 2 Silvertex
- 3 Maglia
- 10 Coast

**Aluminum finish**  
**Acabado aluminio**

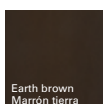

**Certificates**  
**Certificados**

<b>Aluminum</b>	UNE CEN/TS 581-4
<b>Aluminio</b>	
<b>Quality - Resistance</b>	UNE EN 16139:2013
<b>Calidad - Resistencia</b>	

**Intellectual property Propiedad intelectual**

All our collections are protected by international industrial design registries, designs patents, copyrights and intellectual Property laws. Unauthorized use of AW International Property is a criminal offence and can lead to prosecution.

Todas nuestras colecciones están protegidas por registros de diseño industrial, diseño de patente, copyright y derechos de propiedad intelectual en todo el mundo. El uso no autorizado de los diseños y propiedad intelectual de AW supone un delito que puede ser sometido a acción judicial.



**SF4630**

Armless sofa. 2-seater.  
Sofá sin brazos. 2 plazas.



	COM cm. per unit
1 units	670
10 units or more	670

1'57 m3  
94 kg  
x1

COM	1	2	3	4	5	6	7	8	9	10	11	
€	4.338	4.503	4.586	4.669	4.780	4.891	5.002	5.113	5.221	5.333	5.443	5.555

**FU4821**

Protective cover  
Funda protectora | 114 |

**SF4631**

Sofa with two arms. 2-seater.  
Sofá con brazos. 2 plazas.

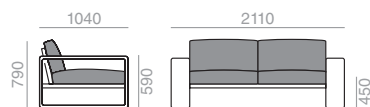

	COM cm. per unit
1 units	670
10 units or more	670

2'21 m3  
122'5 kg  
x1

COM	1	2	3	4	5	6	7	8	9	10	11	
€	4.509	4.678	4.763	4.848	4.962	5.075	5.189	5.303	5.416	5.529	5.641	5.755

**FU4822**

Protective cover  
Funda protectora | 114 |

**SF4632**

Armless sofa. 3-seater.  
Sofá sin brazos. 3 plazas.



	COM cm. per unit
1 units	1000
10 units or more	1000

1'17 m3  
100 kg  
x1

COM	1	2	3	4	5	6	7	8	9	10	11	
€	5.423	5.675	5.802	5.928	6.097	6.264	6.433	6.601	6.768	6.937	7.105	7.273

**FU4823**

Protective cover  
Funda protectora | 211 |

**SF4633**

Sofa with two arms. 3-seater.  
Sofá con brazos. 3 plazas.

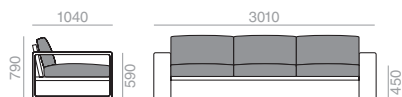

	COM cm. per unit
1 units	1000
10 units or more	1000

2'62 m3  
142 kg  
x1

COM	1	2	3	4	5	6	7	8	9	10	11	
€	5.505	5.761	5.889	6.019	6.189	6.361	6.533	6.703	6.875	7.046	7.218	7.388

**FU4824**

Protective cover  
Funda protectora | 211 |

SF4634

Armless sofa. 3-seater. Two seats with backs and one backless.

Sofá sin brazos. 3 plazas. Dos asientos con respaldo y uno sin respaldo.

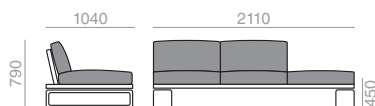

	COM cm. per unit
1 units	900
10 units or more	900

1'9 m3  
112'5 kg  
x1

COM	1	2	3	4	5	6	7	8	9	10	11	
€	5.004	5.221	5.332	5.440	5.585	5.729	5.875	6.019	6.165	6.309	6.455	6.599

**FU4825** Protective cover Funda protectora | 211 |

SF4635

Armless sofa. 3-seater. Two seats with backs and one backless.

Sofá sin brazos. 3 plazas. Dos asientos con respaldo y uno sin respaldo.

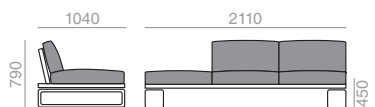

	COM cm. per unit
1 units	900
10 units or more	900

1'9 m3  
112'5 kg  
x1

COM	1	2	3	4	5	6	7	8	9	10	11	
€	5.004	5.221	5.332	5.440	5.585	5.729	5.875	6.019	6.165	6.309	6.455	6.599

**FU4826** Protective cover Funda protectora | 211 |

SF4636

Sofa with single arm. 3-seater. Two seats with backs and one backless.

Sofá con un brazo. 3 plazas. Dos asientos con respaldo y uno sin respaldo.

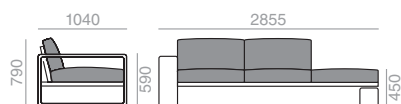

	COM cm. per unit
1 units	900
10 units or more	900

1'17 m3  
100 kg  
x1

COM	1	2	3	4	5	6	7	8	9	10	11	
€	5.249	5.469	5.580	5.693	5.840	5.986	6.134	6.280	6.427	6.576	6.723	6.871

**FU4827** Protective cover Funda protectora | 217 |

SF4637

Sofa with single arm. 3-seater. Two seats with backs and one backless.

Sofá con un brazo. 3 plazas. Dos asientos con respaldo y uno sin respaldo.

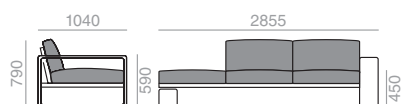

	COM cm. per unit
1 units	900
10 units or more	900

1'17 m3  
100 kg  
x1

COM	1	2	3	4	5	6	7	8	9	10	11	
€	5.249	5.469	5.580	5.693	5.840	5.986	6.134	6.280	6.427	6.576	6.723	6.871

**FU4828** Protective cover Funda protectora | 217 |

**TU4638**

Chaise lounge with wheels. Reclining back.  
Tumbona con ruedas. Respaldo reclinable.

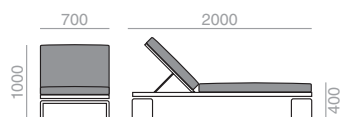

	COM cm. per unit
1 units	460
10 units or more	460

0'63 m3  
38 kg  
x1

COM	1	2	3	4	5	6	7	8	9	10	11	
€	2.658	2.751	2.798	2.845	2.907	2.971	3.034	3.098	3.158	3.221	3.284	3.347

<b>FU4806</b>	Protective cover Funda protectora	101
---------------	--------------------------------------	-----

**CJ0287**

Loose cushion for armchair and barstool.  
Cojín auxiliar para sillón y banqueta.

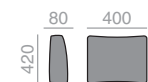

	COM cm. per unit
1 units	40
10 units or more	40

0'02 m3  
1'6 kg  
x1

COM	1	2	3	4	5	6	7	8	9	10	11	
€	95	103	108	112	117	125	129	135	140	146	150	157

**CJ0291**

Loose cushion for lounge chair.  
Cojín auxiliar para butaca.

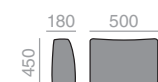

	COM cm. per unit
1 units	45
10 units or more	45

0'02 m3  
1'6 kg  
x1

COM	1	2	3	4	5	6	7	8	9	10	11	
€	97	108	114	120	127	135	142	150	158	165	173	180

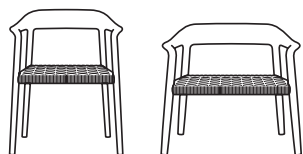

**Description**

Armchair and lounge chair with hand-stringed seat and 4-leg solid iroco wood structure. Valid for outdoor use.

**Descripción**

Sillón y butaca con asiento encordado a mano y estructura de 4 patas de madera maciza de iroco. Válido para su uso en exterior.

**Upholstery**

Andreu World collections use various types of upholstery in acrylic and faux leather that are especially designed for outdoor use. The cushions and covers are made with a top quality fabric that repels water, is resistant to UV rays and mold. The Nuez Outdoor collection supports following upholsteries of Andreu World Catalogue. For fabrics in our catalogue not specified in this box or customers own materials please contact our Customer Service Department.

**Tapicería**

En las colecciones de Andreu World Outdoor se han utilizado distintos tipos de tapicerías de fibra acrílica y ecopiel, especialmente concebidas para su uso en exterior. Los cojines y fundas están confeccionados con un tejido de máxima calidad que repele el agua, es resistente a los rayos UV y al moho. La colección Nuez Outdoor admite las siguientes tapicerías del catálogo de Andreu World. Para las telas de nuestro catálogo no indicadas en este cuadro o telas cliente, consultar con nuestro Departamento Comercial.

**Fabrics / Telas**

- 1 Sand  
Reel One
- 2 Solid & Stripes  
Tack One
- 3 Natte  
Loom Two  
Mezzo  
Reel two
- 4 Heritage  
Savane  
Reel Three  
Reel Four

- 6 Chartres  
Zori  
Patio  
Tack Two  
Tack Three
- 7 Tack Five
- 8 Domino  
Lopi
- 9 Tack Four

**Faux Leather / Ecopiel**

- 2 Silvertex
- 3 Maglia
- 10 Coast

**Wood finish Iroko**

**Acabado madera Iroko**

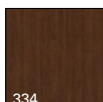

334

**Woven cord finish**

**Acabado de cordón**

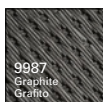

9987  
Graphite  
Gráfico

**Intellectual property Propiedad intelectual**

All our collections are protected by international industrial design registries, designs patents, copyrights and intellectual Property laws. Unauthorized use of AW International Property is a criminal offence and can lead to prosecution.

Todas nuestras colecciones están protegidas por registros de diseño industrial, diseño de patente, copyright y derechos de propiedad intelectual en todo el mundo. El uso no autorizado de los diseños y propiedad intelectual de AW supone un delito que puede ser sometido a acción judicial.



**SO1561** **NEW**

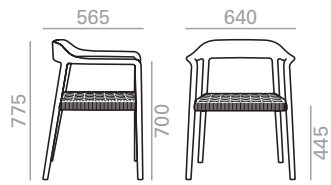

Armchair with hand-stringed seat and 4-leg solid iroko wood structure.  
Sillón con asiento encordado a mano y estructura de 4 patas de madera maciza de iroco.

0'34 m3  
11'2 kg  
x1

€ 1.264

**BU1562** **NEW**

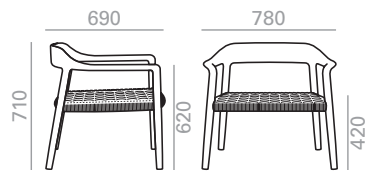

Armchair with hand-stringed seat and 4-leg solid iroko wood structure.  
Butaca con asiento encordado a mano y estructura de 4 patas de madera maciza de iroco.

0'46 m3  
15'25 kg  
x1

€ 1.558



SO0286

Armchair with upholstered seat, woven band back and aluminum frame. 4 aluminum legs base available in several colors.

Sillón con asiento tapizado, respaldo cinchado y estructura de aluminio. Base de 4 patas de aluminio disponible en diferentes colores.



	COM cm. per unit
1 units	55
10 units or more	40

0'31 m3  
10 kg  
x1

COM	1	2	3	4	5	6	7	8	9	10	11	
€	711	722	727	731	738	743	750	757	763	770	775	782

**FU4926** Protective cover Funda protectora | 111 |

BU0288

Lounge chair with upholstered seat, webbed backrest and aluminum frame. Available in different finishes.

Butaca con asiento tapizado, respaldo cinchado y estructura de aluminio. Disponibles en diferentes acabados.

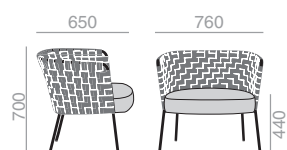

	COM cm. per unit
1 units	80
10 units or more	80

0'35 m3  
11'5 kg  
x1

COM	1	2	3	4	5	6	7	8	9	10	11	
€	854	869	876	881	890	898	908	917	925	934	942	952

**FU4927** Protective cover Funda protectora | 111 |

BQ0289

Disponibles en diferentes acabados. Stool with upholstered seat and backrest with aluminum frame. Available in different finishes.

Banqueta con asiento tapizado, respaldo cinchado y estructura de aluminio. Disponibles en diferentes acabados.



	COM cm. per unit
1 units	30
10 units or more	30

0'42 m3  
10'8 kg  
x1

COM	1	2	3	4	5	6	7	8	9	10	11	
€	782	792	798	802	807	814	819	826	832	839	846	851

**FU4928** Protective cover Funda protectora | 111 |

BQ0290

Counter stool with upholstered seat and backrest with aluminum frame. Available in different finishes.

Banqueta baja con asiento tapizado, respaldo cinchado y estructura de aluminio. Disponibles en diferentes acabados.

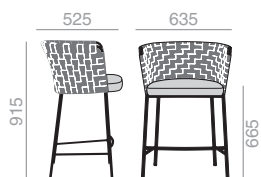

	COM cm. per unit
1 units	45
10 units or more	45

0'37 m3  
10'5 kg  
x1

COM	1	2	3	4	5	6	7	8	9	10	11	
€	782	792	798	802	807	814	819	826	832	839	846	851



**FU4929** Protective cover Funda protectora | 111 |



CJ0287

Loose cushion for armchair and barstool.  
Cojín auxiliar para sillón y banqueta.

	COM cm. per unit
1 units	40
10 units or more	40

 0'02 m3  
 1'6 kg  
 x1

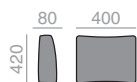



COM	1	2	3	4	5	6	7	8	9	10	11	
€	95	103	108	112	117	125	129	135	140	146	150	157

CJ0291

Loose cushion for lounge chair.  
Cojín auxiliar para butaca.

	COM cm. per unit
1 units	45
10 units or more	45

 0'02 m3  
 1'6 kg  
 x1

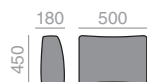

COM	1	2	3	4	5	6	7	8	9	10	11	
€	97	108	114	120	127	135	142	150	158	165	173	180



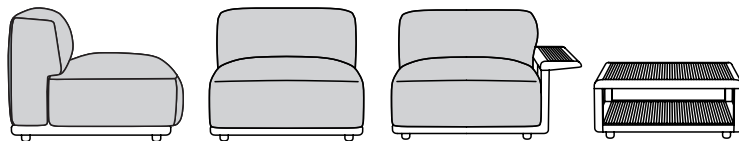

**Description**  
**Descripción**

Modular upholstered 2 and 3-seater sofa with solid iroko wood base and different module options: linear or angular, seat and backrest, open seat and backrest, with upholstered arm or solid iroko wood table available in 2 heights. Valid for outdoor use.

Sofá modular tapizado disponible en diferentes : rinconero, chaise longue y curvo. Estructura y brazos de madera maciza de iroco. Version de reposapiés tapizado. Sistema de unión incluido. Costura interior personalizable en diferentes colores. Válido para su uso en exterior.

**Upholstery**  
**Tapicería**

Andreu World collections use various types of upholstery in acrylic and faux leather that are especially designed for outdoor use. The covers and cushions are made of waterproof polyester fabric to protect the furniture from moisture, rain, and sun. For fabrics in our catalogue not specified in this box or customers own materials please contact our Customer Service Department.

En las colecciones de Andreu World Outdoor se han utilizado distintos tipos de tapicerías de fibra acrílica y ecopiel, especialmente concebidas para su uso en exterior. Los cojines y fundas están confeccionados con un tejido de máxima calidad que repele el agua, es resistente a los rayos UV y al moho.

**Fabrics / Telas**

- 1** Sand  
Reel One
- 2** Solid & Stripes  
Tack One
- 3** Natte  
Loom Two  
Mezzo  
Reel two
- 4** Heritage  
Savane  
Reel Three  
Reel Four

- 6** Chartres  
Zori  
Patio  
Tack Two  
Tack Three
- 7** Tack Five
- 8** Domino  
Lopi
- 9** Tack Four

**Faux Leather / Ecopiel**

- 2** Silvertex
- 3** Maglia
- 10** Coast

**Wood finish Iroko**  
**Acabado madera Iroko**

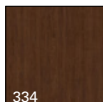

**Intellectual property Propiedad intelectual**

All our collections are protected by international industrial design registries, designs patents, copyrights and intellectual Property laws. Unauthorized use of AW International Property is a criminal offence and can lead to prosecution.  
Todas nuestras colecciones están protegidas por registros de diseño industrial, diseño de patente, copyright y derechos de propiedad intelectual en todo el mundo. El uso no autorizado de los diseños y propiedad intelectual de AW supone un delito que puede ser sometido a acción judicial.



**SF2388** NEW

Modular sofa with upholstered seat and backrest and solid iroko wood structure.  
Sofá modular con asiento y respaldo tapizado y estructura de madera maciza de iroco.

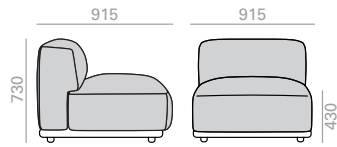

	COM cm. per unit
1 units	340
10 units or more	340

0'68 m3  
 35 kg  
 x1

COM	1	2	3	4	5	6	7	8	9	10	11	
€	2.003	2.085	2.123	2.152	2.202	2.252	2.302	2.352	2.402	2.450	2.500	2.550

**SF2389** NEW

Modular sofa with upholstered seat and backrest and structure and armrest (left side) in solid iroko wood.  
Sofá modular con asiento y respaldo tapizado y estructura y brazo (lado izquierdo) de madera maciza de iroco.

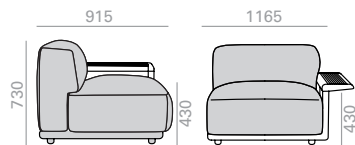

	COM cm. per unit
1 units	340
10 units or more	340

0'86 m3  
 40 kg  
 x1

COM	1	2	3	4	5	6	7	8	9	10	11	
€	2.623	2.706	2.744	2.773	2.823	2.873	2.921	2.971	3.021	3.071	3.121	3.171

**SF2390** NEW

Modular sofa with upholstered seat and backrest and structure and armrest (right side) in solid iroko wood.  
Sofá modular con asiento y respaldo tapizado y estructura y brazo (lado derecho) de madera maciza de iroco.

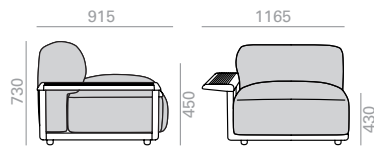

	COM cm. per unit
1 units	340
10 units or more	340

0'86 m3  
 40 kg  
 x1

COM	1	2	3	4	5	6	7	8	9	10	11	
€	2.623	2.706	2.744	2.773	2.823	2.873	2.921	2.971	3.021	3.071	3.121	3.171

**SF2391** NEW

Modular corner sofa (left side) with upholstered seat and backrest and solid iroko wood structure  
Sofá modular rinconero (lado izquierdo) con asiento y respaldo tapizado y estructura de madera maciza de iroco.

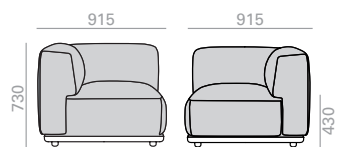

	COM cm. per unit
1 units	430
10 units or more	430

0'68 m3  
 40 kg  
 x1

COM	1	2	3	4	5	6	7	8	9	10	11	
€	2.618	2.723	2.769	2.806	2.869	2.932	2.995	3.058	3.121	3.184	3.247	3.310

**SF2392** NEW

Modular corner sofa (right side) with upholstered seat and backrest and solid iroko wood structure  
Sofá modular rinconero (lado derecho) con asiento y respaldo tapizado y estructura de madera maciza de iroco.

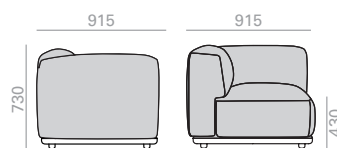

	COM cm. per unit
1 units	430
10 units or more	430

0'68 m3  
 40 kg  
 x1

COM	1	2	3	4	5	6	7	8	9	10	11	
€	2.618	2.723	2.769	2.806	2.869	2.932	2.995	3.058	3.121	3.184	3.247	3.310

**SF2393** **NEW**

Modular chaise lounge sofa with upholstered seat and backrest and solid iroko wood structure.  
Sofá modular chaise lounge con asiento y respaldo tapizado y estructura de madera maciza de iroco.

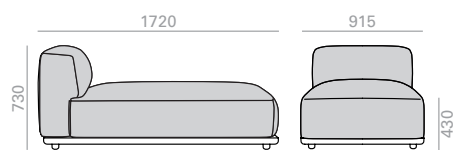

	COM cm. per unit
1 units	500
10 units or more	500

1'25 m3  
50 kg  
x1

COM	1	2	3	4	5	6	7	8	9	10	11	
€	2.637	2.760	2.815	2.856	2.931	3.003	3.076	3.150	3.223	3.295	3.369	3.442

**RS2394** **NEW**

Upholstered footrest with solid iroko wood structure.  
Reposapiés tapizado con estructura de madera maciza de iroco.

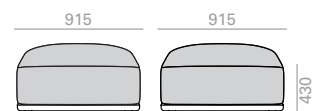

	COM cm. per unit
1 units	200
10 units or more	200

0'43 m3  
28 kg  
x1

COM	1	2	3	4	5	6	7	8	9	10	11	
€	1.110	1.155	1.176	1.193	1.219	1.246	1.273	1.300	1.328	1.355	1.382	1.409

**ME2395** **NEW**

Solid iroko wood side table.  
Mesa auxiliar de madera maciza de iroco.

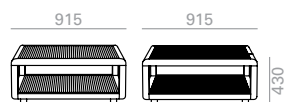

0'38 m3  
32 kg  
x1

€ 2.032

Examples of modular configurations  
Ejemplos de combinaciones modulares

**Set 1 / Conjunto 1**

2 Modules 2 Módulos  
SF2390 + SF2389

	COM cm. per unit
1 units	680
10 units or more	680

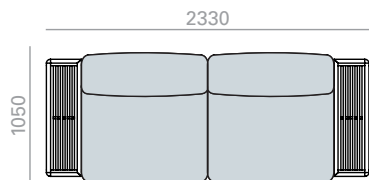

€	COM	1	2	3	4	5	6	7	8	9	10	11
	5.246	5.412	5.488	5.546	5.646	5.746	5.842	5.942	6.042	6.142	6.242	6.342

**Set 2 / Conjunto 2**

3 Modules 3 Módulos  
SF2390 + SF2388 + SF2389

	COM cm. per unit
1 units	1020
10 units or more	1020

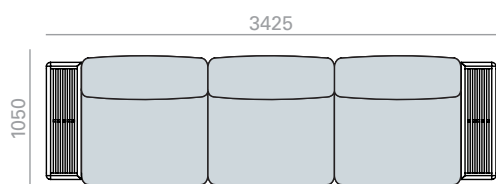

€	COM	1	2	3	4	5	6	7	8	9	10	11
	7.249	7.497	7.611	7.698	7.848	7.998	8.144	8.294	8.444	8.592	8.742	8.892

Examples of modular configurations  
Ejemplos de combinaciones modulares

**Set 3 / Conjunto 3**

4 Modules 4 Módulos  
SF2390 + SF2388 + SF2388 + SF2389

	COM cm. per unit
1 units	1360
10 units or more	1360

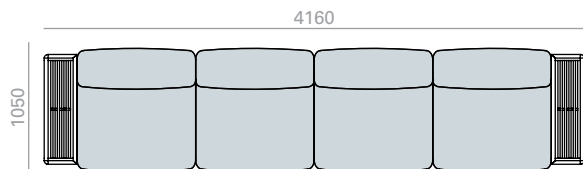

€	COM	1	2	3	4	5	6	7	8	9	10	11
	9.252	9.582	9.734	9.850	10.050	10.250	10.446	10.646	10.846	11.042	11.242	11.442

**Set 4 / Conjunto 4**

2 Modules 2 Módulos  
SF2392 + SF2391

	COM cm. per unit
1 units	860
10 units or more	860

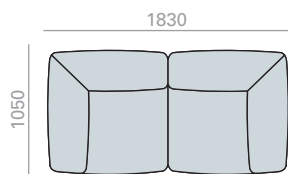

€	COM	1	2	3	4	5	6	7	8	9	10	11
	5.236	5.446	5.538	5.612	5.738	5.864	5.990	6.116	6.242	6.368	6.494	6.620

Examples of modular configurations  
Ejemplos de combinaciones modulares

**Set 5 / Conjunto 5**

3 Modules 3 Módulos  
SF2392 + SF2388 + SF2391

	COM cm. per unit
1 units	1200
10 units or more	1200

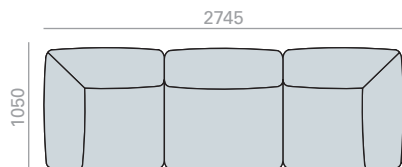

€	COM	1	2	3	4	5	6	7	8	9	10	11	
		7.239	7.531	7.661	7.764	7.940	8.116	8.292	8.468	8.644	8.818	8.994	9.170

**Set 6 / Conjunto 6**

4 Modules 4 Módulos  
SF2392 + SF2388 + SF2388 + SF2391

	COM cm. per unit
1 units	1540
10 units or more	1540

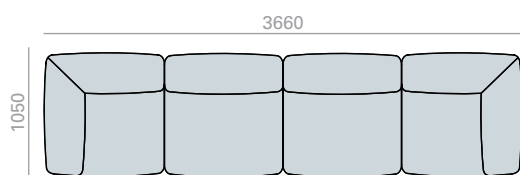

€	COM	1	2	3	4	5	6	7	8	9	10	11	
		9.242	9.616	9.784	9.916	10.142	10.368	10.594	10.820	11.046	11.268	11.494	11.720



Examples of modular configurations  
Ejemplos de combinaciones modulares

**Set 7 / Conjunto 7**

3 Modules 3 Módulos  
SF2390 + SF2388 + SF2392

	COM cm. per unit
1 units	1110
10 units or more	1110

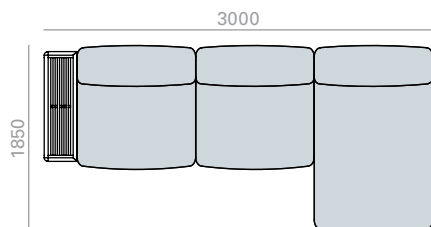

€	COM	1	2	3	4	5	6	7	8	9	10	11
	7.244	7.514	7.636	7.731	7.894	8.057	8.218	8.381	8.544	8.705	8.868	9.031

**Set 8 / Conjunto 8**

4 Modules 4 Módulos  
SF2390 + SF2388 + SF2388 + SF2393

	COM cm. per unit
1 units	1520
10 units or more	1520

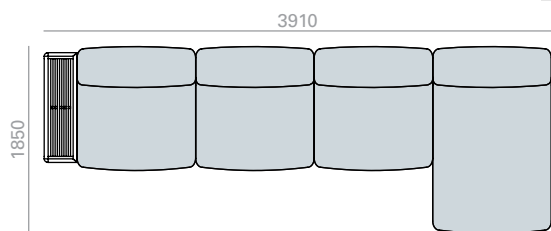

€	COM	1	2	3	4	5	6	7	8	9	10	11
	9.266	9.636	9.805	9.933	10.158	10.380	10.601	10.825	11.048	11.266	11.490	11.713

Examples of modular configurations  
Ejemplos de combinaciones modulares

**Set 9 / Conjunto 9**

5 Modules 5 Módulos

SF2393 + SF2388 + SF2388 + SF2388 + SF2393

	COM cm. per unit
1 units	2020
10 units or more	2020

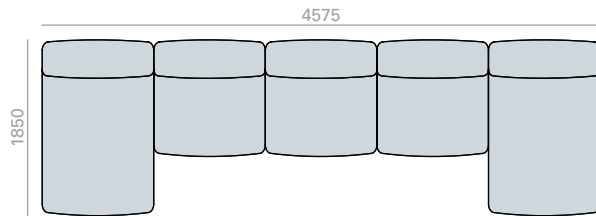

€	COM	1	2	3	4	5	6	7	8	9	10	11
	11.283	11.775	11.999	12.168	12.468	12.762	13.058	13.356	13.652	13.940	14.238	14.534

**Set 10 / Conjunto 10**

3 Modules 3 Módulos

SF2390 + SF2388 + SF2394

	COM cm. per unit
1 units	680
10 units or more	680

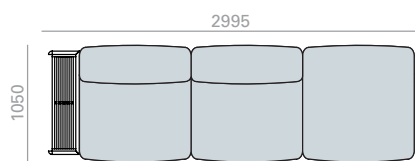

€	COM	1	2	3	4	5	6	7	8	9	10	11
	4.626	4.791	4.867	4.925	5.025	5.125	5.223	5.323	5.423	5.521	5.621	5.721

Examples of modular configurations  
Ejemplos de combinaciones modulares

**Set 11 / Conjunto 11**

4 Modules 4 Módulos  
SF2390 + SF2388 + SF2394 + SF2389

	COM cm. per unit
1 units	1020
10 units or more	1020

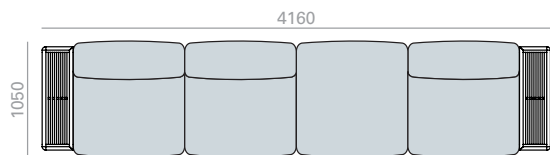

€	COM	1	2	3	4	5	6	7	8	9	10	11
	7.249	7.497	7.611	7.698	7.848	7.998	8.144	8.294	8.444	8.592	8.742	8.892

**Set 12 / Conjunto 12**

3 Modules 3 Módulos  
SF2392 + SF2388 + SF2394

	COM cm. per unit
1 units	770
10 units or more	770

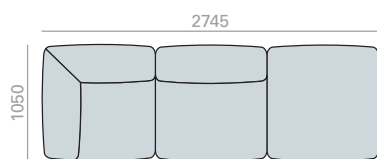

€	COM	1	2	3	4	5	6	7	8	9	10	11
	4.621	4.808	4.892	4.958	5.071	5.184	5.297	5.410	5.523	5.634	5.747	5.860

Examples of modular configurations  
Ejemplos de combinaciones modulares

**Set 13 / Conjunto 13**

4 Modules 4 Módulos  
SF2392 + SF2388 + SF2394 + SF2391

	COM cm. per unit
1 units	1200
10 units or more	1200

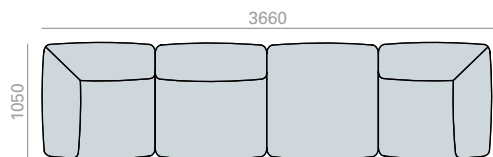

€	COM	1	2	3	4	5	6	7	8	9	10	11
	7.239	7.531	7.661	7.764	7.940	8.116	8.292	8.468	8.644	8.818	8.994	9.170

**Set 14 / Conjunto 14**

3 Modules 3 Módulos  
SF2390 + SF2388 + ME2395

	COM cm. per unit
1 units	680
10 units or more	680

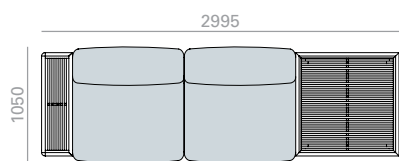

€	COM	1	2	3	4	5	6	7	8	9	10	11
	4.626	4.791	4.867	4.925	5.025	5.125	5.223	5.323	5.423	5.521	5.621	5.721

Examples of modular configurations  
Ejemplos de combinaciones modulares

**Set 15 / Conjunto 15**

4 Modules 4 Módulos  
SF2390 + SF2388 + SF2391 + SF2389

	COM cm. per unit
1 units	1450
10 units or more	1450

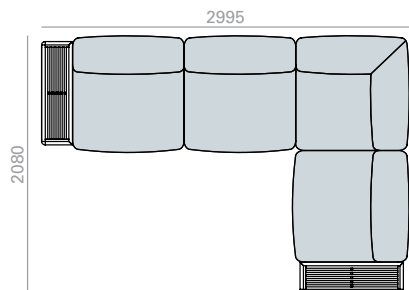

€	COM	1	2	3	4	5	6	7	8	9	10	11
	9.867	10.220	10.380	10.504	10.717	10.930	11.139	11.352	11.565	11.776	11.989	12.202

**Set 16 / Conjunto 16**

5 Modules 5 Módulos  
SF2390 + SF2388 + SF2391 + SF2388 + SF2389

	COM cm. per unit
1 units	1790
10 units or more	1790

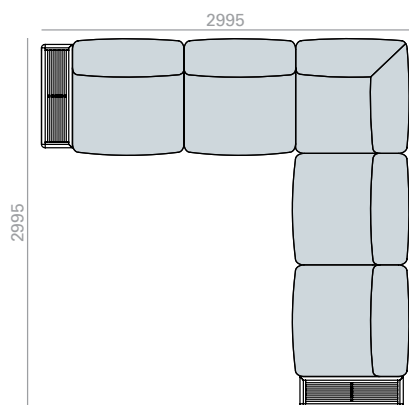

€	COM	1	2	3	4	5	6	7	8	9	10	11
	11.870	12.305	12.503	12.656	12.919	13.182	13.441	13.704	13.967	14.226	14.489	14.752

Examples of modular configurations  
Ejemplos de combinaciones modulares

**Set 17 / Conjunto 17**

6 Modules 6 Módulos  
SF2390 + SF2388 + SF2388 + SF2391 +  
SF2388 + SF2389

	COM cm. per unit
1 units	2130
10 units or more	2130

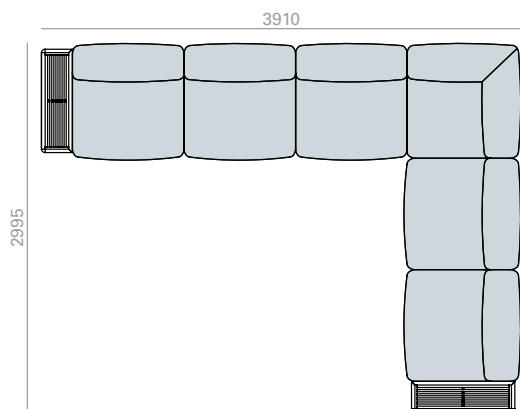

€	COM	1	2	3	4	5	6	7	8	9	10	11
	13.873	14.390	14.626	14.808	15.121	15.434	15.743	16.056	16.369	16.676	16.989	17.302

**Set 18 / Conjunto 18**

7 Modules 7 Módulos  
SF2390 + SF2388 + SF2388 + SF2391 +  
SF2388 + SF2388 + SF2389

	COM cm. per unit
1 units	2470
10 units or more	2470

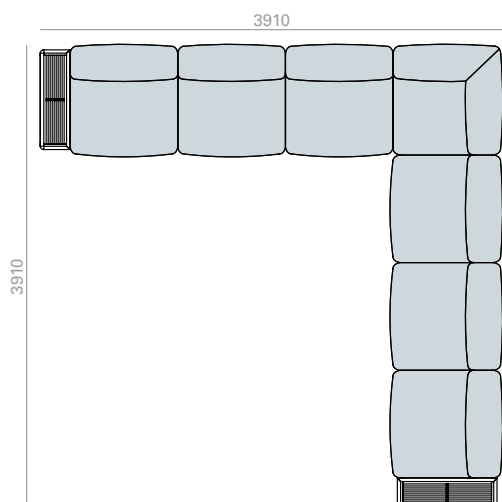

€	COM	1	2	3	4	5	6	7	8	9	10	11
	15.876	16.475	16.749	16.960	17.323	17.686	18.045	18.408	18.771	19.126	19.489	19.852

Examples of modular configurations  
Ejemplos de combinaciones modulares

**Set 19 / Conjunto 19**

4 Modules 4 Módulos  
SF2392 + SF2388 + SF2391 + SF2391

	COM cm. per unit
1 units	1630
10 units or more	1630

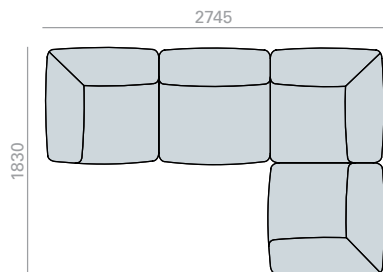

€	COM	1	2	3	4	5	6	7	8	9	10	11
	9.857	10.254	10.430	10.570	10.809	11.048	11.287	11.526	11.765	12.002	12.241	12.480

**Set 20 / Conjunto 20**

5 Modules 5 Módulos  
SF2392 + SF2388 + SF2391 + SF2388 + SF2391

	COM cm. per unit
1 units	1970
10 units or more	1970

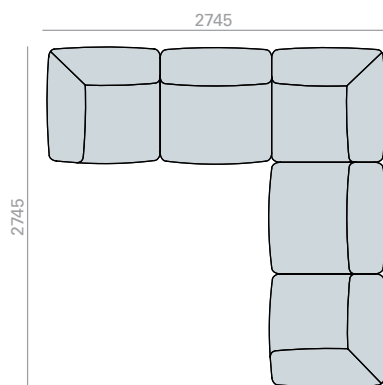

€	COM	1	2	3	4	5	6	7	8	9	10	11
	11.860	12.339	12.553	12.722	13.011	13.300	13.589	13.878	14.167	14.452	14.741	15.030

Examples of modular configurations  
Ejemplos de combinaciones modulares

**Set 21 / Conjunto 21**

6 Modules 6 Módulos

SF2392 + SF2388 + SF2388 + SF2391 + SF2388  
+ SF2391

	COM cm. per unit
1 units	2310
10 units or more	2310

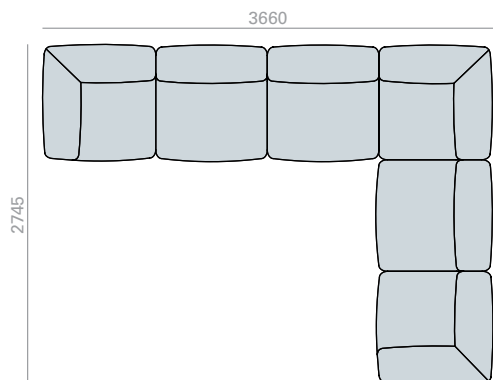

€	COM	1	2	3	4	5	6	7	8	9	10	11
	13.863	14.424	14.676	14.874	15.213	15.552	15.891	16.230	16.569	16.902	17.241	17.580

**Set 22 / Conjunto 22**

7 Modules 7 Módulos

SF2392 + SF2388 + SF2388 + SF2391 + SF2388 +  
SF2388 + SF2391

	COM cm. per unit
1 units	2650
10 units or more	2650

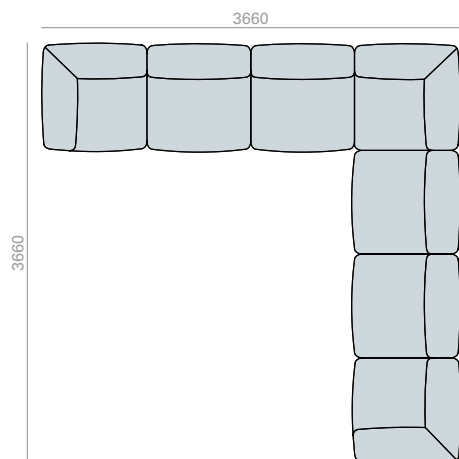

€	COM	1	2	3	4	5	6	7	8	9	10	11
	15.866	16.509	16.799	17.026	17.415	17.804	18.193	18.582	18.971	19.352	19.741	20.130



Examples of modular configurations  
Ejemplos de combinaciones modulares

**Set 23 / Conjunto 23**

4 Modules 4 Módulos  
SF2390 + SF2388 + SF2394 + SF2389

	COM cm. per unit
1 units	1020
10 units or more	1020

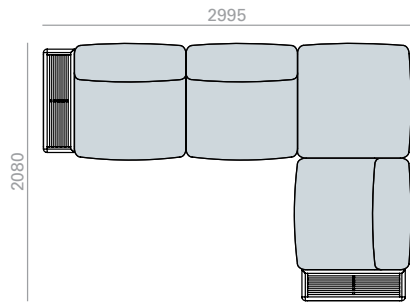

€	COM	1	2	3	4	5	6	7	8	9	10	11
	7.249	7.497	7.611	7.698	7.848	7.998	8.144	8.294	8.444	8.592	8.742	8.892

**Set 24 / Conjunto 24**

5 Modules 5 Módulos  
SF2390 + SF2388 + SF2394 + SF2388 + SF2389

	COM cm. per unit
1 units	1360
10 units or more	1360

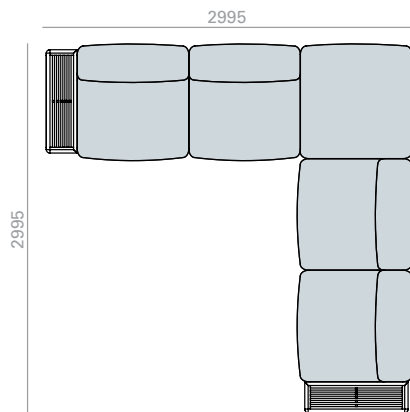

€	COM	1	2	3	4	5	6	7	8	9	10	11
	9.252	9.582	9.734	9.850	10.050	10.250	10.446	10.646	10.846	11.042	11.242	11.442

Examples of modular configurations  
Ejemplos de combinaciones modulares

**Set 25 / Conjunto 25**

4 Modules 4 Módulos  
SF2392 + SF2388 + SF2394 + SF2391

	COM cm. per unit
1 units	1200
10 units or more	1200

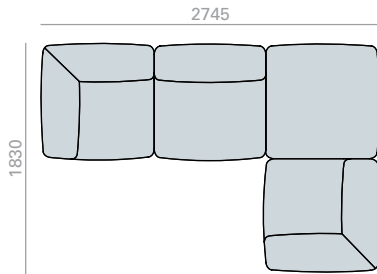

€	COM	1	2	3	4	5	6	7	8	9	10	11
	7.239	7.531	7.661	7.764	7.940	8.116	8.292	8.468	8.644	8.818	8.994	9.170

**Set 26 / Conjunto 26**

5 Modules 5 Módulos  
SF2392 + SF2388 + SF2394 + SF2388 + SF2391

	COM cm. per unit
1 units	1540
10 units or more	1540

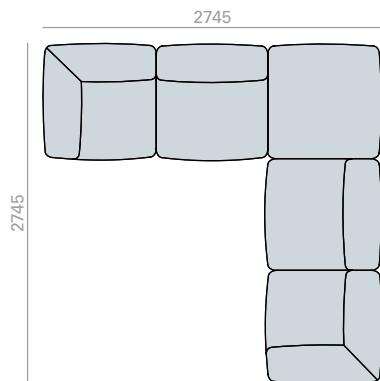

€	COM	1	2	3	4	5	6	7	8	9	10	11
	9.242	9.616	9.784	9.916	10.142	10.368	10.594	10.820	11.046	11.268	11.494	11.720

Examples of modular configurations  
Ejemplos de combinaciones modulares

**Set 27 / Conjunto 27**

4 Modules 4 Módulos  
SF2390 + SF2388 + ME2395 + SF2389

	COM cm. per unit
1 units	1020
10 units or more	1020

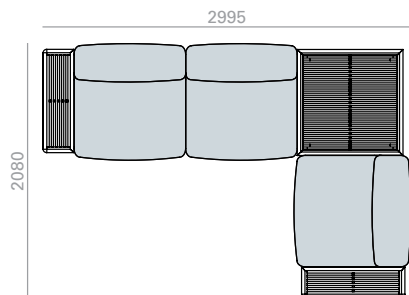

€	COM	1	2	3	4	5	6	7	8	9	10	11
	7.249	7.497	7.611	7.698	7.848	7.998	8.144	8.294	8.444	8.592	8.742	8.892

**Set 28 / Conjunto 28**

5 Modules 5 Módulos  
SF2390 + SF2388 + ME2395 + SF2388 + SF2389

	COM cm. per unit
1 units	1360
10 units or more	1360

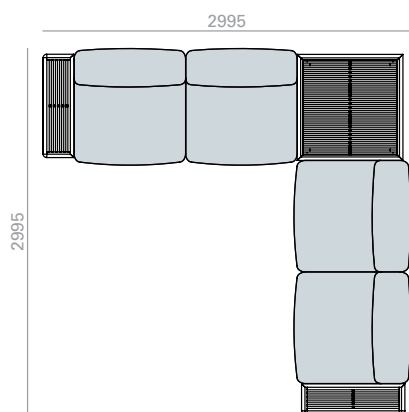

€	COM	1	2	3	4	5	6	7	8	9	10	11
	9.252	9.582	9.734	9.850	10.050	10.250	10.446	10.646	10.846	11.042	11.242	11.442

**Examples of modular configurations**  
**Ejemplos de combinaciones modulares**

**Set 29 / Conjunto 29**

4 Modules 4 Módulos  
 SF2392 + SF2388 + ME2395 + SF2391

	COM cm. per unit
1 units	1200
10 units or more	1200

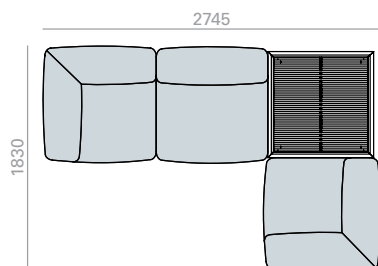

€	COM	1	2	3	4	5	6	7	8	9	10	11
	7.239	7.531	7.661	7.764	7.940	8.116	8.292	8.468	8.644	8.818	8.994	9.170

**Set 30 / Conjunto 30**

5 Modules 5 Módulos  
 SF2392 + SF2388 + ME2395 + SF2388 + SF2391

	COM cm. per unit
1 units	1540
10 units or more	1540

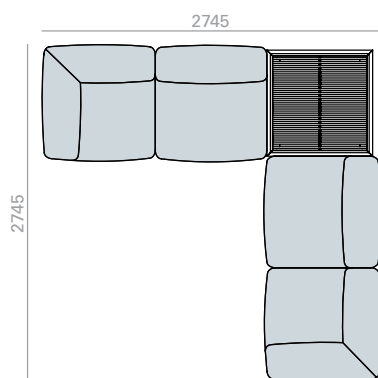

€	COM	1	2	3	4	5	6	7	8	9	10	11
	9.242	9.616	9.784	9.916	10.142	10.368	10.594	10.820	11.046	11.268	11.494	11.720

Examples of modular configurations  
Ejemplos de combinaciones modulares

**Set 31 / Conjunto 31**

6 Modules 6 Módulos

SF2390 + SF2392 + SF2388 + SF2388 + SF2391 + SF2389

	COM cm. per unit
1 units	2220
10 units or more	2220

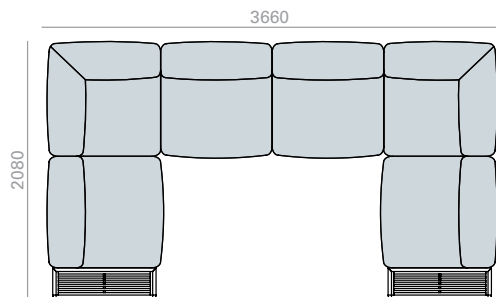

€	COM	1	2	3	4	5	6	7	8	9	10	11	
		14.488	15.028	15.272	15.462	15.788	16.114	16.436	16.762	17.088	17.410	17.736	18.062

**Set 32 / Conjunto 32**

8 Modules 8 Módulos

SF2390 + SF2388 + SF2392 + SF2388 + SF2388 + SF2391 + SF2388 + SF2389

	COM cm. per unit
1 units	2900
10 units or more	2900

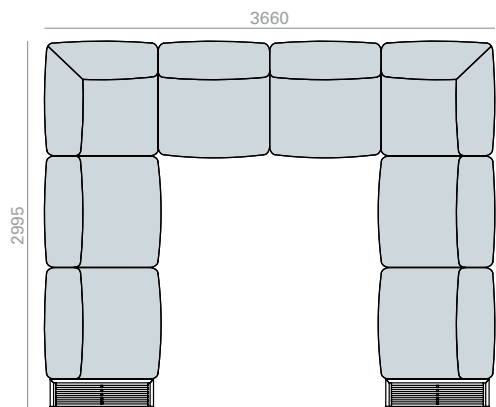

€	COM	1	2	3	4	5	6	7	8	9	10	11	
		18.494	19.198	19.518	19.766	20.192	20.618	21.040	21.466	21.892	22.310	22.736	23.162

Examples of modular configurations  
Ejemplos de combinaciones modulares

**Set 33 / Conjunto 33**

6 Modules 6 Módulos

SF2392 + SF2392 + SF2388 + SF2388 + SF2391  
+ SF2391

	COM cm. per unit
1 units	2400
10 units or more	2400

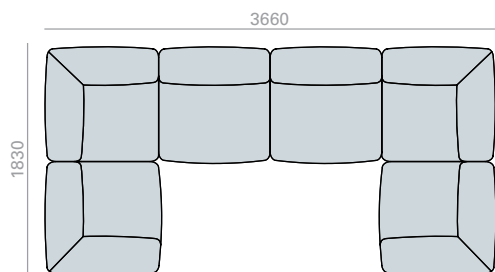

€	COM	1	2	3	4	5	6	7	8	9	10	11	
		14.478	15.062	15.322	15.528	15.880	16.232	16.584	16.936	17.288	17.636	17.988	18.340

**Set 34 / Conjunto 34**

8 Modules 8 Módulos

SF2392 + SF2388 + SF2392 + SF2388 + SF2388 + SF2388 +  
SF2391 + SF2388 + SF2391

	COM cm. per unit
1 units	3080
10 units or more	3080

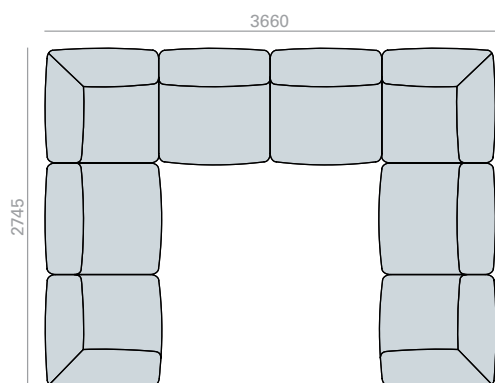

€	COM	1	2	3	4	5	6	7	8	9	10	11	
		18.484	19.232	19.568	19.832	20.284	20.736	21.188	21.640	22.092	22.536	22.988	23.440

Examples of modular configurations  
Ejemplos de combinaciones modulares

**Set 35 / Conjunto 35**

6 Modules 6 Módulos

SF2390 + SF2394 + SF2388 + SF2388 + SF2394  
+ SF2389

	COM cm. per unit
1 units	1360
10 units or more	1360

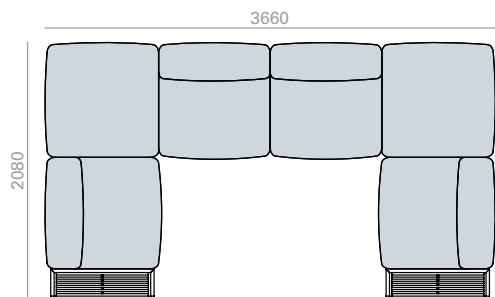

€	COM	1	2	3	4	5	6	7	8	9	10	11	
		9.252	9.582	9.734	9.850	10.050	10.250	10.446	10.646	10.846	11.042	11.242	11.442

**Set 36 / Conjunto 36**

8 Modules 8 Módulos

SF2390 + SF2388 + SF2394 + SF2388 + SF2388 +  
SF2394 + SF2388 + SF2389

	COM cm. per unit
1 units	2040
10 units or more	2040

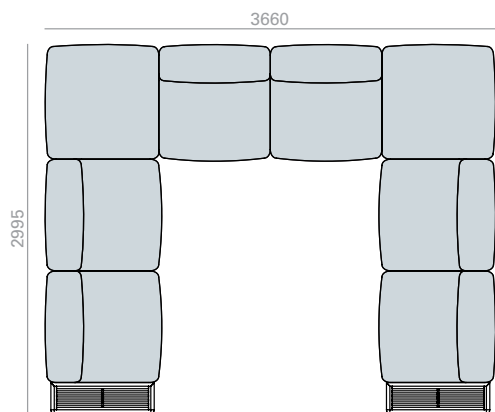

€	COM	1	2	3	4	5	6	7	8	9	10	11	
		13.258	13.752	13.980	14.154	14.454	14.754	15.050	15.350	15.650	15.942	16.242	16.542

Examples of modular configurations  
Ejemplos de combinaciones modulares

**Set 37 / Conjunto 37**

6 Modules 6 Módulos

SF2392 + SF2394 + SF2388 + SF2388 + SF2394 + SF2391

	COM cm. per unit
1 units	1540
10 units or more	1540

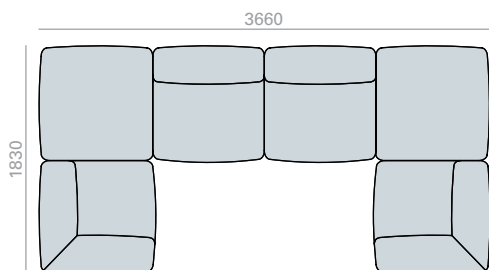

€	COM	1	2	3	4	5	6	7	8	9	10	11
	9.242	9.616	9.784	9.916	10.142	10.368	10.594	10.820	11.046	11.268	11.494	11.720

**Set 38 / Conjunto 38**

8 Modules 8 Módulos

SF2392 + SF2388 + SF2394 + SF2388 + SF2388 + SF2394 + SF2388 + SF2391

	COM cm. per unit
1 units	2220
10 units or more	2220

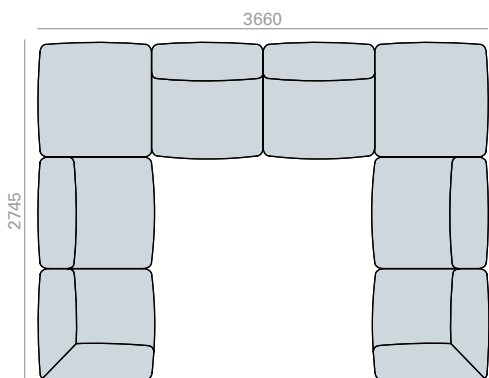

€	COM	1	2	3	4	5	6	7	8	9	10	11
	13.248	13.786	14.030	14.220	14.546	14.872	15.198	15.524	15.850	16.168	16.494	16.820



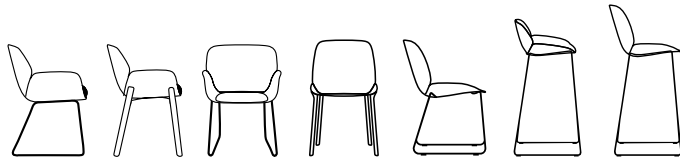

**Description**  
**Descripción**

Armchairs with oak board shell or thermo-polymer shell in available several colors. The available base options are: 4 legs solid wood iroko or steel sled base with EPL5 treatment, available in white, earth brown or black. Optional loose cushions.

Sillones con carcasa de termopolímero Eco disponible en diferentes colores o termopolímero Pure Eco (100% reciclado) disponible en color arena. Las bases disponibles son: base de 4 patas de madera maciza de iroko o base de patín de acero EPL5 en acabado blanco, marrón tierra o negro. Opción de cojín suelto en asiento.

**Upholstery**  
**Tapicería**

Andreu World collections use various types of upholstery in acrylic and faux leather that are especially designed for outdoor use. The cushions and covers are made with a top quality fabric that repels water, is resistant to UV rays and mold. The Nuez Outdoor collection supports following upholsteries of Andreu World Catalogue. For fabrics in our catalogue not specified in this box or customers own materials please contact our Customer Service Department.

En las colecciones de Andreu World Outdoor se han utilizado distintos tipos de tapicerías de fibra acrílica y ecopiel, especialmente concebidas para su uso en exterior. Los cojines y fundas están confeccionados con un tejido de máxima calidad que repele el agua, es resistente a los rayos UV y al moho. La colección Nuez Outdoor admite las siguientes tapicerías del catálogo de Andreu World. Para las telas de nuestro catálogo no indicadas en este cuadro o telas cliente, consultar con nuestro Departamento Comercial.

Fabrics / Telas		Faux Leather / Ecopiel
1 Sand Reel One	6 Chartres Zori Patio Tack Two Tack Three	2 Silvertex 3 Maglia 10 Coast
2 Solid & Stripes Tack One	7 Tack Five	
3 Natte Loom Two Mezzo Reel two	8 Domino Lopi	
4 Heritage Savane Reel Three Reel Four	9 Tack Four	

**Steel finish**  
**Acabado de acero**

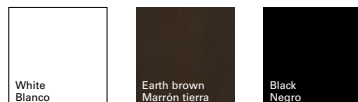

**Eco Thermo-polymer finish**  
**Acabado de Termo-polímero Eco**

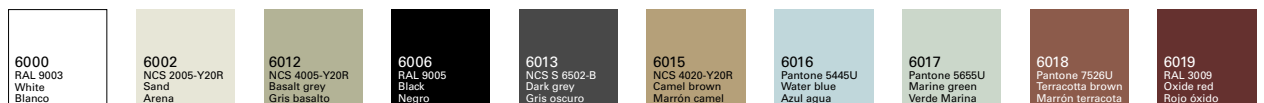

**Pure Eco Thermo-polymer finish**  
**Acabado de Termo-polímero Pure Eco**



**Wood finish Iroko**  
**Acabado madera Iroko**

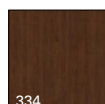

**Certificates**  
**Certificados**

**Steel** UNE CEN/TR 581-4  
**Acero**

**Quality - Resistance** UNE EN 16139:2013  
**Calidad - Resistencia**

**Intellectual property Propiedad intelectual**

All our collections are protected by international industrial design registries, designs patents, copyrights and intellectual Property laws. Unauthorized use of AW International Property is a criminal offence and can lead to prosecution.  
Todas nuestras colecciones están protegidas por registros de diseño industrial, diseño de patente, copyright y derechos de propiedad intelectual todo el mundo. El uso no autorizado de los diseños y propiedad intelectual de AW supone un delito que puede ser sometido a acción judicial.



SO2790

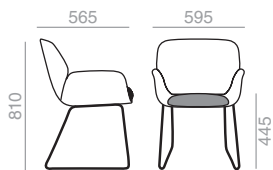

Armchair with Eco thermo-polymer shell available in several colors or Pure Eco thermo-polymer (100% recycled) available in sand color and steel sled base with EPL5 treatment finished in white, brown or black. Optional auxiliary cushion for the seat.

Sillón con carcasa de termopolímero Eco disponible en diferentes colores o termopolímero Pure Eco (100% reciclado) disponible en color arena y base de patín de acero con tratamiento EPL5 en acabado blanco, marrón tierra o negro. Opción de cojín auxiliar en asiento.

	COM cm. per unit
1 units	60
10 units or more	60

0'32 m3  
11'5 kg  
x1

	TP	COM	1	2	3	4	5	6	7	8	9	10	11
€	316	390	401	407	411	419	426	433	440	447	455	462	469

SO2791

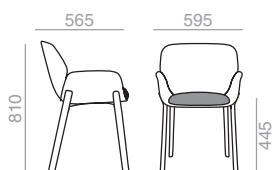

Armchair with Eco thermo-polymer shell available in several colors or Pure Eco thermo-polymer (100% recycled) available in sand color and 4-legs solid iroko wood base. Optional auxiliary cushion for the seat.

Sillón con carcasa de termopolímero Eco disponible en diferentes colores o termopolímero Pure Eco (100% reciclado) disponible en color arena y base de 4 patas de madera maciza de iroko. Opción de cojín auxiliar en asiento.

	COM cm. per unit
1 units	60
10 units or more	60

0'35 m3  
9 kg  
x1

	TP	COM	1	2	3	4	5	6	7	8	9	10	11
€	647	747	760	767	772	781	790	797	806	815	824	832	840

SI2798

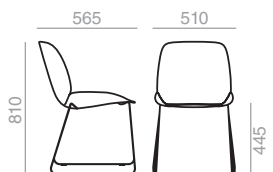

Chair with Eco thermo-polymer shell available in different colors or Pure Eco thermo-polymer (100% recycled) available in sand color with steel sled base with EPL5 treatment in white, earth brown or black finish. Loose seat cushion option.

Silla con carcasa de termopolímero Eco disponible en diferentes colores o termopolímero Pure Eco (100% reciclado) disponible en color arena y base de patín de acero de acero con tratamiento EPL5 en acabado blanco, marrón tierra o negro. Opción de cojín auxiliar.

	COM cm. per unit
1 units	60
10 units or more	60

0'27 m3  
11'1 kg  
x1

	TP	COM	1	2	3	4	5	6	7	8	9	10	11
€	287	372	382	388	391	398	404	411	417	424	431	439	448

SI2799



Chair with shell in Eco thermo-polymer available in different colors or Pure Eco thermo-polymer (100% recycled) available in sand color with 4-legged base in solid iroko wood. Auxiliary seat cushion option.

Silla con carcasa de termopolímero Eco disponible en diferentes colores o termopolímero Pure Eco (100% reciclado) disponible en color arena y base de 4 patas de madera maciza de iroko. Opción de cojín auxiliar en asiento.

	COM cm. per unit
1 units	60
10 units or more	60

0'27 m3  
10'8 kg  
x1

	TP	COM	1	2	3	4	5	6	7	8	9	10	11
€	609	709	721	727	731	739	746	753	761	768	775	783	790

BQ2891

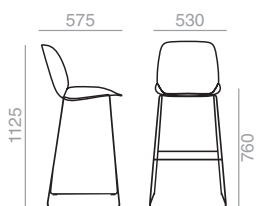

High stool with Eco thermo-polymer shell available in different colors or Pure Eco thermo-polymer (100% recycled) available in sand color with steel sled base with EPL5 treatment in white, earth brown or black finish. Loose seat cushion option.

Banqueta alta con carcasa de termopolímero Eco disponible en diferentes colores o termopolímero Pure Eco (100% reciclado) disponible en color arena y base de patín de acero con tratamiento EPL5 en acabado blanco, marrón tierra o negro. Opción de cojín auxiliar en asiento.

	COM cm. per unit
1 units	60
10 units or more	60

0'39 m3  
15'1 kg  
x1

	TP	COM	1	2	3	4	5	6	7	8	9	10	11
€	355	444	456	462	466	474	481	489	496	503	511	518	526

**BQ2892**



Low stool with Eco thermo-polymer shell available in different colors or Pure Eco thermo-polymer (100% recycled) available in sand color and steel sled base with EPL5 treatment in white, earth brown or black finish. Loose seat cushion option.

Banqueta baja con carcasa de termopolímero Eco disponible en diferentes colores o termopolímero Pure Eco (100% reciclado) disponible en color arena y base de patín de acero con tratamiento EPL5 en acabado blanco, marrón tierra o negro. Opción de cojín auxiliar en asiento.

	COM cm. per unit
1 units	60
10 units or more	60

- 0'36 m3
- 14'1 kg
- x1

	TP	COM	1	2	3	4	5	6	7	8	9	10	11
€	355	444	456	462	466	474	481	489	496	503	511	518	526

**BQ2893**

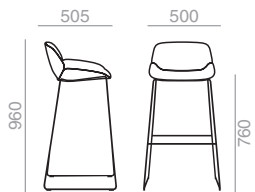

High stool with Eco thermo-polymer shell available in different colors or Pure Eco thermo-polymer (100% recycled) available in sand color with steel sled base with EPL5 treatment in white, earth brown or black finish. Loose seat cushion option.

Banqueta alta con carcasa de termopolímero Eco disponible en diferentes colores o termopolímero Pure Eco (100% reciclado) disponible en color arena y base de patín de acero con tratamiento EPL5 en acabado blanco, marrón tierra o negro. Opción de cojín auxiliar en asiento.

	COM cm. per unit
1 units	50
10 units or more	50

- 0'28 m3
- 12'5 kg
- x1

	TP	COM	1	2	3	4	5	6	7	8	9	10	11
€	350	443	452	456	461	467	471	477	483	489	495	501	507

**BQ2894**

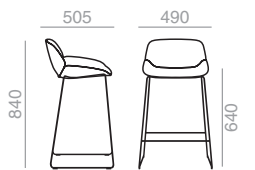

Low stool with Eco thermo-polymer shell available in different colors or Pure Eco thermo-polymer (100% recycled) available in sand color and steel sled base with EPL5 treatment in white, earth brown or black finish. Loose seat cushion option.

Banqueta baja con carcasa de termopolímero Eco disponible en diferentes colores o termopolímero Pure Eco (100% reciclado) disponible en color arena y base de patín de acero con tratamiento EPL5 en acabado blanco, marrón tierra o negro. Opción de cojín auxiliar en asiento.

	COM cm. per unit
1 units	50
10 units or more	50

- 0'23 m3
- 11'5 kg
- x1

	TP	COM	1	2	3	4	5	6	7	8	9	10	11
€	350	443	452	456	461	467	471	477	483	489	495	501	507





**Description**  
**Descripción**

Armchairs with thermo-polymer shell in available several colors. The available base options are: steel sled base or 4 legs steel base with EPL5 treatment and available in white, earth brown or black. Available loose cushion seat and backrest. Optional auxiliary cushion for the seat.  
Sillones con carcasa de termopolímero Eco disponible en diferentes colores o termopolímero Pure Eco (100% reciclado) disponible en color arena. Las bases disponibles son: base de patín de acero o 4 patas de tubo de acero con tratamiento EPL5 en acabado blanco, marrón tierra o negro. Opción de cojín auxiliar en asiento.

**Upholstery**  
**Tapicería**

Andreu World collections use various types of upholstery in acrylic and faux leather that are especially designed for outdoor use. The covers and cushions are made of waterproof polyester fabric to protect the furniture from moisture, rain, and sun. For fabrics in our catalogue not specified in this box or customers own materials please contact our Customer Service Department.

En las colecciones de Andreu World Outdoor se han utilizado distintos tipos de tapicerías de fibra acrílica y ecopiel, especialmente concebidas para su uso en exterior. Los cojines y fundas están confeccionados con un tejido de máxima calidad que repele el agua, es resistente a los rayos UV y al moho.

**Fabrics / Telas**

- 1** Sand  
Reel One
- 2** Solid & Stripes  
Tack One
- 3** Natte  
Loom Two  
Mezzo  
Reel two
- 4** Heritage  
Savane  
Reel Three  
Reel Four
- 6** Chartres  
Zori  
Patio  
Tack Two  
Tack Three
- 7** Tack Five
- 8** Domino  
Lopi
- 9** Tack Four

**Faux Leather / Ecopiel**

- 2** Silvertex
- 3** Maglia
- 10** Coast

**Steel finish**  
**Acabado de acero**

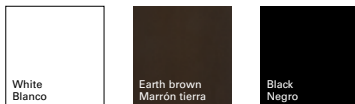

**Eco Thermo-polymer finish**  
**Acabado de Termopolímero Eco**

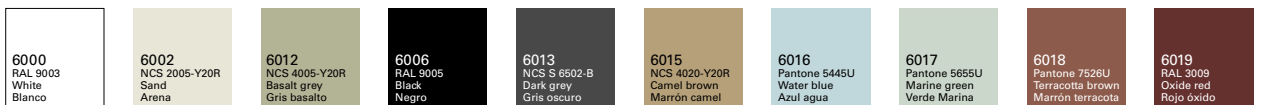

**Pure Eco Thermo-polymer finish**  
**Acabado de Termopolímero Pure Eco**



**Certificates**  
**Certificados**

**Steel** UNE CEN/TR 581-4  
**Acero**

**Quality - Resistance** UNE EN 16139:2013  
**Calidad - Resistencia**

**Intellectual property Propiedad intelectual**

All our collections are protected by international industrial design registries, designs patents, copyrights and intellectual Property laws. Unauthorized use of AW International Property is a criminal offence and can lead to prosecution.  
Todas nuestras colecciones están protegidas por registros de diseño industrial, diseño de patente, copyright y derechos de propiedad intelectual en todo el mundo. El uso no autorizado de los diseños y propiedad intelectual de AW supone un delito que puede ser sometido a acción judicial.



SO0434

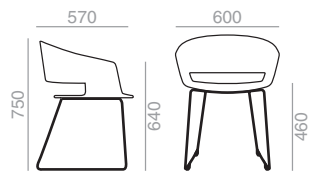

Armchair with Eco thermo-polymer shell available in several colors or Pure Eco thermo-polymer (100% recycled) available in sand color and steel sled base with EPL5 treatment finished in white, earth brown or black. Optional auxiliary cushion for the seat.

Sillón con carcasa de termopolímero Eco disponible en diferentes colores o termopolímero Pure Eco (100% reciclado) disponible en color arena y base de patín de acero con tratamiento EPL5 en acabado blanco, marrón tierra o negro. Opción de cojín auxiliar en asiento.

	COM cm. per unit
1 units	50
10 units or more	50

- 0'3 m3
- 12 kg
- x1

	TP	COM	1	2	3	4	5	6	7	8	9	10	11
€	278	369	379	385	389	394	401	408	413	420	427	433	440

SO0435

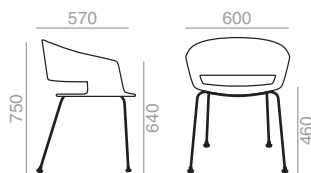

Armchair with Eco thermo-polymer shell available in several colors or Pure Eco thermo-polymer (100% recycled) available in sand color and 4-legs steel sled base with EPL5 treatment and available in white, earth brown or black. Optional auxiliary cushion for the seat.

Sillón con carcasa de termopolímero Eco disponible en diferentes colores o termopolímero Pure Eco (100% reciclado) disponible en color arena y base de 4 patas de acero con tratamiento EPL5 en acabado blanco, marrón tierra o negro. Opción de cojín auxiliar en asiento.

	COM cm. per unit
1 units	50
10 units or more	50

- 0'29 m3
- 11'5 kg
- x1

	TP	COM	1	2	3	4	5	6	7	8	9	10	11
€	396	475	489	496	501	510	519	528	537	546	555	564	573



**Description**  
**Descripción**

Stackable side chair with Eco thermo-polymer shell available in several colors (Cayenne Red and Mango Green only available in SI1245) or Pure Eco thermo-polymer (100% recycled) available in sand color.

Silla apilable de termopolímero Eco disponible en diferentes colores (rojo cayena y verde mango solo disponible en SI1245) o termopolímero Pure Eco (100% reciclado) disponible en color arena.

**Upholstery**  
**Tapicería**

The Sail collection supports following upholsteries of Andreu World Catalogue. For fabrics in our catalogue not specified in this box or customers own materials please contact our Customer Service Department.

En las colecciones de Andreu World Outdoor se han utilizado distintos tipos de tapicerías de fibra acrílica y ecopiel, especialmente concebidas para su uso en exterior. Los cojines y fundas están confeccionados con un tejido de máxima calidad que repele el agua, es resistente a los rayos UV y al moho. La colección Sail admite las siguientes tapicerías del catálogo de Andreu World. Para las telas de nuestro catálogo no indicadas en este cuadro o telas cliente, consultar con nuestro Departamento Comercial.

**Fabrics / Telas**

- 1 Sand  
Reel One
- 2 Solid & Stripes  
Tack One
- 3 Natte  
Loom Two  
Mezzo  
Reel two
- 4 Heritage  
Savane  
Reel Three  
Reel Four

- 6 Chartres  
Zori  
Patio  
Tack Two  
Tack Three
- 7 Tack Five
- 8 Domino  
Lopi
- 9 Tack Four

**Faux Leather / Ecopiel**

- 2 Silvertex
- 3 Maglia
- 10 Coast

**Eco Thermo-polymer finish**

**Acabado de Termo-polímero Eco**



**Pure Eco Thermo-polymer finish**

**Acabado de Termo-polímero Pure Eco**



**Certificates**  
**Certificados**

**Quality - Resistance**  
**Calidad - Resistencia**

UNE EN 16139:2013

**Intellectual property Propiedad intelectual**

All our collections are protected by international industrial design registries, designs patents, copyrights and intellectual Property laws. Unauthorized use of AW International Property is a criminal offence and can lead to prosecution. Todas nuestras colecciones están protegidas por registros de diseño industrial, diseño de patente, copyright y derechos de propiedad intelectual en todo el mundo. El uso no autorizado de los diseños y propiedad intelectual de AW supone un delito que puede ser sometido a acción judicial.



SI1245

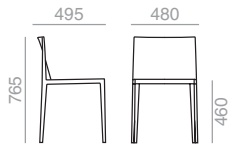

TP  
108

Thermo-polymer  
Termoplímero



Seat cushion  
Cojín asiento

COM	1	2	3	4	5	6	7	8	9	10	11	
	212	219	224	227	230	234	241	244	248	253	258	261



Linking device  
upcharge  
Incremento por  
sistema de unión

36

Chair with seat and back in Eco thermo-polymer available in different colors or Pure Eco thermo-polymer (100% recycled) available in sand color. Option for an upholstered seat. Minimum order per color: 6 units, except in the version with a upholstered seat pad (minimum does not apply).

Silla con asiento y respaldo de termopolímero Eco disponible en diferentes colores o termopolímero Pure Eco (100% reciclado) disponible en color arena. Opción de asiento plafonado. Pedido mínimo por color: 6 unidades, excepto en versión de asiento plafonado (no se aplica mínimo).

	COM cm. per unit
1 units	60
10 units or more	30

0'32 m3  
26'04 kg  
x6

12

20

BQ1250

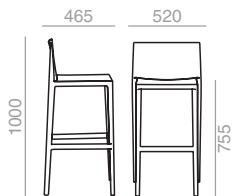

TP  
125

Thermo-polymer  
Termoplímero



Seat cushion  
Cojín asiento

COM	1	2	3	4	5	6	7	8	9	10	11	
	237	243	250	253	256	260	268	271	275	280	284	289

Barstool with seat and back in Eco thermo-polymer available in different colors or Pure Eco thermo-polymer (100% recycled) available in sand color. Option for an upholstered seat.

Banqueta alta con asiento y respaldo de termopolímero Eco disponible en diferentes colores o termopolímero Pure Eco (100% reciclado) disponible en color arena. Opción de asiento plafonado.

	COM cm. per unit
1 units	60
10 units or more	30

0'35 m3  
24'04 kg  
x4

BQ1251

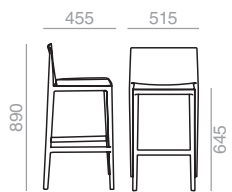

TP  
125

Thermo-polymer  
Termoplímero



Seat cushion  
Cojín asiento

COM	1	2	3	4	5	6	7	8	9	10	11	
	237	243	250	253	256	260	268	271	275	280	284	289

Counter stool with seat and back in Eco thermo-polymer available in different colors or Pure Eco thermo-polymer (100% recycled) available in sand color. Option for an upholstered seat.

Banqueta baja con asiento y respaldo de termopolímero Eco disponible en diferentes colores o termopolímero Pure Eco (100% reciclado) disponible en color arena. Opción de asiento plafonado.

	COM cm. per unit
1 units	60
10 units or more	30

0'32 m3  
23 kg  
x4



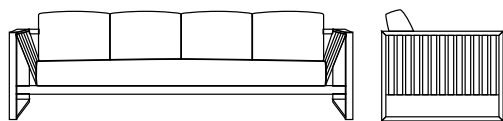

**Description**  
**Descripción**

The Sand collection includes three seater sofas with woven bands for backrest and arms available in several colors, upholstered cushions for seat and backrest, and steel frame with EPL-5 outdoor treatment available in several colors.

Colección de sofás de tres plazas con respaldo y brazos cinchados con cinchas disponibles en diferentes colores, cojines tapizados en asiento y respaldo y estructura de acero con tratamiento EPL5 para exterior disponible en diferentes colores.

**Upholstery**  
**Tapicería**

Andreu World collections use various types of upholstery in acrylic and faux leather that are especially designed for outdoor use. The covers and cushions are made of waterproof polyester fabric to protect the furniture from moisture, rain, and sun. For fabrics in our catalogue not specified in this box or customers own materials please contact our Customer Service Department.

En las colecciones de Andreu World Outdoor se han utilizado distintos tipos de tapicerías de fibra acrílica y ecopiel, especialmente concebidas para su uso en exterior. Los cojines y fundas están confeccionados con un tejido de máxima calidad que repele el agua, es resistente a los rayos UV y al moho. La colección Sand admite las siguientes tapicerías del catálogo de Andreu World. Para las telas de nuestro catálogo no indicadas en este cuadro o telas cliente, consultar con nuestro Departamento Comercial.

**Fabrics / Telas**

- 1** Sand  
Reel One
- 2** Solid & Stripes  
Tack One
- 3** Natte  
Loom Two  
Mezzo  
Reel two
- 4** Heritage  
Savane  
Reel Three  
Reel Four

- 6** Chartres  
Zori  
Patio  
Tack Two  
Tack Three

- 7** Tack Five
- 8** Domino  
Lopi
- 9** Tack Four

**Faux Leather / Ecopiel**

- 2** Silvertex
- 3** Maglia
- 10** Coast

**Steel finish**  
**Acabado de acero**

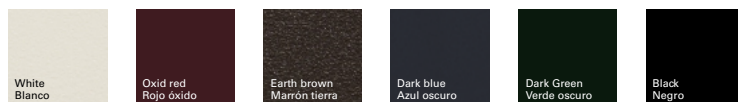

**Woven band finish**  
**Acabado de cincha**



**Certificates**  
**Certificados**

<b>Steel</b> <b>Acero</b>	UNE CEN/TR 581-4
<b>Woven band</b> <b>Cincha</b>	ISO 105-B02, ISO 105-X12, ISO 105-E03
<b>Quality - Resistance</b> <b>Calidad - Resistencia</b>	UNE EN 16139:2013

**Intellectual property Propiedad intelectual**

All our collections are protected by international industrial design registries, designs patents, copyrights and intellectual Property laws. Unauthorized use of AW International Property is a criminal offence and can lead to prosecution.  
Todas nuestras colecciones están protegidas por registros de diseño industrial, diseño de patente, copyright y derechos de propiedad intelectual en todo el mundo. El uso no autorizado de los diseños y propiedad intelectual de AW supone un delito que puede ser sometido a acción judicial.



SF4300

Sofa with steel frame and EPL5 outdoor treatment, available in several colors. 3-seater. Woven bands on back and arms, available in several colors.

Sofá con estructura de acero y tratamiento EPL-5, disponible en diferentes colores. 3 plazas. Cincha en respaldo y brazos disponible en diferentes colores.

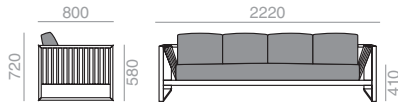

	COM cm. per unit
1 units	630
10 units or more	530

1'37 m3  
62'5 kg  
x1

COM	1	2	3	4	5	6	7	8	9	10	11	
€	3.753	3.888	3.949	3.995	4.076	4.156	4.236	4.318	4.401	4.508	4.616	4.852

**FU4800** Protective cover Funda protectora | 137 |

SF4301

Sofa with steel frame and EPL5 outdoor treatment, available in several colors. Woven bands on back and arms, available in several colors.

Sofá con estructura de acero y tratamiento EPL-5, disponible en diferentes colores. 3 plazas. Cincha en respaldo y brazos disponible en diferentes colores.

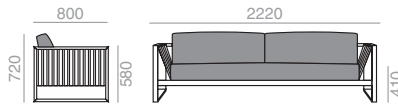

	COM cm. per unit
1 units	630
10 units or more	530

1'38 m3  
69 kg  
x1

COM	1	2	3	4	5	6	7	8	9	10	11	
€	3.567	3.700	3.759	3.806	3.886	3.966	4.045	4.125	4.205	4.284	4.365	4.445

**FU4800** Protective cover Funda protectora | 137 |

SF4325

Sofa with steel frame and EPL5 outdoor treatment, available in several colors. 2-seater. Woven bands on back and arms, available in several colors.

Sofá con estructura de acero y tratamiento EPL-5, disponible en diferentes colores. 2 plazas. Cincha en respaldo y brazos disponible en diferentes colores.

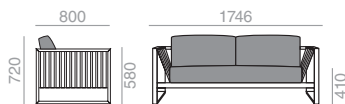

	COM cm. per unit
1 units	450
10 units or more	400

0'98 m3  
60 kg  
x1

COM	1	2	3	4	5	6	7	8	9	10	11	
€	3.326	3.433	3.481	3.518	3.582	3.646	3.711	3.775	3.839	3.903	3.966	4.032

**FU4807** Protective cover Funda protectora | 91 |

SF4326

Sofa with steel frame and EPL5 outdoor treatment, available in several colors. 1-seater. Woven bands on back and arms, available in several colors.

Sofá con estructura de acero y tratamiento EPL-5, disponible en diferentes colores. 1 plaza. Cincha en respaldo y brazos, disponible en diferentes colores.

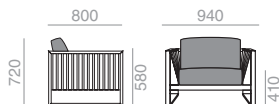

	COM cm. per unit
1 units	260
10 units or more	220

0'59 m3  
32 kg  
x1

COM	1	2	3	4	5	6	7	8	9	10	11	
€	2.393	2.445	2.470	2.487	2.519	2.550	2.582	2.614	2.646	2.677	2.709	2.745

**FU4808** Protective cover Funda protectora | 77 |

**CJ4314**

Loose cushion.  
Cojín auxiliar.

	COM cm. per unit
1 units	60
10 units or more	60

0'02 m3  
 1'6 kg  
 x1

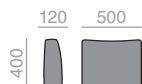

COM	1	2	3	4	5	6	7	8	9	10	11	
€	91	103	109	113	121	128	136	143	151	158	166	173

**CJ0287**

Loose cushion for armchair and barstool.  
Cojín auxiliar para sillón y banqueta.

	COM cm. per unit
1 units	40
10 units or more	40

0'02 m3  
 1'6 kg  
 x1

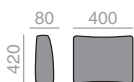

COM	1	2	3	4	5	6	7	8	9	10	11	
€	95	103	108	112	117	125	129	135	140	146	150	157

**CJ0291**

Loose cushion for lounge chair.  
Cojín auxiliar para butaca.

	COM cm. per unit
1 units	45
10 units or more	45

0'02 m3  
 1'6 kg  
 x1

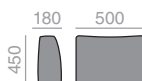

COM	1	2	3	4	5	6	7	8	9	10	11	
€	97	108	114	120	127	135	142	150	158	165	173	180



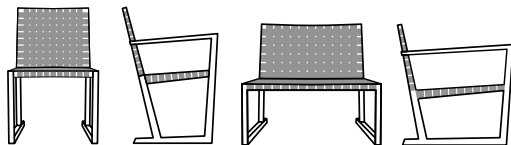

**Description**  
**Descripción**

Chairs, armchairs and lounge chairs with braided strap seat and back in earth brown, sand, graphite or white finish and iroko wood frame. Also available in footrest version.

Sillas, sillones y butacas con asiento y respaldo cinchado con cinchas en acabado marrón tierra, arena, grafito o blanco y estructura de madera maciza de iroko. Disponible versión de reposapiés.

**Upholstery**  
**Tapicería**

Andreu World collections use various types of upholstery in acrylic and faux leather that are especially designed for outdoor use. The covers and cushions are made of waterproof polyester fabric to protect the furniture from moisture, rain, and sun. For fabrics in our catalogue not specified in this box or customers own materials please contact our Customer Service Department.

En las colecciones de Andreu World Outdoor se han utilizado distintos tipos de tapicerías de fibra acrílica y ecopiel, especialmente concebidas para su uso en exterior. Los cojines y fundas están confeccionados con un tejido de máxima calidad que repele el agua, es resistente a los rayos UV y al moho. La colección Serena Teak admite las siguientes tapicerías del catálogo de Andreu World. Para las telas de nuestro catálogo no indicadas en este cuadro o telas cliente, consultar con nuestro Departamento Comercial.

**Fabrics / Telas**

- 1** Sand  
Reel One
- 2** Solid & Stripes  
Tack One
- 3** Natte  
Loom Two  
Mezzo  
Reel two
- 4** Heritage  
Savane  
Reel Three  
Reel Four

- 6** Chartres  
Zori  
Patio  
Tack Two  
Tack Three

- 7** Tack Five
- 8** Domino  
Lopi
- 9** Tack Four

**Faux Leather / Ecopiel**

- 2** Silvertex
- 3** Maglia
- 10** Coast

**Wood finish Iroko**  
**Acabado madera Iroko**

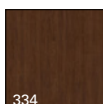

**Woven band finish**  
**Acabado de cincha**



**Certificates**  
**Certificados**

**Woven band** ISO 105-B02, ISO 105-X12, ISO 105-E03  
**Cincha**

**Quality - Resistance** UNE EN 16139:2013  
**Calidad - Resistencia**

**Intellectual property Propiedad intelectual**

All our collections are protected by international industrial design registries, designs patents, copyrights and intellectual Property laws. Unauthorized use of AW International Property is a criminal offence and can lead to prosecution.  
Todas nuestras colecciones están protegidas por registros de diseño industrial, diseño de patente, copyright y derechos de propiedad intelectual en todo el mundo. El uso no autorizado de los diseños y propiedad intelectual de AW supone un delito que puede ser sometido a acción judicial.



SI1190

Chair with webbing seat and backrest and solid iroko wood frame.

Silla con asiento y respaldo cinchado y estructura de madera maciza de iroko.

0'41 m<sup>3</sup>

17'5 kg

x1

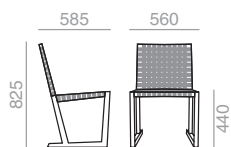

€ 804



SO1191

Armchair with webbing seat and backrest and solid iroko wood frame.

Sillón con asiento y respaldo cinchado y estructura de madera maciza de iroko.

0'3 m<sup>3</sup>

12 kg

x1

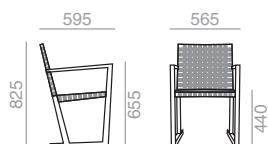

€ 985



BU1192

Lounge chair with webbing seat and backrest and solid iroko wood frame. Low back version.

Butaca de respaldo bajo con asiento y respaldo cinchado y estructura de madera maciza de iroko.

0'49 m<sup>3</sup>

11 kg

x1

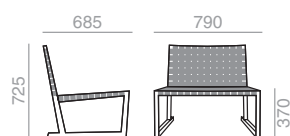

€ 998



BU1193

Lounge arm chair with webbing seat and backrest and solid iroko wood frame. Low back version.

Butaca de respaldo bajo con brazos, asiento y respaldo cinchado y estructura de madera maciza de iroko.

0'48 m<sup>3</sup>

14 kg

x1

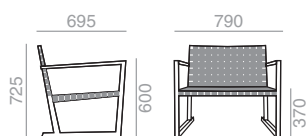

€ 1.192



**BU1194**

Lounge chair with webbing seat and backrest and solid iroko wood frame. High back version.  
 Butaca de respaldo alto con asiento y respaldo cinchado y estructura de madera maciza de iroko.

0'58 m3  
 14 kg  
 x1

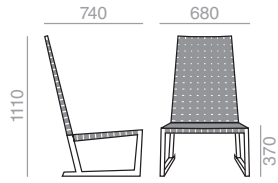

€ 1.136

**FU4811** Protective cover Funda protectora | 95 |

**BU1195**

Lounge arm chair with webbing seat and backrest and solid iroko wood frame. High back version.  
 Butaca de respaldo alto con brazos, asiento y respaldo cinchado y estructura de madera maciza de iroko.

0'62 m3  
 15'5 kg  
 x1

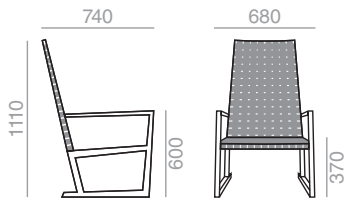

€ 1.295

**FU4811** Protective cover Funda protectora | 95 |

**RS1196**

Ottoman with webbing seat and solid iroko wood frame.  
 Reposapiés con asiento cinchado y estructura de madera maciza de iroko.

0'22 m3  
 6 kg  
 x1

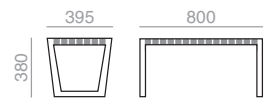

€ 610

**FU4812** Protective cover Funda protectora | 43 |

**CJ1179**

Seat cushion for high back lounge chair (BU1194).  
 Cojín de asiento para butaca de respaldo alto (BU1194).

	COM cm. per unit
1 units	125
10 units or more	125

0'01 m3  
 0'6 kg  
 x1

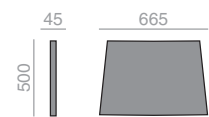

COM	1	2	3	4	5	6	7	8	9	10	11	
€	122	151	164	173	191	207	224	242	258	275	293	309

**CJ1181**

Seat cushion for low back lounge chair (BU1192).  
 Cojín de asiento para butaca de respaldo bajo (BU1192).

	COM cm. per unit
1 units	125
10 units or more	125

0'01 m3  
 0'6 kg  
 x1

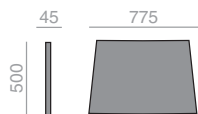

COM	1	2	3	4	5	6	7	8	9	10	11	
€	128	157	170	179	197	213	230	248	264	281	299	315

**CJ1187**

Seat cushion for high back lounge chair with arms (BU1195).  
 Cojín de asiento para butaca con brazos de respaldo alto (BU1195).

	COM cm. per unit
1 units	125
10 units or more	125

0'01 m3  
 0'6 kg  
 x1

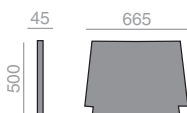

COM	1	2	3	4	5	6	7	8	9	10	11	
€	137	166	179	188	206	222	239	257	273	290	307	324

**CJ1188**

Seat cushion for low back lounge chair with arms (BU1193).  
 Cojín de asiento para butaca con brazos de respaldo bajo (BU1193).

	COM cm. per unit
1 units	125
10 units or more	125

0'01 m3  
 0'6 kg  
 x1

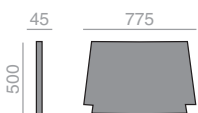

COM	1	2	3	4	5	6	7	8	9	10	11	
€	140	169	182	191	209	225	242	260	276	293	310	327



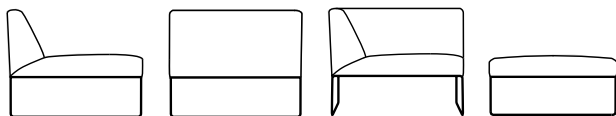

**Description**  
**Descripción**

Highly modular sectional sofa that allows for numerous configurations. Constructed with an EPL-5 treated steel structure and available in different colors. Removable upholstered parts are available in all our outdoor fabrics.

Sofá componible de gran modularidad, que permite diferentes composiciones. Estructura de acero con tratamiento EPL-5 disponible en diferentes colores y partes tapizadas desmontables, disponibles en todos nuestros tejidos para uso exterior.

**Upholstery**  
**Tapicería**

Andreu World collections use various types of upholstery in acrylic and faux leather that are especially designed for outdoor use. The covers and cushions are made of waterproof polyester fabric to protect the furniture from moisture, rain, and sun. For fabrics in our catalogue not specified in this box or customers own materials please contact our Customer Service Department.

En las colecciones de Andreu World Outdoor se han utilizado distintos tipos de tapicerías de fibra acrílica y ecopiel, especialmente concebidas para su uso en exterior. Los cojines y fundas están confeccionados con un tejido de máxima calidad que repele el agua, es resistente a los rayos UV y al moho. La colección Siesta Outdoor admite las siguientes tapicerías del catálogo de Andreu World. Para las telas de nuestro catálogo no indicadas en este cuadro o telas cliente, consultar con nuestro Departamento Comercial.

**Fabrics / Telas**

- |  |  |
|--|--|
| <b>1</b> Sand<br>Reel One                              | <b>6</b> Chartres<br>Zori<br>Patio<br>Tack Two<br>Tack Three |
| <b>2</b> Solid & Stripes<br>Tack One                   | <b>7</b> Tack Five   |
| <b>3</b> Natte<br>Loom Two<br>Mezzo<br>Reel two        | <b>8</b> Domino<br>Lopi                                      |
| <b>4</b> Heritage<br>Savane<br>Reel Three<br>Reel Four | <b>9</b> Tack Four   |

**Faux Leather / Ecopiel**

- 2** Silvertex
- 3** Maglia
- 10** Coast

**Steel finish**  
**Acabado de acero**

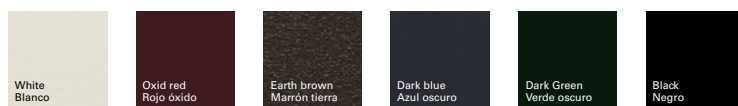

**Certificates**  
**Certificados**

**Steel** UNE CEN/TR 581-4  
**Acero**

**Quality - Resistance** UNE EN 16139:2013  
**Calidad - Resistencia**

**Intellectual property Propiedad intelectual**

All our collections are protected by international industrial design registries, designs patents, copyrights and intellectual Property laws. Unauthorized use of AW International Property is a criminal offence and can lead to prosecution.

Todas nuestras colecciones están protegidas por registros de diseño industrial, diseño de patente, copyright y derechos de propiedad intelectual en todo el mundo. El uso no autorizado de los diseños y propiedad intelectual de AW supone un delito que puede ser sometido a acción judicial.



SF4750

Central sofa module.  
Módulo central.

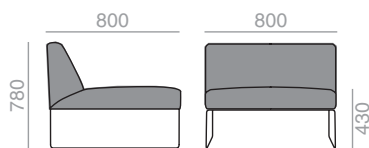

	COM cm. per unit
1 units	300
10 units or more	300

0'6 m3  
27 kg  
x1

COM	1	2	3	4	5	6	7	8	9	10	11	
€	1.463	1.530	1.560	1.593	1.652	1.714	1.774	1.836	1.896	1.957	2.018	2.079

**FU4760** Protective cover Funda protectora | 94 |

SF4751

Right corner sofa module.  
Módulo rinconero. Lado derecho.

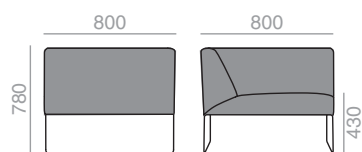

	COM cm. per unit
1 units	400
10 units or more	400

0'6 m3  
31 kg  
x1

COM	1	2	3	4	5	6	7	8	9	10	11	
€	2.031	2.137	2.185	2.235	2.330	2.426	2.517	2.610	2.705	2.799	2.894	2.986

**FU4761** Protective cover Funda protectora | 111 |

SF4755

Left corner sofa module.  
Módulo rinconero. Lado izquierdo.

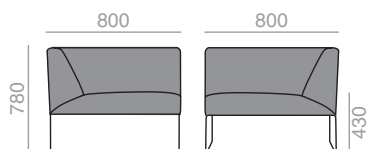

	COM cm. per unit
1 units	400
10 units or more	400

0'6 m3  
31 kg  
x1

COM	1	2	3	4	5	6	7	8	9	10	11	
€	2.029	2.137	2.185	2.235	2.330	2.426	2.517	2.610	2.705	2.799	2.894	2.986

**FU4761** Protective cover Funda protectora | 111 |

RS4754

Ottoman.  
Reposapiés.

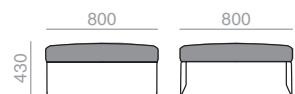

	COM cm. per unit
1 units	200
10 units or more	200

0'32 m3  
18'8 kg  
x1

COM	1	2	3	4	5	6	7	8	9	10	11	
€	894	942	965	982	1.010	1.038	1.068	1.096	1.125	1.154	1.183	1.211

**FU4765** Protective cover Funda protectora | 67 |

**CJ0287**

Loose cushion for armchair and barstool.  
Cojín auxiliar para sillón y banqueta.

	COM cm. per unit
1 units	40
10 units or more	40

0'02 m3  
 1'6 kg  
 x1

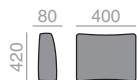

COM	1	2	3	4	5	6	7	8	9	10	11	
€	95	103	108	112	117	125	129	135	140	146	150	157

**CJ0291**

Loose cushion for lounge chair.  
Cojín auxiliar para butaca.

	COM cm. per unit
1 units	45
10 units or more	45

0'02 m3  
 1'6 kg  
 x1

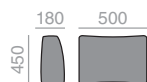

COM	1	2	3	4	5	6	7	8	9	10	11	
€	97	108	114	120	127	135	142	150	158	165	173	180

**Protective cover Funda protectora**

**FU4760**  
94



**FU4763**  
173



**FU4764**  
213



**FU4761**  
111



**FU4829**  
173



**FU4832**  
213



**FU4835**  
111



**FU4830**  
173



**FU4833**  
213



**FU4765**  
67



**FU4831**  
173



**FU4834**  
213



Examples of modular configurations  
Ejemplos de combinaciones modulares

Set 1 / Conjunto 1

3 Modules 3 Módulos  
RS4754 + SF4750 + SF4750

	COM cm. per unit
1 units	800
10 units or more	800

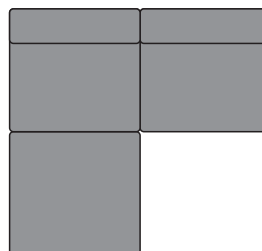

Covers /Fundas

FU4763 + FU4760



€	COM	1	2	3	4	5	6	7	8	9	10	11	
		3.820	4.002	4.085	4.168	4.314	4.466	4.616	4.768	4.917	5.068	5.219	5.369

<b>FU4763</b>	Protective cover Funda protectora	173	<b>FU4760</b>	Protective cover Funda protectora	94
---------------	--------------------------------------	-----	---------------	--------------------------------------	----

Examples of modular configurations  
Ejemplos de combinaciones modulares

Set 2 / Conjunto 2

5 Modules 5 Módulos  
SF4750 + SF4750 + SF4751 + SF4750 + SF4750

	COM cm. per unit
1 units	1600
10 units or more	1600

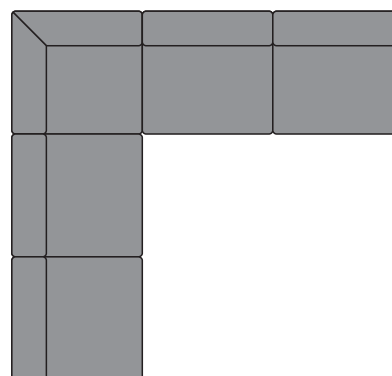

Covers /Fundas

FU4832 + FU4763

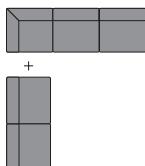

€	COM	1	2	3	4	5	6	7	8	9	10	11	
		7.883	8.257	8.425	8.607	8.938	9.282	9.613	9.954	10.289	10.627	10.966	11.302

<b>FU4832</b>	Protective cover Funda protectora	213	<b>FU4763</b>	Protective cover Funda protectora	173
---------------	--------------------------------------	-----	---------------	--------------------------------------	-----

**Set 3 / Conjunto 3**

6 Modules 6 Módulos

SF4751 + SF4750 + SF4750 + SF4755 + SF4750 + RS4754

	COM cm. per unit
1 units	1900
10 units or more	1900

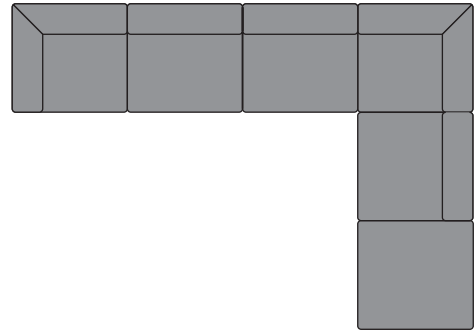

**Covers /Fundas**

FU4832 + FU4829 + FU4765

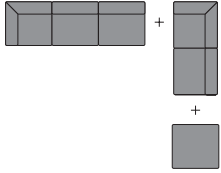

€	COM	1	2	3	4	5	6	7	8	9	10	11
	9.343	9.806	10.015	10.231	10.626	11.032	11.424	11.824	12.223	12.623	13.025	13.420

<b>FU4832</b>	Protective cover Funda protectora	213	<b>FU4829</b>	Protective cover Funda protectora	173	<b>FU4765</b>	Protective cover Funda protectora	67
---------------	--------------------------------------	-----	---------------	--------------------------------------	-----	---------------	--------------------------------------	----

**Examples of modular configurations  
Ejemplos de combinaciones modulares**

**Set 4 / Conjunto 4**

7 Modules 7 Módulos

SF4750 + SF4750 + SF4751 + SF4750 + SF4750 + SF4750 + RS4754

	COM cm. per unit
1 units	2100
10 units or more	2100

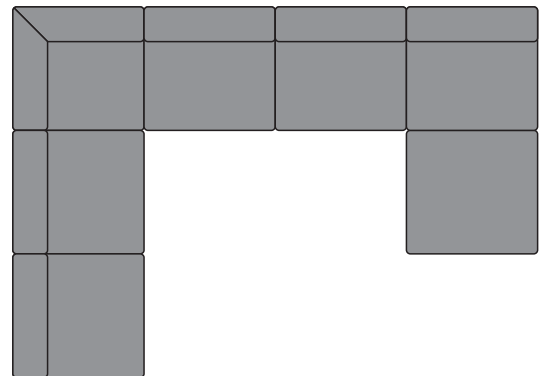

**Covers /Fundas**

FU4833 + FU4764 + FU4765

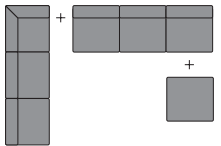

€	COM	1	2	3	4	5	6	7	8	9	10	11
	10.240	10.729	10.950	11.182	11.600	12.034	12.455	12.886	13.310	13.738	14.167	14.592

<b>FU4832</b>	Protective cover Funda protectora	213	<b>FU4829</b>	Protective cover Funda protectora	173	<b>FU4765</b>	Protective cover Funda protectora	67
---------------	--------------------------------------	-----	---------------	--------------------------------------	-----	---------------	--------------------------------------	----

**Set 5 / Conjunto 5**

4 Modules 4 Módulos  
SF4751 + SF4750 + SF4750 + SF4755

	COM cm. per unit
1 units	1400
10 units or more	1400



**Covers /Fundas**

FU4829 + FU4830



€	COM	1	2	3	4	5	6	7	8	9	10	11
	6.986	7.334	7.490	7.656	7.964	8.280	8.582	8.892	9.202	9.512	9.824	10.130

<b>FU4829</b>	Protective cover Funda protectora	173	<b>FU4830</b>	Protective cover Funda protectora	173
---------------	--------------------------------------	-----	---------------	--------------------------------------	-----

**Examples of modular configurations  
Ejemplos de combinaciones modulares**

**Set 6 / Conjunto 6**

5 Modules 5 Módulos  
SF4751 + SF4750 + SF4750 + SF4750 + SF4755

	COM cm. per unit
1 units	1700
10 units or more	1700



**Covers /Fundas**

FU4832 + FU4830

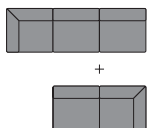

€	COM	1	2	3	4	5	6	7	8	9	10	11
	8.449	8.864	9.050	9.249	9.616	9.994	10.356	10.728	11.098	11.469	11.842	12.209

<b>FU4832</b>	Protective cover Funda protectora	213	<b>FU4830</b>	Protective cover Funda protectora	173
---------------	--------------------------------------	-----	---------------	--------------------------------------	-----

**Set 7 / Conjunto 7**

6 Modules 6 Módulos

SF4751 + SF4750 + SF4751 + SF4750 + SF4750 + SF4755

	COM cm. per unit
1 units	2100
10 units or more	2100

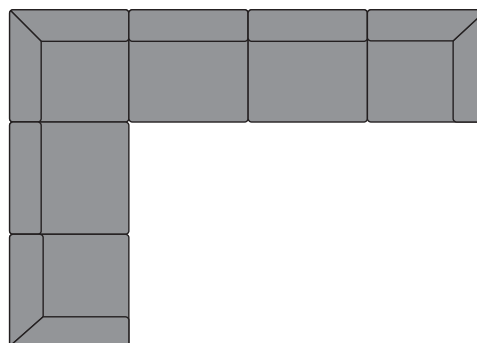

**Covers /Fundas**

FU4829 + FU4829 + FU4830

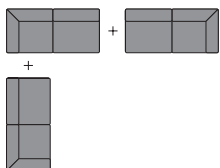

€	COM	1	2	3	4	5	6	7	8	9	10	11
	10.480	11.001	11.235	11.484	11.946	12.420	12.873	13.338	13.803	14.268	14.736	15.195

<b>FU4829</b>	Protective cover Funda protectora	173	<b>FU4829</b>	Protective cover Funda protectora	173	<b>FU4830</b>	Protective cover Funda protectora	173
---------------	--------------------------------------	-----	---------------	--------------------------------------	-----	---------------	--------------------------------------	-----

**Examples of modular configurations  
Ejemplos de combinaciones modulares**

**Set 8 / Conjunto 8**

9 Modules 9 Módulos

SF4750 + SF4750 + SF4751 + SF4750 + SF4750 + SF4750 + SF4755 + SF4750 + SF4750

	COM cm. per unit
1 units	2900
10 units or more	2900

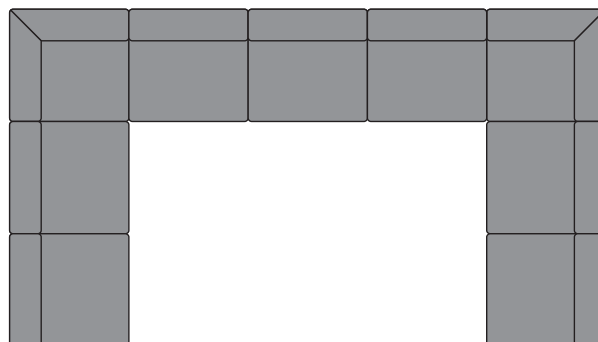

**Covers /Fundas**

FU4833 + FU4764 + FU4832

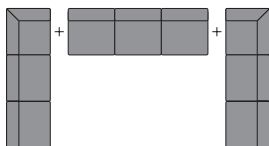

€	COM	1	2	3	4	5	6	7	8	9	10	11
	14.301	14.984	15.290	15.621	16.224	16.850	17.452	18.072	18.682	19.297	19.914	20.525

<b>FU4833</b>	Protective cover Funda protectora	213	<b>FU4764</b>	Protective cover Funda protectora	213	<b>FU4832</b>	Protective cover Funda protectora	213
---------------	--------------------------------------	-----	---------------	--------------------------------------	-----	---------------	--------------------------------------	-----





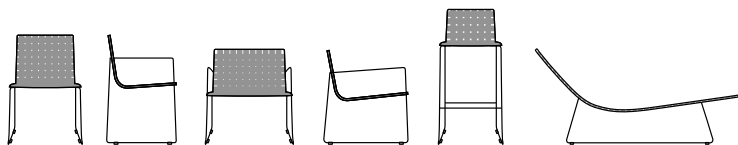

**Description**  
**Descripción**

Collection of chairs, lounge chairs, and barstools with woven band seats and backs available several colors. Chaise lounge version with a headrest cushion is available. The steel EPL-5 outdoor treated frame is available in several colors.

Programa de sillas, butacas y taburetes con cincha en asiento y respaldo disponible en diferentes colores. Se ofrece una chaise lounge y un cojín reposacabezas. Es estructura de acero con tratamiento EPL-5 disponible en diferentes colores.

**Upholstery**  
**Tapicería**

Andreu World collections use various types of upholstery in acrylic and faux leather that are especially designed for outdoor use. The covers and cushions are made of waterproof polyester fabric to protect the furniture from moisture, rain, and sun. For fabrics in our catalogue not specified in this box or customers own materials please contact our Customer Service Department.

En las colecciones de Andreu World Outdoor se han utilizado distintos tipos de tapicerías de fibra acrílica y ecopiel, especialmente concebidas para su uso en exterior. Los cojines y fundas están confeccionados con un tejido de máxima calidad que repele el agua, es resistente a los rayos UV y al moho. La colección Trenza admite las siguientes tapicerías del catálogo de Andreu World. Para las telas de nuestro catálogo no indicadas en este cuadro o telas cliente, consultar con nuestro Departamento Comercial.

**Fabrics / Telas**

- 1** Sand  
Reel One
- 2** Solid & Stripes  
Tack One
- 3** Natte  
Loom Two  
Mezzo  
Reel two
- 4** Heritage  
Savane  
Reel Three  
Reel Four

- 6** Chartres  
Zori  
Patio  
Tack Two  
Tack Three
- 7** Tack Five
- 8** Domino  
Lopi
- 9** Tack Four

**Faux Leather / Ecopiel**

- 2** Silvertex
- 3** Maglia
- 10** Coast

**Steel finish**  
**Acabado de acero**

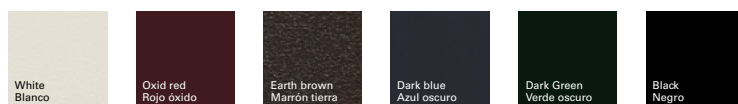

**Woven band finish**  
**Acabado de cincha**



**Certificates**  
**Certificados**

<b>Steel</b> <b>Acero</b>	UNE CEN/TR 581-4
<b>Woven band</b> <b>Cincha</b>	ISO 105-B02, ISO 105-X12, ISO 105-E03
<b>Quality - Resistance</b> <b>Calidad - Resistencia</b>	UNE EN 16139:2013

**Intellectual property Propiedad intelectual**

All our collections are protected by international industrial design registries, designs patents, copyrights and intellectual Property laws. Unauthorized use of AW International Property is a criminal offence and can lead to prosecution.  
Todas nuestras colecciones están protegidas por registros de diseño industrial, diseño de patente, copyright y derechos de propiedad intelectual en todo el mundo. El uso no autorizado de los diseños y propiedad intelectual de AW supone un delito que puede ser sometido a acción judicial.



SI0700

Stackable chair with webbing on seat and backrest and steel sled base with EPL-5 outdoor treatment.

Silla apilable con carcasa cinchada y base de patín de varilla de acero con tratamiento EPL-5 para exterior.

0'3 m3  
42 kg  
x2

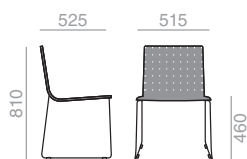

€ 514



SO0701

Stackable armchair with webbing on seat and backrest and steel sled base with EPL-5 outdoor treatment.

Sillón apilable con carcasa cinchada y base de patín de varilla de acero con tratamiento EPL-5 para exterior. Tumbona apilable con carcasa cinchada y base de patín de varilla de acero con tratamiento EPL-5 para exterior.

0'32 m3  
42 kg  
x2

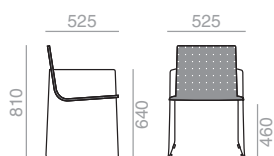

€ 598



BU0702

Stackable lounge chair with webbing on seat and backrest and steel sled base with EPL-5 outdoor treatment.

Butaca apilable con carcasa cinchada y base de patín de varilla de acero con tratamiento EPL-5 para exterior.

0'41 m3  
22 kg  
x2

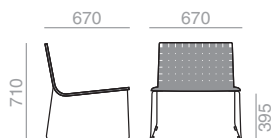

€ 673



BU0703

Stackable lounge chair with webbing on seat and backrest and steel sled base with EPL-5 outdoor treatment.

Butaca apilable con brazos con carcasa cinchada y base de patín de varilla de acero con tratamiento EPL-5 para exterior.

0'42 m3  
29 kg  
x2

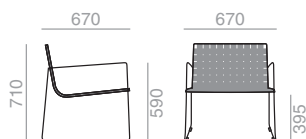

€ 685



TU0704

Stackable chaise lounge with webbing on seat and backrest and steel sled base with EPL-5 outdoor treatment.  
Tumbona apilable con carcasa cinchada y base de patín de varilla de acero con tratamiento EPL-5 para exterior.

0'36 m3  
94 kg  
x2

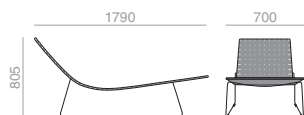

€ 1.324

**FU4934** Protective cover Funda protectora | 111 |

BQ0705

Barstool with webbing on seat and backrest and steel sled base with EPL-5 outdoor treatment.  
Banqueta con carcasa cinchada y base de patín de varilla de acero con tratamiento EPL-5 para exterior.

0'33 m3  
13 kg  
x1

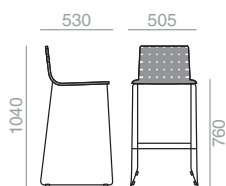

€ 555

**FU4935** Protective cover Funda protectora | 111 |

CJ0706

Headrest cushion.  
Cojín reposacabezas.

	COM cm. per unit
1 units	50
10 units or more	38

0'01 m3  
0'6 kg  
x1

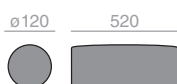

COM	1	2	3	4	5	6	7	8	9	10	11
€ 90	97	101	104	109	115	119	125	130	136	140	146



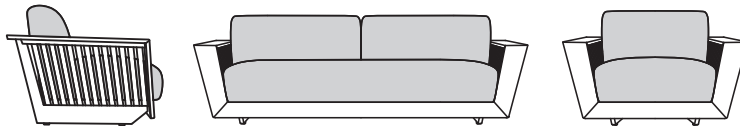

**Description** Upholstered 1 to 3-seater sofa with solid iroko wood structure. Valid for outdoor use.  
**Descripción** Sofá tapizado de 1 a 3 plazas con estructura de madera maciza de iroco. Válido para su uso en exterior.

**Upholstery** Andreu World collections use various types of upholstery in acrylic and faux leather that are especially designed for outdoor use. The covers and cushions are made of waterproof polyester fabric to protect the furniture from moisture, rain, and sun. For fabrics in our catalogue not specified in this box or customers own materials please contact our Customer Service Department.  
**Tapicería**

En las colecciones de Andreu World Outdoor se han utilizado distintos tipos de tapicerías de fibra acrílica y ecopiel, especialmente concebidas para su uso en exterior. Los cojines y fundas están confeccionados con un tejido de máxima calidad que repele el agua, es resistente a los rayos UV y al moho.

**Fabrics / Telas**

- 1** Sand  
Reel One
- 2** Solid & Stripes  
Tack One
- 3** Natte  
Loom Two  
Mezzo  
Reel two
- 4** Heritage  
Savane  
Reel Three  
Reel Four

- 6** Chartres  
Zori  
Patio  
Tack Two  
Tack Three
- 7** Tack Five
- 8** Domino  
Lopi
- 9** Tack Four

**Faux Leather / Ecopiel**

- 2** Silvertex
- 3** Maglia
- 10** Coast

**Wood finish Iroko**  
**Acabado madera Iroko**

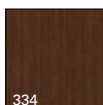

**Intellectual property Propiedad intelectual**

All our collections are protected by international industrial design registries, designs patents, copyrights and intellectual Property laws. Unauthorized use of AW International Property is a criminal offence and can lead to prosecution.  
 Todas nuestras colecciones están protegidas por registros de diseño industrial, diseño de patente, copyright y derechos de propiedad intelectual en todo el mundo. El uso no autorizado de los diseños y propiedad intelectual de AW supone un delito que puede ser sometido a acción judicial.



**SF2360** **NEW**

Upholstered 1-seater sofa with solid iroko wood structure.

Sofá tapizado de 1 plaza con estructura de madera maciza de iroco.

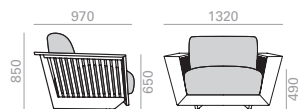

	COM cm. per unit
1 units	300
10 units or more	300

1'78 m<sup>3</sup>  
30 kg  
x1

COM	1	2	3	4	5	6	7	8	9	10	11	
€	3.597	3.671	3.703	3.729	3.773	3.816	3.861	3.905	3.948	3.992	4.035	4.081

**SF2361** **NEW**

Upholstered 2-seater sofa with solid iroko wood structure.

Sofá tapizado de 2 plazas con estructura de madera maciza de iroco.

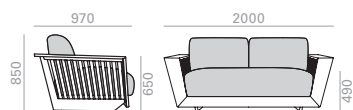

	COM cm. per unit
1 units	600
10 units or more	600

1'42 m<sup>3</sup>  
55 kg  
x1

COM	1	2	3	4	5	6	7	8	9	10	11	
€	4.944	5.090	5.155	5.206	5.294	5.382	5.469	5.556	5.645	5.732	5.821	5.908

**SF2362** **NEW**

Upholstered 3-seater sofa with solid iroko wood structure.

Sofá tapizado de 3 plazas con estructura de madera maciza de iroco.

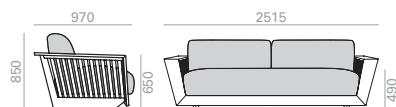

	COM cm. per unit
1 units	700
10 units or more	700

0'95 m<sup>3</sup>  
75 kg  
x1

COM	1	2	3	4	5	6	7	8	9	10	11	
€	5.715	5.885	5.961	6.021	6.124	6.226	6.327	6.431	6.532	6.635	6.737	6.840

# Andreu World >Outdoor

Base Collection

Colección de bases





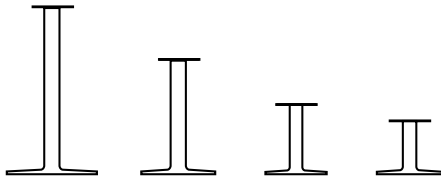

**Description**  
**Descripción**

Injected aluminum table base with an oval column and rounded base plate. Available in 3 different diameters and 4 heights. Offered in earth brown, matte white or matte black. Combinable with any model from our Top collection.

Base de mesa con pie circular y columna ovalada de inyección de aluminio. Disponible en 3 diámetros y 4 alturas diferentes. Se ofrece en acabados marrón tierra, blanco o negro mate. Combinable con cualquier modelo de la colección Top.

**Aluminum finish**  
**Acabado aluminio**

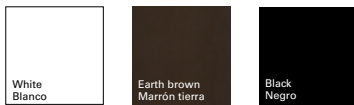

**Certificates**  
**Certificados**

Quality - Resistance  
Calidad - Resistencia

UNE CEN/TR 581-4

Durability of exterior-grade furniture.  
Durabilidad de mobiliario de exterior.

**Intellectual property Propiedad intelectual**

All our collections are protected by international industrial design registries, designs patents, copyrights and intellectual Property laws. Unauthorized use of AW International Property is a criminal offence and can lead to prosecution.

Todas nuestras colecciones están protegidas por registros de diseño industrial, diseño de patente, copyright y derechos de propiedad intelectual en todo el mundo. El uso no autorizado de los diseños y propiedad intelectual de AW supone un delito que puede ser sometido a acción judicial.



Dual 45

Maximum table top 600x600 / ø700. Minimum table top 470x470 / ø550. Estimated table base assembly time 3 minutes. The price of the unassembled table bases applies only to orders greater than 10 units.

Medida máxima de sobre 600x600 / ø700. Medida mínima de sobre 470x470 / ø550. Tiempo estimado de montaje por base 3 min. El precio de las bases desmontadas se aplicará sólo para pedidos a partir de 10 unidades.

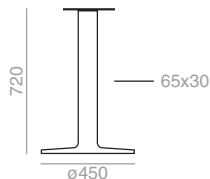

**BM4361**  
White/Matte black/Earth brown  
Blanco/Negro mate/Marrón tierra

0'17 m3  
15'5 kg  
x1  
1 boxes bultos

Assembled	Montada	338
Unassembled	Desmontada	314

Dual 45

Maximum table top 800x800 / ø800. Minimum table top 470x470 / ø550. Estimated table base assembly time 3 minutes. The price of the unassembled table bases applies only to orders greater than 10 units.

Medida máxima de sobre 800x800 / ø800. Medida mínima de sobre 470x470 / ø550. Tiempo estimado de montaje por base 3 min. El precio de las bases desmontadas se aplicará sólo para pedidos a partir de 10 unidades.

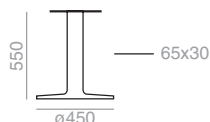

**BM4364**  
White/Matte black/Earth brown  
Blanco/Negro mate/Marrón tierra

0'17 m3  
14'5 kg  
x1  
1 boxes bultos

Assembled	Montada	335
Unassembled	Desmontada	309

Dual 45

Maximum table top 800x800 / ø800. Minimum table top 470x470 / ø550. Estimated table base assembly time 3 minutes. The price of the unassembled table bases applies only to orders greater than 10 units.

Medida máxima de sobre 800x800 / ø800. Medida mínima de sobre 470x470 / ø550. Tiempo estimado de montaje por base 3 min. El precio de las bases desmontadas se aplicará sólo para pedidos a partir de 10 unidades.

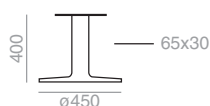

**BM4367**  
White/Matte black/Earth brown  
Blanco/Negro mate/Marrón tierra

0'14 m3  
14 kg  
x1  
1 boxes bultos

Assembled	Montada	326
Unassembled	Desmontada	301

Dual 50

Maximum table top 1000x1000 / ø1000. Minimum table top 520x520 / ø550. Estimated table base assembly time 3 minutes. The price of the unassembled table bases applies only to orders greater than 10 units.

Medida máxima de sobre 1000x1000 / ø1000. Medida mínima de sobre 520x520 / ø550. Tiempo estimado de montaje por base 3 min. El precio de las bases desmontadas se aplicará sólo para pedidos a partir de 10 unidades.

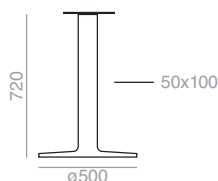

**BM4386**  
White/Matte black/Earth brown  
Blanco/Negro mate/Marrón tierra

0'27 m3  
18 kg  
x1  
1 boxes bultos

Assembled	Montada	447
Unassembled	Desmontada	418

Dual 50

Maximum table top 1000x1000 / ø1000. Minimum table top 520x520 / ø550. Estimated table base assembly time 3 minutes. The price of the unassembled table bases applies only to orders greater than 10 units.

Medida máxima de sobre 1000x1000 / ø1000. Medida mínima de sobre 520x520 / ø550. Tiempo estimado de montaje por base 3 min. El precio de las bases desmontadas se aplicará sólo para pedidos a partir de 10 unidades.

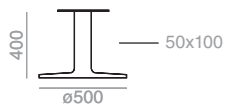

**BM4384**  
White/Matte black/Earth brown  
Blanco/Negro mate/Marrón tierra

0'19 m3  
15'5 kg  
x1  
1 boxes bultos

Assembled	Montada	417
Unassembled	Desmontada	400

Dual 60

Maximum table top 1200x1200 / ø1200. Minimum table top 520x520 / ø550. Estimated table base assembly time 3 minutes. The price of the unassembled table bases applies only to orders greater than 10 units.

Medida máxima de sobre 1200x1200 / ø1200. Medida mínima de sobre 520x520 / ø550. Tiempo estimado de montaje por base 3 min. El precio de las bases desmontadas se aplicará sólo para pedidos a partir de 10 unidades.

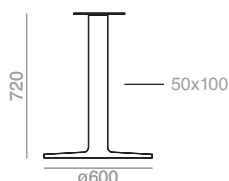

**BM4380**  
White/Matte black/Earth brown  
Blanco/Negro mate/Marrón tierra

0'36 m3  
20 kg  
x1  
1 boxes bultos

Assembled	Montada	480
Unassembled	Desmontada	450

Dual 60

Maximum table top 1200x1200 / ø1200. Minimum table top 520x520 / ø550. Estimated table base assembly time 3 minutes. The price of the unassembled table bases applies only to orders greater than 10 units.

Medida máxima de sobre 1200x1200 / ø1200. Medida mínima de sobre 520x520 / ø550. Tiempo estimado de montaje por base 3 min. El precio de las bases desmontadas se aplicará sólo para pedidos a partir de 10 unidades.

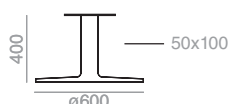

**BM4378**  
White/Matte black/Earth brown  
Blanco/Negro mate/Marrón tierra

0'24 m3  
17'5 kg  
x1  
1 boxes bultos

Assembled	Montada	447
Unassembled	Desmontada	432

Dual 60

Maximum table top 900x900 / ø900. Minimum table top 520x520 / ø550. Estimated table base assembly time 3 minutes. The price of the unassembled table bases applies only to orders greater than 10 units.

Medida máxima de sobre 900x900 / ø900. Medida mínima de sobre 520x520 / ø550. Tiempo estimado de montaje por base 3 min. El precio de las bases desmontadas se aplicará sólo para pedidos a partir de 10 unidades.

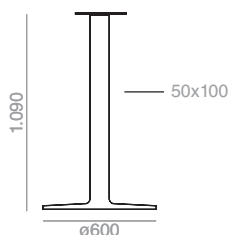

**BM4382**  
White/Matte black/Earth brown  
Blanco/Negro mate/Marrón tierra

0'48 m3  
22 kg  
x1  
1 boxes bultos

Assembled	Montada	516
Unassembled	Desmontada	486



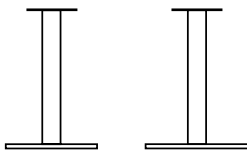

**Description**  
**Descripción**

Central base with injected aluminum base plate. Offered in extruded aluminum and rounded or squared shape. Available in earth brown, white or matte black. It can combine with any model from the Top collection.

Base central de mesa con pie de inyección de aluminio combinable con columnas redondas o cuadradas de aluminio extruido. Disponible en acabados marrón tierra, blanco o negro mate. Combinable con cualquier modelo de la colección Top.

**Aluminum finish**  
**Acabado aluminio**

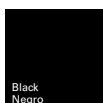
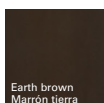

**Certificates**  
**Certificados**

Quality - Resistance  
Calidad - Resistencia

UNE CEN/TR 581-4

Durability of exterior-grade furniture.  
Durabilidad de mobiliario de exterior.

**Intellectual property Propiedad intelectual**

All our collections are protected by international industrial design registries, designs patents, copyrights and intellectual Property laws. Unauthorized use of AW International Property is a criminal offence and can lead to prosecution.

Todas nuestras colecciones están protegidas por registros de diseño industrial, diseño de patente, copyright y derechos de propiedad intelectual en todo el mundo. El uso no autorizado de los diseños y propiedad intelectual de AW supone un delito que puede ser sometido a acción judicial.



400x400

Maximum table top 700x700 / ø800.  
Minimum table top 470x470 / ø550.  
Estimated table base assembly time 3 minutes. The price of the unassembled table bases applies only to orders greater than 10 units.

Medida máxima de sobre 700x700 / ø800.  
Medida mínima de sobre 470x470 / ø550.  
Tiempo estimado de montaje por base 3 min.  
El precio de las bases desmontadas se aplicará sólo para pedidos a partir de 10 unidades.

0.13 m3  
15 kg  
x1  
1 box / bulto

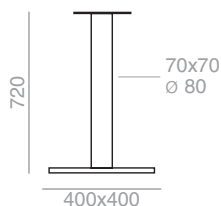

Unassembled  
Desmontada

0.04 m3  
x1

Base Base	Aluminum column Columna aluminio	Round aluminium Redondo aluminio		Square aluminium Cuadrado aluminio			
		Ref.	€	Ref.	€		
Aluminum Aluminio	Blanco/Negro mate/ Marrón tierra White/Matte black/ Earth brown	BM1069	*	290	BM1074	*	299
			**	277		**	288

\*Assembled      \*\*Unassembled  
\*Montada      \*\*Desmontada

450x450

Maximum table top 900x900 / ø1000.  
Minimum table top 470x470 / ø550.  
Estimated table base assembly time 3 minutes. The price of the unassembled table bases applies only to orders greater than 10 units.

Medida máxima de sobre 900x900 / ø1000.  
Medida mínima de sobre 470x470 / ø550.  
Tiempo estimado de montaje por base 3 min.  
El precio de las bases desmontadas se aplicará sólo para pedidos a partir de 10 unidades.

0.16 m3  
20 kg  
x1  
1 box / bulto

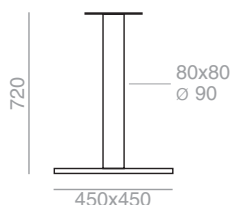

Unassembled  
Desmontada

0.04 m3  
x1

Base Base	Aluminum column Columna aluminio	Round aluminium Redondo aluminio		Square aluminium Cuadrado aluminio			
		Ref.	€	Ref.	€		
Aluminum Aluminio	Blanco/Negro mate/ Marrón tierra White/Matte black/ Earth brown	BM1085	*	307	BM1090	*	321
			**	299		**	309

\*Assembled      \*\*Unassembled  
\*Montada      \*\*Desmontada

450x450

Maximum table top 900x900 / ø1000.  
 Minimum table top 470x470 / ø550.  
 Estimated table base assembly time 3 minutes. The price of the unassembled table bases applies only to orders greater than 10 units.

Medida máxima de sobre 900x900 / ø1000.  
 Medida mínima de sobre 470x470 / ø550.  
 Tiempo estimado de montaje por base 3 min.  
 El precio de las bases desmontadas se aplicará sólo para pedidos a partir de 10 unidades.

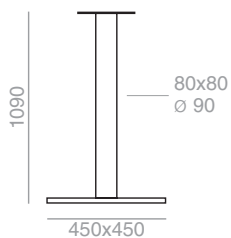

0.24 m3  
 20.5 kg  
 x1  
 1 box / bulto

Unassembled  
 Desmontada

0.06 m3  
 x1

Base Base	Aluminum column Columna aluminio	Round aluminium Redondo aluminio		Square aluminium Cuadrado aluminio	
		Ref.	€	Ref.	€
Aluminum Aluminio	Blanco/Negro mate/ Marrón tierra White/Matte black/ Earth brown	BM1112	* 397	BM1114	* 397
			** 385		** 385

\*Assembled      \*\*Unassembled  
 \*Montada      \*\*Desmontada





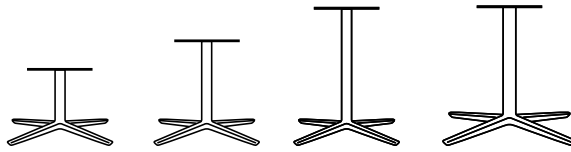

**Description**  
**Descripción**

Injected aluminum four-star base. Available in 2 sizes and 4 heights and offered in earth brown, white or matte black. Combinable with all Top Collections.  
Base de 4 aspas de inyección de aluminio. Disponible en 2 tamaños y 4 alturas diferentes. Se ofrece en acabados marrón tierra, blanco o negro mate. Combinable con cualquier modelo de la colección Top.

**Aluminum finish**  
**Acabado aluminio**

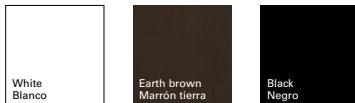

**Certificates**  
**Certificados**

Quality - Resistance  
Calidad - Resistencia

UNE CEN/TR 581-4

Durability of exterior-grade furniture.  
Durabilidad de mobiliario de exterior.

**Intellectual property Propiedad intelectual**

All our collections are protected by international industrial design registries, designs patents, copyrights and intellectual Property laws. Unauthorized use of AW International Property is a criminal offence and can lead to prosecution.

Todas nuestras colecciones están protegidas por registros de diseño industrial, diseño de patente, copyright y derechos de propiedad intelectual en todo el mundo. El uso no autorizado de los diseños y propiedad intelectual de AW supone un delito que puede ser sometido a acción judicial.



Maximum table top 800x800 / ø900. Minimum table top 520x520 / ø600. Estimated table base assembly time 3 minutes. The price of the unassembled table bases applies only to orders greater than 10 units.

Medida máxima de sobre 800x800 / ø900. Medida mínima de sobre 520x520 / ø600. Tiempo estimado de montaje por base 3 min. El precio de las bases desmontadas se aplicará sólo para pedidos a partir de 10 unidades.

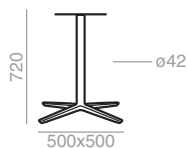

**BM4704**  
White/Matte black/Earth brown  
Blanco/Negro mate/Marrón tierra

0'27 m3  
8 kg  
x1  
1 boxes bultos

Assembled	Montada	281
Unassembled	Desmontada	265

Maximum table top 800x800 / ø900. Minimum table top 520x520 / ø600. Estimated table base assembly time 3 minutes. The price of the unassembled table bases applies only to orders greater than 10 units.

Medida máxima de sobre 800x800 / ø900. Medida mínima de sobre 520x520 / ø600. Tiempo estimado de montaje por base 3 min. El precio de las bases desmontadas se aplicará sólo para pedidos a partir de 10 unidades.



**BM4707**  
White/Matte black/Earth brown  
Blanco/Negro mate/Marrón tierra

0'18 m3  
6'5 kg  
x1  
1 boxes bultos

Assembled	Montada	260
Unassembled	Desmontada	238

Maximum table top 800x800 / ø900. Minimum table top 520x520 / ø600. Estimated table base assembly time 3 minutes. The price of the unassembled table bases applies only to orders greater than 10 units.

Medida máxima de sobre 800x800 / ø900. Medida mínima de sobre 520x520 / ø600. Tiempo estimado de montaje por base 3 min. El precio de las bases desmontadas se aplicará sólo para pedidos a partir de 10 unidades.



**BM4709**  
White/Matte black/Earth brown  
Blanco/Negro mate/Marrón tierra

0'22 m3  
7 kg  
x1  
1 boxes bultos

Assembled	Montada	275
Unassembled	Desmontada	253

Maximum table top 700x700 / ø800. Minimum table top 520x520 / ø600. Estimated table base assembly time 3 minutes. The price of the unassembled table bases applies only to orders greater than 10 units.

Medida máxima de sobre 700x700 / ø800. Medida mínima de sobre 520x520 / ø600. Tiempo estimado de montaje por base 3 min. El precio de las bases desmontadas se aplicará sólo para pedidos a partir de 10 unidades.

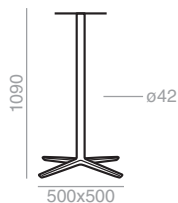

**BM4711**  
White/Matte black/Earth brown  
Blanco/Negro mate/Marrón tierra

0'35 m3  
11 kg  
x1  
1 boxes bultos

Assembled	Montada	321
Unassembled	Desmontada	298

Maximum table top 1100x1100 / ø1200.  
 Minimum table top 620x620 / ø850.  
 Estimated table base assembly time 3 minutes. The price of the unassembled table bases applies only to orders greater than 10 units.

Medida máxima de sobre 1100x1100 / ø1200.  
 Medida mínima de sobre 620x620 / ø850.  
 Tiempo estimado de montaje por base 3 min. El precio de las bases desmontadas se aplicará sólo para pedidos a partir de 10 unidades.

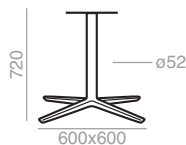

**BM4713**  
 White/Matte black/Earth brown  
 Blanco/Negro mate/Marrón tierra

0'35 m3  
 13 kg  
 x1  
 1 boxes bultos

Assembled	Montada	361
Unassembled	Desmontada	322

Maximum table top 1100x1100 / ø1200.  
 Minimum table top 620x620 / ø850.  
 Estimated table base assembly time 3 minutes. The price of the unassembled table bases applies only to orders greater than 10 units.

Medida máxima de sobre 1100x1100 / ø1200.  
 Medida mínima de sobre 620x620 / ø850.  
 Tiempo estimado de montaje por base 3 min. El precio de las bases desmontadas se aplicará sólo para pedidos a partir de 10 unidades.



**BM4715**  
 White/Matte black/Earth brown  
 Blanco/Negro mate/Marrón tierra

0'23 m3  
 8 kg  
 x1  
 1 boxes bultos

Assembled	Montada	330
Unassembled	Desmontada	295

Maximum table top 1100x1100 / ø1200.  
 Minimum table top 620x620 / ø850.  
 Estimated table base assembly time 3 minutes. The price of the unassembled table bases applies only to orders greater than 10 units.

Medida máxima de sobre 1100x1100 / ø1200.  
 Medida mínima de sobre 620x620 / ø850.  
 Tiempo estimado de montaje por base 3 min. El precio de las bases desmontadas se aplicará sólo para pedidos a partir de 10 unidades.



**BM4717**  
 White/Matte black/Earth brown  
 Blanco/Negro mate/Marrón tierra

0'29 m3  
 15'5 kg  
 x1  
 1 boxes bultos

Assembled	Montada	339
Unassembled	Desmontada	305

**Quattro Motion**

Maximum table top 800x800 / ø900.  
 Minimum table top 620x620 / ø850.  
 Estimated table base assembly time 3 minutes. The price of the unassembled table bases applies only to orders greater than 10 units.

Medida máxima de sobre 800x800 / ø900.  
 Medida mínima de sobre 620x620 / ø850.  
 Tiempo estimado de montaje por base 3 min. El precio de las bases desmontadas se aplicará sólo para pedidos a partir de 10 unidades.

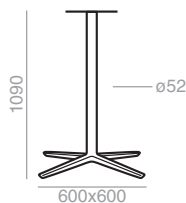

**BM4719**  
 White/Matte black/Earth brown  
 Blanco/Negro mate/Marrón tierra

0'48 m3  
 17 kg  
 x1  
 1 boxes bultos

Assembled	Montada	398
Unassembled	Desmontada	356





Reverse 38

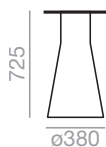

Maximum table top 900x900 / ø1000.  
Minimum table top 600x600 / ø750.  
This base is provided with a sand filled counterweight. Amount of sand: 25 kg. The price of the Promo table bases applies only to orders greater than 12 units per color. Counterweight is supplied separately in promotional offers. Suitable for matte finish

Medida máxima de sobre 900x900 / ø1000.  
Medida mínima de sobre 600x600 / ø750.  
Esta base se sirve rellena de arena. Cantidad de arena 25 kg. El precio de las bases en Promoción se aplicará solo para pedidos de más de 12 unidades del mismo color. El contrapeso es opcional. Válido para acabados mate.

BM4520

Standard  
Promo

Estandar  
Promoción

244  
211

0'12 m3  
29'9 kg  
x1  
1 boxes bultos

Reverse 38 High



Maximum table top 1100x1100 / ø1200.  
Minimum table top 600x600 / ø750.  
This base is provided with a sand filled counterweight. Amount of sand: 45 kg. The price of the Promo table bases applies only to orders greater than 6 units per color. Counterweight is supplied separately in promotional offers. Suitable for matte finish

Medida máxima de sobre 1100x1100 / ø1200.  
Medida mínima de sobre 600x600 / ø750.  
Esta base se sirve rellena de arena. Cantidad de arena 45 kg. El precio de las bases en Promoción se aplicará solo para pedidos de más de 6 unidades del mismo color. El contrapeso es opcional. Válido para acabados mate.

BM4562

Standard  
Promo

Estandar  
Promoción

343  
273

0'21 m3  
52'1 kg  
x1  
1 boxes bultos

Reverse 50

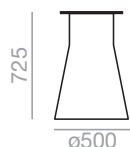

Maximum table top 1400x1400 / ø1500. Minimum table top 700x700 / ø950.

Medida máxima de sobre 1400x1400 / ø1500.  
Medida mínima de sobre 700x700 / ø950.

BM4521

349

0'2 m3  
51'9 kg  
x1  
1 boxes bultos

Reverse 50 Counter

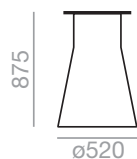

Maximum table top 1300x1300 / ø1400. Minimum table top 700x700 / ø950.

Medida máxima de sobre 1300x1300 / ø1400.  
Medida mínima de sobre 700x700 / ø950.

BM4519

290

0'7 m3  
60 kg  
x1  
1 boxes bultos

Reverse 50 High

Maximum table top 1300x1300 / ø1400. Minimum table top 700x700 / ø950.  
 Medida máxima de sobre 1300x1300 / ø1400.  
 Medida mínima de sobre 700x700 / ø950.

BM4569

338

0'3 m3  
 52'2 kg  
 x1  
 1 boxes bultos



Reverse 60

Maximum table top 1600x1600 / ø1800. Minimum table top 800x800 / ø1050.  
 Medida máxima de sobre 1600x1600 / ø1800.  
 Medida mínima de sobre 800x800 / ø1050.

BM4564

564

0'28 m3  
 77 kg  
 x1  
 1 boxes bultos

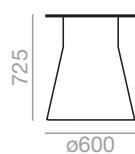

Reverse 80

Maximum table top 1900x1900 / ø2100. Minimum table top 800x800 / ø1050.  
 Medida máxima de sobre 1900x1900 / ø2100.  
 Medida mínima de sobre 800x800 / ø1050.

BM4568

705

0'68 m3  
 94'9 kg  
 x1  
 1 boxes bultos

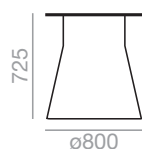

Counterweight / Contrapeso

25 kg counterweight for Reverse 38 table bases.  
 Contrapeso de 25 kg para bases Reverse 38.

CW4524

15

0'07 m3  
 25 kg  
 x1  
 boxes bultos





Counterweight / Contrapeso

50 kg counterweight for Reverse 42 table bases.  
Contrapeso de 50 kg para bases Reverse 42.

CW4566

15

 0'07 m3  
 25 kg  
 x1  
boxes bultos







**Description**  
**Descripción**

Bases in Pure Eco thermo-polymer (100% recycled) available in several colors.  
Bases de termopolimero Pure Eco (100% reciclado) disponible en diferentes colores

**Pure Eco Thermo-polymer finish**  
**Acabado de Termopolimero Pure Eco**

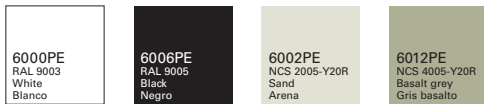

**Intellectual property Propiedad intelectual**

All our collections are protected by international industrial design registries, designs patents, copyrights and intellectual Property laws. Unauthorized use of AW International Property is a criminal offence and can lead to prosecution.  
Todas nuestras colecciones están protegidas por registros de diseño industrial, diseño de patente, copyright y derechos de propiedad intelectual en todo el mundo. El uso no autorizado de los diseños y propiedad intelectual de AW supone un delito que puede ser sometido a acción judicial.



**Solid 38**

Maximum table top 1000x1000 / ø1100. Minimum table top 600x600 / ø750.  
 Medida máxima de sobre 1000x1000 / ø1100.  
 Medida mínima de sobre 600x600 / ø750.

**BM03651**

186

0'14 m3  
 28 kg  
 x1  
 1 boxes bultos



**Solid 50**

Maximum table top 1400x1400 / ø1500. Minimum table top 700x700 / ø950.  
 Medida máxima de sobre 1400x1400 / ø1500.  
 Medida mínima de sobre 700x700 / ø950.

**BM03652**

227

0'2 m3  
 50 kg  
 x1  
 1 boxes bultos

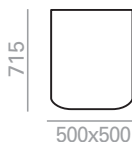



**Andreu World**

**Table tops**

**Sobres de mesa**



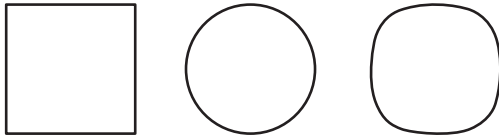

**Description**  
**Descripción**

12 mm thick Compacto high pressure laminate (HPL) table top. Suitable for outdoor and high traffic areas. Able to be combined with all central column base collections.

Tablero Compacto laminado de alta presión (HPL) de 12mm. Valido para exterior y áreas de uso intenso. Valido para cualquier base de columna central.

**Compacto HPL finish**  
**Acabado Compacto HPL**



**Certificates**  
**Certificados**

EN 438-2-4, EN 438-2-5, EN 438-2-6, EN 438-2-7, EN 438-2-8,  
EN 438-2-9, EN 438-2-10, EN 438-2-12, EN 438-2-14, EN 438-2-16,  
EN 12721, EN 438-2-17, EN 438-2-21, EN 438-2-24, EN 438-2-25,  
EN 438-2-26, EN 438-2-27, EN 438-2-30, EN ISO 1183-1,  
ISO 178: 2003, ISO R527: 1996.

**Intellectual property Propiedad intelectual**

All our collections are protected by international industrial design registries, designs patents, copyrights and intellectual Property laws. Unauthorized use of AW International Property is a criminal offence and can lead to prosecution.



Todas nuestras colecciones están protegidas por registros de diseño industrial, diseño de patente, copyright y derechos de propiedad intelectual en todo el mundo. El uso no autorizado de los diseños y propiedad intelectual de AW supone un delito que puede ser sometido a acción judicial.









12 mm thick Compacto high pressure laminate top (HPL)  
 Tablero Compacto laminado de alta presión (HPL) de 12mm.

Edge / Perfil



	 1 m3  kg		Compacto HPL	
	600x600	0'05	7	<b>SB4591</b>
700x700	0'06	9	<b>SB4592</b>	201
800x800	0'08	11	<b>SB4593</b>	227
900x900	0'1	13	<b>SB4594</b>	266
1000x1000	0'12	16	<b>SB4595</b>	322
1100x1100	0'14	19	<b>SB4596</b>	425
1200x1200	0'17	22	<b>SB4597</b>	427
1300x1300	0'2	26	<b>SB4598</b>	432
1400x1400	0'22	30	<b>SB4599</b>	574

	 1 m3  kg		Compacto HPL	
	ø600	0'05	7	<b>SB4580</b>
ø700	0'06	8	<b>SB4581</b>	201
ø800	0'08	10	<b>SB4582</b>	227
ø900	0'1	12	<b>SB4583</b>	266
ø1000	0'12	14	<b>SB4584</b>	322
ø1100	0'14	16	<b>SB4585</b>	425
ø1200	0'17	18	<b>SB4586</b>	427
ø1300	0'2	21	<b>SB4587</b>	432
ø1400	0'22	24	<b>SB4588</b>	574

	 1 m3  kg		Compacto HPL	
	600x600	0'05	8	<b>SB4570</b>
700x700	0'06	10	<b>SB4571</b>	207
800x800	0'08	12	<b>SB4572</b>	235
900x900	0'1	14	<b>SB4573</b>	274
1000x1000	0'12	17	<b>SB4574</b>	324
1100x1100	0'14	19	<b>SB4575</b>	428
1200x1200	0'17	22	<b>SB4576</b>	428
1300x1300	0'2	26	<b>SB4577</b>	433
1400x1400	0'22	29	<b>SB4578</b>	579

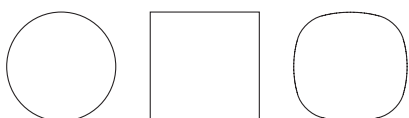

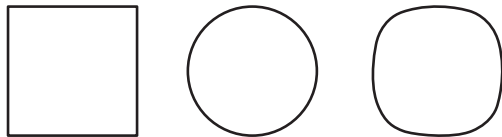

**Description**  
**Descripción**

10mm thick Low Iron Glass available in various colors. Able to be combined with all the central column table Descripción base collections. Suitable for outdoor use. The total thickness of table top is 10 mm. glass + 12 mm. Compacto HPL table top.  
Cristal óptico de 10 mm. de espesor, disponible en varios colores. Válido para cualquier colección de columna central y su uso en exterior. El espesor total del sobre es de 22 mm. (10 mm. de cristal + 12 mm. de soporte de tablero Compacto.)

**Glass finish**  
**Acabado de cristal**



**Certificates**  
**Certificados**

DIN ISO 1183, DIN EN ISO 178, EN ISO 604, DIN ISO 4586 T11,  
DIN ISO 4586 T12, DIN EN 101, DIN ISO 4586 T6, DIN ISO 4586 T7,  
DIN EN ISO 846, DIN 51130:1992-11, DIN ISO 4586 T10,  
DIN ISO 4586 T8, DIN ISO 4586 T16, DIN IEC 61 340-4-1.

**Intellectual property Propiedad intelectual**





All our collections are protected by international industrial design registries, designs patents, copyrights and intellectual Property laws. Unauthorized use of AW International Property is a criminal offence and can lead to prosecution.  
Todas nuestras colecciones están protegidas por registros de diseño industrial, diseño de patente, copyright y derechos de propiedad intelectual en todo el mundo. El uso no autorizado de los diseños y propiedad intelectual de AW supone un delito que puede ser sometido a acción judicial.











10 mm thick glass table top.  
Sobre de mesa cristal de 10 mm de espesor.

Edge / Perfil



	 1  m3  kg	Low Iron Glass Cristal Óptico		
600x600	0'07	13	<b>SB4766</b>	416
700x700	0'09	17	<b>SB4767</b>	450
800x800	0'11	20	<b>SB4768</b>	520
900x900	0'14	24	<b>SB4769</b>	552
1000x1000	0'17	29	<b>SB4770</b>	647
1100x1100	0'2	34	<b>SB4771</b>	736
1200x1200	0'24	40	<b>SB4772</b>	816
1300x1300	0'27	46	<b>SB4773</b>	917
1400x1400	4'91	52	<b>SB4774</b>	1.028
1500x1500	5'83	59	<b>SB4775</b>	1.072

	 1  m3  kg	Low Iron Glass Cristal Óptico		
ø700	0'09	14	<b>SB4777</b>	475
ø800	0'11	17	<b>SB4778</b>	550
ø900	0'14	20	<b>SB4779</b>	593
ø1000	0'17	24	<b>SB4780</b>	704
ø1100	0'2	28	<b>SB4781</b>	839
ø1200	0'24	32	<b>SB4782</b>	868
ø1300	0'27	37	<b>SB4783</b>	992
ø1400	4'91	42	<b>SB4784</b>	1.089
ø1500	5'83	48	<b>SB4785</b>	1.332
600x600	0'07	12	<b>SB4786</b>	529

	 1  m3  kg	Low Iron Glass Cristal Óptico		
700x700	0'09	15	<b>SB4787</b>	564
800x800	0'11	18	<b>SB4788</b>	629
900x900	0'14	22	<b>SB4789</b>	656
1000x1000	0'17	26	<b>SB4790</b>	736
1100x1100	0'2	30	<b>SB4791</b>	779
1200x1200	0'24	35	<b>SB4792</b>	876
1300x1300	0'27	40	<b>SB4793</b>	1.044
1400x1400	4'91	46	<b>SB4794</b>	1.131
1500x1500	5'83	52	<b>SB4795</b>	1.235

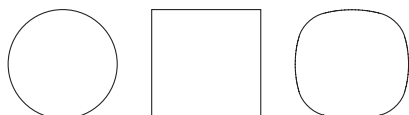



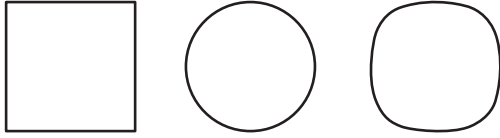

**Description**

12mm thick Solid Surface table top. Available in Glacier White color. Able to be combined with all column base collections. Suitable for outdoor use.

**Descripción**

Sobre de Solid Surface de 12 mm. de espesor. Disponible en color Glacier White. Válido para cualquier colección de columnas. Válido para uso en exterior.

**Solid Surface finish**

**Acabado Solid Surface**



**Certificates**

**Certificados**

DIN ISO 1183, DIN EN ISO 178, EN ISO 604, DIN ISO 4586 T11,  
DIN ISO 4586 T12, DIN EN 101, DIN ISO 4586 T6, DIN ISO 4586 T7,  
DIN EN ISO 846, DIN 51130:1992-11, DIN ISO 4586 T10,  
DIN ISO 4586 T8, DIN ISO 4586 T16, DIN IEC 61 340-4-1.

**Intellectual property Propiedad intelectual**



All our collections are protected by international industrial design registries, designs patents, copyrights and intellectual Property laws. Unauthorized use of AW International Property is a criminal offence and can lead to prosecution.  
Todas nuestras colecciones están protegidas por registros de diseño industrial, diseño de patente, copyright y derechos de propiedad intelectual en todo el mundo. El uso no autorizado de los diseños y propiedad intelectual de AW supone un delito que puede ser sometido a acción judicial.







12 mm thick Solid Surface table top.  
 Sobre de Solid Surface de 12 mm. de espesor.

Edge / Perfil



				
600x600	0'05	9	<b>SB3592</b>	394
700x700	0'06	12	<b>SB3593</b>	452
800x800	0'08	15	<b>SB3594</b>	576
900x900	0'1	19	<b>SB3595</b>	581

				
ø600	0'05	8	<b>SB3596</b>	394
ø700	0'06	10	<b>SB3597</b>	452
ø800	0'08	12	<b>SB3598</b>	570
ø900	0'1	15	<b>SB3599</b>	574

				
600x600	0'05	8	<b>SB3614</b>	394
700x700	0'06	11	<b>SB3615</b>	452
800x800	0'08	13	<b>SB3616</b>	570
900x900	0'1	16	<b>SB3617</b>	574

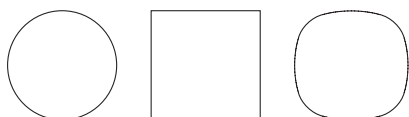

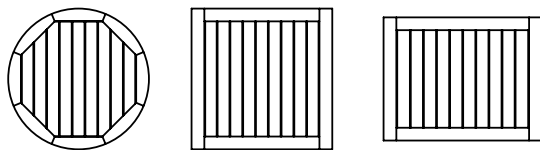

**Description**

Solid iroko wood top of 20 mm thickness. Valid for any central base. Suitable for outdoor use.

**Descripción**

Sobre de madera maciza de iroko de espesor 20 mm. Válido para cualquier base central. Apto para uso en exterior.

**Wood finish Iroko**

**Acabado madera Iroko**

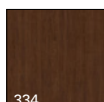

**Intellectual property Propiedad intelectual**

All our collections are protected by international industrial design registries, designs patents, copyrights and intellectual Property laws. Unauthorized use of AW International Property is a criminal offence and can lead to prosecution.





Todas nuestras colecciones están protegidas por registros de diseño industrial, diseño de patente, copyright y derechos de propiedad intelectual en todo el mundo. El uso no autorizado de los diseños y propiedad intelectual de AW supone un delito que puede ser sometido a acción judicial.











20 mm thick teak table top.  
Sobre de mesa de teca de 20 mm de espesor.

Edge / Perfil



	 0	 m3	 kg		
800x800	0'08	11	<b>SB3600</b>	405	
900x900	0'1	11	<b>SB3601</b>	419	
1000x1000	0'12	13	<b>SB3602</b>	443	

	 0	 m3	 kg		
ø800	0'08	8	<b>SB3603</b>	410	
ø900	0'1	12	<b>SB3604</b>	429	
ø1000	0'12	12	<b>SB3605</b>	461	

	 0	 m3	 kg		
900x700	0'1	11	<b>SB3606</b>	381	

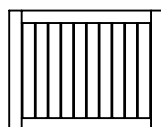
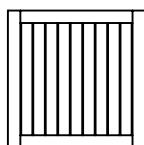
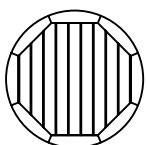

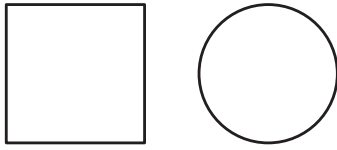

**Description**

8 mm. layer Technical Stone square and round table tops. Square top has protective black edge cover. Also available for outdoor use. The total thickness of table top is 8 mm. (3 mm. Technical Stone table top + 5 mm. glass table top).

**Descripción**

Tablero de mesa Technical Stone de 8 mm. en sobres redondos, con canto protector de color negro en sobres cuadrados. Válido para su uso en exterior. El espesor total del sobre es de 8 mm. (3 mm. de tablero Technical Stone + 5 mm. de sobre de cristal).

**Technical Stone decorative finish**

**Acabado Technical Stone**



**Certificates**

European Standard:  
UNE EN 13501-1:2

International Standards  
UNE EN ISO 10545-3, UNE EN ISO 10545-4, UNE EN ISO 10545-6,  
UNE ENV 12633, UNE EN ISO 10545-12, UNE EN ISO 10545-9.

**Certificados**

**Intellectual property Propiedad intelectual**

All our collections are protected by international industrial design registries, designs patents, copyrights and intellectual Property laws. Unauthorized use of AW International Property is a criminal offence and can lead to prosecution.

Todas nuestras colecciones están protegidas por registros de diseño industrial, diseño de patente, copyright y derechos de propiedad intelectual en todo el mundo. El uso no autorizado de los diseños y propiedad intelectual de AW supone un delito que puede ser sometido a acción judicial.











8mm layer Technical Stone table top.

Tablero de mesa Technical Stone de 8mm.

Edge / Perfil



	 1	 m3	 kg		
600x600	0'06	8	<b>SB4535</b>	522	
700x700	0'08	11	<b>SB4536</b>	602	
800x800	0'1	13	<b>SB4537</b>	702	
900x900	0'12	15	<b>SB4538</b>	763	
1000x1000	0'14	17	<b>SB4539</b>	829	

	 1	 m3	 kg		
ø600	0'06	8	<b>SB4540</b>	581	
ø700	0'08	9	<b>SB4541</b>	668	
ø800	0'1	10	<b>SB4542</b>	758	
ø900	0'12	11	<b>SB4543</b>	836	
ø1000	0'14	13	<b>SB4544</b>	912	



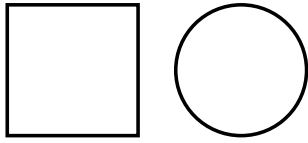

**Description**  
**Descripción**

20 mm. marble table tops available in 2 different shapes and sizes in sand and light gray finish.  
Sobres de mármol de 20 mm. disponible en 2 formas y medidas diferentes en acabado arena y gris claro.

**Terrazzo finish**  
**Acabado terrazzo**



**Intellectual property Propiedad intelectual**





All our collections are protected by international industrial design registries, designs patents, copyrights and intellectual Property laws. Unauthorized use of AW International Property is a criminal offence and can lead to prosecution.  
Todas nuestras colecciones están protegidas por registros de diseño industrial, diseño de patente, copyright y derechos de propiedad intelectual en todo el mundo. El uso no autorizado de los diseños y propiedad intelectual de AW supone un delito que puede ser sometido a acción judicial.







20 mm thick marble table top.  
Sobre de mármol de 20 mm de  
espesor.

Edge / Perfil



	 1	 m3	 kg		
600x600	0'06	11'8	<b>SB7300</b>	619	
700x700	0'08	15'8	<b>SB7301</b>	710	
800x800	0'1	20'5	<b>SB7302</b>	810	
900x900	0'12	25'7	<b>SB7303</b>	998	
1000x1000	0'14	31'6	<b>SB7304</b>	1.115	

	 1	 m3	 kg		
ø600	0'06	11'8	<b>SB7305</b>	697	
ø700	0'08	15'8	<b>SB7306</b>	800	
ø800	0'1	20'5	<b>SB7307</b>	913	
ø900	0'12	25'7	<b>SB7308</b>	1.115	
ø1000	0'14	31'6	<b>SB7309</b>	1.244	







**Andreu World**

**Occasional tables**

**Mesas ocasionales**





**Description**  
**Descripción**

Injected aluminum table base with an oval column and rounded base plate. Available in 2 heights and offered in earth brown, white or matte black and with Compacto high pressure laminate top (HPL) or Technical Stone.

Mesa con base circular y columna ovalada de inyección de aluminio. Disponible en 2 alturas. Se ofrece en acabados marrón tierra, blanco o negro mate y sobres de Compacto laminado de alta presión (HPL) o Technical Stone.

**Aluminum finish**  
**Acabado aluminio**

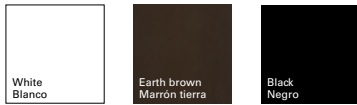

**Technical Stone decorative finish**  
**Acabado Technical Stone**

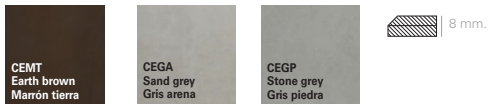

**Compacto HPL finish**  
**Acabado Compacto HPL**



**Certificates**  
**Certificados**

Quality - Resistance  
Calidad - Resistencia

UNE CEN/TR 581-4

Durability of exterior-grade furniture.  
Durabilidad de mobiliario de exterior.

**Intellectual property Propiedad intelectual**

All our collections are protected by international industrial design registries, designs patents, copyrights and intellectual Property laws. Unauthorized use of AW International Property is a criminal offence and can lead to prosecution.

Todas nuestras colecciones están protegidas por registros de diseño industrial, diseño de patente, copyright y derechos de propiedad intelectual en todo el mundo. El uso no autorizado de los diseños y propiedad intelectual de AW supone un delito que puede ser sometido a acción judicial.



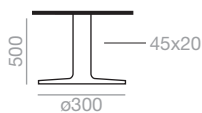
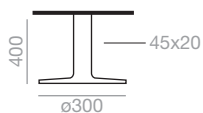

Column height / Altura columna 400					
	Aluminium finish Acabado de Aluminio	Table top / Sobre			
		Compacto HPL		Technical Stone	
		Ref.	€	Ref.	€
400x400	White/Black/Earth brown Blanco/Negro/Marrón tierra	ME6425	309	ME6487	347
ellipse/ elipse 450x450	White/Black/Earth brown Blanco/Negro/Marrón tierra	ME6430	318	ME6492	551
ø450	White/Black/Earth brown Blanco/Negro/Marrón tierra	ME6435	318	ME6497	551
kg		6'6		6'6	
1 box / bulto m3		0'09		0'09	

Column height / Altura columna 500					
	Aluminium finish Acabado de Aluminio	Table top / Sobre			
		Compacto HPL		Technical Stone	
		Ref.	€	Ref.	€
400x400	White/Black/Earth brown Blanco/Negro/Marrón tierra	ME6440	321	ME6502	350
ellipse/ elipse 450x450	White/Black/Earth brown Blanco/Negro/Marrón tierra	ME6445	321	ME6507	553
ø450	White/Black/Earth brown Blanco/Negro/Marrón tierra	ME6450	321	ME6512	553
kg		6'9		6'9	
1 box / bulto m3		0'1		0'1	



**Description**  
**Descripción**

Injected aluminum four-star base. Available in 2 heights and offered in earth brown, white or matte black and Compacto high pressure laminate top (HPL) or Technical Stone top.

Mesa con base de 4 aspas y columna de inyección de aluminio. Disponible en 2 alturas. Se ofrece en acabados marrón tierra, blanco o negro mate y sobres de Compacto laminado de alta presión (HPL) o Technical Stone.

**Aluminum finish**  
**Acabado aluminio**

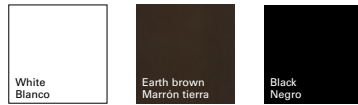

**Compacto HPL finish**  
**Acabado Compacto HPL**

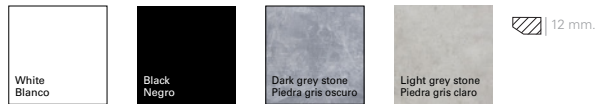

**Technical Stone decorative finish**  
**Acabado Technical Stone**

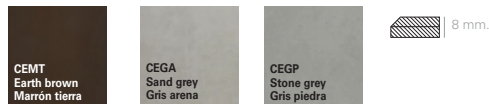

**Certificates**  
**Certificados**

Quality - Resistance Calidad - Resistencia	UNE CEN/TR 581-4	Durability of exterior-grade furniture. Durabilidad de mobiliario de exterior.
---	------------------	---

**Intellectual property Propiedad intelectual**

All our collections are protected by international industrial design registries, designs patents, copyrights and intellectual Property laws. Unauthorized use of AW International Property is a criminal offence and can lead to prosecution.  
Todas nuestras colecciones están protegidas por registros de diseño industrial, diseño de patente, copyright y derechos de propiedad intelectual en todo el mundo. El uso no autorizado de los diseños y propiedad intelectual de AW supone un delito que puede ser sometido a acción judicial.





Column height / Altura columna 400					
	Aluminium finish Acabado de Aluminio	Table top / Sobre			
		Compacto HPL		Technical Stone	
		Ref.	€	Ref.	€
450x450	White/Black/Earth brown Blanco/Negro/Marrón tierra	ME6775	322	ME6886	356
ellipse/ elipse 500x500	White/Black/Earth brown Blanco/Negro/Marrón tierra	ME6780	349	ME6891	561
ø500	White/Black/Earth brown Blanco/Negro/Marrón tierra	ME6785	349	ME6896	561
kg		7'15		7'15	
1 box / bulto m3		0'11		0'11	

Column height / Altura columna 500					
	Aluminium finish Acabado de Aluminio	Table top / Sobre			
		Compacto HPL		Technical Stone	
		Ref.	€	Ref.	€
450x450	White/Black/Earth brown Blanco/Negro/Marrón tierra	ME6790	324	ME6901	358
ellipse/ elipse 500x500	White/Black/Earth brown Blanco/Negro/Marrón tierra	ME6795	353	ME6906	563
ø500	White/Black/Earth brown Blanco/Negro/Marrón tierra	ME6800	353	ME6911	563
kg		7'45		7'45	
1 box / bulto m3		0'13		0'13	

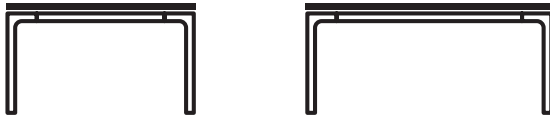

**Description**  
**Descripción**

Table collection with four injected aluminum legs with EPL-5 outdoor treatment, available in earth brown, white or matte black finish and with Compacto high pressure laminate top (HPL) or Technical Stone.

Colección de mesas con base de 4 patas de inyección de aluminio con tratamiento EPL-5 en acabado marrón tierra, blanco o negro mate y sobres de Compacto laminado de alta presión (HPL) o Technical Stone.

**Aluminum finish**  
**Acabado aluminio**

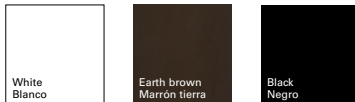

**Compacto HPL finish**  
**Acabado Compacto HPL**

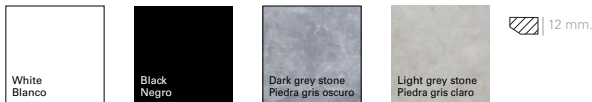

**Technical Stone decorative finish**  
**Acabado Technical Stone**

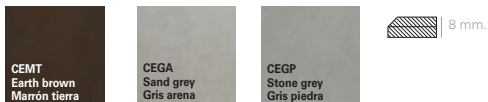

**Certificates**  
**Certificados**

Quality - Resistance  
Calidad - Resistencia

UNE CEN/TR 581-4

Durability of exterior-grade furniture.  
Durabilidad de mobiliario de exterior.

**Intellectual property Propiedad intelectual**

All our collections are protected by international industrial design registries, designs patents, copyrights and intellectual Property laws. Unauthorized use of AW International Property is a criminal offence and can lead to prosecution.

Todas nuestras colecciones están protegidas por registros de diseño industrial, diseño de patente, copyright y derechos de propiedad intelectual en todo el mundo. El uso no autorizado de los diseños y propiedad intelectual de AW supone un delito que puede ser sometido a acción judicial.



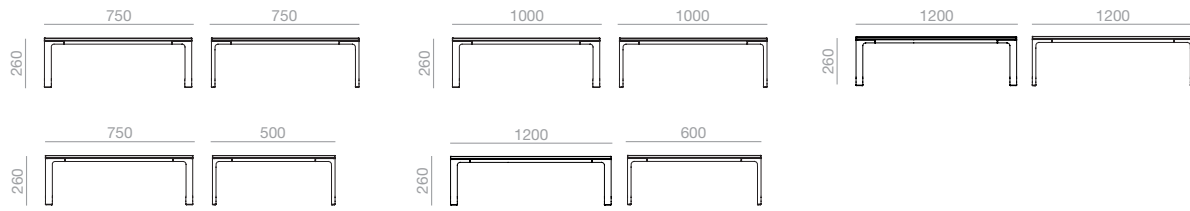

Column height / Altura columna 260					
	Aluminium finish Acabado de Aluminio	Table top / Sobre			
		Compacto HPL Compacto HPL		Technical Stone	
		Ref.	€	Ref.	€
<b>750x750</b>	White/Black/Earth brown Blanco/Negro/Marrón tierra	<b>ME8667</b>	812	<b>ME8763</b>	942
<b>1200x1200</b>	White/Black/Earth brown Blanco/Negro/Marrón tierra	<b>ME8672</b>	1.119		
<b>750x500</b>	White/Black/Earth brown Blanco/Negro/Marrón tierra	<b>ME8677</b>	731	<b>ME8768</b>	844
<b>1200x600</b>	White/Black/Earth brown Blanco/Negro/Marrón tierra	<b>ME8682</b>	845	<b>ME8773</b>	1.160
📦 kg		23'2		23'2	
1 box / bulto 📦 m3		0'16		0'16	

Column height / Altura columna 370					
	Aluminium finish Acabado de Aluminio	Table top / Sobre			
		Compacto HPL Compacto HPL		Technical Stone	
		Ref.	€	Ref.	€
<b>600x600</b>	White/Black/Earth brown Blanco/Negro/Marrón tierra	<b>ME8687</b>	697	<b>ME8798</b>	872
<b>1200x1200</b>	White/Black/Earth brown Blanco/Negro/Marrón tierra	<b>ME8692</b>	1.139		
<b>1200x600</b>	White/Black/Earth brown Blanco/Negro/Marrón tierra	<b>ME8697</b>	864	<b>ME8803</b>	1.182
<b>1400x700</b>	White/Black/Earth brown Blanco/Negro/Marrón tierra	<b>ME8702</b>	986	<b>ME8808</b>	1.329
📦 kg		18'7		18'7	
1 box / bulto 📦 m3		0'15		0'15	



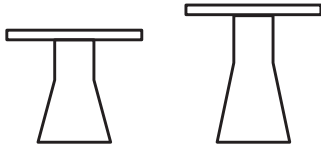

**Description**  
**Descripción**

Occasional table with Pure Eco thermo-polymer (100% recycled) available in several colors. Table tops in several shapes and sizes available in various finishes.

Mesa auxiliar con base central de termopolimero Pure Eco (100% reciclado) disponible en diferentes colores. Sobres de tablero de diferentes formas y medidas disponible en diferentes acabados.

**Pure Eco Thermo-polymer finish**  
**Acabado de Termopolimero Pure Eco**



**Compacto HPL finish**  
**Acabado Compacto HPL**



**Technical Stone decorative finish**  
**Acabado Technical Stone**

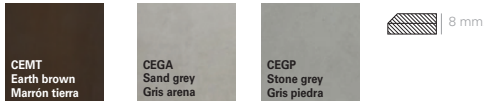

**Certificates**  
**Certificados**

Quality - Resistance  
Calidad - Resistencia

UNE CEN/TR 581-4

Durability of exterior-grade furniture.  
Durabilidad de mobiliario de exterior.

**Intellectual property Propiedad intelectual**

All our collections are protected by international industrial design registries, designs patents, copyrights and intellectual Property laws. Unauthorized use of AW International Property is a criminal offence and can lead to prosecution.

Todas nuestras colecciones están protegidas por registros de diseño industrial, diseño de patente, copyright y derechos de propiedad intelectual en todo el mundo. El uso no autorizado de los diseños y propiedad intelectual de AW supone un delito que puede ser sometido a acción judicial.



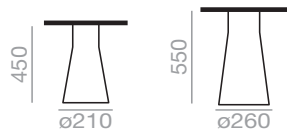

Column height / Altura columna 450				
	Table top / Sobre			
	Compacto HPL		Technical Stone	
	Ref.	€	Ref.	€
400x400	ME5104	292	ME5137	362
ellipse/ elipse 450x450	ME5109	297	ME5138	515
ø450	ME5114	299	ME5139	515
kg	17		16	
1 box / bulto  m3	0'1		0'1	

Column height / Altura columna 550				
	Table top / Sobre			
	Compacto HPL		Technical Stone	
	Ref.	€	Ref.	€
500x500	ME5119	324	ME5140	375
ellipse/ elipse 550x550	ME5124	335	ME5141	542
ø500	ME5129	339	ME5142	542
kg	18		25	
1 box / bulto  m3	0'17		0'17	

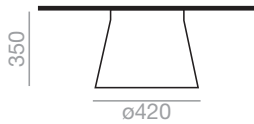

Column height / Altura columna 350				
	Table top / Sobre			
	Compacto HPL		Technical Stone	
	Ref.	€	Ref.	€
800x800	ME5314	470	ME5315	895
900x900	ME5335	510	ME5336	920
1000x1000	ME5353	567	ME5354	966
1100x1100	ME5369	684		
kg	47		46	
1 box / bulto  m3	0'15		0'17	

Column height / Altura columna 350				
ellipse elipse	Table top / Sobre			
	Compacto HPL		Technical Stone	
	Ref.	€	Ref.	€
ellipse/ elipse 900x900	ME5321	504	ME5322	994
ellipse/ elipse 1000x1000	ME5341	565	ME5342	1.026
ellipse/ elipse 1100x1100	ME5359	679		
ellipse/ elipse 1200x1200	ME5373	684		
kg	50		49	
1 box / bulto  m3	0'17		0'19	

Column height / Altura columna 350				
	Table top / Sobre			
	Compacto HPL		Technical Stone	
	Ref.	€	Ref.	€
ø900	ME5328	504	ME5329	1.008
ø1000	ME5347	565	ME5348	1.026
ø1100	ME5364	679		
ø1200	ME5377	686		
kg	50		49	
2 boxes / bultos  m3	0'17		0'44	



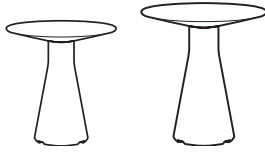

**Description**  
**Descripción**

Occasional tables with central base and top in Pure Eco thermo-polymer (100% recycled) available in several colors. Available in 2 different sizes and heights.  
Mesas ocasionales con base central y sobre de termopolimero Pure Eco (100% reciclado) disponible en diferentes colores. Disponible en 2 medidas y alturas diferentes.

**Pure Eco Thermo-polymer finish**  
**Acabado de Termopolimero Pure Eco**



**Certificates**  
**Certificados**

Quality - Resistance  
Calidad - Resistencia

UNE EN 15372

**Intellectual property Propiedad intelectual**

All our collections are protected by international industrial design registries, designs patents, copyrights and intellectual Property laws. Unauthorized use of AW International Property is a criminal offence and can lead to prosecution.  
Todas nuestras colecciones están protegidas por registros de diseño industrial, diseño de patente, copyright y derechos de propiedad intelectual en todo el mundo. El uso no autorizado de los diseños y propiedad intelectual de AW supone un delito que puede ser sometido a acción judicial.



Auxiliary table.  
Mesa auxiliar.

**ME5890**

219



 0'14 m3  
 14 kg  
 x1  
1 boxes bultos



Auxiliary table.  
Mesa auxiliar.

**ME5891**

246

 0'23 m3  
 24 kg  
 x1  
1 boxes bultos



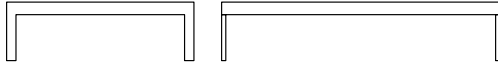

**Description**  
**Descripción**

Coffee table with steel frame with EPL5 outdoor treatment available in several colors. Solid iroko wood frame or Technical Stone top in earth brown, sand grey and stone grey.

Mesa de centro con estructura de acero y tratamiento EPL5 para exterior disponible en diferentes colores. Sobre de madera maciza de iroko o Technical Stone en marrón tierra, gris arena y gris piedra.

**Steel finish**

**Acabado de acero**

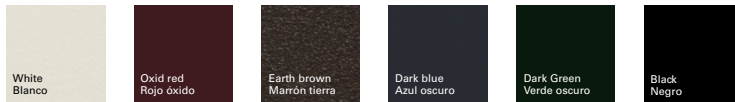

**Technical Stone decorative finish**

**Acabado Technical Stone**



**Wood finish Iroko**

**Acabado madera Iroko**

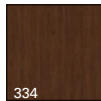

**Certificates**

**Certificados**

Quality - Resistance  
Calidad - Resistencia

UNE CEN/TR 581-4

Durability of exterior-grade furniture.  
Durabilidad de mobiliario de exterior.

**Intellectual property Propiedad intelectual**

All our collections are protected by international industrial design registries, designs patents, copyrights and intellectual Property laws. Unauthorized use of AW International Property is a criminal offence and can lead to prosecution.

Todas nuestras colecciones están protegidas por registros de diseño industrial, diseño de patente, copyright y derechos de propiedad intelectual en todo el mundo. El uso no autorizado de los diseños y propiedad intelectual de AW supone un delito que puede ser sometido a acción judicial.



Auxiliary table. Technical Stone table top.  
Mesa auxiliar. Sobre de Technical Stone.

**ME4315**

819

0'18 m3  
15 kg  
x1  
1 boxes bultos

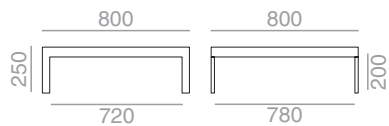

Auxiliary table. Technical Stone table top.  
Mesa auxiliar. Sobre de Technical Stone.

**ME4313**

1.076

0'29 m3  
24 kg  
x1  
1 boxes bultos

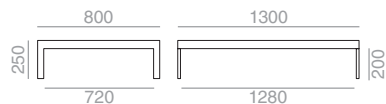

Auxiliary table. Iroko table top.  
Mesa auxiliar. Sobre de iroko.

**ME4318**

1.723

0'34 m3  
15 kg  
x1  
0 boxes bultos

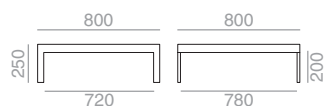

Auxiliary table. Iroko table top.  
Mesa auxiliar. Sobre de iroko.

**ME4319**

2.535

0'53 m3  
24 kg  
x1  
0 boxes bultos

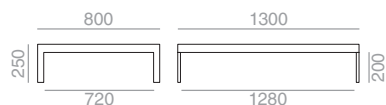





**Description**  
**Descripción**

Coffee table with EPL-5 treated steel frame available in several colors. Able to be combined with the modular Siesta sofa collection.  
Mesa de centro con estructura de acero con tratamiento EPL-5 disponible en diferentes colores. Combinable con la colección de sofá modular Siesta.

**Steel finish**  
**Acabado de acero**

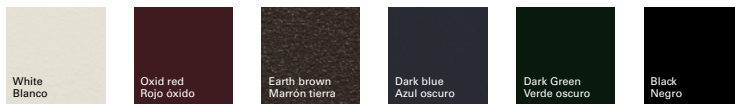

**Certificates**  
**Certificados**

Quality - Resistance  
Calidad - Resistencia

UNE CEN/TR 581-4

Durability of exterior-grade furniture.  
Durabilidad de mobiliario de exterior.

**Intellectual property Propiedad intelectual**

All our collections are protected by international industrial design registries, designs patents, copyrights and intellectual Property laws. Unauthorized use of AW International Property is a criminal offence and can lead to prosecution.  
Todas nuestras colecciones están protegidas por registros de diseño industrial, diseño de patente, copyright y derechos de propiedad intelectual en todo el mundo. El uso no autorizado de los diseños y propiedad intelectual de AW supone un delito que puede ser sometido a acción judicial.



Auxiliary table.  
Mesa auxiliar.

**ME4753**

354

0'19 m<sup>3</sup>

11 kg

x1

1 boxes bultos





Tables

Mesas





**Description** Table available with different types of legs and table tops. Bases of 4 aluminum legs, with square or delta shape, available in anodized brown or solid wood iroko. Valid for outdoor use.  
**Descripción**

Mesa disponible con diferentes tipos de patas y sobres de mesa. Bases de 4 patas de aluminio, con forma cuadrada o delta, disponibles en acabado anodizado marrón o madera maciza de iroko. Válido para su uso en exterior.

**Aluminum finish**  
**Acabado aluminio**

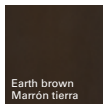

**Compacto HPL finish**  
**Acabado Compacto HPL**

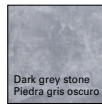
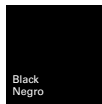

**Technical Stone decorative finish**  
**Acabado Technical Stone**

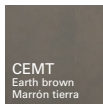

**Wood finish Iroko**  
**Acabado madera Iroko**

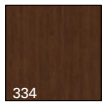

**Certificates** Quality - Resistance UNE CEN/TR 581-4 Durability of exterior-grade furniture.  
**Certificados** Calidad - Resistencia Durabilidad de mobiliario de exterior.

**Intellectual property Propiedad intelectual**

All our collections are protected by international industrial design registries, designs patents, copyrights and intellectual Property laws. Unauthorized use of AW International Property is a criminal offence and can lead to prosecution.  
Todas nuestras colecciones están protegidas por registros de diseño industrial, diseño de patente, copyright y derechos de propiedad intelectual en todo el mundo. El uso no autorizado de los diseños y propiedad intelectual de AW supone un delito que puede ser sometido a acción judicial.



1500 x 1000

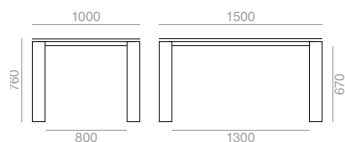

Legs Patas	Table top / Sobre					
	Technical Stone		Compacto HPL Compacto HPL		Iroko	
	Ref.	€	Ref.	€	Ref.	€
Aluminum/ Aluminio	ME5894	2.001	ME5451	1.887	ME5832	4.058
Delta Aluminum / Aluminio Delta	ME5885	1.878	ME5452	1.763	ME5833	3.954
Iroko/ Iroko					ME5834	6.218
kg	45		45		30'7	
0 box / bulto m3	0'43		0'43		0'52	

**FU4815** Protective cover Funda protectora | 126 |

2000 x 1000

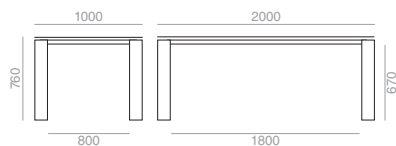

Legs Patas	Table top / Sobre					
	Technical Stone		Compacto HPL Compacto HPL		Iroko	
	Ref.	€	Ref.	€	Ref.	€
Aluminum/ Aluminio	ME5895	2.493	ME5454	2.035	ME5835	5.124
Delta Aluminum / Aluminio Delta	ME5887	2.388	ME5455	1.940	ME5836	4.961
Iroko/ Iroko					ME5837	7.906
kg	49'5		49'5		39'2	
0 box / bulto m3	0'56		0'56		0'48	

**FU4816** Protective cover Funda protectora | 133 |

2500 x 1000

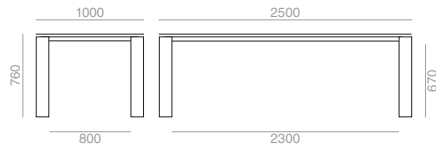

Legs Patas	Table top / Sobre					
	Technical Stone		Compacto HPL Compacto HPL		Iroko	
	Ref.	€	Ref.	€	Ref.	€
Aluminum/ Aluminio	ME5896	2.652	ME5457	2.390	ME5838	6.645
Delta Aluminum / Aluminio Delta	ME5889	2.545	ME5458	2.282	ME5839	5.688
Iroko/ Iroko					ME5840	9.030
kg	56		56		45'7	
box / bulto m3	0'7		0'7		0'58	

<b>FU4817</b>	Protective cover Funda protectora	152
---------------	--------------------------------------	-----

## SALES CONDITIONS/REMARKS

1- This price-list is valid from the 01/01/2024

2- HOW TO ORDER. Please specify:

- a) Model name and reference No. (ie. Sand SF-4300).
- b) Wood color name and reference No. (ie. White).
- c) Fabric category and reference No. (ie. Natte 10022).
- d) Quantity.

3- DELIVERY TIME

Is 4-5 weeks after order confirmation. Loading date for orders with customer's special finishes or C.O.M. (Customer's Own Material) cannot be confirmed until confirmation of our counter-sample or C.O.M. reach Andreu World.

4- Goods remain our property until fully paid.

5- Delivery terms indicated in our order confirmation are to be considered as indicative and are not binding for the manufacturer

6- WITHOUT FABRIC

Articles will be supplied in a protective White fabric (muslin) for upholstery by the customer. This option is not recommended for certain models due to difficulties in the upholstery process for them.

Warning (Without fabric): Please mark on your purchase order if the articles should be without fabric should be provided.

7- UPHOLSTERED WITH CUSTOMER'S OWN MATERIAL (C.O.M.)

This can be supplied at the price indicated in the Customer's Own Material category, but materials must arrive at the factory freight paid at least 3 weeks before the order delivery date. If materials are shipped from non-European Union countries, please be sure to include an invoice with no commercial value for customs clearance purposes. Any additional expenses incurred by Andreu World in using C.O.M. shall be charged in the final invoice.

To facilitate the C.O.M. process, it is advisable to have the fabric sent to us 4 weeks before your expected order delivery date.

- a) The C.O.M.-requirement for fabrics with special repeat, because of their design, will be supplied on request after inspecting the size of repeat.
- b) For C.O.M., facing and direction should be indicated.
- c) Please indicate the reference number of the order and the chairs which correspond to the C.O.M.

Fabric needs can vary significantly depending on fabric's width. When C.O.M. Requirements exceed 1 roll, one additional meter per roll has to be considered.

8- COVERS

We offer protective covers with Siesta, Sand, and Landscape sofa models, Serena collection and Wind tables. Protective covers must be purchased separately.

9- FABRIC ORDERS

For upholstery orders from the Andreu World catalogue, freight costs shall be for the account of the customer.

10- VARIATIONS IN COLOR OR TONE

Wood may suffer a slight, gradual variation in tone due to continuous outdoor use. Additionally, different batches, the effect of time and weather conditions may all have an effect on color and/or tone. Similarly, polymers may also suffer a slight variation in tone when exposed to highly aggressive atmospheric conditions.

Consequently, Andreu World will accept no responsibility for any variations in tone or color attributable to the above-mentioned factors, or the return of any article for the same.

11- TRANSPORT

Andreu World paid the transport charge on the Peninsula and Baleares except Andorra, Ceuta, Melilla and Canarias.

a) Andreu World can not be held responsible for damage sustained during carriage unless the following conditions are fulfilled:

- 1) carriage is for Andreu World account,
- 2) the carrier is assigned by Andreu World,
- 3) the carrier's delivery note states that the goods were accepted "PENDING INSPECTION," and
- 4) the damage is reported within 24 hours of reception.

Failing these conditions, the damage shall not be covered by the carriage insurance and Andreu World shall be free from all responsibility.

b) When carriage is for customer account or the carrier is chosen by the customer, the customer shall be responsible for any damage sustained during carriage.

c) Orders under 1.000 euros will have a transport upcharge of 150 euros.

12- SPECIAL MEASUREMENTS AND MODIFICATIONS

Should you require any special measurement or modification to our Standard products, please contact our "sales department" for information on viability, price and delivery date.

13- WEIGHTS AND VOLUMES

Weights and volumes that appear in the price-list refer to the weight and volume of the box including the products.

14- The manufacturer reserves the right to modify at any time the sizes and the patterns of the model, as well as to introduce any improvements and modifications deemed necessary in the manufacturer's sole criteria  
Warning: While we have tried to ensure that all prices, sizes, volumes, weights, and other specifications are accurate, they are intended only as a guide and

are subject to modification without notice.

Volumes, weights, number of boxes and units per box can vary depending on the combination of products or the total number of units ordered.

15- GUARANTEE

All the products detailed in this Andreu World Outdoor tariff list, with the exception of fabrics, covers, textiles and materials owned by the client, are guaranteed for TWO years, as of the corresponding invoice date and under normal conditions of use and maintenance, against any defect in the materials and production processes that may affect the use of the same. The guarantee does not cover damage caused by misuse, accidents, negligence, damage occasioned during transport or abuse. Similarly, this guarantee does not cover any defects or imperfections that may arise due to time or the wear occasioned by correct use. For example, this guarantee does not cover the loss of color or color differences, changes in wood texture, scratches occasioned to the metal, polymers or woods due to use, upholstery wear due to stacking, etc. The client is responsible for selecting the correct product for the desired application. This constitutes the entire warranty and is in place of and in lieu of all other warranties of every kind whether implied or expressed, including, but not limited to, the warranty of fitness for a particular purpose or warranty of merchantability. The repair, replacement, or prorated rebate of the full purchase price constitutes the full liability of Andreu World and is the sole remedy of the Buyer. Andreu World assumes no liability for commercial loss or any consequential damages that may arise as a result of any product defect, fault, or delay. It is understood that these limitations of remedy and liability are part of the terms and conditions of the purchase of Andreu World products, and by placing an order the Buyer accepts these terms, conditions, and limitations.



## CONDICIONES DE VENTA/OBSERVACIONES

1 - Lista de precios vigente a partir del 01/01/2024

2- CÓMO REALIZAR UN PEDIDO. Concreten, por favor:

- Nombre y número de referencia del modelo (por ej. Sand SF-4300).
- Nombre y número de referencia del color de acabado (por ej. Blanco).
- Categoría y número de referencia de la tela. (por ej. Natte 10022).
- Cantidad.

3- PLAZO DE ENTREGA

Entre 4 y 5 semanas tras la confirmación del pedido. La fecha de carga para pedidos con acabados especiales para el cliente o con tela cliente no podrá confirmarse hasta la ratificación de nuestra contra muestra o cuando la tela cliente llegue a Andreu World.

4- Las mercancías serán de nuestra propiedad hasta que se paguen en su totalidad.

5- Los plazos de entrega indicados en nuestro pedido de confirmación se considerarán como indicativos y no tendrán carácter obligatorio para el fabricante.

6- PRETAPIZADO

Los artículos se suministrarán con una tela blanca protectora (muslin) para ser posteriormente tapizado por el cliente. Hay algunos modelos en que no recomendamos esta posibilidad debido a la dificultad de su realización. Advertencia: Por favor, señale en la orden de compra si los artículos solicitados en pretapizado llevarán una funda.

7- TAPIZADO CON TELA CLIENTE

Podrán suministrarse por el precio indicado en la categoría de tela cliente, pero las telas tienen que llegar a nuestras fábricas a portes pagados y con una antelación de 3-4 semanas desde la fecha de entrega del pedido. Para los países no pertenecientes a la Unión Europea deben incluir una factura sin valor comercial, requisito obligatorio para pasar las aduanas en España. Cualquier gasto causado por la tela cliente se cargará en la factura.

Para evitar problemas se recomienda enviar la tapicería 4 semanas antes de la fecha de entrega prevista para su pedido.

a) La solicitud de tela cliente para telas con estampado especial, a causa de su diseño, se proporcionará sobre pedido después de inspeccionar el tamaño del estampado

b) Para la tela cliente deberá indicarse la cara y la dirección de la tela para su correcto tapizado

c) Por favor, indiquen el número de referencia del pedido y las sillas que correspondan a la tela cliente.

La responsabilidad del comportamiento de la tela cliente en condiciones de exterior es responsabilidad del cliente.

Las necesidades de tela varían en ocasiones de forma significativa según el ancho. Cuando las necesidades de tela cliente excede de 1 rollo, se debe considerar 1 metro más por rollo.

8- FUNDAS

Ofrecemos la opción de comprar por separado fundas de protección en las colecciones Siesta, Landscape, Sand, Serena y Wind.

9- PEDIDOS DE TELAS

En los pedidos de tapicerías del Catálogo de Andreu World los portes de envío serán a cuenta del cliente.

10- VARIACIONES EN EL COLOR O TONALIDAD

La madera puede sufrir una ligera y gradual variación de tono en un uso continuado en el exterior cubierto o bajo porche. Además, los productos que se compran en periodos distintos, el tiempo transcurrido y las condiciones climáticas pueden causar variaciones en el color y/o tonalidad. Igualmente, el termopolímero también puede sufrir una ligera variación de tono en ambientes muy agresivos.

Por lo tanto, Andreu World no aceptará ninguna reclamación sobre las variaciones de tono o color bajo las condiciones anteriormente expuestas y ningún artículo podrá devolverse por ello.

11- TRANSPORTE

Andreu World cubre los portes de envío en la Península y Baleares salvo Andorra, Ceuta, Melilla y Canarias.

a) Andreu World sólo se responsabilizará de daños producidos en el transporte, cuando se cumplan los requisitos siguientes:

1) Que el porte sea pagado por Andreu World,

2) que la agencia de transportes sea asignada por Andreu World,

3) que en el albarán de recepción de la agencia figure que la mercancía ha sido aceptada "SALVO EXAMEN"; y

4) que el daño sea comunicado en el plazo de 24 horas desde la recepción. Si no se dan estas condiciones el seguro de transporte no cubrirá el daño y Andreu World quedará exenta de toda responsabilidad.

b) Cuando el transporte sea pagado por el cliente o la agencia de transportes elegida por el cliente, el cliente será el responsable de los posibles daños producidos durante el transporte.

c) Los pedidos inferiores a 1.000 euros tendrán un suplemento de transporte de 150 Euros.

12- MEDIDAS ESPECIALES Y MODIFICACIONES

Cualquier medida especial o modificación sobre nuestra oferta estándar de producto que usted precise, deberá consultarla con nuestro "Departamento Comercial", el cual le confirmará su viabilidad, precio y fecha de entrega.

13- PESOS Y VOLÚMENES

Los pesos y volúmenes que figuran en el catálogo de precios se refieren al peso y volumen de la caja en la que van los productos.

14- El fabricante se reserva el derecho, según su propio criterio, a modificar en cualquier momento los tamaños y modelos del prototipo, ya consistan en mejoras o en variantes.

Advertencia: Si bien hemos tratado de asegurar que todos los precios, tamaños, volúmenes, pesos, y otras especificaciones sean precisas, ello se pretende sólo como una guía y está sujeto a modificación sin previo aviso.

Los volúmenes, pesos, número de cajas y unidades por caja pueden variar dependiendo de la combinación de productos o del número total de unidades ordenadas.

15- GARANTÍA

Los productos que figuran en esta tarifa de Andreu World Outdoor, excepto confecciones, fundas, tejidos y materiales propiedad del cliente, están garantizados por DOS años, desde la fecha de factura, bajo condiciones normales de uso y mantenimiento, contra cualquier defecto en materiales y procesos de elaboración que afecten a la funcionalidad de los mismos. Esta garantía no incluye las deficiencias ocasionadas por un uso indebido, accidente, negligencia, daños de transporte o abuso. Así mismo, esta garantía no cubrirá defectos o imperfecciones que resulten del paso del tiempo o el desgaste resultante del propio uso.

Como ejemplo, esta garantía no cubrirá la pérdida de color o las matizaciones de los colores, los cambios de textura de la madera, las rayas producidas en el metal, poliamidas o la madera debidas al uso, desgastes en las tapicerías debido al apilado, etc. La correcta selección del producto para cada aplicación es responsabilidad del comprador. Esta constituye la completa y única garantía, y reemplaza a todas aquellas posibles garantías de cualquier clase bien de forma implícita o explícita, incluyendo pero no limitando el cumplimiento de la Ley 23/2003 del 10 de julio de 2003.

La reparación, cambio o el descuento prorrateado sobre el precio total constituyen la responsabilidad total de Andreu World y la única solución posible al comprador. Andreu World no asume ninguna responsabilidad por pérdidas comerciales y cualquier consecuencia en daños que puedan ser resultado de cualquier defecto en el producto, falta o retraso. Se entiende que estas limitaciones de solución y responsabilidad son parte de los términos y condiciones de compra a Andreu World de sus productos, y cuando se pasa un pedido se están aceptando las condiciones, términos y limitaciones.

## MAINTENANCE

If the product is located in an area near the coast and in permanent contact with a marine atmosphere, for a correct maintenance it is recommended to realise periodic cleaning with fresh water or a descale agent to avoid that the rest of saltpeper sets in the different materials of the product.

### 1- WEBBING

40mm thick polypropylene webbing, with UV and weather protective.

### MAINTENANCE

To clean, gently wipe the belts using a brush and soapy water. Rinse with water and allow to air dry.

Excessive chlorine and certain oil-based lotions can permanently stain the belt's color.

Wipe off bird droppings as soon as possible, as they can cause permanent stains on the belts.

### 2- UPHOLSTERY

The Andreu World Outdoor collections use different types of acrylic fiber and synthetic leather designed for outdoor use and manufactured by the world's leading companies. Strong, durable colors, highly resistant to water, grease and UV rays. Resistant to tears and abrasions.

### MAINTENANCE

To wash the acrylic fabrics, only water and a soft brush are required. The synthetic leather must be frequently cleaned with a damp cloth and a brush. Resistant stains on certain of the synthetic leather collections can be removed with alcohol.

We recommend the cleaning of bird droppings, as they can be particularly harmful and can cause permanent stains.

### 3- CUSHIONS AND FOAMS

The cushions included in the Andreu World Outdoor collections, composed of a foam core and different fibers, are suitable for outdoor use.

### MAINTENANCE

Remove the covers from wet cushions and leave them to dry in an airy, sunny area.

Cushions should be stored during the periods in which the furniture is not in use or during periods of bad weather.

The outer covers of the cushions may be hand- or machine-washed at 40°C.

### 4- CERAMICS

The ceramic tops and boards of the bases and tables included in the Andreu World Outdoor collections are waterproof, hygienic and colorfast. They are fire proof and abrasion-resistant, as well as 100% recyclable.

### MAINTENANCE

We recommend the use of regular detergents for cleaning. Lime, wine, ice cream, coffee and grease stains should be removed using an alkaline detergent or a descaling product.

### 5- HIGH PRESSURE Laminate

The 12mm high pressure laminate table tops are suitable for outdoor use. They are treated against UV action and are highly resistant to wear, heat and moisture.

### MAINTENANCE

The surface should be cleaned with a nonabrasive sponge, water and detergent.

### 6- Laminate BOARDS

The 18mm laminate plywood table tops are suitable for covered outdoor spaces. They are extremely resistant to impacts and scratches and have been specifically designed for those uses which require a high-quality finish and a consistent surface.

### MAINTENANCE

Cleaning is simple and only requires water and detergent.

### 7- ALUMINUM

Aluminum is a lightweight, resistant alternative of proven effectiveness for outdoor furniture. It is 100% recyclable.

### MAINTENANCE

Requires only soap and water.

### 8- STEEL

Steel is robust, hard, rigid and weather-resistant. It is suitable for a wide range of uses.

Andreu World use:

- EPL-5 treated steel, based on electrolytic processes that guarantee extreme durability for outdoor use.

### MAINTENANCE

Stainless steel or EPL-5treated steel only requires regular cleaning with soapy water. In the case of stains, avoid abrasive sponges or fabrics. Clean bird droppings as soon as possible, as they can cause abrasions or permanent stains on the steel.

In the event scratches or impacts which cause damage to the EPL-5 treatment, Andreu World can provide a touch-up kit that includes a corrector enabling the damage to be concealed.

### 9- THERMO-POLYMER

The Flex, Sail and Sit collection high-quality thermo-polymer seats and backrests are special treated for outdoor use.

### MAINTENANCE

Cleaning requires only soap and water.

### 10- COVERS

The protective covers are made of polyester fabric which protects the furniture from moisture, rain and sun.

They can be used to cover the furniture when it is stored or during particularly bad weather conditions.

### 11- GLASS

Tempered glass coated with high-adhesion vitrified paint that prevents color changes over time.

### MAINTENANCE

Any cleaning product (including solvents) can be used.

### 12- SOLID SURFACE

Solid Surface is a non-porous and homogeneous materials comprised of natural minerals and a small percentage of highly durable resins. These tops, made of natural minerals, are similar in appearance and feel to natural stone and are available in white. Suitable for outdoor use.

### MAINTENANCE

The Solid surface tops does not absorb liquids, but is recommended to dry spills or drops immediately. Generally, most stains can be removed using a microfiber cloth dampened with household cleaner spray with circular movements.

## MANTENIMIENTO

Si el producto está ubicado en una zona cerca de la costa y en permanente en contacto con un ambiente marino, para un correcto mantenimiento se recomienda realizar limpiezas periódicas con agua dulce o un agente desincrustante para evitar que los restos de salitre se incrusten en los diferentes materiales del producto.

### 1- CINCHA

Cincha realizada en polipropileno de 40mm de grosor, con protección a los rayos UV y a los agentes climáticos.

### MANTENIMIENTO

Para la limpieza se recomienda frotar suavemente las cintas con un cepillo y agua jabonosa. Posteriormente aclarar con agua y dejar secar al aire libre. El exceso de cloro y algunas lociones compuestas de aceites, pueden manchar permanentemente el color de la cinta. Limpiar los restos de excrementos de aves lo antes posible, ya que pueden causar manchas permanentes en las cintas.

### 2- TAPICERÍA

Las colecciones de Andreu World Outdoor utilizan distintos tipos de fibra acrílica y polipiel, concebidas para su uso en exterior y fabricadas por líderes mundiales. Presentan colores sólidos y duraderos, con una buena resistencia al agua, a las grasas y a los rayos UV. Resistentes al desgarro y a la abrasión.

### MANTENIMIENTO

Los tejidos de fibra acrílica solo necesitan un lavado con agua y un suave cepillado. La limpieza de la polipiel requiere un paño húmedo necesitando una mayor frecuencia de limpieza y cepillado. En algunas de las colecciones de polipiel, las manchas más resistentes pueden eliminarse con alcohol. Se recomienda limpiar los restos de excrementos de aves ya que pueden ser particularmente perjudiciales y pueden causar manchas permanentes.

### 3- COJINES Y ESPUMAS

Los cojines de las colecciones Andreu World Outdoor, compuestos por un núcleo de espuma y diferentes fibras, son válidos para su uso en exterior.

### MANTENIMIENTO

En el caso de que los cojines se mojen se recomienda desfundarlos y dejarlos secar en una zona aireada y soleada. Los cojines se deben guardar durante las temporadas en las que no se va a hacer uso del mobiliario o bajo condiciones meteorológicas adversas. La funda exterior del cojín se puede lavar a mano o a máquina con una temperatura de 40°.

### 4- CERÁMICA

Los sobres y tableros cerámicos de las bases y mesas incluidas en las colecciones de Andreu World Outdoor son impermeables, higiénicos y presentan colores inalterables. Son ignífugos y resistentes a la abrasión. Es 100% reciclable.

### MANTENIMIENTO

Para su limpieza se recomienda usar un detergente habitual. Para las manchas de cal, vino, helado, café o grasa se debe emplear un detergente alcalino o un desincrustante.

### 5- TABLEROS COMPACTOS

Los sobres de mesa de tablero compacto de 12mm son idóneos para su uso en exterior. Incorporan un tratamiento que los protege de la acción UV, unido a la elevada resistencia al desgaste, al calor y a la humedad.

### MANTENIMIENTO

Solo requiere limpiar la superficie con una esponja no abrasiva, agua y detergente.

### 6- TABLERO LAMINADO

Los sobres de tablero contrachapado laminado de 18 mm son válidos para exteriores cubiertos o "bajo porche". Son extremadamente resistentes a los golpes y al rayado, están especialmente preparados para aquellos usos donde se necesita un buen acabado y una superficie consistente.

### MANTENIMIENTO

Su limpieza es sencilla y únicamente requiere agua y detergente.

### 7- ALUMINIO

El aluminio es una alternativa ligera, resistente y de contrastada eficacia en la realización de mobiliario de exterior. Es 100% reciclable.

### MANTENIMIENTO

Solo precisa de agua y jabón.

### 8- ACERO

El acero se caracteriza por ser robusto, duro, rígido y resistente a la agresión de agentes climáticos. Permite un gran número de usos.

Andreu World utiliza:

- Acero con tratamiento EPL-5, basado en procesos electrolíticos que garantiza una gran durabilidad para su uso en el exterior.

### MANTENIMIENTO

El acero inoxidable o con tratamiento EPL-5, sólo demanda una limpieza regular con agua jabonosa. En caso de manchas, se deben evitar las esponjas o tejidos abrasivos. Limpiar lo antes posible restos de excrementos de aves ya que pueden causar abrasión o manchas permanentes en el acero. En caso de arañazos o golpes sobre en los que el tratamiento EPL-5 haya quedado dañado, Andreu World puede proporcionar un kit de retoque que incluye un corrector que permite disimular estéticamente el desperfecto.

### 9- TERMOPOLIMERO

Los asientos y respaldos de la colección Flex, Sail y Sit realizados en termopolímero de alta calidad cuentan con un tratamiento especial para su uso en exterior.

### MANTENIMIENTO

Su limpieza requiere únicamente agua y jabón.

### 10- FUNDAS

Las fundas de protección están confeccionadas en tejido de poliéster que protegen el mobiliario de la humedad, la lluvia y el sol. Permiten resguardar el mobiliario cuando no se utiliza o cuando las condiciones meteorológicas son especialmente adversas.

### 11- CRISTAL

Vidrio templado recubierto con pintura vitrificada de gran adherencia que evita variaciones de color a lo largo del tiempo.

### MANTENIMIENTO

Puede utilizarse cualquier producto de limpieza (incluidos disolventes).

### 12- SOLID SURFACE

Solid Surface es un material compacto y homogéneo, compuesto de minerales naturales y un bajo porcentaje de resinas de alta resistencia. Estos sobres, compuestos por minerales naturales, son en su apariencia y tacto similares a la piedra natural y están disponibles en blanco. Válido para uso en exterior.

### MANTENIMIENTO

Los Top Solid Surface no absorben líquidos, pero se recomienda pasar una esponja o bayeta humedecida para secar las salpicaduras. Las manchas en superficie se pueden eliminar utilizando una bayeta de microfibra humedecida con detergente doméstico en spray realizando movimientos circulares.

## CERTIFICATIONS

### 1- WEBBING

ISO 105-B02 Color fastness outdoors  
ISO 105-X12 Rubbing fastness  
ISO 105-E03 Color fastness to chlorinated water

### 2- CERAMICS

UNE EN ISO 10545-3 Water absorption  
UNE EN ISO 10545-4 Flexural strength  
UNE EN ISO 67-101 Surface hardness (MOHS scale)  
UNE EN ISO 10545-13 Chemical resistance  
UNE EN ISO 10545-12 Frost resistance  
UNE EN ISO 10545-5 Resistance to shock and impact (coefficient of restitution)  
UNE EN ISO 10545-14 Stain resistance  
UNE ENV 12633 Friction coefficient  
UNE EN ISO 10545-9 Resistance to thermal shock  
Decision 96/603/EEC Resistance to fire

### 3- HIGH PRESSURE LAMINATE BOARDS

EN 438-6 Exterior-grade high pressure laminate (2mm and thicker)  
EN 438-2-10 Abrasion resistance  
EN 438-2-12 Resistance to boiling water  
EN 438-2-14 Resistance to water vapor  
EN 438-2-16 Resistance to dry heat 180°C  
EN 12721 Resistance to wet heat  
EN 438-2-17 Dimensional stability at high temperature  
EN 438-2-21 Resistance to impact by large-diameter ball  
EN 438-2-24 Resistance to crazing  
EN 438-2-25 Resistance to scratching  
EN 438-2-26 Stain resistance  
EN 438-2-27 Colorfastness in artificial light  
EN 438-2-30 Resistance to cigarette burns.  
Fire resistance C-s1,d0

### 4- LAMINATE BOARDS

DIN 54004- EN ISO 105-805 Colorfastness (6-7 years) [guaranteed by manufacturer]  
UNE EN ISO 175 Chemical resistance

### 5- ALUMINUM

UNE CEN/TR 581-4 Durability of exterior-grade furniture

### 6- EPL-5 STEEL

UNE CEN/TR 581-4 Durability of exterior-grade furniture

### 7- THERMO-POLYMER

UNE EN 581 Resistance to weather and ageing.  
UNE EN 15373 Resistance, durability and safety.

\*\*For more detailed information on test results contact Export Department.

## CERTIFICACIONES

### 1-CINCHA

ISO 105-B02 Solidez del color a la intemperie.  
ISO 105-X12 Solidez al rozamiento.  
ISO 105-E03 Resistente al agua de piscina.

### 2- CERÁMICA

UNE EN ISO 10545-3 Absorción del agua  
UNE EN ISO 10545-4 Resistencia a la flexión  
UNE EN ISO 67-101 Dureza superficial (Escala MOHS)  
UNE EN ISO 10545-13 Resistencia al ataque químico  
UNE EN ISO 10545-12 Resistencia a las heladas  
UNE EN ISO 10545-5 Impacto (coeficiente de restitución)  
UNE EN ISO 10545-14 Resistencia a las manchas  
UNE ENV 12633 Deslizamiento (coeficiente de fricción)  
UNE EN ISO 10545-9 Resistencia al choque térmico  
Comission Decisión 96/603/EC Resistencia al fuego

### 3- TABLERO COMPACTO

EN 438-6 Compactos para exteriores de 2 mm de espesor y mayores.  
EN 438-2-10 Resistencia a la abrasión.  
EN 438-2-12 Resistencia al agua hirviendo.  
EN 438-2-14 Resistencia al vapor de agua.  
EN 438-2-16 Resistente al calor seco 180°C.  
EN 12721 Resistencia al calor húmedo.  
EN 438-2-17 Estabilidad dimensional a temperatura elevada.  
EN 438-2-21 Resistencia al impacto de una bola de gran diámetro.  
EN 438-2-24 Resistencia al agrietado.  
EN 438-2-25 Resistencia al rayado.  
EN 438-2-26 Resistencia a las manchas.  
EN 438-2-27 Solidez del color a la luz artificial.  
EN 438-2-30 Resistencia a las quemaduras de cigarrillo.  
Reeacción al fuego C-s1,d0

### 4- TABLERO LAMINADO

DIN 54004- EN ISO 105-805 Estabilidad del color (6-7 años) [garantizado por el fabricante]  
UNE EN ISO 175 Resistencia a los agentes químicos

### 6- ALUMINIO

UNE CEN/TR 581-4 Durabilidad del mobiliario de exterior.

### 5- ACERO EPL-5

UNE CEN/TR 581-4 Durabilidad del mobiliario de exterior

### 7- TERMOPOLIMERO

UNE EN 581 Resistencia a la intemperie y al paso del tiempo.  
UNE EN 15373 Resistencia, durabilidad y seguridad.

\*\*Para recibir información detallada sobre los resultados de los ensayos contactar con nuestro Departamento comercial.



Fabrics

## Andreu World Textiles

Sand / Grade 1 IN/OUT

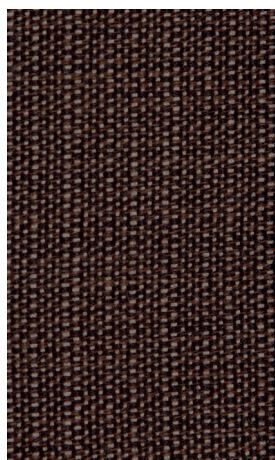

1184

Composition / Composición  
100% Dyed Acrylic Solution  
100% Acrílico teñido en masa

Martindale test /  
Resistencia a la abrasión  
17.000 Cycles / Ciclos



1180



1181



1183



1182

Loom Two / Grade 3 IN/OUT



I065

Composition / Composición  
100% PP

Martindale test /  
Resistencia a la abrasión  
20.000 Cycles / Ciclos

Certifications / Certificad  
BS 5852:1990 sez 4 part 1  
(Cigarette Test)



I057

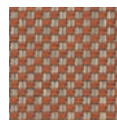

I058



I059



I060



I061

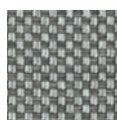

I062



I063

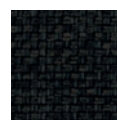

I064



I066

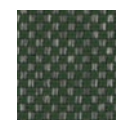

I067

**Andreu World Textiles**

**Reel One / Grade 1 IN/OUT**

Composition / Composición  
 100% Fibra acrílica tintada en masa  
 100% Solution-dyed acrylic fibre

Martindale test /  
 Resistencia a la abrasión  
 30.000 Cycles / Ciclos  
 (EN ISO 12947/2)



R059

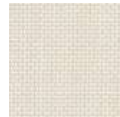

R050

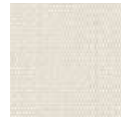

R051



R052



R053



R054



R055



R056



R057



R058



R060

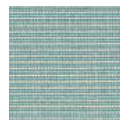

R061



R062

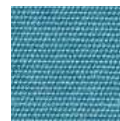

R063



R064



R065

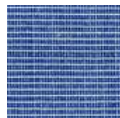

R066



R067



R068



R069



R070

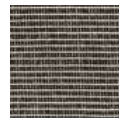

R071



R072

**Reel Two / Grade 3 IN/OUT**

Composition / Composición  
 100% Fibra acrílica tintada en masa  
 100% Solution-dyed acrylic fibre

Martindale test /  
 Resistencia a la abrasión  
 30.000 Cycles / Ciclos  
 (EN ISO 12947/2)



R078

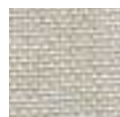

R073



R074



R075



R076



R077

## Andreu World Textiles

### Reel Three / Grade 4 IN/OUT

Composition / Composición  
100% Fibra acrílica tintada en masa  
100% Solution-dyed acrylic fiber

Martindale test /  
Resistencia a la abrasión  
30.000 Cycles / Ciclos  
(EN ISO 12947/2)



R079



R080



R081

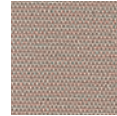

R082

### Reel Four / Grade 4 IN/OUT

Composition / Composición  
100% Fibra acrílica tintada en masa  
100% Solution-dyed acrylic fiber

Martindale test /  
Resistencia a la abrasión  
30.000 Cycles / Ciclos  
(EN ISO 12947/2)



R083

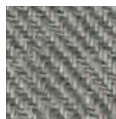

R084

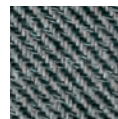

R085

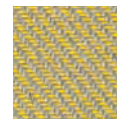

R086

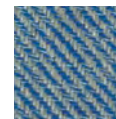

R087

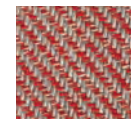

R088

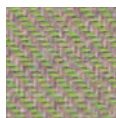

R089

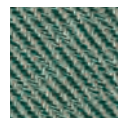

R090



## Andreu World Textiles

### Tack One / Grade 2 IN/OUT

Composition / Composición  
 49.5% PAC. 38,5%PES. 12%CO  
 49.5% PAC. 38,5%PES. 12%CO

Martindale test /  
 Resistencia a la abrasión  
 35.000 Cycles / Ciclos  
 (EN ISO 12947/2)

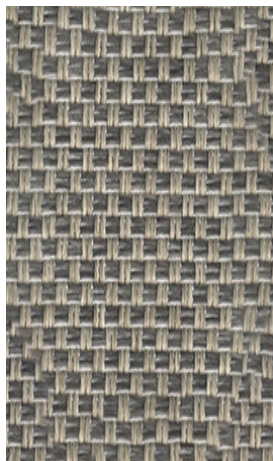

2242



2240



2741

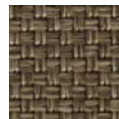

2243

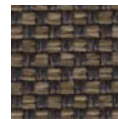

2244

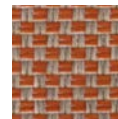

2245

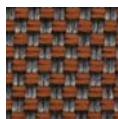

2246



2247

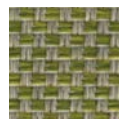

2248

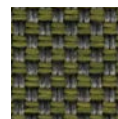

2249



2250



2251



2252



2253



2254



2255

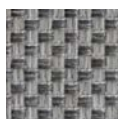

2256

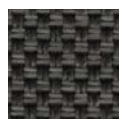

2257

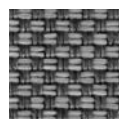

2258



2259



2470

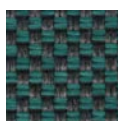

2471

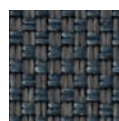

2472



2473

### Tack Two / Grade 6 IN/OUT

Composition / Composición  
 82% PP., 18%PES. REC.  
 82% PP., 18%PES. REC.

Martindale test /  
 Resistencia a la abrasión  
 100.000 Cycles / Ciclos  
 (EN ISO 12947/2)



2178

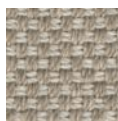

2179

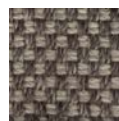

2180

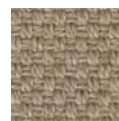

2181

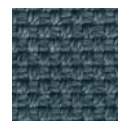

2182

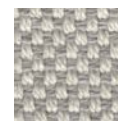

2183



2184



2185

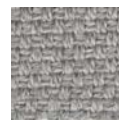

2186

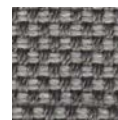

2187

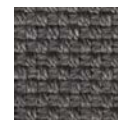

2188

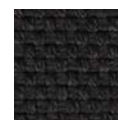

2189

## Andreu World Textiles

### Tack Three / Grade 6 IN/OUT

Composition / Composición  
100% PET.  
100% PET.

Martindale test /  
Resistencia a la abrasión  
100.000 Cycles / Ciclos  
(EN ISO 12947/2)



2826



2810



2811

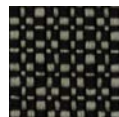

2812



2813

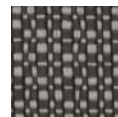

2814

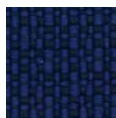

2815

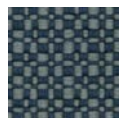

2816



2817

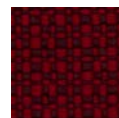

2818



2819

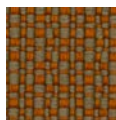

2820



2821



2822



2823



2824

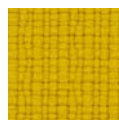

2825



2827

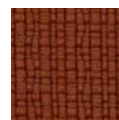

2829



2829

### Tack Four / Grade 9 IN/OUT

Composition / Composición  
100% PET  
100% PET

Martindale test /  
Resistencia a la abrasión  
50.000 Cycles / Ciclos  
(EN ISO 12947/2)



2831

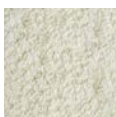

2830



2832

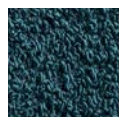

2833

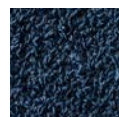

2834

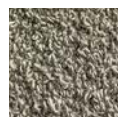

2835

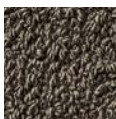

2836

## Andreu World Textiles

Tack Five / Grade 7 IN/OUT

Composition / Composición  
PP 100%  
PP 100%

Martindale test /  
Resistencia a la abrasión  
100.000 Cycles / Ciclos  
(EN ISO 12947/2)



L068



L069



L070



L071



L072



L073

## Sunbrella Textiles / Telas Sunbrella

Mezzo / Grade 3

Composition / Composición  
100% Sunbrella Acrylic  
100% Sunbrella acrílico

Martindale test /  
Resistencia a la abrasión  
22.000 Cycles / Ciclos



**MEZ 10227**  
140 Atlas



**MEZ 10228**  
140 Celadon



**MEZ 10221**  
140 Coral



**MEZ 10225**  
140 Feather



**MEZ 10223**  
140 Henna



**MEZ 10229**  
140 Opal



**MEZ 10224**  
140 Scale



**MEZ 10219**  
140 Sulfur



**MEZ 10222**  
140 Tigerlily



**MEZ 10226**  
140 Tropic



**MEZ 10220**  
140 Turmeric

Natte / Grade 3

Composition / Composición  
100% Sunbrella solution dyed  
acrylic  
Solución Sunbrella 100% teñida  
acrílica

Martindale test /  
Resistencia a la abrasión  
30.000 Cycles / Ciclos

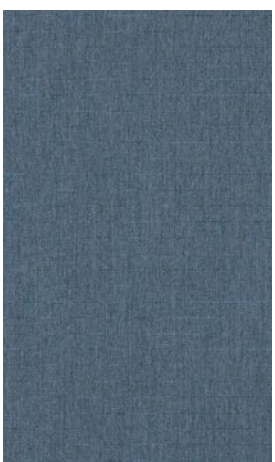

**AT 10064 140**  
Carbon Sky

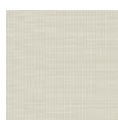

**NAT 10014**  
140 Nature



**NAT 10020**  
140 White

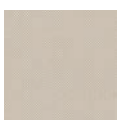

**NAT 10021**  
140 Canvas



**NAT 10022 140**  
Grey Chine



**NAT 10025 140**  
Frosty Chine



**NAT 10028 140**  
Heather Beige



**NAT 10029 140**  
Heather Grey

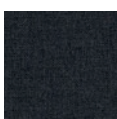

**NAT 10030 140**  
Sooty

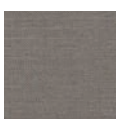

**NAT 10040 140**  
Nature Grey



**NAT 10059 140**  
Dark Taupe

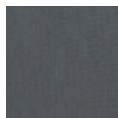

**NAT 10063 140**  
Charcoal Chine



**NAT 10065 140**  
Carbon beige

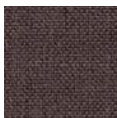

**NAT 10101**  
140 Tonka

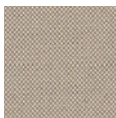

**NAT 10150**  
140 Heather



**NAT 10151**  
140 Linen



**NAT 10152**  
140 Graumel



**NAT 10155**  
140 Taupe

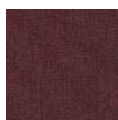

**NAT 10231**  
140 Carmine



**NAT 10232**  
140 Ivy



**NAT 10233**  
140 Pistachio



**NAT 10234**  
140 Flamingo

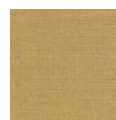

**NAT 10235**  
140 Amber

## Sunbrella Textiles / Telas Sunbrella

Solid & Stripes / Grade 2

Composition / Composición  
100% acrílico teñido en masa  
100% acrylic dyed mass

Martindale test /  
Resistencia a la abrasión  
30.000 Cycles / Ciclos



SJA 5477  
137 Logo Red

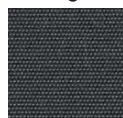

SJA 3906 137  
Carbon



SJA 3964 137  
Curacao

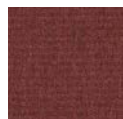

SJA 3982 137  
Autumn



SJA 3989 137  
Opera

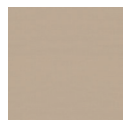

SJA 5422 137  
Antique Beige

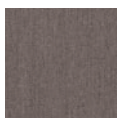

SJA 3907 137  
Taupe Chine



SJA 3965 137  
Blush



SJA 3983 137  
Almond



SJA 3990 137  
Myosotis



SJA 5436 137  
Burgundy



SJA 3127 137  
Mink Brown



SJA 3729 137  
Taupe

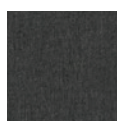

SJA 3757 137  
Flanelle

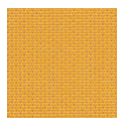

SJA 3938 137  
Mimosa



SJA 3966 137  
Marble



SJA 3984 137  
Canary



SJA 3991 137  
Blazer



SJA 5453 137  
Canvas

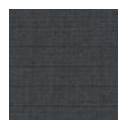

SJA 3705 137  
Charcoal

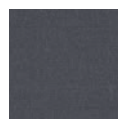

SJA 3737 137  
Ardoise



SJA 3758 137  
Sooty

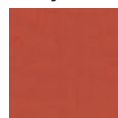

SJA 3939 137  
Paprika

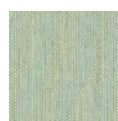

SJA 3967 137  
Mint



SJA 3985 137  
Ink



SJA 5404 137  
Natural



SJA 5476 137  
Heather Beige



SJA 3706 137  
Shingles



SJA 3738 137  
Macao



SJA 3780 137  
Lin



SJA 3941 137  
Adriatic



SJA 3968 137  
Pepper



SJA 3986 137  
Rainforest



SJA 5408 137  
Black



SJA 5499 137  
True Blue



SJA 3717 137  
Riviera Blue



SJA 3741 137  
Silver Grey

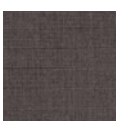

SJA 3792 137  
Dark Smoke

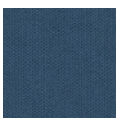

SJA 3942 137  
Blue Storm



SJA 3969  
137 Pumpkin



SJA 3987 137  
Alpine



SJA 5416 137  
Aruba

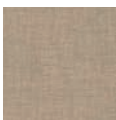

SJA 48009 137  
Arbor Pebble



SJA 3728 137  
Paris Red



SJA 3756 137  
Lead Chine



SJA 3793 137  
Blue Chine



SJA 3944 137  
Charron

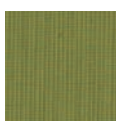

SJA 3970 137  
Lichen

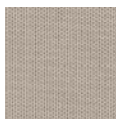

SJA 3988 137  
Stone



SJA 5420 137  
Mineral Blue

## Sunbrella Textiles / Telas Sunbrella

### Heritage / Grade 4

Composition / Composición  
 50% Recycled acrylic, 47% acrylic,  
 3% PE  
 50% acrílico reciclado, 47%  
 acrílico, 3% PE

Martindale test /  
 Resistencia a la abrasión  
 22.000 Cycles / Ciclos



**SJA 18012 00**  
 137 Moss

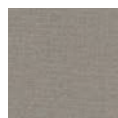

**SJA 18001 00**  
 137 Ash



**SJA 18006 00**  
 137 Papyrus

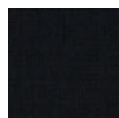

**SJA 18009 00**  
 137 Char



**SJA 18011 00**  
 137 Leaf



**SJA 18015 00**  
 137 Slate



**SJA 18016 00**  
 137 Sky



**SJA 18017 00**  
 137 Indigo



**SJA 18018 00**  
 137 Alpine

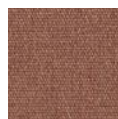

**SJA 18021 00**  
 137 Rust



**SJA 18022 00**  
 137 Scarlet

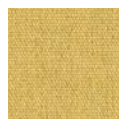

**SJA 18023 00**  
 137 Duon

### Savane / Grade 4

Composition / Composición  
 100% Sunbrella solution dyed  
 acrylic  
 Solución Sunbrella 100% teñida  
 acrílica

Martindale test /  
 Resistencia a la abrasión  
 38.000 Cycles / Ciclos



**SAV2 J233**  
 140 Coconut



**SAV2 J234**  
 140 Grey

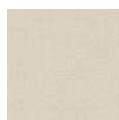

**SAV2 J235**  
 140 White



**SAV2 J350**  
 140 Nimbus



**SAV2 J349 140**  
 Savane Whisper



**SAV2 J236**  
 140 Zinc



**SAV2 J351**  
 140 Tornado

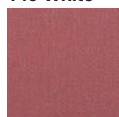

**SAV2 J352**  
 140 Eris



**SAV2 J353**  
 140 Dawn



**SAV2 J354**  
 140 Spring

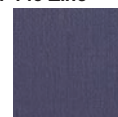

**SAV2 J355**  
 140 Midnight

## Sunbrella Textiles / Telas Sunbrella

### Chartres / Grade 6

Composition / Composición  
100% Sunbrella solution dyed  
acrylic  
Solución Sunbrella 100% teñida  
acrílica

Martindale test /  
Resistencia a la abrasión  
35.000 Cycles / Ciclos



**CHA2 J193**  
140 Pearl

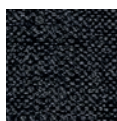

**CHA2 J182**  
140 Sooty



**CHA2 J189**  
140 Heather

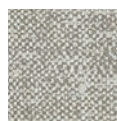

**CHA2 J191**  
140 Grey



**CHA2 J194**  
140 Silver



**CHA2 J348 140**  
Chartres Drizzle

### Zori / Grade 6

Composition / Composición  
98% Sunbrella Acrylic, 2% Other  
Fiber  
98% Sunbrella acrílico, 2% otras  
fibra

Martindale test /  
Resistencia a la abrasión  
37.000 Cycles / Ciclos



**ZOR R065**  
140 Fugu



**ZOR R061**  
140 Gari



**ZOR R067**  
140 Graphite



**ZOR R063**  
140 Hibiscus



**ZOR R064**  
140 Kiri



**ZOR R059**  
140 Matcha



**ZOR R069**  
140 Miso



**ZOR R070**  
140 Muse



**ZOR R068**  
140 Nami



**ZOR R057**  
140 Rice



**ZOR R066**  
140 Sake



**ZOR R062**  
140 Sento



**ZOR R060**  
140 Straw



**ZOR R058**  
140 Washi

## Kvadrat Textiles / Telas Kvadrat

### Patio / Grade 6

Composition / Composición 100% Trevira CS  
100% Trevira CS

Martindale test / Resistencia a la abrasión  
50.000 Cycles / Ciclos

Certifications / Certificados  
BS 5852 Crib 5 • IMO FTP Code 2010 Part 8 • NF D 60 013 • NF P 92 507 M1 • UNI 9175 1IM • UNI 9177 Classe 1 • US Cal. Bull. 117-2013 • DIN 4102 B1 • EN 1021-1/2 • AS/NZS 3837 class 1  
ASTM E84 Class A Unadhered • NFPA 701 • ÖNORM B1/Q1



0440

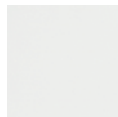

0100

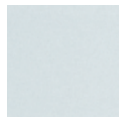

0110



0140



0150



0170

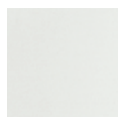

0200



0210

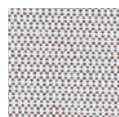

0220

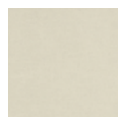

0230



0340



0370



0410



0430



0450



0550

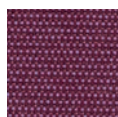

0570



0650



0730



0740



0750

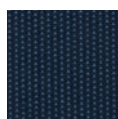

0780

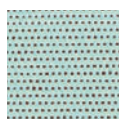

0840



0970

### Atrium / Grade 8 IN/OUT

Composition / Composición 100% Trevira CS, water repellent  
100% Trevira CS, repelente al agua

Martindale test / Resistencia a la abrasión  
50.000 Cycles / Ciclos

Certifications / Certificados  
OEKO-TEX® Standard 100 • AS/NZS 3837 • BS 5852 part 1 • EN 1021-1/2 • IMO FTP Code 2010 Part 8 • NF D 60 013 • NFPA 260UNI 9175 1 • IMUS Cal. Bull. 117-2013 • ÖNORM B1/ Q1 • BS 5852 Crib 5 with treatment



0951



0131



0181



0201



0231



0241



0351



0451

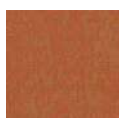

0541

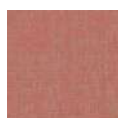

0631



0701



0751



0781



0901



0931



0981



## Sunbrella Textiles / Telas Sunbrella

Domino / Grade 8

100% Sunbrella Acrylic  
100% Sunbrella acrílico

Martindale test /  
Resistencia a la abrasión  
80.000 Cycles / Ciclos



**DOM R049**  
**140 Casino**

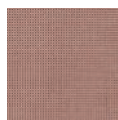

**DOM R046**  
**140 Craps**



**DOM R050**  
**140 Jackpot**

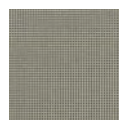

**DOM R045**  
**140 Joker**



**DOM R044**  
**140 Loto**

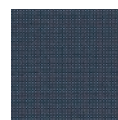

**DOM R048**  
**140 Poker**



**DOM R047 140**  
**Roulette**

Lopi / Grade 8

Composition / Composición  
100% Sunbrella solution dyed  
acrylic  
Solución Sunbrella 100% teñida  
acrílica

Martindale test /  
Resistencia a la abrasión  
90.000 Cycles / Ciclos

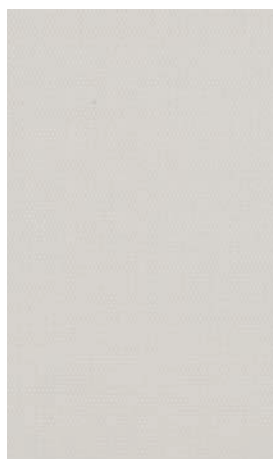

**LOP R033**  
**140 Snow**



**LOP R013**  
**140 Shadow**

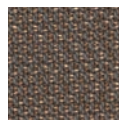

**LOP R014**  
**140 Coconut**



**LOP R015**  
**140 Silver**



**LOP R017**  
**140 Charcoal**



**LOP R018**  
**140 Marble**



**LOP R019**  
**140 Sand**



**LOP R034**  
**140 Antique**



**LOP R038**  
**140 Beldi**

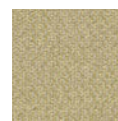

**LOP R039**  
**140 Biscuit**

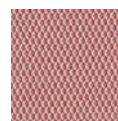

**LOP R040**  
**140 Azalea**



**LOP R041**  
**140 Tangerine**

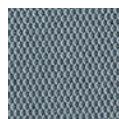

**LOP R042**  
**140 Nenuphar**

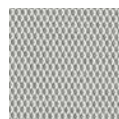

**LOP R043**  
**140 Ash**

## Spradling Textiles / Telas Spradling

### Silvertex / Grade 2

Composition / Composición  
Vinyl / Urethane topcoat  
Capa de vinilo / uretano

Martindale test /  
Resistencia a la abrasión  
300.000 Cycles / Ciclos

Certifications / Certificados  
EU: EN 1021 Parte 1 y 2 • ES: UNE 23.727-90 1R/M.2 • FR: NF P 92-503/M2 • DE: DIN 4102 B2 • IT: UNI 9175 (1987) / UNI 9175/FA1 (1994) • Classe 1.I.M (UNO I EMME) • AT: ÖNORM B 3825, Gruppe 1 - Schwerbrennbare Verhalten • AT: ÖNORM A 3800 Teil 1, Qualmbildungsklasse Q1 - schwachqualmend • IMO FTP 2010 Código MSC.307 (88) Parte 8 3.1 & 3.2 • US: FMVSS 302 • US: FAR 25/853 (MED) Marine Equipment Directive (en su versión en vigor) • ECE R118.02 (replaces Directive 95/28/CE) Annexes 6, 7 & 8 • EN 71-2:2006+A1:2007 - Seguridad del juguete - Parte 2: Inflamabilidad • Selección de colores en calidad BS 5852 CRIB 5

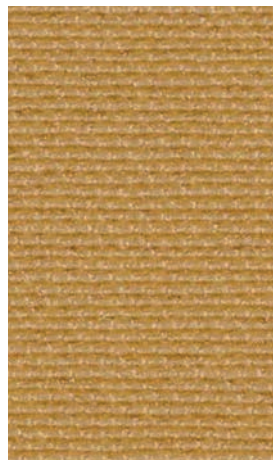

**Camel**  
122-2105



**Avocado**  
122-2092



**Squash**  
122-2093



**Lotus**  
122-2099



**Teal**  
122-2100

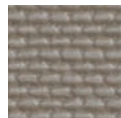

**Macadamia**  
122-0001



**Luggage**  
122-0073

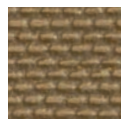

**Champagne**  
122-1078

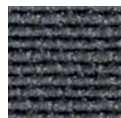

**Petrol**  
122-2094



**Aluminium**  
122-2101



**Sandstone**  
122-0002



**Beige**  
122-



**Cobre**  
122-2003



**Grenadine**  
122-2095



**Coral**  
122-2102

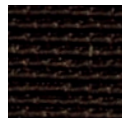

**Mocca**  
122-



**Umber**  
122-1014



**White**  
122-2089



**Tomato**  
122-2096



**Skylight**  
122-2103



**Taupe**  
122-0009

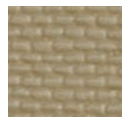

**Sisal**  
122-

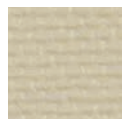

**Ice Cream**  
122-2090



**Orchid**  
122-2097

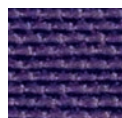

**Ultra Violet**  
122-2104



**Naranja**  
122-0013

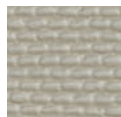

**Cream**  
122-1077



**Citrus**  
122-2091

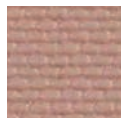

**Rosé**  
122-2098

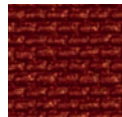

**Sunkist**  
122-2012

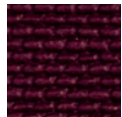

**Raspberry**  
122-2016

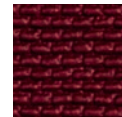

**Wine**  
122-2064

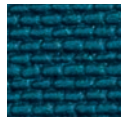

**Turquoise**  
122-3001



**Sapphire**  
122-3007

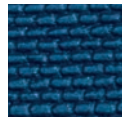

**Baltic**  
122-3066

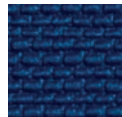

**Delft**  
122-3067

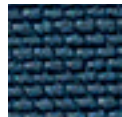

**Jet**  
122-3068



**Plata**  
122-

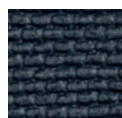

**Storm**  
122-4002



**Graphite**  
122-4003

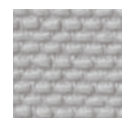

**Ice**  
122-4004

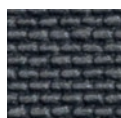

**Titanium**  
122-4010

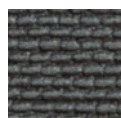

**Sterling**  
122-4011



**Shiitake**  
122-4012

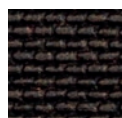

**Meteor**  
122-4024



**Pistacho**  
122-5008

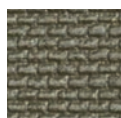

**Sage**  
122-5009

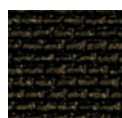

**Bottle**  
122-5010



**Celery**  
122-5019

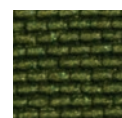

**Basil**  
122-5020



**Forest**  
122-5063

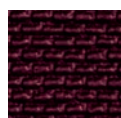

**Rubin**  
122-6004

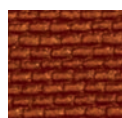

**Mandarin**  
122-



**Melon**  
122-6062



**Safran**  
122-6065

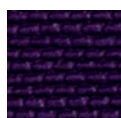

**Aubergine**  
122-7001

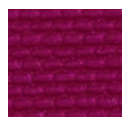

**Magenta**  
122-7002

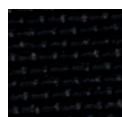

**Black**  
122-9001

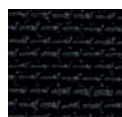

**Carbon**  
122-9002

## Spradling Textiles / Telas Spradling

### Maglia / Grade 3

Composition / Composición  
Vinyl / Urethane topcoat  
Capa de vinilo / uretano

Martindale test /  
Resistencia a la abrasión  
>100.000 Cycles / Ciclos

Certifications / Certificados  
EU: EN 1021 Parte 1 y 2 ● ES: UNE 23.727-90 1R/M.2 ● FR: NF P 92-503/M2 ● DE: DIN 4102 B2 ● IT: UNI 9175 (1987) / UNI 9175/FA1 (1994) Classe 1.IM (UNO I EMME) ● AT: ÖNORM B 3825, Gruppe 1 - Schwerbrennbares Verhalten ● AT: ÖNORM A 3800 Teil 1, Qualmbildungsklasse Q1 - schwachqualmend ● IMO FTP 2010 Código MSC.307 (88) Parte 8 3.1 & 3.2 ● US: FMVSS 302 ● US: FAR 25/853 ● (MED) Marine Equipment Directive (en su versión en vigor) ● ECE R118.02 (replaces Directive 95/28/CE) Annexes 6, 7 & 8 ● EN 71-2:2006+A1:2007 - Seguridad del juguete - Parte 2: Inflamabilidad



**Urban**  
MAG-8056



**Army**  
MAG-0031



**Dovetail**  
MAG-1702



**Earth**  
MAG-3616

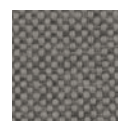

**Granite**  
MAG-7026



**Ginger**  
MAG-6025

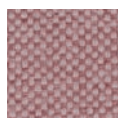

**Blossom**  
MAG-4203



**Uyumi**  
MAG-5001



**Serenity**  
MAG-2420

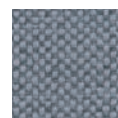

**Breeze**  
MAG-0003



**Indigo**  
MAG-5559

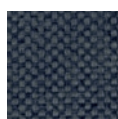

**Midnight**  
MAG-5450



**Greenland**  
MAG-6443



**Sky**  
MAG-2003

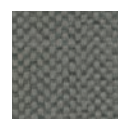

**Safari**  
MAG-8022



**Primrose**  
MAG-2000



**Sage**  
MAG-0406

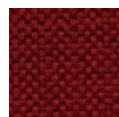

**Mars**  
MAG-4227



**Truffle**  
MAG-4537

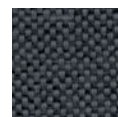

**Thunder**  
MAG-6016

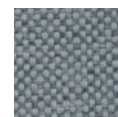

**Alaska**  
MAG-4008

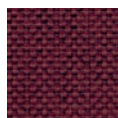

**Açai**  
MAG-6030

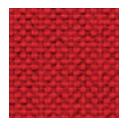

**Maple**  
MAG-6026



**Svalbard**  
MAG-6022

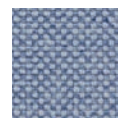

**Kyanite**  
MAG-6023

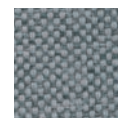

**Tahoe**  
MAG-6027



**Minuit**  
MAG-6028



**Blackcave**  
MAG-6032

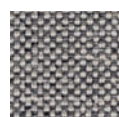

**Monochrome**  
MAG-6024

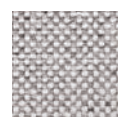

**Ash**  
MAG-6031



**Fjord**  
MAG-6021



**Maui**  
MAG-6020



**Hive**  
MAG-6029



**Grizzly**  
MAG-6019

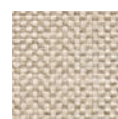

**Oak**  
MAG-6018



**Artic**  
MAG-6017

**Ultrafabrics Textiles / Telas Ultrafabrics**

**Coast / Grade 10**

Composition / Composición 100%  
Polycarbonate Polyurethane  
Surface  
100% Policarbonato  
Superficie de poliuretano

Martindale test /  
Resistencia a la abrasión 180.000  
Cycles / Ciclos

Certifications / Certificados  
ASTM E84-Class A ● CA TB  
117-2013-Pass ● FMVSS  
302&95/28 Annex IV ● NFPA 260-  
Class 1 ●UFAC Class 1



**640-3837**  
**Bungalow**

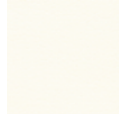

**640-0021**  
**Snow Cap**



**640-0042**  
**Beacon**



**640-2579**  
**Glacial**



**640-2590**  
**Raindrop**



**640-2776**  
**Naval Blue**

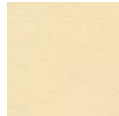

**640-3797**  
**Conch**



**640-3879**  
**Terra**



**640-3880**  
**Savanna**



**640-3881**  
**Dusty Earth**



**640-3890**  
**Cabana**



**640-4338**  
**Stem Green**



**640-5968**  
**Feather**



**640-6086**  
**Walrus Grey**



**640-6508**  
**Dolphin**



**640-7230**  
**Calypso**