

PRIC 

LIS  

 **4.23**

MIDJ[®]

w

••

PRICE 

LIS  

 **4.23**

MIDJ[®]

INDEX

Chairs

Apelle	18
Area	22
Bolle	26
Calla	32
Cover	54
Dalia	58
Danny	73
Guapa	75
Joe	78
Lea	85
Liù	94
Maya	111
Master	113
Mia	115
Mito	116
Montera	119
Nenè	122
Nuvola	127
Ola	134
P47	139
Pippi	146
Piuma	148
Qua-ndo	151
S1	153
Silvy	155
Slim	159
Soffio	162
Sonny	163
Star	172
Strike	174
Suite	175
Toy	176
Trampoliere	177
Wrap	179

Tables

Akashi	184
Alexander	187
Alfred	189
Apollo	191
Armando	193
Badù	195
Blade	198
Brioso	201
Clessidra	202
Dama	207
Diamante	210
Forest	212
Gran Sasso	214
Infinity	215
Lea	218
Link	219
Marcopolo	220
Master	221
Moonlight	222
More	223
Nenè	226
Nexus	228
Paul	230
Pechino	231
Plissé	233
Spike	235
Suite	236
Woody	237
Zeus	241

Coffee Table

Apelle	244
Bloom	248
Bolle	250
Clessidra	252
Dalia	254
Guapa	255
Hoodi	256
Joint	257
Lea	259
Ola	261
P47	262
Paw	263
Suite	264
Trampoliere	266
Trip	267
Walter	268

Complements

Apelle	270
Suite	271
Apelle	272
Lea	273
Apelle	276
Siena	278
Suite	280
Apelle	281
Guapa	282
Pippi	283
Bold	284
Peek	285
Spot	286
Bolle	287
Charlotte	288
Ghost	289
Guapa	290
Japan	291
Suspense	293
Sunrise	294

Bases

Break	296
Clessidra	297
Composit	298
Dama	304
Liù	305
Luna	307
Ola	308
Plissé	309
Smart	310
Square	312
Trampoliere	314

Top

Glass Top	316
Marble Top	317
Top Melamine	318
Top MDF	319
Top Fenix	320
Laminate Top	321
Top HPL	322
Top sheet metal	323
Top metal	324

Accessories 326

Finiture 327

Tables index by size

Fix tables

Model	Tops' materials	Tops' shape
cm 60		
Break/3	melamine, crystalceramic, HPL, metal	● ■
Break/4	glass, melamine, HPL	●
Composit/1 45x45 H73	glass, melamine, HPL	● ■
Composit/1 45x45 H107	glass, melamine, HPL	● ■
Composit/2 45x45 H73	glass, melamine, HPL	● ■
Composit/2 45x45 H107	glass, melamine, HPL	● ■
Composit/3 diam 45 H73	glass, melamine, HPL	● ■
Composit/3 diam 45 H107	glass, melamine, HPL	● ■
Composit/3 diam 55 H73	glass, melamine, HPL	●
Composit/3 diam 55 H107	glass, melamine, HPL	●
Infinity diam 44	melamine, glass, crystalceramic, HPL, metal, fenix, laminate	●
Liu H73	melamine, HPL	● ■
Liu H107	melamine, HPL	● ■
Plissé H73	melamine, laminate, fenix, HPL, metal sheet, metal	●
Plissé H103	melamine, laminate, fenix, HPL, metal sheet, metal	●
Smart/1 39x39 H73	melamine, HPL	● ■
Smart/1 39x39 H107	melamine, HPL	● ■
Smart/1 48x48 H73	melamine, HPL	● ■
Smart/1 48x48 H107	melamine, HPL	● ■
Smart/2 diam 42 H73	melamine, HPL	● ■
Smart/2 diam 42 H107	melamine, HPL	● ■
Smart/2 diam 50 H73	melamine, HPL	● ■
Smart/2 diam 50 H107	melamine, HPL	● ■
Trampoline H73	melamine, HPL	●
Trampoline H107	melamine, HPL	●

cm 70

Break/3	melamine, glass, crystalceramic, HPL, metal, metal sheet	● ■
Break/4	melamine, glass, crystalceramic, HPL, metal, metal sheet	● ■
Dama 3G H73	melamine, laminate, fenix, HPL, metal sheet, metal	●
Dama 3G H103	melamine, laminate, fenix, HPL, metal sheet, metal	●
Dama 4G H73	melamine, laminate, fenix, HPL, metal sheet, metal	■
Dama 4G H103	melamine, laminate, fenix, HPL, metal sheet, metal	■
Clessidra	melamine, laminate, fenix, HPL, metal sheet, metal	●
Composit/1 45x45 H73	glass, melamine, HPL, metal sheet, metal	● ■
Composit/1 45x45 H107	glass, melamine, HPL, metal sheet, metal	● ■
Composit/2 45x45 H73	glass, melamine, HPL, metal sheet, metal	● ■
Composit/2 45x45 H107	glass, melamine, HPL, metal sheet, metal	● ■
Composit/3 diam 45 H73	glass, melamine, HPL, metal sheet, metal	● ■
Composit/3 diam 45 H107	glass, melamine, HPL, metal sheet, metal	● ■
Composit/3 diam 55 H73	glass, melamine, HPL, metal sheet, metal	● ■
Composit/3 diam 55 H107	glass, melamine, HPL, metal sheet, metal	● ■
Infinity diam 44	melamine, glass, crystalceramic, HPL, metal, fenix, metal sheet	●
Plissé H73	melamine, laminate, fenix, HPL, metal sheet, metal	●
Plissé H103	melamine, laminate, fenix, HPL, metal sheet, metal	●
Sintesy	glass, melamine, HPL, metal sheet, metal	● ■
Liu H73	melamine, HPL, metal sheet, metal	● ■
Liu H107	melamine, HPL, metal sheet, metal	●
Luna H73	melamine, HPL, metal sheet, metal	● ■
Luna H107	melamine, HPL, metal sheet, metal	● ■
Smart/1 39x39 H73	melamine, HPL, metal sheet, metal	● ■
Smart/1 39x39 H107	melamine, HPL, metal sheet, metal	● ■

Fix tables

Model	Tops' materials	Tops' shape
cm 70		
Smart/1 48x48 H73	melamine, HPL, metal sheet, metal	● ■
Smart/1 48x48 H107	melamine, HPL, metal sheet, metal	● ■
Smart/2 diam 42 H73	melamine, HPL, metal sheet, metal	● ■
Smart/2 diam 42 H107	melamine, HPL, metal sheet, metal	● ■
Smart/2 diam 50 H73	melamine, HPL, metal sheet, metal	● ■
Smart/2 diam 50 H107	melamine, HPL, metal sheet, metal	● ■
Square 3G H73	melamine, HPL, metal sheet, metal	●
Square 3G H107	melamine, HPL, metal sheet, metal	●
Square 4G H73	melamine, HPL, metal sheet, metal	● ■
Square 4G H107	melamine, HPL, metal sheet, metal	● ■
Trampoline H73	melamine, HPL, metal sheet, metal	●
Trampoline H107	melamine, HPL, metal sheet, metal	●
Nené	melamine, HPL	●









































cm 75

Dama 4G H73	melamine, laminate, fenix, HPL, metal sheet, metal	■
Dama 4G H103	melamine, laminate, fenix, HPL, metal sheet, metal	■
Ola/4	metal sheet	■
Nené	melamine, HPL	■











































cm 80

Break/4	glass, melamine	●
Clessidra	melamine, laminate, fenix, HPL, metal sheet, metal	●
Dama 3G H73	melamine, laminate, fenix, HPL, metal sheet, metal	●
Dama 3G H103	melamine, laminate, fenix, HPL, metal sheet, metal	●
Dama 4G H73	melamine, laminate, fenix, HPL, metal sheet, metal	■
Dama 4G H103	melamine, laminate, fenix, HPL, metal sheet, metal	■
Infinity diam 44	melamine, glass, crystalceramic, HPL, metal	●
Composit/1 45x45 H73	glass, melamine, HPL, metal sheet, metal	● ■
Composit/1 45x45 H107	glass, melamine, HPL, metal sheet, metal	●
Composit/1 55x55 H73	glass, melamine, HPL, metal sheet, metal	● ■
Composit/1 55x55 H107	glass, melamine, HPL, metal sheet, metal	● ■
Composit/2 45x45 H73	glass, melamine, HPL, metal sheet, metal	● ■
Composit/2 45x45 H107	glass, melamine, HPL, metal sheet, metal	●
Composit/2 55x55 H73	glass, melamine, HPL, metal sheet, metal	● ■
Composit/2 55x55 H107	glass, melamine, HPL, metal sheet, metal	● ■
Composit/3 diam 45 H73	glass, melamine, HPL, metal sheet, metal	●
Composit/3 diam 45 H107	glass, melamine, HPL, metal sheet, metal	●
Composit/3 diam 55 H73	glass, melamine, HPL, metal sheet, metal	●
Composit/3 diam 55 H107	glass, melamine, HPL, metal sheet, metal	●
Nené	melamine, HPL	●
Sintesy	glass, melamine, HPL, metal sheet, metal	● ■
Liu H73	melamine, HPL, metal sheet, metal	●
Luna H73	melamine, HPL, metal sheet, metal	● ■
Luna H107	melamine, HPL, metal sheet, metal	● ■
Ola/3	melamine, HPL, metal sheet, metal	●
Plissé H73	melamine, laminate, fenix, HPL, metal sheet, metal	●
Smart/1 39x39 H73	melamine, HPL	●
Smart/1 48x48 H73	melamine, HPL	● ■
Smart/2 diam 42 H73	melamine, HPL	●
Smart/2 diam 42 H107	melamine, HPL	●
Smart/2 diam 50 H73	melamine, HPL	●
Square 3G H73	melamine, HPL, metal sheet, metal	●

Fix tables

Model	Tops' materials	Tops' shape
cm 80		
Square 4G H73	melamine, HPL, metal sheet, metal	
Trampoline H73	melamine, HPL, metal sheet, metal	
Trampoline H107	melamine, HPL, metal sheet, metal	
cm 85		
Ola/4	metal sheet	
Nenè	melamine, HPL	 
cm 90		
Armando	metal	
Clessidra	melamine, laminate, fenix, HPL, metal sheet, metal	
Dama 3G H73	melamine, laminate, fenix, HPL, metal sheet, metal	
Dama 3G H103	melamine, laminate, fenix, HPL, metal sheet, metal	
Infinity diam 44	melamine, glass, crystalceramic, fenix, laminate	
Composit/1 45x45 H73	glass, melamine, HPL	
Composit/1 55x55 H73	glass, melamine, HPL	
Composit/1 55x55 H107	glass, melamine, HPL	
Composit/2 45x45 H73	glass, melamine, HPL	
Composit/2 55x55 H73	glass, melamine, HPL	
Composit/2 55x55 H107	glass, melamine, HPL	
Composit/3 diam 55 H73	glass, melamine, HPL	
Plissé H73	melamine, laminate, fenix, HPL, metal sheet, metal	
Sintesy	glass, melamine, HPL	
Ola/3	melamine, HPL	
Smart/1 48x48 H73	melamine, HPL	
Smart/2 diam 50 H73	melamine, HPL	
cm 100		
Infinity diam 70	melamine, glass, crystalceramic	
Clessidra	melamine, laminate, fenix, veneered wood, glass, crystalceramic, marmble	
Composit/2 55x55 H73	glass, melamine, HPL	
Composit/1 55x55 H73	glass, melamine, HPL	
cm 120		
Clessidra	melamine, laminate, fenix, veneered wood, glass, crystalceramic, marmble	
Infinity diam 70	melamine, glass, crystalceramic, fenix, laminate	
Woody	veneered wood, fenix, laminate, crystalceramic, glass	
cm 140		
Akashi	veneered wood, MDF, fenix, laminate, ceramic, glass	
Brioso	glass, veneered	
Dama H73	veneered wood wood, melamine, fenix, laminate, HPL	
Dama H110	veneered wood, melamine, fenix, laminate, HPL	
Nenè	melamine	
Spike	glass	
Woody	veneered wood, fenix, laminate, crystalceramic, glass	
Woody	veneered wood, fenix, laminate, crystalceramic, glass	
cm 150		
Clessidra	veneered wood, crystalceramic	
Forest	veneered wood, crystalceramic	
Plissé	veneered wood, crystalceramic, marble	

Fix tables

Model	Tops' materials	Tops' shape
cm 160		
Akashi,	veneered wood, MDF, fenix, laminate, ceramic, glass	
Armando	metal	
Brioso	glass, veneered wood	
Dama H73	veneered wood, melamine, fenix, laminate, HPL	
Dama H110	veneered wood, melamine, fenix, laminate, HPL	
Woody	veneered wood, fenix, laminate, crystalceramic, glass	
cm 180		
Akashi	veneered wood, MDF, fenix, laminate, ceramic, glass	
Brioso	glass	
Clessidra	veneered wood, crystalceramic	
Plissé	veneered wood, crystalceramic, marble	
Woody	veneered wood, fenix, laminate, crystalceramic, glass	
cm 190		
Master	fenix	
Lea	veneered wood, crystalceramic	
cm 200		
Akashi	veneered wood, MDF, fenix, laminate, ceramic, glass	
Armando	metal	
Dama H73	veneered wood, melamine, fenix, laminate, HPL	
Dama H110	veneered wood, melamine, fenix, laminate, HPL	
Forest	solid wood	
Moonlight	glass, crystalceramic	
Pechino	veneered wood, solid wood, glass	
Spike	veneered wood, crystalceramic, marble	
Zeus	solid wood, veneered wood, glass, crystalceramic	
cm 220		
Gran Sasso	glass, crystalceramic	
Lea	veneered wood, crystalceramic	
Moonlight	glass, crystalceramic	
Nexus	glass, crystalceramic	
Suite	glass, crystalceramic	
cm 250		
Gran Sasso	glass, crystalceramic	
Nexus	solid wood, glass, crystalceramic	 
Pechino	veneered wood, solid wood, glass	 
Suite	glass, crystalceramic	
Zeus	solid wood, veneered wood, glass, crystalceramic	 
cm 280		
Armando	metal	
Forest	veneered wood, crystalceramic	 
Nexus	crystalceramic	 
cm 300		
Akashi	veneered wood, MDF, fenix, laminate, ceramic, glass	
Clessidra	melamine, laminate, fenix, veneered wood, glass, crystalceramic, marble	

Extendable tables

Model	Tops' materials	Tops' shape
cm 100		
Badù	melamine, glass, crystalceramic	
More	melamine, glass, crystalceramic	
cm 110 XL		
Badù	melamine, glass, crystalceramic	
Blade	melamine, fenix, glass, crystalceramic	
More	melamine, fenix, glass, crystalceramic	
cm 120		
Badù	melamine, glass, crystalceramic	
Blade	melamine, fenix, glass, crystalceramic	
Diamante	melamine, glass, crystalceramic	
Link	veneered wood, crystalceramic	
More	melamine, fenix, glass, crystalceramic	
Paul	veneered wood, crystalceramic	
Woody	veneered wood, fenix, laminate, crystalceramic, glass	
cm 140		
Apollo	melamine, MDF, veneered wood, glass, crystalceramic	
Badù	melamine, MDF, fenix, glass, crystalceramic	
Blade	melamine, MDF, fenix, veneered wood, glass, crystalceramic	
Diamante	melamine, MDF, glass, crystalceramic	
Marcopolo	glass, crystalceramic	
Master	fenix	
More	melamine, MDF, fenix, veneered wood, glass, crystalceramic	
Woody	veneered wood, fenix, laminate, crystalceramic, glass	
Woody	veneered wood, fenix, laminate, crystalceramic, glass	
cm 160		
Akashi	veneered wood, fenix, laminate	
Alexander	glass, crystalceramic	
Alfred	glass, crystalceramic	
Apollo	melamine, MDF, veneered wood, glass, crystalceramic	
Badù	veneered wood, medf, melamine, fenix, laminate, crystalceramic, glass, fenix, laminate	
Blade	melamine, MDF, veneered wood, fenix, glass, crystalceramic	
Diamante	melamine, MDF, glass, crystalceramic	
Marcopolo	glass, crystalceramic	
Master	fenix	
More	veneered wood, MDF, melamine, fenix, laminate, crystalceramic, glass	
Pechino	glass	
Woody	veneered wood, fenix, laminate, crystalceramic, glass	

Extendable tables

Model	Tops' materials	Tops' shape
cm 180		
Woody	veneered wood, fenix, laminate	
cm 190		
Apollo	glass, crystalceramic	
Pechino	glass	
Diamante	melamine, glass, crystalceramic	
cm 200		
Akashi	veneered wood, fenix, laminate	
Alexander	glass, crystalceramic	
Alfred	glass, crystalceramic	
Forest	glass, crystalceramic	
Zeus	veneered wood	

Introduction

This Midj price list is a descriptive tool containing the information necessary for the formulation of orders. Here are just a few important instructions to facilitate consultation.

Product description and finishes

The products are described in the finishes and materials with which they can be made shown in the materials section of our catalog and price list. Customer finishes, if technically practicable, can be supplied on request with a minimum surcharge of 5%.

Information on the stackability of the products is shown (where possible).

The seat heights indicated in the price list and catalog refer to the maximum height measured in the center of the seat.

Prices

Each item corresponds to a code number and an extension (eg: _N) that identifies the basic type. For each item and basic type, the VAT excluded prices are shown, for the available upholstery classes. Any increases are shown in the lower section of each item.

Order confirmation

The confirmation of the order can be made by us only after the complete clarification of the order: therefore samples, fabrics or customer leathers and other important indications must reach us in advance. The delivery term starts from the receipt of the acceptance of the order proposal and/or from the receipt of COM/COL materials. The execution process of all orders will follow our General Conditions of Sale.

Upholstery - Fabrics

Fabric consumption

The fabric consumption for each item is expressed in linear meters and is valid for fabrics of height 140 cm cm, solid color and not velvet type. The consumptions indicated refers only to the fabrics present in our box material.

Customer fabrics and leathers

The fabrics and leathers sent by customers must comply with the following regulations:

- The customer's fabric is available for minimum quantities of 6 pieces.
- In case of quantities of less than 6 pieces in COM/COL, a surcharge of Euro 150 will be applied.
- Before accepting any order in COM/COL, Midj may request a fabric sample for a prior feasibility assessment (minimum sample size 15x15cm). If the preli-

minary test is not exhaustive, Midj may request additional material for a whole sample production. During the production process, if there are difficulties in realization, due to the technical characteristics of the material, it may be necessary to request additional meters and delivery date could be postponed.

- Midj will not be in any way responsible for the appearance, durability, color brightness or any other issues related to the COM/COL material provided by the client.
- Midj's liability in relation to the goods in COM/COL is limited to any defects directly attributable to Midj's production.
- Custom's fabrics or leathers must arrive to our company provided with a transport document or invoice and the "Customer fabric-leather delivery form" shown below, completed in its entirety, specifying the side and direction for the application on the items. In the absence of this important mark, the order will not be produced.
- The fabric sent to us by customers must arrive at our company free of charge and, if coming from countries that are not EEC members, accompanied by the certificate of origin, which is essential for customs clearance in Italy. Any transport and / or customs costs incurred by us will be charged on the invoice.
- In the case of customer fabric with design connection, please send a photo of the fabric and tell us the exact position, in order to provide you with the actual consumption.
- For each roll of customer fabric shipped to us we require the mandatory addition of 1 m of extra fabric for initial testing.
- COL-customer leather: the leather sent to us must be suitable for upholstering small sized chairs and must have a thickness between 0.8 / 1.1 mm. Otherwise, a surcharge of € 10,00 / sqm is applied for extra work to be carried out before upholstery.
- Consumption per customer leather must be requested in advance to the Midj sales office.
- In the case of orders with custom's fabric in odd quantities, the consumption must be calculated as that necessary for the immediately higher unit. Example, for an order of 9 chairs, the material needed should be calculated for 10.
- For quantities over 10 pcs check consumption with the Midj sales office.
- Light colours do not have to be in contact with fabrics or clothes treated with colour addicts not fixed (for example jeans and its derivatives) or with not solid colour treatment, in order to avoid any colour spots and glows for which we CANNOT grant cleaning.

General terms of sale

Premises

These general terms of sale, together with the special terms specified in each Order Confirmation, regulate the purchase and sale agreement between Midj S.p.A. (hereinafter called Midj for short) and the purchaser (hereinafter called the Purchaser for short). The general terms of sale are an essential and integral part of the agreement and are intended to be fully accepted by the Purchaser when Midj transmits its ORDER CONFIRMATION.

Clause 1: Price list and validity

The prices specified on the attached price list, in euros, are gross (before discounts) and do not include VAT; standard packaging for products is included in the prices. The price list indicated herein are the recommended retail prices plus the applicable VAT of each Country. The price list cancels and replaces the previous one.

Clause 2: Changes to the price list

Without giving prior notice, Midj reserves the right to vary the prices and/or products specified on the price list. These changes in prices and/or products shall immediately apply as soon as the Purchaser is informed.

Clause 3: Purchase orders

The custom must send purchase orders to Midj in writing, indicating the identification code of the selected goods, the model, the quantity, the finishes and the dimensions. Midj reserves the right to accept or reject the order by sending written confirmation. Acceptance of an order is called "Order Confirmation". No purchase order can be canceled or modified after sending the "Order Confirmation".

Art. 4 Order changes

Changes to an order are to be understood as decreases in quantity, changes in articles, or variations in the finishes of an article. It is possible to request the modification of an order within 24 hours from the confirmation of the "Order Proposal", once the "Order Confirmation" document has been received, no changes will be allowed. In case of changes, the delivery times will start from the date of modification. The increase in quantities is considered a new order, the delivery date will start from the confirmation of the same. It will not be possible to accept more than one change for each order. Any changes to the delivery address upon sending the order confirmation subsequent to the order will be charged € 100 net.

Clause 5: Cancellation/Suspension of a purchase order

A purchase order cannot be canceled, suspended or postponed without Midj written consent. Any acceptations will be conditioned by the issue of an economic compensation that will take into consideration the costs incurred, the time provided, the use of the equipment and facilities and any further services rendered.

Clause 6: Delivery terms Goods are delivered "Ex-works Midj" (according to the current INCOTERMS). Any other term of delivery requested by the Purchaser shall require written authorization from Midj, and stated on the Order Confirmation or other document. It is mandatory for the number of pieces included in the packaging to be specified at the side of each model from the price list. Any periods of goods storage in Midj warehouse, beyond the period agreed, will be charged on invoice. The Purchaser therefore explicitly accepts that orders, when made for an odd

number of a product packed as an even number, shall be automatically increased to the next even number.

Clause 7 Terms of payment

Payment shall be made by the Purchaser, without any extra charges requested, in compliance with the terms specified on the Order Confirmation. For any delay in payment, Midj shall debit interest on arrears according to the provisions of Legislative Decree nr. 231/2002. Midj reserves the right to suspend all supplies of goods in any case of default even partial, of the agreed terms of payment on the part of the Purchaser. Moreover, Midj reserves the right to change any previously agreed payment terms, without any liability or any right.

Clause 8: Outdoor products

The products marked with the specific symbol are suitable for outdoor use. It should be noted that Midj uses three types of materials for products suitable for outdoor use: polypropylene, aluminum and steel treated with cataphoresis and powder coating. Each material responds differently to exposure to UV rays, chloride and salinity. Areas characterized by high humidity, such as near lakes and coastal areas favor chemical condensation and, due to the saline concentration naturally present in the atmosphere, the exposure of the steel or aluminum parts generates corrosive phenomena which progressively spread. In any case, it is advisable to evaluate with our team the most suitable type of material for the place of destination. It is always recommended to store it in a protected room in case of long periods of inactivity (≥ 3 months). Terraces, porches, patios and verandas, spas and locations near the sea are to be considered outdoor environments, even if covered and/or not directly exposed to atmospheric agents.

Clause 9: Shipment and transport terms

The date of preparation of the ordered products is indicated in the "Order Confirmation" document and is to be considered indicative. A delay shall not constitute a justifiable reason for cancelling an order or for any type of compensation and/or indemnity, unless otherwise agreed between the parties. Orders shall not be changed or cancelled later than 1 days after being confirmed by Midj. In the event of cancellation, an amount shall be charged equal to 20% of the value of the accepted order. Any damage to goods due to transport or any differences in quantity/quality to those specified on the delivery note must be reported at the time of unloading and indicated on the delivery note. Failing this, Midj shall not replace any delivered goods which have been damaged due to transport or which are incorrect.

Clause 10 Packaging

The packaging made by Midj is suitable for the transport of goods by road; the cardboard boxes must always be handled keeping the side indicated. Where possible, out standard packaging is allowed on request with a net charge of €20 for each package. Any specific packaging for transport by air must be specified at the time of the order. The supplement for special packaging is €50 net per pallet. Also, in case of need for a pallet compliant with the FAO ISPM 15 protocol, the request must be made at the time of the order and provides for a supplement of € 25 net for each pallet.

Clause 11: Customer fabrics and leathers

Fabrics and leathers sent by the customers must be provided with detailed documentation, which highlights materials specifications, Midj PO reference, as well as the technical specifications indicated in the "Introduction" section. In the absence of this important document, the order will not be processed. Materials sent to us by the customers have to be delivered to our company in free port terms and, if coming from extra-CEE countries, they have to arrive with the certificate of origin, which is mandatory for clearance in Italy. Any transport/clearance costs, that we will afford, will be charged on invoice.

Clause 12 Claims and warranty

The product warranty only covers the total replacement of the product or faulty parts due to manufacturing defects that are directly attributable to Midj. Any claims concerning the packaging, quantity, number or external characteristics of products (apparent defects), must be communicated to Midj by email together with photographic material, under penalty of forfeiture, within eight days of the date of receiving the goods. Any claims concerning defects that cannot be identified by examination at the time of delivery (non-visible defects) must be communicated to Midj by email together with photographic material, under penalty of forfeiture, within eight days of the date the defect was discovered, and in any case, no later than 12 (twelve) months after delivery. The warranty does not include any defects in the product caused by incorrect assembly, improper use or any use other than its intended use, non-observance of the use and maintenance instructions, or wear and tear. Any claim, dispute or allegation not ascribable to product defects may only be deemed valid if communicated in writing to Midj within eight days of the date of receiving the related invoice.

Clause 13: Returned goods

No returns shall be accepted unless previously communicated in writing and explicitly authorized in writing by Midj. Any returned goods must be returned, at the very latest, within 60 days of the approval given by Midj. Returns must only be made using vehicles sent by Midj and accompanied by a related document authorizing their return. It must be pointed that carriers may only be used upon prior written authorization from Midj. If the goods to be returned are not made available for collection twice running when the vehicle sent by Midj arrives, any authorization given for their return shall be cancelled and any goods sent as replacements shall be duly paid. When goods are returned, Midj shall immediately check their condition and, in the event of damage not ascribable to Midj, the value of individual pieces shall not be considered. If the goods are damaged, due to the absence of their original packaging (or any packaging required to keep the goods intact during transport), Midj shall be entitled to charge the Purchaser any costs required for repairs, or may not accept the goods. When goods are returned, a credit note shall be issued, which, in any case, shall be based on the prices of the specific invoice, for which details must be strictly specified on the delivery note for the returned goods. Any goods sent as replacements shall be duly invoiced. If the replaced goods are not returned within 60 days, Midj shall refuse to collect them and shall issue a bank order for full payment. In the event of non-payment, Midj reserves the

right to suspend deliveries as specified in CLAUSE 7 above. For replacements under warranty which involve returns, Midj reserves the right to invoice the goods sent as replacements if no manufacturing defects ascribable to Midj are found in these returned goods. The value of the returned goods shall not be compensated with the value of the goods to be delivered.

Clause 14: Samples allowance

The colors of the photographic materials in the present list, in catalogs and in the material samples, are indicative as it is technically impossible to reproduce the tones and finishes. Midj disclaims any responsibility for color matching requests with previously purchased articles.

Clause 15: Technical data, use and product maintenance sheet

In compliance with Italian Law nr.126 of 10/04/91 and Ministerial Decree nr.101 of 08/02/97, Midj provides a "Technical Sheet" in all its packages, which must be visible on all goods displayed. Midj shall not be held liable for any non-observance of this obligation on the part of the Purchaser.

Clause 16: Retention of title

It is agreed that delivered products shall remain the property of Midj until full payment of the price has been made by the Purchaser, even when any of the original delivered goods have been customized, finished and/or altered.

Art. 17: Sales conditions

The retailer can sell the products only through the points of sale indicated in the order confirmation. The resale of Midj products through retailers located in places other than those indicated in the order is subject to authorization from Midj, and has to be received in writing. In the event that a reseller decides to start the sale via e-commerce or via internet, he must notify Midj in writing and undertake to comply with the online sales policy and the criteria indicated by Midj.

Article 18: Online sales

Selling products via e-commerce or website must always be requested and authorized in writing by Midj. The domain name or names used must always be included in the request. Resale on third party marketplaces is expressly prohibited. The reseller is not allowed to register any domain name containing Midj brand or logo. The online e-commerce sales must be designed and developed in a workmanlike manner with a professional front-end result, and must be kept up to date from a technical point of view. Visitors should clearly acknowledge that this is a dealer site and not the official Midj site. The site must necessarily include information on the retailer, complete with legal information, privacy policy, sales conditions, contacts. The retailer undertakes to keep the contents relating to Midj products updated and to intervene promptly in the removal of items whose production has been discontinued, and to update materials and price list.

Clause 19: Court of jurisdiction

Any dispute arising from the interpretation and execution of the purchase and sale contract governed by these general terms of sale shall be settled by the Court of Pordenone.

However, Midj reserves the right to choose the Court where the Purchaser has its legal offices and /or its main offices.

C.O.M. and C.O.L. delivery form

Customer: _____

Shipping date: _____

Order nr. or Proforma Invoice nr: _____

Customer reference: _____

Model name to be upholstered: _____

Name of leather or fabric manufacturer: _____

Name of fabric or leather collection: _____

Color: _____

Quantity: _____

Special instructions for cutting and upholstery: _____

- A) Solid color fabric
- B) Fabric with horizontal orientation
- C) Fabric with vertical orientation
- D) Patterned fabric

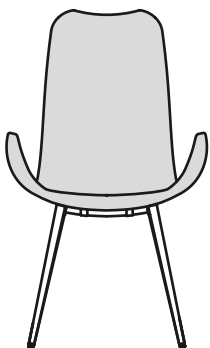

A

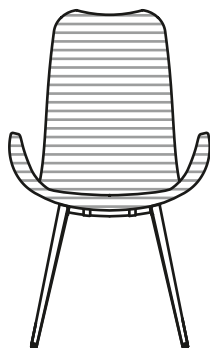

B

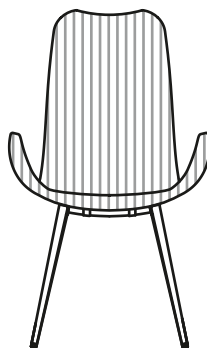

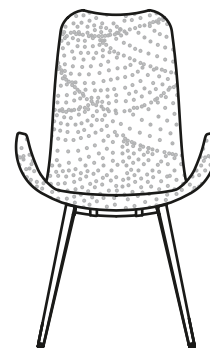

C



D

Please send the materials to the following address:
Midj warehouse, Via Guglielmo Marconi 39 - 33079 Ramuscello di Sesto al Reghena (PN) - Italy
Tel +39 0434 690122

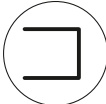
Table tops

	Models available	thickness	edge
HPL			
ø60	Composit h75-h110 Smart h75-h110 Break 3-4, Infinity Italia Trampoline h75-h110	cm 1	
ø70	Composit h75-h110 Smart h75-h110 Break 3-4 Infinity Italia Trampoline h75	cm 1	
ø79,2	Composit h75 Smart h75 Break 4 Infinity Four	cm 1	
60x60	Composit h75-h110 Smart h75-h110 Italia Sintesy	cm 1	
70x70	Composit h75-h110 Smart h75-h110 Italia Sintesy	cm 1	
79,2x79,2	Composit h75 Smart h75 Four Sintesy	cm 1	
MELAMINE			
ø60	Composit h75-h110 Smart h75-h110 Break 3-4 Infinity Italia Trampoline h75-h110	cm 1,8/2	
ø70	Composit h75-h110 Smart h75-h110 Break 3-4 Infinity Italia Trampoline h75	cm 1,8/2	
ø80	Composit h75 Smart h75 Break 4 Infinity Four	cm 1,8/2	
ø100	Infinity	cm 1,8/2	
ø120	Infinity	cm 1,8/2	
60x60	Composit h75-h110 Smart h75-h110 Italia Sintesy	cm 1,8/2	
70x70	Composit h75-h110 Smart h75-h110 Italia Sintesy	cm 1,8/2	
80x80	Composit h75 Smart h75 Four Sintesy	cm 1,8/2	
GLASS			
ø60	Composit h75-h110 Face H75-H110 Infinity	cm 1	
ø80	Composit h75 Face H75 Infinity	cm 1	
ø100	Infinity	cm 1	
ø120	Infinity	cm 1	

Legend of the icons

weight of

the packed product in Kg



quantity per box



box volume in m3



n° boxes



COM consumption



COL consumption



to assemble



stackable



swivel chair



swivel and adjustable chair



outdoor finish



finish suitable for seaside area



tested product



certification IIM





fire retardant

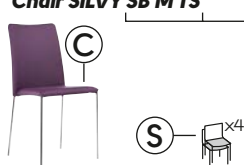

A **Silvy SB, SBR; SA, SAR - Shell in hide, fabric or leather** **B**
 Frame in: metal or upholstered **B**

A Model	Cod.	E Mod.	Frame	G Shell								Optional	Q.tà	colli	Kg	M³	
				TA	TB	TC	TD	TE	SF	SV	COM						COL
Chair SILVY SB M TS			F MI	203 €	222 €	266 €	293 €	391 €	299 €	354 €	203 €	266 €	FM-M3 ES-1	2	1	9.0	0.33
	S1490MT	SB															

H **COM/COL - Minimum Q.ty 6 pc. for each material. For weft or patterned fabrics see specific pages**

COM 	Mtl. 1.00 h. 1.40 Each	P	COL 	Mq. 1.65 Each
---	------------------------	----------	---	---------------

Frame finishes

Metal

MI WHITE **BB**, BROWN **E6**, SAND **EC**, GRAPHITE **EG**, BLACK **EN**

Shell finishes

Upholstery

TA FAUX LEATHER **Secret**, FABRIC **Mirage**, FABRIC **Cotton Club**

TB FAUX LEATHER **Vintage**, FABRIC **Fenix Wool**, FABRIC **Novabuk**, FABRIC **Manhattan**, FABRIC **Visual**

TC VELVET SUPERB, FABRIC **Second**, FABRIC **Main Line Flax**, FABRIC **Oceanic**

TD FABRIC **Yoredale**, FABRIC **Remix 3**

TE FABRIC **Uniform Melange**

SF LEATHER **Fiore**

SV LEATHER **Vintage**

CU HIDE

Optionals:

		Valore	Opzioni/Note
FM-M3	Indoor glossy metal M3	+ 20 €	CHROME CC
ES-1	Fireproof foam	+ 7 €	ES-1

Silvy SB

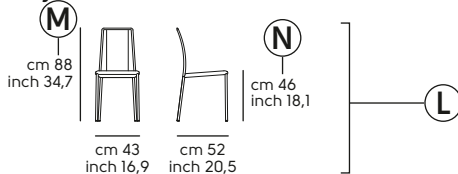

- A** model name
- B** model description
- C** image of model
- D** code article
- E** model / frame type
- F** frame finishes
- G** shell finishes
- H** prices
- I** optionals codes
- L** drawing with dimensions in cm/inch
- M** total height
- N** seat height
- O** packaging data
- P** COM/COM information
- Q** standard finishes variants
- R** optional descriptions and increases
- S** additional icons

Table Diamante
Frame in: metal

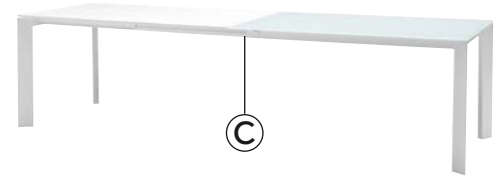

A	Version	Cod.	Legs	Frame	G	Top and extensions	Optional	Q.tà	colli	Kg	M³
	Diamante Laminato										
	Top and extensions 19 mm thk.										
		D				HLO					
	120/170 x80	T0160120				1.566 €		1	4	61.0	0.28
	140/190 x90	T0160140	M1	M1		1.676 €	FM-M2	1	4	81.0	0.35
	160/210/260 x90	T0160160				1.886 €		1	5	94.0	0.41

Note: For Glass or Crystal Ceramic tops, extensions ONLY in matching lacquered MDF - 190/240/290x100 FT extensions in Ceramic

Frame finishes

Metal	
MI	WHITE BB , BROWN E6 , SAND EC , GRAPHITE EG , BLACK EN

Legs finishes

Metal	
MI	WHITE BB , BROWN E6 , SAND EC , GRAPHITE EG , BLACK EN

Top and extensions finishes

Melamine	
HLI	WHITE M01 , GRAFITE M02 , BLACK M04 , SAND M07

Laminate	
HLO	BLUE LBB , GRAFITE GREY LGD , ASH GREY LGS , CHERRY RED LRC , RED BULGARO LRS , SAND LS2

Optionals:			
	Valore	Opzioni/Note	
FM-M2	Indoor matt metal M2	+ 166 €	ASH GREY ES , BRONZE E2 , BULGARO RED FP , CHERRY RED EQ , DARK GREEN EL , FACEPOWDER PINK E8 , FANGO E3 , GOLDEN YELLOW EO , LIGHT BLUE E0 , LIGHT GREY ET , OCEAN BLUE E1 , OCHER YELLOW E7 , PAPAYA ORANGE EA , PASTEL YELLOW E4 , PINE GREEN EJ , RED ER , SAGE GREEN E9

120/170 x80

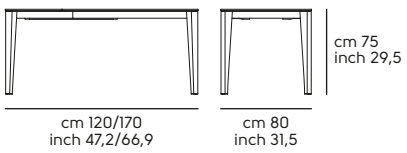

140/190 x90

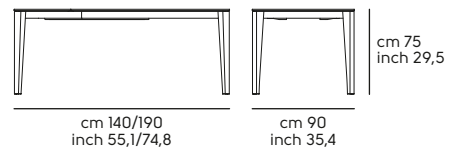

160/210/260 x90

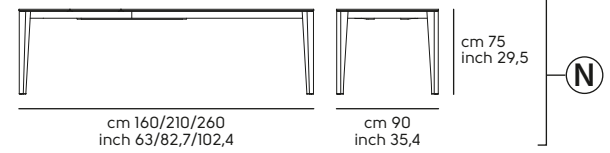

- (A) model name
- (B) model description
- (C) image of model
- (D) code article
- (E) legs finish
- (F) frame finishes
- (G) top finishes
- (H) prices
- (I) packaging data
- (L) frame finishes variants
- (M) top and extensions finishes
- (N) drawing with dimensions in cm/inch

Frame Liù

Frame in: metal-wood. Top NOT included

Version	Cod.	H	Legs	Metallic insert	Optional	Q.tà	colli	Kg	M ³	
										M1
LIU' ML H 40 Top Max 60x60 - Ø 70	T1285B04	H. 40	LF1	203 €	242 €	PD-F0	1	1	4.0	0.08



Legs finishes

Wood

LF1 Ash wood painted GREY **F02**, Ash wood painted GRAFITE GREY **F03**, Ash wood painted BLACK **F04**, Ash wood painted WHITE **F05**, Ash wood painted BLUE **F06**, Ash wood painted RED **F08**, Ash wood painted CHERRY RED **F09**, Ash wood painted FLAMED WALNUT **F24**, Ash wood painted DARK BROWN **F26**, Ash wood painted NATURAL **F40**, Ash wood painted NATURAL OAK **F52**

Insert finishes

Metal

M1 WHITE **BB**, BROWN **E6**, SAND **EC**, GRAPHITE **EG**, BLACK **EN**

M2 LIGHT BLUE **E0**, OCEAN BLUE **E1**, BRONZE **E2**, FANGO **E3**, PASTEL YELLOW **E4**, OCHER YELLOW **E7**, FACEPOWDER PINK **E8**, SAGE GREEN **E9**, PAPAYA ORANGE **EA**, PINE GREEN **EJ**, DARK GREEN **EL**, GOLDEN YELLOW **EO**, CHERRY RED **EQ**, RED **ER**, ASH GREY **ES**, LIGHT GREY **ET**, BULGARO RED **FP**

Optionals:

	Valore	Opzioni/Note
PD-F0 Felt pad feet	+ 6 €	PD-F0

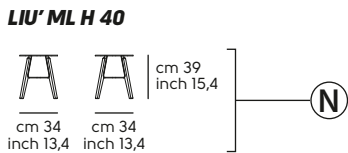

- (A)** model name
- (B)** model description
- (C)** image of model
- (D)** code article
- (E)** legs finish
- (F)** finishes
- (G)** prices
- (H)** optionals code
- (I)** packaging data
- (L)** standard finishes variants
- (M)** optionals description and increases
- (N)** drawing with dimensions in cm/inch

(A)
Top metal

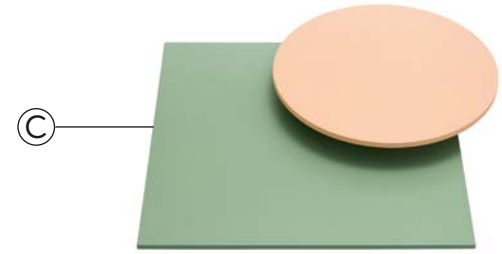

(B) Version	Cod.	Thickness	Finish (F)				Optional	Q.tà	coll.	Kg	M ³
Square Metal Top											
	(D)		M1	M2	O1	O2					
Top Ø 60	TT15LD06	1.5	133 €	161 €	161 €	189 €		1	1	5.0	0.04
Top Ø 70			TT15LD07	160 €	190 €	188 €	216 €	1	1	6.5	0.05
Top Ø 80			TT15LD08	225 €	254 €	254 €	280 €	1	1	9.5	0.07

Note:
NOT AVAILABLE in Industrial E5 finish

Top finishes

Metal

M1	WHITE BB , INDUSTRIAL E5 , BROWN E6 , SAND EC , GRAPHITE EG , BLACK EN
M2	LIGHT BLUE E0 , OCEAN BLUE E1 , FANGO E3 , PASTEL YELLOW E4 , OCHER YELLOW E7 , FACEPOWDER PINK E8 , SAGE GREEN E9 , PAPAYA ORANGE EA , PINE GREEN EJ , DARK GREEN EL , GOLDEN YELLOW EO , CHERRY RED EQ , RED ER , ASH GREY ES , LIGHT GREY ET , BRONZE EZ + TRANSP., BULGARO RED FP

Outdoor Metal

O1	Outdoor BROWN E6 , Outdoor WHITE BB , Outdoor SAND EC , Outdoor GRAFITE EG , Outdoor BLACK EN
O2	Outdoor LIGHT BLUE E0 , Outdoor OCEAN BLUE E1 , Outdoor FANGO E3 , Outdoor PASTEL YELLOW E4 , Outdoor OCHER YELLOW E7 , Outdoor FACEPOWDER PINK E8 , Outdoor SAGE GREEN E9 , Outdoor PINE GREEN EJ , Outdoor DARK GREEN EL , Outdoor GOLD YELLOW EO , Outdoor RED BULGARO FP , Outdoor CHERRY RED EQ , Outdoor RED ER , Outdoor ASH GREY ES , Outdoor LIGHT GREY ET , Outdoor PAPAYA ORANGE EA , Outdoor BRONZE EZ +TRANSP.

(A) model finish

(B) model name

(C) image of model

(D) code article

(E) prices

(F) finishes

(G) dimensions

(H) packaging data







(I) finishes variants

Chairs

Apelle design Beatriz Sempere

Apelle S, P, DS, DP, H65-75 - Shell in hide

Frame in: metal

Model	Code	Mod.	Frame	Shell		Optional	Q.ty	boxes	Kg	M ³
				CU	CT					
Chair Apelle S M CU 	S1000S0	S	M1	420 €	629 €	FM-M2 FM-M3 FM-M4	2	1	13.0	0.41
Armchair APELLE P M CU 	S1000P0	P	M1	471 €	680 €	FM-M2 FM-M3 FM-M4	1	1	9.0	0.3
Office Chair APELLE DS CU 	S1000D0	DS	M1	593 €	790 €	FM-M2	1	1	10.5	0.31
Office Arm. APELLE DP CU 	S1000E0	DP	M1	655 €	849 €	FM-M2	1	1	11.0	0.33
Stool APELLE H65 M CU 	S1000H0	H65	M1	500 €	697 €	FM-M2 FM-M3 FM-M4	1	1	8.5	0.29
Stool APELLE H75 M CU 	S1000J0	H75	M1	512 €	715 €	FM-M2 FM-M3 FM-M4	1	1	9.0	0.31

Frame finishes

Metal

M1 WHITE **BB**, INDUSTRIAL **E5**, BROWN **E6**, SAND **EC**, GRAPHITE **EG**, BLACK **EN**

Shell finishes

Upholstery

CU HIDE

CT TUSCAN HIDE

Optionals:

		Value	Options/notes
FM-M2	Indoor matt metal M2	+ 58 €	ASH GREY ES , BRONZE E2 , BULGARO RED FP , CHERRY RED EQ , DARK GREEN EL , FACEPOWDER PINK E8 , FANGO E3 , GOLDEN YELLOW EO , LIGHT BLUE EO , LIGHT GREY ET , OCEAN BLUE E1 , OCHER YELLOW E7 , PAPAYA ORANGE EA , PASTEL YELLOW E4 , PINE GREEN EJ , RED ER , SAGE GREEN E9
FM-M3	Indoor glossy metal M3	+ 32 €	CHROME CC
FM-M4	Indoor glossy Metal M4	+ 142 €	BLACK NICKEL DZ , CHAMPAGNE GOLD DG , GOLDEN BRONZE DB , MATT BLACK NICKEL DY , MATT GOLDEN BRONZE DC , PINK GOLD DR

Apelle S

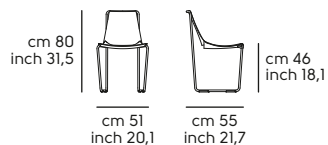

Apelle P

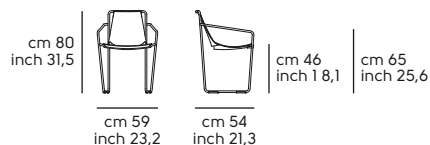

Apelle DS

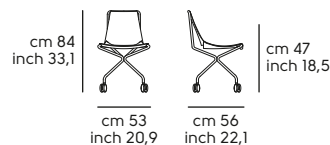

Apelle DP



Apelle H65

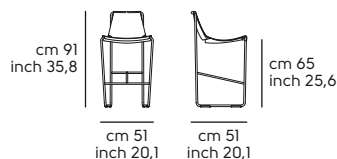



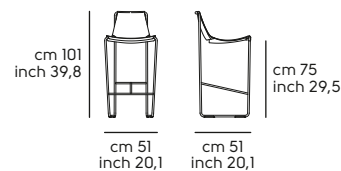



Apelle H75



Apelle Jump H45-65-75 - Seat in hide, fabric or leather

Frame in: metal

Model	Code	Mod.	Frame	Shell		Optional	Q.ty	boxes	Kg	M³
				CU	CT					
	S1000G1	J45	M1	235 €	278 €	FM-M2 FM-M4	1	1	4.0	0.1
	S1000H1	J65	M1	268 €	312 €	FM-M2 FM-M4	1	1	5.0	0.15
	S1000J1	J75	M1	288 €	335 €	FM-M2 FM-M4	1	1	6.0	0.18

Model	Code	Mod.	Frame	Shell								Optional	Q.ty	boxes	Kg	M³	
				TA	TB	TC	TD	TE	SF	SV	COM						COL
	S1000G1	J45	M1	200 €	205 €	215 €	223 €	267 €	226 €	246 €	200 €	215 €	FM-M2 FM-M4	1	1	5.0	0.1
	S1000H1	J65	M1	230 €	235 €	246 €	254 €	296 €	256 €	276 €	230 €	246 €	FM-M2 FM-M4	1	1	7.0	0.15
	S1000J1	J75	M1	242 €	255 €	267 €	266 €	309 €	277 €	298 €	242 €	267 €	FM-M2 FM-M4	1	1	7.5	0.18



Frame finishes

Metal	
MI	WHITE BB , INDUSTRIAL E5 , BROWN E6 , SAND EC , GRAPHITE EG , BLACK EN

Seat finishes

Upholstery			
TA	FAUX LEATHER Secret , FABRIC Mirage , FABRIC Cotton Club	TB	FAUX LEATHER Vintage , FABRIC Fenix Wool , FABRIC Novabuk , FABRIC Manhattan , FABRIC Visual
TC	VELVET SUPERB, FABRIC Second , FABRIC Main Line Flax , FABRIC Oceanic	TD	FABRIC Yoredale , FABRIC Remix 3
TE	FABRIC Uniform Melange	SF	LEATHER Fiore
SV	LEATHER Vintage	CU	HIDE
CT	TUSCAN HIDE		

COM/COL - Minimum Q.ty 6 pc. for each material. For weft or patterned fabrics see specific pages

 COM	Mtl. 0.50 h. 1.40 Each	 COL	Mq. 0.40 Each
--	------------------------	--	---------------

Optionals:

		Value	Options/notes
FM-M2	Indoor matt metal M2	+ 58 €	ASH GREY ES , BRONZE E2 , BULGARO RED FP , CHERRY RED EQ , DARK GREEN EL , FACEPOWDER PINK E8 , FANGO E3 , GOLDEN YELLOW EO , LIGHT BLUE EO , LIGHT GREY ET , OCEAN BLUE E1 , OCHER YELLOW E7 , PAPAYA ORANGE EA , PASTEL YELLOW E4 , PINE GREEN EJ , RED ER , SAGE GREEN E9
FM-M4	Indoor glossy Metal M4	+ 142 €	BLACK NICKEL DZ , CHAMPAGNE GOLD DG , GOLDEN BRONZE DB , MATT BLACK NICKEL DY , MATT GOLDEN BRONZE DC , PINK GOLD DR

Apelle J45

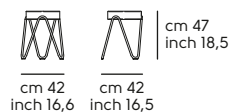

Apelle J65

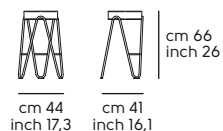

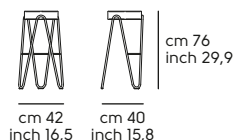

Apelle J75



Apelle Lounge AT, DNB, CL - Shell in hide

Frame in: metal

Model	Code	Mod.	Frame	Shell		Optional	Q.ty	boxes	Kg	M³
				CU	CT					
Waiting Chair APELLE AT M CU 	S1000AC	AT	MI	741 €	1.164 €	FM-M2 FM-M3 FM-M4	1	1	10.0	0.54
Rocking APELLE DNB M CU 	S1000RO	DN	MI	805 €	1.306 €	FM-M2 FM-M3	1	1	10.5	0.63
Lounge APELLE CL M CU Senza Cuscino 	S1000LO	CL	MI	1.233 €	1.873 €	FM-M2 FM-M3 FM-M4	1	1	20.0	0.85

Note:

Lounge APELLE CL M CU available only in CT Fiore Tuscan leather

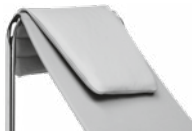
Model	Cod.	--	--	Upholstery	Optional	Q.tà	colli	Kg	M³
				SF					
Cushion APELLE CUSHION 	A1000QO			122 €		1	1	3.0	0.028

Frame finishes

Metal

MI WHITE BB, INDUSTRIAL E5, BROWN E6, SAND EC, GRAPHITE EG, BLACK EN

Shell finishes

Upholstery

CU HIDE

CT TUSCAN HIDE

Cushion finishes

Upholstery

SF LEATHER Fiore

Optionals:

	Value	Options/notes
FM-M2 Indoor matt metal M2	+ 71 €	ASH GREY ES , BRONZE E2 , BULGARO RED FP , CHERRY RED EQ , DARK GREEN EL , FACEPOWDER PINK E8 , FANGO E3 , GOLDEN YELLOW EO , LIGHT BLUE E0 , LIGHT GREY ET , OCEAN BLUE E1 , OCHER YELLOW E7 , PAPAYA ORANGE EA , PASTEL YELLOW E4 , PINE GREEN EJ , RED ER , SAGE GREEN E9
FM-M3 Indoor glossy metal M3	+ 149 €	CHROME CC
FM-M4 Indoor glossy Metal M4	+ 271 €	BLACK NICKEL DZ , CHAMPAGNE GOLD DG , GOLDEN BRONZE DB , MATT BLACK NICKEL DY , MATT GOLDEN BRONZE DC , PINK GOLD DR

Apelle AT

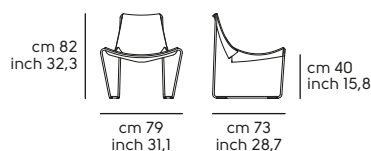

Apelle DN

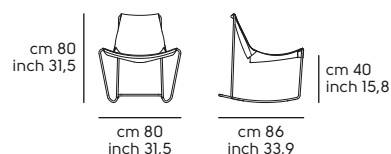

Apelle CL

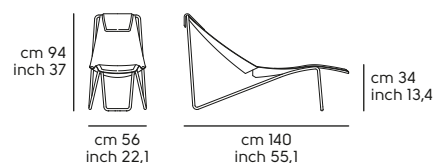

Area design Studio Pastina



Area - Seat and back in fabric

Frame in: metal

Model	Code	Mod.	Frame	Seat and Backrest								Optional	Q.ty	boxes	Kg	M ³	
				TA	TB	TC	TD	TE	SF	SV	COM						COL
 Pouf AREA B1 M TS	S2090B1	B1	M1	700 €	733 €	815 €	874 €	993 €	1.050 €	1.191 €	815 €	815 €	FM-M2 ES-1 PD-F0	1	1	15.0	0.35

Note:



For C.O.M. Min. Qty 5 Pc. - Extra Charge for Fire-Retardant foam (ES-1) Euro 89

 Mtl. 1.56 h. 1.40 Each	 Mq. 2.80 Each
--	---

Model	Code	Mod.	Frame	Seat and Backrest								Optional	Q.ty	boxes	Kg	M ³	
				TA	TB	TC	TD	TE	SF	SV	COM						COL
 Pouf AREA B2 M TS	S2090B2	B2	M1	933 €	989 €	1.127 €	1.225 €	1.408 €	1.566 €	1.791 €	1.127 €	1.127 €	FM-M2 ES-1 PD-F0	1	1	27.0	0.657

Note:

For C.O.M. Min. Qty 5 Pc. - Extra Charge for Fire-Retardant foam (ES-1) Euro 133

 Mtl. 2.58 h. 1.40 Each	 Mq. 4.40 Each
--	---

Model	Code	Mod.	Frame	Seat and Backrest								Optional	Q.ty	boxes	Kg	M ³	
				TA	TB	TC	TD	TE	SF	SV	COM						COL
 Armchair AREA P M TS	S2090DVI00	P	M1	995 €	1.054 €	1.200 €	1.305 €	1.514 €	1.610 €	1.866 €	1.200 €	1.200 €	FM-M2 ES-1 PD-F0	1	1	22.0	0.477

Note:



For C.O.M. Min. Qty 5 Pc. - Extra Charge for Fire-Retardant foam (ES-1) Euro 133

 Mtl. 2.76 h. 1.40 Each	 Mq. 5.00 Each
--	---

Model	Code	Mod.	Frame	Seat and Backrest								Optional	Q.ty	boxes	Kg	M³	
				TA	TB	TC	TD	TE	SF	SV	COM						COL
 Armchair AREA P_BR M TS	S2090DVIB2	P BR	MI	1.724 €	1.823 €	2.067 €	2.244 €	2.594 €	2.658 €	3.131 €	2.067 €	2.067 €	FM-M2 ES-1 PD-FO	1	1	30.0	0.562

Note:



For C.O.M. Min. Qty 5 Pc. - Extra Charge for Fire-Retardant foam (ES-1) Euro 179

 Mtl. 4.63 h. 1.40 Each	 Mq. 8.60 Each
---	---

Model	Code	Mod.	Frame	Seat and Backrest								Optional	Q.ty	boxes	Kg	M³	
				TA	TB	TC	TD	TE	SF	SV	COM						COL
 Sofa AREA DV2 M TS	S2090DV200	DV2	MI	1.608 €	1.710 €	1.967 €	2.151 €	2.493 €	2.547 €	3.077 €	1.967 €	1.967 €	FM-M2 ES-1 PD-FO	1	1	38.0	0.894

Note:

For C.O.M. Min. Qty 5 Pc. - Extra Charge for Fire-Retardant foam (ES-1) Euro 201

 Mtl. 4.72 h. 1.40 Each	 Mq. 8.10 Each
---	---

Model	Code	Mod.	Frame	Seat and Backrest								Optional	Q.ty	boxes	Kg	M³	
				TA	TB	TC	TD	TE	SF	SV	COM						COL
 Dormeuse AREA DV2_DRM M TS	S2090DV2B1	DV2 DRM	MI	1.919 €	2.022 €	2.279 €	2.463 €	2.805 €	2.856 €	3.165 €	2.279 €	2.279 €	FM-M2 ES-1 PD-FO	1	1	40.0	0.937

Note:

For C.O.M. Min. Qty 5 Pc. - Extra Charge for Fire-Retardant foam (ES-1) Euro 211

 Mtl. 4.72 h. 1.40 Each	 Mq. 8.40 Each
---	---

Model	Code	Mod.	Frame	Seat and Backrest								Optional	Q.ty	boxes	Kg	M³	
				TA	TB	TC	TD	TE	SF	SV	COM						COL
 Sofa AREA DV2_BR M TS	S2090DV2B2	DV2 BR	MI	2.335 €	2.477 €	2.835 €	3.091 €	3.565 €	3.694 €	4.256 €	2.835 €	2.835 €	FM-M2 ES-1 PD-FO	1	1	46.0	0.991

Note:

For C.O.M. Min. Qty 5 Pc. - Extra Charge for Fire-Retardant foam (ES-1) Euro 267

 Mtl. 6.55 h. 1.40 Each	 Mq. 11.70 Each
---	--

Model	Code	Mod.	Frame	Seat and Backrest									Optional	Q.ty	boxes	Kg	M³
				TA	TB	TC	TD	TE	SF	SV	COM	COL					
 Sofa AREA DV3 M TS	S2090DV300	DV3	M1	2.489 €	2.627 €	2.978 €	3.231 €	3.718 €	3.837 €	4.400 €	2.978 €	2.978 €	FM-M2 ES-1 PD-F0	1	1	64.0	1.296

Note:



For C.O.M. Min. Qty 5 Pc. - Extra Charge for Fire-Retardant foam (ES-1) Euro 356

 COM	Mtl. 6.54 h. 1.40 Each	 COL	Mq. 11.10 Each
---	------------------------	---	----------------

Model	Code	Mod.	Frame	Seat and Backrest									Optional	Q.ty	boxes	Kg	M³
				TA	TB	TC	TD	TE	SF	SV	COM	COL					
 Sofa AREA DV3_BR M TS	S2090DV3B2	DV3 BR	M1	3.216 €	3.396 €	3.845 €	4.170 €	4.792 €	4.917 €	5.645 €	3.845 €	3.845 €	FM-M2 ES-1 PD-F0	1	1	72.0	1.403

Note:

For C.O.M. Min. Qty 5 Pc. - Extra Charge for Fire-Retardant foam (ES-1) Euro 434

 COM	Mtl. 8.40 h. 1.40 Each	 COL	Mq. 14.70 Each
---	------------------------	---	----------------

Frame finishes

Metal

MI	WHITE BB , BROWN E6 , SAND EC , GRAPHITE EG , BLACK EN
-----------	---

Seat and Back finishes

Upholstery

TA	FAUX LEATHER Secret , FABRIC Mirage , FABRIC Cotton Club	TB	FAUX LEATHER Vintage , FABRIC Fenix Wool , FABRIC Visual , FABRIC Manhattan , FABRIC Novabuk
TC	VELVET SUPERB, FABRIC Second , FABRIC Main Line Flax , FABRIC Oceanic	TD	FABRIC Yoredale , FABRIC Remix 3
TE	FABRIC Uniform Melange	SF	LEATHER Fiore
SV	LEATHER Vintage		

Optionals:

		Value	Options/notes
FM-M2	Indoor matt metal M2	+ 56 €	ASH GREY ES , BRONZE E2 , BULGARO RED FP , CHERRY RED EQ , DARK GREEN EL , FACEPOWDER PINK E8 , FANGO E3 , GOLDEN YELLOW EO , LIGHT BLUE EO , LIGHT GREY ET , OCEAN BLUE E1 , OCHER YELLOW E7 , PAPAYA ORANGE EA , PASTEL YELLOW E4 , PINE GREEN EJ , RED ER , SAGE GREEN E9
ES-1	Fireproof foam	+ 456 €	ES-1
PD-F0	Felt pad feet	+ 6 €	PD-F0

Area B1

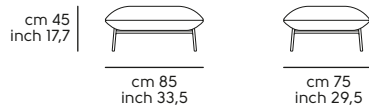

Area B2

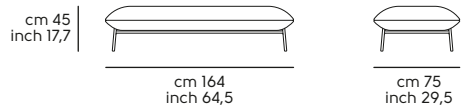

Area P

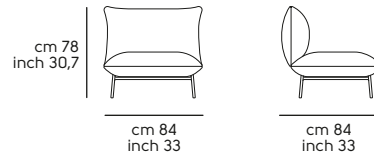

Area P BR

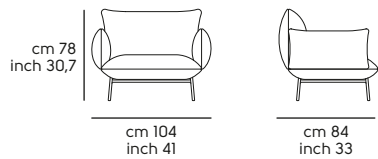

Area DV2

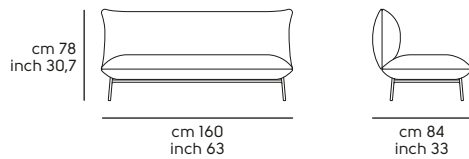

Area DV2 DRM

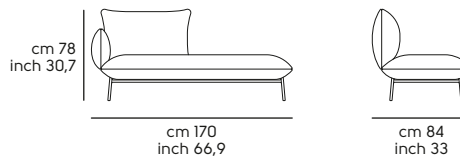

Area DV2 BR

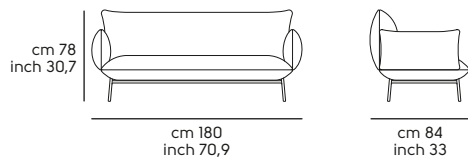

Area DV3

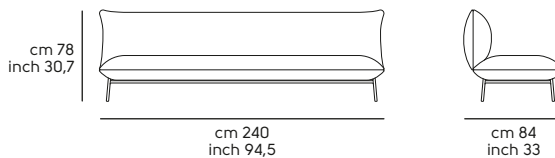

Area DV3 BR

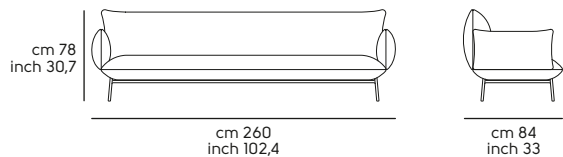

Bolle design Paola Navone

Bolle INDOOR - P, AP, DV - Seat and cushion in fabric

Frame in: metal

Model	Code	Mod.	Frame and Backrest	Seat and cushions						Optional	Q.ty	boxes	Kg	M ³
				TA	TB	TC	TD	TE	COM					
 Armchair BOLLE P M TS IN	S2200PT	P	MI	731 €	764 €	813 €	848 €	962 €	731 €	FM-M2 ES-1 PD-F0	1	1	11.5	0.29

Note:

CUSHION INCLUDED - 1 SMALL

COM/COL - Minimum Q.ty 6 pc. for each material. For weft or patterned fabrics see specific pages

	Mtl. 0.68 h. 1.40 Each ONLY SEAT
---	----------------------------------

Optionals:

		Value	Options/notes
FM-M2	Indoor matt metal M2	+ 63 €	ASH GREY ES , BRONZE E2 , BULGARO RED FP , CHERRY RED EQ , DARK GREEN EL , FACEPOWDER PINK E8 , FANGO E3 , GOLDEN YELLOW EO , LIGHT BLUE EO , LIGHT GREY ET , OCEAN BLUE E1 , OCHER YELLOW E7 , PAPAYA ORANGE EA , PASTEL YELLOW E4 , PINE GREEN EJ , RED ER , SAGE GREEN E9
ES-1	Fireproof foam	+ 21 €	ES-1
PD-F0	Felt pad feet	+ 6 €	PD-F0

Model	Code	Mod.	Frame and Backrest	Seat and cushions						Optional	Q.ty	boxes	Kg	M ³
				TA	TB	TC	TD	TE	COM					
 Waiting Chair BOLLE AP M TS IN	S2200AT	AP	MI	1.250 €	1.328 €	1.457 €	1.544 €	1.785 €	1.250 €	FM-M2 ES-1 PD-F0	1	1	20.0	0.5

Note:

CUSHIONS INCLUDED - 1 SMALL + 1 BIG

COM/COL - Minimum Q.ty 6 pc. for each material. For weft or patterned fabrics see specific pages

	Mtl. 1.21 h. 1.40 Each ONLY SEAT
---	----------------------------------

Optionals:

		Value	Options/notes
FM-M2	Indoor matt metal M2	+ 84 €	ASH GREY ES , BRONZE E2 , BULGARO RED FP , CHERRY RED EQ , DARK GREEN EL , FACEPOWDER PINK E8 , FANGO E3 , GOLDEN YELLOW EO , LIGHT BLUE EO , LIGHT GREY ET , OCEAN BLUE E1 , OCHER YELLOW E7 , PAPAYA ORANGE EA , PASTEL YELLOW E4 , PINE GREEN EJ , RED ER , SAGE GREEN E9
ES-1	Fireproof foam	+ 32 €	ES-1
PD-F0	Felt pad feet	+ 6 €	PD-F0

Model	Code	Mod.	Frame and Backrest	Seat and cushions						Optional	Q.ty	boxes	Kg	M³
				TA	TB	TC	TD	TE	COM					
 Sofa BOLLE DV M TS IN	S2200LT	DV	MI	2.573 €	2.772 €	3.095 €	3.305 €	3.901 €	2.573 €	FM-M2 ES-1 PD-F0	1	1	37.0	0.88

Note:

CUSHIONS INCLUDED - 2 SMALL + 2 MEDIUM + 2 BIG

COM/COL - Minimum Q.ty 6 pc. for each material. For weft or patterned fabrics see specific pages

	Mtl. 2.02 h. 1.40 Each ONLY SEAT
--	----------------------------------

Optionals:

		Value	Options/notes
FM-M2	Indoor matt metal M2	+ 168 €	ASH GREY ES , BRONZE E2 , BULGARO RED FP , CHERRY RED EQ , DARK GREEN EL , FACEPOWDER PINK E8 , FANGO E3 , GOLDEN YELLOW EO , LIGHT BLUE E0 , LIGHT GREY ET , OCEAN BLUE E1 , OCHER YELLOW E7 , PAPAYA ORANGE EA , PASTEL YELLOW E4 , PINE GREEN EJ , RED ER , SAGE GREEN E9
ES-1	Fireproof foam	+ 63 €	ES-1
PD-F0	Felt pad feet	+ 6 €	PD-F0

Note:

--

Frame and Back finishes

Metal	
MI	WHITE BB , BROWN E6 , SAND EC , GRAPHITE EG , BLACK EN

Finishes Seat and Cushions

Upholstery			
TA	FAUX LEATHER Secret , FABRIC Mirage , FABRIC Cotton Club	TB	FAUX LEATHER Vintage , FABRIC Fenix Wool , FABRIC Novabuk , FABRIC Manhattan , FABRIC Visual
TC	VELVET SUPERB, FABRIC Second , FABRIC Main Line Flax , FABRIC Oceanic	TD	FABRIC Yoredale , FABRIC Remix 3
TE	FABRIC Uniform Melange		

Bolle OUTDOOR - P, AP, DV - Seat and cushion in fabric

Frame with bases in: metal shell in alluminium

Model	Code	Mod.	Frame and Backrest	Seat and cushions	Optional	Q.ty	boxes	Kg	M ²
					TC				
Armchair BOLLE P M TS OUT 	S2201PT	P	O1	1.208 €	FM-O2 ES-1	1	1	11.5	0.29

Note:

CUSHION INCLUDED - CAT. TC OUTDOOR fabric - 1 SMALL

COM/COL - Minimum Q.ty 6 pc. for each material. For weft or patterned fabrics see specific pages

 Mtl. 0.68 h. 1.40 Each ONLY SEAT	
--	--

Optionals:

		Value	Options/notes
FM-O2	Outdoor metal O2	+ 63 €	Outdoor ASH GREY ES , Outdoor BRONZE E2 , Outdoor CHERRY RED EQ , Outdoor DARK GREEN EL , Outdoor FACEPOWDER PINK E8 , Outdoor FANGO E3 , Outdoor GOLD YELLOW EO , Outdoor LIGHT BLUE E0 , Outdoor LIGHT GREY ET , Outdoor OCEAN BLUE E1 , Outdoor OCHER YELLOW E7 , Outdoor PAPAYA ORANGE EA , Outdoor PASTEL YELLOW E4 , Outdoor PINE GREEN EJ , Outdoor RED BULGARO FP , Outdoor RED ER , Outdoor SAGE GREEN E9
ES-1	Fireproof foam	+ 26 €	ES-1

Model	Code	Mod.	Frame and Backrest	Seat and cushions	Optional	Q.ty	boxes	Kg	M ²
					TC				
Waiting Chair BOLLE AP M TS OUT 	S2201AT	AP	O1	1.764 €	FM-O2 ES-1	1	1	20.0	0.5

Note:



CUSHIONS INCLUDED - CAT. TC OUTDOOR Fabric - 1 SMALL + 1 BIG

COM/COL - Minimum Q.ty 6 pc. for each material. For weft or patterned fabrics see specific pages

 Mtl. 1.21 h. 1.40 Each ONLY SEAT	
--	--

Optionals:

		Value	Options/notes
FM-O2	Outdoor metal O2	+ 84 €	Outdoor ASH GREY ES , Outdoor BRONZE E2 , Outdoor CHERRY RED EQ , Outdoor DARK GREEN EL , Outdoor FACEPOWDER PINK E8 , Outdoor FANGO E3 , Outdoor GOLD YELLOW EO , Outdoor LIGHT BLUE E0 , Outdoor LIGHT GREY ET , Outdoor OCEAN BLUE E1 , Outdoor OCHER YELLOW E7 , Outdoor PAPAYA ORANGE EA , Outdoor PASTEL YELLOW E4 , Outdoor PINE GREEN EJ , Outdoor RED BULGARO FP , Outdoor RED ER , Outdoor SAGE GREEN E9
ES-1	Fireproof foam	+ 37 €	ES-1

Model	Code	Mod.	Frame and Backrest	Seat and cushions	Optional	Q.ty	boxes	Kg	M ³
					TC				
 Sofa BOLLE DV M TS OUT 	S2201LT	DV	OI	3.476 €	FM-O2 ES-1	1	1	37.0	0.88

Note:

CUSHIONS INCLUDED - CAT. TC OUTDOOR Fabric - 2 SMALL + 2 MEDIUM + 2 BIG

COM/COL - Minimum Q.ty 6 pc. for each material. For weft or patterned fabrics see specific pages

	Mtl. 2.02 h. 1.40 Each ONLY SEAT
--	----------------------------------

Optionals:

	Value	Options/notes
FM-O2	+ 168 €	Outdoor ASH GREY ES , Outdoor BRONZE E2 , Outdoor CHERRY RED EQ , Outdoor DARK GREEN EL , Outdoor FACEPOWDER PINK E8 , Outdoor FANGO E3 , Outdoor GOLD YELLOW EO , Outdoor LIGHT BLUE E0 , Outdoor LIGHT GREY ET , Outdoor OCEAN BLUE EI , Outdoor OCHER YELLOW E7 , Outdoor PAPAYA ORANGE EA , Outdoor PASTEL YELLOW E4 , Outdoor PINE GREEN EJ , Outdoor RED BULGARO FP , Outdoor RED ER , Outdoor SAGE GREEN E9
ES-1	+ 68 €	ES-1

Note:

--

Frame and Back finishes

Metal

OI	Outdoor BROWN E6 , Outdoor WHITE BB , Outdoor SAND EC , Outdoor GRAFITE EG , Outdoor BLACK EN
-----------	--

Bolle P

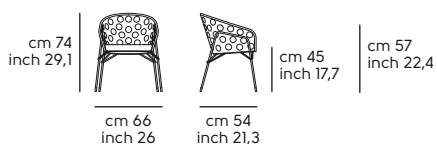

Bolle AP

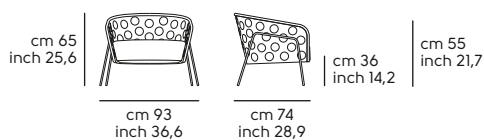

Bolle DV

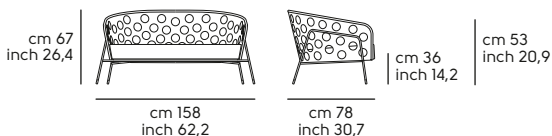

Bolle INDOOR Cushion - Cushion in fabric

--

Model	Code	Mod.	--	Upholstery						Optional	Q.ty	boxes	Kg	M ³
				TA	TB	TC	TD	TE	COM					
	A2200Q0	S		98 €	113 €	138 €	155 €	213 €	98 €	ES-1	1	1	0.9	0.01

COM/COL - Minimum Q.ty 6 pc. for each material. For weft or patterned fabrics see specific pages

 COM	Mtl. 0.63 h. 1.40 Each
--	------------------------

Model	Code	Mod.	--	Upholstery						Optional	Q.ty	boxes	Kg	M ³
				TA	TB	TC	TD	TE	COM					
	A2200Q1	M		121 €	139 €	166 €	186 €	242 €	121 €	ES-1	1	1	1.1	0.04

COM/COL - Minimum Q.ty 6 pc. for each material. For weft or patterned fabrics see specific pages

 COM	Mtl. 0.73 h. 1.40 Each
--	------------------------

Model	Code	Mod.	--	Upholstery						Optional	Q.ty	boxes	Kg	M ³
				TA	TB	TC	TD	TE	COM					
	A2200Q2	L		194 €	217 €	255 €	280 €	350 €	194 €	ES-1	1	1	2.0	0.09

COM/COL - Minimum Q.ty 6 pc. for each material. For weft or patterned fabrics see specific pages

 COM	Mtl. 1.00 h. 1.40 Each
--	------------------------

Cushion finishes

Upholstery



TA	FAUX LEATHER Secret , FABRIC Mirage , FABRIC Cotton Club	TB	FAUX LEATHER Vintage , FABRIC Fenix Wool , FABRIC Novabuk , FABRIC Manhattan , FABRIC Visual
TC	VELVET SUPERB, FABRIC Second , FABRIC Main Line Flax , FABRIC Oceanic	TD	FABRIC Yoredale , FABRIC Remix 3
TE	FABRIC Uniform Melange		

Optionals:

	Value	Options/notes
ES-1	Fireproof foam	+ 11 € ES-1



Bolle OUTDOOR Cushion - Cushion in fabric

--

Model	Code	Mod.	--	Upholstery	Optional	Q.ty	boxes	Kg	M³
					TC				
Cushion BOLLE Small OUT									
	A2201Q0	S		145 €	ES-1	1	1	0.9	0.01
									



COM/COL - Minimum Q.ty 6 pc. for each material. For weft or patterned fabrics see specific pages

	Mtl. 0.63 h. 1.40 Each
--	------------------------

Model	Code	Mod.	--	Upholstery	Optional	Q.ty	boxes	Kg	M³
					TC				
Cushion BOLLE Medium OUT									
	A2201Q1	M		176 €	ES-1	1	1	1.1	0.04
									

COM/COL - Minimum Q.ty 6 pc. for each material. For weft or patterned fabrics see specific pages

	Mtl. 0.73 h. 1.40 Each
--	------------------------

Model	Code	Mod.	--	Upholstery	Optional	Q.ty	boxes	Kg	M³
					TC				
Cushion BOLLE Large OUT									
	A2201Q2	L		268 €	ES-1	1	1	2.0	0.09
									

COM/COL - Minimum Q.ty 6 pc. for each material. For weft or patterned fabrics see specific pages

	Mtl. 1.00 h. 1.40 Each
--	------------------------

Optionals:

		Value	Options/notes
ES-1	Fireproof foam	+ 16 €	ES-1

Bolle Cushion S

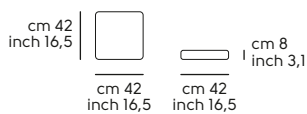

Bolle Cushion M

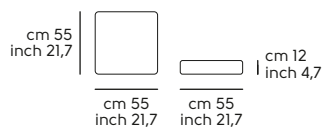



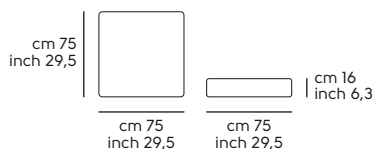











Bolle Cushion L



Calla design Fabrizio Batoni

Calla S, DS - Shell in polypropylene

Frame in: metal or wood

Model	Code	Base type	Frame	Shell	Optional	Q.ty	boxes	Kg	M ³
PP1									
Chair CALLA S M_M PP   	S1920SP_M	_M	M1	160 €	FM-M2 FM-M3 FM-M4 FM-O1 FM-O2 PD-F0	2 4	1 1	12.0 23.0	0.3 0.45
Chair CALLA S M_T PP   	S1920SP_T	_T	M1	182 €	FM-M2 FM-O1 FM-O2	2 4	1 1	12.0 23.0	0.3 0.45
Chair CALLA S M_Q PP  	S1920SP_Q	_Q	M1	196 €	FM-M2 FM-O1 FM-O2 PD-F0	2	1	12.0	0.3
Chair CALLA S M_X PP  	S1920SP_X	_X	M1	179 €	FM-M2 FM-M3 FM-M4 FM-O1 FM-O2 PD-F0	2	1	12.0	0.3
Chair CALLA S L_C PP 	S1925WP_C	_C	LF1	242 €	PD-F0	2	1	12.0	0.35
Chair CALLA S L_N PP  	S1925WP_N	_N	LII	334 €	FL-I2 PD-F0	2	1	12.0	0.35
Office Chair CALLA DS PP  	S1920DP	DS	M1	328 €	FM-M2 FM-M3	1	2	9.5	0.27

Note:

Linking device available for T base. See Accessories section

Frame finishes

Metal

MI	WHITE BB , BROWN E6 , SAND EC , GRAPHITE EG , BLACK EN
-----------	---

Wood

LFI	Ash wood painted GREY F02 , Ash wood painted GRAFITE GREY F03 , Ash wood painted BLACK F04 , Ash wood painted WHITE F05 , Ash wood painted BLUE F06 , Ash wood painted RED F08 , Ash wood painted CHERRY RED F09 , Ash wood painted FLAMED WALNUT F24 , Ash wood painted DARK BROWN F26 , Ash wood painted NATURAL F40 , Ash wood painted NATURAL OAK F52
LII	Veneered wood painted GREY I02 , Veneered wood painted GRAFITE GREY I03 , Veneered wood painted BLACK I04 , Veneered wood painted WHITE I05 , Veneered wood painted BLUE I06 , Veneered wood painted RED I08 , Veneered wood painted CHERRY RED I09 , Veneered wood painted DARK BROWN I26 , Veneered wood painted NATURAL I40 , Veneered wood painted NATURAL OAK I52

Shell finishes

Polypropylene

PP1	WHITE PB4 , GRAFITE GREY PGD , SKY GREY PGU , BROWN PM2 , BLACK PN4 , OCHER YELLOW PO2 , RED PRR , RED BULGARO PRS , SAND PS2 , TERRACOTTA PT2 , DARK GREEN PVL
------------	--

Optionals:

		Value	Options/notes
FM-M2	Indoor matt metal M2	+ 45 €	ASH GREY ES , BRONZE E2 , BULGARO RED FP , CHERRY RED EQ , DARK GREEN EL , FACEPOWDER PINK E8 , FANGO E3 , GOLDEN YELLOW EO , LIGHT BLUE E0 , LIGHT GREY ET , OCEAN BLUE E1 , OCHER YELLOW E7 , PAPAYA ORANGE EA , PASTEL YELLOW E4 , PINE GREEN EJ , RED ER , SAGE GREEN E9
FM-M3	Indoor glossy metal M3	+ 25 €	CHROME CC
FM-M4	Indoor glossy Metal M4	+ 117 €	BLACK NICKEL DZ , CHAMPAGNE GOLD DG , GOLDEN BRONZE DB , MATT BLACK NICKEL DY , MATT GOLDEN BRONZE DC , PINK GOLD DR
FM-O1	Outdoor metal O1	+ 40 €	Outdoor BLACK EN , Outdoor BROWN E6 , Outdoor GRAFITE EG , Outdoor SAND EC , Outdoor WHITE BB
FM-O2	Outdoor metal O2	+ 91 €	Outdoor ASH GREY ES , Outdoor BRONZE E2 , Outdoor CHERRY RED EQ , Outdoor DARK GREEN EL , Outdoor FACEPOWDER PINK E8 , Outdoor FANGO E3 , Outdoor GOLD YELLOW EO , Outdoor LIGHT BLUE E0 , Outdoor LIGHT GREY ET , Outdoor OCEAN BLUE E1 , Outdoor OCHER YELLOW E7 , Outdoor PAPAYA ORANGE EA , Outdoor PASTEL YELLOW E4 , Outdoor PINE GREEN EJ , Outdoor RED BULGARO FP , Outdoor RED ER , Outdoor SAGE GREEN E9
FL-I2	Veneered wood finish LI2	+ 6 €	Veneered wood FLAMED WALNUT I24 , Veneered wood NATURAL OAK I22
PD-F0	Felt pad feet	+ 6 €	PD-F0

Calla S_M

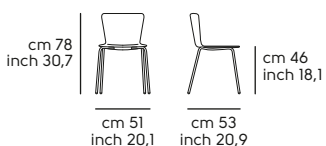

Calla S_T

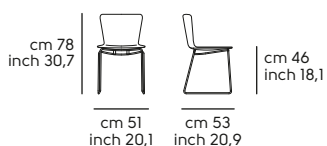

Calla S_Q

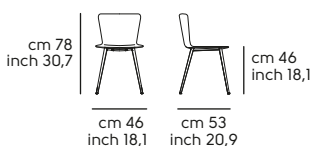

Calla S_X

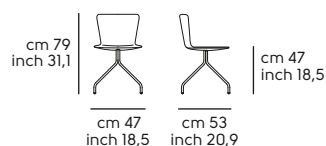

Calla S_C

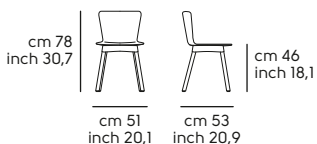

Calla S_N

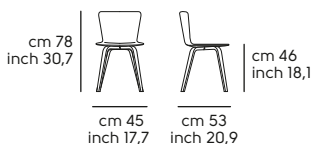



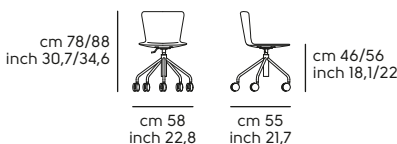











Calla S_DS



Calla S, DS - Shell in polypropylene, seat in fabric or leather

Frame in: metal or wood

Model	Code	Base type	Frame	Shell PPI / Seat									Optional	Q.ty	boxes	Kg	M³
				TA	TB	TC	TD	TE	SF	SV	COM	COL					
 	S1920SS_M	_M	MI	214 €	222 €	235 €	271 €	375 €	248 €	256 €	214 €	235 €	FM-M2 FM-M3 FM-M4 ES-1 PD-F0	2 4	1 1	12.0 23.0	0.3 0.45
  	S1929SS_M	_M	MI	230 €	238 €	251 €	288 €	392 €	265 €	273 €	230 €	251 €	FM-M2 FM-M3 FM-M4 ES-1 PD-F0	2 4	1 1	12.0 23.0	0.3 0.45
	S1920SS_T	_T	MI	237 €	245 €	258 €	294 €	398 €	271 €	279 €	237 €	258 €	FM-M2 ES-1	2 4	1 1	12.0 23.0	0.3 0.45
 	S1929SS_T	_T	MI	253 €	261 €	274 €	311 €	415 €	288 €	296 €	253 €	274 €	FM-M2 ES-1	2 4	1 1	12.0 23.0	0.3 0.45
	S1920SS_Q	_Q	MI	250 €	258 €	271 €	307 €	411 €	284 €	292 €	250 €	271 €	FM-M2 ES-1 PD-F0	2	1	12.0	0.3
	S1920SS_X	_X	MI	237 €	245 €	258 €	294 €	398 €	271 €	279 €	237 €	258 €	FM-M2 FM-M3 FM-M4 ES-1 PD-F0	2	1	12.0	0.3
	S1925WS_C	_C	LF1	294 €	303 €	315 €	352 €	456 €	329 €	337 €	294 €	315 €	ES-1 PD-F0	2	1	12.0	0.35
 	S1925WS_N	_N	LII	378 €	387 €	399 €	436 €	540 €	413 €	421 €	378 €	399 €	FL-I2 ES-1 PD-F0	2	1	12.0	0.35
 	S1920DS	DS	MI	382 €	390 €	402 €	440 €	544 €	415 €	423 €	382 €	402 €	FM-M2 FM-M3 ES-1	1	2	9.5	0.27

Note:

Linking device available for T base. See Accessories section

Frame finishes

Metal	
MI	WHITE BB , BROWN E6 , SAND EC , GRAPHITE EG , BLACK EN

Wood	
LFI	Ash wood painted GREY F02 , Ash wood painted GRAFITE GREY F03 , Ash wood painted BLACK F04 , Ash wood painted WHITE F05 , Ash wood painted BLUE F06 , Ash wood painted RED F08 , Ash wood painted CHERRY RED F09 , Ash wood painted FLAMED WALNUT F24 , Ash wood painted DARK BROWN F26 , Ash wood painted NATURAL F40 , Ash wood painted NATURAL OAK F52
LII	Veneered wood painted GREY I02 , Veneered wood painted GRAFITE GREY I03 , Veneered wood painted BLACK I04 , Veneered wood painted WHITE I05 , Veneered wood painted BLUE I06 , Veneered wood painted RED I08 , Veneered wood painted CHERRY RED I09 , Veneered wood painted DARK BROWN I26 , Veneered wood painted NATURAL I40 , Veneered wood painted NATURAL OAK I52



Shell finishes

Polypropylene	
PP1	WHITE PB4 , GRAFITE GREY PGD , SKY GREY PGU , BROWN PM2 , BLACK PN4 , OCHER YELLOW PO2 , RED PRR , RED BULGARO PRS , SAND PS2 , TERRACOTTA PT2 , DARK GREEN PVL

Seat finishes

Upholstery	
TA	FAUX LEATHER Secret , FABRIC Mirage , FABRIC Cotton Club
TB	FAUX LEATHER Vintage , FABRIC Fenix Wool , FABRIC Novabuk , FABRIC Manhattan , FABRIC Visual
TC	VELVET SUPERB, FABRIC Second , FABRIC Main Line Flax , FABRIC Oceanic
TD	FABRIC Yoredale , FABRIC Remix 3
TE	FABRIC Uniform Melange
SF	LEATHER Fiore
SV	LEATHER Vintage

COM/COL - Minimum Q.ty 6 pc. for each material. For weft or patterned fabrics see specific pages

 COM	Mtl. 0.60 h. 1.40 Each	 COL	Mq. 0.70 Each
---	------------------------	--	---------------

Optionals:

		Value	Options/notes
FM-M2	Indoor matt metal M2	+ 45 €	ASH GREY ES , BRONZE E2 , BULGARO RED FP , CHERRY RED EQ , DARK GREEN EL , FACEPOWDER PINK E8 , FANGO E3 , GOLDEN YELLOW EO , LIGHT BLUE EO , LIGHT GREY ET , OCEAN BLUE EI , OCHER YELLOW E7 , PAPAYA ORANGE EA , PASTEL YELLOW E4 , PINE GREEN EJ , RED ER , SAGE GREEN E9
FM-M3	Indoor glossy metal M3	+ 20 €	CHROME CC
FM-M4	Indoor glossy Metal M4	+ 117 €	BLACK NICKEL DZ , CHAMPAGNE GOLD DG , GOLDEN BRONZE DB , MATT BLACK NICKEL DY , MATT GOLDEN BRONZE DC , PINK GOLD DR
FL-I2	Veneered wood finish LI2	+ 6 €	Veneered wood FLAMED WALNUT I24 , Veneered wood NATURAL OAK I22
ES-1	Fireproof foam	+ 5 €	ES-1
PD-F0	Felt pad feet	+ 6 €	PD-F0

Calla S_M

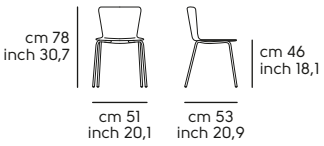

cm 78 / inch 30,7
cm 51 / inch 20,1
cm 53 / inch 20,9
cm 46 / inch 18,1

Calla S_T

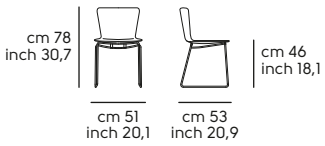

cm 78 / inch 30,7
cm 51 / inch 20,1
cm 53 / inch 20,9
cm 46 / inch 18,1

Calla S_Q

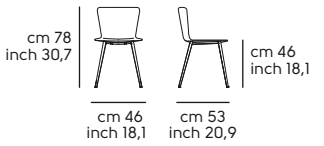

cm 78 / inch 30,7
cm 46 / inch 18,1
cm 53 / inch 20,9
cm 46 / inch 18,1

Calla S_X

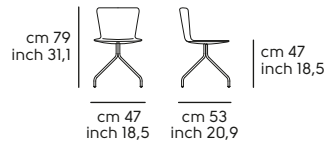

cm 79 / inch 31,1
cm 47 / inch 18,5
cm 47 / inch 18,5
cm 53 / inch 20,9

Calla S_C

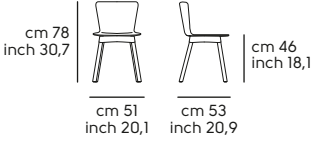

cm 78 / inch 30,7
cm 51 / inch 20,1
cm 53 / inch 20,9
cm 46 / inch 18,1

Calla S_N

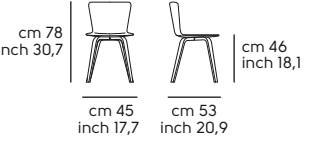

cm 78 / inch 30,7
cm 45 / inch 17,7
cm 53 / inch 20,9
cm 46 / inch 18,1



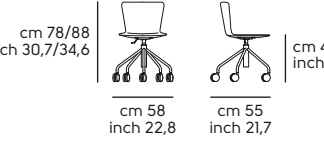





Calla S_DS



cm 78/88 / inch 30,7/34,6
cm 58 / inch 22,8
cm 55 / inch 21,7
cm 46/56 / inch 18,1/22

Calla S, DS - Shell in fabric or leather

Frame in: metal or wood

Model	Code	Base type	Frame	Upholstered shell									Optional	Q.ty	boxes	Kg	M ³
				TA	TB	TC	TD	TE	SF	SV	COM	COL					
Chair CALLA S M_M TS 	S1920ST_M	_M	M1	248 €	268 €	309 €	335 €	483 €	351 €	413 €	248 €	309 €	FM-M2 FM-M3 FM-M4 ES-1 PD-F0	2 4	1 1	13.0 25.0	0.3 0.45
Stackable Chair CALLA S M_M TS 	S1929ST_M	_M	M1	265 €	286 €	326 €	352 €	500 €	368 €	431 €	265 €	326 €	FM-M2 FM-M3 FM-M4 ES-1 PD-F0	2 4	1 1	13.0 25.0	0.3 0.45
Chair CALLA S M_T TS 	S1920ST_T	_T	M1	271 €	291 €	332 €	358 €	506 €	374 €	436 €	271 €	332 €	FM-M2 ES-1	2 4	1 1	13.0 25.0	0.3 0.45
Stackable Chair CALLA S M_T TS 	S1929ST_T	_T	M1	288 €	309 €	349 €	375 €	523 €	391 €	454 €	288 €	349 €	FM-M2 ES-1	2 4	1 1	13.0 25.0	0.3 0.45
Chair CALLA S M_Q TS 	S1920ST_Q	_Q	M1	285 €	305 €	346 €	372 €	520 €	388 €	450 €	285 €	346 €	FM-M2 ES-1 PD-F0	2	1	13.0	0.3
Chair CALLA S M_X TS 	S1920ST_X	_X	M1	267 €	287 €	328 €	354 €	502 €	370 €	432 €	267 €	328 €	FM-M2 FM-M3 FM-M4 ES-1 PD-F0	2	1	13.0	0.3
Chair CALLA S L_C TS 	S1925WT_C	_C	LF1	330 €	351 €	391 €	417 €	565 €	434 €	494 €	330 €	391 €	ES-1 PD-F0	2	1	13.0	0.35
Chair CALLA S L_N TS 	S1925WT_N	_N	L11	413 €	434 €	474 €	500 €	648 €	517 €	577 €	413 €	474 €	FL-I2 ES-1 PD-F0	2	1	13.0	0.35
Office Chair CALLA DS TS 	S1920DT	DS	M1	415 €	436 €	475 €	503 €	649 €	519 €	581 €	415 €	475 €	FM-M2 FM-M3 ES-1	1	2	9.5	0.27

Note:

TS Front and Back covering available in two-tone or bi-material. Reference price in the upper category. Linking device available for T base. See Accessories section



Frame finishes

Metal		Wood	
MI	WHITE BB , BROWN E6 , SAND EC , GRAPHITE EG , BLACK EN	LFI	Ash wood painted GREY F02 , Ash wood painted GRAFITE GREY F03 , Ash wood painted BLACK F04 , Ash wood painted WHITE F05 , Ash wood painted BLUE F06 , Ash wood painted RED F08 , Ash wood painted CHERRY RED F09 , Ash wood painted FLAMED WALNUT F24 , Ash wood painted DARK BROWN F26 , Ash wood painted NATURAL F40 , Ash wood painted NATURAL OAK F52
		LII	Veneered wood painted GREY I02 , Veneered wood painted GRAFITE GREY I03 , Veneered wood painted BLACK I04 , Veneered wood painted WHITE I05 , Veneered wood painted BLUE I06 , Veneered wood painted RED I08 , Veneered wood painted CHERRY RED I09 , Veneered wood painted DARK BROWN I26 , Veneered wood painted NATURAL I40 , Veneered wood painted NATURAL OAK I52

Shell finishes

Upholstery	
TA	FAUX LEATHER Secret , FABRIC Mirage , FABRIC Cotton Club
TC	VELVET SUPERB, FABRIC Second , FABRIC Main Line Flax , FABRIC Oceanic
TE	FABRIC Uniform Melange
SV	LEATHER Vintage
TB	FAUX LEATHER Vintage , FABRIC Fenix Wool , FABRIC Novabuk , FABRIC Manhattan , FABRIC Visual
TD	FABRIC Yoredale , FABRIC Remix 3
SF	LEATHER Fiore

COM/COL - Minimum Q.ty 6 pc. for each material. For weft or patterned fabrics see specific pages

 COM	Mtl. 0.92 h. 1.40 Each	 COL	Mq. 1.90 Each
--	------------------------	---	---------------

Optionals:

	Value	Options/notes
FM-M2	+ 45 €	ASH GREY ES , BRONZE E2 , BULGARO RED FP , CHERRY RED EQ , DARK GREEN EL , FACEPOWDER PINK E8 , FANGO E3 , GOLDEN YELLOW EO , LIGHT BLUE EO , LIGHT GREY ET , OCEAN BLUE E1 , OCHER YELLOW E7 , PAPAYA ORANGE EA , PASTEL YELLOW E4 , PINE GREEN EJ , RED ER , SAGE GREEN E9
FM-M3	+ 20 €	CHROME CC
FM-M4	+ 117 €	BLACK NICKEL DZ , CHAMPAGNE GOLD DG , GOLDEN BRONZE DB , MATT BLACK NICKEL DY , MATT GOLDEN BRONZE DC , PINK GOLD DR
FL-I2	+ 6 €	Veneered wood FLAMED WALNUT I24 , Veneered wood NATURAL OAK I22
ES-1	+ 6 €	ES-1
PD-F0	+ 6 €	PD-F0

Calla S_M

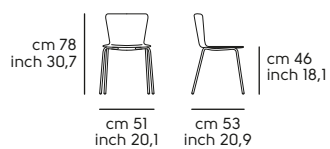

Calla S_T

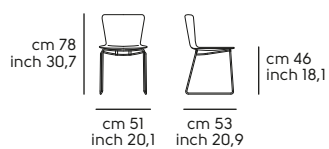

Calla S_G

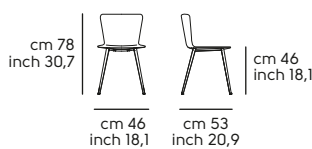

Calla S_X

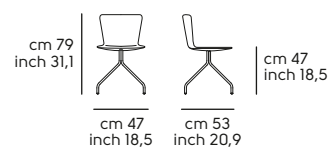

Calla S_C

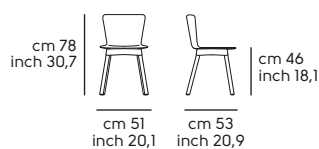

Calla S_N

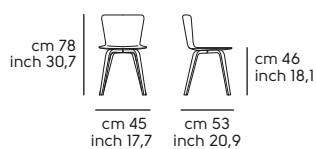



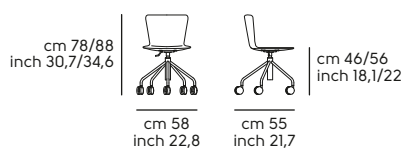



Calla S_DS



Calla P, DP - Shell in polypropylene

Frame in: metal or wood

Model	Code	Base type	Frame	Shell	Optional	Q.ty	boxes	Kg	M ³
				PP1					
Armch. CALLA P M_M PP 	S1921PP_M	_M	M1	184 €	FM-M2 FM-M3 FM-M4 FM-O1 FM-O2 PD-F0	1	1	7.0	0.26
Armch. CALLA P M_T PP 	S1921PP_T	_T	M1	207 €	FM-M2 FM-O1 FM-O2	1	1	7.0	0.26
Armch. CALLA P M_Q PP 	S1921PP_Q	_Q	M1	221 €	FM-M2 FM-O1 FM-O2 PD-F0	1	1	7.0	0.26
Armch. CALLA P M_X PP 	S1921PP_X	_X	M1	204 €	FM-M2 FM-M3 FM-M4 FM-O1 FM-O2 PD-F0	1	1	7.0	0.26
Armch. CALLA P L_C PP 	S1926WP_C	_C	LF1	267 €	PD-F0	1	1	7.0	0.26
Armch. CALLA P L_N PP 	S1926WP_N	_N	L11	352 €	FL-I2 PD-F0	1	1	7.0	0.26
Office Arm. CALLA DP PP 	S1921DP	DP	M1	358 €	FM-M2 FM-M3	1	2	10.0	0.29

Note:

Linking device available for T base. See Accessories section. Available in the DISASSEMBLED version with 4 euro price reduction. Min. 20 pcs.

Frame finishes

Metal	
MI	WHITE BB , BROWN E6 , SAND EC , GRAPHITE EG , BLACK EN

Wood	
LFI	Ash wood painted GREY F02 , Ash wood painted GRAFITE GREY F03 , Ash wood painted BLACK F04 , Ash wood painted WHITE F05 , Ash wood painted BLUE F06 , Ash wood painted RED F08 , Ash wood painted CHERRY RED F09 , Ash wood painted FLAMED WALNUT F24 , Ash wood painted DARK BROWN F26 , Ash wood painted NATURAL F40 , Ash wood painted NATURAL OAK F52
LII	Veneered wood painted GREY I02 , Veneered wood painted GRAFITE GREY I03 , Veneered wood painted BLACK I04 , Veneered wood painted WHITE I05 , Veneered wood painted BLUE I06 , Veneered wood painted RED I08 , Veneered wood painted CHERRY RED I09 , Veneered wood painted DARK BROWN I26 , Veneered wood painted NATURAL I40 , Veneered wood painted NATURAL OAK I52

Shell finishes

Polypropylene	
PPI	WHITE PB4 , GRAFITE GREY PGD , SKY GREY PGU , BROWN PM2 , BLACK PN4 , OCHER YELLOW PO2 , RED PRR , RED BULGARO PRS , SAND PS2 , TERRACOTTA PT2 , DARK GREEN PVL

Optionals:			
		Value	Options/notes
FM-M2	Indoor matt metal M2	+ 45 €	ASH GREY ES , BRONZE E2 , BULGARO RED FP , CHERRY RED EQ , DARK GREEN EL , FACEPOWDER PINK E8 , FANGO E3 , GOLDEN YELLOW EO , LIGHT BLUE E0 , LIGHT GREY ET , OCEAN BLUE E1 , OCHER YELLOW E7 , PAPAYA ORANGE EA , PASTEL YELLOW E4 , PINE GREEN EJ , RED ER , SAGE GREEN E9
FM-M3	Indoor glossy metal M3	+ 20 €	CHROME CC
FM-M4	Indoor glossy Metal M4	+ 117 €	BLACK NICKEL DZ , CHAMPAGNE GOLD DG , GOLDEN BRONZE DB , MATT BLACK NICKEL DY , MATT GOLDEN BRONZE DC , PINK GOLD DR
FM-O1	Outdoor metal O1	+ 40 €	Outdoor BLACK EN , Outdoor BROWN E6 , Outdoor GRAFITE EG , Outdoor SAND EC , Outdoor WHITE BB
FM-O2	Outdoor metal O2	+ 91 €	Outdoor ASH GREY ES , Outdoor BRONZE E2 , Outdoor CHERRY RED EQ , Outdoor DARK GREEN EL , Outdoor FACEPOWDER PINK E8 , Outdoor FANGO E3 , Outdoor GOLD YELLOW EO , Outdoor LIGHT BLUE E0 , Outdoor LIGHT GREY ET , Outdoor OCEAN BLUE E1 , Outdoor OCHER YELLOW E7 , Outdoor PAPAYA ORANGE EA , Outdoor PASTEL YELLOW E4 , Outdoor PINE GREEN EJ , Outdoor RED BULGARO FP , Outdoor RED ER , Outdoor SAGE GREEN E9
FL-I2	Veneered wood finish LI2	+ 6 €	Veneered wood FLAMED WALNUT I24 , Veneered wood NATURAL OAK I22
PD-F0	Felt pad feet	+ 6 €	PD-F0

Calla P_M

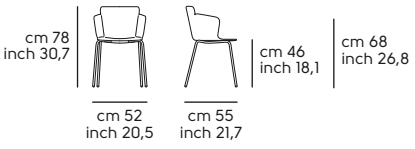

Calla P_T

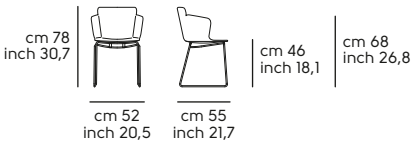

Calla P_Q

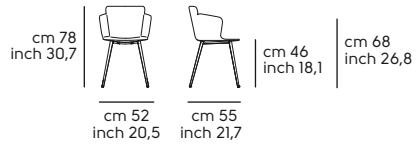

Calla P_X

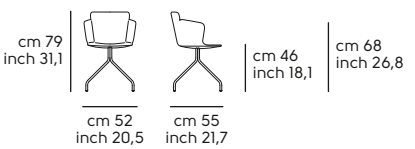

Calla P_C

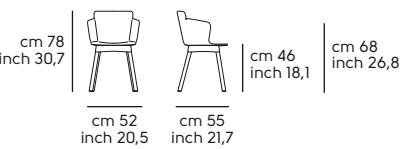

Calla P_N

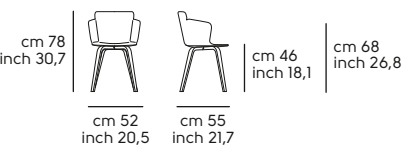



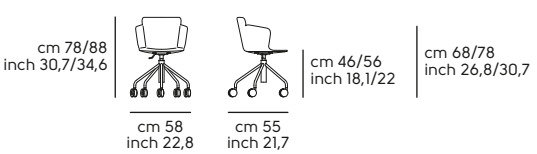



Calla P_DP



Calla P, DP - Shell in polypropylene, seat in fabric or leather

Frame in: metal or wood

Model	Code	Base type	Frame	Shell PPI / Seat									Optional	Q.ty	boxes	Kg	M ³
				TA	TB	TC	TD	TE	SF	SV	COM	COL					
Armch. CALLA P M_M PP_TS 	S1921PS_M	_M	M1	239 €	246 €	259 €	296 €	397 €	272 €	313 €	239 €	259 €	FM-M2 FM-M3 FM-M4 ES-1 PD-F0	1	1	7.0	0.26
Armch. CALLA P M_T PP_TS 	S1921PS_T	_T	M1	261 €	268 €	281 €	318 €	419 €	294 €	335 €	261 €	281 €	FM-M2 ES-1	1	1	7.0	0.26
Armch. CALLA P M_Q PP_TS 	S1921PS_Q	_Q	M1	274 €	281 €	294 €	331 €	432 €	307 €	348 €	274 €	294 €	FM-M2 ES-1 PD-F0	1	1	7.0	0.26
Armch. CALLA P M_X PP_TS 	S1921PS_X	_X	M1	258 €	265 €	278 €	315 €	416 €	291 €	332 €	258 €	278 €	FM-M2 FM-M3 FM-M4 ES-1 PD-F0	1	1	7.0	0.26
Armch. CALLA P L_C PP_TS 	S1926WS_C	_C	LFI	321 €	330 €	342 €	378 €	479 €	355 €	395 €	321 €	342 €	ES-1 PD-F0	1	1	7.0	0.26
Armch. CALLA P L_N PP_TS 	S1926WS_N	_N	LII	406 €	415 €	427 €	463 €	564 €	440 €	480 €	406 €	427 €	FL-I2 ES-1 PD-F0	1	1	7.0	0.26
Office Arm. CALLA DP PP_TS 	S1921DS	DP	M1	414 €	420 €	434 €	470 €	571 €	446 €	487 €	414 €	434 €	FM-M2 FM-M3 ES-1	1	2	10.0	0.29

Note:

Linking device available for T base. See Accessories section. Available in the DISASSEMBLED version with 4 euro price reduction. Min. 20 pcs.

Frame finishes

Metal

MI	WHITE BB, BROWN E6, SAND EC, GRAPHITE EG, BLACK EN
-----------	--

Wood

LFI	Ash wood painted GREY F02, Ash wood painted GRAFITE GREY F03, Ash wood painted BLACK F04, Ash wood painted WHITE F05, Ash wood painted BLUE F06, Ash wood painted RED F08, Ash wood painted CHERRY RED F09, Ash wood painted FLAMED WALNUT F24, Ash wood painted DARK BROWN F26, Ash wood painted NATURAL F40, Ash wood painted NATURAL OAK F52
LII	Veneered wood painted GREY I02, Veneered wood painted GRAFITE GREY I03, Veneered wood painted BLACK I04, Veneered wood painted WHITE I05, Veneered wood painted BLUE I06, Veneered wood painted RED I08, Veneered wood painted CHERRY RED I09, Veneered wood painted DARK BROWN I26, Veneered wood painted NATURAL I40, Veneered wood painted NATURAL OAK I52

Shell finishes

Polypropylene



PPI	WHITE PB4 , GRAFITE GREY PGD , SKY GREY PGU , BROWN PM2 , BLACK PN4 , OCHER YELLOW PO2 , RED PRR , RED BULGARO PRS , SAND PS2 , TERRACOTTA PT2 , DARK GREEN PVL
------------	--

Seat finishes

Upholstery

TA	FAUX LEATHER Secret , FABRIC Mirage , FABRIC Cotton Club
TB	FAUX LEATHER Vintage , FABRIC Fenix Wool , FABRIC Novabuk , FABRIC Manhattan , FABRIC Visual
TC	VELVET SUPERB, FABRIC Second , FABRIC Main Line Flax , FABRIC Oceanic
TD	FABRIC Yoredale , FABRIC Remix 3
TE	FABRIC Uniform Melange
SF	LEATHER Fiore
SV	LEATHER Vintage

COM/COL - Minimum Q.ty 6 pc. for each material. For weft or patterned fabrics see specific pages

 COM	Mtl. 0.60 h. 1.40 Each	 COL	Mq. 0.70 Each
---	------------------------	--	---------------

Optionals:

		Value	Options/notes
FM-M2	Indoor matt metal M2	+ 45 €	ASH GREY ES , BRONZE E2 , BULGARO RED FP , CHERRY RED EQ , DARK GREEN EL , FACEPOWDER PINK E8 , FANGO E3 , GOLDEN YELLOW EO , LIGHT BLUE EO , LIGHT GREY ET , OCEAN BLUE E1 , OCHER YELLOW E7 , PAPAYA ORANGE EA , PASTEL YELLOW E4 , PINE GREEN EJ , RED ER , SAGE GREEN E9
FM-M3	Indoor glossy metal M3	+ 20 €	CHROME CC
FM-M4	Indoor glossy Metal M4	+ 117 €	BLACK NICKEL DZ , CHAMPAGNE GOLD DG , GOLDEN BRONZE DB , MATT BLACK NICKEL DY , MATT GOLDEN BRONZE DC , PINK GOLD DR
FL-I2	Veneered wood finish LI2	+ 6 €	Veneered wood FLAMED WALNUT I24 , Veneered wood NATURAL OAK I22
ES-1	Fireproof foam	+ 5 €	ES-1
PD-F0	Felt pad feet	+ 6 €	PD-F0

Calla P_M

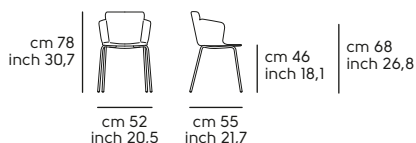

Calla P_T

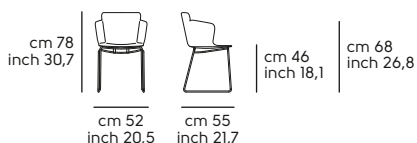

Calla P_Q

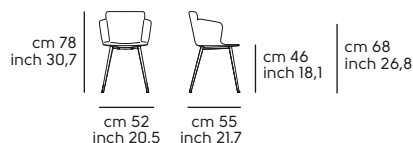

Calla P_X

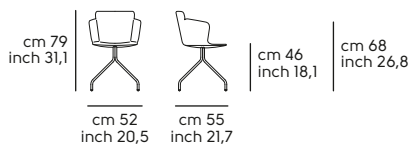

Calla P_C

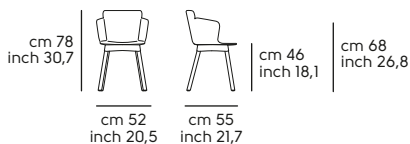

Calla P_N

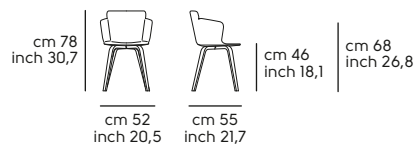



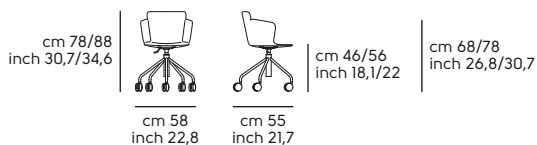





Calla P_DP



Calla P, DP - Shell in fabric or leather

Frame in: metal or wood

Model	Code	Base type	Frame	Upholstered shell									Optional	Q.ty	boxes	Kg	M³
				TA	TB	TC	TD	TE	SF	SV	COM	COL					
Armch. CALLA P M_M TS 	S192IPT_M	_M	M1	339 €	364 €	413 €	445 €	596 €	442 €	515 €	339 €	413 €	FM-M2 FM-M3 FM-M4 ES-1 PD-FO	1	1	7.5	0.26
Armch. CALLA P M_T TS 	S192IPT_T	_T	M1	362 €	387 €	436 €	468 €	619 €	465 €	538 €	362 €	436 €	FM-M2 ES-1	1	1	7.5	0.26
Armch. CALLA P M_Q TS 	S192IPT_Q	_Q	M1	375 €	400 €	449 €	481 €	632 €	478 €	551 €	375 €	449 €	FM-M2 ES-1 PD-FO	1	1	7.5	0.26
Armch. CALLA P M_X TS 	S192IPT_X	_X	M1	358 €	383 €	432 €	464 €	615 €	461 €	534 €	358 €	432 €	FM-M2 FM-M3 FM-M4 ES-1 PD-FO	1	1	7.5	0.26
Armch. CALLA P L_C TS 	S1926WT_C	_C	LF1	421 €	446 €	494 €	527 €	679 €	525 €	596 €	421 €	494 €	ES-1 PD-FO	1	1	7.5	0.26
Armch. CALLA P L_N TS 	S1926WT_N	_N	L11	506 €	531 €	579 €	612 €	764 €	610 €	681 €	506 €	579 €	FL-12 ES-1 PD-FO	1	1	7.5	0.26
Office Arm. CALLA DP TS  	S1921DT	DP	M1	513 €	538 €	587 €	620 €	771 €	616 €	689 €	513 €	587 €	FM-M2 FM-M3 ES-1	1	2	10.0	0.29

Note:

TS Front and Back covering available in two-tone or bi-material. Reference price in the upper category. Linking device available for T base. See Accessories section. Available in the DISASSEMBLED version with 4 euro price reduction. Min. 20 pcs.

Frame finishes

Metal

MI	WHITE BB , BROWN E6 , SAND EC , GRAPHITE EG , BLACK EN
-----------	---

Wood



LFI	Ash wood painted GREY F02 , Ash wood painted GRAFITE GREY F03 , Ash wood painted BLACK F04 , Ash wood painted WHITE F05 , Ash wood painted BLUE F06 , Ash wood painted RED F08 , Ash wood painted CHERRY RED F09 , Ash wood painted FLAMED WALNUT F24 , Ash wood painted DARK BROWN F26 , Ash wood painted NATURAL F40 , Ash wood painted NATURAL OAK F52
LII	Veneered wood painted GREY I02 , Veneered wood painted GRAFITE GREY I03 , Veneered wood painted BLACK I04 , Veneered wood painted WHITE I05 , Veneered wood painted BLUE I06 , Veneered wood painted RED I08 , Veneered wood painted CHERRY RED I09 , Veneered wood painted DARK BROWN I26 , Veneered wood painted NATURAL I40 , Veneered wood painted NATURAL OAK I52

Shell finishes

Upholstery

TA	FAUX LEATHER Secret , FABRIC Mirage , FABRIC Cotton Club	TB	FAUX LEATHER Vintage , FABRIC Fenix Wool , FABRIC Novabuk , FABRIC Manhattan , FABRIC Visual
TC	VELVET SUPERB, FABRIC Second , FABRIC Main Line Flax , FABRIC Oceanic	TD	FABRIC Yoredale , FABRIC Remix 3
TE	FABRIC Uniform Melange	SF	LEATHER Fiore
SV	LEATHER Vintage		

COM/COL - Minimum Q.ty 6 pc. for each material. For weft or patterned fabrics see specific pages

COM 	Mtl. 1.10 h. 1.40 Each	COL 	Mq. 2.40 Each
--	------------------------	---	---------------

Optionals:

	Value	Options/notes
FM-M2	+ 45 €	ASH GREY ES , BRONZE E2 , BULGARO RED FP , CHERRY RED EQ , DARK GREEN EL , FACEPOWDER PINK E8 , FANGO E3 , GOLDEN YELLOW EO , LIGHT BLUE E0 , LIGHT GREY ET , OCEAN BLUE E1 , OCHER YELLOW E7 , PAPAYA ORANGE EA , PASTEL YELLOW E4 , PINE GREEN EJ , RED ER , SAGE GREEN E9
FM-M3	+ 20 €	CHROME CC
FM-M4	+ 117 €	BLACK NICKEL DZ , CHAMPAGNE GOLD DG , GOLDEN BRONZE DB , MATT BLACK NICKEL DY , MATT GOLDEN BRONZE DC , PINK GOLD DR
FL-I2	+ 6 €	Veneered wood FLAMED WALNUT I24 , Veneered wood NATURAL OAK I22
ES-1	+ 6 €	ES-1
PD-F0	+ 6 €	PD-F0

Calla P_M



Calla P_T

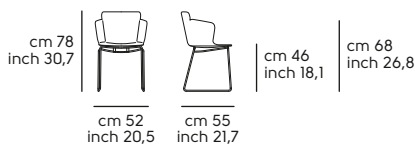

Calla P_Q

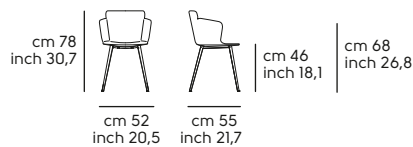

Calla P_X

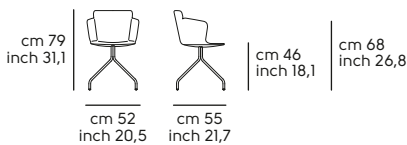

Calla P_C



Calla P_N

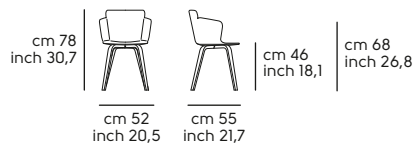



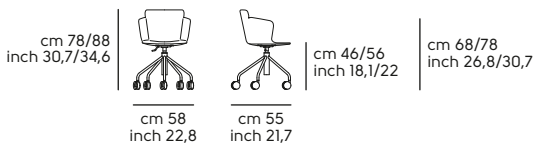

Calla P_DP





Calla S H65-S H75 - Shell in polypropylene, seat in fabric or leather, shell in fabric or leather

Frame in: metal

Model	Code	Mod.	Frame	Shell								Optional	Q.ty	boxes	Kg	M ³
PPI																
Stool CALLA S65 M PP 	S1920HP	S65	M1	269 €								FM-M2 FM-O1 FM-O2 PD-F0	1	1	7.0	0.23
Stool CALLA S75 M PP 	S1920JP	S75	M1	284 €								FM-M2 FM-O1 FM-O2 PD-F0	1	1	7.0	0.25

Model	Code	Mod.	Frame	Shell PPI / Seat									Optional	Q.ty	boxes	Kg	M ³
				TA	TB	TC	TD	TE	SF	SV	COM	COL					
Stool CALLA S65 M PP_TS 	S1920HS	S65	M1	324 €	332 €	344 €	381 €	485 €	357 €	396 €	324 €	344 €	FM-M2 ES-1 PD-F0	1	1	7.0	0.23
Stool CALLA S75 M PP_TS 	S1920JS	S75	M1	336 €	344 €	357 €	394 €	499 €	370 €	411 €	336 €	357 €	FM-M2 ES-1 PD-F0	1	1	7.0	0.25

Model	Code	Mod.	Frame	Upholstered shell									Optional	Q.ty	boxes	Kg	M ³
				TA	TB	TC	TD	TE	SF	SV	COM	COL					
Stool CALLA S65 M TS 	S1920HT	S65	M1	357 €	377 €	417 €	443 €	592 €	461 €	522 €	357 €	417 €	FM-M2 ES-1 PD-F0	1	1	7.5	0.23
Stool CALLA S75 M TS 	S1920JT	S75	M1	370 €	391 €	432 €	455 €	604 €	471 €	534 €	370 €	432 €	FM-M2 ES-1 PD-F0	1	1	7.5	0.25

Note:

TS Front and Back covering available in two-tone or bi-material. Reference price in the upper category

Frame finishes

Metal	
MI	WHITE BB , BROWN E6 , SAND EC , GRAPHITE EG , BLACK EN



Shell finishes

Polypropylene	
PPI	WHITE PB4 , GRAFITE GREY PGD , SKY GREY PGU , BROWN PM2 , BLACK PN4 , OCHER YELLOW PO2 , RED PRR , RED BULGARO PRS , SAND PS2 , TERRACOTTA PT2 , DARK GREEN PVL

Seat and shell finishes

Upholstery			
TA	FAUX LEATHER Secret , FABRIC Mirage , FABRIC Cotton Club	TB	FAUX LEATHER Vintage , FABRIC Fenix Wool , FABRIC Novabuk , FABRIC Manhattan , FABRIC Visual
TC	VELVET SUPERB, FABRIC Second , FABRIC Main Line Flax , FABRIC Oceanic	TD	FABRIC Yoredale , FABRIC Remix 3
TE	FABRIC Uniform Melange	SF	LEATHER Fiore
SV	LEATHER Vintage		

COM/COL - Minimum Q.ty 6 pc. for each material. For weft or patterned fabrics see specific pages

 COM	M PP_TS Mtl. 0.60 h. 1.40 Each - M TS Mtl. 0.92 h. 1.40 Each	 COL	M PP_TS Mq. 0.70 Each - M TS Mq. 1.90 Each
---	--	--	--

Optionals:

		Value	Options/notes
FM-M2	Indoor matt metal M2	+ 45 €	ASH GREY ES , BRONZE E2 , BULGARO RED FP , CHERRY RED EQ , DARK GREEN EL , FACEPOWDER PINK E8 , FANGO E3 , GOLDEN YELLOW EO , LIGHT BLUE E0 , LIGHT GREY ET , OCEAN BLUE E1 , OCHER YELLOW E7 , PAPAYA ORANGE EA , PASTEL YELLOW E4 , PINE GREEN EJ , RED ER , SAGE GREEN E9
FM-O1	Outdoor metal O1	+ 40 €	Outdoor BLACK EN , Outdoor BROWN E6 , Outdoor GRAFITE EG , Outdoor SAND EC , Outdoor WHITE BB
FM-O2	Outdoor metal O2	+ 91 €	Outdoor ASH GREY ES , Outdoor BRONZE E2 , Outdoor CHERRY RED EQ , Outdoor DARK GREEN EL , Outdoor FACEPOWDER PINK E8 , Outdoor FANGO E3 , Outdoor GOLD YELLOW EO , Outdoor LIGHT BLUE E0 , Outdoor LIGHT GREY ET , Outdoor OCEAN BLUE E1 , Outdoor OCHER YELLOW E7 , Outdoor PAPAYA ORANGE EA , Outdoor PASTEL YELLOW E4 , Outdoor PINE GREEN EJ , Outdoor RED BULGARO FP , Outdoor RED ER , Outdoor SAGE GREEN E9
ES-1	Fireproof foam	+ 5 €	ES-1
PD-F0	Felt pad feet	+ 6 €	PD-F0

Calla S65

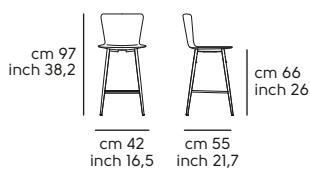



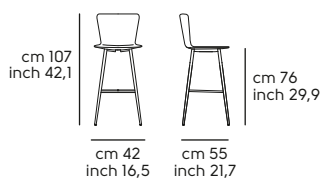

Calla S75





Calla P H65-P H75 - Shell in polypropylene, seat in fabric or leather, shell in fabric or leather

Frame in: metal

Model	Code	Mod.	Frame	Shell									Optional	Q.ty	boxes	Kg	M ³
				PP1													
Stool CALLA P65 M PP 	S1921HP	P65	M1	289 €									FM-M2 FM-O1 FM-O2 PD-F0	1	1	7.0	0.27
Stool CALLA P75 M PP 	S1921JP	P75	M1	301 €									FM-M2 FM-O1 FM-O2 PD-F0	1	1	7.0	0.3

Model	Code	Mod.	Frame	Shell PP1 / Seat									Optional	Q.ty	boxes	Kg	M ³
				TA	TB	TC	TD	TE	SF	SV	COM	COL					
Stool CALLA P65 M PP_TS 	S1921HS	P65	M1	343 €	351 €	364 €	400 €	501 €	376 €	416 €	343 €	364 €	FM-M2 ES-1 PD-F0	1	1	7.0	0.27
Stool CALLA P75 M PP_TS 	S1921JS	P75	M1	356 €	364 €	376 €	414 €	513 €	390 €	431 €	356 €	376 €	FM-M2 ES-1 PD-F0	1	1	7.0	0.3

Model	Code	Mod.	Frame	Upholstered shell									Optional	Q.ty	boxes	Kg	M ³
				TA	TB	TC	TD	TE	SF	SV	COM	COL					
Stool CALLA P65 M TS 	S1921HT	P65	M1	443 €	469 €	520 €	548 €	700 €	546 €	618 €	443 €	520 €	FM-M2 ES-1 PD-F0	1	1	7.5	0.27
Stool CALLA P75 M TS 	S1921JT	P75	M1	457 €	484 €	532 €	563 €	714 €	560 €	632 €	457 €	532 €	FM-M2 ES-1 PD-F0	1	1	7.5	0.3

Note:

TS Front and Back covering available in two-tone or bi-material. Reference price in the upper category

Frame finishes

Metal	
MI	WHITE BB , BROWN E6 , SAND EC , GRAPHITE EG , BLACK EN



Shell finishes

Polypropylene	
PPI	WHITE PB4 , GRAFITE GREY PGD , SKY GREY PGU , BROWN PM2 , BLACK PN4 , OCHER YELLOW PO2 , RED PRR , RED BULGARO PRS , SAND PS2 , TERRACOTTA PT2 , DARK GREEN PVL

Seat and shell finishes

Upholstery	
TA	FAUX LEATHER Secret , FABRIC Mirage , FABRIC Cotton Club
TC	VELVET SUPERB, FABRIC Second , FABRIC Main Line Flax , FABRIC Oceanic
TE	FABRIC Uniform Melange
SV	LEATHER Vintage
TB	FAUX LEATHER Vintage , FABRIC Fenix Wool , FABRIC Novabuk , FABRIC Manhattan , FABRIC Visual
TD	FABRIC Yoredale , FABRIC Remix 3
SF	LEATHER Fiore

COM/COL - Minimum Q.ty 6 pc. for each material. For weft or patterned fabrics see specific pages

 COM	M PP_TS Mtl. 0.60 h. 1.40 Each - M TS Mtl. 1.10 h. 1.40 Each	 COL	M PP_TS Mq. 0.70 Each - M TS Mq. 2.40 Each
---	--	--	--

Optionals:

		Value	Options/notes
FM-M2	Indoor matt metal M2	+ 45 €	ASH GREY ES , BRONZE E2 , BULGARO RED FP , CHERRY RED EQ , DARK GREEN EL , FACEPOWDER PINK E8 , FANGO E3 , GOLDEN YELLOW EO , LIGHT BLUE E0 , LIGHT GREY ET , OCEAN BLUE E1 , OCHER YELLOW E7 , PAPAYA ORANGE EA , PASTEL YELLOW E4 , PINE GREEN EJ , RED ER , SAGE GREEN E9
FM-O1	Outdoor metal O1	+ 40 €	Outdoor BLACK EN , Outdoor BROWN E6 , Outdoor GRAFITE EG , Outdoor SAND EC , Outdoor WHITE BB
FM-O2	Outdoor metal O2	+ 91 €	Outdoor ASH GREY ES , Outdoor BRONZE E2 , Outdoor CHERRY RED EQ , Outdoor DARK GREEN EL , Outdoor FACEPOWDER PINK E8 , Outdoor FANGO E3 , Outdoor GOLD YELLOW EO , Outdoor LIGHT BLUE E0 , Outdoor LIGHT GREY ET , Outdoor OCEAN BLUE E1 , Outdoor OCHER YELLOW E7 , Outdoor PAPAYA ORANGE EA , Outdoor PASTEL YELLOW E4 , Outdoor PINE GREEN EJ , Outdoor RED BULGARO FP , Outdoor RED ER , Outdoor SAGE GREEN E9
ES-1	Fireproof foam	+ 5 €	ES-1
PD-F0	Felt pad feet	+ 6 €	PD-F0

Calla P65

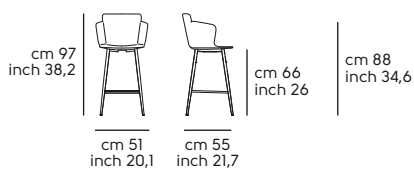



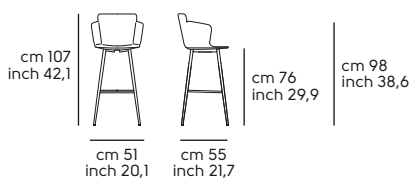

Calla P75





Calla S H65-S H75 - Shell in polypropylene, seat in fabric or leather, shell in fabric or leather

Frame in: wood

Model	Code	Mod.	Frame	Shell								Optional	Q.ty	boxes	Kg	M ³	
PP1																	
Stool CALLA S65 LR PP																	
	S1925HP	S65	LF1	328 €								PD-F0	1	1	7.2	0.25	
Stool CALLA S75 LR PP																	
	S1925JP	S75	LF1	347 €								PD-F0	1	1	7.6	0.28	

Model	Code	Mod.	Frame	Shell PP1 / Seat										Optional	Q.ty	boxes	Kg	M ³
				TA	TB	TC	TD	TE	SF	SV	COM	COL						
Stool CALLA S65 LR PP_TS																		
	S1925HS	S65	LF1	382 €	391 €	402 €	440 €	544 €	416 €	455 €	382 €	402 €	ES-1 PD-F0	1	1	8.1	0.25	
Stool CALLA S75 LR PP_TS																		
	S1925JS	S75	LF1	400 €	406 €	421 €	457 €	561 €	433 €	473 €	400 €	421 €	ES-1 PD-F0	1	1	8.35	0.28	

Model	Code	Mod.	Frame	Upholstered shell										Optional	Q.ty	boxes	Kg	M ³
				TA	TB	TC	TD	TE	SF	SV	COM	COL						
Stool CALLA S65 LR TS																		
	S1925HT	S65	LF1	416 €	436 €	476 €	502 €	651 €	520 €	580 €	416 €	476 €	ES-1 PD-F0	1	1	8.6	0.25	
Stool CALLA S75 LR TS																		
	S1925JT	S75	LF1	433 €	454 €	494 €	519 €	667 €	534 €	599 €	433 €	494 €	ES-1 PD-F0	1	1	8.8	0.28	

Note:

TS Front and Back covering available in two-tone or bi-material. Reference price in the upper category

Frame finishes

Wood

LFI	Ash wood painted GREY F02 , Ash wood painted GRAFITE GREY F03 , Ash wood painted BLACK F04 , Ash wood painted WHITE F05 , Ash wood painted BLUE F06 , Ash wood painted RED F08 , Ash wood painted CHERRY RED F09 , Ash wood painted FLAMED WALNUT F24 , Ash wood painted DARK BROWN F26 , Ash wood painted NATURAL F40 , Ash wood painted NATURAL OAK F52
------------	--

Shell finishes

Polypropylene

PPI	WHITE PB4 , GRAFITE GREY PGD , SKY GREY PGU , BROWN PM2 , BLACK PN4 , OCHER YELLOW PO2 , RED PRR , RED BULGARO PRS , SAND PS2 , TERRACOTTA PT2 , DARK GREEN PVL
------------	--

Seat and shell finishes

Upholstery

TA	FAUX LEATHER Secret , FABRIC Mirage , FABRIC Cotton Club	TB	FAUX LEATHER Vintage , FABRIC Fenix Wool , FABRIC Novabuk , FABRIC Manhattan , FABRIC Visual
TC	VELVET SUPERB, FABRIC Second , FABRIC Main Line Flax , FABRIC Oceanic	TD	FABRIC Yoredale , FABRIC Remix 3
TI	FABRIC Uniform Melange	SF	LEATHER Fiore
SV	LEATHER Vintage		

COM/COL - Minimum Q.ty 6 pc. for each material. For weft or patterned fabrics see specific pages

COM	M PP_TS Mtl. 0.60 h. 1.40 Each - M TS Mtl. 0.92 h. 1.40 Each	COL	M PP_TS Mq. 0.70 Each - M TS Mq. 1.90 Each
------------	--	------------	--

Optionals:

		Value	Options/notes
ES-1	Fireproof foam	+ 6 €	ES-1
PD-F0	Felt pad feet	+ 6 €	PD-F0

Calla S65 LR PP

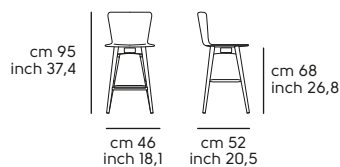

Calla S75 LR PP

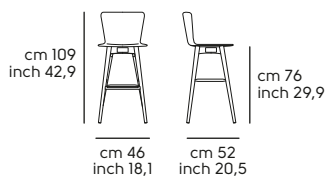

Calla S65 LR PP_TS

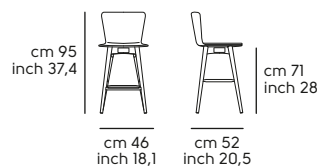

Calla S75 LR PP_TS

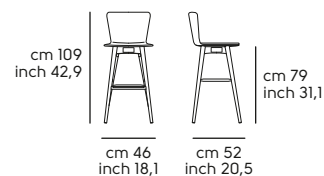

Calla S65 LR TS

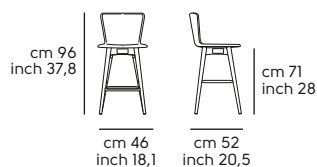



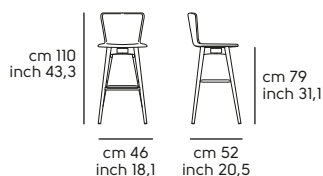

Calla S75 LR TS





Calla P H65-P H75 - Shell in polypropylene, seat in fabric or leather, shell in fabric or leather

Frame in: wood

Model	Code	Mod.	Frame	Shell								Optional	Q.ty	boxes	Kg	M ³	
PP1																	
Stool CALLA P65 LR PP 	S1926HP	P65	LF1	348 €								PD-F0	1	1	7.6	0.31	
Stool CALLA P75 LR PP 	S1926JP	P75	LF1	365 €								PD-F0	1	1	7.9	0.33	

Model	Code	Mod.	Frame	Shell PP1 / Seat									Optional	Q.ty	boxes	Kg	M ³
				TA	TB	TC	TD	TE	SF	SV	COM	COL					
Stool CALLA P65 LR PP_TS 	S1926HS	P65	LF1	401 €	410 €	422 €	459 €	559 €	435 €	475 €	401 €	422 €	ES-1 PD-F0	1	1	8.0	0.31
Stool CALLA P75 LR PP_TS 	S1926JS	P75	LF1	420 €	426 €	440 €	477 €	578 €	453 €	492 €	420 €	440 €	ES-1 PD-F0	1	1	8.4	0.33

Model	Code	Mod.	Frame	Upholstered shell									Optional	Q.ty	boxes	Kg	M ³
				TA	TB	TC	TD	TE	SF	SV	COM	COL					
Stool CALLA P65 LR TS 	S1926HT	P65	LF1	502 €	528 €	578 €	607 €	758 €	604 €	677 €	502 €	578 €	ES-1 PD-F0	1	1	8.45	0.31
Stool CALLA P75 LR TS 	S1926JT	P75	LF1	521 €	547 €	596 €	625 €	777 €	623 €	696 €	521 €	596 €	ES-1 PD-F0	1	1	8.8	0.33

Note:

TS Front and Back covering available in two-tone or bi-material. Reference price in the upper category

Frame finishes

Wood

LFI	Ash wood painted GREY F02 , Ash wood painted GRAFITE GREY F03 , Ash wood painted BLACK F04 , Ash wood painted WHITE F05 , Ash wood painted BLUE F06 , Ash wood painted RED F08 , Ash wood painted CHERRY RED F09 , Ash wood painted FLAMED WALNUT F24 , Ash wood painted DARK BROWN F26 , Ash wood painted NATURAL F40 , Ash wood painted NATURAL OAK F52
------------	--

Shell finishes

Polypropylene

PPI	WHITE PB4 , GRAFITE GREY PGD , SKY GREY PGU , BROWN PM2 , BLACK PN4 , OCHER YELLOW PO2 , RED PRR , RED BULGARO PRS , SAND PS2 , TERRACOTTA PT2 , DARK GREEN PVL
------------	--

Seat and shell finishes

Upholstery

TA	FAUX LEATHER Secret , FABRIC Mirage , FABRIC Cotton Club	TB	FAUX LEATHER Vintage , FABRIC Fenix Wool , FABRIC Novabuk , FABRIC Manhattan , FABRIC Visual
TC	VELVET SUPERB, FABRIC Second , FABRIC Main Line Flax , FABRIC Oceanic	TD	FABRIC Yoredale , FABRIC Remix 3
TI	FABRIC Uniform Melange	SF	LEATHER Fiore
SV	LEATHER Vintage		

COM/COL - Minimum Q.ty 6 pc. for each material. For weft or patterned fabrics see specific pages

COM	M PP_TS Mtl. 0.60 h. 1.40 Each - M TS Mtl. 1.10 h. 1.40 Each	COL	M PP_TS Mq. 0.70 Each - M TS Mq. 2.40 Each
------------	--	------------	--

Optionals:

		Value	Options/notes
ES-1	Fireproof foam	+ 6 €	ES-1
PD-F0	Felt pad feet	+ 6 €	PD-F0

Calla P65 LR PP

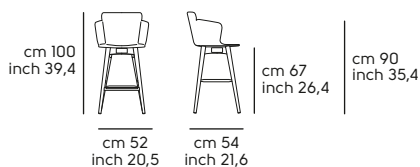

Calla P75 LR PP

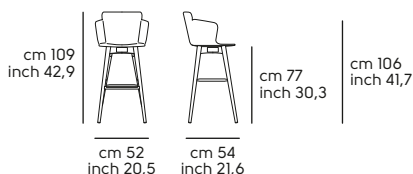

Calla P65 LR PP_TS

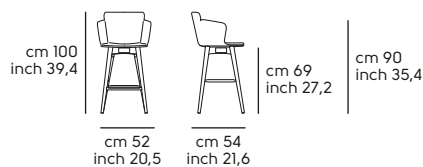

Calla P75 LR PP_TS

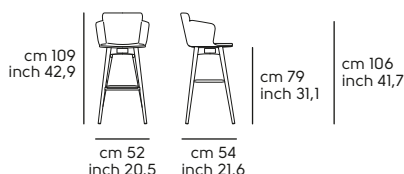

Calla P65 LR TS

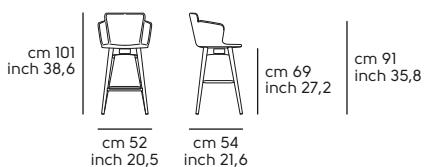



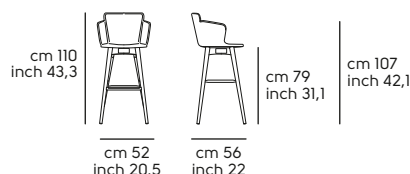

Calla P75 LR TS





Calla SG - Shell in polypropylene, seat in fabric or leather, shell in fabric or leather

Frame in: metal

Model	Code	Mod.	Frame	Shell								Optional	Q.ty	boxes	Kg	M ³
PP1																
Stool CALLA S SG PP 	S1920ZP	S	M1	491 €								FM-M2	1	1	16.6	0.26
Stool CALLA P SG PP 	S1921ZP	P	M1	511 €								FM-M2	1	1	17.0	0.3

Model	Code	Mod.	Frame	Shell PP1 / Seat									Optional	Q.ty	boxes	Kg	M ³
				TA	TB	TC	TD	TE	SF	SV	COM	COL					
Stool CALLA S SG PP_TS 	S1920ZS	S	M1	547 €	554 €	567 €	604 €	708 €	580 €	618 €	547 €	567 €	FM-M2 ES-1	1	1	17.0	0.26
Stool CALLA P SG PP_TS 	S1921ZS	P	M1	566 €	573 €	587 €	623 €	723 €	599 €	638 €	566 €	587 €	FM-M2 ES-1	1	1	17.4	0.3

Model	Code	Mod.	Frame	Upholstered shell									Optional	Q.ty	boxes	Kg	M ³
				TA	TB	TC	TD	TE	SF	SV	COM	COL					
Stool CALLA S SG TS 	S1920ZT	S	M1	580 €	600 €	639 €	666 €	815 €	684 €	744 €	580 €	639 €	FM-M2 ES-1	1	1	17.5	0.26
Stool CALLA P SG TS 	S1921ZT	P	M1	666 €	692 €	742 €	771 €	923 €	769 €	841 €	666 €	742 €	FM-M2 ES-1	1	1	17.9	0.3

Note:

TS Front and Back covering available in two-tone or bi-material. Reference price in the upper category

Frame finishes

Metal	
MI	WHITE BB , BROWN E6 , SAND EC , GRAPHITE EG , BLACK EN



Shell finishes

Polypropylene	
PPI	WHITE PB4 , GRAFITE GREY PGD , SKY GREY PGU , BROWN PM2 , BLACK PN4 , OCHER YELLOW PO2 , RED PRR , RED BULGARO PRS , SAND PS2 , TERRACOTTA PT2 , DARK GREEN PVL



Seat and shell finishes

Upholstery	
TA	FAUX LEATHER Secret , FABRIC Mirage , FABRIC Cotton Club
TC	VELVET SUPERB, FABRIC Second , FABRIC Main Line Flax , FABRIC Oceanic
TI	FABRIC Uniform Melange
SV	LEATHER Vintage
TB	FAUX LEATHER Vintage , FABRIC Fenix Wool , FABRIC Novabuk , FABRIC Manhattan , FABRIC Visual
TD	FABRIC Yoredale , FABRIC Remix 3
SF	LEATHER Fiore

COM/COL - Minimum Q.ty 6 pc. for each material. For weft or patterned fabrics see specific pages

	S SG PP_TS Mtl. 0.60 h. 1.40 Each - S SG TS Mtl. 0.92 h. 1.40 Each		S SG PP_TS Mq. 0.70 Each - S SG TS Mq. 1.90 Each
--	--	---	--

COM/COL - Minimum Q.ty 6 pc. for each material. For weft or patterned fabrics see specific pages

	P SG PP_TS Mtl. 0.60 h. 1.40 Each - P SG TS Mtl. 1.10 h. 1.40 Each		P SG PP_TS Mq. 0.70 Each - P SG TS Mq. 2.40 Each
--	--	---	--

Optionals:

	Value	Options/notes
FM-M2	+ 45 €	Indoor matt metal M2 ASH GREY ES , BRONZE E2 , BULGARO RED FP , CHERRY RED EQ , DARK GREEN EL , FACEPOWDER PINK E8 , FANGO E3 , GOLDEN YELLOW EO , LIGHT BLUE EO , LIGHT GREY ET , OCEAN BLUE E1 , OCHER YELLOW E7 , PAPAYA ORANGE EA , PASTEL YELLOW E4 , PINE GREEN EJ , RED ER , SAGE GREEN E9
ES-1	+ 6 €	Fireproof foam ES-1

Calla S SG PP

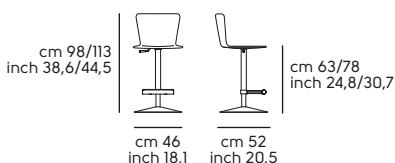

Calla P SG PP

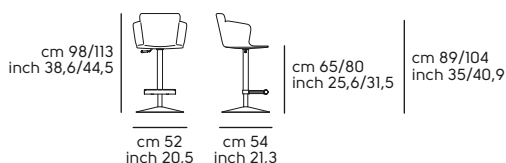

Calla S SG PP_TS

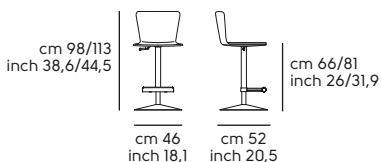

Calla P SG PP_TS

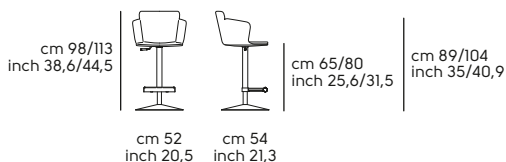

Calla S SG TS

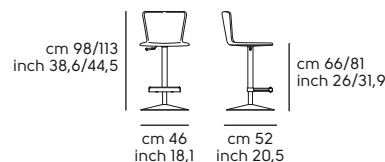



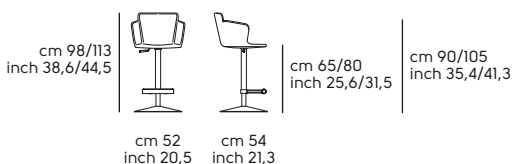

Calla P SG TS



Cover design Midj R&D

Cover S - Shell in fabric or leather

Frame in: metal or wood

Model	Code	Base type	Frame	Shell									Optional	Q.ty	boxes	Kg	M ²
				TA	TB	TC	TD	TE	SF	SV	COM	COL					
 Chair COVER S M_M TS 	S1071MT_M	_M	M1	229 €	242 €	278 €	306 €	417 €	328 €	390 €	229 €	278 €	FM-M2 FM-M3 ES-1 PD-F0	2 4	1 1	16.0 30.0	0.35 0.45
 Chair COVER S M_T TS	S1071MT_T	_T	M1	249 €	262 €	298 €	326 €	437 €	348 €	410 €	249 €	298 €	FM-M2 FM-M3 ES-1	2	1	16.0	0.38
 Chair COVER S M_Q TS	S1071MT_Q	_Q	M1	264 €	277 €	313 €	341 €	452 €	363 €	425 €	264 €	313 €	FM-M2 ES-1 PD-F0	2	1	16.0	0.26
 Chair COVER S L_R TS	S1071WO_R	_R	LF1	320 €	334 €	369 €	396 €	508 €	417 €	481 €	320 €	369 €	ES-1 PD-F0	2	1	14.5	0.46

Frame finishes

Metal

MI WHITE **BB**, BROWN **E6**, SAND **EC**, GRAPHITE **EG**, BLACK **EN**

Wood

LF1

Ash wood painted GREY **F02**, Ash wood painted GRAFITE GREY **F03**, Ash wood painted BLACK **F04**, Ash wood painted WHITE **F05**, Ash wood painted BLUE **F06**, Ash wood painted RED **F08**, Ash wood painted CHERRY RED **F09**, Ash wood painted FLAMED WALNUT **F24**, Ash wood painted DARK BROWN **F26**, Ash wood painted NATURAL **F40**, Ash wood painted NATURAL OAK **F52**

Shell finishes

Upholstery

TA FAUX LEATHER **Secret**, FABRIC **Mirage**, FABRIC **Cotton Club**

TC VELVET SUPERB, FABRIC **Second**, FABRIC **Main Line Flax**, FABRIC **Oceanic**

TI FABRIC **Uniform Melange**

SV LEATHER **Vintage**

TB FAUX LEATHER **Vintage**, FABRIC **Fenix Wool**, FABRIC **Novabuk**, FABRIC **Manhattan**, FABRIC **Visual**

TD FABRIC **Yoredale**, FABRIC **Remix 3**

SF LEATHER **Fiore**

COM/COL - Minimum Q.ty 6 pc. for each material. For weft or patterned fabrics see specific pages

COM Mtl. 0.80 h. 1.40 Each

COL Mq. 1.43 Each

Optionals:		Value	Options/notes
FM-M2	Indoor matt metal M2	+ 45 €	ASH GREY ES , BRONZE E2 , BULGARO RED FP , CHERRY RED EQ , DARK GREEN EL , FACEPOWDER PINK E8 , FANGO E3 , GOLDEN YELLOW EO , LIGHT BLUE EO , LIGHT GREY ET , OCEAN BLUE EI , OCHER YELLOW E7 , PAPAYA ORANGE EA , PASTEL YELLOW E4 , PINE GREEN EJ , RED ER , SAGE GREEN E9
FM-M3	Indoor glossy metal M3	+ 20 €	CHROME CC
ES-1	Fireproof foam	+ 4 €	ES-1
PD-F0	Felt pad feet	+ 6 €	PD-F0

Cover S_M

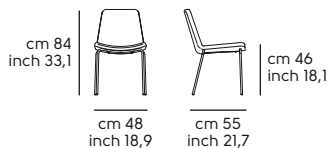

Cover S_T

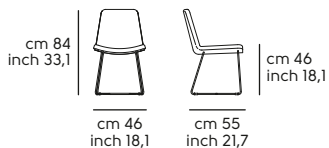

Cover S_Q

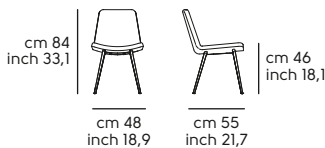

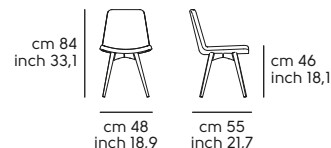

Cover S_R





Cover P, AT, H65-75-SG - Shell in fabric or leather

Frame in: metal or wood



Model	Code	Mod.	Frame	Shell									Optional	Q.ty	boxes	Kg	M³
				TA	TB	TC	TD	TE	SF	SV	COM	COL					
Armch. COVER P M TS 	S1070PT	P	MI	258 €	271 €	308 €	334 €	446 €	356 €	416 €	258 €	308 €	FM-M2 FM-M3 ES-1	2	1	18.5	0.35
Armch. COVER P M TV TS 	S1070P9	P-TV	MI	306 €	317 €	354 €	381 €	492 €	403 €	465 €	306 €	354 €	FM-M2 FM-M3 ES-1	2	1	18.5	0.35









COM/COL - Minimum Q.ty 6 pc. for each material. For weft or patterned fabrics see specific pages

 Mtl. 0.80 h. 1.40 Each	 Mq. 1.43 Each
---	---

Model	Code	Mod.	Frame	Shell									Optional	Q.ty	boxes	Kg	M³
				TA	TB	TC	TD	TE	SF	SV	COM	COL					
Waiting Chair COVER AT M TS 	S1070LT	AT	MI	433 €	477 €	510 €	527 €	630 €	542 €	659 €	433 €	510 €	FM-M2 FM-M3 ES-1	1	1	11.5	0.35

COM/COL - Minimum Q.ty 6 pc. for each material. For weft or patterned fabrics see specific pages

 Mtl. 1.05 h. 1.40 Each	 Mq. 2.09 Each
---	---

Model	Code	Mod.	Frame	Shell									Optional	Q.ty	boxes	Kg	M ²
				TA	TB	TC	TD	TE	SF	SV	COM	COL					
Stool COVER H65 M TS  	S1070H0	H65	M1	243 €	256 €	277 €	286 €	349 €	335 €	362 €	243 €	277 €	FM-M2 FM-M3 ES-1 PD-F0	2	1	14.0	0.23 0.27
Stool COVER H75 M TS   	S1070J0	H75	M1	256 €	269 €	289 €	298 €	361 €	349 €	375 €	256 €	289 €	FM-M2 FM-M3 ES-1 PD-F0	2	1	15.0	0.25 0.32
Stool COVER H65 LR TS 	S1070HW	H65 LR	LF1	301 €	314 €	335 €	344 €	406 €	394 €	421 €	301 €	335 €	ES-1 PD-F0	1	1	6.7	0.18
Stool COVER H75 LR TS 	S1070JW	H75 LR	LF1	305 €	316 €	337 €	347 €	410 €	396 €	423 €	305 €	337 €	ES-1 PD-F0	1	1	7.0	0.22
Stool COVER SG TS  	S1070ZT	SG	M1	506 €	519 €	539 €	548 €	611 €	599 €	625 €	506 €	539 €	FM-M2	1	1	17.0	0.2

COM/COL - Minimum Q.ty 6 pc. for each material. For weft or patterned fabrics see specific pages

	Mtl. 0.45 h. 1.40 Each		Mq. 1.01 Each
---	------------------------	---	---------------

Frame finishes

Metal

MI	WHITE BB , BROWN E6 , SAND EC , GRAPHITE EG , BLACK EN
-----------	---

Wood

LFI	Ash wood painted GREY F02 , Ash wood painted GRAFITE GREY F03 , Ash wood painted BLACK F04 , Ash wood painted WHITE F05 , Ash wood painted BLUE F06 , Ash wood painted RED F08 , Ash wood painted CHERRY RED F09 , Ash wood painted FLAMED WALNUT F24 , Ash wood painted DARK BROWN F26 , Ash wood painted NATURAL F40 , Ash wood painted NATURAL OAK F52
------------	--

Shell finishes

Upholstery

TA	FAUX LEATHER Secret , FABRIC Mirage , FABRIC Cotton Club	TB	FAUX LEATHER Vintage , FABRIC Fenix Wool , FABRIC Novabuk , FABRIC Manhattan , FABRIC Visual
TC	VELVET SUPERB, FABRIC Second , FABRIC Main Line Flax , FABRIC Oceanic	TD	FABRIC Yoredale , FABRIC Remix 3
TE	FABRIC Uniform Melange	SF	LEATHER Fiore
SV	LEATHER Vintage		

Optionals:

		Value	Options/notes
FM-M2	Indoor matt metal M2	+ 45 €	ASH GREY ES , BRONZE E2 , BULGARO RED FP , CHERRY RED EQ , DARK GREEN EL , FACEPOWDER PINK E8 , FANGO E3 , GOLDEN YELLOW EO , LIGHT BLUE EO , LIGHT GREY ET , OCEAN BLUE EI , OCHER YELLOW E7 , PAPAYA ORANGE EA , PASTEL YELLOW E4 , PINE GREEN EJ , RED ER , SAGE GREEN E9
FM-M3	Indoor glossy metal M3	+ 20 €	CHROME CC
ES-1	Fireproof foam	+ 6 €	ES-1
PD-F0	Felt pad feet	+ 6 €	PD-F0

Cover P

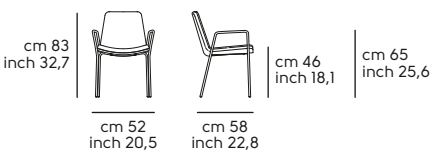

Cover P-TV

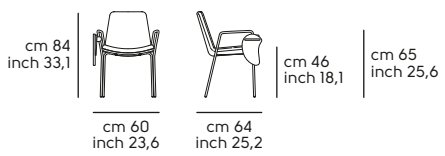

Cover AT

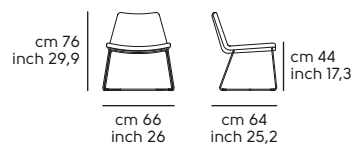

Cover H65

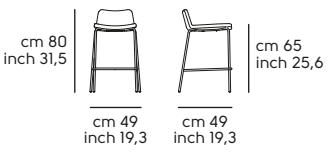

Cover H75

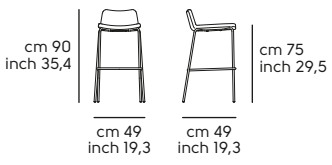

Cover H65 LR

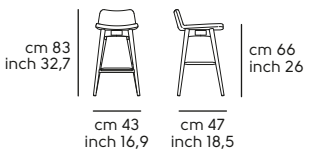

Cover H75 LR

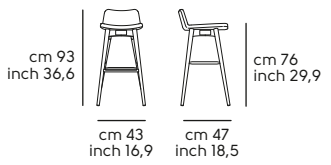



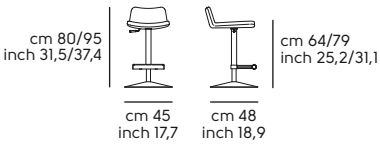





Cover SG



Dalia design Beatriz Sempere

Dalia S, DS - Shell in fabric or leather

Frame in: metal or wood

Model	Code	Base type	Frame	Shell									Optional	Q.ty	boxes	Kg	M³
				TA	TB	TC	TD	TE	SF	SV	COM	COL					
Chair DALIA S M_M TS 	S185ISM_M	_M	MI	288 €	329 €	375 €	386 €	476 €	463 €	565 €	288 €	375 €	FM-M2 FM-M3 PD-F0	2	1	18.5	0.51
Chair DALIA S M_T TS 	S185ISM_T	_T	MI	312 €	353 €	399 €	410 €	500 €	487 €	589 €	312 €	399 €	FM-M2 FM-M3	2	1	19.2	0.44
Chair DALIA S M_Q TS 	S185ISM_Q	_Q	MI	334 €	375 €	421 €	432 €	522 €	509 €	611 €	334 €	421 €	FM-M2 PD-F0	2	1	19.3	0.47
Chair DALIA S L_R TS 	S185ISL_R	_R	LF1	377 €	420 €	466 €	478 €	566 €	552 €	655 €	377 €	466 €	PD-F0	2	1	18.0	0.47
Chair DALIA S L_N TS 	S185ISL_N	_N	LII	476 €	519 €	565 €	577 €	665 €	651 €	754 €	476 €	565 €	FL-I2 PD-F0	2	1	18.0	0.47
Chair DALIA S X47 TS 	S185ISX	X47	MI	477 €	519 €	565 €	575 €	665 €	652 €	754 €	477 €	565 €	FM-M2	1	1	11.4	0.32
Chair with self-return DALIA S X47 TS 	S185ISY	X47	MI	509 €	551 €	597 €	609 €	698 €	685 €	786 €	509 €	597 €	FM-M2	1	1	11.4	0.32
Office Chair DALIA DS TS 	S1850DS	DS	MI	520 €	560 €	608 €	618 €	707 €	695 €	796 €	520 €	608 €	FM-M2,	1	2	13.7	0.29
Office Chair DALIA DS 47 TS 	S1850DS	DS 47	MI	520 €	560 €	608 €	618 €	707 €	695 €	796 €	520 €	608 €	FM-M2,	1	2	13.7	0.29

Note:

TS Front and Back covering available in two-tone or bi-material. Reference price in the upper category

Frame finishes

Metal	
MI	WHITE BB , BROWN E6 , SAND EC , GRAPHITE EG , BLACK EN

Wood	
LFI	Ash wood painted GREY F02 , Ash wood painted GRAFITE GREY F03 , Ash wood painted BLACK F04 , Ash wood painted WHITE F05 , Ash wood painted BLUE F06 , Ash wood painted RED F08 , Ash wood painted CHERRY RED F09 , Ash wood painted FLAMED WALNUT F24 , Ash wood painted DARK BROWN F26 , Ash wood painted NATURAL F40 , Ash wood painted NATURAL OAK F52
LII	Veneered wood painted GREY I02 , Veneered wood painted GRAFITE GREY I03 , Veneered wood painted BLACK I04 , Veneered wood painted WHITE I05 , Veneered wood painted BLUE I06 , Veneered wood painted RED I08 , Veneered wood painted CHERRY RED I09 , Veneered wood painted DARK BROWN I26 , Veneered wood painted NATURAL I40 , Veneered wood painted NATURAL OAK I52

Shell finishes

Upholstery	
TA	FAUX LEATHER Secret , FABRIC Mirage , FABRIC Cotton Club
TC	VELVET SUPERB, FABRIC Second , FABRIC Main Line Flax , FABRIC Oceanic
TE	FABRIC Uniform Melange
SV	LEATHER Vintage
TB	FAUX LEATHER Vintage , FABRIC Fenix Wool , FABRIC Novabuk , FABRIC Manhattan , FABRIC Visual
TD	FABRIC Yoredale , FABRIC Remix 3
SF	LEATHER Fiore

COM/COL - Minimum Q.ty 6 pc. for each material. For weft or patterned fabrics see specific pages

COM	Mtl. 0.80 h. 1.40 Each	COL	Mq. 1.73 Each
------------	------------------------	------------	---------------

Optionals:

	Value	Options/notes
FM-M2	+ 45 €	ASH GREY ES , BRONZE E2 , BULGARO RED FP , CHERRY RED EQ , DARK GREEN EL , FACEPOWDER PINK E8 , FANGO E3 , GOLDEN YELLOW EO , LIGHT BLUE E0 , LIGHT GREY ET , OCEAN BLUE EI , OCHER YELLOW E7 , PAPAYA ORANGE EA , PASTEL YELLOW E4 , PINE GREEN EJ , RED ER , SAGE GREEN E9
FM-M3	+ 20 €	CHROME CC
FL-I2	+ 8 €	Veneered wood FLAMED WALNUT I24 , Veneered wood NATURAL OAK I22
PD-F0	+ 6 €	PD-F0

Dalia S_M

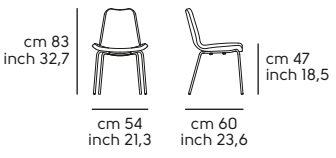

Dalia S_T

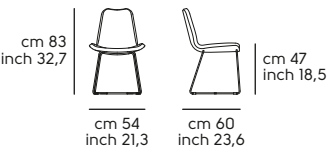

Dalia S_Q

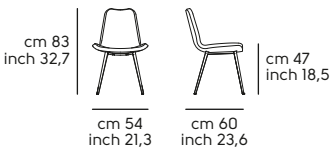

Dalia S_R

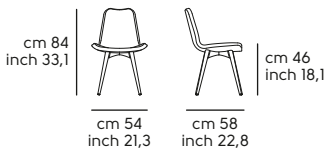

Dalia S_N

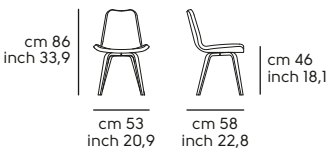

Dalia S_X47





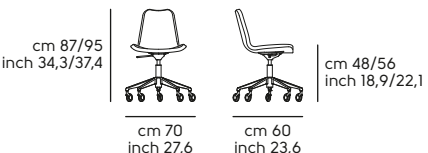





Dalia S_DS



Dalia PB, DPB - Shell in fabric or leather

Frame in: metal or wood

Model	Code	Base type	Frame	Shell									Optional	Q.ty	boxes	Kg	M ²
				TA	TB	TC	TD	TE	SF	SV	COM	COL					
Armch. DALIA PB M_MTS 	S1851PB_M	_M	M1	371 €	412 €	469 €	479 €	602 €	585 €	702 €	371 €	469 €	FM-M2 FM-M3 PD-F0	1	1	11.1	0.35
Armch. DALIA PB M_TTS 	S1851PB_T	_T	M1	394 €	435 €	492 €	502 €	625 €	608 €	725 €	394 €	492 €	FM-M2 FM-M3	1	1	11.4	0.35
Armch. DALIA PB M_QTS 	S1851PB_Q	_Q	M1	416 €	457 €	514 €	524 €	647 €	630 €	747 €	416 €	514 €	FM-M2 PD-F0	1	1	11.5	0.34
Armch. DALIA PB L_RTS 	S1851LB_R	_R	LF1	462 €	502 €	560 €	569 €	689 €	674 €	793 €	462 €	560 €	PD-F0	1	1	10.8	0.35
Armch. DALIA PB L_NTS 	S1851LB_N	_N	L11	560 €	600 €	658 €	667 €	787 €	772 €	891 €	560 €	658 €	FL-I2 PD-F0	1	1	10.8	0.35
Armch. DALIA PB X47TS 	S1851BX	X47	M1	560 €	600 €	658 €	667 €	792 €	774 €	891 €	560 €	658 €	FM-M2	1	1	11.7	0.31
Armch. with self-return DALIA PB X47TS 	S1851BY	X47	M1	592 €	633 €	691 €	700 €	824 €	806 €	924 €	592 €	691 €	FM-M2	1	1	11.7	0.31
Office Arm. DALIA DPB TS 	S1850EB	DPB	M1	603 €	644 €	702 €	711 €	833 €	816 €	933 €	603 €	702 €	FM-M2,	1	2	15.0	0.3
Office Arm. DALIA DPB 47TS 	S1850EB	DPB 47	M1	603 €	644 €	702 €	711 €	833 €	816 €	933 €	603 €	702 €	FM-M2,	1	2	15.0	0.3

Note:

TS Front and Back covering available in two-tone or bi-material. Reference price in the upper category

Frame finishes

Metal	
MI	WHITE BB , BROWN E6 , SAND EC , GRAPHITE EG , BLACK EN

Wood	
LFI	Ash wood painted GREY F02 , Ash wood painted GRAFITE GREY F03 , Ash wood painted BLACK F04 , Ash wood painted WHITE F05 , Ash wood painted BLUE F06 , Ash wood painted RED F08 , Ash wood painted CHERRY RED F09 , Ash wood painted FLAMED WALNUT F24 , Ash wood painted DARK BROWN F26 , Ash wood painted NATURAL F40 , Ash wood painted NATURAL OAK F52
LII	Veneered wood painted GREY I02 , Veneered wood painted GRAFITE GREY I03 , Veneered wood painted BLACK I04 , Veneered wood painted WHITE I05 , Veneered wood painted BLUE I06 , Veneered wood painted RED I08 , Veneered wood painted CHERRY RED I09 , Veneered wood painted DARK BROWN I26 , Veneered wood painted NATURAL I40 , Veneered wood painted NATURAL OAK I52

Shell finishes

Upholstery	
TA	FAUX LEATHER Secret , FABRIC Mirage , FABRIC Cotton Club
TC	VELVET SUPERB, FABRIC Second , FABRIC Main Line Flax , FABRIC Oceanic
TE	FABRIC Uniform Melange
SV	LEATHER Vintage
TB	FAUX LEATHER Vintage , FABRIC Fenix Wool , FABRIC Novabuk , FABRIC Manhattan , FABRIC Visual
TD	FABRIC Yoredale , FABRIC Remix 3
SF	LEATHER Fiore

COM/COL - Minimum Q.ty 6 pc. for each material. For weft or patterned fabrics see specific pages

COM	Mtl. 1.10 h. 1.40 Each	COL	Mq. 2.35 Each
------------	------------------------	------------	---------------

Optionals:

	Value	Options/notes
FM-M2	+ 45 €	ASH GREY ES , BRONZE E2 , BULGARO RED FP , CHERRY RED EQ , DARK GREEN EL , FACEPOWDER PINK E8 , FANGO E3 , GOLDEN YELLOW EO , LIGHT BLUE E0 , LIGHT GREY ET , OCEAN BLUE E1 , OCHER YELLOW E7 , PAPAYA ORANGE EA , PASTEL YELLOW E4 , PINE GREEN EJ , RED ER , SAGE GREEN E9
FM-M3	+ 20 €	CHROME CC
FL-I2	+ 8 €	Veneered wood FLAMED WALNUT I24 , Veneered wood NATURAL OAK I22
PD-F0	+ 6 €	PD-F0

Dalia PB_M

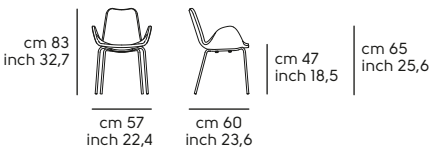

Dalia PB_T

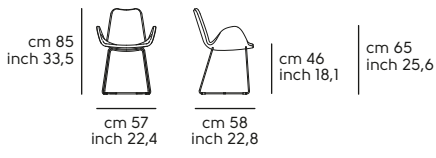

Dalia PB_Q

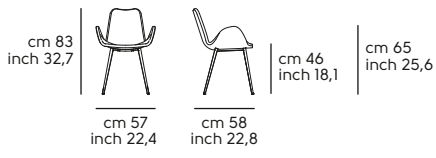

Dalia PB_R

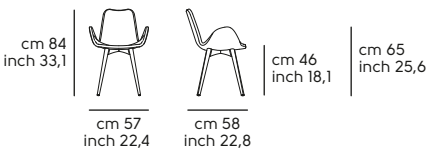

Dalia PB_N

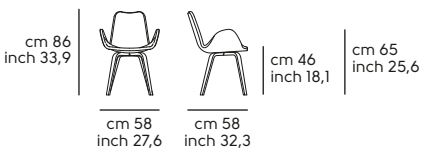

Dalia PB_X47

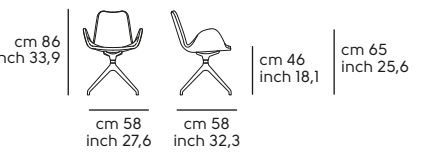



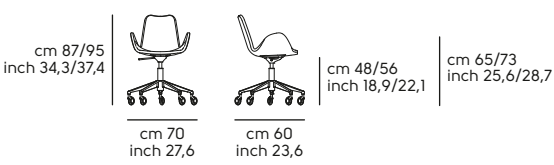





Dalia PB_DPB



Dalia PA, DPA - Shell in fabric or leather

Frame in: metal or wood

Model	Code	Base type	Frame	Shell									Optional	Q.ty	boxes	Kg	M ²
				TA	TB	TC	TD	TE	SF	SV	COM	COL					
Armch. DALIA PA M_M TS 	S1851PA_M	_M	M1	406 €	461 €	512 €	533 €	656 €	636 €	755 €	406 €	512 €	FM-M2 FM-M3 PD-F0	1	1	11.4	0.48
Armch. DALIA PA M_T TS 	S1851PA_T	_T	M1	429 €	484 €	535 €	556 €	679 €	659 €	778 €	429 €	535 €	FM-M2 FM-M3	1	1	11.8	0.41
Armch. DALIA PA M_Q TS 	S1851PA_Q	_Q	M1	450 €	505 €	556 €	577 €	700 €	680 €	799 €	450 €	556 €	FM-M2 PD-F0	1	1	11.8	0.41
Armch. DALIA PA L_R TS 	S1851LA_R	_R	LF1	495 €	549 €	601 €	622 €	748 €	726 €	844 €	495 €	601 €	PD-F0	1	1	11.2	0.41
Armch. DALIA PA L_N TS 	S1851LA_N	_N	L11	593 €	647 €	699 €	720 €	846 €	824 €	942 €	593 €	699 €	FL-I2 PD-F0	1	1	11.2	0.41
Armch. DALIA PA X47 TS 	S1851AX	X47	M1	596 €	649 €	701 €	722 €	843 €	824 €	944 €	596 €	701 €	FM-M2	1	1	12.25	0.4
Armch. with self-return DALIA PA X47 TS 	S1851AY	X47	M1	629 €	683 €	734 €	755 €	877 €	858 €	977 €	629 €	734 €	FM-M2	1	1	12.25	0.4
Office Arm. DALIA DPA TS 	S1850EA	DPA	M1	638 €	692 €	743 €	764 €	887 €	867 €	987 €	638 €	743 €	FM-M2,	1	2	15.8	0.36
Office Arm. DALIA DPA 47 TS 	S1850EA	DPA 47	M1	638 €	692 €	743 €	764 €	887 €	867 €	987 €	638 €	743 €	FM-M2,	1	2	15.8	0.36

Note:

TS Front and Back covering available in two-tone or bi-material. Reference price in the upper category

Frame finishes

Metal

MI	WHITE BB , BROWN E6 , SAND EC , GRAPHITE EG , BLACK EN
-----------	---

Wood

LFI	Ash wood painted GREY F02 , Ash wood painted GRAFITE GREY F03 , Ash wood painted BLACK F04 , Ash wood painted WHITE F05 , Ash wood painted BLUE F06 , Ash wood painted RED F08 , Ash wood painted CHERRY RED F09 , Ash wood painted FLAMED WALNUT F24 , Ash wood painted DARK BROWN F26 , Ash wood painted NATURAL F40 , Ash wood painted NATURAL OAK F52
LII	Veneered wood painted GREY I02 , Veneered wood painted GRAFITE GREY I03 , Veneered wood painted BLACK I04 , Veneered wood painted WHITE I05 , Veneered wood painted BLUE I06 , Veneered wood painted RED I08 , Veneered wood painted CHERRY RED I09 , Veneered wood painted DARK BROWN I26 , Veneered wood painted NATURAL I40 , Veneered wood painted NATURAL OAK I52

Shell finishes

Upholstery

TA	FAUX LEATHER Secret , FABRIC Mirage , FABRIC Cotton Club	TB	FAUX LEATHER Vintage , FABRIC Fenix Wool , FABRIC Novabuk , FABRIC Manhattan , FABRIC Visual
TC	VELVET SUPERB, FABRIC Second , FABRIC Main Line Flax , FABRIC Oceanic	TD	FABRIC Yoredate , FABRIC Remix 3
TE	FABRIC Uniform Melange	SF	LEATHER Fiore
SV	LEATHER Vintage		

COM/COL - Minimum Q.ty 6 pc. for each material. For weft or patterned fabrics see specific pages

COM	Mtl. 1.10 h. 1.40 Each	COL	Mq. 2.89 Each
------------	------------------------	------------	---------------

Optionals:

	Value	Options/notes
FM-M2	+ 45 €	ASH GREY ES , BRONZE E2 , BULGARO RED FP , CHERRY RED EQ , DARK GREEN EL , FACEPOWDER PINK E8 , FANGO E3 , GOLDEN YELLOW EO , LIGHT BLUE E0 , LIGHT GREY ET , OCEAN BLUE E1 , OCHER YELLOW E7 , PAPAYA ORANGE EA , PASTEL YELLOW E4 , PINE GREEN EJ , RED ER , SAGE GREEN E9
FM-M3	+ 20 €	CHROME CC
FL-I2	+ 8 €	Veneered wood FLAMED WALNUT I24 , Veneered wood NATURAL OAK I22
PD-F0	+ 6 €	PD-F0

Dalia PA_M

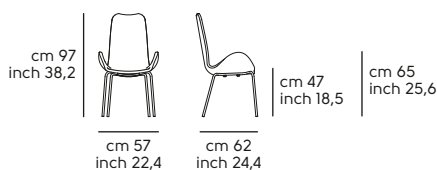

Dalia PA_T

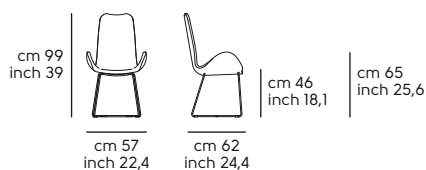

Dalia PA_Q

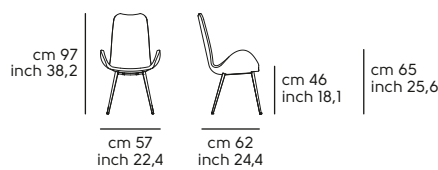

Dalia PA_R

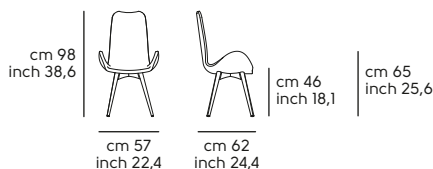

Dalia PA_N

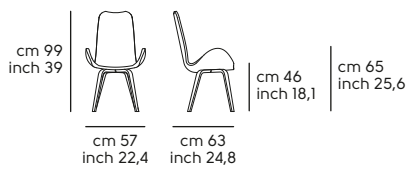

Dalia PA_X47

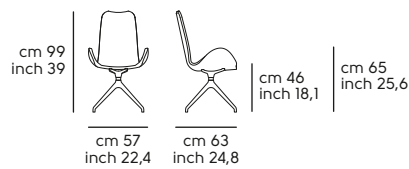



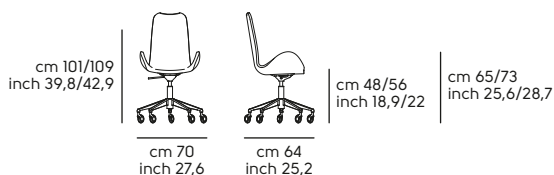

Dalia PA_DPA



Dalia AP - Shell in fabric or leather

Frame in: metal or wood

Model	Code	Base type	Frame	Shell									Optional	Q.ty	boxes	Kg	M ²
				TA	TB	TC	TD	TE	SF	SV	COM	COL					
Waiting Chair DALIA AP M TS 	S1850APO_T	_T	M1	502 €	541 €	599 €	637 €	780 €	730 €	862 €	502 €	599 €	FM-M2 PD-F0 ES-1	1	1	14.5	0.45
Waiting Chair DALIA AP LN TS 	S1850APL	_N	LII	689 €	728 €	786 €	824 €	968 €	918 €	1.050 €	689 €	786 €	FL-I2 PD-F0 ES-1	1	1	14.0	0.45
Waiting Chair Autor. DALIA AP GX TS  	S1850APY	GX	M1	644 €	683 €	741 €	779 €	923 €	873 €	1.005 €	644 €	741 €	FM-M2 ES-1	1	1	16.0	0.44

Note:

TS Front and Back covering available in two-tone or bi-material. Reference price in the upper category

Frame finishes

Metal		Wood	
MI	WHITE BB , BROWN E6 , SAND EC , GRAPHITE EG , BLACK EN	LII	Veneered wood painted GREY I02 , Veneered wood painted GRAFITE GREY I03 , Veneered wood painted BLACK I04 , Veneered wood painted WHITE I05 , Veneered wood painted BLUE I06 , Veneered wood painted RED I08 , Veneered wood painted CHERRY RED I09 , Veneered wood painted DARK BROWN I26 , Veneered wood painted NATURAL I40 , Veneered wood painted NATURAL OAK I52

Shell finishes

Upholstery	
TA	FAUX LEATHER Secret , FABRIC Mirage , FABRIC Cotton Club
TC	VELVET SUPERB, FABRIC Second , FABRIC Main Line Flax , FABRIC Oceanic
TE	FABRIC Uniform Melange
SV	LEATHER Vintage
TB	FAUX LEATHER Vintage , FABRIC Fenix Wool , FABRIC Novabuk , FABRIC Manhattan , FABRIC Visual
TD	FABRIC Yoredale , FABRIC Remix 3
SF	LEATHER Fiore

COM/COL - Minimum Q.ty 6 pc. for each material. For weft or patterned fabrics see specific pages

COM 	Mtl. 1.85 h. 1.40 Each	COL 	Mq. 2.60 Each
--	------------------------	---	---------------

Optionals:

	Value	Options/notes
FM-M2	+ 49 €	Indoor matt metal M2 ASH GREY ES , BRONZE E2 , BULGARO RED FP , CHERRY RED EQ , DARK GREEN EL , FACEPOWDER PINK E8 , FANGO E3 , GOLDEN YELLOW EO , LIGHT BLUE E0 , LIGHT GREY ET , OCEAN BLUE E1 , OCHER YELLOW E7 , PAPAYA ORANGE EA , PASTEL YELLOW E4 , PINE GREEN EJ , RED ER , SAGE GREEN E9
FL-I2	+ 14 €	Veneered wood finish LI2 Veneered wood FLAMED WALNUT I24 , Veneered wood NATURAL OAK I22
ES-1	+ 17 €	Fireproof foam ES-1
PD-F0	+ 6 €	Felt pad feet PD-F0

Dalia AP_T

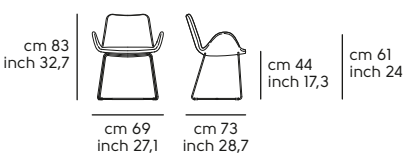

Dalia AP_N

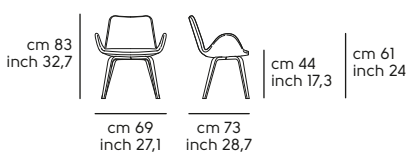

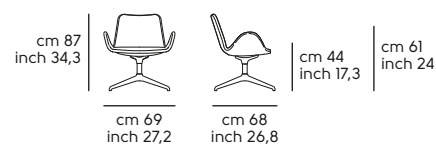

Dalia AP_GX



Dalia DV - Shell in fabric or leather

Frame in: metal or wood

Model	Code	Base type	Frame	Shell									Optional	Q.ty	boxes	Kg	M ²
				TA	TB	TC	TD	TE	SF	SV	COM	COL					
 Sofa DALIA DV M TS	S1850D00_T	_T	MI	973 €	1.034 €	1.133 €	1.199 €	1.383 €	1.216 €	1.394 €	973 €	1.133 €	FM-M2 PD-F0 ES-1	1	1	26.0	0.84
 Sofa DALIA DV LN TS	S1850D0L_N	_N	LII	1.360 €	1.420 €	1.519 €	1.586 €	1.768 €	1.602 €	1.781 €	1.360 €	1.519 €	FL-I2 PD-F0 ES-1	1	1	27.8	0.84

Note:

TS Front and Back covering available in two-tone or bi-material. Reference price in the upper category

Frame finishes

Metal

MI	WHITE BB , BROWN E6 , SAND EC , GRAPHITE EG , BLACK EN
-----------	---

Wood



LII	Veneered wood painted GREY I02 , Veneered wood painted GRAFITE GREY I03 , Veneered wood painted BLACK I04 , Veneered wood painted WHITE I05 , Veneered wood painted BLUE I06 , Veneered wood painted RED I08 , Veneered wood painted CHERRY RED I09 , Veneered wood painted DARK BROWN I26 , Veneered wood painted NATURAL I40 , Veneered wood painted NATURAL OAK I52
------------	--

Shell finishes

Upholstery

TA	FAUX LEATHER Secret , FABRIC Mirage , FABRIC Cotton Club	TB	FAUX LEATHER Vintage , FABRIC Fenix Wool , FABRIC Novabuk , FABRIC Manhattan , FABRIC Visual
TC	VELVET SUPERB, FABRIC Second , FABRIC Main Line Flax , FABRIC Oceanic	TD	FABRIC Yoredale , FABRIC Remix 3
TE	FABRIC Uniform Melange	SF	LEATHER Fiore
SV	LEATHER Vintage		

COM/COL - Minimum Q.ty 6 pc. for each material. For weft or patterned fabrics see specific pages

 COM	Mtl. 2.85 h. 1.40 Each	 COL	Mq. 3.95 Each
--	------------------------	--	---------------

Optionals:

	Value	Options/notes
FM-M2	Indoor matt metal M2	+ 49 €
FL-I2	Veneered wood finish LI2	+ 14 €
ES-1	Fireproof foam	+ 17 €
PD-F0	Felt pad feet	+ 6 €

Dalia DV_T

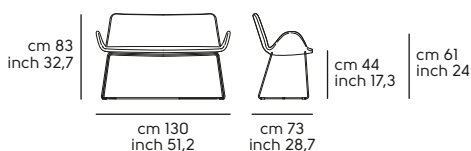

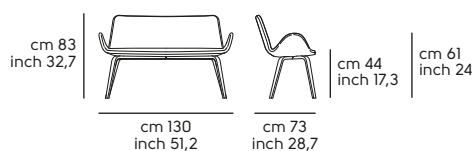

Dalia DV_N



Dalia PE - Shell in fabric or leather

Frame in: metal or wood

Model	Code	Base type	Frame	Shell									Optional	Q.ty	boxes	Kg	M³
				TA	TB	TC	TD	TE	SF	SV	COM	COL					
 Waiting Chair Alta DALIA PE M TS	S1850PEO_T	_T	MI	758 €	814 €	897 €	953 €	1.111 €	988 €	1.151 €	758 €	897 €	FM-M2 PD-F0 ES-1	1	1	19.35	0.74
 Waiting Chair Alta DALIA PE LN TS	S1850PEL	_N	LII	946 €	1.001 €	1.084 €	1.141 €	1.299 €	1.175 €	1.339 €	946 €	1.084 €	FL-I2 PD-F0 ES-1	1	1	18.75	0.74
 Waiting Chair Alta Autor. DALIA PE GX TS	S1850PEY	GX	MI	901 €	956 €	1.038 €	1.096 €	1.254 €	1.130 €	1.294 €	901 €	1.038 €	FM-M2 ES-1	1	1	21.1	0.7

Note:

TS Front and Back covering available in two-tone or bi-material. Reference price in the upper category

Frame finishes

Metal

MI	WHITE BB , BROWN E6 , SAND EC , GRAPHITE EG , BLACK EN
-----------	---

Wood

LII	Veneered wood painted GREY I02 , Veneered wood painted GRAFITE GREY I03 , Veneered wood painted BLACK I04 , Veneered wood painted WHITE I05 , Veneered wood painted BLUE I06 , Veneered wood painted RED I08 , Veneered wood painted CHERRY RED I09 , Veneered wood painted DARK BROWN I26 , Veneered wood painted NATURAL I40 , Veneered wood painted NATURAL OAK I52
------------	--

Shell finishes

Upholstery

TA	FAUX LEATHER Secret , FABRIC Mirage , FABRIC Cotton Club	TB	FAUX LEATHER Vintage , FABRIC Fenix Wool , FABRIC Novabuk , FABRIC Manhattan , FABRIC Visual
TC	VELVET SUPERB, FABRIC Second , FABRIC Main Line Flax , FABRIC Oceanic	TD	FABRIC Yoredale , FABRIC Remix 3
TE	FABRIC Uniform Melange	SF	LEATHER Fiore
SV	LEATHER Vintage		

COM/COL - Minimum Q.ty 6 pc. for each material. For weft or patterned fabrics see specific pages

COM	Mtl. 2.50 h. 1.40 Each	COL	Mq. 3.50 Each
------------	------------------------	------------	---------------

Optionals:

	Value	Options/notes
FM-M2	+ 49 €	ASH GREY ES , BRONZE E2 , BULGARO RED FP , CHERRY RED EQ , DARK GREEN EL , FACEPOWDER PINK E8 , FANGO E3 , GOLDEN YELLOW EO , LIGHT BLUE E0 , LIGHT GREY ET , OCEAN BLUE E1 , OCHER YELLOW E7 , PAPAYA ORANGE EA , PASTEL YELLOW E4 , PINE GREEN EJ , RED ER , SAGE GREEN E9
FL-I2	+ 14 €	Veneered wood FLAMED WALNUT I24 , Veneered wood NATURAL OAK I22
ES-1	+ 27 €	ES-1
PD-F0	+ 6 €	PD-F0

Dalia PE_T

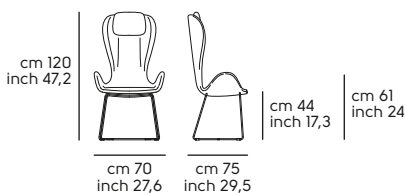

Dalia PE_N

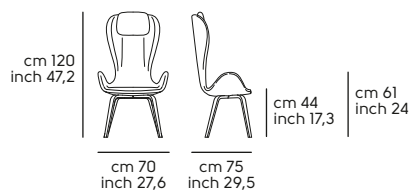

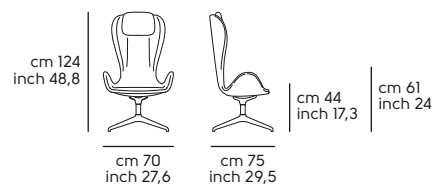

Dalia PE_GX



Dalia DVE - Shell in fabric or leather

Frame in: metal or wood

Model	Code	Base type	Frame	Shell									Optional	Q.ty	boxes	Kg	M³
				TA	TB	TC	TD	TE	SF	SV	COM	COL					
 <p>Sofa DALIA DVE M TS</p>	S1850DE0_T	_T	MI	1.389 €	1.486 €	1.645 €	1.754 €	2.043 €	1.933 €	2.291 €	1.389 €	1.645 €	FM-M2 PD-F0 ES-1	1	1	36.0	1.36
 <p>Sofa DALIA DVE LN TS</p>	S1850DEL	_N	LII	1.776 €	1.872 €	2.031 €	2.139 €	2.429 €	2.318 €	2.676 €	1.776 €	2.031 €	FL-I2 PD-F0 ES-1	1	1	38.0	1.36

Note:

TS Front and Back covering available in two-tone or bi-material. Reference price in the upper category

Frame finishes

Metal

MI	WHITE BB , BROWN E6 , SAND EC , GRAPHITE EG , BLACK EN
-----------	---

Wood

LII	Veneered wood painted GREY I02 , Veneered wood painted GRAFITE GREY I03 , Veneered wood painted BLACK I04 , Veneered wood painted WHITE I05 , Veneered wood painted BLUE I06 , Veneered wood painted RED I08 , Veneered wood painted CHERRY RED I09 , Veneered wood painted DARK BROWN I26 , Veneered wood painted NATURAL I40 , Veneered wood painted NATURAL OAK I52
------------	--

Shell finishes

Upholstery

TA	FAUX LEATHER Secret , FABRIC Mirage , FABRIC Cotton Club	TB	FAUX LEATHER Vintage , FABRIC Fenix Wool , FABRIC Novabuk , FABRIC Manhattan , FABRIC Visual
TC	VELVET SUPERB, FABRIC Second , FABRIC Main Line Flax , FABRIC Oceanic	TD	FABRIC Yoredale , FABRIC Remix 3
TE	FABRIC Uniform Melange	SF	LEATHER Fiore
SV	LEATHER Vintage		

COM/COL - Minimum Q.ty 6 pc. for each material. For weft or patterned fabrics see specific pages

COM	Mtl. 3.70 h. 1.40 Each	COL	Mq. 5.20 Each
------------	------------------------	------------	---------------

Optionals:

	Value	Options/notes
FM-M2	+ 61 €	Indoor matt metal M2 ASH GREY ES , BRONZE E2 , BULGARO RED FP , CHERRY RED EQ , DARK GREEN EL , FACEPOWDER PINK E8 , FANGO E3 , GOLDEN YELLOW EO , LIGHT BLUE EO , LIGHT GREY ET , OCEAN BLUE E1 , OCHER YELLOW E7 , PAPAYA ORANGE EA , PASTEL YELLOW E4 , PINE GREEN EJ , RED ER , SAGE GREEN E9
FL-I2	+ 34 €	Veneered wood finish LI2 Veneered wood FLAMED WALNUT I24 , Veneered wood NATURAL OAK I22
ES-1	+ 39 €	Fireproof foam ES-1
PD-F0	+ 6 €	Felt pad feet PD-F0

Dalia DVE_T

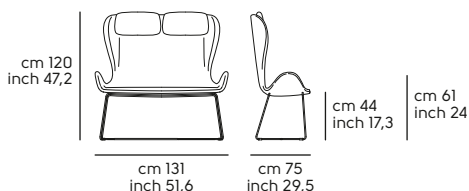

Dalia DVE_N

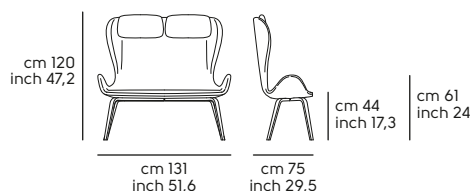

Dalia Cushion DVE-PE - Upholstered in fabric or leather

Model	Code	--	--	Upholstery									Optional	Q.ty 	boxes 	Kg 	M³
				TA	TB	TC	TD	TE	SF	SV	COM	COL					
Cushion DALIA DVE-PE 	A1850Q0			83 €	87 €	91 €	96 €	105 €	93 €	98 €	83 €	91 €	ES-1	1	1	1.0	0.01



Note:
Sold per unit

Cushion finishes

Upholstery

TA	FAUX LEATHER Secret , FABRIC Mirage , FABRIC Cotton Club	TB	FAUX LEATHER Vintage , FABRIC Fenix Wool , FABRIC Novabuk , FABRIC Manhattan , FABRIC Visual
TC	VELVET SUPERB, FABRIC Second , FABRIC Main Line Flax , FABRIC Oceanic	TD	FABRIC Yoredale , FABRIC Remix 3
TE	FABRIC Uniform Melange	SF	LEATHER Fiore
SV	LEATHER Vintage		

COM/COL - Minimum Q.ty 6 pc. for each material. For weft or patterned fabrics see specific pages

 COM	Mtl. 0.45 h. 1.40 Each	 COL	Mq. 0.65 Each
---	------------------------	--	---------------

Optionals:

	Value	Options/notes
ES-1	Fireproof foam	+ 5 € ES-1

Dalia Cushion DVE-PE



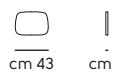



cm 30
inch 11,8



cm 43 cm 3
inch 16,9 inch 1,2

Dalia H65-75-SG - Shell in fabric or leather

Frame in: metal or wood

Model	Code	Mod.	Frame	Shell									Optional	Q.ty	boxes	Kg	M ²
				TA	TB	TC	TD	TE	SF	SV	COM	COL					
Stool DALIA H65 M TS 	S1850IQ	H65	M1	412 €	445 €	476 €	495 €	570 €	545 €	602 €	412 €	476 €	FM-M2 ES-1 PD-F0	1	1	8.0	0.29
Stool DALIA H75 M TS 	S1850KQ	H75	M1	423 €	460 €	488 €	506 €	582 €	559 €	615 €	423 €	488 €	FM-M2 ES-1 PD-F0	1	1	8.0	0.31
Stool DALIA H65 LR TS 	S1850IW	LR H65	LF1	482 €	515 €	545 €	565 €	641 €	615 €	673 €	482 €	545 €	ES-1 PD-F0	1	1	8.0	0.29
Stool DALIA H75 LR TS 	S1850KW	LR H75	LF1	499 €	533 €	564 €	583 €	657 €	634 €	689 €	499 €	564 €	ES-1 PD-F0	1	1	8.0	0.31
Stool DALIA SG TS  	S1850ZT	SG	M1	676 €	710 €	740 €	759 €	835 €	810 €	866 €	676 €	740 €	FM-M2 ES-1	1	1	16.35	0.25

Note:

TS Front and Back covering available in two-tone or bi-material. Reference price in the upper category



Frame finishes

Metal		Wood	
MI	WHITE BB , BROWN E6 , SAND EC , GRAPHITE EG , BLACK EN	LFI	Ash wood painted GREY F02 , Ash wood painted GRAFITE GREY F03 , Ash wood painted BLACK F04 , Ash wood painted WHITE F05 , Ash wood painted BLUE F06 , Ash wood painted RED F08 , Ash wood painted CHERRY RED F09 , Ash wood painted FLAMED WALNUT F24 , Ash wood painted DARK BROWN F26 , Ash wood painted NATURAL F40 , Ash wood painted NATURAL OAK F52

Shell finishes

Upholstery	
TA	FAUX LEATHER Secret , FABRIC Mirage , FABRIC Cotton Club
TC	VELVET SUPERB, FABRIC Second , FABRIC Main Line Flax , FABRIC Oceanic
TE	FABRIC Uniform Melange
SV	LEATHER Vintage
TB	FAUX LEATHER Vintage , FABRIC Fenix Wool , FABRIC Novabuk , FABRIC Manhattan , FABRIC Visual
TD	FABRIC Yoredale , FABRIC Remix 3
SF	LEATHER Fiore

COM/COL - Minimum Q.ty 6 pc. for each material. For weft or patterned fabrics see specific pages

COM 	Mtl. 0.80 h. 1.40 Each	COL 	Mq. 1.20 Each
--	------------------------	---	---------------

Optionals:

	Value	Options/notes
FM-M2	+ 59 €	ASH GREY ES , BRONZE E2 , BULGARO RED FP , CHERRY RED EQ , DARK GREEN EL , FACEPOWDER PINK E8 , FANGO E3 , GOLDEN YELLOW EO , LIGHT BLUE E0 , LIGHT GREY ET , OCEAN BLUE E1 , OCHER YELLOW E7 , PAPAYA ORANGE EA , PASTEL YELLOW E4 , PINE GREEN EJ , RED ER , SAGE GREEN E9
ES-1	+ 5 €	ES-1
PD-F0	+ 6 €	PD-F0

Dalia H65

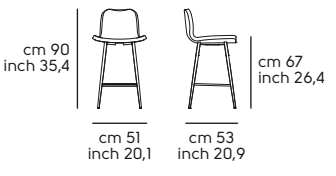

Dalia H75

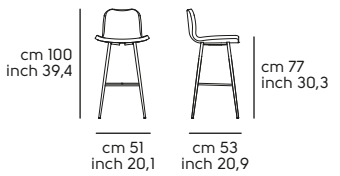

Dalia LR H65

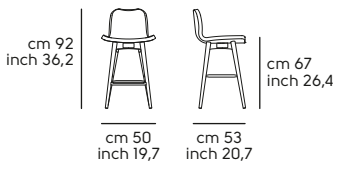

Dalia LR H75

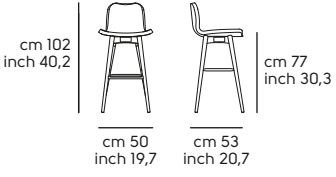

Dalia SG

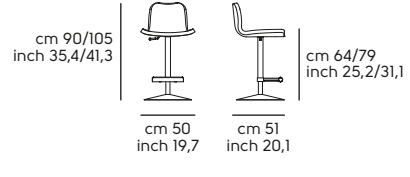

Pouf DALIA B2 - Cushion in fabric or leather

Frame in: metal

Model	Code	Mod.	Frame	Cushion									Optional	Q.ty	boxes	Kg	M ²
				TA	TB	TC	TD	TE	SF	SV	COM	COL					
 Pouf DALIA B2 M TS	S1850B20	B2	M1	415 €	457 €	526 €	572 €	741 €	521 €	595 €	415 €	526 €	FM-M2	1	1	9.0	0.19

Note:

Frame finishes

Metal



M1 WHITE **BB**, BROWN **E6**, SAND **EC**, GRAPHITE **EG**, BLACK **EN**

Seat finishes

Upholstery

TA	FAUX LEATHER Secret , FABRIC Mirage , FABRIC Cotton Club	TB	FAUX LEATHER Vintage , FABRIC Fenix Wool , FABRIC Novabuk , FABRIC Manhattan , FABRIC Visual
TC	VELVET SUPERB, FABRIC Second , FABRIC Main Line Flax , FABRIC Oceanic	TD	FABRIC Yoredale , FABRIC Remix 3
TE	FABRIC Uniform Melange	SF	LEATHER Fiore
SV	LEATHER Vintage		

COM/COL - Minimum Q.ty 6 pc. for each material. For weft or patterned fabrics see specific pages

 COM	Mtl. 0.90 h. 1.40 Each	 COL	Mq. 0.75 Each
--	------------------------	--	---------------

Optionals:

	Value	Options/notes
FM-M2	Indoor matt metal M2	+ 49 € ASH GREY ES , BRONZE E2 , BULGARO RED FP , CHERRY RED EQ , DARK GREEN EL , FACEPOWDER PINK E8 , FANGO E3 , GOLDEN YELLOW EO , LIGHT BLUE EO , LIGHT GREY ET , OCEAN BLUE E1 , OCHER YELLOW E7 , PAPAYA ORANGE EA , PASTEL YELLOW E4 , PINE GREEN EJ , RED ER , SAGE GREEN E9

DALIA B2

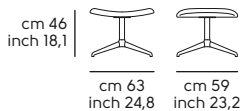

Danny design Midj R&D

Danny S - Shell in fabric or leather, back in wood

Frame in: wood



Model	Code	Mod.	Frame	Shell (Back Shell LII)									Optional	Q.ty	boxes	Kg	M³
				TA	TB	TC	TD	TE	SF	SV	COM	COL					
 Chair DANNY S L TS	S1080W1	S	LII	639 €	683 €	705 €	737 €	865 €	822 €	908 €	639 €	705 €	FL-I2 ES-1 PD-FO	1	1	8.5	0.28

COM/COL - Minimum Q.ty 6 pc. for each material. For weft or patterned fabrics see specific pages



 Mtl. 0.65 h. 1.40 Each	 Mq. 1.95 Each
---	---

Danny PB, P - Shell in fabric or leather, back in wood

Frame in: wood

Model	Code	Mod.	Frame	Shell (Back Shell LII)									Optional	Q.ty	boxes	Kg	M³
				TA	TB	TC	TD	TE	SF	SV	COM	COL					
 Armch. DANNY PB L TS	S1080PN	PB	LII	710 €	752 €	774 €	803 €	938 €	904 €	1.005 €	710 €	774 €	FL-I2 ES-1 PD-FO	1	1	9.0	0.32
 Armch. DANNY P L TS	S1080PY	P	LII	735 €	777 €	799 €	830 €	953 €	923 €	1.023 €	735 €	799 €	FL-I2 ES-1 PD-FO	1	1	12.0	0.32

COM/COL - Minimum Q.ty 6 pc. for each material. For weft or patterned fabrics see specific pages

 Mtl. 1.40 h. 1.40 Each	 Mq. 2.28 Each
---	---

Frame finishes

Wood

LII

Veneered wood painted GREY **102**, Veneered wood painted GRAFITE GREY **103**, Veneered wood painted BLACK **104**, Veneered wood painted WHITE **105**, Veneered wood painted BLUE **106**, Veneered wood painted RED **108**, Veneered wood painted CHERRY RED **109**, Veneered wood painted DARK BROWN **126**, Veneered wood painted NATURAL **140**, Veneered wood painted NATURAL OAK **152**

Backrest shell finishes

Wood

LII

Veneered wood painted GREY **102**, Veneered wood painted GRAFITE GREY **103**, Veneered wood painted BLACK **104**, Veneered wood painted WHITE **105**, Veneered wood painted BLUE **106**, Veneered wood painted RED **108**, Veneered wood painted CHERRY RED **109**, Veneered wood painted DARK BROWN **126**, Veneered wood painted NATURAL **140**, Veneered wood painted NATURAL OAK **152**

Shell finishes

Upholstery

TA	FAUX LEATHER Secret , FABRIC Mirage , FABRIC Cotton Club	TB	FAUX LEATHER Vintage , FABRIC Fenix Wool , FABRIC Novabuk , FABRIC Manhattan , FABRIC Visual
TC	VELVET SUPERB, FABRIC Second , FABRIC Main Line Flax , FABRIC Oceanic	TD	FABRIC Yoredale , FABRIC Remix 3
TE	FABRIC Uniform Melange	SF	LEATHER Fiore
SV	LEATHER Vintage		

Optionals:

		Value	Options/notes
FL-I2	Veneered wood finish LI2	+ 6 €	Veneered wood FLAMED WALNUT I24 , Veneered wood NATURAL OAK I22
ES-1	Fireproof foam	+ 20 €	ES-1
PD-F0	Felt pad feet	+ 6 €	PD-F0

Danny S

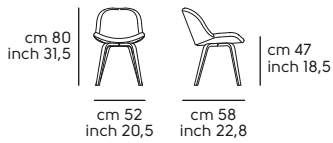

Danny PB

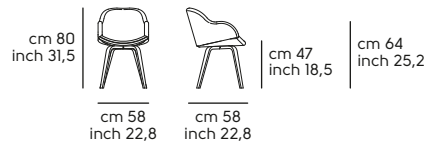



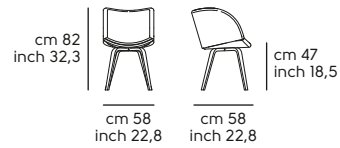

Danny P



Guapa design Sempere e Poli

Guapa S, P, AP - Shell in hide

Frame in: metal

Model	Code	Mod.	Frame	Shell		Optional	Q.ty	boxes	Kg	M ³
				CK	CT					
Chair GUAPA S M CU 	S1150S0	S	M1	603 €	762 €	FM-M2 FM-M3 FM-M4	2	1	18.0	0.44
Armch. GUAPA P M CU 	S1150P0	P	M1	719 €	917 €	FM-M2 FM-M3 FM-M4	1	1	11.5	0.37
Armch. GUAPA P MX CU 	S1150PX	MX	M1	878 €	1.074 €	FM-M2	1	1	12.0	0.22
Waiting Chair GUAPA AP M CU 	S1150AC	AP	M1	864 €	1.158 €	FM-M2 FM-M3	1	1	13.5	0.46

Frame finishes

Metal	
MI	WHITE BB , BROWN E6 , SAND EC , GRAPHITE EG , BLACK EN

Shell finishes

Upholstery	
CK	HIDE_TK
CT	TUSCAN HIDE

Optionals:

	Value	Options/notes
FM-M2	Indoor matt metal M2	+ 58 €
FM-M3	Indoor glossy metal M3	+ 25 €
FM-M4	Indoor glossy Metal M4	+ 154 €

ASH GREY **ES**, BRONZE **E2**, BULGARO RED **FP**, CHERRY RED **EQ**, DARK GREEN **EL**, FACEPOWDER PINK **E8**, FANGO **E3**, GOLDEN YELLOW **EO**, LIGHT BLUE **E0**, LIGHT GREY **ET**, OCEAN BLUE **E1**, OCHER YELLOW **E7**, PAPAYA ORANGE **EA**, PASTEL YELLOW **E4**, PINE GREEN **EJ**, RED **ER**, SAGE GREEN **E9**
 CHROME **CC**
 BLACK NICKEL **DZ**, CHAMPAGNE GOLD **DG**, GOLDEN BRONZE **DB**, MATT BLACK NICKEL **DY**, MATT GOLDEN BRONZE **DC**, PINK GOLD **DR**

Guapa S

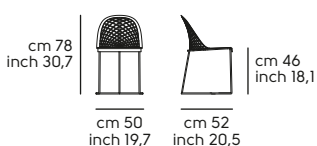

Guapa P

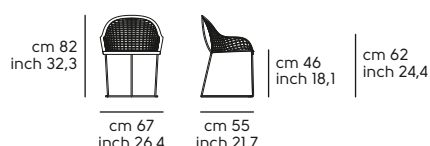

Guapa MX





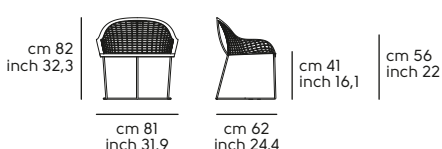

Guapa AP



Guapa H65-75, DPB, DPA - Shell in hide

Frame in: metal

Model	Code	Mod.	Frame	Shell		Optional	Q.ty	boxes	Kg	M ²
				CK	CT					
Stool GUAPA H65 M CU 	S1150H0	H65	M1	718 €	887 €	FM-M2 FM-M3 FM-M4	1	1	11.0	0.31
Stool GUAPA H75 M CU 	S1150J0	H75	M1	731 €	901 €	FM-M2 FM-M3 FM-M4	1	1	11.5	0.34
Office Arm. GUAPA DPB M CU 	S1150EB	DPB	M1	926 €	1.124 €	FM-M2	1	2	13.0	0.34
Office Arm. GUAPA DPA M CU 	S1150EA	DPA	M1	1.118 €	1.371 €	FM-M2	1	2	17.0	0.44

Frame finishes

Metal

M1 WHITE **BB**, BROWN **E6**, SAND **EC**, GRAPHITE **EG**, BLACK **EN**

Shell finishes

Upholstery

CK HIDE_TK

CT TUSCAN HIDE

Optionals:

		Value	Options/notes
FM-M2	Indoor matt metal M2	+ 58 €	ASH GREY ES , BRONZE E2 , BULGARO RED FP , CHERRY RED EQ , DARK GREEN EL , FACEPOWDER PINK E8 , FANGO E3 , GOLDEN YELLOW EO , LIGHT BLUE EO , LIGHT GREY ET , OCEAN BLUE E1 , OCHER YELLOW E7 , PAPAYA ORANGE EA , PASTEL YELLOW E4 , PINE GREEN EJ , RED ER , SAGE GREEN E9
FM-M3	Indoor glossy metal M3	+ 25 €	CHROME CC
FM-M4	Indoor glossy Metal M4	+ 154 €	BLACK NICKEL DZ , CHAMPAGNE GOLD DG , GOLDEN BRONZE DB , MATT BLACK NICKEL DY , MATT GOLDEN BRONZE DC , PINK GOLD DR

Guapa H65

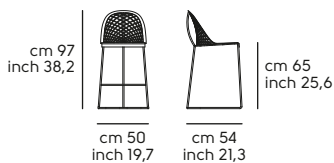

Guapa H75

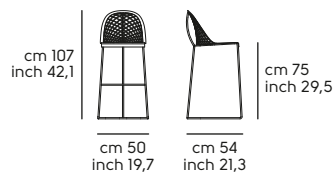

Guapa DPB

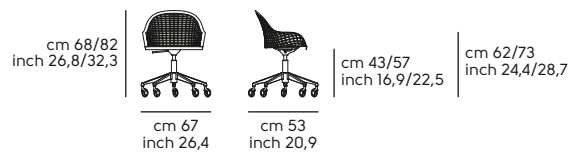

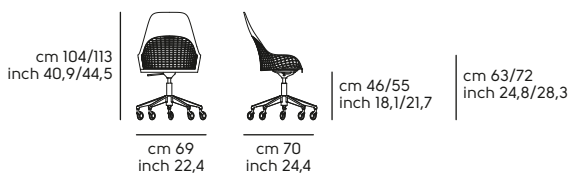

Guapa DPA



Guapa DNB, DNA - Shell in hide

Frame in: metal

Model	Code	Mod.	Frame	Shell		Optional	Q.ty	boxes	Kg	M ³
				CK	CT					
Rocking GUAPA DNB M CU 	S1150RB	DNB	MI-LFI	1.029 €	1.226 €	FM-M2 FM-M3	1	1	13.5	0.49
Rocking GUAPA DNA M CU 	S1150RA	DNA	MI-LFI	1.209 €	1.463 €	FM-M2 FM-M3	1	1	15.0	0.65

Frame finishes

Metal	
MI	WHITE BB , BROWN E6 , SAND EC , GRAPHITE EG , BLACK EN

Sledges finishes

Wood	
LFI	Ash wood painted GREY F02 , Ash wood painted GRAFITE GREY F03 , Ash wood painted BLACK F04 , Ash wood painted WHITE F05 , Ash wood painted BLUE F06 , Ash wood painted RED F08 , Ash wood painted CHERRY RED F09 , Ash wood painted FLAMED WALNUT F24 , Ash wood painted DARK BROWN F26 , Ash wood painted NATURAL F40 , Ash wood painted NATURAL OAK F52

Shell finishes

Upholstery	
CK	HIDE_TK
CT	TUSCAN HIDE

Optionals:

	Value	Options/notes
FM-M2	+ 58 €	ASH GREY ES , BRONZE E2 , BULGARO RED FP , CHERRY RED EQ , DARK GREEN EL , FACEPOWDER PINK E8 , FANGO E3 , GOLDEN YELLOW EO , LIGHT BLUE E0 , LIGHT GREY ET , OCEAN BLUE E1 , OCHER YELLOW E7 , PAPAYA ORANGE EA , PASTEL YELLOW E4 , PINE GREEN EJ , RED ER , SAGE GREEN E9
FM-M3	+ 25 €	CHROME CC

Guapa DNB



Guapa DNA

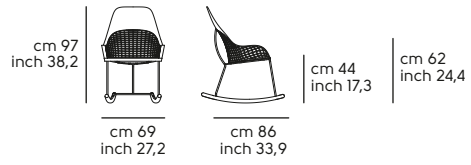

Joe design Midj R&D



Joe S M - Seat and back in hide, fabric or leather, wood

Frame in: metal

Model	Code	Mod.	Frame	Seat and Backrest								Optional	Q.ty	boxes	Kg	M³
				CU				CT								
Chair JOE S M CU 	S1210SQ	S	MI	371 €				435 €				FM-M2 ES-1 PD-FO	2	1	12.0	0.32



Model	Code	Mod.	Frame	TA	TB	TC	TD	TE	SF	SV	COM	COL	Optional	Q.ty	boxes	Kg	M³
				Chair JOE S MTS 	S1210SR	S	MI	278 €	303 €	337 €	366 €	457 €					

COM/COL - Minimum Q.ty 6 pc. for each material. For weft or patterned fabrics see specific pages

 Mtl. 0.70 h. 1.40 Each	 Mq. 1.20 Each
--	---



Model	Code	Mod.	Frame	Seat and Back (Backrest LII)								Optional	Q.ty	boxes	Kg	M³	
				TA	TB	TC	TD	TE	SF	SV	COM						COL
Chair JOE S MTS/L 	S1210SS	S	MI	314 €	333 €	365 €	392 €	475 €	389 €	421 €	314 €	365 €	FM-M2 FL-I2 ES-1 PD-FO	2	1	12.0	0.32

COM/COL - Minimum Q.ty 6 pc. for each material. For weft or patterned fabrics see specific pages

 Mtl. 0.66 h. 1.40 Each	 Mq. 1.07 Each
--	---

Model	Code	Mod.	Frame	Seat (Back LII)								Optional	Q.ty	boxes	Kg	M³	
				TA	TB	TC	TD	TE	SF	SV	COM						COL
Chair JOE S MTS-LG 	S1210SD	S	MI	280 €	298 €	328 €	352 €	424 €	342 €	365 €	280 €	328 €	FM-M2 ES-1 FL-I2 PD-FO	2	1	12.0	0.32

COM/COL - Minimum Q.ty 6 pc. for each material. For weft or patterned fabrics see specific pages

 Mtl. 0.31 h. 1.40 Each	 Mq. 0.52 Each
--	---

Model	Code	Mod.	Frame	Seat and Backrest		Optional	Q.ty	boxes	Kg	M ³
				L11	L12					
Chair JOE S M LG  <small>CATAS EN 1728</small>	S1210S0	S	M1	284 €	308 €	FM-M2 PD-F0	2	1	12.0	0.32

Frame finishes

Metal

M1 WHITE **BB**, BROWN **E6**, SAND **EC**, GRAPHITE **EG**, BLACK **EN**

Backrest back finishes

Wood

L11

Veneered wood painted GREY **I02**, Veneered wood painted GRAFITE GREY **I03**, Veneered wood painted BLACK **I04**, Veneered wood painted WHITE **I05**, Veneered wood painted BLUE **I06**, Veneered wood painted RED **I08**, Veneered wood painted CHERRY RED **I09**, Veneered wood painted DARK BROWN **I26**, Veneered wood painted NATURAL **I40**, Veneered wood painted NATURAL OAK **I52**

Seat and Back finishes

Wood

L11

Veneered wood painted GREY **I02**, Veneered wood painted GRAFITE GREY **I03**, Veneered wood painted BLACK **I04**, Veneered wood painted WHITE **I05**, Veneered wood painted BLUE **I06**, Veneered wood painted RED **I08**, Veneered wood painted CHERRY RED **I09**, Veneered wood painted DARK BROWN **I26**, Veneered wood painted NATURAL **I40**, Veneered wood painted NATURAL OAK **I52**

L12

Veneered wood NATURAL OAK **I22**, Veneered wood FLAMED WALNUT **I24**

Upholstery

TA FAUX LEATHER **Secret**, FABRIC **Mirage**, FABRIC **Cotton Club**

TC VELVET SUPERB, FABRIC **Second**, FABRIC **Main Line Flax**, FABRIC **Oceanic**

TE FABRIC **Uniform Melange**

SV LEATHER **Vintage**

CT TUSCAN HIDE

TB FAUX LEATHER **Vintage**, FABRIC **Fenix Wool**, FABRIC **Novabuk**, FABRIC **Manhattan**, FABRIC **Visual**

TD FABRIC **Yoredale**, FABRIC **Remix 3**

SF LEATHER **Fiore**

CU HIDE

Optionals:

		Value	Options/notes
FM-M2	Indoor matt metal M2	+ 45 €	ASH GREY ES , BRONZE E2 , BULGARO RED FP , CHERRY RED EQ , DARK GREEN EL , FACEPOWDER PINK E8 , FANGO E3 , GOLDEN YELLOW EO , LIGHT BLUE E0 , LIGHT GREY ET , OCEAN BLUE E1 , OCHER YELLOW E7 , PAPAYA ORANGE EA , PASTEL YELLOW E4 , PINE GREEN EJ , RED ER , SAGE GREEN E9
FL-I2	Veneered wood finish L12	+ 20 €	Veneered wood FLAMED WALNUT I24 , Veneered wood NATURAL OAK I22
ES-1	Fireproof foam	+ 5 €	ES-1
PD-F0	Felt pad feet	+ 6 €	PD-F0

Joe S

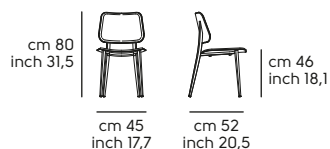

Joe S L - Seat and back in hide, fabric or leather, wood

Frame in: wood

Model	Code	Mod.	Frame	Seat and Backrest								Optional	Q.ty	boxes	Kg	M³		
				CU				CT										
Chair JOE S L CU																		
	S1215SQ	S	LF1	413 €				480 €				ES-1 PD-FO	2	1	12.0	0.32		



Model	Code	Mod.	Frame	TA	TB	TC	TD	TE	SF	SV	COM	COL	Optional	Q.ty	boxes	Kg	M³
				Chair JOE S L TS													
	S1215SR	S	LF1	324 €	351 €	386 €	405 €	492 €	408 €	446 €	324 €	386 €	ES-1 PD-FO	2	1	12.0	0.32

COM/COL - Minimum Q.ty 6 pc. for each material. For weft or patterned fabrics see specific pages

	Mtl. 0.70 h. 1.40 Each		Mq. 1.20 Each
---	------------------------	---	---------------



Model	Code	Mod.	Frame	Seat and Back (Backrest LII)								Optional	Q.ty	boxes	Kg	M³	
				TA	TB	TC	TD	TE	SF	SV	COM						COL
Chair JOE S L TS/L																	
	S1215SS	S	LF1	358 €	383 €	419 €	439 €	507 €	433 €	465 €	358 €	419 €	ES-1 PD-FO	2	1	12.0	0.32

COM/COL - Minimum Q.ty 6 pc. for each material. For weft or patterned fabrics see specific pages

	Mtl. 0.66 h. 1.40 Each		Mq. 1.07 Each
---	------------------------	---	---------------

Model	Code	Mod.	Frame	Seat (Back LII)								Optional	Q.ty	boxes	Kg	M³	
				TA	TB	TC	TD	TE	SF	SV	COM						COL
Chair JOE S L TS-LG																	
	S1215SD	S	LF1	338 €	353 €	374 €	389 €	433 €	390 €	423 €	338 €	374 €	ES-1 PD-FO	2	1	12.0	0.32

COM/COL - Minimum Q.ty 6 pc. for each material. For weft or patterned fabrics see specific pages

	Mtl. 0.31 h. 1.40 Each		Mq. 0.52 Each
---	------------------------	---	---------------

Model	Code	Mod.	Seat and Backrest	Frame								Optional	Q.ty	boxes	Kg	M³	
				LF1													
Chair JOE S L LG																	
	S1215S0	S	LII	320 €								PD-FO	2	1	12.0	0.32	

Frame finishes

Wood

LFI	Ash wood painted GREY F02 , Ash wood painted GRAFITE GREY F03 , Ash wood painted BLACK F04 , Ash wood painted WHITE F05 , Ash wood painted BLUE F06 , Ash wood painted RED F08 , Ash wood painted CHERRY RED F09 , Ash wood painted FLAMED WALNUT F24 , Ash wood painted DARK BROWN F26 , Ash wood painted NATURAL F40 , Ash wood painted NATURAL OAK F52
------------	--

Backrest back finishes

Wood

LII	Veneered wood painted GREY I02 , Veneered wood painted GRAFITE GREY I03 , Veneered wood painted BLACK I04 , Veneered wood painted WHITE I05 , Veneered wood painted BLUE I06 , Veneered wood painted RED I08 , Veneered wood painted CHERRY RED I09 , Veneered wood painted DARK BROWN I26 , Veneered wood painted NATURAL I40 , Veneered wood painted NATURAL OAK I52
------------	--

Seat and Back finishes

Wood

LII	Veneered wood painted GREY I02 , Veneered wood painted GRAFITE GREY I03 , Veneered wood painted BLACK I04 , Veneered wood painted WHITE I05 , Veneered wood painted BLUE I06 , Veneered wood painted RED I08 , Veneered wood painted CHERRY RED I09 , Veneered wood painted DARK BROWN I26 , Veneered wood painted NATURAL I40 , Veneered wood painted NATURAL OAK I52
------------	--

Upholstery

TA	FAUX LEATHER Secret , FABRIC Mirage , FABRIC Cotton Club	TB	FAUX LEATHER Vintage , FABRIC Fenix Wool , FABRIC Novabuk , FABRIC Manhattan , FABRIC Visual
TC	VELVET SUPERB, FABRIC Second , FABRIC Main Line Flax , FABRIC Oceanic	TD	FABRIC Yoredale , FABRIC Remix 3
TE	FABRIC Uniform Melange	SF	LEATHER Fiore
SV	LEATHER Vintage	CU	HIDE
CT	TUSCAN HIDE		

Optionals:

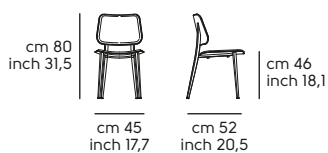

		Value	Options/notes
ES-1	Fireproof foam	+ 5 €	ES-1
PD-F0	Felt pad feet	+ 6 €	PD-F0

Joe S



Joe H65-75 - Seat and back in hide, fabric or leather, wood



Frame in: metal

Model	Code	Mod.	Frame	Seat and Backrest								Optional	Q.ty	boxes	Kg	M ³
				CU				CT								
Stool JOE H65 M CU 	S1210HQ	H65	M1	432 €				500 €				FM-M2 ES-1 PD-F0	1	1	7.5	0.27
Stool JOE H75 M CU 	S1210JQ	H75	M1	443 €				512 €				FM-M2 ES-1 PD-F0	1	1	7.5	0.33

Model	Code	Mod.	Frame	TA	TB	TC	TD	TE	SF	SV	COM	COL	Optional	Q.ty	boxes	Kg	M ³
Stool JOE H65 M TS 	S1210HR	H65	M1	358 €	384 €	420 €	440 €	511 €	442 €	482 €	358 €	420 €	FM-M2 ES-1 PD-F0	1	1	7.5	0.27
Stool JOE H75 M TS 	S1210JR	H75	M1	370 €	396 €	432 €	450 €	523 €	454 €	492 €	370 €	432 €	FM-M2 ES-1 PD-F0	1	1	7.5	0.33



COM/COL - Minimum Q.ty 6 pc. for each material. For weft or patterned fabrics see specific pages

 Mtl. 0.70 h. 1.40 Each	 Mq. 1.20 Each
--	---

Model	Code	Mod.	Frame	Seat and Back (Backrest LII)								Optional	Q.ty	boxes	Kg	M ³	
				TA	TB	TC	TD	TE	SF	SV	COM	COL					
Stool JOE H65 M TS/L 	S1210HS	H65	M1	397 €	422 €	458 €	478 €	524 €	485 €	504 €	397 €	458 €	FM-M2 FL-I2 ES-1 PD-F0	1	1	7.5	0.27
Stool JOE H75 M TS/L 	S1210JS	H75	M1	408 €	434 €	468 €	488 €	534 €	497 €	515 €	408 €	468 €	FM-M2 FL-I2 ES-1 PD-F0	1	1	7.5	0.33



COM/COL - Minimum Q.ty 6 pc. for each material. For weft or patterned fabrics see specific pages

 Mtl. 0.66 h. 1.40 Each	 Mq. 1.07 Each
--	---

Model	Code	Mod.	Frame	Seat (Back LII)									Optional	Q.ty	boxes	Kg	M³
				TA	TB	TC	TD	TE	SF	SV	COM	COL					
 Stool JOE H65 M TS-LG	S1210HD	H65	M1	347 €	364 €	384 €	400 €	445 €	408 €	432 €	347 €	384 €	FM-M2 ES-1 FL-I2 PD-F0	1	1	7.5	0.27
 Stool JOE H75 M TS-LG	S1210JD	H75	M1	357 €	375 €	396 €	412 €	457 €	419 €	442 €	357 €	396 €	FM-M2 ES-1 FL-I2 PD-F0	1	1	7.5	0.33

COM/COL - Minimum Q.ty 6 pc. for each material. For weft or patterned fabrics see specific pages

 COM	Mtl. 0.31 h. 1.40 Each	 COL	Mq. 0.52 Each
---	------------------------	--	---------------

Model	Code	Mod.	Frame	Seat and Backrest		Optional	Q.ty	boxes	Kg	M³
				L11	L12					
 Stool JOE H65 M LG	S1210H0	H65	M1	349 €	372 €	FM-M2 PD-F0	1	1	7.5	0.27
 Stool JOE H75 M LG	S1210J0	H75	M1	361 €	386 €	FM-M2 PD-F0	1	1	7.5	0.33

Frame finishes

Metal

MI WHITE **BB**, BROWN **E6**, SAND **EC**, GRAPHITE **EG**, BLACK **EN**

Backrest back finishes

Wood

LII

Veneered wood painted GREY **I02**, Veneered wood painted GRAFITE GREY **I03**, Veneered wood painted BLACK **I04**, Veneered wood painted WHITE **I05**, Veneered wood painted BLUE **I06**, Veneered wood painted RED **I08**, Veneered wood painted CHERRY RED **I09**, Veneered wood painted DARK BROWN **I26**, Veneered wood painted NATURAL **I40**, Veneered wood painted NATURAL OAK **I52**

Seat and Back finishes

Wood

LII

Veneered wood painted GREY **I02**, Veneered wood painted GRAFITE GREY **I03**, Veneered wood painted BLACK **I04**, Veneered wood painted WHITE **I05**, Veneered wood painted BLUE **I06**, Veneered wood painted RED **I08**, Veneered wood painted CHERRY RED **I09**, Veneered wood painted DARK BROWN **I26**, Veneered wood painted NATURAL **I40**, Veneered wood painted NATURAL OAK **I52**

L12

Veneered wood NATURAL OAK **I22**, Veneered wood FLAMED WALNUT **I24**

Upholstery

TA FAUX LEATHER **Secret**, FABRIC **Mirage**, FABRIC **Cotton Club**

TC VELVET SUPERB, FABRIC **Second**, FABRIC **Main Line Flax**, FABRIC **Oceanic**

TE FABRIC **Uniform Melange**

SV LEATHER **Vintage**

CT TUSCAN HIDE

TB FAUX LEATHER **Vintage**, FABRIC **Fenix Wool**, FABRIC **Novabuk**, FABRIC **Manhattan**, FABRIC **Visual**

TD FABRIC **Yoredale**, FABRIC **Remix 3**

SF LEATHER **Fiore**

CU HIDE

Optionals:			
		Value	Options/notes
FM-M2	Indoor matt metal M2	+ 45 €	ASH GREY ES , BRONZE E2 , BULGARO RED FP , CHERRY RED EQ , DARK GREEN EL , FACEPOWDER PINK E8 , FANGO E3 , GOLDEN YELLOW EO , LIGHT BLUE EO , LIGHT GREY ET , OCEAN BLUE E1 , OCHER YELLOW E7 , PAPAYA ORANGE EA , PASTEL YELLOW E4 , PINE GREEN EJ , RED ER , SAGE GREEN E9
FL-I2	Veneered wood finish L12	+ 20 €	Veneered wood FLAMED WALNUT I24 , Veneered wood NATURAL OAK I22
ES-1	Fireproof foam	+ 5 €	ES-1
PD-F0	Felt pad feet	+ 6 €	PD-F0

Joe H65

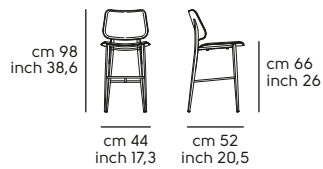

Joe H75

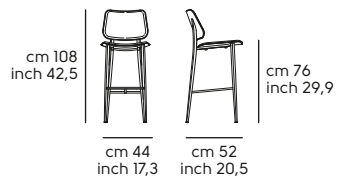

Lea design Paolo Vernier

Lea S, P - Shell in hide, fabric or leather, back in veneered wood

Frame in: metal

Model	Code	Mod.	Frame	Shell								Optional	Q.ty	boxes	Kg	M ³				
				CU				CT												
	SI940SC	S	MI	555 €								758 €				FM-M2 FM-M4 ES-1 PD-FO	1 2	1 1	8.0 16.0	0.3 0.43

Model	Code	Mod.	Frame	TA	TB	TC	TD	TE	SF	SV	COM	COL	Optional	Q.ty	boxes	Kg	M ³
					SI940ST	S	MI	386 €	422 €	462 €	485 €	592 €					

COM/COL - Minimum Q.ty 6 pc. for each material. For weft or patterned fabrics see specific pages

 Mtl. 1.10 h. 1.40 Each	 Mq. 2.00 Each
---	---

Model	Code	Mod.	Frame	Shell (Back Shell LII)								Optional	Q.ty	boxes	Kg	M ³				
				TA	TB	TC	TD	TE	SF	SV	COM						COL			
	SI940SL	S	MI	475 €								531 €				FM-M2 FM-M4 FL-I2 ES-1 PD-FO	1 2	1 1	8.0 16.0	0.3 0.43

COM/COL - Minimum Q.ty 6 pc. for each material. For weft or patterned fabrics see specific pages

 Mtl. 0.72 h. 1.40 Each	 Mq. 1.30 Each
---	---

Model	Code	Mod.	Frame	Shell								Optional	Q.ty	boxes	Kg	M ³				
				CU				CT												
	SI940PC	P	MI	732 €								1.026 €				FM-M2 FM-M4 ES-1 PD-FO	1	1	10.0	0.37



Model	Code	Mod.	Frame	TA	TB	TC	TD	TE	SF	SV	COM	COL	Optional	Q.ty	boxes	Kg	M ³
					SI940PT	P	MI	488 €	513 €	565 €	633 €	789 €					

COM/COL - Minimum Q.ty 6 pc. for each material. For weft or patterned fabrics see specific pages

 Mtl. 1.60 h. 1.40 Each	 Mq. 2.85 Each
---	---

Model	Code	Mod.	Frame	Shell (Back Shell LII)								Optional	Q.ty	boxes	Kg	M³	
				TA	TB	TC	TD	TE	SF	SV	COM						COL
 Armch. LEA P M TS/L	S1940PL	P	M1	595 €	618 €	658 €	709 €	831 €	686 €	728 €	595 €	658 €	FM-M2 FM-M4 FL-I2 ES-1 PD-F0	1	1	10.0	0.37

COM/COL - Minimum Q.ty 6 pc. for each material. For weft or patterned fabrics see specific pages

 Mtl. 1.25 h. 1.40 Each	 Mq. 2.10 Each
--	---

Note:

TS Front and Back covering available in two-tone or bi-material. Reference price in the upper category - ONLY Model M TS

Frame finishes

Metal

MI	WHITE BB , BROWN E6 , SAND EC , GRAPHITE EG , BLACK EN
-----------	---

Backrest shell finishes

Wood

LII	Veneered wood painted GREY I02 , Veneered wood painted GRAFITE GREY I03 , Veneered wood painted BLACK I04 , Veneered wood painted WHITE I05 , Veneered wood painted BLUE I06 , Veneered wood painted RED I08 , Veneered wood painted CHERRY RED I09 , Veneered wood painted DARK BROWN I26 , Veneered wood painted NATURAL I40 , Veneered wood painted NATURAL OAK I52
------------	--

Shell finishes

Upholstery

TA	FAUX LEATHER Secret , FABRIC Mirage , FABRIC Cotton Club	TB	FAUX LEATHER Vintage , FABRIC Fenix Wool , FABRIC Novabuk , FABRIC Manhattan , FABRIC Visual
TC	VELVET SUPERB, FABRIC Second , FABRIC Main Line Flax , FABRIC Oceanic	TD	FABRIC Yoredale , FABRIC Remix 3
TE	FABRIC Uniform Melange	SF	LEATHER Fiore
SV	LEATHER Vintage	CU	HIDE
CT	TUSCAN HIDE		

Optionals:

	Value	Options/notes
FM-M2	+ 51 €	ASH GREY ES , BRONZE E2 , BULGARO RED FP , CHERRY RED EQ , DARK GREEN EL , FACEPOWDER PINK E8 , FANGO E3 , GOLDEN YELLOW EO , LIGHT BLUE EO , LIGHT GREY ET , OCEAN BLUE E1 , OCHER YELLOW E7 , PAPAYA ORANGE EA , PASTEL YELLOW E4 , PINE GREEN EJ , RED ER , SAGE GREEN E9
FM-M4	+ 117 €	BLACK NICKEL DZ , CHAMPAGNE GOLD DG , GOLDEN BRONZE DB , MATT BLACK NICKEL DY , MATT GOLDEN BRONZE DC , PINK GOLD DR
FL-I2	+ 15 €	Veneered wood FLAMED WALNUT I24 , Veneered wood NATURAL OAK I22
ES-1	+ 20 €	ES-1
PD-F0	+ 6 €	PD-F0

Lea S

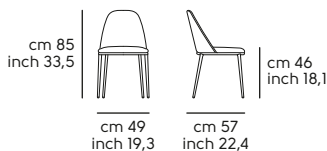

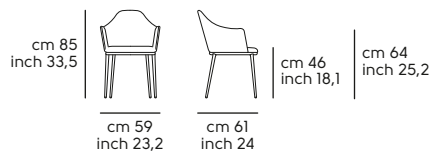

Lea P





Lea S, P - Shell in hide, fabric or leather, back in veneered wood

Frame in: metal

Model	Code	Mod.	Frame	Shell								Optional	Q.ty	boxes	Kg	M³	
				CU	CT												
	S1940SYC	GX	MI	788 €								990 €	FM-M2 ES-1	1	1	11.9	0.27
				TA	TB	TC	TD	TE	SF	SV	COM						



Model	Code	Mod.	Frame	TA	TB	TC	TD	TE	SF	SV	COM	COL	Optional	Q.ty	boxes	Kg	M³
					S1940SYT	GX	MI	617 €	654 €	693 €	717 €	823 €					

COM/COL - Minimum Q.ty 6 pc. for each material. For weft or patterned fabrics see specific pages

 Mtl. 1.10 h. 1.40 Each	 Mq. 2.00 Each
---	---

Model	Code	Mod.	Frame	Shell (Back Shell LII)								Optional	Q.ty	boxes	Kg	M³								
				TA	TB	TC	TD	TE	SF	SV	COM						COL							
	S1940SYL	GX	MI	706 €								726 €	763 €	771 €	841 €	802 €	843 €	706 €	763 €	FM-M2 FL-I2 ES-1	1	1	11.9	0.27
				TA	TB	TC	TD	TE	SF	SV	COM													



COM/COL - Minimum Q.ty 6 pc. for each material. For weft or patterned fabrics see specific pages

 Mtl. 0.72 h. 1.40 Each	 Mq. 1.30 Each
---	---

Model	Code	Mod.	Frame	Shell								Optional	Q.ty	boxes	Kg	M³	
				CU	CT												
	S1940PYC	GX	MI	964 €								1.257 €	FM-M2 ES-1	1	1	14.2	0.32
				TA	TB	TC	TD	TE	SF	SV	COM						



Model	Code	Mod.	Frame	TA	TB	TC	TD	TE	SF	SV	COM	COL	Optional	Q.ty	boxes	Kg	M³
					S1940PYT	GX	MI	720 €	746 €	796 €	864 €	1.020 €					

COM/COL - Minimum Q.ty 6 pc. for each material. For weft or patterned fabrics see specific pages

 Mtl. 1.60 h. 1.40 Each	 Mq. 2.85 Each
---	---

Model	Code	Mod.	Frame	Shell (Back Shell LII)									Optional	Q.ty	boxes	Kg	M ³
				TA	TB	TC	TD	TE	SF	SV	COM	COL					
 Armch. with self-return LEA P GX TS/L	S1940PYL	GX	M1	827 €	851 €	889 €	941 €	1.062 €	918 €	960 €	827 €	889 €	FM-M2 FL-12 ES-1	1	1	14.2	0.32

COM/COL - Minimum Q.ty 6 pc. for each material. For weft or patterned fabrics see specific pages

 Mtl. 1.25 h. 1.40 Each	 Mq. 2.10 Each
--	---

Note:

TS Front and Back covering available in two-tone or bi-material. Reference price in the upper category - ONLY Model GX TS

Frame finishes

Metal

MI	WHITE BB , BROWN E6 , SAND EC , GRAPHITE EG , BLACK EN
-----------	---

Backrest shell finishes

Wood

LII	Veneered wood painted GREY I02 , Veneered wood painted GRAFITE GREY I03 , Veneered wood painted BLACK I04 , Veneered wood painted WHITE I05 , Veneered wood painted BLUE I06 , Veneered wood painted RED I08 , Veneered wood painted CHERRY RED I09 , Veneered wood painted DARK BROWN I26 , Veneered wood painted NATURAL I40 , Veneered wood painted NATURAL OAK I52
------------	--

Shell finishes

Upholstery

TA	FAUX LEATHER Secret , FABRIC Mirage , FABRIC Cotton Club	TB	FAUX LEATHER Vintage , FABRIC Fenix Wool , FABRIC Novabuk , FABRIC Manhattan , FABRIC Visual
TC	VELVET SUPERB, FABRIC Second , FABRIC Main Line Flax , FABRIC Oceanic	TD	FABRIC Yoredale , FABRIC Remix 3
TE	FABRIC Uniform Melange	SF	LEATHER Fiore
SV	LEATHER Vintage	CU	HIDE
CT	TUSCAN HIDE		

Optionals:

	Value	Options/notes
FM-M2	+ 59 €	ASH GREY ES , BRONZE E2 , BULGARO RED FP , CHERRY RED EQ , DARK GREEN EL , FACEPOWDER PINK E8 , FANGO E3 , GOLDEN YELLOW EO , LIGHT BLUE EO , LIGHT GREY ET , OCEAN BLUE E1 , OCHER YELLOW E7 , PAPAYA ORANGE EA , PASTEL YELLOW E4 , PINE GREEN EJ , RED ER , SAGE GREEN E9
FL-12	+ 17 €	Veneered wood FLAMED WALNUT I24 , Veneered wood NATURAL OAK I22
ES-1	+ 20 €	ES-1

Lea S GX

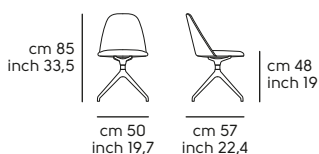

Lea P GX

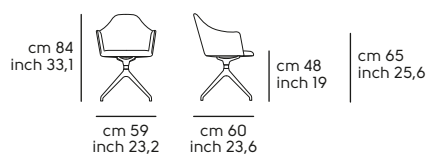

Lea AP, DV - Shell in fabric or leather

Frame in: metal

Model	Code	Mod.	Frame	Shell									Optional	Q.ty	boxes	Kg	M³
				TA	TB	TC	TD	TE	SF	SV	COM	COL					
 Waiting Chair LEA AP MTS	S1940AT	AP	MI	715 €	757 €	824 €	864 €	1.026 €	877 €	953 €	715 €	824 €	FM-M2 FM-M4 ES-1 PD-F0	1	1	12.0	0.36

COM/COL - Minimum Q.ty 6 pc. for each material. For weft or patterned fabrics see specific pages

 Mtl. 1.65 h. 1.40 Each	 Mq. 3.00 Each
---	---

Model	Code	Mod.	Frame	Shell									Optional	Q.ty	boxes	Kg	M³
				TA	TB	TC	TD	TE	SF	SV	COM	COL					
 Sofa LEA DV MTS	S1940LT	DV	MI	1.030 €	1.128 €	1.191 €	1.269 €	1.527 €	1.482 €	1.662 €	1.030 €	1.191 €	FM-M2 FM-M4 ES-1 PD-F0	1	1	22.0	0.69

COM/COL - Minimum Q.ty 6 pc. for each material. For weft or patterned fabrics see specific pages

 Mtl. 2.65 h. 1.40 Each	 Mq. 4.80 Each
---	---

Note:

TS Front and Back covering available in two-tone or bi-material. Reference price in the upper category

Frame finishes

Metal

MI	WHITE BB , BROWN E6 , SAND EC , GRAPHITE EG , BLACK EN
-----------	---

Shell finishes

Upholstery

TA	FAUX LEATHER Secret , FABRIC Mirage , FABRIC Cotton Club	TB	FAUX LEATHER Vintage , FABRIC Fenix Wool , FABRIC Novabuk , FABRIC Manhattan , FABRIC Visual
TC	VELVET SUPERB, FABRIC Second , FABRIC Main Line Flax , FABRIC Oceanic	TD	FABRIC Yoredale , FABRIC Remix 3
TE	FABRIC Uniform Melange	SF	LEATHER Fiore
SV	LEATHER Vintage		

Optionals:

	Value	Options/notes
FM-M2	Indoor matt metal M2	+ 65 €
		ASH GREY ES , BRONZE E2 , BULGARO RED FP , CHERRY RED EQ , DARK GREEN EL , FACEPOWDER PINK E8 , FANGO E3 , GOLDEN YELLOW EO , LIGHT BLUE E0 , LIGHT GREY ET , OCEAN BLUE EI , OCHER YELLOW E7 , PAPAYA ORANGE EA , PASTEL YELLOW E4 , PINE GREEN EJ , RED ER , SAGE GREEN E9
FM-M4	Indoor glossy Metal M4	+ 194 €
		BLACK NICKEL DZ , CHAMPAGNE GOLD DG , GOLDEN BRONZE DB , MATT BLACK NICKEL DY , MATT GOLDEN BRONZE DC , PINK GOLD DR
ES-1	Fireproof foam	+ 40 €
		ES-1
PD-F0	Felt pad feet	+ 6 €
		PD-F0

Lea AP

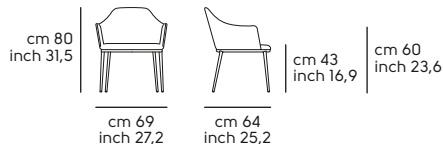



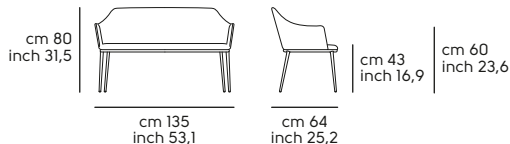





Lea DV





Lea H65-H75-SG - Shell in hide, fabric or leather

Frame in: metal

Model	Code	Mod.	Frame	Shell												Optional	Q.ty	boxes	Kg	M³
				CU						CT										
Stool LEA H65 M CU																				
	S1940HC	H65	M1	597 €						796 €						FM-M2 FM-M4 ES-1 PD-F0	1	1	9.5	0.34
Stool LEA H75 M CU																				
	S1940JC	H75	M1	611 €						810 €						FM-M2 FM-M4 ES-1 PD-F0	1	1	10.0	0.38
Stool LEA SG CU																				
 	S1940ZC	SG	M1	862 €						1.061 €						FM-M2 ES-1	1	1	20.5	0.25
				TA	TB	TC	TD	TE	SF	SV	COM	COL								
Stool LEA H65 M TS																				
	S1940HT	H65	M1	484 €	500 €	541 €	574 €	671 €	579 €	624 €	484 €	541 €	FM-M2 FM-M4 ES-1 PD-F0	1	1	9.5	0.34			
Stool LEA H75 M TS																				
 	S1940JT	H75	M1	495 €	512 €	552 €	586 €	683 €	591 €	638 €	495 €	552 €	FM-M2 FM-M4 ES-1 PD-F0	1	1	10.0	0.38			
Stool LEA SG TS																				
 	S1940ZT	SG	M1	749 €	764 €	805 €	839 €	936 €	843 €	888 €	749 €	805 €	FM-M2 ES-1	1	1	19.5	0.25			

COM/COL - Minimum Q.ty 6 pc. for each material. For weft or patterned fabrics see specific pages

 Mtl. 1.00 h. 1.40 Each	 Mq. 1.60 Each
--	---

Note:

TS Front and Back covering available in two-tone or bi-material. Reference price in the upper category - ONLY Model M TS

Frame finishes

Metal	
MI	WHITE BB , BROWN E6 , SAND EC , GRAPHITE EG , BLACK EN

Shell finishes

Upholstery			
TA	FAUX LEATHER Secret , FABRIC Mirage , FABRIC Cotton Club	TB	FAUX LEATHER Vintage , FABRIC Fenix Wool , FABRIC Novabuk , FABRIC Manhattan , FABRIC Visual
TC	VELVET SUPERB, FABRIC Second , FABRIC Main Line Flax , FABRIC Oceanic	TD	FABRIC Yoredale , FABRIC Remix 3
TE	FABRIC Uniform Melange	SF	LEATHER Fiore
SV	LEATHER Vintage	CU	HIDE
CT	TUSCAN HIDE		

Optionals:

		Value	Options/notes
FM-M2	Indoor matt metal M2	+ 51 €	ASH GREY ES , BRONZE E2 , BULGARO RED FP , CHERRY RED EQ , DARK GREEN EL , FACEPOWDER PINK E8 , FANGO E3 , GOLDEN YELLOW EO , LIGHT BLUE E0 , LIGHT GREY ET , OCEAN BLUE E1 , OCHER YELLOW E7 , PAPAYA ORANGE EA , PASTEL YELLOW E4 , PINE GREEN EJ , RED ER , SAGE GREEN E9
FM-M4	Indoor glossy Metal M4	+ 154 €	BLACK NICKEL DZ , CHAMPAGNE GOLD DG , GOLDEN BRONZE DB , MATT BLACK NICKEL DY , MATT GOLDEN BRONZE DC , PINK GOLD DR
ES-1	Fireproof foam	+ 20 €	ES-1
PD-F0	Felt pad feet	+ 6 €	PD-F0

Lea H65

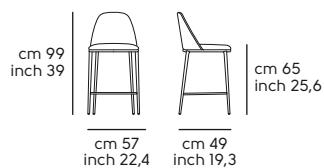

Lea H75

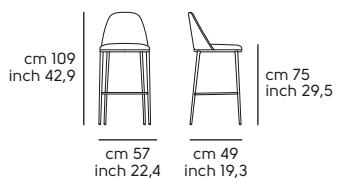

Lea SG



Lea B1-B2-B3 pouf - Seat in fabric or leather

Frame in: metal

Model	Code	Mod.	Frame	Shell									Optional	Q.ty	boxes	Kg	M³
				TA	TB	TC	TD	TE	SF	SV	COM	COL					
 <p>Pouf LEA B1 M TS</p>	S1940B1	B1	M1	243 €	252 €	256 €	301 €	365 €	265 €	290 €	243 €	256 €	FM-M2 FM-M4 ES-1 PD-F0	1	1	5.5	0.1

COM/COL - Minimum Q.ty 6 pc. for each material. For weft or patterned fabrics see specific pages

 Mtl. 0.65 h. 1.40 Each	 Mq. 1.15 Each
--	---



Model	Code	Mod.	Frame	Shell									Optional	Q.ty	boxes	Kg	M³
				TA	TB	TC	TD	TE	SF	SV	COM	COL					
 <p>Pouf LEA B2 M TS</p>	S1940B2	B2	M1	271 €	284 €	290 €	344 €	421 €	303 €	342 €	271 €	290 €	FM-M2 FM-M4 ES-1 PD-F0	1	1	5.8	0.11

COM/COL - Minimum Q.ty 6 pc. for each material. For weft or patterned fabrics see specific pages

 Mtl. 0.80 h. 1.40 Each	 Mq. 1.40 Each
--	---

Model	Code	Mod.	Frame	Shell									Optional	Q.ty	boxes	Kg	M³
				TA	TB	TC	TD	TE	SF	SV	COM	COL					
 <p>Pouf LEA B3 M TS</p>	S1940B3	B3	M1	329 €	354 €	378 €	437 €	553 €	412 €	484 €	329 €	378 €	FM-M2 FM-M4 ES-1 PD-F0	1	1	7.1	0.16

COM/COL - Minimum Q.ty 6 pc. for each material. For weft or patterned fabrics see specific pages

 Mtl. 1.20 h. 1.40 Each	 Mq. 2.20 Each
--	---

Frame finishes

Metal	
MI	WHITE BB , BROWN E6 , SAND EC , GRAPHITE EG , BLACK EN

Shell finishes

Upholstery			
TA	FAUX LEATHER Secret , FABRIC Mirage , FABRIC Cotton Club	TB	FAUX LEATHER Vintage , FABRIC Fenix Wool , FABRIC Novabuk , FABRIC Manhattan , FABRIC Visual
TC	VELVET SUPERB, FABRIC Second , FABRIC Main Line Flax , FABRIC Oceanic	TD	FABRIC Yoredale , FABRIC Remix 3
TE	FABRIC Uniform Melange	SF	LEATHER Fiore
SV	LEATHER Vintage		

Optionals:

		Value	Options/notes
FM-M2	Indoor matt metal M2	+ 45 €	ASH GREY ES , BRONZE E2 , BULGARO RED FP , CHERRY RED EQ , DARK GREEN EL , FACEPOWDER PINK E8 , FANGO E3 , GOLDEN YELLOW EO , LIGHT BLUE E0 , LIGHT GREY ET , OCEAN BLUE EI , OCHER YELLOW E7 , PAPAYA ORANGE EA , PASTEL YELLOW E4 , PINE GREEN EJ , RED ER , SAGE GREEN E9
FM-M4	Indoor glossy Metal M4	+ 117 €	BLACK NICKEL DZ , CHAMPAGNE GOLD DG , GOLDEN BRONZE DB , MATT BLACK NICKEL DY , MATT GOLDEN BRONZE DC , PINK GOLD DR
ES-1	Fireproof foam	+ 5 €	ES-1
PD-F0	Felt pad feet	+ 6 €	PD-F0

Lea B1

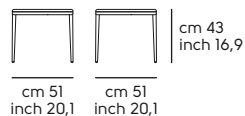

Lea B2

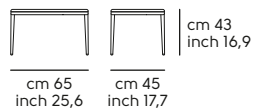



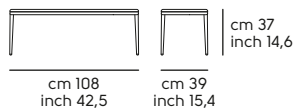





Lea B3



Liù design Archirivolto

Liù S, P, D, DP - Wood shell

Frame in: metal or wood or metal-wood

Model	Code	Base type	Frame	Shell		Optional	Q.ty	boxes	Kg	M ³
				LI1	LI2					
Chair LIÙ S M LG_M 	S1280SL_M	_M	M1	256 €	277 €	FM-M2 FM-M3 FM-M4 PD-F0	2 4	1 1	12.0 25.0	0.34 0.43
Chair LIÙ S M LG_T 	S1280SL_T	_T	M1	279 €	300 €	FM-M2 FM-M3 FM-M4	2 4	1 1	12.0 25.0	0.34 0.43
Chair LIÙ S M LG_X 	S1280SL_X	_X	M1	276 €	297 €	FM-M2 FM-M3 FM-M4 PD-F0	2	1	12.0	0.28
Chair LIÙ S L LG_R 	S1280WL_R	_R	LF1	347 €	368 €	PD-F0	2	1	19.0	0.31
Chair LIÙ S ML LG 	S1285ML	ML	LF1-M1	372 €	393 €	FM-M2 PD-F0	2	1	20.0	0.32
Armch. LIÙ P M LG 	S1280PL	M	M1	303 €	324 €	FM-M2 FM-M3 FM-M4 PD-F0	2 4	1 1	14.0 31.0	0.36 0.51
Office Chair LIÙ DS LG 	S1280DL	DS	M1	434 €	455 €	FM-M2 FM-M3	1	2	10.5	0.27
Office Arm. LIÙ DP LG 	S1280EL	DP	M1	481 €	500 €	FM-M2 FM-M3	1	2	11.0	0.34

Frame finishes

Metal

MI	WHITE BB , INDUSTRIAL E5 , BROWN E6 , SAND EC , GRAPHITE EG , BLACK EN
-----------	--

Wood

LFI	Ash wood painted GREY F02 , Ash wood painted GRAFITE GREY F03 , Ash wood painted BLACK F04 , Ash wood painted WHITE F05 , Ash wood painted BLUE F06 , Ash wood painted RED F08 , Ash wood painted CHERRY RED F09 , Ash wood painted FLAMED WALNUT F24 , Ash wood painted DARK BROWN F26 , Ash wood painted NATURAL F40 , Ash wood painted NATURAL OAK F52
------------	--

Insert finishes

Metal

MI	WHITE BB , INDUSTRIAL E5 , BROWN E6 , SAND EC , GRAPHITE EG , BLACK EN
-----------	--

Shell finishes

Wood

LII	Veneered wood painted GREY I02 , Veneered wood painted GRAFITE GREY I03 , Veneered wood painted BLACK I04 , Veneered wood painted WHITE I05 , Veneered wood painted BLUE I06 , Veneered wood painted RED I08 , Veneered wood painted CHERRY RED I09 , Veneered wood painted DARK BROWN I26 , Veneered wood painted NATURAL I40 , Veneered wood painted NATURAL OAK I52
LIZ	Veneered wood NATURAL OAK I22 , Veneered wood FLAMED WALNUT I24

Optionals:

		Value	Options/notes
FM-M2	Indoor matt metal M2	+ 45 €	ASH GREY ES , BRONZE E2 , BULGARO RED FP , CHERRY RED EQ , DARK GREEN EL , FACEPOWDER PINK E8 , FANGO E3 , GOLDEN YELLOW EO , LIGHT BLUE E0 , LIGHT GREY ET , OCEAN BLUE E1 , OCHER YELLOW E7 , PAPAYA ORANGE EA , PASTEL YELLOW E4 , PINE GREEN EJ , RED ER , SAGE GREEN E9
FM-M3	Indoor glossy metal M3	+ 20 €	CHROME CC
FM-M4	Indoor glossy Metal M4	+ 103 €	BLACK NICKEL DZ , CHAMPAGNE GOLD DG , GOLDEN BRONZE DB , MATT BLACK NICKEL DY , MATT GOLDEN BRONZE DC , PINK GOLD DR
PD-F0	Felt pad feet	+ 6 €	PD-F0

Liù S_M

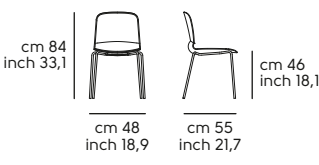

Liù S_T

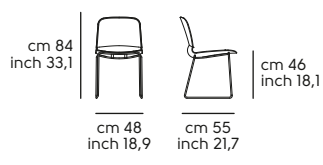

Liù S_X

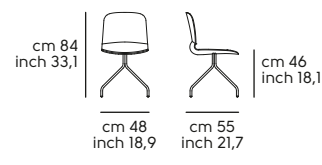

Liù S_R

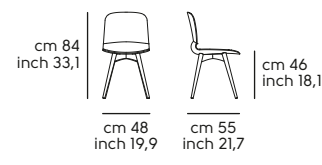

Liù S ML

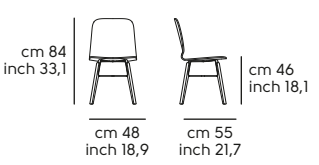

Liù P M

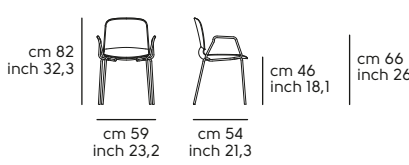

Liù S DS

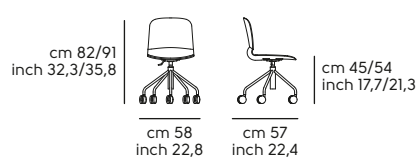



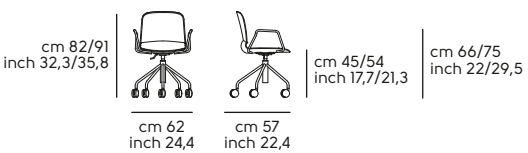









Liù P DP



LIÙ S, P, D, DP - Shell in fabric or leather with horizontal stitches

Frame in: metal or wood or metal-wood

Model	Code	Base type	Frame	Shell									Optional	Q.ty	boxes	Kg	M³
				TA	TB	TC	TD	TE	SF	SV	COM	COL					
Chair LIÙ S M TS_M  	S1280ST_M	_M	M1	263 €	274 €	315 €	340 €	425 €	349 €	417 €	263 €	315 €	FM-M2 FM-M3 FM-M4 ES-1 PD-F0	2 4	1 1	16.0 24.0	0.34 0.46
Chair LIÙ S M TS_T 	S1280ST_T	_T	M1	286 €	297 €	338 €	363 €	448 €	372 €	440 €	286 €	338 €	FM-M2 FM-M3 FM-M4 ES-1	2 4	1 1	16.0 24.0	0.34 0.46
Chair LIÙ S M TS_X 	S1280ST_X	_X	M1	283 €	294 €	335 €	360 €	445 €	369 €	437 €	283 €	335 €	FM-M2 FM-M3 FM-M4 ES-1 PD-F0	2	1	16.0	0.34
Chair LIÙ S L TS_R  	S1280WT_R	_R	LF1	355 €	365 €	406 €	434 €	519 €	439 €	508 €	355 €	406 €	ES-1 PD-F0	2	1	14.0	0.35
Chair LIÙ S ML TS  	S1285MT	ML	LF1-M1	377 €	391 €	433 €	456 €	541 €	464 €	533 €	377 €	433 €	FM-M2 ES-1 PD-F0	2	1	12.0	0.28
Armch. LIÙ P M TS 	S1280PT	M	M1	308 €	320 €	362 €	386 €	470 €	394 €	464 €	308 €	362 €	FM-M2 FM-M3 FM-M4 ES-1 PD-F0	2 4	1 1	14.0 31.0	0.36 0.51
Office Chair LIÙ DS TS  	S1280DT	DS	M1	440 €	450 €	491 €	519 €	603 €	524 €	593 €	440 €	491 €	FM-M2 FM-M3 ES-1	1	2	10.5	0.28
Office Arm. LIÙ DP TS  	S1280ET	DP	M1	487 €	498 €	539 €	566 €	651 €	570 €	641 €	487 €	539 €	FM-M2 FM-M3 ES-1	1	2	11.0	0.35

Frame finishes

Metal

MI	WHITE BB , BROWN E6 , SAND EC , GRAPHITE EG , BLACK EN
-----------	---

Wood

LFI	Ash wood painted GREY F02 , Ash wood painted GRAFITE GREY F03 , Ash wood painted BLACK F04 , Ash wood painted WHITE F05 , Ash wood painted BLUE F06 , Ash wood painted RED F08 , Ash wood painted CHERRY RED F09 , Ash wood painted FLAMED WALNUT F24 , Ash wood painted DARK BROWN F26 , Ash wood painted NATURAL F40 , Ash wood painted NATURAL OAK F52
------------	--

Insert finishes

Metal



MI	WHITE BB , BROWN E6 , SAND EC , GRAPHITE EG , BLACK EN
-----------	---

Shell finishes

Upholstery

TA	FAUX LEATHER Secret , FABRIC Mirage , FABRIC Cotton Club	TB	FAUX LEATHER Vintage , FABRIC Fenix Wool , FABRIC Novabuk , FABRIC Manhattan , FABRIC Visual
TC	VELVET SUPERB, FABRIC Second , FABRIC Main Line Flax , FABRIC Oceanic	TD	FABRIC Yoredale , FABRIC Remix 3
TE	FABRIC Uniform Melange	SF	LEATHER Fiore
SV	LEATHER Vintage		

COM/COL - Minimum Q.ty 6 pc. for each material. For weft or patterned fabrics see specific pages

 COM	Mtl. 0.87 h. 1.40 Each	 COL	Mq. 1.10 Each
---	------------------------	--	---------------

Optionals:

	Value	Options/notes
FM-M2	+ 45 €	ASH GREY ES , BRONZE E2 , BULGARO RED FP , CHERRY RED EQ , DARK GREEN EL , FACEPOWDER PINK E8 , FANGO E3 , GOLDEN YELLOW EO , LIGHT BLUE EO , LIGHT GREY ET , OCEAN BLUE E1 , OCHER YELLOW E7 , PAPAYA ORANGE EA , PASTEL YELLOW E4 , PINE GREEN EJ , RED ER , SAGE GREEN E9
FM-M3	+ 20 €	CHROME CC
FM-M4	+ 103 €	BLACK NICKEL DZ , CHAMPAGNE GOLD DG , GOLDEN BRONZE DB , MATT BLACK NICKEL DY , MATT GOLDEN BRONZE DC , PINK GOLD DR
ES-1	+ 6 €	ES-1
PD-F0	+ 6 €	PD-F0

Liù S_M

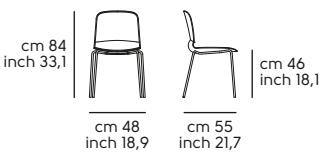

Liù S_T

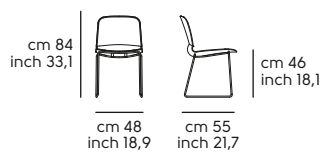

Liù S_X

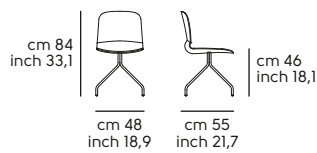

Liù S_R



Liù S ML

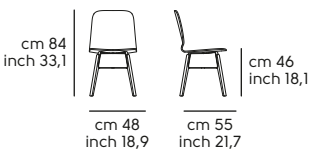

Liù P M

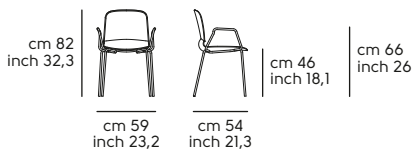

Liù S DS

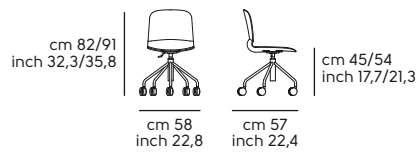



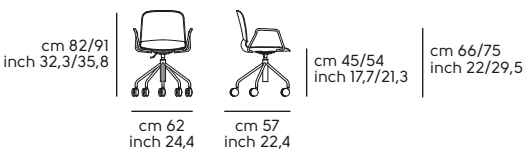





Liù P DP



Liù S, P, D, DP - Shell in fabric or leather with wrinkles

Frame in: metal or wood or metal-wood

Model	Code	Base type	Frame	Shell									Optional	Q.ty	boxes	Kg	M ³
				TA	TB	TC	TD	TE	SF	SV	COM	COL					
Chair LIÙ S M TS2_M 	S1280SU_M	_M	M1	269 €	293 €	328 €	348 €	433 €	372 €	443 €	269 €	328 €	FM-M2 FM-M3 FM-M4 ES-1 PD-FO	2 4	1 1	16.0 24.0	0.34 0.46
Chair LIÙ S M TS2_T 	S1280SU_T	_T	M1	292 €	316 €	351 €	371 €	456 €	395 €	466 €	292 €	351 €	FM-M2 FM-M3 FM-M4 ES-1	2 4	1 1	16.0 24.0	0.34 0.46
Chair LIÙ S M TS2_X 	S1280SU_X	_X	M1	289 €	313 €	348 €	368 €	453 €	392 €	463 €	289 €	348 €	FM-M2 FM-M3 FM-M4 ES-1 PD-FO	2	1	16.0	0.34
Chair LIÙ S L TS2_R 	S1280WU_R	_R	LF1	359 €	384 €	417 €	438 €	523 €	463 €	533 €	359 €	417 €	ES-1 PD-FO	2	1	14.0	0.35
Chair LIÙ S ML TS2 	S1285MU	ML	LF1-M1	386 €	411 €	443 €	464 €	549 €	488 €	560 €	386 €	443 €	FM-M2 ES-1 PD-FO	2	1	12.0	0.28
Armch. LIÙ P M TS2 	S1280PU	M	M1	315 €	339 €	374 €	394 €	479 €	418 €	489 €	315 €	374 €	FM-M2 FM-M3 FM-M4 ES-1 PD-FO	2 4	1 1	14.0 31.0	0.36 0.51
Office Chair LIÙ DS TS2 	S1280DU	DS	M1	445 €	469 €	505 €	524 €	609 €	548 €	620 €	445 €	505 €	FM-M2 FM-M3 ES-1	1	2	10.5	0.28
Office Arm. LIÙ DP TS2 	S1280EU	DP	M1	491 €	517 €	549 €	570 €	655 €	595 €	666 €	491 €	549 €	FM-M2 FM-M3 ES-1	1	2	11.0	0.35

Frame finishes

Metal

MI	WHITE BB , BROWN E6 , SAND EC , GRAPHITE EG , BLACK EN
-----------	---

Wood

LFI	Ash wood painted GREY F02 , Ash wood painted GRAFITE GREY F03 , Ash wood painted BLACK F04 , Ash wood painted WHITE F05 , Ash wood painted BLUE F06 , Ash wood painted RED F08 , Ash wood painted CHERRY RED F09 , Ash wood painted FLAMED WALNUT F24 , Ash wood painted DARK BROWN F26 , Ash wood painted NATURAL F40 , Ash wood painted NATURAL OAK F52
------------	--

Insert finishes

Metal



MI	WHITE BB , BROWN E6 , SAND EC , GRAPHITE EG , BLACK EN
-----------	---

Shell finishes

Upholstery

TA	FAUX LEATHER Secret , FABRIC Mirage , FABRIC Cotton Club	TB	FAUX LEATHER Vintage , FABRIC Fenix Wool , FABRIC Novabuk , FABRIC Manhattan , FABRIC Visual
TC	VELVET SUPERB, FABRIC Second , FABRIC Main Line Flax , FABRIC Oceanic	TD	FABRIC Yoredale , FABRIC Remix 3
TE	FABRIC Uniform Melange	SF	LEATHER Fiore
SV	LEATHER Vintage		

COM/COL - Minimum Q.ty 6 pc. for each material. For weft or patterned fabrics see specific pages

 COM	Mtl. 0.75 h. 1.40 Each	 COL	Mq. 1.10 Each
---	------------------------	--	---------------

Optionals:

	Value	Options/notes
FM-M2	+ 45 €	ASH GREY ES , BRONZE E2 , BULGARO RED FP , CHERRY RED EQ , DARK GREEN EL , FACEPOWDER PINK E8 , FANGO E3 , GOLDEN YELLOW EO , LIGHT BLUE EO , LIGHT GREY ET , OCEAN BLUE E1 , OCHER YELLOW E7 , PAPAYA ORANGE EA , PASTEL YELLOW E4 , PINE GREEN EJ , RED ER , SAGE GREEN E9
FM-M3	+ 20 €	CHROME CC
FM-M4	+ 103 €	BLACK NICKEL DZ , CHAMPAGNE GOLD DG , GOLDEN BRONZE DB , MATT BLACK NICKEL DY , MATT GOLDEN BRONZE DC , PINK GOLD DR
ES-1	+ 6 €	ES-1
PD-F0	+ 6 €	PD-F0

Liù S_M

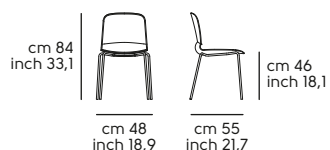

Liù S_T

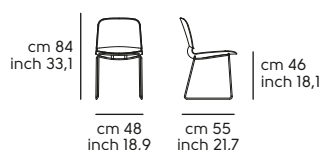

Liù S_X

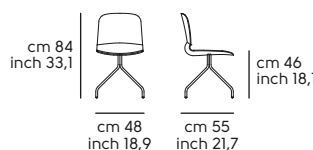

Liù S_R

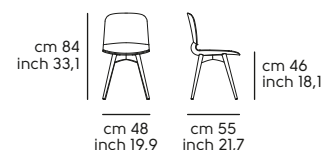

Liù S ML

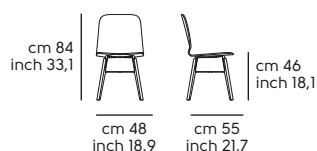

Liù P M

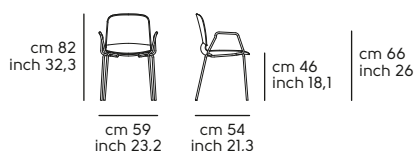

Liù S DS

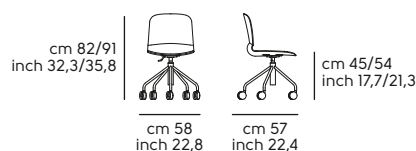



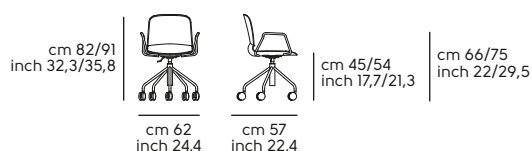





Liù P DP



Liù S, P, D, DP - Shell in fabric or leather with wrinkles and back in wood

Frame in: metal or wood or metal-wood

Model	Code	Base type	Frame	Shell (Back Shell LI)									Optional	Q.ty	boxes	Kg	M ³
				TA	TB	TC	TD	TE	SF	SV	COM	COL					
Chair LIÙ S M TS2/L_M 	S1280SY_M	_M	M1	396 €	408 €	432 €	441 €	528 €	501 €	571 €	396 €	432 €	FM-M2 FM-M3 FM-M4 FL-I2 ES-1 PD-F0	2 4	1 1	16.0 24.0	0.34 0.46
Chair LIÙ S M TS2/L_T 	S1280SY_T	_T	M1	419 €	431 €	455 €	464 €	551 €	524 €	594 €	419 €	455 €	FM-M2 FM-M3 FM-M4 FL-I2 ES-1	2 4	1 1	16.0 24.0	0.34 0.46
Chair LIÙ S M TS2/L_X 	S1280SY_X	_X	M1	416 €	428 €	452 €	461 €	548 €	521 €	591 €	416 €	452 €	FM-M2 FM-M3 FM-M4 FL-I2 ES-1 PD-F0	2	1	16.0	0.34
Chair LIÙ S L TS2/L_R 	S1280WY_R	_R	LF1	487 €	498 €	521 €	532 €	620 €	591 €	663 €	487 €	521 €	FL-I2 ES-1 PD-F0	2	1	14.0	0.35
Chair LIÙ S ML TS2/L 	S1285MY	ML	LF1-M1	512 €	523 €	546 €	558 €	645 €	617 €	688 €	512 €	546 €	FM-M2 FL-I2 ES-1 PD-F0	2	1	12.0	0.28
Armch. LIÙ P M TS2/L 	S1280PY	M	M1	443 €	455 €	477 €	488 €	575 €	547 €	618 €	443 €	477 €	FM-M2 FM-M3 FM-M4 FL-I2 ES-1 PD-F0	2 4	1 1	14.0 31.0	0.36 0.51
Office Chair LIÙ DS TS2/L 	S1280DY	DS	M1	572 €	585 €	608 €	617 €	705 €	678 €	749 €	572 €	608 €	FM-M2 FM-M3 FL-I2 ES-1	1	2	10.5	0.28
Office Arm. LIÙ DP TS2/L 	S1280EY	DP	M1	620 €	630 €	654 €	665 €	752 €	725 €	795 €	620 €	654 €	FM-M2 FM-M3 FL-I2 ES-1	1	2	11.0	0.35

Frame finishes

Metal	
MI	WHITE BB , BROWN E6 , SAND EC , GRAPHITE EG , BLACK EN

Wood	
LFI	Ash wood painted GREY F02 , Ash wood painted GRAFITE GREY F03 , Ash wood painted BLACK F04 , Ash wood painted WHITE F05 , Ash wood painted BLUE F06 , Ash wood painted RED F08 , Ash wood painted CHERRY RED F09 , Ash wood painted FLAMED WALNUT F24 , Ash wood painted DARK BROWN F26 , Ash wood painted NATURAL F40 , Ash wood painted NATURAL OAK F52

Insert finishes

Metal	
MI	WHITE BB , BROWN E6 , SAND EC , GRAPHITE EG , BLACK EN



Backrest shell finishes

Wood	
LII	Veneered wood painted GREY I02 , Veneered wood painted GRAFITE GREY I03 , Veneered wood painted BLACK I04 , Veneered wood painted WHITE I05 , Veneered wood painted BLUE I06 , Veneered wood painted RED I08 , Veneered wood painted CHERRY RED I09 , Veneered wood painted DARK BROWN I26 , Veneered wood painted NATURAL I40 , Veneered wood painted NATURAL OAK I52

Shell finishes

Upholstery			
TA	FAUX LEATHER Secret , FABRIC Mirage , FABRIC Cotton Club	TB	FAUX LEATHER Vintage , FABRIC Fenix Wool , FABRIC Novabuk , FABRIC Manhattan , FABRIC Visual
TC	VELVET SUPERB, FABRIC Second , FABRIC Main Line Flax , FABRIC Oceanic	TD	FABRIC Yoredale , FABRIC Remix 3
TE	FABRIC Uniform Melange	SF	LEATHER Fiore
SV	LEATHER Vintage		

COM/COL - Minimum Q.ty 6 pc. for each material. For weft or patterned fabrics see specific pages

 COM	Mtl. 0.50 h. 1.40 Each	 COL	Mq. 0.80 Each
---	------------------------	--	---------------

Optionals:

	Value	Options/notes
FM-M2	+ 45 €	ASH GREY ES , BRONZE E2 , BULGARO RED FP , CHERRY RED EQ , DARK GREEN EL , FACEPOWDER PINK E8 , FANGO E3 , GOLDEN YELLOW EO , LIGHT BLUE E0 , LIGHT GREY ET , OCEAN BLUE E1 , OCHER YELLOW E7 , PAPAYA ORANGE EA , PASTEL YELLOW E4 , PINE GREEN EJ , RED ER , SAGE GREEN E9
FM-M3	+ 20 €	CHROME CC
FM-M4	+ 103 €	BLACK NICKEL DZ , CHAMPAGNE GOLD DG , GOLDEN BRONZE DB , MATT BLACK NICKEL DY , MATT GOLDEN BRONZE DC , PINK GOLD DR
FL-I2	+ 15 €	Veneered wood FLAMED WALNUT I24 , Veneered wood NATURAL OAK I22
ES-1	+ 6 €	ES-1
PD-F0	+ 6 €	PD-F0

Liù S_M

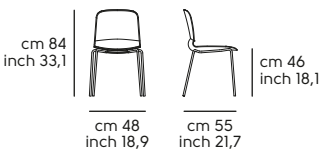

Liù S_T

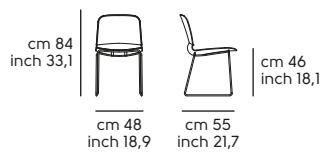

Liù S_X

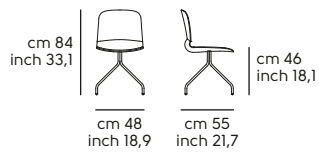

Liù S_R

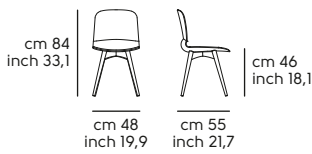

Liù S ML

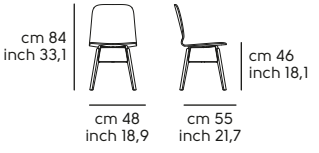

Liù P M

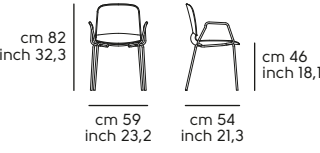

Liù S DS

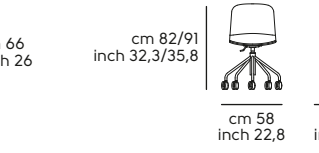



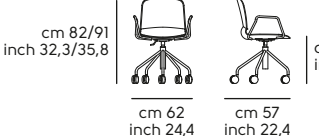







Liù P DP



Liù H65-75-SG - Wood shell

Frame in: metal, metal-wood or wood

Model	Code	Mod.	Frame	Shell		Optional	Q.ty	boxes	Kg	M³
				LI1	LI2					
Stool LIÙ H65 M LG  	S1280HL	H65	M1	314 €	328 €	FM-M2 FM-M3 FM-M4 PD-F0	2	1	14.0	0.24
Stool LIÙ H75 M LG  	S1280JL	H75	M1	329 €	342 €	FM-M2 FM-M3 FM-M4 PD-F0	2	1	16.0	0.31
Stool LIÙ H65 ML LG 	S1285HL	ML H65	LF1-M1	469 €	483 €	FM-M2 PD-F0	1	1	14.0	0.24
Stool LIÙ H75 ML LG 	S1285JL	ML H75	LF1-M1	484 €	494 €	FM-M2 PD-F0	1	1	16.0	0.31
Stool LIÙ H65 LR-LG 	S1280HI	LR H65	LF1	424 €	438 €	PD-F0	1	1	6.55	0.21
Stool LIÙ H75 LR-LG 	S1280JI	LR H75	LF1	443 €	457 €	PD-F0	1	1	6.85	0.24
Stool LIÙ SG LG  	S1280ZL	SG	M1	579 €	592 €	FM-M2	1	1	16.0	0.21

Frame finishes

Metal

MI	WHITE BB , BROWN E6 , SAND EC , GRAPHITE EG , BLACK EN
-----------	---

Wood

LFI	Ash wood painted GREY F02 , Ash wood painted GRAFITE GREY F03 , Ash wood painted BLACK F04 , Ash wood painted WHITE F05 , Ash wood painted BLUE F06 , Ash wood painted RED F08 , Ash wood painted CHERRY RED F09 , Ash wood painted FLAMED WALNUT F24 , Ash wood painted DARK BROWN F26 , Ash wood painted NATURAL F40 , Ash wood painted NATURAL OAK F52
------------	--

Insert finishes

Metal

MI	WHITE BB , BROWN E6 , SAND EC , GRAPHITE EG , BLACK EN
-----------	---

Shell finishes

Wood

LII	Veneered wood painted GREY I02 , Veneered wood painted GRAFITE GREY I03 , Veneered wood painted BLACK I04 , Veneered wood painted WHITE I05 , Veneered wood painted BLUE I06 , Veneered wood painted RED I08 , Veneered wood painted CHERRY RED I09 , Veneered wood painted DARK BROWN I26 , Veneered wood painted NATURAL I40 , Veneered wood painted NATURAL OAK I52
LII	Veneered wood NATURAL OAK I22 , Veneered wood FLAMED WALNUT I24





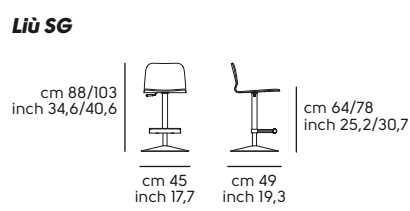
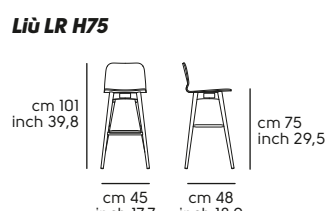
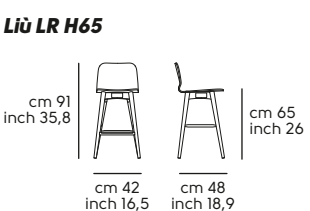
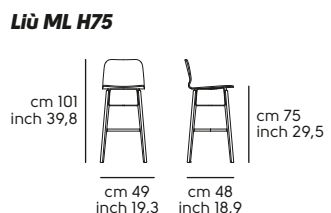
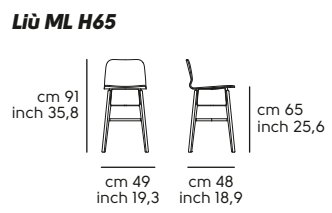
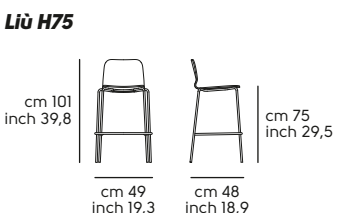
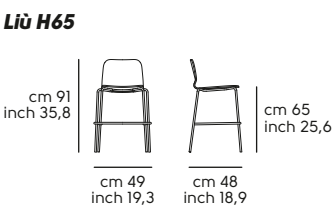





Optionals:

		Value	Options/notes
FM-M2	Indoor matt metal M2	+ 45 €	ASH GREY ES , BRONZE E2 , BULGARO RED FP , CHERRY RED EQ , DARK GREEN EL , FACEPOWDER PINK E8 , FANGO E3 , GOLDEN YELLOW EO , LIGHT BLUE E0 , LIGHT GREY ET , OCEAN BLUE EI , OCHER YELLOW E7 , PAPAYA ORANGE EA , PASTEL YELLOW E4 , PINE GREEN EJ , RED ER , SAGE GREEN E9
FM-M3	Indoor glossy metal M3	+ 20 €	CHROME CC
FM-M4	Indoor glossy Metal M4	+ 103 €	BLACK NICKEL DZ , CHAMPAGNE GOLD DG , GOLDEN BRONZE DB , MATT BLACK NICKEL DY , MATT GOLDEN BRONZE DC , PINK GOLD DR
PD-F0	Felt pad feet	+ 6 €	PD-F0



Liù H65-75-SG - Shell in fabric or leather with wrinkles

Frame in: metal, metal-wood or wood

Model	Code	Mod.	Frame	Shell									Optional	Q.ty	boxes	Kg	M³
				TA	TB	TC	TD	TE	SF	SV	COM	COL					
Stool LIÙ H65 M TS2  	S1280HU	H65	M1	315 €	329 €	354 €	370 €	427 €	417 €	561 €	315 €	354 €	FM-M2 FM-M3 FM-M4 ES-1 PD-F0	2	1	14.0	0.28
Stool LIÙ H75 M TS2  	S1280JU	H75	M1	329 €	342 €	368 €	382 €	441 €	431 €	572 €	329 €	368 €	FM-M2 FM-M3 FM-M4 ES-1 PD-F0	2	1	16.0	0.33
Stool LIÙ H65 ML TS2 	S1285HU	ML H65	LF1-M1	463 €	475 €	500 €	517 €	575 €	565 €	719 €	463 €	500 €	FM-M2 ES-1 PD-F0	1	1	14.0	0.24
Stool LIÙ H75 ML TS2 	S1285JU	ML H75	LF1-M1	475 €	488 €	512 €	528 €	587 €	575 €	732 €	475 €	512 €	FM-M2 ES-1 PD-F0	1	1	16.0	0.31
Stool LIÙ H65 LR-TS2 	S1280HJ	LR H65	LF1	425 €	439 €	464 €	480 €	538 €	527 €	671 €	425 €	464 €	ES-1 PD-F0	1	1	7.05	0.21
Stool LIÙ H75 LR-TS2 	S1280JJ	LR H75	LF1	443 €	457 €	482 €	498 €	555 €	545 €	687 €	443 €	482 €	ES-1 PD-F0	1	1	7.35	0.24
Stool LIÙ SG TS2  	S1280ZU	SG	M1	547 €	560 €	586 €	601 €	659 €	648 €	793 €	547 €	586 €	FM-M2 ES-1	1	1	16.5	0.21

Frame finishes

Metal

MI	WHITE BB , BROWN E6 , SAND EC , GRAPHITE EG , BLACK EN
-----------	---

Wood

LFI	Ash wood painted GREY F02 , Ash wood painted GRAFITE GREY F03 , Ash wood painted BLACK F04 , Ash wood painted WHITE F05 , Ash wood painted BLUE F06 , Ash wood painted RED F08 , Ash wood painted CHERRY RED F09 , Ash wood painted FLAMED WALNUT F24 , Ash wood painted DARK BROWN F26 , Ash wood painted NATURAL F40 , Ash wood painted NATURAL OAK F52
------------	--

Insert finishes

Metal



MI	WHITE BB , BROWN E6 , SAND EC , GRAPHITE EG , BLACK EN
-----------	---

Shell finishes

Upholstery

TA	FAUX LEATHER Secret , FABRIC Mirage , FABRIC Cotton Club	TB	FAUX LEATHER Vintage , FABRIC Fenix Wool , FABRIC Novabuk , FABRIC Manhattan , FABRIC Visual
TC	VELVET SUPERB, FABRIC Second , FABRIC Main Line Flax , FABRIC Oceanic	TD	FABRIC Yoredale , FABRIC Remix 3
TE	FABRIC Uniform Melange	SF	LEATHER Fiore
SV	LEATHER Vintage		

COM/COL - Minimum Q.ty 6 pc. for each material. For weft or patterned fabrics see specific pages

 COM	Mtl. 0.60 h. 1.40 Each	 COL	Mq. 0.90 Each
---	------------------------	--	---------------

Optionals:

	Value	Options/notes
FM-M2	+ 45 €	ASH GREY ES , BRONZE E2 , BULGARO RED FP , CHERRY RED EQ , DARK GREEN EL , FACEPOWDER PINK E8 , FANGO E3 , GOLDEN YELLOW EO , LIGHT BLUE EO , LIGHT GREY ET , OCEAN BLUE EI , OCHER YELLOW E7 , PAPAYA ORANGE EA , PASTEL YELLOW E4 , PINE GREEN EJ , RED ER , SAGE GREEN E9
FM-M3	+ 20 €	CHROME CC
FM-M4	+ 103 €	BLACK NICKEL DZ , CHAMPAGNE GOLD DG , GOLDEN BRONZE DB , MATT BLACK NICKEL DY , MATT GOLDEN BRONZE DC , PINK GOLD DR
ES-1	+ 6 €	ES-1
PD-F0	+ 6 €	PD-F0

Liù H65

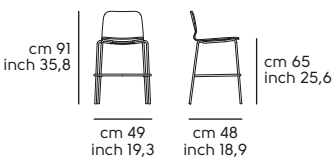

cm 91
inch 35,8

cm 65
inch 25,6

cm 49
inch 19,3

cm 48
inch 18,9

Liù H75

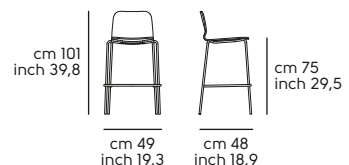

cm 101
inch 39,8

cm 75
inch 29,5

cm 49
inch 19,3

cm 48
inch 18,9

Liù ML H65

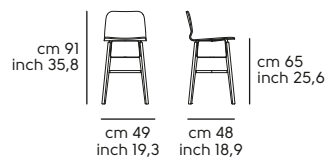

cm 91
inch 35,8

cm 65
inch 25,6

cm 49
inch 19,3

cm 48
inch 18,9

Liù ML H75

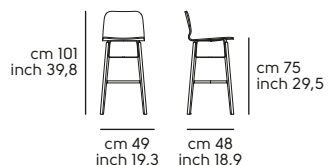

cm 101
inch 39,8

cm 75
inch 29,5

cm 49
inch 19,3

cm 48
inch 18,9

Liù LR H65

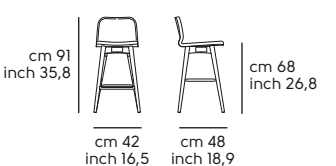

cm 91
inch 35,8

cm 68
inch 26,8

cm 42
inch 16,5

cm 48
inch 18,9

Liù LR H75

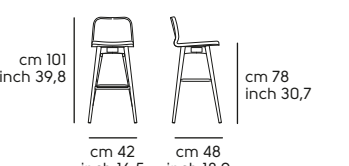

cm 101
inch 39,8

cm 78
inch 30,7

cm 42
inch 16,5

cm 48
inch 18,9

Liù SG

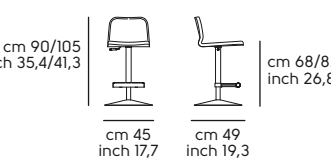

cm 90/105
inch 35,4/41,3











cm 68/82
inch 26,8/32,3

cm 45
inch 17,7

cm 49
inch 19,3

LIÙ H65-75-SG - Shell in fabric or leather with wrinkles and back in wood

Frame in: metal, metal-wood or wood

Model	Code	Mod.	Frame	Shell (Back Shell LI)									Optional	Q.ty	boxes	Kg	M ³
				TA	TB	TC	TD	TE	SF	SV	COM	COL					
Stool LIÙ H65 M TS2/L  	S1280HY	H65	M1	433 €	444 €	469 €	484 €	517 €	506 €	677 €	433 €	469 €	FM-M2 FM-M3 FM-M4 FL-I2 ES-1 PD-F0	2	1	14.0	0.28
Stool LIÙ H75 M TS2/L  	S1280JY	H75	M1	444 €	459 €	484 €	497 €	529 €	519 €	689 €	444 €	484 €	FM-M2 FM-M3 FM-M4 FL-I2 ES-1 PD-F0	2	1	16.0	0.33
Stool LIÙ H65 ML TS2/L 	S1285HY	ML H65	LF1-M1	579 €	591 €	616 €	631 €	664 €	653 €	835 €	579 €	616 €	FM-M2 FL-I2 ES-1 PD-F0	1	1	14.0	0.24
Stool LIÙ H75 ML TS2/L 	S1285JY	ML H75	LF1-M1	591 €	604 €	629 €	643 €	676 €	665 €	849 €	591 €	629 €	FM-M2 FL-I2 ES-1 PD-F0	1	1	16.0	0.31
Stool LIÙ H65 LR-TS2/L 	S1280HK	LR H65	LF1	543 €	554 €	580 €	605 €	627 €	616 €	788 €	543 €	580 €	FL-I2 ES-1 PD-F0	1	1	7.25	0.21
Stool LIÙ H75 LR-TS2/L 	S1280JK	LR H75	LF1	559 €	573 €	599 €	622 €	644 €	633 €	803 €	559 €	599 €	FL-I2 ES-1 PD-F0	1	1	7.55	0.24
Stool LIÙ SG TS2/L  	S1280ZV	SG	M1	664 €	676 €	701 €	715 €	749 €	737 €	908 €	664 €	701 €	FM-M2 FL-I2 ES-1	1	1	16.7	0.21

Frame finishes

Metal	
MI	WHITE BB , BROWN E6 , SAND EC , GRAPHITE EG , BLACK EN

Wood	
LFI	Ash wood painted GREY F02 , Ash wood painted GRAFITE GREY F03 , Ash wood painted BLACK F04 , Ash wood painted WHITE F05 , Ash wood painted BLUE F06 , Ash wood painted RED F08 , Ash wood painted CHERRY RED F09 , Ash wood painted FLAMED WALNUT F24 , Ash wood painted DARK BROWN F26 , Ash wood painted NATURAL F40 , Ash wood painted NATURAL OAK F52

Insert finishes

Metal	
MI	WHITE BB , BROWN E6 , SAND EC , GRAPHITE EG , BLACK EN

Backrest shell finishes



Wood	
LII	Veneered wood painted GREY I02 , Veneered wood painted GRAFITE GREY I03 , Veneered wood painted BLACK I04 , Veneered wood painted WHITE I05 , Veneered wood painted BLUE I06 , Veneered wood painted RED I08 , Veneered wood painted CHERRY RED I09 , Veneered wood painted DARK BROWN I26 , Veneered wood painted NATURAL I40 , Veneered wood painted NATURAL OAK I52

Shell finishes

Upholstery	
TA	FAUX LEATHER Secret , FABRIC Mirage , FABRIC Cotton Club
TC	VELVET SUPERB, FABRIC Second , FABRIC Main Line Flax , FABRIC Oceanic
TE	FABRIC Uniform Melange
SV	LEATHER Vintage

TB	FAUX LEATHER Vintage , FABRIC Fenix Wool , FABRIC Novabuk , FABRIC Manhattan , FABRIC Visual
TD	FABRIC Yoredale , FABRIC Remix 3
SF	LEATHER Fiore

COM/COL - Minimum Q.ty 6 pc. for each material. For weft or patterned fabrics see specific pages

 COM	Mtl. 0.45 h. 1.40 Each	 COL	Mq. 0.70 Each
---	------------------------	--	---------------

Optionals:

	Value	Options/notes
FM-M2	+ 45 €	ASH GREY ES , BRONZE E2 , BULGARO RED FP , CHERRY RED EQ , DARK GREEN EL , FACEPOWDER PINK E8 , FANGO E3 , GOLDEN YELLOW EO , LIGHT BLUE EO , LIGHT GREY ET , OCEAN BLUE EI , OCHER YELLOW E7 , PAPAYA ORANGE EA , PASTEL YELLOW E4 , PINE GREEN EJ , RED ER , SAGE GREEN E9
FM-M3	+ 20 €	CHROME CC
FM-M4	+ 103 €	BLACK NICKEL DZ , CHAMPAGNE GOLD DG , GOLDEN BRONZE DB , MATT BLACK NICKEL DY , MATT GOLDEN BRONZE DC , PINK GOLD DR
FL-I2	+ 15 €	Veneered wood FLAMED WALNUT I24 , Veneered wood NATURAL OAK I22
ES-1	+ 6 €	ES-1
PD-F0	+ 6 €	PD-F0

Liù H65

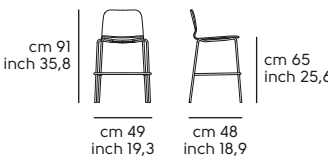

Liù H75

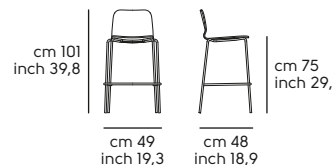

Liù ML H65

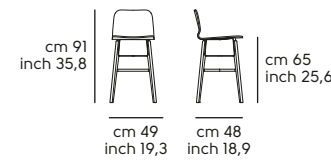

Liù ML H75

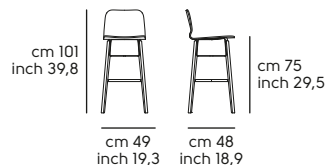

Liù LR H65

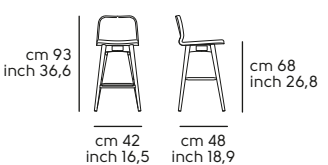

Liù LR H75

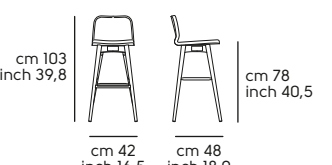

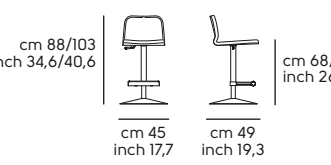

Liù SG



Liù AT - Wood shell

Frame in: metal or metal-wood

Model	Code	Mod.	Frame	Shell		Optional	Q.ty	boxes	Kg	M ³
				LI1	LI2					
 <p>Waiting Chair LIÙ AT ML LG</p>	S1280AL	AT	M1	384 €	411 €	FM-M2 PD-F0	1	1	8.0	0.31
 <p>Waiting Chair LIÙ AT ML LG</p>	S1285AL	ML AT	LF1-M1	512 €	539 €	FM-M2 PD-F0	1	1	8.0	0.31

Frame finishes

Metal

MI WHITE **BB**, BROWN **E6**, SAND **EC**, GRAPHITE **EG**, BLACK **EN**

Wood

LFI

Ash wood painted GREY **F02**, Ash wood painted GRAFITE GREY **F03**, Ash wood painted BLACK **F04**, Ash wood painted WHITE **F05**, Ash wood painted BLUE **F06**, Ash wood painted RED **F08**, Ash wood painted CHERRY RED **F09**, Ash wood painted FLAMED WALNUT **F24**, Ash wood painted DARK BROWN **F26**, Ash wood painted NATURAL **F40**, Ash wood painted NATURAL OAK **F52**

Insert finishes

Metal

MI WHITE **BB**, BROWN **E6**, SAND **EC**, GRAPHITE **EG**, BLACK **EN**

Shell finishes

Wood

LII

Veneered wood painted GREY **I02**, Veneered wood painted GRAFITE GREY **I03**, Veneered wood painted BLACK **I04**, Veneered wood painted WHITE **I05**, Veneered wood painted BLUE **I06**, Veneered wood painted RED **I08**, Veneered wood painted CHERRY RED **I09**, Veneered wood painted DARK BROWN **I26**, Veneered wood painted NATURAL **I40**, Veneered wood painted NATURAL OAK **I52**

LI2

Veneered wood NATURAL OAK **I22**, Veneered wood FLAMED WALNUT **I24**

Optionals:

	Value	Options/notes
FM-M2	Indoor matt metal M2 + 51 €	ASH GREY ES , BRONZE E2 , BULGARO RED FP , CHERRY RED EQ , DARK GREEN EL , FACEPOWDER PINK E8 , FANGO E3 , GOLDEN YELLOW EO , LIGHT BLUE EO , LIGHT GREY ET , OCEAN BLUE E1 , OCHER YELLOW E7 , PAPAYA ORANGE EA , PASTEL YELLOW E4 , PINE GREEN EJ , RED ER , SAGE GREEN E9
PD-F0	Felt pad feet + 6 €	PD-F0

Liù AT

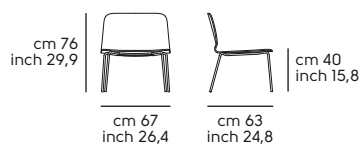

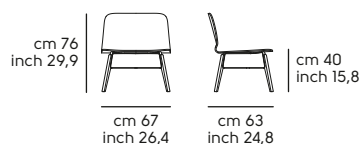

Liù ML AT



Liù AT - Shell in fabric or leather with wrinkles

Frame in: metal or metal-wood

Model	Code	Mod.	Frame	Shell									Optional	Q.ty	boxes	Kg	M³
				TA	TB	TC	TD	TE	SF	SV	COM	COL					
 Waiting Chair LIÙ AT M TS2	SI280AU	AT	MI	381 €	396 €	459 €	500 €	625 €	490 €	591 €	381 €	459 €	FM-M2 ES-1 PD-F0	1	1	8.0	0.35
 Waiting Chair LIÙ AT ML TS2	SI285AU	ML AT	LFI-MI	509 €	525 €	587 €	627 €	753 €	620 €	720 €	509 €	587 €	FM-M2 ES-1 PD-F0	1	1	8.0	0.35

Frame finishes

Metal

MI	WHITE BB , BROWN E6 , SAND EC , GRAPHITE EG , BLACK EN
-----------	---

Wood

LFI	Ash wood painted GREY F02 , Ash wood painted GRAFITE GREY F03 , Ash wood painted BLACK F04 , Ash wood painted WHITE F05 , Ash wood painted BLUE F06 , Ash wood painted RED F08 , Ash wood painted CHERRY RED F09 , Ash wood painted FLAMED WALNUT F24 , Ash wood painted DARK BROWN F26 , Ash wood painted NATURAL F40 , Ash wood painted NATURAL OAK F52
------------	--

Insert finishes

Metal

MI	WHITE BB , BROWN E6 , SAND EC , GRAPHITE EG , BLACK EN
-----------	---

Shell finishes

Upholstery

TA	FAUX LEATHER Secret , FABRIC Mirage , FABRIC Cotton Club	TB	FAUX LEATHER Vintage , FABRIC Fenix Wool , FABRIC Novabuk , FABRIC Manhattan , FABRIC Visual
TC	VELVET SUPERB, FABRIC Second , FABRIC Main Line Flax , FABRIC Oceanic	TD	FABRIC Yoredale , FABRIC Remix 3
TE	FABRIC Uniform Melange	SF	LEATHER Fiore
SV	LEATHER Vintage		

COM/COL - Minimum Q.ty 6 pc. for each material. For weft or patterned fabrics see specific pages

 COM	Mtl. 1.30 h. 1.40 Each	 COL	Mq. 1.60 Each
---	------------------------	--	---------------

Optionals:

	Value	Options/notes
FM-M2	+ 51 €	ASH GREY ES , BRONZE E2 , BULGARO RED FP , CHERRY RED EQ , DARK GREEN EL , FACEPOWDER PINK E8 , FANGO E3 , GOLDEN YELLOW EO , LIGHT BLUE EO , LIGHT GREY ET , OCEAN BLUE E1 , OCHER YELLOW E7 , PAPAYA ORANGE EA , PASTEL YELLOW E4 , PINE GREEN E3 , RED ER , SAGE GREEN E9
ES-1	+ 7 €	ES-1
PD-F0	+ 6 €	PD-F0

Liù AT

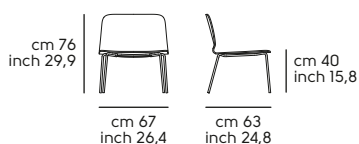

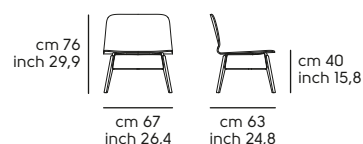

Liù ML AT



Liù AT - Shell in fabric or leather with wrinkles and back in wood

Frame in: metal or metal-wood

Model	Code	Mod.	Frame	Shell (Back Shell LII)									Optional	Q.ty	boxes	Kg	M³
				TA	TB	TC	TD	TE	SF	SV	COM	COL					
 Waiting Chair LIÙ AT M TS2/L	S1280AY	AT	M1	495 €	512 €	572 €	594 €	701 €	608 €	707 €	495 €	572 €	FM-M2 FL-I2 ES-1 PD-F0	1	1	8.0	0.35
 Waiting Chair LIÙ AT ML TS2/L	S1285AY	ML AT	LF1-M1	624 €	642 €	702 €	723 €	831 €	736 €	836 €	624 €	702 €	FM-M2 FL-I2 ES-1 PD-F0	1	1	8.0	0.35

Frame finishes

Metal

MI	WHITE BB , BROWN E6 , SAND EC , GRAPHITE EG , BLACK EN
-----------	---

Wood

LFI	Ash wood painted GREY F02 , Ash wood painted GRAFITE GREY F03 , Ash wood painted BLACK F04 , Ash wood painted WHITE F05 , Ash wood painted BLUE F06 , Ash wood painted RED F08 , Ash wood painted CHERRY RED F09 , Ash wood painted FLAMED WALNUT F24 , Ash wood painted DARK BROWN F26 , Ash wood painted NATURAL F40 , Ash wood painted NATURAL OAK F52
------------	--

Insert finishes

Metal

MI	WHITE BB , BROWN E6 , SAND EC , GRAPHITE EG , BLACK EN
-----------	---

Backrest shell finishes

Wood

LII	Veneered wood painted GREY I02 , Veneered wood painted GRAFITE GREY I03 , Veneered wood painted BLACK I04 , Veneered wood painted WHITE I05 , Veneered wood painted BLUE I06 , Veneered wood painted RED I08 , Veneered wood painted CHERRY RED I09 , Veneered wood painted DARK BROWN I26 , Veneered wood painted NATURAL I40 , Veneered wood painted NATURAL OAK I52
------------	--

Shell finishes

Upholstery

TA	FAUX LEATHER Secret , FABRIC Mirage , FABRIC Cotton Club	TB	FAUX LEATHER Vintage , FABRIC Fenix Wool , FABRIC Novabuk , FABRIC Manhattan , FABRIC Visual
TC	VELVET SUPERB, FABRIC Second , FABRIC Main Line Flax , FABRIC Oceanic	TD	FABRIC Yoredale , FABRIC Remix 3
TE	FABRIC Uniform Melange	SF	LEATHER Fiore
SV	LEATHER Vintage		

COM/COL - Minimum Q.ty 6 pc. for each material. For weft or patterned fabrics see specific pages

COM	Mtl. 1.10 h. 1.40 Each	COL	Mq. 1.20 Each
------------	------------------------	------------	---------------

Optionals:

	Value	Options/notes
FM-M2	+ 51 €	ASH GREY ES , BRONZE E2 , BULGARO RED FP , CHERRY RED EQ , DARK GREEN EL , FACEPOWDER PINK E8 , FANGO E3 , GOLDEN YELLOW EO , LIGHT BLUE EO , LIGHT GREY ET , OCEAN BLUE E1 , OCHER YELLOW E7 , PAPAYA ORANGE EA , PASTEL YELLOW E4 , PINE GREEN EJ , RED ER , SAGE GREEN E9
FL-I2	+ 20 €	Veneered wood FLAMED WALNUT I24 , Veneered wood NATURAL OAK I22
ES-1	+ 7 €	ES-1
PD-F0	+ 6 €	PD-F0

Liù AT

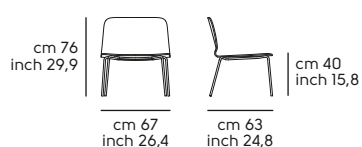

Liù ML AT

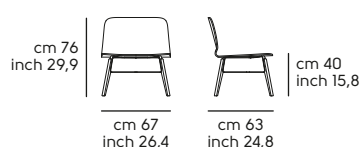



Maya design Balutto Associati

Maya S, H65-75 - Seat in wood, fabric or leather

Frame in: wood

Model	Code	Mod.	Frame and Backrest	Seat									Optional	Q.ty	boxes	Kg	M ³
LFI																	
Chair MAYA S L LG 	S1860SW	S	LFI	326 €									PD-FO	2	1	12.0	0.28

Model	Code	Mod.	Frame and Backrest	TA	TB	TC	TD	TE	SF	SV	COM	COL	Optional	Q.ty	boxes	Kg	M ³
Chair MAYA S L TS 	S1860ST	S	LFI	301 €	326 €	349 €	361 €	438 €	361 €	421 €	301 €	349 €	ES-1 PD-FO	2	1	12.0	0.28

Model	Code	Mod.	Frame and Backrest	Seat									Optional	Q.ty	boxes	Kg	M ³
LFI																	
Stool MAYA H65 L LG 	S1860HW	H65	LFI	412 €									PD-FO	1	1	6.5	0.31
Stool MAYA H75 L LG  <small>CATAS EN 1728</small>	S1860JW	H75	LFI	423 €									PD-FO	1	1	7.5	0.34

Model	Code	Mod.	Frame and Backrest	TA	TB	TC	TD	TE	SF	SV	COM	COL	Optional	Q.ty	boxes	Kg	M ³
Stool MAYA H65 L TS 	S1860HT	H65	LFI	400 €	424 €	447 €	461 €	537 €	461 €	521 €	400 €	447 €	ES-1 PD-FO	1	1	6.5	0.31
Stool MAYA H75 L TS  <small>CATAS EN 1728</small>	S1860JT	H75	LFI	414 €	438 €	461 €	475 €	550 €	475 €	533 €	414 €	461 €	ES-1 PD-FO	1	1	7.5	0.34

Frame and Back finishes

Wood

LFI	Ash wood painted GREY F02 , Ash wood painted GRAFITE GREY F03 , Ash wood painted BLACK F04 , Ash wood painted WHITE F05 , Ash wood painted BLUE F06 , Ash wood painted RED F08 , Ash wood painted CHERRY RED F09 , Ash wood painted FLAMED WALNUT F24 , Ash wood painted DARK BROWN F26 , Ash wood painted NATURAL F40 , Ash wood painted NATURAL OAK F52
------------	--

Seat finishes

Wood

LFI	Ash wood painted GREY F02 , Ash wood painted GRAFITE GREY F03 , Ash wood painted BLACK F04 , Ash wood painted WHITE F05 , Ash wood painted BLUE F06 , Ash wood painted RED F08 , Ash wood painted CHERRY RED F09 , Ash wood painted FLAMED WALNUT F24 , Ash wood painted DARK BROWN F26 , Ash wood painted NATURAL F40 , Ash wood painted NATURAL OAK F52
------------	--

Upholstery

TA	FAUX LEATHER Secret , FABRIC Mirage , FABRIC Cotton Club
TB	FAUX LEATHER Vintage , FABRIC Fenix Wool , FABRIC Novabuk , FABRIC Manhattan , FABRIC Visual
TC	VELVET SUPERB, FABRIC Second , FABRIC Main Line Flax , FABRIC Oceanic

Shell finishes

Upholstery



TD	FABRIC Yoredale , FABRIC Remix 3	TE	FABRIC Uniform Melange
-----------	--	-----------	-------------------------------

Seat finishes

Upholstery

SF	LEATHER Fiore
SV	LEATHER Vintage

COM/COL - Minimum Q.ty 6 pc. for each material. For weft or patterned fabrics see specific pages

COM 	Mtl. 0.55 h. 1.40 Each	COL 	Mq. 0.68 Each
---	------------------------	---	---------------

Optionals:

		Value	Options/notes
ES-1	Fireproof foam	+ 6 €	ES-1
PD-F0	Felt pad feet	+ 6 €	PD-F0

Maya S

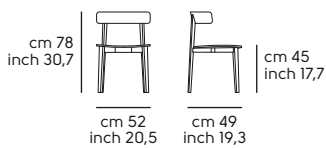

Maya H65

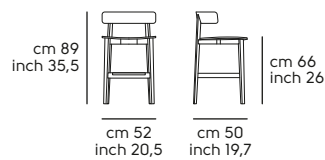



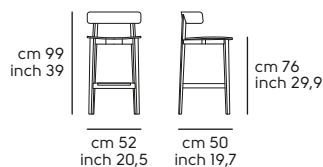



Maya H75





Master design Paolo Vernier

Master S, H65-75 - Seat and back in hide, fabric or leather, wood

Frame in: metal

Model	Code	Mod.	Frame	Seat and Backrest								Optional	Q.ty	boxes	Kg	M ³	
				CU				CT									
Chair MASTER S M CU 																	
	S1710SC	S	MI	437 €				525 €				FM-M2 FM-M4 ES-1	2	1	14.0	0.19	
Chair MASTER S M TS 				TA	TB	TC	TD	TE	SF	SV	COM	COL					
	S1710ST	S	MI	274 €	295 €	320 €	336 €	379 €	370 €	405 €	274 €	320 €	FM-M2 FM-M4 ES-1	2	1	14.0	0.28
Chair MASTER S M LG 				HF1			LI1			LI2							
	S1710SW	S	MI	333 €			347 €			359 €			FM-M2 FM-M4	2	1	14.0	0.26
Stool MASTER H65 M CU 				CU				CT									
	S1710HC	H65	MI	504 €				592 €				FM-M2 FM-M4 ES-1	1	1	9.0	0.24	
Stool MASTER H75 M CU 				CU				CT									
	S1710JC	H75	MI	517 €				605 €				FM-M2 FM-M4 ES-1	1	1	9.5	0.25	
Stool MASTER H65 M TS 				TA	TB	TC	TD	TE	SF	SV	COM	COL					
	S1710HT	H65	MI	342 €	362 €	387 €	403 €	446 €	437 €	473 €	342 €	387 €	FM-M2 FM-M4 ES-1	1	1	9.0	0.24
Stool MASTER H75 M TS 				TA	TB	TC	TD	TE	SF	SV	COM	COL					
	S1710JT	H75	MI	354 €	375 €	399 €	416 €	459 €	448 €	485 €	354 €	399 €	FM-M2 FM-M4 ES-1	1	1	9.5	0.25

				HF1	LI1	LI2					
Stool MASTER H65 M LG 	S1710HW	H65	M1	393 €	408 €	420 €	FM-M2 FM-M4	1	1	9.0	0.22
	Stool MASTER H75 M LG 	S1710JW	H75	M1	405 €	421 €	434 €	FM-M2 FM-M4	1	1	9.5

Frame finishes

Metal

M1 WHITE **BB**, BROWN **E6**, SAND **EC**, GRAPHITE **EG**, BLACK **EN**

Seat and Back finishes

Laminate

HF1 Fenix BLACK **FX4**, Fenix WHITE **FX5**

Wood

LI1 Veneered wood painted GREY **I02**, Veneered wood painted GRAFITE GREY **I03**, Veneered wood painted BLACK **I04**, Veneered wood painted WHITE **I05**, Veneered wood painted BLUE **I06**, Veneered wood painted RED **I08**, Veneered wood painted CHERRY RED **I09**, Veneered wood painted DARK BROWN **I26**, Veneered wood painted NATURAL **I40**, Veneered wood painted NATURAL OAK **I52**

LI2 Veneered wood NATURAL OAK **I22**, Veneered wood FLAMED WALNUT **I24**

Seat and Back finishes

Upholstery

TA FAUX LEATHER **Secret**, FABRIC **Mirage**, FABRIC **Cotton Club**

TC VELVET SUPERB, FABRIC **Second**, FABRIC **Main Line Flax**, FABRIC **Oceanic**

TE FABRIC **Uniform Melange**

SV LEATHER **Vintage**

CT TUSCAN HIDE

TB FAUX LEATHER **Vintage**, FABRIC **Fenix Wool**, FABRIC **Novabuk**, FABRIC **Manhattan**, FABRIC **Visual**

TD FABRIC **Yoredale**, FABRIC **Remix 3**

SF LEATHER **Fiore**

CU HIDE

COM/COL - Minimum Q.ty 6 pc. for each material. For weft or patterned fabrics see specific pages

COM Mtl. 0.50 h. 1.40 Each

COL Mq. 1.24 Each

Optionals:

		Value	Options/notes
FM-M2	Indoor matt metal M2	+ 49 €	ASH GREY ES , BRONZE E2 , BULGARO RED FP , CHERRY RED EQ , DARK GREEN EL , FACEPOWDER PINK E8 , FANGO E3 , GOLDEN YELLOW EO , LIGHT BLUE EO , LIGHT GREY ET , OCEAN BLUE E1 , OCHER YELLOW E7 , PAPAYA ORANGE EA , PASTEL YELLOW E4 , PINE GREEN EJ , RED ER , SAGE GREEN E9
FM-M4	Indoor glossy Metal M4	+ 132 €	BLACK NICKEL DZ , CHAMPAGNE GOLD DG , GOLDEN BRONZE DB , MATT BLACK NICKEL DY , MATT GOLDEN BRONZE DC , PINK GOLD DR
ES-1	Fireproof foam	+ 6 €	ES-1

Master S

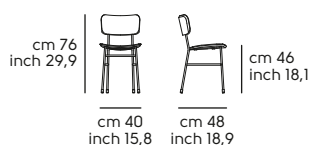

Master H65

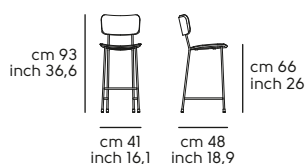

Master H75

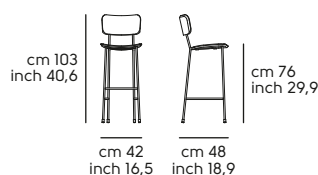

Mia design Beatriz Sempere

Mia S - Shell in hide

Frame in: metal

Model	Code	Mod.	Frame	Shell		Optional	Q.ty	boxes	Kg	M ³
				CU	CT					
Chair MIA S M CU										
	S2000S0	S	MI	500 €	669 €	FM-M2 FM-M4 PD-F0	1 2	1 1	8.0 15.0	0.36 0.49

Frame finishes

Metal

MI WHITE **BB**, INDUSTRIAL **E5**, BROWN **E6**, SAND **EC**, GRAPHITE **EG**, BLACK **EN**

Shell finishes

Upholstery

CU HIDE

CT TUSCAN HIDE

Optionals:

		Value	Options/notes
FM-M2	Indoor matt metal M2	+ 51 €	ASH GREY ES , BRONZE E2 , BULGARO RED FP , CHERRY RED EQ , DARK GREEN EL , FACEPOWDER PINK E8 , FANGO E3 , GOLDEN YELLOW EO , LIGHT BLUE E0 , LIGHT GREY ET , OCEAN BLUE E1 , OCHER YELLOW E7 , PAPAYA ORANGE EA , PASTEL YELLOW E4 , PINE GREEN EJ , RED ER , SAGE GREEN E9
FM-M4	Indoor glossy Metal M4	+ 103 €	BLACK NICKEL DZ , CHAMPAGNE GOLD DG , GOLDEN BRONZE DB , MATT BLACK NICKEL DY , MATT GOLDEN BRONZE DC , PINK GOLD DR
PD-F0	Felt pad feet	+ 6 €	PD-F0

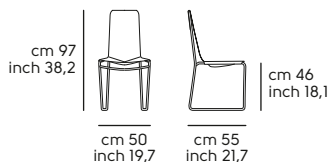

Mia S





Mito design Midj R&D

Mito S, P - Seat in fabric or leather or wood, Back in wood

Frame in: metal

Model	Code	Mod.	Frame	Seat (Back LII)									Optional	Q.ty	boxes	Kg	M ²
				TA	TB	TC	TD	TE	SF	SV	COM	COL					
 	S1870SD	S	MI	260 €	267 €	280 €	292 €	327 €	296 €	326 €	260 €	280 €	FM-M2 FL-I2 PD-F0	2 4	1 1	12.0 25.0	0.23 0.32

Model	Code	Mod.	Frame	Seat and Backrest		Optional	Q.ty	boxes	Kg	M ²
				LII	LI2					
 	S1870SW	S	MI	273 €	286 €	FM-M2 PD-F0	2 4	1 1	12.0 25.0	0.23 0.32

Frame finishes

Metal

MI WHITE **BB**, BROWN **E6**, SAND **EC**, GRAPHITE **EG**, BLACK **EN**

Back finishes

Wood

LII Veneered wood painted GREY **I02**, Veneered wood painted GRAFITE GREY **I03**, Veneered wood painted BLACK **I04**, Veneered wood painted WHITE **I05**, Veneered wood painted BLUE **I06**, Veneered wood painted RED **I08**, Veneered wood painted CHERRY RED **I09**, Veneered wood painted DARK BROWN **I26**, Veneered wood painted NATURAL **I40**, Veneered wood painted NATURAL OAK **I52**

Seat and Back finishes

Wood

LII Veneered wood painted GREY **I02**, Veneered wood painted GRAFITE GREY **I03**, Veneered wood painted BLACK **I04**, Veneered wood painted WHITE **I05**, Veneered wood painted BLUE **I06**, Veneered wood painted RED **I08**, Veneered wood painted CHERRY RED **I09**, Veneered wood painted DARK BROWN **I26**, Veneered wood painted NATURAL **I40**, Veneered wood painted NATURAL OAK **I52**

LI2 Veneered wood NATURAL OAK **I22**, Veneered wood FLAMED WALNUT **I24**

Seat finishes

Upholstery

TA FAUX LEATHER **Secret**, FABRIC **Mirage**, FABRIC **Cotton Club**

TC VELVET SUPERB, FABRIC **Second**, FABRIC **Main Line Flax**, FABRIC **Oceanic**

TE FABRIC **Uniform Melange**

SV LEATHER **Vintage**

TB FAUX LEATHER **Vintage**, FABRIC **Fenix Wool**, FABRIC **Novabuk**, FABRIC **Manhattan**, FABRIC **Visual**

TD FABRIC **Yoredale**, FABRIC **Remix 3**

SF LEATHER **Fiore**

COM/COL - Minimum Q.ty 6 pc. for each material. For weft or patterned fabrics see specific pages

COM Mtl. 0.35 h. 1.40 Each

COL Mq. 0.68 Each



Optionals:		Value	Options/notes
FM-M2	Indoor matt metal M2	+ 45 €	ASH GREY ES , BRONZE E2 , BULGARO RED FP , CHERRY RED EG , DARK GREEN EL , FACEPOWDER PINK E8 , FANGO E3 , GOLDEN YELLOW EO , LIGHT BLUE EO , LIGHT GREY ET , OCEAN BLUE EI , OCHER YELLOW E7 , PAPAYA ORANGE EA , PASTEL YELLOW E4 , PINE GREEN EJ , RED ER , SAGE GREEN E9
FL-I2	Veneered wood finish LI2	+ 8 €	Veneered wood FLAMED WALNUT I24 , Veneered wood NATURAL OAK I22
PD-F0	Felt pad feet	+ 6 €	PD-F0

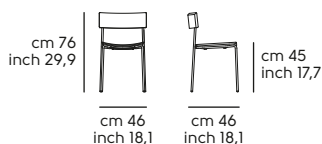

Mito S



Mito H65-75 - Seat in fabric or leather or wood, Back in wood

Frame in: metal

Model	Code	Mod.	Frame	Seat (Back LI)									Optional	Q.ty	boxes	Kg	M ³
				TA	TB	TC	TD	TE	SF	SV	COM	COL					
Stool MITO H65 MTS-LG 	S1870HD	H65	MI	320 €	329 €	343 €	352 €	386 €	358 €	387 €	320 €	343 €	FM-M2 FL-I2 PD-F0	1 2	1 1	7.7 15.4	0.28 0.31
Stool MITO H75 MTS-LG 	S1870JD	H75	MI	334 €	342 €	356 €	366 €	400 €	371 €	400 €	334 €	356 €	FM-M2 FL-I2 PD-F0	1 2	1 1	8.0 16.0	0.3 0.34

Model	Code	Mod.	Frame	Seat and Backrest		Optional	Q.ty	boxes	Kg	M ³
				LI1	LI2					
Stool MITO H65 M LG 	S1870HW	H65	MI	333 €	345 €	FM-M2 PD-F0	1 2	1 1	7.7 15.4	0.28 0.31
Stool MITO H75 M LG 	S1870JW	H75	MI	348 €	359 €	FM-M2 PD-F0	1 2	1 1	8.0 16.0	0.3 0.34

Frame finishes

Metal

MI	WHITE BB , BROWN E6 , SAND EC , GRAPHITE EG , BLACK EN
-----------	---

Back finishes

Wood

LII	Veneered wood painted GREY I02 , Veneered wood painted GRAFITE GREY I03 , Veneered wood painted BLACK I04 , Veneered wood painted WHITE I05 , Veneered wood painted BLUE I06 , Veneered wood painted RED I08 , Veneered wood painted CHERRY RED I09 , Veneered wood painted DARK BROWN I26 , Veneered wood painted NATURAL I40 , Veneered wood painted NATURAL OAK I52
------------	--

Seat and Back finishes

Wood



LII	Veneered wood painted GREY I02 , Veneered wood painted GRAFITE GREY I03 , Veneered wood painted BLACK I04 , Veneered wood painted WHITE I05 , Veneered wood painted BLUE I06 , Veneered wood painted RED I08 , Veneered wood painted CHERRY RED I09 , Veneered wood painted DARK BROWN I26 , Veneered wood painted NATURAL I40 , Veneered wood painted NATURAL OAK I52	L12	Veneered wood NATURAL OAK I22 , Veneered wood FLAMED WALNUT I24
------------	--	------------	---

Seat finishes

Upholstery

TA	FAUX LEATHER Secret , FABRIC Mirage , FABRIC Cotton Club	TB	FAUX LEATHER Vintage , FABRIC Fenix Wool , FABRIC Novabuk , FABRIC Manhattan , FABRIC Visual
TC	VELVET SUPERB, FABRIC Second , FABRIC Main Line Flax , FABRIC Oceanic	TD	FABRIC Yoredale , FABRIC Remix 3
TE	FABRIC Uniform Melange	SF	LEATHER Fiore
SV	LEATHER Vintage		

COM/COL - Minimum Q.ty 6 pc. for each material. For weft or patterned fabrics see specific pages

	Mtl. 0.35 h. 1.40 Each		Mq. 0.68 Each
---	------------------------	---	---------------

Optionals:

		Value	Options/notes
FM-M2	Indoor matt metal M2	+ 45 €	ASH GREY ES , BRONZE E2 , BULGARO RED FP , CHERRY RED EQ , DARK GREEN EL , FACEPOWDER PINK E8 , FANGO E3 , GOLDEN YELLOW EO , LIGHT BLUE EO , LIGHT GREY ET , OCEAN BLUE E1 , OCHER YELLOW E7 , PAPAYA ORANGE EA , PASTEL YELLOW E4 , PINE GREEN EJ , RED ER , SAGE GREEN E9
FL-I2	Veneered wood finish L12	+ 13 €	Veneered wood FLAMED WALNUT I24 , Veneered wood NATURAL OAK I22
PD-F0	Felt pad feet	+ 6 €	PD-F0

Mito H65

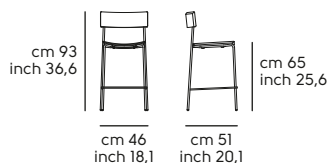



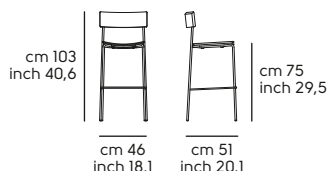



Mito H75



Montera design Ateliernanni







Montera S - Seat in hide, fabric or leather, wood

Frame in: wood

Model	Code	Mod.	Frame and Backrest	Seat										Optional	Q.ty	boxes	Kg	M ³	
				CU					CT										
 Chair MONTERA S L CU 	S1720SC	S	LFI	405 €					459 €					ES-1 PD-F0	2	1	12.0	0.45	
				TA	TB	TC	TD	TE	SF	SV	COM	COL							
 Chair MONTERA S L TS 	S1720ST	S	LFI	383 €	396 €	412 €	434 €	487 €	425 €	450 €	383 €	412 €	ES-1 PD-F0	2	1	12.0	0.45		
				TA	TB	TC	TD	TE	SF	SV	COM	COL							
 Chair MONTERA S L LG 	S1720SW	S	LFI	LFI										384 €	PD-F0	2	1	12.0	0.45
				TA	TB	TC	TD	TE	SF	SV	COM	COL							

Montera H65-75 - Seat in hide, fabric or leather, wood

Frame in: wood

Model	Code	Mod.	Frame and Backrest	Seat										Optional	Q.ty	boxes	Kg	M ³
				CU					CT									
Stool MONTERA H65 L CU 	S1720HC	H65	LF1	495 €					572 €					ES-1 PD-F0	1	1	9.0	0.29
Stool MONTERA H75 L CU 	S1720JC	H75	LF1	512 €					590 €					ES-1 PD-F0	1	1	9.0	0.33
				TA	TB	TC	TD	TE	SF	SV	COM	COL						
Stool MONTERA H65 L TS 	S1720HT	H65	LF1	459 €	466 €	491 €	508 €	563 €	509 €	544 €	459 €	491 €	ES-1 PD-F0	1	1	9.0	0.29	
Stool MONTERA H75 L TS 	S1720JT	H75	LF1	473 €	484 €	509 €	523 €	576 €	525 €	561 €	473 €	509 €	ES-1 PD-F0	1	1	9.0	0.33	
				LF1														
Stool MONTERA H65 L LG 	S1720HW	H65	LF1	463 €										PD-F0	1	1	9.0	0.29
Stool MONTERA H75 L LG 	S1720JW	H75	LF1	482 €										PD-F0	1	1	9.0	0.33

Frame and Back finishes

Wood

LFI	Ash wood painted GREY F02 , Ash wood painted GRAFITE GREY F03 , Ash wood painted BLACK F04 , Ash wood painted WHITE F05 , Ash wood painted BLUE F06 , Ash wood painted RED F08 , Ash wood painted CHERRY RED F09 , Ash wood painted FLAMED WALNUT F24 , Ash wood painted DARK BROWN F26 , Ash wood painted NATURAL F40 , Ash wood painted NATURAL OAK F52
------------	--

Seat finishes

Wood



LFI	Ash wood painted GREY F02 , Ash wood painted GRAFITE GREY F03 , Ash wood painted BLACK F04 , Ash wood painted WHITE F05 , Ash wood painted BLUE F06 , Ash wood painted RED F08 , Ash wood painted CHERRY RED F09 , Ash wood painted FLAMED WALNUT F24 , Ash wood painted DARK BROWN F26 , Ash wood painted NATURAL F40 , Ash wood painted NATURAL OAK F52
------------	--

Seat finishes

Upholstery

TA	FAUX LEATHER Secret , FABRIC Mirage , FABRIC Cotton Club	TB	FAUX LEATHER Vintage , FABRIC Fenix Wool , FABRIC Novabuk , FABRIC Manhattan , FABRIC Visual
TC	VELVET SUPERB, FABRIC Second , FABRIC Main Line Flax , FABRIC Oceanic	TD	FABRIC Yoredale , FABRIC Remix 3
TE	FABRIC Uniform Melange	SF	LEATHER Fiore
SV	LEATHER Vintage	CU	HIDE
CT	TUSCAN HIDE		

COM/COL - Minimum Q.ty 6 pc. for each material. For weft or patterned fabrics see specific pages

 COM	Mtl. 0.55 h. 1.40 Each	 COL	Mq. 0.68 Each
---	------------------------	--	---------------

Optionals:

		Value	Options/notes
ES-1	Fireproof foam	+ 6 €	ES-1
PD-F0	Felt pad feet	+ 6 €	PD-F0

Montera S

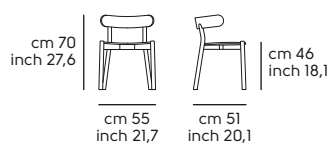

Montera H65

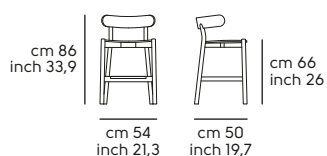

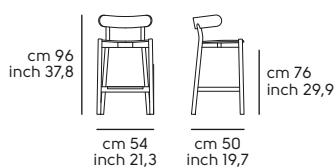

Montera H75



Nenè design Paolo Vernier



Nenè S PP - Polypropylene

Frame in: polypropylene

Model	Code	Mod.	Frame	Frame	Optional	Q.ty	boxes	Kg	M ³
					PP1				
 Chair NENÈ S PP 	S1370S0	S	PP1	108 €	PD-F0	4	1	15.5	0.4



Nenè S LG - Wood



Frame in: wood

Model	Code	Mod.	Frame	Frame	Optional	Q.ty	boxes	Kg	M ³
					LF1				
 Chair NENÈ S L 	S1370WL	S	LF1	649 €	PD-F0	2	1	10.0	0.23

Nenè S - Seat and Back in hide, fabric or leather

Frame : polypropylene

Model	Code	Mod.	Frame	Seat and Backrest	Optional	Q.ty	boxes	Kg	M ³
					CU				
 Chair NENÈ S PP-CU 	S1370SC	S	PP1	242 €	PD-F0	4	1	15.5	0.4





Model	Code	Mod.	Frame	Seat and Backrest	Optional	Q.ty	boxes	Kg	M ³
				TA TB TC TD TE SF SV COM COL					
 Chair NENÈ S PP-TS 	S1370ST	S	PP1	219 € 229 € 251 € 268 € 321 € 261 € 299 € 219 € 251 €	ES-1 PD-F0	4	1	18.0	0.4

COM/COL - Minimum Q.ty 6 pc. for each material. For weft or patterned fabrics see specific pages



 Mtl. 0.60 h. 1.40 Each	 Mq. 0.97 Each
--	---

Nenè S - Completely upholstered

Frame : polypropylene

Model	Code	Mod.	--	Upholstery									Optional	Q.ty 	boxes 	Kg 	M³
				TA	TB	TC	TD	TE	SF	SV	COM	COL					
 Chair NENÈ S R_TS-SF 	S1370T5	S		302 €	330 €	384 €	399 €	498 €	472 €	547 €	302 €	384 €	ES-1 PD-FO	4	1	18.0	0.4
 Chair NENÈ S R_TS-CF 	S1370T0	S		326 €	357 €	419 €	439 €	532 €	495 €	571 €	326 €	419 €	ES-1 PD-FO	4	1	18.0	0.4

COM/COL - Minimum Q.ty 6 pc. for each material. For weft or patterned fabrics see specific pages

 COM	Mtl. 1.15 h. 1.40 Each	 COL	Mq. 1.95 Each
---	------------------------	--	---------------

Frame finishes

Polypropylene

PP1	WHITE PB4 , GRAFITE GREY PGD , SKY GREY PGU , BROWN PM2 , BLACK PN4 , OCHER YELLOW PO2 , RED PRR , RED BULGARO PRS , SAND PS2 , TERRACOTTA PT2 , DARK GREEN PVL
------------	--

Wood

LFI	Ash wood painted NATURAL F40 , Ash wood painted NATURAL OAK F52 , Ash wood painted DARK BROWN F26 , Ash wood painted FLAMED WALNUT F24 , Ash wood painted WHITE F05 , Ash wood painted BLACK F04 , Ash wood painted RED F08 , Ash wood painted CHERRY RED F09 , Ash wood painted BLUE F06 , Ash wood painted GREY F02 , Ash wood painted GRAFITE GREY F03
------------	--

Seat and Back finishes

Upholstery

TA	FAUX LEATHER Secret , FABRIC Mirage , FABRIC Cotton Club	TB	FAUX LEATHER Vintage , FABRIC Fenix Wool , FABRIC Novabuk , FABRIC Manhattan , FABRIC Visual
TC	VELVET SUPERB, FABRIC Second , FABRIC Main Line Flax , FABRIC Oceanic	TD	FABRIC Yoredale , FABRIC Remix 3
TE	FABRIC Uniform Melange	SF	LEATHER Fiore
SV	LEATHER Vintage	CU	HIDE

Optionals:

		Value	Options/notes
ES-1	Fireproof foam	+ 6 €	ES-1
PD-FO	Felt pad feet	+ 6 €	PD-FO

Nenè S

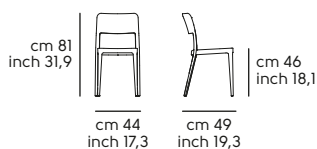

Nenè P - Seat and back in polypropylene, fabric or leather

Frame : polypropylene

Model	Code	Mod.	Frame	Frame	Optional	Q.ty	boxes	Kg	M ³
					PP1				
Armch. NENÈ P PP 	S1370P0	P	PP1	125 €	PD-F0	4	1	18.0	0.4

Model	Code	Mod.	Frame	Seat and Backrest								Optional	Q.ty	boxes	Kg	M ³	
				TA	TB	TC	TD	TE	SF	SV	COM	COL					
Armch. NENÈ P PP-TS 	S1370PT	P	PP1	237 €	249 €	267 €	286 €	339 €	280 €	320 €	237 €	267 €	ES-1 PD-F0	4	1	18.0	0.4

Frame finishes

Polypropylene



PP1	WHITE PB4 , GRAFITE GREY PGD , SKY GREY PGU , BROWN PM2 , BLACK PN4 , OCHER YELLOW PO2 , RED PRR , RED BULGARO PRS , SAND PS2 , TERRACOTTA PT2 , DARK GREEN PVL
------------	--

Seat and Back finishes

Upholstery

TA	FAUX LEATHER Secret , FABRIC Mirage , FABRIC Cotton Club	TB	FAUX LEATHER Vintage , FABRIC Fenix Wool , FABRIC Novabuk , FABRIC Manhattan , FABRIC Visual
TC	VELVET SUPERB, FABRIC Second , FABRIC Main Line Flax , FABRIC Oceanic	TD	FABRIC Yoredale , FABRIC Remix 3
TE	FABRIC Uniform Melange	SF	LEATHER Fiore
SV	LEATHER Vintage		

COM/COL - Minimum Q.ty 6 pc. for each material. For weft or patterned fabrics see specific pages

COM 	Mtl. 0.60 h. 1.40 Each	COL 	Mq. 0.97 Each
---	------------------------	---	---------------

Optionals:



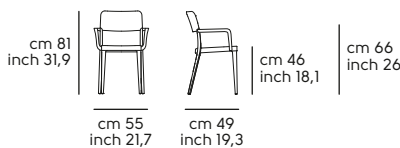

	Value	Options/notes
ES-1	+ 6 €	ES-1
PD-F0	+ 6 €	PD-F0



Nenè P



Nenè H65-H75 - Seat and back in polypropylene, fabric or leather

Frame : polypropylene

Model	Code	Mod.	Frame	Frame									Optional	Q.ty	boxes	Kg	M³
				PP1													
  Stool NENÈ H65 PP	S1370H0	H65	PP1	142 €									PD-FO	4	1	17.4	0.32
  Stool NENÈ H75 PP	S1370J0	H75	PP1	147 €									PD-FO	4	1	18.0	0.37

Model	Code	Mod.	Frame	Seat and Backrest									Optional	Q.ty	boxes	Kg	M³
				TA	TB	TC	TD	TE	SF	SV	COM	COL					
 Stool NENÈ H65 PP-TS	S1370HT	H65	PP1	246 €	258 €	276 €	295 €	348 €	289 €	329 €	246 €	276 €	ES-1 PD-FO	4	1	17.4	0.32
 Stool NENÈ H75 PP-TS	S1370JT	H75	PP1	251 €	263 €	281 €	300 €	353 €	294 €	334 €	251 €	281 €	ES-1 PD-FO	4	1	18.0	0.37

Frame finishes

Polypropylene



PPI	WHITE PB4 , GRAFITE GREY PGD , SKY GREY PGU , BROWN PM2 , BLACK PN4 , OCHER YELLOW PO2 , RED PRR , RED BULGARO PRS , SAND PS2 , TERRACOTTA PT2 , DARK GREEN PVL
------------	--

Seat and Back finishes

Upholstery

TA	FAUX LEATHER Secret , FABRIC Mirage , FABRIC Cotton Club	TB	FAUX LEATHER Vintage , FABRIC Fenix Wool , FABRIC Novabuk , FABRIC Manhattan , FABRIC Visual
TC	VELVET SUPERB, FABRIC Second , FABRIC Main Line Flax , FABRIC Oceanic	TD	FABRIC Yoredale , FABRIC Remix 3
TE	FABRIC Uniform Melange	SF	LEATHER Fiore
SV	LEATHER Vintage		

COM/COL - Minimum Q.ty 6 pc. for each material. For weft or patterned fabrics see specific pages

COM 	Mtl. 0.46 h. 1.40 Each	COL 	Mq. 0.84 Each
---	------------------------	---	---------------

Optionals:

		Value	Options/notes
ES-1	Fireproof foam	+ 6 €	ES-1
PD-F0	Felt pad feet	+ 6 €	PD-F0

Nenè H65

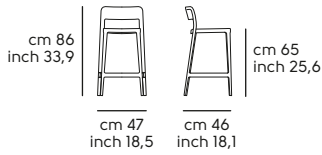

Nenè H75

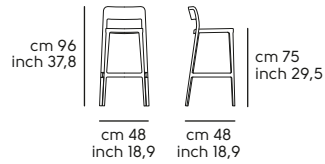

Nuvola design Midj R&D

Nuvola SB, SBR; SA, SAR - Shell in hide, fabric or leather

Frame in: metal or upholstered

Model	Code	Mod.	Frame	Seat and Backrest									Optional	Q.ty	boxes	Kg	M ³
CU																	
	S1390MC	SB	MI	405 €									ES-1	2	1	15.5	0.32

Model	Code	Mod.	Frame	TA	TB	TC	TD	TE	SF	SV	COM	COL	Optional	Q.ty	boxes	Kg	M ³
	S1390MT	SB	MI	271 €	310 €	382 €	400 €	450 €	405 €	519 €	271 €	382 €	ES-1	2	1	15.5	0.32



COM/COL - Minimum Q.ty 6 pc. for each material. For weft or patterned fabrics see specific pages

	Mtl. 0.75 h. 1.40 Each		Mq. 1.15 Each
--	------------------------	---	---------------

Model	Code	Mod.	--	Upholstery									Optional	Q.ty	boxes	Kg	M ³
CU																	
	S1390SC	SB		425 €									ES-1	2	1	15.5	0.29

Model	Code	Mod.	--	TA	TB	TC	TD	TE	SF	SV	COM	COL	Optional	Q.ty	boxes	Kg	M ³
	S1390ST	SB		285 €	324 €	390 €	411 €	503 €	426 €	541 €	285 €	390 €	ES-1	2	1	15.5	0.29



COM/COL - Minimum Q.ty 6 pc. for each material. For weft or patterned fabrics see specific pages

	Mtl. 0.95 h. 1.40 Each		Mq. 1.50 Each
--	------------------------	---	---------------

Model	Code	Mod.	Frame	Seat and Backrest								Optional	Q.ty	boxes	Kg	M ³
CU																
Chair NUVOLA SA M CU 	S1390RC	SA	M1	417 €								ES-1	2	1	17.5	0.36

Model	Code	Mod.	Frame	TA	TB	TC	TD	TE	SF	SV	COM	COL	Optional	Q.ty	boxes	Kg	M ³
Chair NUVOLA SA M TS 	S1390RT	SA	M1	298 €	336 €	398 €	410 €	486 €	467 €	593 €	298 €	398 €	ES-1	2	1	17.5	0.36



COM/COL - Minimum Q.ty 6 pc. for each material. For weft or patterned fabrics see specific pages

 Mtl. 0.80 h. 1.40 Each	 Mq. 1.20 Each
--	---

Model	Code	Mod.	--	Upholstery								Optional	Q.ty	boxes	Kg	M ³
CU																
Chair NUVOLA SA R_CU 	S1390UC	SA		466 €								ES-1	2	1	17.5	0.36

Model	Code	Mod.	--	TA	TB	TC	TD	TE	SF	SV	COM	COL	Optional	Q.ty	boxes	Kg	M ³
Chair NUVOLA SA R_TS 	S1390UT	SA		314 €	357 €	418 €	447 €	545 €	487 €	622 €	314 €	418 €	ES-1	2	1	17.5	0.36

COM/COL - Minimum Q.ty 6 pc. for each material. For weft or patterned fabrics see specific pages

 Mtl. 1.00 h. 1.40 Each	 Mq. 1.55 Each
--	---

Note:

TS Front and Back covering available in two-tone or bi-material. Reference price in the upper category

Frame finishes

Metal	
MI	WHITE BB , BROWN E6 , SAND EC , GRAPHITE EG , BLACK EN

Seat and Back finishes

Upholstery			
TA	FAUX LEATHER Secret , FABRIC Mirage , FABRIC Cotton Club	TB	FAUX LEATHER Vintage , FABRIC Fenix Wool , FABRIC Novabuk , FABRIC Manhattan , FABRIC Visual
TC	VELVET SUPERB, FABRIC Second , FABRIC Main Line Flax , FABRIC Oceanic	TD	FABRIC Yoredale , FABRIC Remix 3
TE	FABRIC Uniform Melange	SF	LEATHER Fiore
SV	LEATHER Vintage	CU	HIDE

Options:

		Value	Options/notes
ES-1	Fireproof foam	+ 7 €	ES-1

Nuvola SB

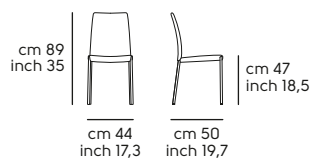

Nuvola SA

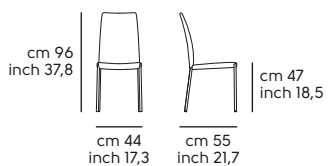



Nuvola PBL, PBLR - Shell in hide, fabric or leather

Frame in: metal or upholstered

Model	Code	Mod.	Frame	Seat and Backrest								Optional	Q.ty	boxes	Kg	M ²
CU																
Armch. NUVOLA PB M CU 	S1390QC	PB	M1	630 €								ES-1	1	1	11.5	0.28

Model	Code	Mod.	Frame	TA	TB	TC	TD	TE	SF	SV	COM	COL	Optional	Q.ty	boxes	Kg	M ²
Armch. NUVOLA PB M TS 	S1390QT	PB	M1	499 €	541 €	630 €	643 €	752 €	668 €	796 €	499 €	630 €	ES-1	1	1	11.5	0.28

COM/COL - Minimum Q.ty 6 pc. for each material. For weft or patterned fabrics see specific pages

 Mtl. 1.35 h. 1.40 Each	 Mq. 2.00 Each
--	---

Model	Code	Mod.	--	Upholstery								Optional	Q.ty	boxes	Kg	M ²
CU																
Armch. NUVOLA PB R CU 	S1390PC	PB		684 €								ES-1	1	1	11.5	0.34

Model	Code	Mod.	--	TA	TB	TC	TD	TE	SF	SV	COM	COL	Optional	Q.ty	boxes	Kg	M ²
Armch. NUVOLA PB R TS 	S1390PT	PB		509 €	572 €	669 €	654 €	763 €	693 €	801 €	509 €	669 €	ES-1	1	1	11.5	0.34

COM/COL - Minimum Q.ty 6 pc. for each material. For weft or patterned fabrics see specific pages

 Mtl. 1.60 h. 1.40 Each	 Mq. 2.33 Each
--	---

Note:

TS Front and Back covering available in two-tone or bi-material. Reference price in the upper category

Frame finishes

Metal	
MI	WHITE BB , BROWN E6 , SAND EC , GRAPHITE EG , BLACK EN

Seat and Back finishes

Upholstery			
TA	FAUX LEATHER Secret , FABRIC Mirage , FABRIC Cotton Club	TB	FAUX LEATHER Vintage , FABRIC Fenix Wool , FABRIC Novabuk , FABRIC Manhattan , FABRIC Visual
TC	VELVET SUPERB, FABRIC Second , FABRIC Main Line Flax , FABRIC Oceanic	TD	FABRIC Yoredale , FABRIC Remix 3
TE	FABRIC Uniform Melange	SF	LEATHER Fiore
SV	LEATHER Vintage	CU	HIDE

Options:



		Value	Options/notes
ES-1	Fireproof foam	+ 7 €	ES-1

Nuvola PB





Nuvola H65-75 - Shell in hide, fabric or leather



Frame in: metal or upholstered

Model	Code	Mod.	Frame	Seat and Backrest								Optional	Q.ty	boxes	Kg	M ²
CU																
 Stool NUVOLA H65 M CU	S1390IC	H65	M1	501 €								ES-1	1	1	9.0	0.23
 Stool NUVOLA H75 M CU	S1390KC	H75	M1	513 €								ES-1	1	1	9.5	0.23

Model	Code	Mod.	Frame	TA	TB	TC	TD	TE	SF	SV	COM	COL	Optional	Q.ty	boxes	Kg	M ²
 Stool NUVOLA H65 M TS	S1390IT	H65	M1	372 €	400 €	434 €	459 €	523 €	488 €	557 €	372 €	434 €	ES-1	1	1	9.0	0.23
 Stool NUVOLA H75 M TS	S1390KT	H75	M1	386 €	413 €	445 €	470 €	534 €	501 €	568 €	386 €	445 €	ES-1	1	1	9.5	0.23



COM/COL - Minimum Q.ty 6 pc. for each material. For weft or patterned fabrics see specific pages

 COM Mtl. 0.65 h. 1.40 Each	 COL Mq. 1.00 Each
--	---

Model	Code	Mod.	--	Upholstery								Optional	Q.ty	boxes	Kg	M ²
CU																
 Stool NUVOLA H65 R_CU	S1390HC	H65		552 €								ES-1	1	1	9.0	0.25
 Stool NUVOLA H75 R_CU	S1390JC	H75		571 €								ES-1	1	1	9.5	0.27

Model	Code	Mod.	--	TA	TB	TC	TD	TE	SF	SV	COM	COL	Optional	Q.ty	boxes	Kg	M ²
 Stool NUVOLA H65 R_TS	S1390HT	H65		400 €	433 €	482 €	490 €	554 €	519 €	600 €	400 €	482 €	ES-1	1	1	9.0	0.25
 Stool NUVOLA H75 R_TS	S1390JT	H75		418 €	450 €	500 €	509 €	573 €	538 €	620 €	418 €	500 €	ES-1	1	1	9.5	0.27

COM/COL - Minimum Q.ty 6 pc. for each material. For weft or patterned fabrics see specific pages

COM 	Mtl. 0.95 h. 1.40 Each	COL 	Mq. 1.50 Each
--	------------------------	---	---------------

Note:
TS Front and Back covering available in two-tone or bi-material. Reference price in the upper category

Frame finishes

Metal	
MI	WHITE BB , BROWN E6 , SAND EC , GRAPHITE EG , BLACK EN

Seat and Back finishes

Upholstery			
TA	FAUX LEATHER Secret , FABRIC Mirage , FABRIC Cotton Club	TB	FAUX LEATHER Vintage , FABRIC Fenix Wool , FABRIC Novabuk , FABRIC Manhattan , FABRIC Visual
TC	VELVET SUPERB, FABRIC Second , FABRIC Main Line Flax , FABRIC Oceanic	TD	FABRIC Yoredale , FABRIC Remix 3
TE	FABRIC Uniform Melange	SF	LEATHER Fiore
SV	LEATHER Vintage	CU	HIDE

Optionals:

		Value	Options/notes
ES-1	Fireproof foam	+ 6 €	ES-1

Nuvola H65

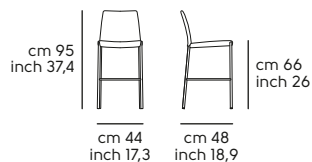



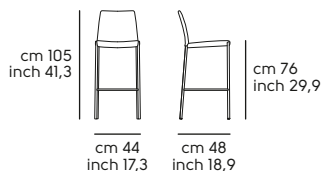

Nuvola H75



Ola design Paolo Vernier

Ola S, P, H65-75, BN - Metal Shell

Frame in: metal

Model	Code	Mod.	--	Frame and Shell				Optional	Q.ty	boxes	Kg	M ³
				M1	M2	O1	O2					
Chair OLA S M 	S140IS0	S		153 €	206 €	264 €	316 €	PD-F0	2 4	1 1	14.0 26.0	0.31 0.41
Armch. OLA P M 	S140IP0	P		179 €	234 €	289 €	344 €	PD-F0	2 4	1 1	14.5 27.0	0.32 0.42
Stool OLA H65 M 	S140IH0	H65		189 €	238 €	299 €	349 €	PD-F0	1 2	1 1	9.0 16.0	0.28 0.34
Stool OLA H75 M 	S140IJ0	H75		201 €	251 €	311 €	361 €	PD-F0	1 2	1 1	9.0 16.0	0.28 0.34
Bench OLA BN M 	S140IB1	BN		364 €	443 €	475 €	553 €	PD-F0	1	1	14.0	0.56

Note:

OUTDOOR USE SEASIDE EXCLUDED

Frame and shell finishes

Metal

M1	WHITE BB , INDUSTRIAL E5 , BROWN E6 , SAND EC , GRAPHITE EG , BLACK EN
M2	LIGHT BLUE E0 , OCEAN BLUE E1 , BRONZE E2 , FANGO E3 , PASTEL YELLOW E4 , OCHER YELLOW E7 , FACEPOWDER PINK E8 , SAGE GREEN E9 , PAPAYA ORANGE EA , PINE GREEN EJ , DARK GREEN EL , GOLDEN YELLOW EO , CHERRY RED EQ , RED ER , ASH GREY ES , LIGHT GREY ET , BULGARO RED FP

Outdoor Metal

O1	Outdoor BROWN E6 , Outdoor WHITE BB , Outdoor SAND EC , Outdoor GRAFITE EG , Outdoor BLACK EN
O2	Outdoor LIGHT BLUE E0 , Outdoor OCEAN BLUE E1 , Outdoor BRONZE E2 , Outdoor FANGO E3 , Outdoor PASTEL YELLOW E4 , Outdoor OCHER YELLOW E7 , Outdoor FACEPOWDER PINK E8 , Outdoor SAGE GREEN E9 , Outdoor PINE GREEN EJ , Outdoor DARK GREEN EL , Outdoor GOLD YELLOW EO , Outdoor RED BULGARO FP , Outdoor CHERRY RED EQ , Outdoor RED ER , Outdoor ASH GREY ES , Outdoor LIGHT GREY ET , Outdoor PAPAYA ORANGE EA

Optionals:

	Value	Options/notes
PD-F0	Felt pad feet	+ 6 € PD-F0

Ola S

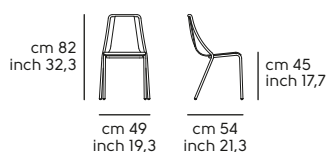

Ola P

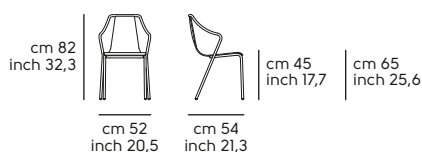

Ola H65

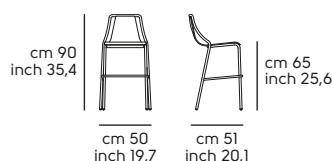

Ola H75

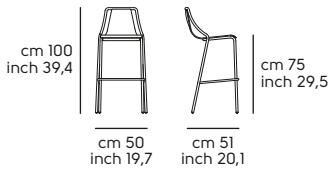



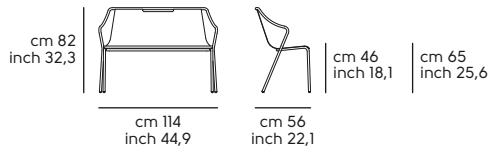





Ola BN



Ola S, P, H65-75 - Wood shell

Frame in: metal

Model	Code	Mod.	Frame	Shell		Optional	Q.ty	boxes	Kg	M ³
				L11	L12					
Chair OLA S M LG										
										
										
	SI400SW	S	M1	237 €	252 €	FM-M2 PD-F0	2 4	1 1	14.0 26.0	0.31 0.41
Armch. OLA P M LG										
										
										
	SI400PW	P	M1	265 €	278 €	FM-M2 PD-F0	2 4	1 1	14.5 27.0	0.32 0.42
Stool OLA H65 M LG										
										
										
	SI400HW	H65	M1	277 €	287 €	FM-M2 PD-F0	1 2	1 1	9.0 16.0	0.26 0.29
Stool OLA H75 M LG										
										
										
	SI400JW	H75	M1	290 €	299 €	FM-M2 PD-F0	1 2	1 1	9.0 16.0	0.3 0.35

Frame finishes

Metal	
M1	WHITE BB , INDUSTRIAL E5 , BROWN E6 , SAND EC , GRAPHITE EG , BLACK EN

Shell finishes

Wood	
L11	Veneered wood painted GREY I02 , Veneered wood painted GRAFITE GREY I03 , Veneered wood painted BLACK I04 , Veneered wood painted WHITE I05 , Veneered wood painted BLUE I06 , Veneered wood painted RED I08 , Veneered wood painted CHERRY RED I09 , Veneered wood painted DARK BROWN I26 , Veneered wood painted NATURAL I40 , Veneered wood painted NATURAL OAK I52
L12	Veneered wood NATURAL OAK I22 , Veneered wood FLAMED WALNUT I24

Optionals:

	Value	Options/notes
FM-M2	+ 45 €	ASH GREY ES , BRONZE E2 , BULGARO RED FP , CHERRY RED EQ , DARK GREEN EL , FACEPOWDER PINK E8 , FANGO E3 , GOLDEN YELLOW EO , LIGHT BLUE EO , LIGHT GREY ET , OCEAN BLUE E1 , OCHER YELLOW E7 , PAPAYA ORANGE EA , PASTEL YELLOW E4 , PINE GREEN EJ , RED ER , SAGE GREEN E9
PD-F0	+ 6 €	PD-F0

Ola S

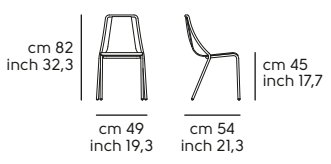

Ola P

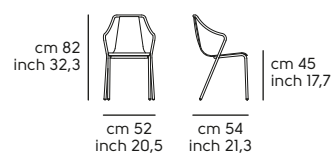

Ola H65

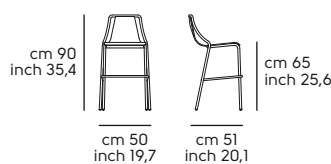



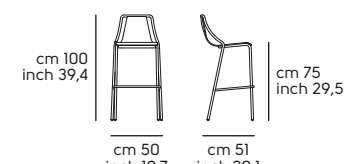





Ola H75



Ola S, P, H65-75 - Shell in hide

Frame in: metal

Model	Code	Mod.	Frame	Shell		Optional	Q.ty	boxes	Kg	M³
				CU	CT					
Chair OLA S M CU 	S1400SC	S	M1	300 €	423 €	FM-M2 PD-F0	2	1	14.0	0.31
							4	1	26.0	0.41
Armch. OLA P M CU 	S1400PC	P	M1	328 €	450 €	FM-M2 PD-F0	2	1	14.5	0.32
							4	1	27.0	0.42
Stool OLA H65 M CU 	S1400HC	H65	M1	332 €	431 €	FM-M2 PD-F0	1	1	9.0	0.26
							2	1	16.0	0.3
Stool OLA H75 M CU 	S1400JC	H75	M1	344 €	442 €	FM-M2 PD-F0	1	1	9.0	0.28
							2	1	16.0	0.34

Frame finishes

Metal

M1 WHITE **BB**, INDUSTRIAL **E5**, BROWN **E6**, SAND **EC**, GRAPHITE **EG**, BLACK **EN**

Shell finishes

Upholstery

CU HIDE

CT TUSCAN HIDE

Optionals:

		Value	Options/notes
FM-M2	Indoor matt metal M2	+ 45 €	ASH GREY ES , BRONZE E2 , BULGARO RED FP , CHERRY RED EQ , DARK GREEN EL , FACEPOWDER PINK E8 , FANGO E3 , GOLDEN YELLOW EO , LIGHT BLUE EO , LIGHT GREY ET , OCEAN BLUE E1 , OCHER YELLOW E7 , PAPAYA ORANGE EA , PASTEL YELLOW E4 , PINE GREEN EJ , RED ER , SAGE GREEN E9
PD-F0	Felt pad feet	+ 6 €	PD-F0

Ola S

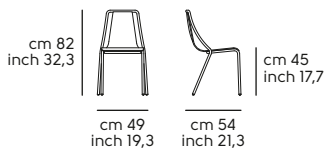

Ola P

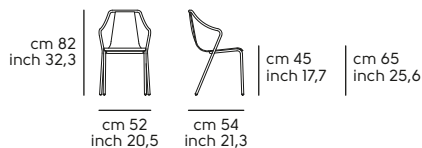

Ola H65

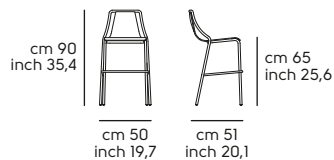



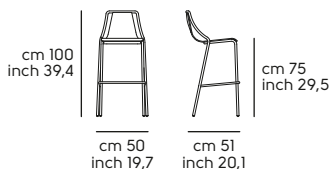

Ola H75





Ola S, P, H65-75 - Shell in fabric or leather

Frame in: metal



Model	Code	Mod.	Frame	Shell									Optional	Q.ty	boxes	Kg	M³
				TA	TB	TC	TD	TE	SF	SV	COM	COL					
Chair OLA S M TS																	
 	SI400ST	S	MI	227 €	250 €	280 €	296 €	350 €	310 €	372 €	227 €	280 €	FM-M2 PD-FO	2	1	14.0	0.31
				4	1	26.0	0.41										
Armch. OLA P M TS																	
 	SI400PT	P	MI	254 €	277 €	309 €	326 €	376 €	336 €	400 €	254 €	309 €	FM-M2 PD-FO	2	1	14.5	0.32
				4	1	27.0	0.42										

COM/COL - Minimum Q.ty 6 pc. for each material. For weft or patterned fabrics see specific pages

 Mtl. 0.65 h. 1.40 Each	 Mq. 1.07 Each
---	---

Model	Code	Mod.	Frame	Shell									Optional	Q.ty	boxes	Kg	M³
				TA	TB	TC	TD	TE	SF	SV	COM	COL					
Stool OLA H65 M TS																	
 	SI400HT	H65	MI	274 €	300 €	323 €	339 €	392 €	350 €	412 €	274 €	323 €	FM-M2 PD-FO	1	1	9.0	0.26
				2	1	16.0	0.32										
Stool OLA H75 M TS																	
 	SI400JT	H75	MI	288 €	313 €	336 €	353 €	404 €	362 €	423 €	288 €	336 €	FM-M2 PD-FO	1	1	9.0	0.3
				2	1	16.0	0.35										

COM/COL - Minimum Q.ty 6 pc. for each material. For weft or patterned fabrics see specific pages

 Mtl. 0.60 h. 1.40 Each	 Mq. 0.95 Each
---	---

Note:

TS Front and Back covering available in two-tone or bi-material. Reference price in the upper category

Frame finishes

Metal	
MI	WHITE BB , INDUSTRIAL E5 , BROWN E6 , SAND EC , GRAPHITE EG , BLACK EN

Shell finishes

Upholstery			
TA	FAUX LEATHER Secret , FABRIC Mirage , FABRIC Cotton Club	TB	FAUX LEATHER Vintage , FABRIC Fenix Wool , FABRIC Novabuk , FABRIC Manhattan , FABRIC Visual
TC	VELVET SUPERB, FABRIC Second , FABRIC Main Line Flax , FABRIC Oceanic	TD	FABRIC Yoredale , FABRIC Remix 3
TE	FABRIC Uniform Melange	SF	LEATHER Fiore
SV	LEATHER Vintage		

Options:

		Value	Options/notes
FM-M2	Indoor matt metal M2	+ 45 €	ASH GREY ES , BRONZE E2 , BULGARO RED FP , CHERRY RED EQ , DARK GREEN EL , FACEPOWDER PINK E8 , FANGO E3 , GOLDEN YELLOW EO , LIGHT BLUE EO , LIGHT GREY ET , OCEAN BLUE EI , OCHER YELLOW E7 , PAPAYA ORANGE EA , PASTEL YELLOW E4 , PINE GREEN EJ , RED ER , SAGE GREEN E9
PD-F0	Felt pad feet	+ 6 €	PD-F0

Ola S

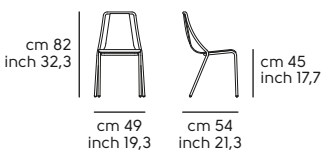

Ola P

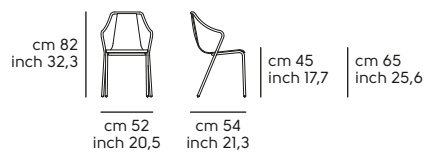

Ola H65

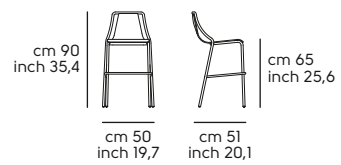



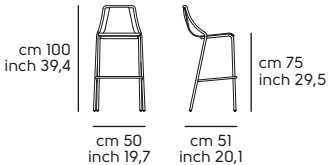

Ola H75



P47 design Franco Poli

Armchair P47 P - Shell in hide, seat in fabric or leather

Frame in: metal

Model	Code	Mod.	Frame	Seat (Backrest hide CK)									Optional	Q.ty	boxes	Kg	M ³
				TA	TB	TC	TD	TE	SF	SV	COM	COL					
 Armchair P47 P M TS_CU	S2140P00	P M	MI	775 €	790 €	803 €	839 €	898 €	823 €	843 €	775 €	803 €	FM-M2 FM-M3 FM-M4 RV-CT	1 2	1 1	13.0 24.0	0.37 0.37
 Armchair P47 P GX TS_CU	S2140PX0	P GX	MI	927 €	941 €	956 €	991 €	1.050 €	975 €	995 €	927 €	956 €	FM-M2 RV-CT	1	1	17.0	0.24
 Armch. with self-return P47 P GX TS_CU	S2140PX1	P GX A	MI	958 €	971 €	987 €	1.022 €	1.080 €	1.007 €	1.027 €	958 €	987 €	FM-M2 RV-CT	1	1	17.0	0.24
 Office Arm. P47 DP TS_CU	S2140DP0	DP	MI	962 €	975 €	991 €	1.027 €	1.085 €	1.011 €	1.031 €	962 €	991 €	FM-M2 RV-CT	1	2	19.0	0.31
 Office Arm. P47 DPA TS_CU	S2140DPA	DPA	MI	1.078 €	1.093 €	1.108 €	1.143 €	1.202 €	1.128 €	1.148 €	1.078 €	1.108 €	FM-M2 RV-CT	1	2	20.0	0.44

Note:

Frame finishes

Metal

MI WHITE **BB**, BROWN **E6**, SAND **EC**, GRAPHITE **EG**, BLACK **EN**

Back finishes

Upholstery

CK HIDE_TK

Seat finishes

Upholstery

TA FAUX LEATHER **Secret**, FABRIC **Mirage**, FABRIC **Cotton Club**

TC VELVET SUPERB, FABRIC **Second**, FABRIC **Main Line Flax**, FABRIC **Oceanic**

TE FABRIC **Uniform Melange**



SV LEATHER **Vintage**

TB FAUX LEATHER **Vintage**, FABRIC **Fenix Wool**, FABRIC **Novabuk**, FABRIC **Manhattan**, FABRIC **Visual**



TD FABRIC **Yoredale**, FABRIC **Remix 3**

SF LEATHER **Fiore**

COM/COL - Minimum Q.ty 6 pc. for each material. For weft or patterned fabrics see specific pages

 Mtl. 0.73 h. 1.40 Each	 Mq. 0.57 Each
--	---

COM/COL - Minimum Q.ty 6 pc. for each material. For weft or patterned fabrics see specific pages

 Mtl. 1.16 h. 1.40 Each	 Mq. 1.12 Each
--	---

Optionals:

	Value	Options/notes
FM-M2	+ 59 €	ASH GREY ES , BRONZE E2 , BULGARO RED FP , CHERRY RED EQ , DARK GREEN EL , FACEPOWDER PINK E8 , FANGO E3 , GOLDEN YELLOW EO , LIGHT BLUE EO , LIGHT GREY ET , OCEAN BLUE E1 , OCHER YELLOW E7 , PAPAYA ORANGE EA , PASTEL YELLOW E4 , PINE GREEN EJ , RED ER , SAGE GREEN E9
FM-M3	+ 29 €	CHROME CC
FM-M4	+ 158 €	BLACK NICKEL DZ , CHAMPAGNE GOLD DG , GOLDEN BRONZE DB , MATT BLACK NICKEL DY , MATT GOLDEN BRONZE DC , PINK GOLD DR
RV-CT	+ 188 €	TUSCAN HIDE

P47 P M

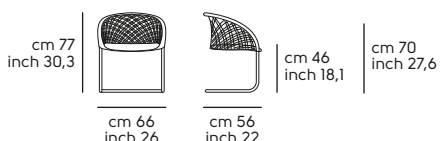

P47 P GX

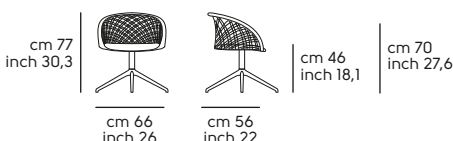

P47 P GXA

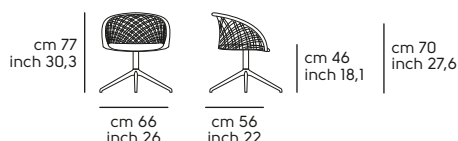

P47 DP



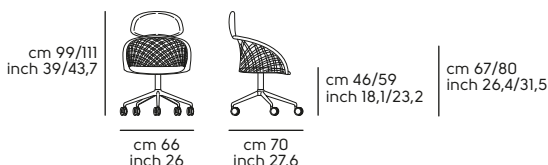

P47 DPA



Waiting Chair P47 AP - Shell in hide, seat in fabric or leather

Frame in: metal

Model	Code	Mod.	Frame	Seat (Backrest hide CK)								Optional	Q.ty	boxes	Kg	M³	
				TA	TB	TC	TD	TE	SF	SV	COM						COL
	S2140APO	AP M	M1	994 €	1.020 €	1.055 €	1.103 €	1.174 €	1.076 €	1.124 €	994 €	1.055 €	FM-M2 FM-M3 RV-CT	1	1	17.5	0.46
	S2140APX	AP GX	M1	1.163 €	1.189 €	1.224 €	1.271 €	1.342 €	1.244 €	1.292 €	1.163 €	1.224 €	FM-M2 RV-CT	1	1	20.0	0.5
	S2140APY	APA GX	M1	1.316 €	1.341 €	1.376 €	1.423 €	1.494 €	1.397 €	1.443 €	1.316 €	1.376 €	FM-M2 RV-CT	1	1	21.0	0.68

Note:

Frame finishes

Metal	
MI	WHITE BB , BROWN E6 , SAND EC , GRAPHITE EG , BLACK EN



Back finishes

Upholstery	
CK	HIDE_TK



Seat finishes

Upholstery	
TA	FAUX LEATHER Secret , FABRIC Mirage , FABRIC Cotton Club
TC	VELVET SUPERB, FABRIC Second , FABRIC Main Line Flax , FABRIC Oceanic
TE	FABRIC Uniform Melange
SV	LEATHER Vintage
TB	FAUX LEATHER Vintage , FABRIC Fenix Wool , FABRIC Novabuk , FABRIC Manhattan , FABRIC Visual
TD	FABRIC Yoredale , FABRIC Remix 3
SF	LEATHER Fiore

COM/COL - Minimum Q.ty 6 pc. for each material. For weft or patterned fabrics see specific pages

 Mtl. 0.84 h. 1.40 Each	 Mq. 0.79 Each
---	---

COM/COL - Minimum Q.ty 6 pc. for each material. For weft or patterned fabrics see specific pages

 Mtl. 1.32 h. 1.40 Each	 Mq. 1.38 Each
---	---

Optionals:

	Value	Options/notes
FM-M2	+ 59 €	Indoor matt metal M2 ASH GREY ES , BRONZE E2 , BULGARO RED FP , CHERRY RED EQ , DARK GREEN EL , FACEPOWDER PINK E8 , FANGO E3 , GOLDEN YELLOW EO , LIGHT BLUE EO , LIGHT GREY ET , OCEAN BLUE E1 , OCHER YELLOW E7 , PAPAYA ORANGE EA , PASTEL YELLOW E4 , PINE GREEN EJ , RED ER , SAGE GREEN E9
FM-M3	+ 29 €	Indoor glossy metal M3 CHROME CC
RV-CT	+ 257 €	Tuscan hide upholstery TUSCAN HIDE

P47 AP M

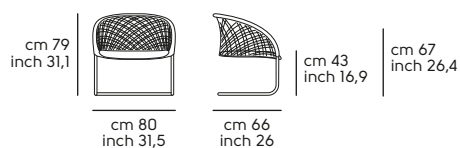

P47 AP GX

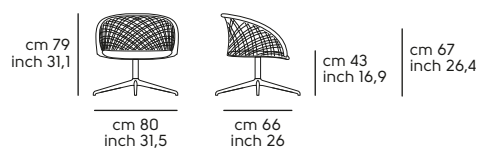

P47 APA GX

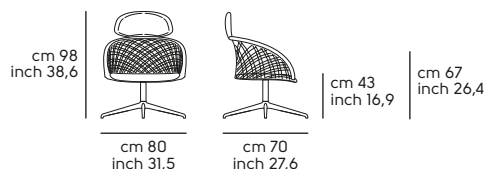

Sofa P47 DV - Shell in hide, seat in fabric or leather

Frame in: metal

Model	Code	Mod.	Frame	Seat (Backrest hide CK)									Optional	Q.ty	boxes	Kg	M ³
				TA	TB	TC	TD	TE	SF	SV	COM	COL					
 Sofa P47 DV M TS_CU	S2140DVO	DV M	M1	1.414 €	1.455 €	1.491 €	1.542 €	1.619 €	1.519 €	1.560 €	1.414 €	1.491 €	FM-M2 FM-M3 RV-CT	1	1	25.0	0.7

Note:

Frame finishes

Metal

MI WHITE **BB**, BROWN **E6**, SAND **EC**, GRAPHITE **EG**, BLACK **EN**

Back finishes

Upholstery

CK HIDE_TK

Seat finishes

Upholstery

TA FAUX LEATHER **Secret**, FABRIC **Mirage**, FABRIC **Cotton Club**

TB FAUX LEATHER **Vintage**, FABRIC **Fenix Wool**, FABRIC **Novabuk**, FABRIC **Manhattan**, FABRIC **Visual**

TC VELVET SUPERB, FABRIC **Second**, FABRIC **Main Line Flax**, FABRIC **Oceanic**



TD FABRIC **Yoredale**, FABRIC **Remix 3**

TE FABRIC **Uniform Melange**

SF LEATHER **Fiore**

SV LEATHER **Vintage**

COM/COL - Minimum Q.ty 6 pc. for each material. For weft or patterned fabrics see specific pages

 COM	Mtl. 0.85 h. 1.40 Each	 COL	Mq. 1.30 Each
--	------------------------	--	---------------

Optionals:

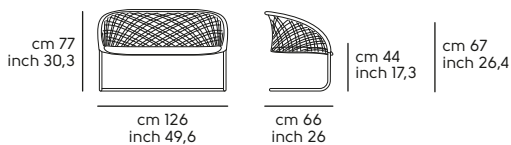

	Value	Options/notes
FM-M2	+ 64 €	ASH GREY ES , BRONZE E2 , BULGARO RED FP , CHERRY RED EQ , DARK GREEN EL , FACEPOWDER PINK E8 , FANGO E3 , GOLDEN YELLOW EO , LIGHT BLUE EO , LIGHT GREY ET , OCEAN BLUE E1 , OCHER YELLOW E7 , PAPAYA ORANGE EA , PASTEL YELLOW E4 , PINE GREEN EJ , RED ER , SAGE GREEN E9
FM-M3	+ 46 €	CHROME CC
RV-CT	+ 305 €	TUSCAN HIDE

P47 DV M



Stool P47 H65-H75 - Shell in hide, seat in fabric or leather

Frame in: metal

Model	Code	Mod.	Frame	Seat (Backrest hide CK)									Optional	Q.ty	boxes	Kg	M³
				TA	TB	TC	TD	TE	SF	SV	COM	COL					
 Stool P47 H65 MTS_CU	S2140H00	H65 M	MI	803 €	816 €	831 €	862 €	927 €	851 €	869 €	803 €	831 €	FM-M2 FM-M3 FM-M4 RV-CT	1	1	12.0	0.3
 Stool P47 H75 MTS_CU	S2140J00	H75 M	MI	816 €	827 €	841 €	875 €	940 €	861 €	881 €	816 €	841 €	FM-M2 FM-M3 FM-M4 RV-CT	1	1	13.0	0.33

Note:

Frame finishes

Metal

MI WHITE **BB**, BROWN **E6**, SAND **EC**, GRAPHITE **EG**, BLACK **EN**

Back finishes

Upholstery

CK HIDE_TK

Seat finishes

Upholstery

TA FAUX LEATHER **Secret**, FABRIC **Mirage**, FABRIC **Cotton Club**

TC VELVET SUPERB, FABRIC **Second**, FABRIC **Main Line Flax**, FABRIC **Oceanic**

TE FABRIC **Uniform Melange**



SV LEATHER **Vintage**

TB FAUX LEATHER **Vintage**, FABRIC **Fenix Wool**, FABRIC **Novabuk**, FABRIC **Manhattan**, FABRIC **Visual**

TD FABRIC **Yoredale**, FABRIC **Remix 3**

SF LEATHER **Fiore**

COM/COL - Minimum Q.ty 6 pc. for each material. For weft or patterned fabrics see specific pages

 COM	Mtl. 0.67 h. 1.40 Each	 COL	Mq. 0.55 Each
---	------------------------	--	---------------

Optionals:

		Value	Options/notes
FM-M2	Indoor matt metal M2	+ 59 €	ASH GREY ES , BRONZE E2 , BULGARO RED FP , CHERRY RED EQ , DARK GREEN EL , FACEPOWDER PINK E8 , FANGO E3 , GOLDEN YELLOW EO , LIGHT BLUE E0 , LIGHT GREY ET , OCEAN BLUE E1 , OCHER YELLOW E7 , PAPAYA ORANGE EA , PASTEL YELLOW E4 , PINE GREEN EJ , RED ER , SAGE GREEN E9
FM-M3	Indoor glossy metal M3	+ 29 €	CHROME CC
FM-M4	Indoor glossy Metal M4	+ 158 €	BLACK NICKEL DZ , CHAMPAGNE GOLD DG , GOLDEN BRONZE DB , MATT BLACK NICKEL DY , MATT GOLDEN BRONZE DC , PINK GOLD DR
RV-CT	Tuscan hide upholstery	+ 170 €	TUSCAN HIDE

P47 H65 M

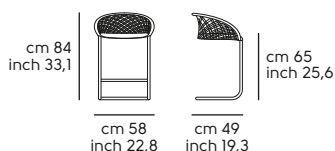

P47 H75 M

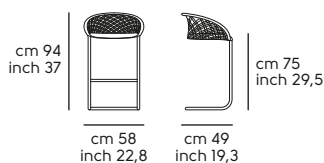

Stool P47 SG - Shell in hide, seat in fabric or leather

Frame in: metal

Model	Code	Mod.	Frame	Seat (Backrest hide CK)									Optional	Q.ty	boxes	Kg	M ³
				TA	TB	TC	TD	TE	SF	SV	COM	COL					
 Stool P47 SG TS_CU	S2140ZTO	SG	MI	965 €	975 €	990 €	1.023 €	1.088 €	1.010 €	1.030 €	965 €	990 €	FM-M2 RV-CT	1	1	22.0	0.32

Note:

Frame finishes

Metal

MI WHITE **BB**, BROWN **E6**, SAND **EC**, GRAPHITE **EG**, BLACK **EN**

Back finishes

Upholstery

CK HIDE_TK

Seat finishes

Upholstery

TA FAUX LEATHER **Secret**, FABRIC **Mirage**, FABRIC **Cotton Club**

TB FAUX LEATHER **Vintage**, FABRIC **Fenix Wool**, FABRIC **Novabuk**, FABRIC **Manhattan**, FABRIC **Visual**

TC VELVET SUPERB, FABRIC **Second**, FABRIC **Main Line Flax**, FABRIC **Oceanic**



TD FABRIC **Yoredale**, FABRIC **Remix 3**

TE FABRIC **Uniform Melange**

SF LEATHER **Fiore**

SV LEATHER **Vintage**

COM/COL - Minimum Q.ty 6 pc. for each material. For weft or patterned fabrics see specific pages

 COM	Mtl. 0.67 h. 1.40 Each	 COL	Mq. 0.55 Each
--	------------------------	--	---------------

Optionals:

	Value	Options/notes
FM-M2	+ 59 €	ASH GREY ES , BRONZE E2 , BULGARO RED FP , CHERRY RED EQ , DARK GREEN EL , FACEPOWDER PINK E8 , FANGO E3 , GOLDEN YELLOW EO , LIGHT BLUE EO , LIGHT GREY ET , OCEAN BLUE E1 , OCHER YELLOW E7 , PAPAYA ORANGE EA , PASTEL YELLOW E4 , PINE GREEN EJ , RED ER , SAGE GREEN E9
RV-CT	+ 170 €	TUSCAN HIDE

P47 SG

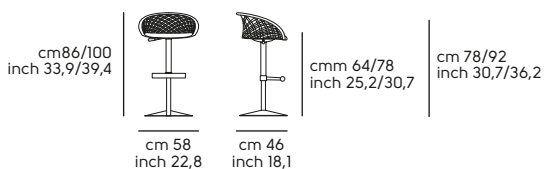

Pouf P47 B2 - Cushion in fabric or leather

Frame in: metal

Model	Code	Mod.	Frame	Cushion									Optional	Q.ty	boxes	Kg	M³
				TA	TB	TC	TD	TE	SF	SV	COM	COL					
 Pouf P47 B2 M TS	S2140B20	B2	M1	513 €	541 €	575 €	622 €	687 €	596 €	643 €	513 €	575 €	FM-M2	1	1	12.0	0.2

Note:

Frame finishes

Metal



MI WHITE **BB**, BROWN **E6**, SAND **EC**, GRAPHITE **EG**, BLACK **EN**

Seat finishes

Upholstery

TA	FAUX LEATHER Secret , FABRIC Mirage , FABRIC Cotton Club	TB	FAUX LEATHER Vintage , FABRIC Fenix Wool , FABRIC Novabuk , FABRIC Manhattan , FABRIC Visual
TC	VELVET SUPERB, FABRIC Second , FABRIC Main Line Flax , FABRIC Oceanic	TD	FABRIC Yoredale , FABRIC Remix 3
TE	FABRIC Uniform Melange	SF	LEATHER Fiore
SV	LEATHER Vintage		

COM/COL - Minimum Q.ty 6 pc. for each material. For weft or patterned fabrics see specific pages

 COM	Mtl. 0.85 h. 1.40 Each	 COL	Mq. 1.42 Each
---	------------------------	--	---------------

Optionals:

	Value	Options/notes
FM-M2	Indoor matt metal M2	+ 59 € ASH GREY ES , BRONZE E2 , BULGARO RED FP , CHERRY RED EQ , DARK GREEN EL , FACEPOWDER PINK E8 , FANGO E3 , GOLDEN YELLOW EO , LIGHT BLUE EO , LIGHT GREY ET , OCEAN BLUE E1 , OCHER YELLOW E7 , PAPAYA ORANGE EA , PASTEL YELLOW E4 , PINE GREEN EJ , RED ER , SAGE GREEN E9



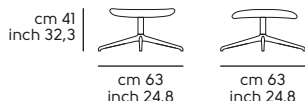

P47 B2



Pippi design Roberto Paoli

Pippi S, P, AP, H65-75 - Completely upholstered in fabric

Frame in: metal upholstered

Model	Code	Mod.	feet	Upholstery		Optional	Q.ty	boxes	Kg	M ³
				TB	TE					
Chair PIPPI S R_TS 	S1950ST	S	M1	418 €	557 €	FM-M2 FM-M4 ES-1	1 2	1 1	8.0 16.0	0.26 0.37
Armch. PIPPI P R_TS 	S1950PT	P	M1	456 €	594 €	FM-M2 FM-M4 ES-1	1	1	8.5	0.3
Waiting Chair PIPPI AP R_TS 	S1950AT	AP	M1	541 €	706 €	FM-M2 FM-M4 ES-1	1	1	10.0	0.42
Stool PIPPI H65 R_TS 	S1950HT	H65	M1	500 €	639 €	FM-M2 FM-M4 ES-1	1	1	8.5	0.2
Stool PIPPI H75 R_TS 	S1950JT	H75	M1	511 €	653 €	FM-M2 FM-M4 ES-1	1	1	9.0	0.25

Feet finishes

Metal

MI	WHITE BB , BROWN E6 , SAND EC , GRAPHITE EG , BLACK EN
-----------	---

Shell finishes

Upholstery

TB	FABRIC Fenix Wool , FABRIC Visual
-----------	---

Shell finishes

Upholstery

TE	FABRIC Uniform Melange
-----------	-------------------------------

Optionals:

		Value	Options/notes
FM-M2	Indoor matt metal M2	+ 22 €	ASH GREY ES , BRONZE E2 , BULGARO RED FP , CHERRY RED EQ , DARK GREEN EL , FACEPOWDER PINK E8 , FANGO E3 , GOLDEN YELLOW EO , LIGHT BLUE E0 , LIGHT GREY ET , OCEAN BLUE E1 , OCHER YELLOW E7 , PAPAYA ORANGE EA , PASTEL YELLOW E4 , PINE GREEN EJ , RED ER , SAGE GREEN E9
FM-M4	Indoor glossy Metal M4	+ 49 €	BLACK NICKEL DZ , CHAMPAGNE GOLD DG , GOLDEN BRONZE DB , MATT BLACK NICKEL DY , MATT GOLDEN BRONZE DC , PINK GOLD DR
ES-1	Fireproof foam	+ 7 €	ES-1

Pippi S

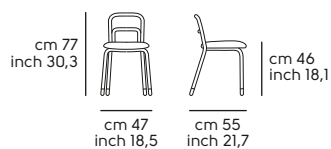

Pippi P

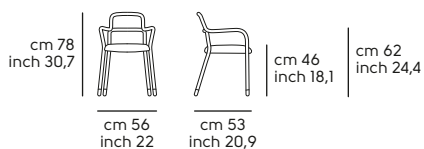

Pippi AP

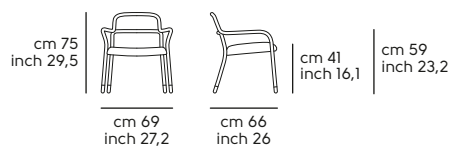

Pippi H65

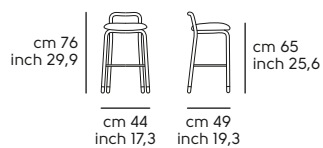

Pippi H75

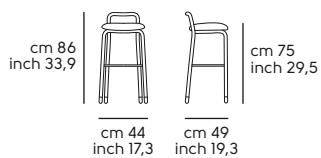

Piuma design Paolo Vernier

Piuma S, P, H65-75 - Seat and back in hide, fabric or leather, wood

Frame in: metal

Model	Code	Mod.	Frame + Insert	Seat and Backrest								Optional	Q.ty	boxes	Kg	M ³
				CU				CT								
Chair PIUMA S M CU 	S2210SC	S	MI	439 €				527 €				FM-M2 FM-M4 ES-1 PD-FO	2	1	8.4	0.29







Model	Code	Mod.	Frame + Insert	TA	TB	TC	TD	TE	SF	SV	COM	COL	Optional	Q.ty	boxes	Kg	M ³
				Chair PIUMA S M TS 	S2210ST	S	MI	358 €	378 €	401 €	418 €	476 €					

Model	Code	Mod.	Frame + Insert	LI1				LI2				Optional	Q.ty	boxes	Kg	M ³
				Chair PIUMA S M LG 	S2210SW	S	MI	395 €								

Model	Code	Mod.	Frame + Insert	Seat and Backrest								Optional	Q.ty	boxes	Kg	M ³
				CU				CT								
Armch. PIUMA P M CU 	S2210PC	P	MI	458 €				546 €				FM-M2 FM-M4 ES-1 PD-FO	1	1	5.7	0.21

Model	Code	Mod.	Frame + Insert	TA	TB	TC	TD	TE	SF	SV	COM	COL	Optional	Q.ty	boxes	Kg	M ³
				Armch. PIUMA P M TS 	S2210PT	P	MI	436 €	456 €	479 €	495 €	552 €					

Model	Code	Mod.	Frame + Insert	LI1				LI2				Optional	Q.ty	boxes	Kg	M ³
				Armch. PIUMA P M LG 	S2210PW	P	MI	414 €								

Model	Code	Mod.	Frame + Insert	Seat and Backrest								Optional	Q.ty	boxes	Kg	M³	
				CU				CT									
Stool PIUMA H65 M CU 	S2210HC	H65	M1	505 €				593 €				FM-M2 FM-M4 ES-1 PD-F0	1	1	5.9	0.21	
Stool PIUMA H75 M CU 	S2210JC	H75	M1	519 €				607 €				FM-M2 FM-M4 ES-1 PD-F0	1	1	6.2	0.23	
				TA	TB	TC	TD	TE	SF	SV	COM	COL					
Stool PIUMA H65 M TS 	S2210HT	H65	M1	424 €	444 €	467 €	484 €	542 €	530 €	605 €	424 €	467 €	FM-M2 FM-M4 ES-1 PD-F0	1	1	5.9	0.21
Stool PIUMA H75 M TS 	S2210JT	H75	M1	438 €	458 €	481 €	498 €	554 €	544 €	618 €	438 €	481 €	FM-M2 FM-M4 ES-1 PD-F0	1	1	6.2	0.23
				LI1				LI2									
Stool PIUMA H65 M LG 	S2210HW	H65	M1	461 €				475 €				FM-M2 FM-M4 ES-1 PD-F0	1	1	5.9	0.21	
Stool PIUMA H75 M LG 	S2210JW	H75	M1	475 €				487 €				FM-M2 FM-M4 ES-1 PD-F0	1	1	6.2	0.23	

Finishes Frame and inserts

Metal	
MI	WHITE BB , BROWN E6 , SAND EC , GRAPHITE EG , BLACK EN

Finishes wing screws

Metal	
MI	BLACK EN



Seat and Back finishes150

Wood	
LI1	Veneered wood painted GREY I02 , Veneered wood painted GRAFITE GREY I03 , Veneered wood painted BLACK I04 , Veneered wood painted WHITE I05 , Veneered wood painted BLUE I06 , Veneered wood painted RED I08 , Veneered wood painted CHERRY RED I09 , Veneered wood painted DARK BROWN I26 , Veneered wood painted NATURAL I40 , Veneered wood painted NATURAL OAK I52
LI2	Veneered wood NATURAL OAK I22 , Veneered wood FLAMED WALNUT I24

Seat and Back finishes

Upholstery			
TA	FAUX LEATHER Secret , FABRIC Mirage , FABRIC Cotton Club	TB	FAUX LEATHER Vintage , FABRIC Fenix Wool , FABRIC Novabuk , FABRIC Manhattan , FABRIC Visual
TC	VELVET SUPERB, FABRIC Second , FABRIC Main Line Flax , FABRIC Oceanic	TD	FABRIC Yoredale , FABRIC Remix 3
TE	FABRIC Uniform Melange	SF	LEATHER Fiore
SV	LEATHER Vintage	CU	HIDE
CT	TUSCAN HIDE		

COM/COL - Minimum Q.ty 6 pc. for each material. For weft or patterned fabrics see specific pages

 COM	Mtl. 0.65 h. 1.40 Each	 COL	Mq. 0.80 Each
--	------------------------	--	---------------

Optionals:

		Value	Options/notes
FM-M2	Indoor matt metal M2	+ 49 €	ASH GREY ES , BRONZE E2 , BULGARO RED FP , CHERRY RED EQ , DARK GREEN EL , FACEPOWDER PINK E8 , FANGO E3 , GOLDEN YELLOW EO , LIGHT BLUE EO , LIGHT GREY ET , OCEAN BLUE E1 , OCHER YELLOW E7 , PAPAYA ORANGE EA , PASTEL YELLOW E4 , PINE GREEN EJ , RED ER , SAGE GREEN E9
FM-M4	Indoor glossy Metal M4	+ 132 €	BLACK NICKEL DZ , CHAMPAGNE GOLD DG , GOLDEN BRONZE DB , MATT BLACK NICKEL DY , MATT GOLDEN BRONZE DC , PINK GOLD DR
ES-1	Fireproof foam	+ 6 €	ES-1
PD-F0	Felt pad feet	+ 6 €	PD-F0

Piuma S

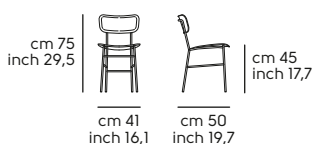

Piuma H65

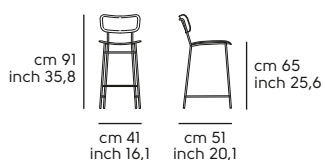

Piuma H75

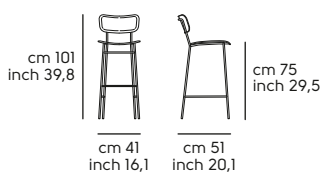

Piuma P

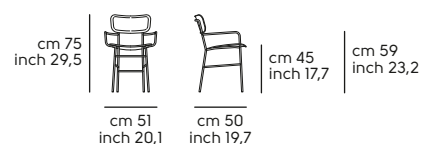

Qua-ndo design Michi Jung & Paolo Vernier

Qua-ndo P, AP, DV - Seat and back in fabric or leather

Frame in: metal

Model	Code	Mod.	Frame	Seat and Backrest						Optional	Q.ty	boxes	Kg	M ³
				TA	TB	TC	TD	TE	COM					
 Armch. QUA-NDO P MTS	S2190PT	P	MI	651 €	687 €	747 €	786 €	896 €	651 €	FM-M2 FM-M4 ES-1	1	1	10.0	0.31

COM/COL - Minimum Q.ty 6 pc. for each material. For weft or patterned fabrics see specific pages

	Mtl. 2.30 h. 1.40 Each
--	------------------------

Model	Code	Mod.	Frame	Seat and Backrest						Optional	Q.ty	boxes	Kg	M ³
				TA	TB	TC	TD	TE	COM					
 Waiting Chair QUA-NDO AP MTS	S2190AT	AP	MI	860 €	921 €	1.020 €	1.086 €	1.257 €	860 €	FM-M2 FM-M4 ES-1	1	1	13.65	0.48

COM/COL - Minimum Q.ty 6 pc. for each material. For weft or patterned fabrics see specific pages

	Mtl. 2.85 h. 1.40 Each
--	------------------------

Model	Code	Mod.	Frame	Seat and Backrest						Optional	Q.ty	boxes	Kg	M ³
				TA	TB	TC	TD	TE	COM					
 Sofa QUA-NDO DV MTS	S2190LT	DV	MI	1.367 €	1.461 €	1.608 €	1.709 €	1.974 €	1.367 €	FM-M2 FM-M4 ES-1	1	1	23.5	0.82

COM/COL - Minimum Q.ty 6 pc. for each material. For weft or patterned fabrics see specific pages

	Mtl. 4.10 h. 1.40 Each
--	------------------------

Frame finishes

Metal

MI	WHITE BB , BROWN E6 , SAND EC , GRAPHITE EG , BLACK EN
-----------	---

Seat and Back finishes

Upholstery

TA	FAUX LEATHER Secret , FABRIC Mirage , FABRIC Cotton Club	TB	FAUX LEATHER Vintage , FABRIC Fenix Wool , FABRIC Novabuk , FABRIC Manhattan , FABRIC Visual
TC	VELVET SUPERB, FABRIC Second , FABRIC Main Line Flax , FABRIC Oceanic	TD	FABRIC Yoredale , FABRIC Remix 3
TE	FABRIC Uniform Melange		

Optionals:

		Value	Options/notes
FM-M2	Indoor matt metal M2	+ 61 €	ASH GREY ES , BRONZE E2 , BULGARO RED FP , CHERRY RED EQ , DARK GREEN EL , FACEPOWDER PINK E8 , FANGO E3 , GOLDEN YELLOW EO , LIGHT BLUE EO , LIGHT GREY ET , OCEAN BLUE E1 , OCHER YELLOW E7 , PAPAYA ORANGE EA , PASTEL YELLOW E4 , PINE GREEN EJ , RED ER , SAGE GREEN E9
FM-M4	Indoor glossy Metal M4	+ 188 €	BLACK NICKEL DZ , CHAMPAGNE GOLD DG , GOLDEN BRONZE DB , MATT BLACK NICKEL DY , MATT GOLDEN BRONZE DC , PINK GOLD DR
ES-1	Fireproof foam	+ 44 €	ES-1

Qua-ndo P

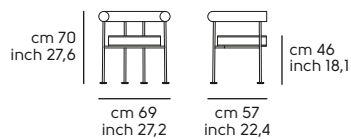

Qua-ndo AP

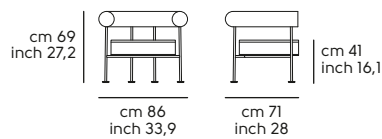

Qua-ndo DV

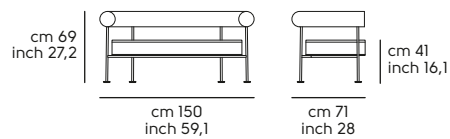

S1 design Paola Navone

S1 - Chair in fabric or leather upholstered

Frame with bases in: upholstered metal , Feet available in two heights H.35 - H.100

Model	Code	Mod.	Metal Feet	Upholstery									Optional	Q.ty	boxes	Kg	M ³
				TA	TB	TC	TD	TE	SF	SV	COM	COL					
	S2180SB	S	MI	473 €	515 €	579 €	622 €	771 €	671 €	793 €	473 €	579 €	ZP-A0 FM-M2 FM-M4	2	1	16.0	0.41

COM/COL - Minimum Q.ty 6 pc. for each material. For weft or patterned fabrics see specific pages

COM	Mtl. 1.85 h. 1.40 Each	COL	Mq. 2.60 Each														
	S2180SO	M	MI	494 €	538 €	610 €	654 €	802 €	700 €	831 €	494 €	610 €	ZP-A0 FM-M2 FM-M4	2	1	16.5	0.43

COM/COL - Minimum Q.ty 6 pc. for each material. For weft or patterned fabrics see specific pages

COM	Mtl. 1.85 h. 1.40 Each	COL	Mq. 2.60 Each														
	S2180SA	T	MI	503 €	549 €	622 €	666 €	817 €	714 €	844 €	503 €	622 €	ZP-A0 FM-M2 FM-M4	2	1	16.7	0.49

COM/COL - Minimum Q.ty 6 pc. for each material. For weft or patterned fabrics see specific pages

COM	Mtl. 2.10 h. 1.40 Each	COL	Mq. 2.95 Each
-----	------------------------	-----	---------------

Finishes Metal Feet

Metal	
MI	WHITE BB , BROWN E6 , SAND EC , GRAPHITE EG , BLACK EN

Finishes Shell / Pipe

Upholstery			
TA	FAUX LEATHER Secret , FABRIC Mirage , FABRIC Cotton Club	TB	FAUX LEATHER Vintage , FABRIC Fenix Wool , FABRIC Novabuk , FABRIC Manhattan , FABRIC Visual
TC	VELVET SUPERB, FABRIC Second , FABRIC Main Line Flax , FABRIC Oceanic	TD	FABRIC Yoredale , FABRIC Remix 3
TE	FABRIC Uniform Melange	SF	LEATHER Fiore
SV	LEATHER Vintage		

Optionals:

		Value	Options/notes
ZP-A0	Metal Feet H.100	+ 22 €	ZP-A0
FM-M2	Indoor matt metal M2	+ 34 €	ASH GREY ES , BRONZE E2 , BULGARO RED FP , CHERRY RED EQ , DARK GREEN EL , FACEPOWDER PINK E8 , FANGO E3 , GOLDEN YELLOW EO , LIGHT BLUE EO , LIGHT GREY ET , OCEAN BLUE EI , OCHER YELLOW E7 , PAPAYA ORANGE EA , PASTEL YELLOW E4 , PINE GREEN EJ , RED ER , SAGE GREEN E9
FM-M4	Indoor glossy Metal M4	+ 49 €	BLACK NICKEL DZ , CHAMPAGNE GOLD DG , GOLDEN BRONZE DB , MATT BLACK NICKEL DY , MATT GOLDEN BRONZE DC , PINK GOLD DR

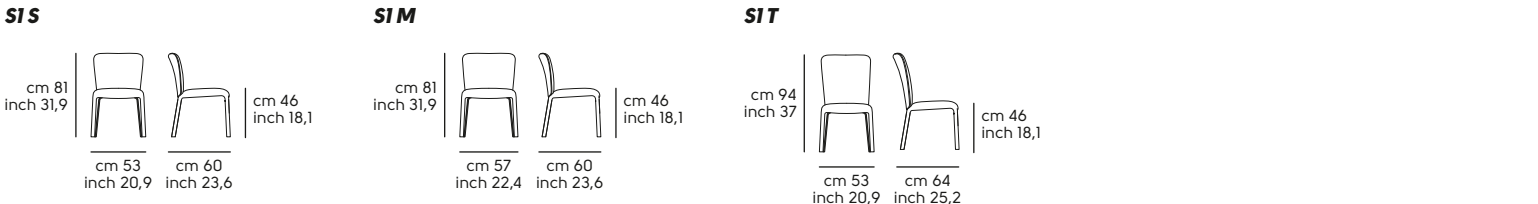

Silvy design Midj R&D

Silvy SB, SBR; SA, SAR - Shell in hide, fabric or leather

Frame in: metal or upholstered

Model	Code	Mod.	Frame	Shell	Optional	Q.ty	boxes	Kg	M ³
CU									
Chair SILVY SB M CU 	S1490MC	SB	M1	284 €	FM-M3 ES-1	2	1	9.0	0.31

Model	Code	Mod.	Frame	TA	TB	TC	TD	TE	SF	SV	COM	COL	Optional	Q.ty	boxes	Kg	M ³
Chair SILVY SB M TS 	S1490MT	SB	M1	203 €	222 €	266 €	293 €	391 €	299 €	354 €	203 €	266 €	FM-M3 ES-1	2	1	9.0	0.33



COM/COL - Minimum Q.ty 6 pc. for each material. For weft or patterned fabrics see specific pages

COM 	Mtl. 1.00 h. 1.40 Each	COL 	Mq. 1.65 Each
--	------------------------	---	---------------

Model	Code	Mod.	--	Upholstery	Optional	Q.ty	boxes	Kg	M ³
CU									
Chair SILVY SB R_CU 	S1490SC	SB		300 €	ES-1	2	1	9.0	0.31

Model	Code	Mod.	Frame	TA	TB	TC	TD	TE	SF	SV	COM	COL	Optional	Q.ty	boxes	Kg	M ³
Chair SILVY SB R_TS 	S1490ST	SB		223 €	251 €	317 €	322 €	428 €	356 €	402 €	223 €	317 €	ES-1	2	1	9.0	0.33



COM/COL - Minimum Q.ty 6 pc. for each material. For weft or patterned fabrics see specific pages

COM 	Mtl. 1.00 h. 1.40 Each	COL 	Mq. 1.70 Each
--	------------------------	---	---------------

Model	Code	Mod.	Frame	Shell								Optional	Q.ty	boxes	Kg	M ³
CU																
 Chair SILVY SA M CU	S1490RC	SA	M1	301 €								FM-M3 ES-1	2	1	9.0	0.35

Model	Code	Mod.	Frame	TA	TB	TC	TD	TE	SF	SV	COM	COL	Optional	Q.ty	boxes	Kg	M ³
 Chair SILVY SA M TS	S1490RT	SA	M1	222 €	240 €	292 €	321 €	427 €	317 €	382 €	222 €	292 €	FM-M3 ES-1	2	1	9.0	0.35



COM/COL - Minimum Q.ty 6 pc. for each material. For weft or patterned fabrics see specific pages

 Mtl. 1.10 h. 1.40 Each	 Mq. 1.39 Each
--	---

Model	Code	Mod.	--	Upholstery								Optional	Q.ty	boxes	Kg	M ³
CU																
 Chair SILVY SA R CU	S1490UC	SA		334 €								ES-1	2	1	9.0	0.35

Model	Code	Mod.	--	TA	TB	TC	TD	TE	SF	SV	COM	COL	Optional	Q.ty	boxes	Kg	M ³
 Chair SILVY SA R TS	S1490UT	SA		249 €	272 €	323 €	349 €	456 €	368 €	417 €	249 €	323 €	ES-1	2	1	9.0	0.35

COM/COL - Minimum Q.ty 6 pc. for each material. For weft or patterned fabrics see specific pages

 Mtl. 1.10 h. 1.40 Each	 Mq. 1.73 Each
--	---

Frame finishes

Metal

MI	WHITE BB , BROWN E6 , SAND EC , GRAPHITE EG , BLACK EN
-----------	---

Shell finishes

Upholstery

TA	FAUX LEATHER Secret , FABRIC Mirage , FABRIC Cotton Club	TB	FAUX LEATHER Vintage , FABRIC Fenix Wool , FABRIC Novabuk , FABRIC Manhattan , FABRIC Visual
TC	VELVET SUPERB, FABRIC Second , FABRIC Main Line Flax , FABRIC Oceanic	TD	FABRIC Yoredale , FABRIC Remix 3
TE	FABRIC Uniform Melange	SF	LEATHER Fiore
SV	LEATHER Vintage	CU	HIDE

Optionals:			
		Value	Options/notes
FM-M3	Indoor glossy metal M3	+ 20 €	CHROME CC
ES-1	Fireproof foam	+ 7 €	ES-1

Silvy SB

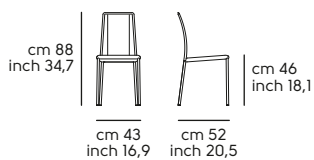

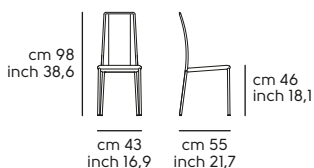

Silvy SA



Silvy H65-H75 - Shell in hide, fabric or leather

Frame in: metal

Model	Code	Mod.	Frame	Shell	Optional	Q.ty	boxes	Kg	M³
CU									
Stool SILVY H65 M CU 	S1490IC	H65	MI	309 €	FM-M3 ES-1	2	1	9.0	0.27
Stool SILVY H75 M CU 	S1490KC	H75	MI	320 €	FM-M3 ES-1	2	1	10.0	0.29

				TA	TB	TC	TD	TE	SF	SV	COM	COL					
Stool SILVY H65 M TS 	S1490IT	H65	MI	248 €	272 €	292 €	302 €	360 €	306 €	358 €	248 €	292 €	FM-M3 ES-1	2	1	9.0	0.28
Stool SILVY H75 M TS 	S1490KT	H75	MI	260 €	286 €	306 €	314 €	373 €	317 €	371 €	260 €	306 €	FM-M3 ES-1	2	1	10.0	0.29

Frame finishes

Metal

MI	WHITE BB , BROWN E6 , SAND EC , GRAPHITE EG , BLACK EN
-----------	---

Shell finishes

Upholstery

TA	FAUX LEATHER Secret , FABRIC Mirage , FABRIC Cotton Club	TB	FAUX LEATHER Vintage , FABRIC Fenix Wool , FABRIC Novabuk , FABRIC Manhattan , FABRIC Visual
TC	VELVET SUPERB, FABRIC Second , FABRIC Main Line Flax , FABRIC Oceanic	TD	FABRIC Yoredale , FABRIC Remix 3
TE	FABRIC Uniform Melange	SF	LEATHER Fiore
SV	LEATHER Vintage	CU	HIDE

COM/COL - Minimum Q.ty 6 pc. for each material. For weft or patterned fabrics see specific pages

COM 	Mtl. 0.60 h. 1.40 Each	COL 	Mq. 1.04 Each
---	------------------------	---	---------------

Optionals:

		Value	Options/notes
FM-M3	Indoor glossy metal M3	+ 20 €	CHROME CC
ES-1	Fireproof foam	+ 7 €	ES-1

Silvy H65

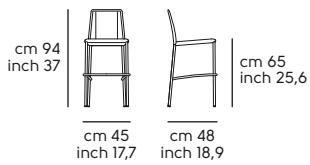



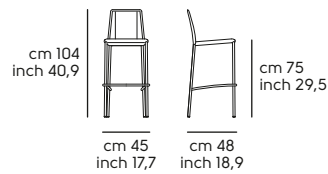



Silvy H75



Slim design Paolo Vernier

Slim S, H65-75 - Metal seat and back

Frame in: metal

Model	Code	Mod.	--	Frame				Optional	Q.ty	boxes	Kg	M ³
				M1	M2	O1	O2					
Chair SLIM S M 	SI73ISO	S		205 €	265 €	315 €	375 €		2 4	1 1	14.0 29.0	0.27 0.44
  												
Stool SLIM H65 M 	SI73IH0	H65		265 €	332 €	375 €	442 €		1	1	17.0	0.34
Stool SLIM H75 M 	SI73IJ0	H75		277 €	344 €	387 €	455 €		1	1	20.0	0.37

Frame finishes

Metal

M1	WHITE BB , INDUSTRIAL E5 , BROWN E6 , SAND EC , GRAPHITE EG , BLACK EN
M2	LIGHT BLUE E0 , OCEAN BLUE E1 , BRONZE E2 , FANGO E3 , PASTEL YELLOW E4 , OCHER YELLOW E7 , FACEPOWDER PINK E8 , SAGE GREEN E9 , PAPAYA ORANGE EA , PINE GREEN EJ , DARK GREEN EL , GOLDEN YELLOW EO , CHERRY RED EQ , RED ER , ASH GREY ES , LIGHT GREY ET , BULGARO RED FP

Outdoor Metal

O1	Outdoor BROWN E6 , Outdoor WHITE BB , Outdoor SAND EC , Outdoor GRAFITE EG , Outdoor BLACK EN
O2	Outdoor LIGHT BLUE E0 , Outdoor OCEAN BLUE E1 , Outdoor BRONZE E2 , Outdoor FANGO E3 , Outdoor PASTEL YELLOW E4 , Outdoor OCHER YELLOW E7 , Outdoor FACEPOWDER PINK E8 , Outdoor SAGE GREEN E9 , Outdoor PINE GREEN EJ , Outdoor DARK GREEN EL , Outdoor GOLD YELLOW EO , Outdoor RED BULGARO FP , Outdoor CHERRY RED EQ , Outdoor RED ER , Outdoor ASH GREY ES , Outdoor LIGHT GREY ET , Outdoor PAPAYA ORANGE EA

Slim S

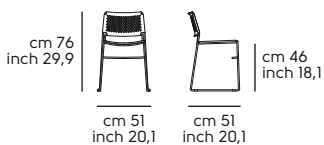

Slim H65

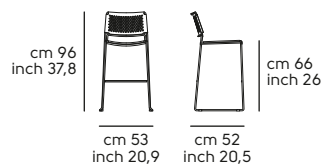



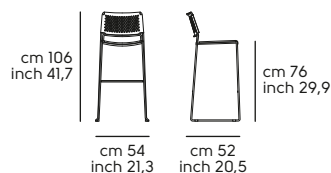









Slim H75



Slim S, H65-75 - Seat and back in hide, fabric or leather

Frame in: metal

Model	Code	Mod.	Frame	Seat and Backrest										Optional	Q.ty	boxes	Kg	M³
				CU					CT									
Chair SLIM S M CU																		
	S1730SC	S	M1	376 €					469 €					FM-M2 FM-M4 ES-1	2 4	1 1	14.0 29.0	0.27 0.44
																		
Chair SLIM S M TS																		
	S1730ST	S	M1	TA	TB	TC	TD	TE	SF	SV	COM	COL	FM-M2 FM-M4 ES-1	2 4	1 1	14.0 29.0	0.27 0.44	
				284 €	314 €	347 €	362 €	415 €	402 €	448 €	284 €	347 €						
Stool SLIM H65 M CU																		
	S1730HC	H65	M1	417 €					512 €					FM-M2 FM-M4 ES-1	1	1	8.5	0.25
																		
Stool SLIM H75 M CU																		
	S1730JC	H75	M1	431 €					527 €					FM-M2 FM-M4 ES-1	1	1	10.0	0.28
																		
Stool SLIM H65 M TS																		
	S1730HT	H65	M1	TA	TB	TC	TD	TE	SF	SV	COM	COL	FM-M2 FM-M4 ES-1	1	1	8.5	0.25	
				334 €	365 €	401 €	418 €	468 €	434 €	471 €	334 €	401 €						
Stool SLIM H75 M TS																		
	S1730JT	H75	M1	TA	TB	TC	TD	TE	SF	SV	COM	COL	FM-M2 FM-M4 ES-1	1	1	10.0	0.28	
				347 €	377 €	415 €	432 €	481 €	445 €	486 €	347 €	415 €						



Frame finishes

Metal	
MI	WHITE BB , INDUSTRIAL E5 , BROWN E6 , SAND EC , GRAPHITE EG , BLACK EN

Seat and Back finishes

Upholstery			
TA	FAUX LEATHER Secret , FABRIC Mirage , FABRIC Cotton Club	TB	FAUX LEATHER Vintage , FABRIC Fenix Wool , FABRIC Novabuk , FABRIC Manhattan , FABRIC Visual
TC	VELVET SUPERB, FABRIC Second , FABRIC Main Line Flax , FABRIC Oceanic	TD	FABRIC Yoredale , FABRIC Remix 3
TE	FABRIC Uniform Melange	SF	LEATHER Fiore
SV	LEATHER Vintage	CU	HIDE
CT	TUSCAN HIDE		

COM/COL - Minimum Q.ty 6 pc. for each material. For weft or patterned fabrics see specific pages

 COM	Mtl. 0.70 h. 1.40 Each	 COL	Mq. 1.11 Each
---	------------------------	--	---------------

Optionals:

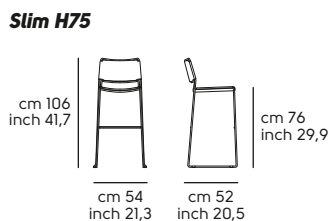
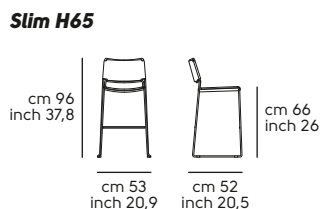
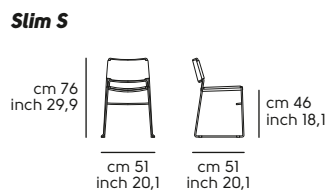

		Value	Options/notes
FM-M2	Indoor matt metal M2	+ 45 €	ASH GREY ES , BRONZE E2 , BULGARO RED FP , CHERRY RED EQ , DARK GREEN EL , FACEPOWDER PINK E8 , FANGO E3 , GOLDEN YELLOW EO , LIGHT BLUE EO , LIGHT GREY ET , OCEAN BLUE E1 , OCHER YELLOW E7 , PAPAYA ORANGE EA , PASTEL YELLOW E4 , PINE GREEN EJ , RED ER , SAGE GREEN E9
FM-M4	Indoor glossy Metal M4	+ 78 €	BLACK NICKEL DZ , CHAMPAGNE GOLD DG , GOLDEN BRONZE DB , MATT BLACK NICKEL DY , MATT GOLDEN BRONZE DC , PINK GOLD DR
ES-1	Fireproof foam	+ 6 €	ES-1



Soffio design Carlesi e Tonelli Studio

Soffio S - Completely upholstered in fabric or leather

Frame in: metal upholstered

Model	Code	Mod.	--	Upholstery								Optional	Q.ty	boxes	Kg	M ³	
				TA	TB	TC	TD	TE	SF	SV	COM						COL
 Chair SOFFIO S_R TS 	SI510ST	S		311 €	336 €	391 €	415 €	527 €	480 €	582 €	311 €	391 €	ES-1	2	1	18.0	0.38

Finishes

Upholstery

TA	FAUX LEATHER Secret , FABRIC Mirage , FABRIC Cotton Club	TB	FAUX LEATHER Vintage , FABRIC Fenix Wool , FABRIC Novabuk , FABRIC Manhattan , FABRIC Visual
TC	VELVET SUPERB, FABRIC Second , FABRIC Main Line Flax , FABRIC Oceanic	TD	FABRIC Yoredale , FABRIC Remix 3
TE	FABRIC Uniform Melange	SF	LEATHER Fiore
SV	LEATHER Vintage		

COM/COL - Minimum Q.ty 6 pc. for each material. For weft or patterned fabrics see specific pages

 COM	Mtl. 1.15 h. 1.40 Each	 COL	Mq. 1.89 Each
--	------------------------	--	---------------

Optionals:

		Value	Options/notes
ES-1	Fireproof foam	+ 12 €	ES-1



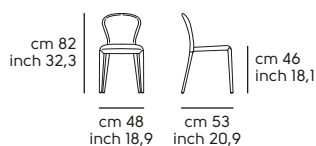



Soffio S



Sonny design Midj R&D

Sonny S - Shell in fabric or leather

Frame in: metal or wood

Model	Code	Base type	Frame	Shell									Optional	Q.ty	boxes	Kg	M ³
				TA	TB	TC	TD	TE	SF	SV	COM	COL					
Chair SONNY S M TS_M 	S1521MT_M	_M	M1	308 €	361 €	439 €	467 €	523 €	505 €	600 €	308 €	439 €	FM-M2 FM-M3 FM-M4 PD-FO	1	1	7.0	0.29
Chair SONNY S M TS_Q 	S1521MT_Q	_Q	M1	358 €	411 €	489 €	517 €	573 €	555 €	650 €	358 €	489 €	FM-M2 PD-FO	1	1	9.5	0.29
Chair SONNY S L TS_R  <small>CATAS EN1728</small>	S1521WL_R	_R	LFI	384 €	439 €	516 €	545 €	600 €	582 €	678 €	384 €	516 €	PD-FO	1	1	7.5	0.28
Chair SONNY S L TS_N 	S1521WL_N	_N	LII	487 €	542 €	619 €	648 €	703 €	685 €	781 €	487 €	619 €	FL-I2 PD-FO	1	1	7.5	0.28
Chair SONNY S MX TS 	S1520FX	MX	M1	500 €	555 €	633 €	662 €	717 €	697 €	794 €	500 €	633 €	FM-M2	1	1	11.0	0.28
Chair with self-return SONNY S X47 TS 	S1521YS	X47	M1	530 €	587 €	664 €	692 €	748 €	728 €	824 €	530 €	664 €	FM-M2	1	1	10.5	0.25
Office Chair SONNY DS TS 	S1520DT	DS	M1	539 €	592 €	669 €	698 €	753 €	736 €	833 €	539 €	669 €	FM-M2	1	2	11.0	0.26

Note:

TS Front and Back covering available in two-tone or bi-material. Reference price in the upper category

Frame finishes

Metal

MI	WHITE BB , BROWN E6 , SAND EC , GRAPHITE EG , BLACK EN
-----------	---

Wood



LFI	Ash wood painted GREY F02 , Ash wood painted GRAFITE GREY F03 , Ash wood painted BLACK F04 , Ash wood painted WHITE F05 , Ash wood painted BLUE F06 , Ash wood painted RED F08 , Ash wood painted CHERRY RED F09 , Ash wood painted FLAMED WALNUT F24 , Ash wood painted DARK BROWN F26 , Ash wood painted NATURAL F40 , Ash wood painted NATURAL OAK F52
LII	Veneered wood painted GREY I02 , Veneered wood painted GRAFITE GREY I03 , Veneered wood painted BLACK I04 , Veneered wood painted WHITE I05 , Veneered wood painted BLUE I06 , Veneered wood painted RED I08 , Veneered wood painted CHERRY RED I09 , Veneered wood painted DARK BROWN I26 , Veneered wood painted NATURAL I40 , Veneered wood painted NATURAL OAK I52

Shell finishes

Upholstery

TA	FAUX LEATHER Secret , FABRIC Mirage , FABRIC Cotton Club	TB	FAUX LEATHER Vintage , FABRIC Fenix Wool , FABRIC Novabuk , FABRIC Manhattan , FABRIC Visual
TC	VELVET SUPERB, FABRIC Second , FABRIC Main Line Flax , FABRIC Oceanic	TD	FABRIC Yoredale , FABRIC Remix 3
TE	FABRIC Uniform Melange	SF	LEATHER Fiore
SV	LEATHER Vintage		

COM/COL - Minimum Q.ty 6 pc. for each material. For weft or patterned fabrics see specific pages

COM 	Mtl. 1.10 h. 1.40 Each	COL 	Mq. 2.02 Each
--	------------------------	--	---------------

Optionals:

		Value	Options/notes
FM-M2	Indoor matt metal M2	+ 45 €	ASH GREY ES , BRONZE E2 , BULGARO RED FP , CHERRY RED EQ , DARK GREEN EL , FACEPOWDER PINK E8 , FANGO E3 , GOLDEN YELLOW EO , LIGHT BLUE EO , LIGHT GREY ET , OCEAN BLUE E1 , OCHER YELLOW E7 , PAPAYA ORANGE EA , PASTEL YELLOW E4 , PINE GREEN EJ , RED ER , SAGE GREEN E9
FM-M3	Indoor glossy metal M3	+ 20 €	CHROME CC
FM-M4	Indoor glossy Metal M4	+ 103 €	BLACK NICKEL DZ , CHAMPAGNE GOLD DG , GOLDEN BRONZE DB , MATT BLACK NICKEL DY , MATT GOLDEN BRONZE DC , PINK GOLD DR
FL-I2	Veneered wood finish LI2	+ 8 €	Veneered wood FLAMED WALNUT I24 , Veneered wood NATURAL OAK I22
PD-F0	Felt pad feet	+ 6 €	PD-F0

Sonny S_M

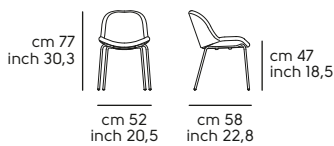

Sonny S_Q

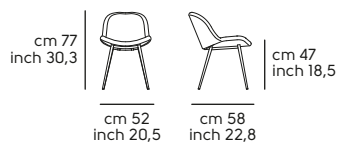

Sonny S_R

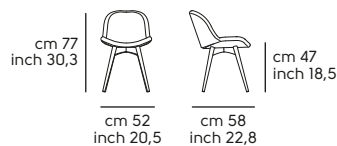

Sonny S_N

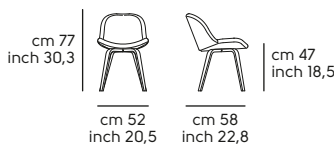

Sonny S_MX

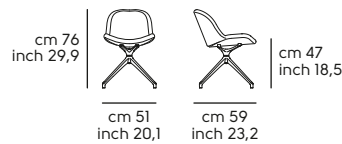

Sonny SX47

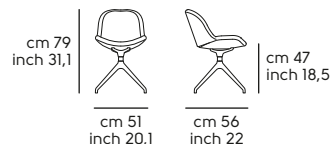



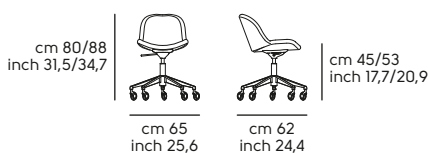







Sonny S_DS



Sonny PB - Shell in fabric or leather

Frame in: metal or wood

Model	Code	Base type	Frame	Shell									Optional	Q.ty	boxes	Kg	M³
				TA	TB	TC	TD	TE	SF	SV	COM	COL					
Armch. SONNY PB M TS_M 	S1521PT_M	_M	MI	371 €	414 €	491 €	506 €	652 €	589 €	725 €	371 €	491 €	FM-M2 FM-M3 FM-M4 PD-FO	1	1	7.0	0.31
Armch. SONNY PB M TS_Q 	S1521PT_Q	_Q	MI	423 €	466 €	543 €	558 €	704 €	641 €	777 €	423 €	543 €	FM-M2 PD-FO	1	1	9.5	0.31
Armch. SONNY PB L TS_R 	S1521PW_R	_R	LFI	447 €	490 €	561 €	583 €	729 €	666 €	801 €	447 €	561 €	PD-FO	1	1	7.0	0.31
Armch. SONNY PB L TS_N 	S1521PW_N	_N	LII	550 €	593 €	664 €	686 €	832 €	769 €	904 €	550 €	664 €	FL-I2 PD-FO	1	1	7.0	0.31
Armch. SONNY PB MX TS  	S1520QY	MX	MI	565 €	608 €	685 €	700 €	845 €	781 €	918 €	565 €	685 €	FM-M2	1	1	12.0	0.32
Armch. with self-return SONNY PB X47 TS  	S1521YQ	X47	MI	595 €	638 €	709 €	731 €	877 €	813 €	948 €	595 €	709 €	FM-M2	1	1	11.35	0.3
Office Arm. SONNY DPB TS  	S1520ET	DPB	MI	662 €	704 €	775 €	797 €	943 €	879 €	1.013 €	662 €	775 €	FM-M2,	1	2	12.0	0.3

Note:
TS Front and Back covering available in two-tone or bi-material. Reference price in the upper category

Frame finishes

Metal

MI	WHITE BB , BROWN E6 , SAND EC , GRAPHITE EG , BLACK EN
-----------	---

Wood



LFI	Ash wood painted GREY F02 , Ash wood painted GRAFITE GREY F03 , Ash wood painted BLACK F04 , Ash wood painted WHITE F05 , Ash wood painted BLUE F06 , Ash wood painted RED F08 , Ash wood painted CHERRY RED F09 , Ash wood painted FLAMED WALNUT F24 , Ash wood painted DARK BROWN F26 , Ash wood painted NATURAL F40 , Ash wood painted NATURAL OAK F52
LII	Veneered wood painted GREY I02 , Veneered wood painted GRAFITE GREY I03 , Veneered wood painted BLACK I04 , Veneered wood painted WHITE I05 , Veneered wood painted BLUE I06 , Veneered wood painted RED I08 , Veneered wood painted CHERRY RED I09 , Veneered wood painted DARK BROWN I26 , Veneered wood painted NATURAL I40 , Veneered wood painted NATURAL OAK I52

Shell finishes

Upholstery

TA	FAUX LEATHER Secret , FABRIC Mirage , FABRIC Cotton Club	TB	FAUX LEATHER Vintage , FABRIC Fenix Wool , FABRIC Novabuk , FABRIC Manhattan , FABRIC Visual
TC	VELVET SUPERB, FABRIC Second , FABRIC Main Line Flax , FABRIC Oceanic	TD	FABRIC Yoredale , FABRIC Remix 3
TE	FABRIC Uniform Melange	SF	LEATHER Fiore
SV	LEATHER Vintage		

COM/COL - Minimum Q.ty 6 pc. for each material. For weft or patterned fabrics see specific pages

COM 	Mtl. 1.50 h. 1.40 Each	COL 	Mq. 2.74 Each
--	------------------------	--	---------------

Optionals:

		Value	Options/notes
FM-M2	Indoor matt metal M2	+ 45 €	ASH GREY ES , BRONZE E2 , BULGARO RED FP , CHERRY RED EQ , DARK GREEN EL , FACEPOWDER PINK E8 , FANGO E3 , GOLDEN YELLOW EO , LIGHT BLUE EO , LIGHT GREY ET , OCEAN BLUE E1 , OCHER YELLOW E7 , PAPAYA ORANGE EA , PASTEL YELLOW E4 , PINE GREEN EJ , RED ER , SAGE GREEN E9
FM-M3	Indoor glossy metal M3	+ 20 €	CHROME CC
FM-M4	Indoor glossy Metal M4	+ 103 €	BLACK NICKEL DZ , CHAMPAGNE GOLD DG , GOLDEN BRONZE DB , MATT BLACK NICKEL DY , MATT GOLDEN BRONZE DC , PINK GOLD DR
FL-I2	Veneered wood finish LI2	+ 8 €	Veneered wood FLAMED WALNUT I24 , Veneered wood NATURAL OAK I22
PD-F0	Felt pad feet	+ 6 €	PD-F0

Sonny PB_M

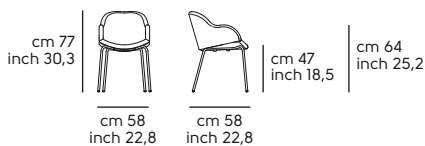

Sonny PB_Q

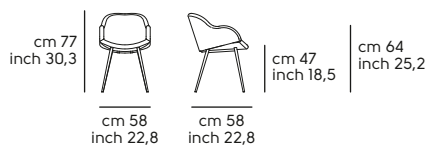

Sonny PB_R

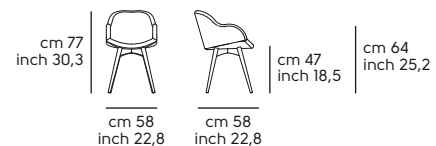

Sonny PB_N

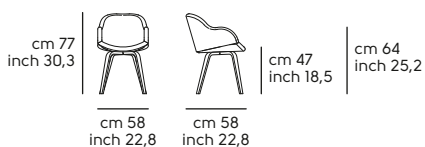

Sonny PB_MX

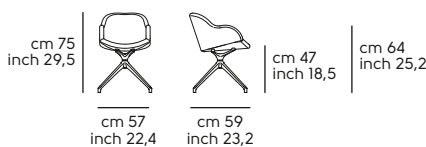

Sonny PB_X47

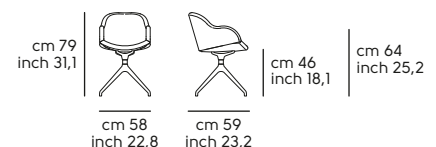















Sonny PB_DPB



Sonny P - Shell in fabric or leather

Frame in: metal or wood

Model	Code	Base type	Frame	Shell									Optional	Q.ty 	boxes 	Kg 	M³ 
				TA	TB	TC	TD	TE	SF	SV	COM	COL					
Armch. SONNY P M TS_M 	S1521GT_M	_M	MI	386 €	462 €	500 €	522 €	667 €	614 €	746 €	386 €	500 €	FM-M2 FM-M3 FM-M4 PD-F0	1	1	7.0	0.31
Armch. SONNY P M TS_Q 	S1521GT_Q	_Q	MI	436 €	512 €	550 €	572 €	717 €	664 €	796 €	436 €	550 €	FM-M2 PD-F0	1	1	10.0	0.31
Armch. SONNY P L TS_R 	S1521QW_R	_R	LFI	475 €	550 €	588 €	610 €	755 €	704 €	836 €	475 €	588 €	PD-F0	1	1	9.5	0.33
Armch. SONNY P L TS_N 	S1521QW_N	_N	LII	566 €	641 €	679 €	701 €	846 €	795 €	927 €	566 €	679 €	FL-I2 PD-F0	1	1	9.5	0.33
Armch. SONNY P MX TS  	S1520GX	MX	MI	579 €	655 €	693 €	714 €	860 €	806 €	939 €	579 €	693 €	FM-M2	1	1	13.0	0.32
Armch. with self-return SONNY P X47 TS  	S1521YP	X47	MI	610 €	686 €	725 €	746 €	890 €	837 €	969 €	610 €	725 €	FM-M2	1	1	11.5	0.3
Office Arm. SONNY DP TS  	S1520ED	DP	MI	676 €	752 €	790 €	834 €	957 €	903 €	1.035 €	676 €	790 €	FM-M2,	1	2	13.0	0.3

Note:

TS Front and Back covering available in two-tone or bi-material. Reference price in the upper category

Frame finishes

Metal

MI	WHITE BB , BROWN E6 , SAND EC , GRAPHITE EG , BLACK EN
-----------	---

Wood



LFI	Ash wood painted GREY F02 , Ash wood painted GRAFITE GREY F03 , Ash wood painted BLACK F04 , Ash wood painted WHITE F05 , Ash wood painted BLUE F06 , Ash wood painted RED F08 , Ash wood painted CHERRY RED F09 , Ash wood painted FLAMED WALNUT F24 , Ash wood painted DARK BROWN F26 , Ash wood painted NATURAL F40 , Ash wood painted NATURAL OAK F52
LII	Veneered wood painted GREY I02 , Veneered wood painted GRAFITE GREY I03 , Veneered wood painted BLACK I04 , Veneered wood painted WHITE I05 , Veneered wood painted BLUE I06 , Veneered wood painted RED I08 , Veneered wood painted CHERRY RED I09 , Veneered wood painted DARK BROWN I26 , Veneered wood painted NATURAL I40 , Veneered wood painted NATURAL OAK I52

Shell finishes

Upholstery

TA	FAUX LEATHER Secret , FABRIC Mirage , FABRIC Cotton Club	TB	FAUX LEATHER Vintage , FABRIC Fenix Wool , FABRIC Novabuk , FABRIC Manhattan , FABRIC Visual
TC	VELVET SUPERB, FABRIC Second , FABRIC Main Line Flax , FABRIC Oceanic	TD	FABRIC Yoredale , FABRIC Remix 3
TE	FABRIC Uniform Melange	SF	LEATHER Fiore
SV	LEATHER Vintage		

COM/COL - Minimum Q.ty 6 pc. for each material. For weft or patterned fabrics see specific pages

 COM	Mtl. 1.50 h. 1.40 Each	 COL	Mq. 2.60 Each
---	------------------------	---	---------------

Optionals:

		Value	Options/notes
FM-M2	Indoor matt metal M2	+ 45 €	ASH GREY ES , BRONZE E2 , BULGARO RED FP , CHERRY RED EQ , DARK GREEN EL , FACEPOWDER PINK E8 , FANGO E3 , GOLDEN YELLOW EO , LIGHT BLUE EO , LIGHT GREY ET , OCEAN BLUE E1 , OCHER YELLOW E7 , PAPAYA ORANGE EA , PASTEL YELLOW E4 , PINE GREEN EJ , RED ER , SAGE GREEN E9
FM-M3	Indoor glossy metal M3	+ 20 €	CHROME CC
FM-M4	Indoor glossy Metal M4	+ 103 €	BLACK NICKEL DZ , CHAMPAGNE GOLD DG , GOLDEN BRONZE DB , MATT BLACK NICKEL DY , MATT GOLDEN BRONZE DC , PINK GOLD DR
FL-I2	Veneered wood finish LI2	+ 8 €	Veneered wood FLAMED WALNUT I24 , Veneered wood NATURAL OAK I22
PD-F0	Felt pad feet	+ 6 €	PD-F0

Sonny P_M

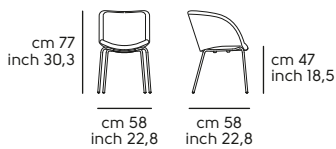

Sonny P_Q

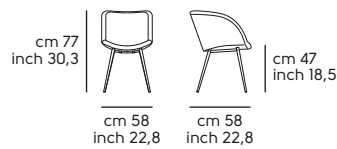

Sonny P_R

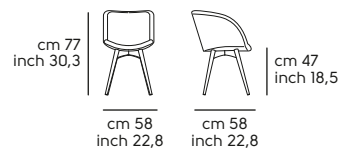

Sonny P_N

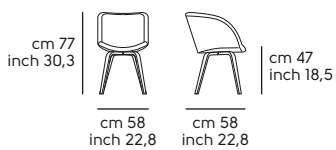

Sonny P_MX

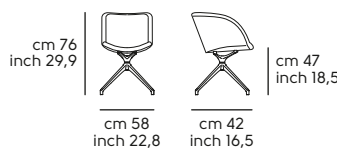

Sonny P_X47

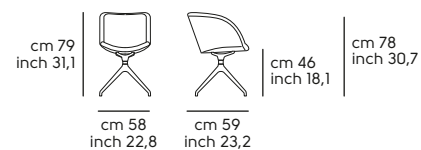

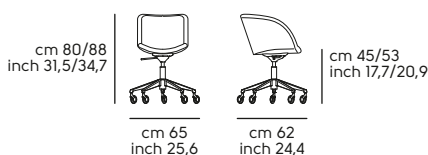

Sonny P_DP



Sonny H65-75 - Shell in fabric or leather

Frame in: metal

Model	Code	Mod.	Frame	Shell									Optional	Q.ty 	boxes 	Kg 	M³
				TA	TB	TC	TD	TE	SF	SV	COM	COL					
 Stool SONNY H65 M TS	S1520IT	H65	MI	446 €	501 €	578 €	605 €	660 €	644 €	739 €	446 €	578 €	FM-M2 PD-F0	1	1	9.5	0.34
 Stool SONNY H75 M TS	S1520KT	H75	MI	461 €	515 €	592 €	620 €	675 €	658 €	753 €	461 €	592 €	FM-M2 PD-F0	1	1	10.0	0.38

Note:

TS Front and Back covering available in two-tone or bi-material. Reference price in the upper category

Frame finishes

Metal



MI	WHITE BB , BROWN E6 , SAND EC , GRAPHITE EG , BLACK EN
-----------	---

Shell finishes

Upholstery

TA	FAUX LEATHER Secret , FABRIC Mirage , FABRIC Cotton Club	TB	FAUX LEATHER Vintage , FABRIC Fenix Wool , FABRIC Novabuk , FABRIC Manhattan , FABRIC Visual
TC	VELVET SUPERB, FABRIC Second , FABRIC Main Line Flax , FABRIC Oceanic	TD	FABRIC Yoredale , FABRIC Remix 3
TE	FABRIC Uniform Melange	SF	LEATHER Fiore
SV	LEATHER Vintage		

COM/COL - Minimum Q.ty 6 pc. for each material. For weft or patterned fabrics see specific pages

 COM	Mtl. 1.10 h. 1.40 Each	 COL	Mq. 2.02 Each
---	------------------------	--	---------------

Optionals:

	Value	Options/notes
FM-M2	+ 45 €	INDOOR MATT METAL M2
PD-F0	+ 6 €	PD-F0

Sonny H65

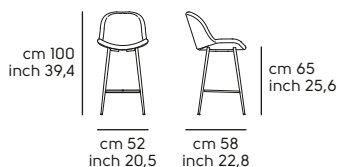

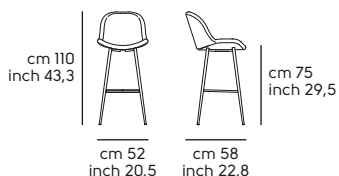

Sonny H75



Sonny H65-75 - Shell in fabric or leather

Frame in: wood

Model	Code	Mod.	Frame	Shell									Optional	Q.ty	boxes	Kg	M³
				TA	TB	TC	TD	TE	SF	SV	COM	COL					
 Stool SONNY H65 LR TS	S1520IW	H65	LF1	512 €	567 €	644 €	671 €	727 €	710 €	805 €	512 €	644 €	PD-F0	1	1	8.9	0.3
 Stool SONNY H75 LR TS	S1520KW	H75	LF1	531 €	586 €	663 €	690 €	746 €	729 €	823 €	531 €	663 €	PD-F0	1	1	10.15	0.33

Note:

TS Front and Back covering available in two-tone or bi-material. Reference price in the upper category

Frame finishes

Wood

LF1	Ash wood painted GREY F02 , Ash wood painted GRAFITE GREY F03 , Ash wood painted BLACK F04 , Ash wood painted WHITE F05 , Ash wood painted BLUE F06 , Ash wood painted RED F08 , Ash wood painted CHERRY RED F09 , Ash wood painted FLAMED WALNUT F24 , Ash wood painted DARK BROWN F26 , Ash wood painted NATURAL F40 , Ash wood painted NATURAL OAK F52
------------	--

Shell finishes

Upholstery

TA	FAUX LEATHER Secret , FABRIC Mirage , FABRIC Cotton Club	TB	FAUX LEATHER Vintage , FABRIC Fenix Wool , FABRIC Novabuk , FABRIC Manhattan , FABRIC Visual
TC	VELVET SUPERB, FABRIC Second , FABRIC Main Line Flax , FABRIC Oceanic	TD	FABRIC Yoredale , FABRIC Remix 3
TE	FABRIC Uniform Melange	SF	LEATHER Fiore
SV	LEATHER Vintage		

COM/COL - Minimum Q.ty 6 pc. for each material. For weft or patterned fabrics see specific pages

COM	Mtl. 1.10 h. 1.40 Each	COL	Mq. 2.02 Each
------------	------------------------	------------	---------------

Optionals:

	Value	Options/notes
PD-F0	Felt pad feet	+ 6 € PD-F0

Sonny H65 LR

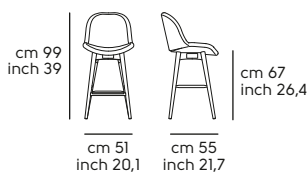

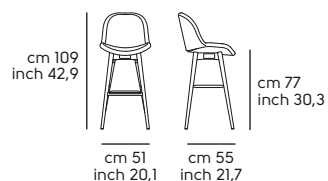

Sonny H75 LR



Sonny SG - Shell in fabric or leather

Frame in: metal

Model	Code	Mod.	Frame	Shell									Optional	Q.ty	boxes	Kg	M³
				TA	TB	TC	TD	TE	SF	SV	COM	COL					
 Stool SONNY SG	S1520ZT	SG	M3	559 €	613 €	690 €	718 €	773 €	756 €	852 €	559 €	690 €		1	1	17.0	0.32
 Stool SONNY SG_YD	S1520ZT	SG_YD	MI	711 €	765 €	842 €	870 €	925 €	908 €	1.004 €	711 €	842 €	FM-M2	1	1	17.7	0.29

Note:
TS Front and Back covering available in two-tone or bi-material. Reference price in the upper category

Frame finishes

Metal

M3	CHROME CC
-----------	-----------

Frame finishes

Metal

MI	WHITE BB, BROWN E6, SAND EC, GRAPHITE EG, BLACK EN
-----------	--

Shell finishes

Upholstery

TA	FAUX LEATHER Secret, FABRIC Mirage, FABRIC Cotton Club	TB	FAUX LEATHER Vintage, FABRIC Fenix Wool, FABRIC Novabuk, FABRIC Manhattan, FABRIC Visual
TC	VELVET SUPERB, FABRIC Second, FABRIC Main Line Flax, FABRIC Oceanic	TD	FABRIC Yoredale, FABRIC Remix 3
TE	FABRIC Uniform Melange	SF	LEATHER Fiore
SV	LEATHER Vintage		

COM/COL - Minimum Q.ty 6 pc. for each material. For weft or patterned fabrics see specific pages

COM	Mtl. 1.10 h. 1.40 Each	COL	Mq. 2.02 Each
------------	------------------------	------------	---------------

Optionals:

	Value	Options/notes
FM-M2	+ 56 €	INDOOR MATT METAL M2 ASH GREY ES, BRONZE E2, BULGARO RED FP, CHERRY RED EQ, DARK GREEN EL, FACEPOWDER PINK E8, FANGO E3, GOLDEN YELLOW EO, LIGHT BLUE E0, LIGHT GREY ET, OCEAN BLUE EI, OCHER YELLOW E7, PAPAYA ORANGE EA, PASTEL YELLOW E4, PINE GREEN EJ, RED ER, SAGE GREEN E9

Sonny SG

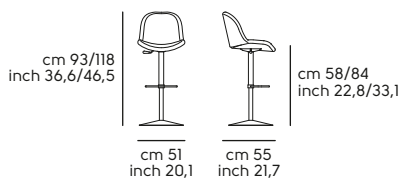

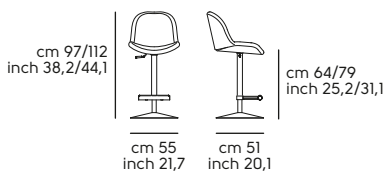

Sonny SG_YD





Star design Midj R&D

Star S, DSB, DSA, DPB, DPA - Shell in fabric or leather

Frame in: metal



Model	Code	Mod.	Frame	Shell								Optional	Q.ty	boxes	Kg	M ³	
				TA	TB	TC	TD	TE	SF	SV	COM						COL
  	S1180SO	S	MI	203 €	234 €	268 €	276 €	369 €	350 €	427 €	203 €	268 €	FM-M2 FM-M3 ES-1 PD-F0	2 4	1 1	14.5 27.0	0.35 0.53

COM/COL - Minimum Q.ty 6 pc. for each material. For weft or patterned fabrics see specific pages

 Mtl. 0.80 h. 1.40 Each	 Mq. 1.43 Each
--	---



Model	Code	Mod.	Frame	Shell								Optional	Q.ty	boxes	Kg	M ³	
				TA	TB	TC	TD	TE	SF	SV	COM						COL
  	S1180DB	DSB	MI	316 €	347 €	384 €	390 €	466 €	455 €	522 €	316 €	384 €	FM-M2 FM-M3 ES-1 PD-D1	1	2	11.0	0.2
				  	S1180EB	DPB	MI	378 €	410 €	445 €	450 €	528 €	515 €	585 €	378 €	445 €	FM-M2 FM-M3 ES-1 PD-D1

COM/COL - Minimum Q.ty 6 pc. for each material. For weft or patterned fabrics see specific pages

 Mtl. 0.80 h. 1.40 Each	 Mq. 1.71 Each
--	---

Model	Code	Mod.	Frame	Shell								Optional	Q.ty	boxes	Kg	M ³	
				TA	TB	TC	TD	TE	SF	SV	COM						COL
  	S1180DA	DSA	MI	349 €	392 €	431 €	446 €	517 €	499 €	541 €	349 €	431 €	FM-M2 FM-M3 ES-1 PD-D1	1	2	12.0	0.25
				  	S1180EA	DPA	MI	411 €	455 €	492 €	506 €	579 €	561 €	599 €	411 €	492 €	FM-M2 FM-M3 ES-1 PD-D1

COM/COL - Minimum Q.ty 6 pc. for each material. For weft or patterned fabrics see specific pages

 Mtl. 0.99 h. 1.40 Each	 Mq. 2.54 Each
--	---

Frame finishes

Metal	
MI	WHITE BB , BROWN E6 , SAND EC , GRAPHITE EG , BLACK EN

Shell finishes

Upholstery			
TA	FAUX LEATHER Secret , FABRIC Mirage , FABRIC Cotton Club	TB	FAUX LEATHER Vintage , FABRIC Fenix Wool , FABRIC Novabuk , FABRIC Manhattan , FABRIC Visual
TC	VELVET SUPERB, FABRIC Second , FABRIC Main Line Flax , FABRIC Oceanic	TD	FABRIC Yoredale , FABRIC Remix 3
TE	FABRIC Uniform Melange	SF	LEATHER Fiore
SV	LEATHER Vintage		

Options:

		Value	Options/notes
FM-M2	Indoor matt metal M2	+ 45 €	ASH GREY ES , BRONZE E2 , BULGARO RED FP , CHERRY RED EQ , DARK GREEN EL , FACEPOWDER PINK E8 , FANGO E3 , GOLDEN YELLOW EO , LIGHT BLUE E0 , LIGHT GREY ET , OCEAN BLUE EI , OCHER YELLOW E7 , PAPAYA ORANGE EA , PASTEL YELLOW E4 , PINE GREEN EJ , RED ER , SAGE GREEN E9
FM-M3	Indoor glossy metal M3	+ 20 €	CHROME CC
ES-1	Fireproof foam	+ 6 €	ES-1
PD-F0	Felt pad feet	+ 6 €	PD-F0
PD-D1	Set Feet Office Chair D1	+ 6 €	PD-D1

Star S

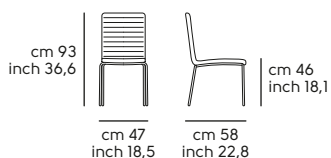

Star DSB

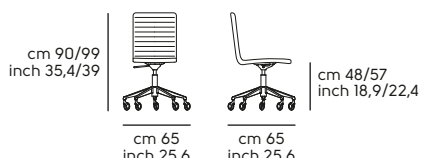

Star DPB

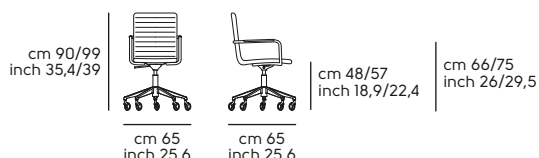

Star DSA

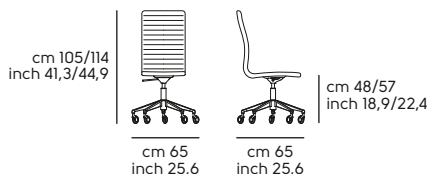



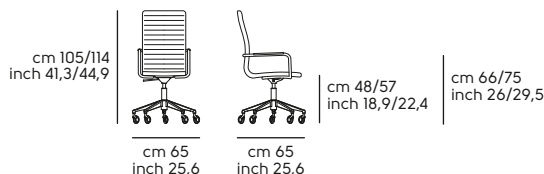



Star DPA



Strike design Ateliernanni

Strike S, P, S_H65-75, P_H65-75 - Metal Back

Frame in: wood

Model	Code	Mod.	Frame and Seat	Back		Optional	G.ty	boxes	Kg	M³
				M1	M2					
Chair STRIKE S L 	S1740S0	S	LF1	460 €	511 €		2	1	12.0	0.3
Armch. STRIKE P L 	S1740P0	P	LF1	481 €	533 €		1	1	6.5	0.3
Stool STRIKE S H65 L 	S1740IS	S65	LF1	531 €	600 €		1	1	8.0	0.3
Stool STRIKE S H75 L 	S1740KS	S75	LF1	544 €	614 €		1	1	8.0	0.34
Stool STRIKE P H65 L 	S1740IP	P65	LF1	550 €	603 €		1	1	8.0	0.37
Stool STRIKE P H75 L 	S1740KP	P75	LF1	565 €	616 €		1	1	8.0	0.37

Seat and Frame finishes

Wood

LF1 Ash wood painted GREY **F02**, Ash wood painted GRAFITE GREY **F03**, Ash wood painted BLACK **F04**, Ash wood painted WHITE **F05**, Ash wood painted BLUE **F06**, Ash wood painted RED **F08**, Ash wood painted CHERRY RED **F09**, Ash wood painted FLAMED WALNUT **F24**, Ash wood painted DARK BROWN **F26**, Ash wood painted NATURAL **F40**, Ash wood painted NATURAL OAK **F52**

Back finishes

Metal

M1 WHITE **BB**, BROWN **E6**, SAND **EC**, GRAPHITE **EG**, BLACK **EN**

M2 LIGHT BLUE **E0**, OCEAN BLUE **E1**, BRONZE **E2**, FANGO **E3**, PASTEL YELLOW **E4**, OCHER YELLOW **E7**, FACEPOWDER PINK **E8**, SAGE GREEN **E9**, PAPAYA ORANGE **EA**, PINE GREEN **EJ**, DARK GREEN **EL**, GOLDEN YELLOW **EO**, CHERRY RED **EQ**, RED **ER**, ASH GREY **ES**, LIGHT GREY **ET**, BULGARO RED **FP**

Strike S

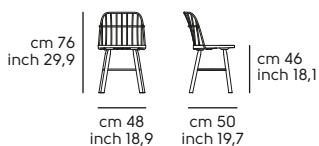

Strike P

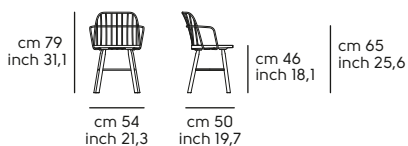

Strike S65

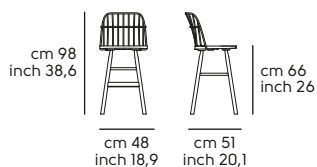

Strike S75

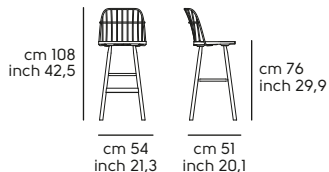

Strike P65

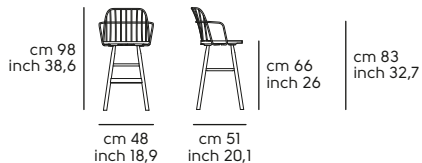

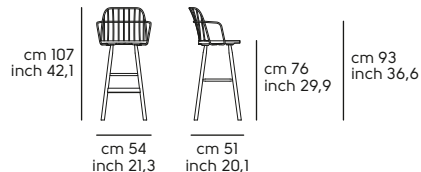

Strike P75



Suite design Ateliernanni

Suite P, AP - Seat and back in hide

Frame in: wood

Model	Code	Mod.	Frame	Seat and Backrest		Optional	Q.ty	boxes	Kg	M ³
				CU	CT					
Armch. SUITE P L CU 	S1750P0	P	LFI	642 €	860 €	PD-F0	1	1	9.5	0.27
Waiting Chair SUITE AP L CU 	S1750AC	AP	LFI	930 €	1.158 €	PD-F0	1	1	10.0	0.4

Frame finishes

Wood

LFI

Ash wood painted GREY **F02**, Ash wood painted GRAFITE GREY **F03**, Ash wood painted BLACK **F04**, Ash wood painted WHITE **F05**, Ash wood painted BLUE **F06**, Ash wood painted RED **F08**, Ash wood painted CHERRY RED **F09**, Ash wood painted FLAMED WALNUT **F24**, Ash wood painted DARK BROWN **F26**, Ash wood painted NATURAL **F40**, Ash wood painted NATURAL OAK **F52**

Shell finishes

Upholstery

CU

HIDE

CT

TUSCAN HIDE

Options:

	Value	Options/notes
PD-F0	Felt pad feet	+ 6 € PD-F0

Suite P



Suite AP

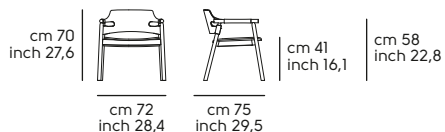

Toy design Studio Pastina

Toy SG - Seat and back in fabric or leather

Frame in: metal

Model	Code	Mod.	Frame	Seat and Backrest									Optional	Q.ty	boxes	Kg	M ³
				TA	TB	TC	TD	TE	SF	SV	COM	COL					
 Stool TOY SG TS	S2130ZT	SG	MI	541 €	553 €	582 €	608 €	699 €	612 €	633 €	541 €	582 €	FM-M2	1	1	17.0	0.2

Note:

Frame finishes

Metal

MI WHITE **BB**, BROWN **E6**, SAND **EC**, GRAPHITE **EG**, BLACK **EN**

Seat and Back finishes

Upholstery

TA	FAUX LEATHER Secret , FABRIC Mirage , FABRIC Cotton Club	TB	FAUX LEATHER Vintage , FABRIC Fenix Wool , FABRIC Novabuk , FABRIC Manhattan , FABRIC Visual
TC	VELVET SUPERB, FABRIC Second , FABRIC Main Line Flax , FABRIC Oceanic	TD	FABRIC Yoredale , FABRIC Remix 3
TE	FABRIC Uniform Melange	SF	LEATHER Fiore
SV	LEATHER Vintage		

COM/COL - Minimum Q.ty 6 pc. for each material. For weft or patterned fabrics see specific pages

COM	Mtl. 0.72 h. 1.40 Each	COL	Mq. 1.31 Each
------------	------------------------	------------	---------------

Optionals:

	Value	Options/notes
FM-M2	+ 56 €	ASH GREY ES , BRONZE E2 , BULGARO RED FP , CHERRY RED EQ , DARK GREEN EL , FACEPOWDER PINK E8 , FANGO E3 , GOLDEN YELLOW EO , LIGHT BLUE EO , LIGHT GREY ET , OCEAN BLUE E1 , OCHER YELLOW E7 , PAPAYA ORANGE EA , PASTEL YELLOW E4 , PINE GREEN EJ , RED ER , SAGE GREEN E9

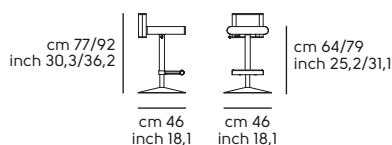

Toy SG



Trampoliere design Roberto Paoli

Trampoliere OUT S, P, H65-75 - Metal Shell

Frame in: metal

Model	Code	Mod.	--	Frame		Optional	Q.ty	boxes	Kg	M ³
				O1	O2					
Chair TRAMPOLIERE OUT S M 	S1550M2	S		210 €	278 €		4	1	26.0	0.32
Stool TRAMPOLIERE OUT H65 M 	S1550I2	H65		239 €	310 €		1 2	1 1	8.1 16.2	0.2 0.25
Stool TRAMPOLIERE OUT H75 M 	S1550K2	H75		239 €	310 €		1 2	1 1	8.1 16.2	0.2 0.25

Frame finishes

Outdoor Metal

O1	Outdoor BROWN E6 , Outdoor WHITE BB , Outdoor SAND EC , Outdoor GRAFITE EG , Outdoor BLACK EN
O2	Outdoor LIGHT BLUE E0 , Outdoor OCEAN BLUE E1 , Outdoor BRONZE E2 , Outdoor FANGO E3 , Outdoor PASTEL YELLOW E4 , Outdoor OCHER YELLOW E7 , Outdoor FACEPOWDER PINK E8 , Outdoor SAGE GREEN E9 , Outdoor PINE GREEN EJ , Outdoor DARK GREEN EL , Outdoor GOLD YELLOW EO , Outdoor RED BULGARO FP , Outdoor CHERRY RED EQ , Outdoor RED ER , Outdoor ASH GREY ES , Outdoor LIGHT GREY ET , Outdoor PAPAYA ORANGE EA

Trampoliere S

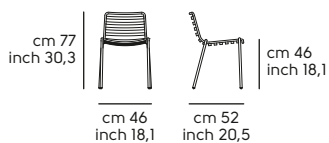



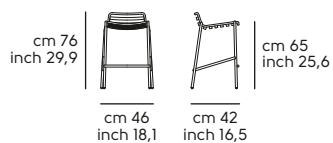

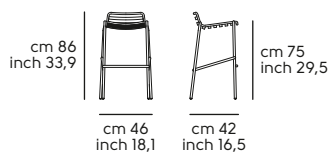

Trampoliere H65





Trampoliere H75



Trampoline Cushion - Fabric or leather

Model	Code	Mod.	--	Upholstery									Optional	Q.ty 	boxes 	Kg 	M² 
				TA	TB	TC	TD	TE	SF	SV	COM	COL					
Cushion TRAMPOLIERE S 	A1550C0	S		90 €	101 €	116 €	127 €	166 €	144 €	174 €	90 €	116 €		4	1	1.2	0.04
Cushion TRAMPOLIERE H65-H75 	A1550C1	H65-H75		86 €	95 €	108 €	118 €	152 €	135 €	164 €	86 €	108 €		4	1	1.0	0.01

COM/COL - Minimum Q.ty 6 pc. for each material. For weft or patterned fabrics see specific pages

 COM	Mtl. 0.40 h. 1.40 Each	 COL	Mq. 0.60 Each
--	------------------------	--	---------------

Cushion finishes

Upholstery

TA	FAUX LEATHER Secret , FABRIC Mirage , FABRIC Cotton Club	TB	FAUX LEATHER Vintage , FABRIC Fenix Wool , FABRIC Novabuk , FABRIC Manhattan , FABRIC Visual
TC	VELVET SUPERB, FABRIC Second , FABRIC Main Line Flax , FABRIC Oceanic	TD	FABRIC Yoredale , FABRIC Remix 3
TE	FABRIC Uniform Melange	SF	LEATHER Fiore
SV	LEATHER Vintage		

Optionals:

		Value	Options/notes
ES-1	Fireproof foam	+ 6 €	ES-1

Wrap design Balutto Associati

Wrap S, P, AP - Shell in fabric or leather

Frame in: metal or wood

Model	Code	Base type	Frame	Shell									Optional	Q.ty	boxes	Kg	M ³
				TA	TB	TC	TD	TE	SF	SV	COM	COL					
 Chair WRAP S M TS	SI590SO	_M	MI	291 €	326 €	370 €	380 €	460 €	445 €	534 €	291 €	370 €	FM-M2 ES-1 PD-FO	2	1	16.8	0.41



COM/COL - Minimum Q.ty 6 pc. for each material. For weft or patterned fabrics see specific pages

 Mtl. 0.90 h. 1.40 Each	 Mq. 2.15 Each
---	---

Model	Code	Base type	Frame	Shell									Optional	Q.ty	boxes	Kg	M ³
				TA	TB	TC	TD	TE	SF	SV	COM	COL					
 Armch. WRAP P M TS	SI590PO	_M	MI	359 €	396 €	450 €	467 €	585 €	508 €	636 €	359 €	450 €	FM-M2 ES-1 PD-FO	2	1	16.8	0.48

COM/COL - Minimum Q.ty 6 pc. for each material. For weft or patterned fabrics see specific pages

 Mtl. 1.20 h. 1.40 Each	 Mq. 2.34 Each
---	---

Model	Code	Base type	Frame	Shell									Optional	Q.ty	boxes	Kg	M ³
				TA	TB	TC	TD	TE	SF	SV	COM	COL					
 Waiting Chair WRAP AP M TS	SI590A0	_M	MI	512 €	548 €	614 €	631 €	756 €	632 €	727 €	512 €	614 €	FM-M2 ES-1 PD-FO	1	1	11.5	0.41
 Waiting Chair WRAP AP L TS_N	SI590AL	_N	LII	674 €	710 €	775 €	792 €	918 €	793 €	887 €	674 €	775 €	FL-I2 ES-1 PD-FO	1	1	11.5	0.5

COM/COL - Minimum Q.ty 6 pc. for each material. For weft or patterned fabrics see specific pages

 Mtl. 1.30 h. 1.40 Each	 Mq. 2.34 Each
---	---

Note:

TS Front and Back covering available in two-tone or bi-material. Reference price in the upper category

Frame finishes

Metal

MI	WHITE BB , BROWN E6 , SAND EC , GRAPHITE EG , BLACK EN
-----------	---

Wood

LII	Veneered wood painted GREY I02 , Veneered wood painted GRAFITE GREY I03 , Veneered wood painted BLACK I04 , Veneered wood painted WHITE I05 , Veneered wood painted BLUE I06 , Veneered wood painted RED I08 , Veneered wood painted CHERRY RED I09 , Veneered wood painted DARK BROWN I26 , Veneered wood painted NATURAL I40 , Veneered wood painted NATURAL OAK I52
------------	--

Shell finishes

Upholstery

TA	FAUX LEATHER Secret , FABRIC Mirage , FABRIC Cotton Club	TB	FAUX LEATHER Vintage , FABRIC Fenix Wool , FABRIC Novabuk , FABRIC Manhattan , FABRIC Visual
TC	VELVET SUPERB, FABRIC Second , FABRIC Main Line Flax , FABRIC Oceanic	TD	FABRIC Yoredale , FABRIC Remix 3
TE	FABRIC Uniform Melange	SF	LEATHER Fiore
SV	LEATHER Vintage		

Optionals:

		Value	Options/notes
FM-M2	Indoor matt metal M2	+ 45 €	ASH GREY ES , BRONZE E2 , BULGARO RED FP , CHERRY RED EQ , DARK GREEN EL , FACEPOWDER PINK E8 , FANGO E3 , GOLDEN YELLOW EO , LIGHT BLUE EO , LIGHT GREY ET , OCEAN BLUE E1 , OCHER YELLOW E7 , PAPAYA ORANGE EA , PASTEL YELLOW E4 , PINE GREEN EJ , RED ER , SAGE GREEN E9
FL-I2	Veneered wood finish LI2	+ 8 €	Veneered wood FLAMED WALNUT I24 , Veneered wood NATURAL OAK I22
ES-1	Fireproof foam	+ 6 €	ES-1
PD-F0	Felt pad feet	+ 6 €	PD-F0

Wrap S_M

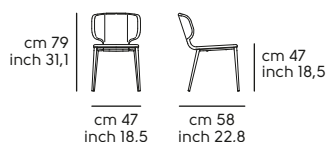

Wrap P_M

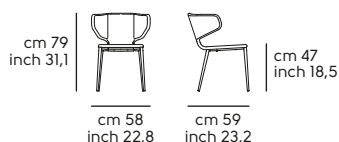

Wrap AP_M

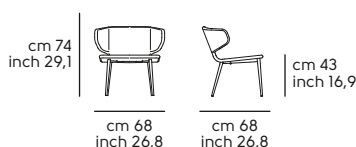

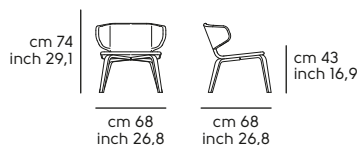

Wrap AP_N



Wrap H65-75 - Shell in fabric or leather

Frame in: metal

Model	Code	Mod.	Frame	Shell									Optional	Q.ty	boxes	Kg	M³
				TA	TB	TC	TD	TE	SF	SV	COM	COL					
 Stool WRAP H65 M TS	SI590H0	H65	MI	345 €	381 €	417 €	434 €	505 €	486 €	578 €	345 €	417 €	FM-M2 ES-1 PD-F0	1	1	8.4	0.29
 Stool WRAP H75 M TS	SI590J0	H75	MI	358 €	395 €	431 €	446 €	519 €	499 €	590 €	358 €	431 €	FM-M2 ES-1 PD-F0	1	1	8.4	0.32

Note:

TS Front and Back covering available in two-tone or bi-material. Reference price in the upper category

Frame finishes

Metal



MI	WHITE BB , BROWN E6 , SAND EC , GRAPHITE EG , BLACK EN
-----------	---

Shell finishes

Upholstery

TA	FAUX LEATHER Secret , FABRIC Mirage , FABRIC Cotton Club	TB	FAUX LEATHER Vintage , FABRIC Fenix Wool , FABRIC Novabuk , FABRIC Manhattan , FABRIC Visual
TC	VELVET SUPERB, FABRIC Second , FABRIC Main Line Flax , FABRIC Oceanic	TD	FABRIC Yoredale , FABRIC Remix 3
TE	FABRIC Uniform Melange	SF	LEATHER Fiore
SV	LEATHER Vintage		

COM/COL - Minimum Q.ty 6 pc. for each material. For weft or patterned fabrics see specific pages

 COM	Mtl. 0.85 h. 1.40 Each	 COL	Mq. 1.76 Each
---	------------------------	--	---------------

Optionals:

	Value	Options/notes
FM-M2	+ 45 €	ASH GREY ES , BRONZE E2 , BULGARO RED FP , CHERRY RED EQ , DARK GREEN EL , FACEPOWDER PINK E8 , FANGO E3 , GOLDEN YELLOW EO , LIGHT BLUE E0 , LIGHT GREY ET , OCEAN BLUE E1 , OCHER YELLOW E7 , PAPAYA ORANGE EA , PASTEL YELLOW E4 , PINE GREEN EJ , RED ER , SAGE GREEN E9
ES-1	+ 6 €	ES-1
PD-F0	+ 6 €	PD-F0

Wrap H65

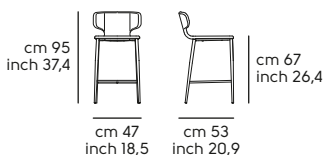

Wrap H75

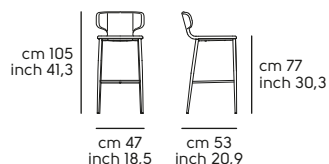

Wrap SG - Shell in fabric or leather

Frame in: metal

Model	Code	Mod.	Frame	Shell									Optional	Q.ty	boxes	Kg	M²
				TA	TB	TC	TD	TE	SF	SV	COM	COL					
 Stool WRAP SG TS	S1590ZT	SG	MI	610 €	646 €	681 €	698 €	770 €	751 €	842 €	610 €	681 €	FM-M2 ES-1	1	1	17.0	0.26

Note:

TS Front and Back covering available in two-tone or bi-material. Reference price in the upper category

Frame finishes

Metal

MI WHITE **BB**, BROWN **E6**, SAND **EC**, GRAPHITE **EG**, BLACK **EN**

Shell finishes

Upholstery

TA	FAUX LEATHER Secret , FABRIC Mirage , FABRIC Cotton Club	TB	FAUX LEATHER Vintage , FABRIC Fenix Wool , FABRIC Novabuk , FABRIC Manhattan , FABRIC Visual
TC	VELVET SUPERB, FABRIC Second , FABRIC Main Line Flax , FABRIC Oceanic	TD	FABRIC Yoredale , FABRIC Remix 3
TE	FABRIC Uniform Melange	SF	LEATHER Fiore
SV	LEATHER Vintage		

COM/COL - Minimum Q.ty 6 pc. for each material. For weft or patterned fabrics see specific pages

COM	Mtl. 0.85 h. 1.40 Each	COL	Mq. 1.76 Each
------------	------------------------	------------	---------------

Optionals:

	Value	Options/notes
FM-M2	+ 56 €	ASH GREY ES , BRONZE E2 , BULGARO RED FP , CHERRY RED EQ , DARK GREEN EL , FACEPOWDER PINK E8 , FANGO E3 , GOLDEN YELLOW EO , LIGHT BLUE EO , LIGHT GREY ET , OCEAN BLUE EI , OCHER YELLOW E7 , PAPAYA ORANGE EA , PASTEL YELLOW E4 , PINE GREEN EJ , RED ER , SAGE GREEN E9
ES-1	+ 6 €	ES-1

Wrap SG

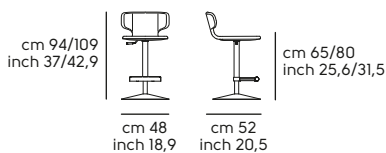

Tables

Akashi design Paolo Vernier

Table Akashi

Frame with bases in: aluminum - FIXED Tables with tops in Glass or Ceramic are suitable for Outdoor



Version	Code	Legs	Frame	Top	Optional	Q.ty	boxes	Kg	M ³
---------	------	------	-------	-----	----------	------	-------	----	----------------

Akashi MDF

Top 19 mm. thk.

				LM1					
140x140	T2230140	M1	M1	2.481 €	FM-M2	1	2	67.5	0.41
160x 90	T2230160			2.166 €		1	2	57.5	0.31
180x100	T2230180			2.390 €		1	2	66.0	0.38
200x100	T2230200			2.591 €		1	2	69.0	0.45

Akashi Veneer

Top 19 mm. thk.

				LI2					
140x140	T2230140	M1	M1	2.938 €	FM-M2	1	2	62.0	0.41
160x 90	T2230160			2.400 €		1	2	53.5	0.31
180x100	T2230180			2.672 €		1	2	60.0	0.38
200x100	T2230200			2.946 €		1	2	63.0	0.45
300x120	T2230300			4.358 €		1	2	90.0	0.88

Akashi Laminato

Top 19 mm. thk.

				HLO					
160x 90	T2230160	M1	M1	2.433 €	FM-M2	1	2	53.5	0.31
180x100	T2230180			2.545 €		1	2	60.0	0.38
200x100	T2230200			2.788 €		1	2	63.0	0.45
300x120	T2230300			3.925 €		1	2	90.0	0.88

Akashi Fenix

Top 19 mm. thk.

				HF1					
160x 90	T2230160	M1	M1	2.675 €	FM-M2	1	2	53.5	0.31
180x100	T2230180			2.800 €		1	2	60.0	0.38
200x100	T2230200			3.065 €		1	2	63.0	0.45
300x120	T2230300			4.318 €		1	2	90.0	0.88

Akashi Glass



Top 6 mm. thk.

				GVB	GVC	GVD					
140x140	T2230140			2.160 €	2.259 €	2.410 €		1	2	72.0	0.41
160x 90	T2230160			1.930 €	2.034 €	2.114 €		1	2	62.0	0.31
180x100	T2230180	M1	M1	2.126 €	2.259 €	2.357 €	FM-M2	1	2	69.5	0.38
200x100	T2230200			2.294 €	2.441 €	2.552 €		1	2	73.5	0.45
300x120	T2230300			3.127 €	3.385 €	3.582 €		1	2	108.0	0.88

Akashi Ceramic

Top 6 mm. thk.

				GMA							
160x 90	T2230160				3.175 €			1	2	90.0	0.31
180x100	T2230180				3.645 €			1	2	106.5	0.38
200x100	T2230200	M1	M1		4.010 €		FM-M2	1	2	115.0	0.45
300x120	T2230300				5.488 €			1	2	186.0	0.88

Version	Code	Legs	Frame	Top and extensions	Optional				
---------	------	------	-------	--------------------	----------	---	---	---	---

Akashi MDF

Top and extensions 19 mm thk.

				LM1							
160/210x90	T2231160				2.927 €			1	2	69.5	0.31
200/260x100	T2231200	M1	M1		3.577 €		FM-M2	1	2	81.0	0.49

Akashi Veneer

Top and extensions 19 mm thk.

				LI2							
160/210x90	T2231160				3.337 €			1	2	65.5	0.31
200/260x100	T2231200	M1	M1		3.993 €		FM-M2	1	2	75.0	0.49

Akashi Laminato

Top and extensions 19 mm thk.

				HLO							
160/210x90	T2231160				3.024 €			1	2	65.5	0.31
200/260x100	T2231200	M1	M1		3.634 €		FM-M2	1	2	75.0	0.49

Akashi Fenix

Top and extensions 19 mm thk.

				HF1							
160/210x90	T2231160				3.416 €			1	2	65.5	0.31
200/260x100	T2231200	M1	M1		4.093 €		FM-M2	1	2	75.0	0.49

Note:

Tables FIXED With Tops in Glass o Ceramic are suitable for OUTDOOR

Frame finishes

Metal	
MI	WHITE BB , BROWN E6 , SAND EC , GRAPHITE EG , BLACK EN

Legs finishes

Metal	
MI	WHITE BB , BROWN E6 , SAND EC , GRAPHITE EG , BLACK EN

Top and extensions finishes

Lacquered MDF	
LMI	GRAPHITE GREY G02 , BLACK G04 , WHITE G05 , SAND G07 , BROWN G41
Laminate	
HLO	BLUE LBB , GRAFITE GREY LGD , ASH GREY LGS , CHERRY RED LRC , RED BULGARO LRS , SAND LS2

Veneer	
LI2	NATURAL OAK I22 , FLAMED WALNUT I24
Fenix	
HFI	BLACK FX4 , WHITE FX5

Top finishes

Crystal Ceramic and Ceramic	
GMA	MARBLE CALACATTA GLOSSY WHITE K32 , BLACK GREEK MARBLE K33 , MARBLE GLOSSY NOIR DESIR K35 , MARBLE CALACATTA MATT WHITE K42 , MARBLE MATT NOIR DESIR K45 , MARBLE MATT GREEN TINOS K46

Satin Glass	
GVC	MATT GRAFITE ANTISCRATCH J31 , MATT SAND ANTISCRATCH J32
GVD	EXTRA CLEAR MATT WHITE ANTISCRATCH J41

Glossy Glass	
GVB	EXTRA CLEAR GLOSSY WHITE J21 , EXTRA CLEAR GLOSSY CHERRY RED J25

Optionals:

	Value	Options/notes
FM-M2	+ 166 €	Indoor matt metal M2 ASH GREY ES , BRONZE E2 , BULGARO RED FP , CHERRY RED EQ , DARK GREEN EL , FACEPOWDER PINK E8 , FANGO E3 , GOLDEN YELLOW EO , LIGHT BLUE EO , LIGHT GREY ET , OCEAN BLUE EI , OCHER YELLOW E7 , PAPAYA ORANGE EA , PASTEL YELLOW E4 , PINE GREEN EJ , RED ER , SAGE GREEN E9

140x140

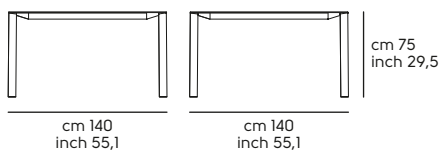

160x 90

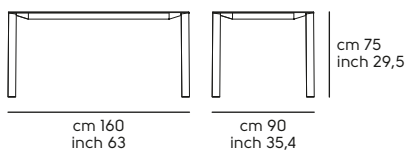

180x100

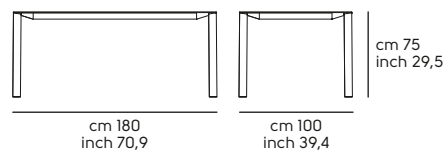

200x100

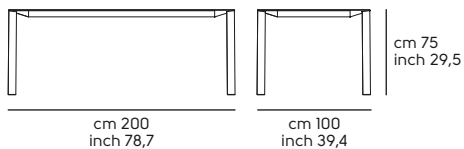

300x120

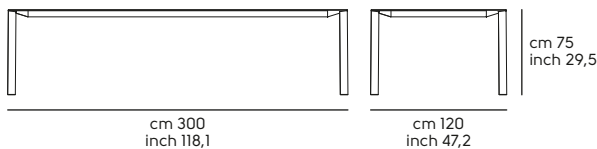

160/210x90

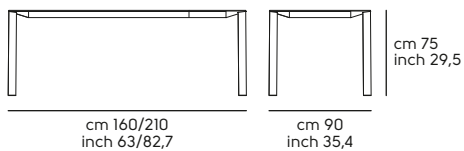

200/260x100

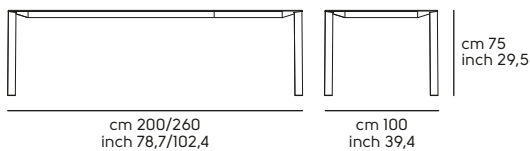

Alexander design Midj R&D

Table Alexander

Frame in: metal



Version	Code	Legs	Frame	Top	Optional	Q.ty	boxes	Kg	M ³
---------	------	------	-------	-----	----------	------	-------	----	----------------

Alexander Wood

Top 40 mm. thk.

				LS1	LS2					
200x106	T1774200	MI	MI	3.036 €	3.533 €		1	3	117.0	0.69
250x106	T1774250			3.626 €	4.185 €		1	3	130.0	0.8

Alexander Ceramic

Top 16 mm. thk.

				GMA						
220x116 Botte	T1775220	MI	MI	3.674 €			1	3	138.0	0.37
250x120 Botte	T1775250			4.349 €			1	3	151.0	0.39

Version	Code	Legs	Frame	Top and extensions	Optional	Q.ty	boxes	Kg	M ³
---------	------	------	-------	--------------------	----------	------	-------	----	----------------

Alexander Glass

Top and extensions 10 mm thk.

				GVC						
160/240x 90	T1776160	MI	MI	2.862 €			1	4	112.0	0.44
200/300x100	T1776200			3.505 €			1	4	136.0	0.75

Alexander Ceramic

Top and extensions 11 mm thk. | ATTENTION ! GMA: Top and Extensions 14 mm thk.

				GKA	GKB	GMA					
160/240x 90	T1776160	MI	MI	3.483 €	3.616 €	3.974 €		1	4	112.0	0.44
200/300x100	T1776200			4.307 €	4.455 €	4.992 €		1	4	136.0	0.75

Note:

For Glass or Crystal Ceramic tops, extensions in the same material

Frame finishes

Metal

MI WHITE BB, BROWN E6, SAND EC, GRAPHITE EG, BLACK EN

Top and extensions finishes

Solid wood

LS1 IM OAK STRAIGHT EDGE WRI

LS2 SOLID WALNUT BARK EDGE WNI

Crystal Ceramic and Ceramic

GKA PIOMBO K01, CHARCOAL SAVOIA K11, CEMENT SAVOIA K12, EMPERADOR MARBLE BRUSH.MATT BROWN K31

GKB RUST OXIDE K23, WHITE CALCE K24

Legs finishes

Metal

MI WHITE BB, BROWN E6, SAND EC, GRAPHITE EG, BLACK EN

Satin Glass

GVC MATT GRAFITE ANTISCRATCH J31, MATT SAND ANTISCRATCH J32

Crystal Ceramic and glossy Ceramic

GMA MARBLE CALACATTA GLOSSY WHITE K32, BLACK GREEK MARBLE K33, MARBLE GLOSSY NOIR DESIR K35, MARBLE CALACATTA MATT WHITE K42, MARBLE MATT NOIR DESIR K45, MARBLE MATT GREEN TINOS K46

200x106

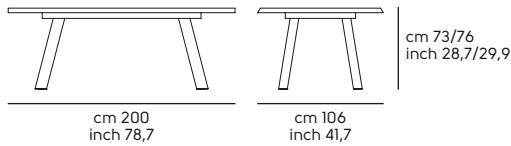

250x106

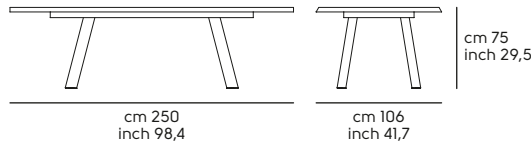

220x116 Botte

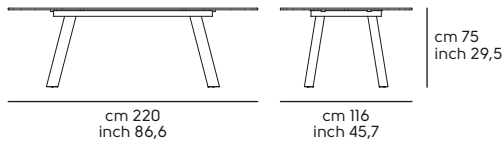

250x120 Botte

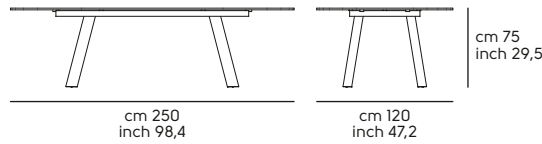

160/240x 90

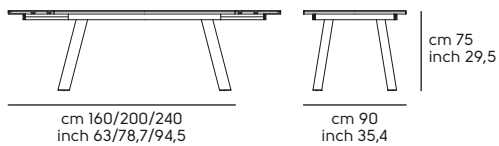

200/300x100

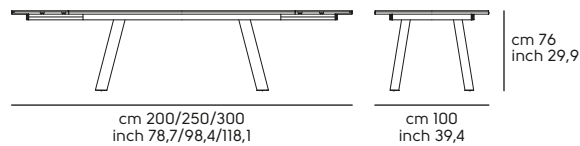

Alfred design Midj R&D

Table Alfred

Frame in: metal



T
A
B
L
E
S

Version	Code	Legs	Frame	Top	Optional	Q.ty	boxes	Kg	M ³
---------	------	------	-------	-----	----------	------	-------	----	----------------

Alfred Wood

Top 40 mm. thk.

				LS1	LS2					
200x106	T1760200	MI	MI	3.165 €	3.658 €		1	4	113.0	0.39
250x106	T1760250			3.756 €	4.308 €		1	4	126.0	0.45

Alfred Ceramic

Top 16 mm. thk.

				GMA						
220x116 Botte	T1761220	MI	MI	3.791 €			1	4	155.0	0.69
250x120 Botte	T1761250			4.467 €			1	4	164.0	0.65

Version	Code	Legs	Frame	Top and extensions	Optional	Q.ty	boxes	Kg	M ³
---------	------	------	-------	--------------------	----------	------	-------	----	----------------

Alfred Glass

Top and extensions 10 mm thk.

				GVC						
160/240x 90	T1762160	MI	MI	2.985 €			1	5	129.0	0.68
200/300x100	T1762200			3.637 €			1	5	153.0	0.87

Alfred Ceramic

Top and extensions 11 mm thk. | ATTENTION ! GMA: Top and Extensions 14 mm thk.

				GKA	GKB	GMA					
160/240x 90	T1762160	MI	MI	3.603 €	3.744 €	4.099 €		1	5	129.0	0.68
200/300x100	T1762200			4.422 €	4.576 €	5.121 €		1	5	153.0	0.87

Note:

For Glass or Crystal Ceramic tops, extensions in the same material

Frame finishes

Metal

MI WHITE BB, BROWN E6, SAND EC, GRAPHITE EG, BLACK EN

Top and extensions finishes

Solid wood

LS1 IM OAK STRAIGHT EDGE WRI

LS2 SOLID WALNUT BARK EDGE WNI

Crystal Ceramic and Ceramic

GKA PIOMBO K01, CHARCOAL SAVOIA K11, CEMENT SAVOIA K12, EMPERADOR MARBLE BRUSH.MATT BROWN K31

GKB RUST OXIDE K23, WHITE CALCE K24

Legs finishes

Metal

MI WHITE BB, BROWN E6, SAND EC, GRAPHITE EG, BLACK EN

Satin Glass

GVC MATT GRAFITE ANTISCRATCH J31, MATT SAND ANTISCRATCH J32

Crystal Ceramic and glossy Ceramic

GMA MARBLE CALACATTA GLOSSY WHITE K32, BLACK GREEK MARBLE K33, MARBLE GLOSSY NOIR DESIR K35, MARBLE CALACATTA MATT WHITE K42, MARBLE MATT NOIR DESIR K45, MARBLE MATT GREEN TINOS K46

200x106

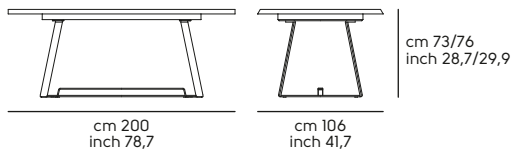

250x106

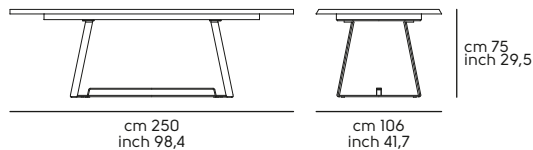

220x116 Botte

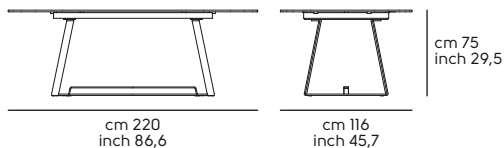

250x120 Botte

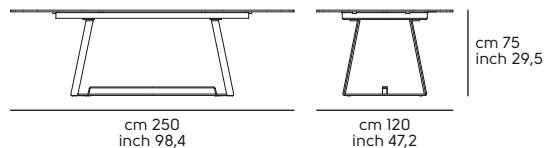

160/240x 90

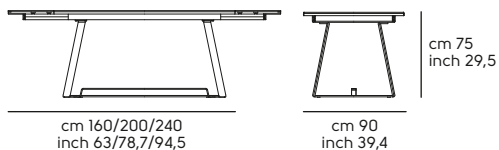

200/300x100

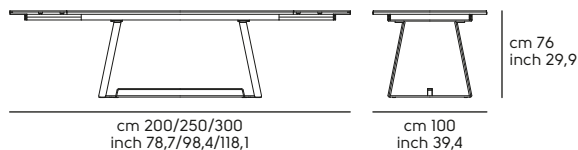

Apollo design Studio Kappa

Table Apollo

Frame in: metal



Version	Code	Legs	Frame	Top and extensions	Optional	Q.ty	boxes	Kg	M ³
---------	------	------	-------	--------------------	----------	------	-------	----	----------------

Apollo Melamine HL

Top and extensions 18 mm thk.

				HL1					
140/190 x90	T0110140	M1	M1	1.602 €	FM-M2	1	4	69.0	0.32
160/210/260 x90	T0110160			1.706 €		1	5	84.0	0.34

Apollo MDF

Top and extensions 19 mm thk.

				LM1					
140/190 x90	T0110140	M1	M1	2.175 €	FM-M2	1	4	69.0	0.32
160/210/260 x90	T0110160			2.295 €		1	5	84.0	0.34

Apollo Fenix

Top and extensions 19 mm thk.

				HFI					
140/190 x90	T0110140	M1	M1	1.922 €	FM-M2	1	4	69.0	0.32
160/210/260 x90	T0110160			2.059 €		1	5	84.0	0.34

Apollo Laminate

Top and extensions 19 mm thk.

				HLO					
140/190 x90	T0110140	M1	M1	1.731 €	FM-M2	1	4	69.0	0.32
160/210/260 x90	T0110160			1.852 €		1	5	84.0	0.34

Apollo Veneer

Top and extensions 19 mm thk.

				LI2					
140/190 x90	T0110140	M1	M1	2.402 €	FM-M2	1	4	69.0	0.32
160/210/260 x90	T0110160			2.652 €		1	5	84.0	0.34

Apollo Glass

Glass top 10 mm thk. MDF extensions 19 mm thk.

				GVB	GVC	GVD					
140/190 x90	T0110140	M1	M1	2.305 €	2.426 €	2.639 €	FM-M2	1	4	80.0	0.32
160/210/260 x90	T0110160			2.428 €	2.573 €	2.810 €		1	5	97.0	0.34
190/240/290 x90	T0110190			2.704 €	2.781 €	3.059 €		1	5	107.0	0.4

Apollo Ceramic

Ceramic top 11 mm thk 19 mm thk MDF extensions | ATTENTION! GMA: Top Th. 14 mm. and Extensions Thk 22 mm.

				GKA	GKB	GMA					
140/190 x90	T0110140	M1	M1	2.615 €	2.769 €	2.952 €	FM-M2	1	4	80.0	0.32
160/210/260 x90	T0110160			2.807 €	3.000 €	3.302 €		1	5	97.0	0.34
190/240/290 x90	T0110190			3.187 €	3.396 €	3.837 €		1	5	107.0	0.4

Note:

For Glass or Crystal Ceramic tops, extensions ONLY in matching lacquered MDF - OUTDOOR

Frame finishes**Metal****MI** WHITE BB, BROWN E6, SAND EC, GRAPHITE EG, BLACK EN**Legs finishes****Metal****MI** WHITE BB, BROWN E6, SAND EC, GRAPHITE EG, BLACK EN**Top and extensions finishes****Melamine****HLI** WHITE M01, GRAFITE M02, BLACKM04, SAND M07**Veneer****LI2** NATURAL OAK I22, FLAMED WALNUT I24**Laminate****HLO** BLUE LBB, GRAFITE GREY LGD, ASH GREY LGS, CHERRY RED LRC, RED BULGARO LRS, SAND LS2**Fenix****HFI** BLACK FX4, WHITE FX5**Lacquered MDF****LMI** GRAPHITE GREY G02, BLACK G04, WHITE G05, SAND G07, BROWN G41**Top finishes with matching lacquered MDF extensions****Satin Glass****GVC** MATT GRAFITE ANTISCRATCH J31, MATT SAND ANTISCRATCH J32**GVD** EXTRA CLEAR MATT WHITE ANTISCRATCH J41**Glossy Glass****GVB** EXTRA CLEAR GLOSSY WHITE J21**Crystal Ceramic and Ceramic****GKA** PIOMBO K01, CHARCOAL SAVOIA K11, CEMENT SAVOIA K12, EMPERADOR MARBLE BRUSH.MATT BROWN K31**GKB** RUST OXIDE K23, WHITE CALCE K24**Crystal Ceramic and glossy Ceramic****GMA** MARBLE CALACATTA GLOSSY WHITE K32, BLACK GREEK MARBLE K33, MARBLE GLOSSY NOIR DESIR K35, MARBLE CALACATTA MATT WHITE K42, MARBLE MATT NOIR DESIR K45, MARBLE MATT GREEN TINOS K46**Lacquered MDF extensions finishes, JUST for Glass and Crystal Ceramic tops****Lacquered MDF****LMI** GRAPHITE GREY G02, BLACK G04, WHITE G05, SAND G07, BROWN G41**Optionals:**

		Value	Options/notes
FM-M2	Indoor matt metal M2	+ 166 €	ASH GREY ES, BRONZE E2, BULGARO RED FP, CHERRY RED EQ, DARK GREEN EL, FACEPOWDER PINK E8, FANGO E3, GOLDEN YELLOW EO, LIGHT BLUE E0, LIGHT GREY ET, OCEAN BLUE EI, OCHER YELLOW E7, PAPAYA ORANGE EA, PASTEL YELLOW E4, PINE GREEN EJ, RED ER, SAGE GREEN E9

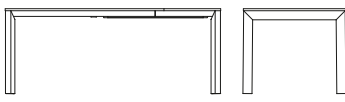
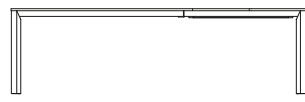
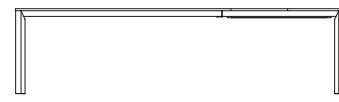
140/190 x90cm 140/190
inch 55,1/74,8cm 90
inch 35,4cm 75
inch 29,5**160/210/260 x90**cm 160/210/260
inch 63/82,7/102,4cm 90
inch 35,4cm 75
inch 29,5**190/240/290 x90**cm 190/240/290
inch 74,8/94,5/114,2cm 90
inch 35,4cm 75
inch 29,5

Armando design Balutto Associati

Table Armando

Frame in: metal



T
A
B
L
E
S

Version	Code	Legs	Frame	Top	Optional	Q.ty	boxes	Kg	M ³
---------	------	------	-------	-----	----------	------	-------	----	----------------

Armando Metal

Top 17 mm. thk.

				M1					
80 x80	T0120Q80			928 €		1	2	30.0	0.15
90 x90	T0120Q90			1.045 €		1	2	35.0	0.16
160x90	T0120160			1.520 €		1	2	49.0	0.23
200x100	T0120200			1.662 €		1	2	62.0	0.28
280x100	T0120280	M1	M1	2.461 €		1	2	98.0	0.38
80 x80 H.110	T0127Q80			1.031 €		1	2	36.0	0.15
90 x90 H.110	T0127Q90			1.148 €		1	2	37.0	0.19
160x90 H.110	T0127160			1.623 €		1	2	54.0	0.25
200x100 H.110	T0127200			1.766 €		1	2	68.0	0.29
280x100 H.110	T0127280			2.552 €		1	2	103.0	0.42

Frame finishes

Metal

MI WHITE BB, BLACK EN

Top finishes

Metal

MI WHITE BB, BLACK EN

Legs finishes

Metal

MI WHITE BB, BLACK EN

80 x80

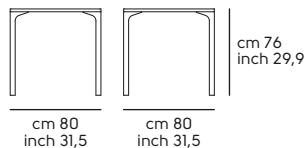

90 x90

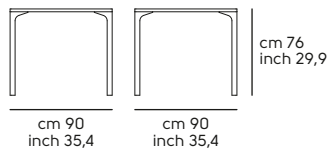

160x90

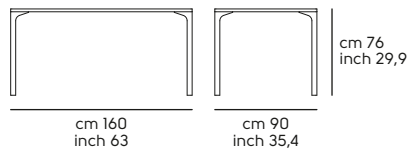

200x100

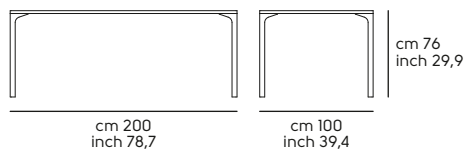

280x100

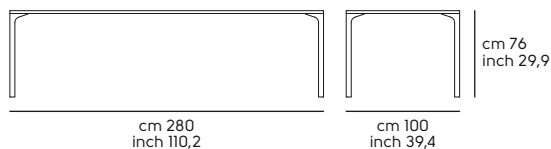

80 x80 H.110

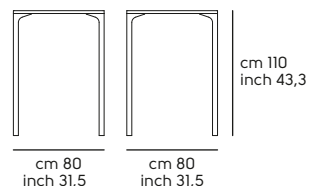

90 x90 H.110

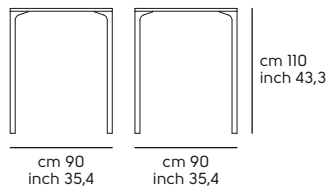

160x90 H.110

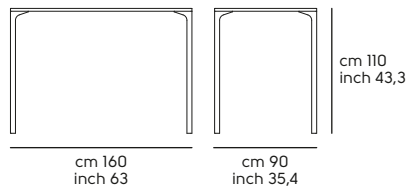

200x100 H.110

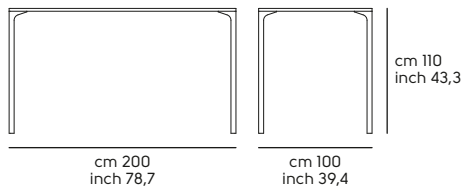

280x100 H.110



Badù design Studio Kappa

Table Badù

Frame in: metal



T
A
B
L
E
S

Version	Code	Legs	Frame	Top and extensions	Optional	Q.ty	boxes	Kg	M ³
---------	------	------	-------	--------------------	----------	------	-------	----	----------------

Badù Melamine HL

Top and extensions 18 mm thk. - 120/170 x 80 CATAS certified

				HL1					
100/140 x70	T0130100			674 €		1	4	38.0	0.16
120/170 x80	T0130120			788 €		1	4	44.0	0.23
140/200 x90	T0130140			823 €		1	4	51.0	0.3
L 140/185/230 x90	T0135140	MI	MI	933 €	FM-M2	1	5	55.0	0.47
XL 110/155/200/245 x80	T0137110			1.136 €		1	5	55.0	0.28
XL 140/190/240/290 x90	T0137140			1.515 €		1	6	70.0	0.4
XL 160/210/260/310 x90	T0137160			1.643 €		1	6	75.0	0.5

Badù MDF

Top and extensions 19 mm thk.

				LM1					
140/200 x90	T0130140			1.299 €		1	4	48.0	0.3
L 140/185/230 x90	T0135140	MI	MI	1.475 €	FM-M2	1	5	55.0	0.47
XL 140/190/240/290 x90	T0137140			1.803 €		1	6	70.0	0.4
XL 160/210/260/310 x90	T0137160			2.008 €		1	6	75.0	0.5

Badù Veneer

Top and extensions 19 mm thk.

				LI2					
L 140/185/230 x90	T0135140	MI	MI	1.725 €	FM-M2	1	5	55.0	0.47
XL 160/210/260/310 x90	T0137160			2.183 €		1	6	60.0	0.5

Badù Fenix

Top and extensions 19 mm thk.

				HF1					
100/140 x70	T0130100			1.643 €		1	4	38.0	0.16
120/170 x80	T0130120			1.772 €		1	4	44.0	0.23
140/200 x90	T0130140			1.791 €		1	4	51.0	0.3
L 140/185/230 x90	T0135140	MI	MI	1.894 €	FM-M2	1	5	55.0	0.47
XL 110/155/200/245 x80	T0137110			2.124 €		1	5	55.0	0.28
XL 140/190/240/290 x90	T0137140			2.610 €		1	6	70.0	0.4
XL 160/210/260/310 x90	T0137160			2.681 €		1	6	75.0	0.5

Badü Laminate

Top and extensions 19 mm thk.

				HLO							
100/140 x70	T0130100			1.345 €				1	4	38.0	0.16
120/170 x80	T0130120			1.455 €				1	4	44.0	0.23
140/200 x90	T0130140			1.477 €				1	4	51.0	0.3
L 140/185/230 x90	T0135140	M1	M1	1.555 €			FM-M2	1	5	55.0	0.47
XL 110/155/200/245 x80	T0137110			1.742 €				1	5	55.0	0.28
XL 140/190/240/290 x90	T0137140			2.150 €				1	6	70.0	0.4
XL 160/210/260/310 x90	T0137160			2.195 €				1	6	75.0	0.5

Badü Glass

Glass top 10 mm thk. MDF extensions 19 mm thk.

				GVB	GVC	GVD					
100/140 x70	T0130100			921 €	1.023 €	1.082 €		1	4	47.0	0.16
120/170 x80	T0130120			1.030 €	1.175 €	1.244 €		1	4	56.0	0.23
140/200 x90	T0130140			1.140 €	1.230 €	1.305 €		1	4	63.0	0.3
L 140/185/230 x90	T0135140	M1	M1	1.469 €	1.612 €	1.850 €	FM-M2	1	5	70.0	0.32
XL 110/155/200/245 x80	T0137110			1.482 €	1.605 €	1.776 €		1	5	67.0	0.28
XL 140/190/240/290 x90	T0137140			2.050 €	2.224 €	2.439 €		1	6	85.0	0.4
XL 160/210/260/310 x90	T0137160			2.183 €	2.349 €	2.602 €		1	6	90.0	0.5

Badü Ceramic

Ceramic top 11 mm thk and MDF extensions 19 mm thk | ATTENTION! GMA: Top Th. 14 mm. and Extensions Thk 22 mm.

				GKA	GKB	GMA					
100/140 x70	T0130100			1.308 €	1.381 €	1.518 €		1	4	50.0	0.16
120/170 x80	T0130120			1.433 €	1.528 €	1.677 €		1	4	60.0	0.23
140/200 x90	T0130140			1.596 €	1.703 €	1.867 €		1	4	68.0	0.3
L 140/185/230 x90	T0135140	M1	M1	2.016 €	2.138 €	2.340 €	FM-M2	1	5	75.0	0.32
XL 110/155/200/245 x80	T0137110			1.936 €	2.078 €	2.285 €		1	5	70.0	0.28
XL 140/190/240/290 x90	T0137140			2.533 €	2.748 €	3.021 €		1	6	90.0	0.4
XL 160/210/260/310 x90	T0137160			2.746 €	2.844 €	3.109 €		1	6	95.0	0.5

Note:

For Glass or Crystal Ceramic tops, extensions ONLY in matching lacquered MDF

Frame finishes

Metal

MI	WHITE BB , BROWN E6 , SAND EC , GRAPHITE EG , BLACK EN
-----------	---

Legs finishes

Metal

MI	WHITE BB , BROWN E6 , SAND EC , GRAPHITE EG , BLACK EN
-----------	---

Top and extensions finishes

Melamine

H11	WHITE M01 , GRAFITE M02 , BLACK M04 , SAND M07
------------	--

Lacquered MDF

LMI	GRAPHITE GREY G02 , BLACK G04 , WHITE G05 , SAND G07 , BROWN G41
------------	---

Veneer

LI2	NATURAL OAK I22 , FLAMED WALNUT I24
------------	---

Fenix

HFI	BLACK FX4 , WHITE FX5
------------	-------------------------------------

Top and extensions finishes

Laminate

HLO	BLUE LBB, GRAFITE GREY LGD, ASH GREY LGS, CHERRY RED LRC, RED BULGARO LRS, SAND LS2
------------	---

Top finishes with matching lacquered MDF extensions

Satin Glass

GVC	MATT GRAFITE ANTISCRATCH J31, MATT SAND ANTISCRATCH J32
GVD	EXTRA CLEAR MATT WHITE ANTISCRATCH J41

Crystal Ceramic and Ceramic

GKA	PIOMBO K01, CHARCOAL SAVOIA K11, CEMENT SAVOIA K12, EMPERADOR MARBLE BRUSH.MATT BROWN K31
GKB	RUST OXIDE K23, WHITE CALCE K24

Glossy Glass

GVB	EXTRA CLEAR GLOSSY WHITE J21
------------	------------------------------

Crystal Ceramic and glossy Ceramic

GMA	MARBLE CALACATTA GLOSSY WHITE K32, BLACK GREEK MARBLE K33, MARBLE GLOSSY NOIR DESIR K35, MARBLE CALACATTA MATT WHITE K42, MARBLE MATT NOIR DESIR K45, MARBLE MATT GREEN TINOS K46
------------	---

Lacquered MDF extensions finishes, JUST for Glass and Crystal Ceramic tops

Lacquered MDF

LMI	GRAPHITE GREY G02, BLACK G04, WHITE G05, SAND G07, BROWN G41
------------	--

Optionals:

		Value	Options/notes
FM-M2	Indoor matt metal M2	+ 166 €	ASH GREY ES, BRONZE E2, BULGARO RED FP, CHERRY RED EQ, DARK GREEN EL, FACEPOWDER PINK E8, FANGO E3, GOLDEN YELLOW EO, LIGHT BLUE E0, LIGHT GREY ET, OCEAN BLUE E1, OCHER YELLOW E7, PAPAYA ORANGE EA, PASTEL YELLOW E4, PINE GREEN EJ, RED ER, SAGE GREEN E9

100/140 x70

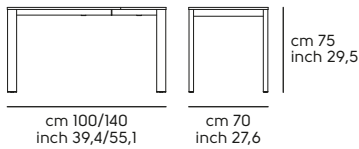

120/170 x80

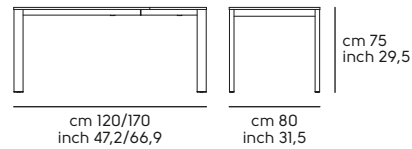

140/200 x90

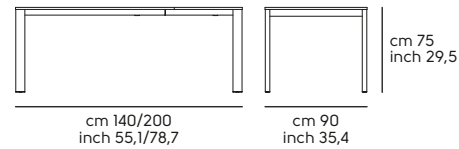

L 140/185/230 x90

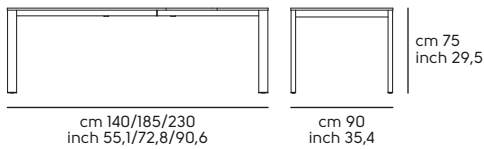

XL 110/155/200/245 x80

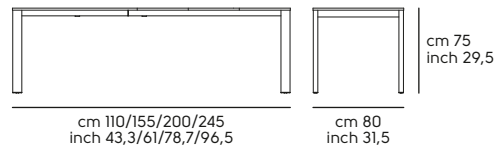

XL 140/190/240/290 x90

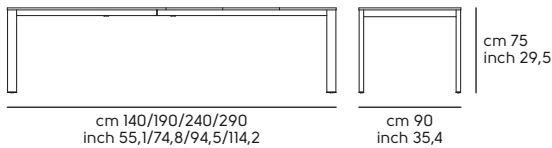

XL 160/210/260/310 x90

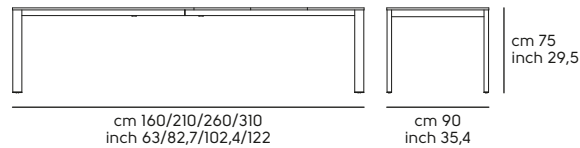

Blade design Paolo Vernier

Table Blade

Frame in: metal. Legs: covered with solid ash



Version	Code	Legs	Frame	Top and extensions	Optional	Q.ty	boxes	Kg	M ³
---------	------	------	-------	--------------------	----------	------	-------	----	----------------

Blade Melamine HL

Top and extensions 18 mm thk.

				HLI					
120/170 x80	T1801120			1.125 €	FM-M2	1	4	50.0	0.23
140/200 x90	T1801140			1.161 €		1	4	55.0	0.27
L 140/185/230 x90	T1802140	LFI	MI	1.251 €		1	5	60.0	0.28
XL 110/155/200/245 x80	T1803110			1.455 €		1	6	59.0	0.52
XL 140/190/240/290 x90	T1803140			1.830 €		1	6	71.0	0.52
XL 160/210/260/310 x90	T1803160			1.953 €		1	6	72.0	0.52

Blade MDF

Top and extensions 19 mm thk.

				LMI					
140/200 x90	T1801140			1.612 €	FM-M2	1	4	55.0	0.27
L 140/185/230 x90	T1802140	LFI	MI	1.933 €		1	5	60.0	0.28
XL 140/190/240/290 x90	T1803140			2.107 €		1	6	71.0	0.52
XL 160/210/260/310 x90	T1803160			2.227 €		1	6	72.0	0.52

Blade Fenix

Top and extensions 19 mm thk.

				HFI					
120/170 x80	T1805120			1.855 €	FM-M2	1	4	52.0	0.23
140/200 x90	T1805140			1.908 €		1	4	56.0	0.27
L 140/185/230 x90	T1806140	LFI	MI	2.135 €		1	5	60.0	0.28
XL 110/155/200/245 x80	T1807110			2.301 €		1	6	60.0	0.52
XL 140/190/240/290 x90	T1807140			2.822 €		1	6	72.0	0.52
XL 160/210/260/310 x90	T1803160			2.920 €		1	6	72.0	0.52

Blade Laminato

Top and extensions 19 mm thk.

				HLO					
120/170 x80	T1805120			1.523 €	FM-M2	1	4	52.0	0.23
140/200 x90	T1805140			1.565 €		1	4	56.0	0.27
L 140/185/230 x90	T1806140	LFI	MI	1.764 €		1	5	60.0	0.28
XL 110/155/200/245 x80	T1807110			1.901 €		1	6	60.0	0.52
XL 140/190/240/290 x90	T1807140			2.321 €		1	6	72.0	0.52
XL 160/210/260/310 x90	T1803160			2.405 €		1	6	72.0	0.52

Blade Veneer

Top and extensions 19 mm thk. | ATTENTION !: legs F24 and Top + extensions I24 are in different wood essences

				LI2						
L 140/185/230 x90	T1806140	LFI	MI	1.958 €		FM-M2	1	5	60.0	0.28
XL 160/210/260/310 x90	T1803160			2.478 €			1	6	72.0	0.52

Blade Glass

Glass top 10 mm thk. MDF extensions 19 mm thk.

				GVB	GVC	GVD					
120/170 x80	T1801120	LFI	MI	1.347 €	1.494 €	1.560 €	FM-M2	1	4	62.0	0.23
140/200 x90	T1801140			1.467 €	1.545 €	1.617 €		1	4	70.0	0.27
L 140/185/230 x90	T1802140			1.756 €	1.908 €	2.136 €		1	5	74.0	0.28
XL 110/155/200/245 x80	T1803110			1.802 €	1.917 €	2.081 €		1	6	71.0	0.52
XL 140/190/240/290 x90	T1803140			2.307 €	2.513 €	2.720 €		1	6	86.0	0.52
XL 160/210/260/310 x90	T1803160			2.410 €	2.644 €	2.868 €		1	6	86.0	0.52

Blade Ceramic

Ceramic top 11 mm thk and MDF extensions 19 mm thk | ATTENTION! GMA: Top Th. 14 mm. and Extensions Thk 22 mm.

				GKA	GKB	GMA					
120/170 x80	T1801120	LFI	MI	1.738 €	1.830 €	1.971 €	FM-M2	1	4	62.0	0.23
140/200 x90	T1801140			1.894 €	1.997 €	2.153 €		1	4	70.0	0.27
L 140/185/230 x90	T1802140			2.293 €	2.410 €	2.602 €		1	5	74.0	0.28
XL 110/155/200/245 x80	T1803110			2.237 €	2.371 €	2.571 €		1	6	71.0	0.52
XL 140/190/240/290 x90	T1803140			2.808 €	3.016 €	3.279 €		1	6	86.0	0.52
XL 160/210/260/310 x90	T1803160			2.963 €	3.059 €	3.363 €		1	6	86.0	0.52

Note:

For Glass or Crystal Ceramic tops, extensions ONLY in matching lacquered MDF

Frame finishes**Metal****MI** WHITE **BB**, BROWN **E6**, SAND **EC**, GRAPHITE **EG**, BLACK **EN****Legs finishes****Solid ash****LFI**Ash wood painted GREY **F02**, Ash wood painted GRAFITE GREY **F03**, Ash wood painted BLACK **F04**, Ash wood painted WHITE **F05**, Ash wood painted BLUE **F06**, Ash wood painted RED **F08**, Ash wood painted CHERRY RED **F09**, Ash wood painted FLAMED WALNUT **F24**, Ash wood painted DARK BROWN **F26**, Ash wood painted NATURAL **F40**, Ash wood painted NATURAL OAK **F52****Top and extensions finishes****Melamine****HLI** WHITE **M01**, GRAFITE **M02**, BLACK **M04**, SAND **M07****Lacquered MDF****LMI** GRAPHITE GREY **G02**, BLACK **G04**, WHITE **G05**, SAND **G07**, BROWN **G41****Laminate****HLO** BLUE **LBB**, GRAFITE GREY **LGD**, ASH GREY **LGS**, CHERRY RED **LRC**, RED BULGARO **LRS**, SAND **LS2****Veneer****LI2** NATURAL OAK **I22**, FLAMED WALNUT **I24****Fenix****HFI** BLACK **FX4**, WHITE **FX5**

Top finishes with matching lacquered MDF extensions

Satin Glass

GVC	MATT GRAFITE ANTISCRATCH J31 , MATT SAND ANTISCRATCH J32
GVD	EXTRA CLEAR MATT WHITE ANTISCRATCH J41

Crystal Ceramic and Ceramic

GKA	PIOMBO K01 , CHARCOAL SAVOIA K11 , CEMENT SAVOIA K12 , EMPERADOR MARBLE BRUSH.MATT BROWN K31
GKB	RUST OXIDE K23 , WHITE CALCE K24

Glossy Glass

GVB	EXTRA CLEAR GLOSSY WHITE J21 , EXTRA CLEAR GLOSSY CHERRY RED J25
------------	--

Crystal Ceramic and glossy Ceramic

GMA	MARBLE CALACATTA GLOSSY WHITE K32 , BLACK GREEK MARBLE K33 , MARBLE GLOSSY NOIR DESIR K35 , MARBLE CALACATTA MATT WHITE K42 , MARBLE MATT NOIR DESIR K45 , MARBLE MATT GREEN TINOS K46
------------	--

Lacquered MDF extensions finishes, JUST for Glass and Crystal Ceramic tops

Lacquered MDF

LMI	GRAPHITE GREY G02 , BLACK G04 , WHITE G05 , SAND G07 , BROWN G41
------------	---

Optionals:

		Value	Options/notes
FM-M2	Indoor matt metal M2	+ 158 €	ASH GREY ES , BRONZE E2 , BULGARO RED FP , CHERRY RED EQ , DARK GREEN EL , FACEPOWDER PINK E8 , FANGO E3 , GOLDEN YELLOW EO , LIGHT BLUE EO , LIGHT GREY ET , OCEAN BLUE E1 , OCHER YELLOW E7 , PAPAYA ORANGE EA , PASTEL YELLOW E4 , PINE GREEN EJ , RED ER , SAGE GREEN E9

120/170 x80

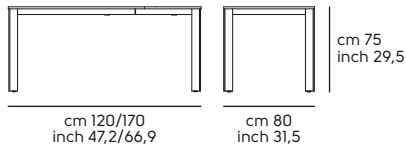

140/200 x90

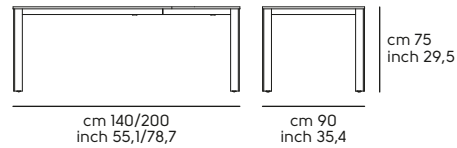

L 140/185/230 x90

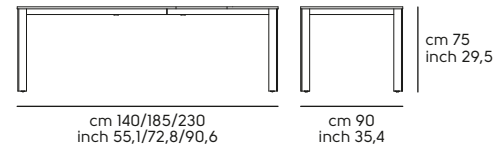

XL 110/155/200/245 x80

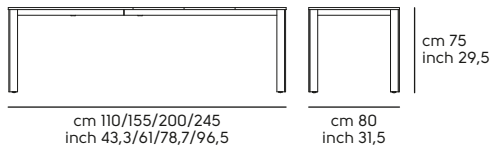

XL 140/190/240/290 x90

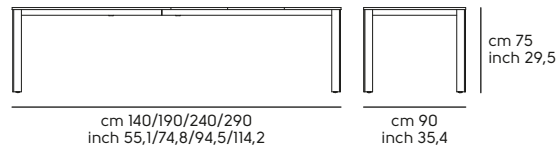

XL 160/210/260/310 x90

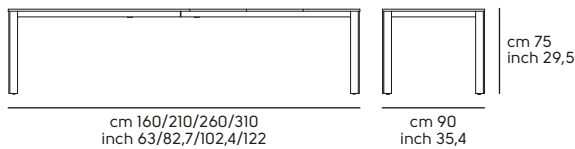

Brioso design Balutto Associati

Table Brioso

Frame in: metal



Version	Code	Legs	Frame	Top	Optional	Q.ty	boxes	Kg	M ³
---------	------	------	-------	-----	----------	------	-------	----	----------------

Brioso Glass

Top 10 mm. thk.

				GVB					
140 x80	T0150140			728 €					
160 x90	T0150160	M1	M1	847 €	FM-M2	1	3	44.0	0.28
180 x90	T0150180			894 €	FM-M3	1	3	52.0	0.3

Brioso Veneer

Top 19 mm. thk.

				L12					
140 x90_LG	T0150149			1.008 €					
160 x90_LG	T0150160	M1	M1	1.083 €	FM-M2	1	3	44.0	0.28
					FM-M3	1	3	52.0	0.3

Frame finishes

Metal

MI WHITE **BB**, INDUSTRIAL **E5**, BROWN **E6**, SAND **EC**, GRAPHITE **EG**, BLACK **EN**

Legs finishes

Metal

MI WHITE **BB**, INDUSTRIAL **E5**, BROWN **E6**, SAND **EC**, GRAPHITE **EG**, BLACK **EN**

Top finishes

Veneer

L12 NATURAL OAK **I22**, FLAMED WALNUT **I24**

Glossy Glass

GVB EXTRA CLEAR TRANSPARENT **J01**

Optionals:

		Value	Options/notes
FM-M2	Indoor matt metal M2	+ 100 €	ASH GREY ES , BRONZE E2 , BULGARO RED FP , CHERRY RED EQ , DARK GREEN EL , FACEPOWDER PINK E8 , FANGO E3 , GOLDEN YELLOW EO , LIGHT BLUE EO , LIGHT GREY ET , OCEAN BLUE E1 , OCHER YELLOW E7 , PAPAYA ORANGE EA , PASTEL YELLOW E4 , PINE GREEN EJ , RED ER , SAGE GREEN E9
FM-M3	Indoor glossy metal M3	+ 56 €	CHROME CC

140 x80

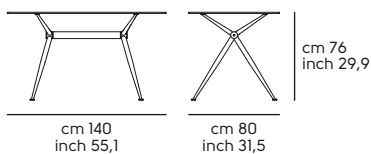

160 x90

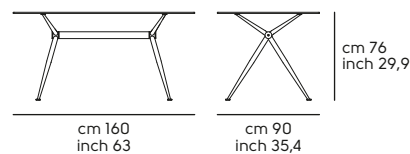

180 x90

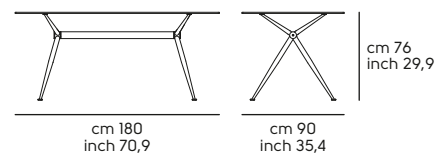

Clessidra design Paolo Vernier

Table Clessidra

Frame in: metal or wood-paneled, with metal insert



Version	Code	Insert	Frame	Top	Optional	Q.ty	boxes	Kg	M ³
---------	------	--------	-------	-----	----------	------	-------	----	----------------

Clessidra Veneer

Top D.150 20 mm. thk. - D.180 25 mm. thk.

				L11	L12					
D. 150	T1960150	M1- M2-M4	M1	2.565 €	2.700 €	FM-M2	1	2	150.0	0.7
D. 180	T1960180		M1	3.625 €	3.991 €		1	2	154.0	0.75
D. 150	T1961150		L11	3.376 €	3.510 €	FL-I2	1	2	145.0	0.7
D. 180	T1961180		L11	3.991 €	4.454 €		1	2	149.0	0.75

Clessidra Ceramic

Top D.150 16 mm. thk.

				GMA						
D. 150	T1960150	M1- M2-M4	M1	3.724 €		FM-M2	1	2	210.0	0.7
D. 150	T1961150		L11	4.561 €			FL-I2	1	2	205.0

Clessidra Marble

Top D.150 Top 2 mm. thk.

				GMM						
D. 150	T1960150	M1- M2-M4	M1	5.424 €		FM-M2	1	2	210.0	0.7
D. 150	T1961150		L11	6.235 €			FL-I2	1	2	205.0

Table Clessidra Double

Frame in: metal or wood-panelled, with metal insert



Version	Code	Insert	Frame	Top	Optional	Q.ty	boxes	Kg	M ³
Clessidra Veneer Top 25 mm. thk.									
				LI1					
				LI2					
300x150 Botte	T1960300	M1-	M1	5.120 €	FM-M2	1	3	300.0	1.4
300x150 Botte	T1961300	M2-M4	LI1	5.378 €	FL-I2	1	3	290.0	1.4

Clessidra Ceramic

Top 18 mm. thk.

				GMA					
300x150 Botte	T1960300	M1-	M1	5.396 €	FM-M2	1	3	420.0	1.4
300x150 Botte	T1961300	M2-M4	LI1	5.653 €	FL-I2	1	3	410.0	1.4

Frame finishes

Metal

M1	WHITE BB , BROWN E6 , SAND EC , GRAPHITE EG , BLACK EN , INDUSTRIAL E5
-----------	--

Veneer

LI1	Veneered wood painted GREY I02 , Veneered wood painted GRAFITE GREY I03 , Veneered wood painted BLACK I04 , Veneered wood painted WHITE I05 , Veneered wood painted BLUE I06 , Veneered wood painted RED I08 , Veneered wood painted CHERRY RED I09 , Veneered wood painted DARK BROWN I26 , Veneered wood painted NATURAL I40 , Veneered wood painted NATURAL OAK I52
------------	--

Insert finishes

Metal

M1	WHITE BB , BROWN E6 , SAND EC , GRAPHITE EG , BLACK EN
M2	LIGHT BLUE E0 , OCEAN BLUE E1 , BRONZE E2 , FANGO E3 , PASTEL YELLOW E4 , OCHER YELLOW E7 , FACEPOWDER PINK E8 , SAGE GREEN E9 , PAPAYA ORANGE EA , PINE GREEN EJ , DARK GREEN EL , GOLDEN YELLOW EO , CHERRY RED EQ , RED ER , ASH GREY ES , LIGHT GREY ET , BULGARO RED FP
M4	GOLDEN BRONZE DB , MATT GOLDEN BRONZE DC , CHAMPAGNE GOLD DG , PINK GOLD DR , MATT BLACK NICKEL DY , BLACK NICKEL DZ

Top finishes

Veneer

LI1	BLACK I04 , WHITE I05 , NATURAL I40
LI2	NATURAL OAK I22 , FLAMED WALNUT I24

Crystal Ceramic and glossy Ceramic

GMA	MARBLE CALACATTA GLOSSY WHITE K32 , BLACK GREEK MARBLE K33 , MARBLE GLOSSY NOIR DESIR K35 , MARBLE CALACATTA MATT WHITE K42 , MARBLE MATT NOIR DESIR K45
------------	---

Marble

GMM	BEIGE TRAVERTINO ROMANO MB2 , WHITE CALACATTA VAGLI MB4 , BLACK MARQUINIA MN4 , GREEN TINOS MVE
------------	---

Optionals:

		Value	Options/notes
FM-M2	Indoor matt metal M2	+ 198 €	ASH GREY ES , BRONZE E2 , BULGARO RED FP , CHERRY RED EQ , DARK GREEN EL , FACEPOWDER PINK E8 , FANGO E3 , GOLDEN YELLOW EO , LIGHT BLUE E0 , LIGHT GREY ET , OCEAN BLUE E1 , OCHER YELLOW E7 , PAPAYA ORANGE EA , PASTEL YELLOW E4 , PINE GREEN EJ , RED ER , SAGE GREEN E9
FL-I2	Veneered wood finish LI2	+ 210 €	Veneered wood FLAMED WALNUT I24 , Veneered wood NATURAL OAK I22

Table Clessidra D.100-120

Frame in: metal with metal insert

Version	Code	Insert	Frame	Top	Optional	Q.ty	boxes	Kg	M ³
---------	------	--------	-------	-----	----------	------	-------	----	----------------

Clessidra Melamine HL

Top 20 mm. thk.

				HL1					
D. 100	T1960100	M1-	M1	1.252 €	FM-M2	1	2	57.0	0.25
D. 120	T1960120	M2-M4		1.301 €		1	2	60.5	0.3

Clessidra Laminato

Top 19 mm. thk.

				HLO					
D. 100	T1960100	M1-	M1	1.619 €	FM-M2	1	2	58.0	0.25
D. 120	T1960120	M2-M4		1.676 €		1	2	63.0	0.3

Clessidra Fenix

Top 19 mm. thk.

				HF1					
D. 100	T1960100	M1-	M1	1.689 €	FM-M2	1	2	58.0	0.25
D. 120	T1960120	M2-M4		1.760 €		1	2	63.0	0.3

Clessidra Veneer

Top 20 mm. thk.

				LI1	LI2					
D. 100	T1960100	M1-	M1	1.643 €	1.731 €	FM-M2	1	2	58.0	0.25
D. 120	T1960120	M2-M4		1.698 €	1.786 €		1	2	63.0	0.3

Clessidra Glass

Top 10 mm. thk.

				GVB	GVC	GVD					
D. 100	T1960100	M1-	M1	1.632 €	1.820 €	1.918 €	FM-M2	1	2	72.0	0.25
D. 120	T1960120	M2-M4		1.762 €	1.940 €	2.062 €		1	2	79.0	0.3

Clessidra Ceramic

Top 11 mm. thk.

				GMA					
D. 100	T1960100	M1-	M1	2.172 €	FM-M2	1	2	78.0	0.25
D. 120	T1960120	M2-M4		2.403 €		1	2	85.0	0.3

Clessidra Marble

Top 20 mm. thk.

				GMM					
D. 100	T1960100	M1-	M1	2.724 €	FM-M2	1	2	92.0	0.25
D. 120	T1960120	M2-M4		3.087 €		1	2	110.0	0.3

Optionals:

		Value	Options/notes
FM-M2	Indoor matt metal M2	+ 198 €	ASH GREY ES , BRONZE E2 , BULGARO RED FP , CHERRY RED EQ , DARK GREEN EL , FACEPOWDER PINK E8 , FANGO E3 , GOLDEN YELLOW EO , LIGHT BLUE E0 , LIGHT GREY ET , OCEAN BLUE E1 , OCHER YELLOW E7 , PAPAYA ORANGE EA , PASTEL YELLOW E4 , PINE GREEN EJ , RED ER , SAGE GREEN E9

Lazy Susan

Top: Ceramic, Marble



Version	Code	Top Thickness	--	Top	Optional	Q.ty	boxes	Kg	M ³
Lazy Susan Ceramic Top Ø60 6 mm. thk.									
				GMA					
LS D. 60 H. 2.6	A2220060	0.6		375 €		1	1	7.0	0.01

Lazy Susan Marble Top Ø60 20 mm. thk.									
				GMM					
LS D. 60 H. 4.0	A2220060	2		662 €		1	1	16.0	0.02

Frame finishes

Metal

M1	WHITE BB , BROWN E6 , SAND EC , GRAPHITE EG , BLACK EN , INDUSTRIAL E5
-----------	--

Insert finishes

Metal

M1	WHITE BB , BROWN E6 , SAND EC , GRAPHITE EG , BLACK EN
M2	LIGHT BLUE E0 , OCEAN BLUE E1 , BRONZE E2 , FANGO E3 , PASTEL YELLOW E4 , OCHER YELLOW E7 , FACEPOWDER PINK E8 , SAGE GREEN E9 , PAPAYA ORANGE EA , PINE GREEN EJ , DARK GREEN EL , GOLDEN YELLOW EO , CHERRY RED EQ , RED ER , ASH GREY ES , LIGHT GREY ET , BULGARO RED FP
M4	GOLDEN BRONZE DB , MATT GOLDEN BRONZE DC , CHAMPAGNE GOLD DG , PINK GOLD DR , MATT BLACK NICKEL DY , BLACK NICKEL DZ

Top finishes

Veneer

LI1	BLACK I04, WHITE I05, NATURAL I40
LI2	NATURAL OAK I22, FLAMED WALNUT I24

Marble

GMM	BEIGE TRAVERTINO ROMANO MB2, WHITE CALACATTA VAGLI MB4, BLACK MARQUINIA MN4, GREEN TINOS MVE
------------	--

Melamine

HLI	WHITE M01, GRAFITE M02, BLACKM04, SAND M07
------------	--

Fenix

HFI	BLACK FX4, WHITE FX5
------------	----------------------

Crystal Ceramic and glossy Ceramic

GMA	MARBLE CALACATTA GLOSSY WHITE K32, BLACK GREEK MARBLE K33, MARBLE GLOSSY NOIR DESIR K35, MARBLE CALACATTA MATT WHITE K42, MARBLE MATT NOIR DESIR K45, MARBLE MATT GREEN TINOS K46
------------	---

Glossy Glass

GVB	EXTRA CLEAR GLOSSY CHERRY RED J25
GVC	MATT GRAFITE ANTISCRATCH J31, MATT SAND ANTISCRATCH J32
GVD	EXTRA CLEAR MATT WHITE ANTISCRATCH J41

Laminate

HLO	BLUE LBB, GRAFITE GREY LGD, ASH GREY LGS, CHERRY RED LRC, RED BULGARO LRS, SAND LS2
------------	---

HPL

HH1	WHITE/Black Core HB4, BLACK/Black Core HN4
HH2	CEMENT/Black Core HC6, CORTEN/Brown Core HC7, DARK GREY/Black Core HGW
HH3	WHITE/White Core WB4

D. 100

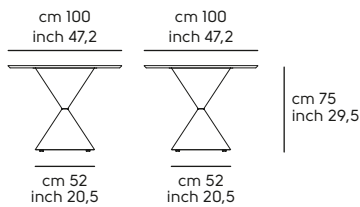

D. 120

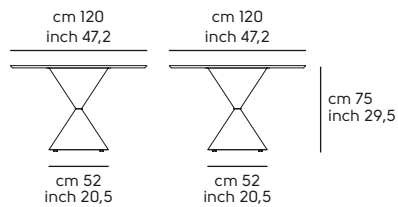

D. 150

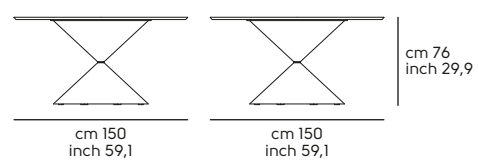

D. 180

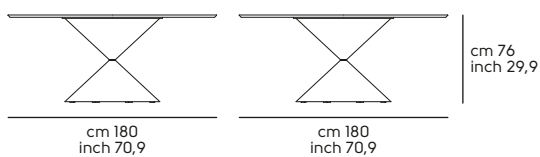

300x150 Botte

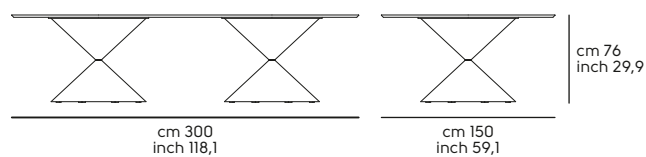

LS D. 60

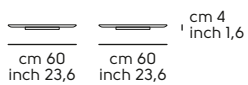

Dama design Jacopo Maria Giagnoni

Desk Dama

Frame in: metal



Version	Code	Legs	Frame	Top	Optional	Q.ty	boxes	Kg	M ³
---------	------	------	-------	-----	----------	------	-------	----	----------------

Dama Melamine HL

Top 18 mm. thk.

				HL1					
140x 80	T2070140			651 €		1	3	37,2	0,333
160x 80	T2070160	MI	MI	685 €	FM-M2 ZZ-PC	1	3	40,6	0,369
200x100	T2070200			832 €		1	3	52,5	0,556

Dama Veneer

Top 19 mm. thk.

				LI1					
140x 80	T2070140			975 €		1	3	37,2	0,333
160x 80	T2070160	MI	MI	1.037 €	FM-M2 ZZ-PC	1	3	40,6	0,369
200x100	T2070200			1.336 €		1	3	52,5	0,556

Dama Laminato

Top 19 mm. thk.

				HLO					
140x 80	T2070140			799 €		1	3	37,2	0,333
160x 80	T2070160	MI	MI	879 €	FM-M2 ZZ-PC	1	3	40,6	0,369
200x100	T2070200			1.000 €		1	3	52,5	0,556

Dama Fenix

Top 19 mm. thk.

				HF1					
140x 80	T2070140			941 €		1	3	37,2	0,333
160x 80	T2070160	MI	MI	1.020 €	FM-M2 ZZ-PC	1	3	40,6	0,369
200x100	T2070200			1.141 €		1	3	52,5	0,556

Dama HPL

Top 10 mm. thk.

				HH1	HH2	HH3					
140x 80	T2070140			923 €	1.046 €	1.117 €		1	3	40,0	0,333
160x 80	T2070160	MI	MI	992 €	1.126 €	1.232 €	FM-M2 ZZ-PC	1	3	43,75	0,369
200x100	T2070200			1.202 €	1.424 €	1.600 €		1	3	57,9	0,556

Dama Metallo

Top 15 mm. thk.

				M1	M2					
140x 80_MT	T2071140			817 €	873 €		1	3	43,9	0,333
160x 80_MT	T2071160	MI	MI	858 €	935 €	FM-M2	1	3	48,0	0,369
200x100_MT	T2071200			1.035 €	1.134 €	ZZ-PC	1	3	64,3	0,556

Desk Dama H.110

Frame in: metal

Version	Code	Legs	Frame	Top	Optional	Q.ty	boxes	Kg	M ³
---------	------	------	-------	-----	----------	------	-------	----	----------------

Dama H.110 Melamine HL

Top 18 mm. thk.

				HL1					
140x 80 H.110	T2075140			676 €	FM-M2 ZZ-PC	1	3	40,3	0,369
160x 80 H.110	T2075160	M1	M1	710 €		1	3	43,7	0,405
200x100 H.110	T2075200			856 €		1	3	55,6	0,592

Dama H.110 Veneer

Top 19 mm. thk.

				L11					
140x 80 H.110	T2075140			1.000 €	FM-M2 ZZ-PC	1	3	40,3	0,369
160x 80 H.110	T2075160	M1	M1	1.063 €		1	3	43,7	0,405
200x100 H.110	T2075200			1.361 €		1	3	55,6	0,592

Dama H.110 Laminato

Top 19 mm. thk.

				HLO					
140x 80 H.110	T2075140			823 €	FM-M2 ZZ-PC	1	3	40,3	0,369
160x 80 H.110	T2075160	M1	M1	904 €		1	3	43,7	0,405
200x100 H.110	T2075200			1.026 €		1	3	55,6	0,592

Dama H.110 Fenix

Top 19 mm. thk.

				HF1					
140x 80 H.110	T2075140			965 €	FM-M2 ZZ-PC	1	3	40,3	0,369
160x 80 H.110	T2075160	M1	M1	1.045 €		1	3	43,7	0,405
200x100 H.110	T2075200			1.167 €		1	3	55,6	0,592

Dama H.110 HPL

Top 10 mm. thk.

				HH1	HH2	HH3					
140x 80 H.110	T2075140			947 €	1.071 €	1.141 €	FM-M2 ZZ-PC	1	3	43,1	0,369
160x 80 H.110	T2075160	M1	M1	1.016 €	1.151 €	1.257 €		1	3	46,85	0,405
200x100 H.110	T2075200			1.226 €	1.449 €	1.625 €		1	3	61,0	0,592

Dama H.110 Metallo

Top 15 mm. thk.

				M1	M2					
140x 80_MT H.110	T2076140			841 €	897 €	FM-M2	1	3	47,0	0,369
160x 80_MT H.110	T2076160	M1	M1	883 €	961 €		1	3	51,1	0,405
200x100_MT H.110	T2076200			1.061 €	1.160 €		1	3	67,4	0,592

Note:

Frame finishes

Metal	
M1	WHITE BB , BROWN E6 , SAND EC , GRAPHITE EG , BLACK EN

Legs finishes

Metal	
M1	WHITE BB , BROWN E6 , SAND EC , GRAPHITE EG , BLACK EN

Top finishes

Melamine	
HL1	WHITE M01 , GRAFITE M02 , BLACK M04 , SAND M07

Veneer	
L11	NATURAL I40

HPL	
HH1	WHITE/Black Core HB4 , BLACK/Black Core HN4
HH2	CEMENT/Black Core HC6 , CORTEN/Brown Core HC7 , DARK GREY/Black Core HGW
HH3	WHITE/White Core WB4

Laminate	
HLO	BLUE LBB , GRAFITE GREY LGD , ASH GREY LGS , CHERRY RED LRC , RED BULGARO LRS , SAND LS2

Fenix	
HF1	BLACK FX4 , WHITE FX5

Metal	
M1	WHITE BB , BROWN E6 , SAND EC , GRAPHITE EG , BLACK EN
M2	LIGHT BLUE E0 , OCEAN BLUE E1 , BRONZE E2 , FANGO E3 , PASTEL YELLOW E4 , OCHER YELLOW E7 , FACEPOWDER PINK E8 , SAGE GREEN E9 , PAPAYA ORANGE EA , PINE GREEN EJ , DARK GREEN EL , GOLDEN YELLOW EO , CHERRY RED EQ , RED ER , ASH GREY ES , LIGHT GREY ET , BULGARO RED FP

Finishes Cable Management Box

Metal	
M1	WHITE, BLACK

Optionals:

		Value	Options/notes
FM-M2	Indoor matt metal M2	+ 66 €	ASH GREY ES , BRONZE E2 , BULGARO RED FP , CHERRY RED EQ , DARK GREEN EL , FACEPOWDER PINK E8 , FANGO E3 , GOLDEN YELLOW EO , LIGHT BLUE E0 , LIGHT GREY ET , OCEAN BLUE E1 , OCHER YELLOW E7 , PAPAYA ORANGE EA , PASTEL YELLOW E4 , PINE GREEN EJ , RED ER , SAGE GREEN E9
ZZ-PC	Cable management box 26x12	+ 122 €	ZZ-PC

140x 80

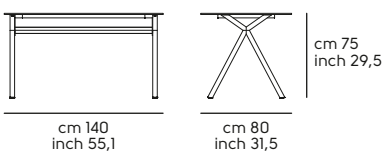

160x 80

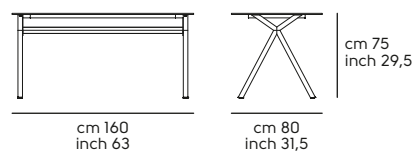

200x100

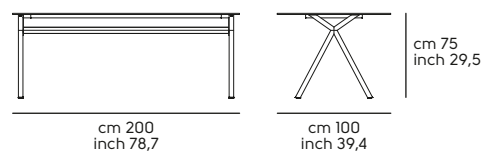

140x 80 H.110

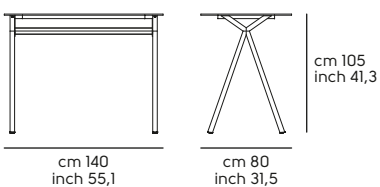

160x 80 H.110

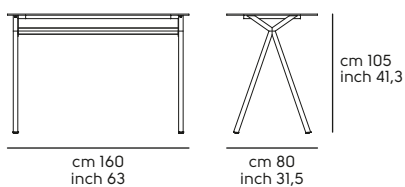

200x100 H.110

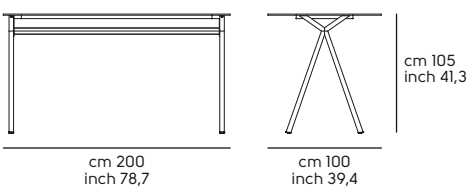

Cable management box



Diamante design Studio Kappa

Table Diamante

Frame in: metal



Version	Code	Legs	Frame	Top and extensions	Optional	Q.ty	boxes	Kg	M ³
---------	------	------	-------	--------------------	----------	------	-------	----	----------------

Diamante Melamine HL

Top and extensions 18 mm thk.

				HLI					
120/170 x80	T0160120			1.149 €	FM-M2	1	4	59.0	0.28
140/190 x90	T0160140		1.251 €	1		4	79.0	0.35	
160/210/260 x90	T0160160	M1	M1	1.377 €		1	5	92.0	0.41
190/240/290x100	T0160190			1.599 €		1	4	107.0	0.46

Version	Code	Legs	Frame	Top and extensions	Optional	Q.ty	boxes	Kg	M ³
---------	------	------	-------	--------------------	----------	------	-------	----	----------------

Diamante Fenix

Top and extensions 19 mm thk.

				HFI					
120/170 x80	T0160120			1.910 €	FM-M2	1	4	61.0	0.28
140/190 x90	T0160140	M1	M1	2.044 €		1	4	81.0	0.35
160/210/260 x90	T0160160			2.303 €		1	5	94.0	0.41

Version	Code	Legs	Frame	Top and extensions	Optional	Q.ty	boxes	Kg	M ³
---------	------	------	-------	--------------------	----------	------	-------	----	----------------

Diamante Laminato

Top and extensions 19 mm thk.

				HLO					
120/170 x80	T0160120			1.566 €	FM-M2	1	4	61.0	0.28
140/190 x90	T0160140	M1	M1	1.676 €		1	4	81.0	0.35
160/210/260 x90	T0160160			1.886 €		1	5	94.0	0.41

Diamante Glass

Glass top 10 mm thk. MDF extensions 19 mm thk.

				GVB	GVC	GVD					
120/170 x80	T0160120			1.360 €	1.537 €	1.674 €	FM-M2	1	4	59.0	0.28
140/190 x90	T0160140			1.475 €	1.649 €	1.788 €		1	4	79.0	0.35
160/210/260 x90	T0160160	M1	M1	1.700 €	1.881 €	2.007 €		1	5	92.0	0.41
190/240/290x100	T0160190			2.050 €	2.220 €	2.378 €		1	4	107.0	0.46

Diamante Ceramic

Ceramic top 11 mm thk and MDF extensions 19 mm thk | ATTENTION! GMA: Top Th. 14 mm. and Extensions Thk 22 mm.

				GKA	GKB	GMA					
120/170 x80	T0160120			1.854 €	1.978 €	2.179 €	FM-M2	1	4	59.0	0.28
140/190 x90	T0160140			1.998 €	2.142 €	2.356 €		1	4	79.0	0.35
160/210/260 x90	T0160160	M1	M1	2.338 €	2.559 €	2.814 €		1	5	92.0	0.41
190/240/290x100	T0160190			2.901 €	3.074 €	3.377 €		1	4	107.0	0.46

Note:

For Glass or Crystal Ceramic tops, extensions ONLY in matching lacquered MDF - 190/240/290x100 FT extensions in Ceramic

Frame finishes**Metal****MI** WHITE **BB**, BROWN **E6**, SAND **EC**, GRAPHITE **EG**, BLACK **EN****Legs finishes****Metal****MI** WHITE **BB**, BROWN **E6**, SAND **EC**, GRAPHITE **EG**, BLACK **EN****Top and extensions finishes****Melamine****HLI** WHITE M01, GRAFITE M02, BLACKM04, SAND M07**Laminate****HLO** BLUE LBB, GRAFITE GREY LGD, ASH GREY LGS, CHERRY RED LRC, RED BULGARO LRS, SAND LS2**Fenix****HFI** BLACK FX4, WHITE FX5**Top finishes with matching lacquered MDF extensions****Satin Glass****GVC** MATT GRAFITE ANTISCRATCH **J31**, MATT SAND ANTISCRATCH **J32****GVD** EXTRA CLEAR MATT WHITE ANTISCRATCH **J41****Glossy Glass****GVB** EXTRA CLEAR GLOSSY WHITE **J21****Crystal Ceramic and Ceramic****GKA** PIOMBO **K01**, CHARCOAL SAVOIA **K11**, CEMENT SAVOIA **K12**, EMPERADOR MARBLE BRUSH.MATT BROWN **K31****GKB** RUST OXIDE **K23**, WHITE CALCE **K24****Crystal Ceramic and glossy Ceramic****GMA** MARBLE CALACATTA GLOSSY WHITE **K32**, BLACK GREEK MARBLE **K33**, MARBLE GLOSSY NOIR DESIR **K35**, MARBLE CALACATTA MATT WHITE **K42**, MARBLE MATT NOIR DESIR **K45**, MARBLE MATT GREEN TINOS **K46****Lacquered MDF extensions finishes, JUST for Glass and Crystal Ceramic tops****Lacquered MDF****LMI** GRAPHITE GREY **G02**, BLACK **G04**, WHITE **G05**, SAND **G07**, BROWN **G41****Optionals:**

		Value	Options/notes
FM-M2	Indoor matt metal M2	+ 166 €	ASH GREY ES , BRONZE E2 , BULGARO RED FP , CHERRY RED EQ , DARK GREEN EL , FACEPOWDER PINK E8 , FANGO E3 , GOLDEN YELLOW EO , LIGHT BLUE EO , LIGHT GREY ET , OCEAN BLUE E1 , OCHER YELLOW E7 , PAPAYA ORANGE EA , PASTEL YELLOW E4 , PINE GREEN EJ , RED ER , SAGE GREEN E9

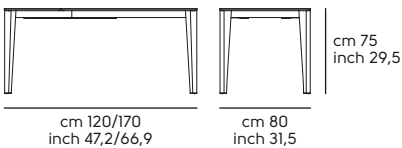
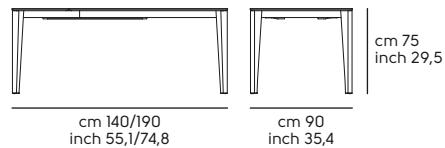
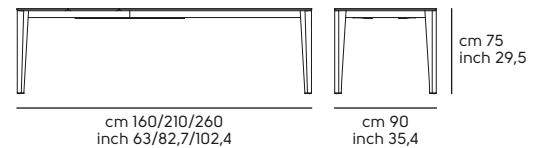
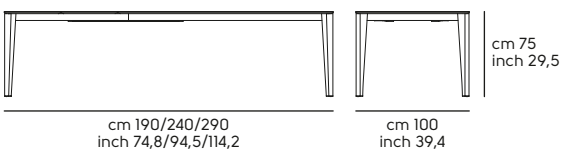
120/170 x80**140/190 x90****160/210/260 x90****190/240/290x100**

Forest design Beatriz Sempere

Table Forest

Frame in: metal



Version	Code	Legs	Frame	Top	Optional	Q.ty	boxes	Kg	M ³
---------	------	------	-------	-----	----------	------	-------	----	----------------

Forest Veneer

Top 20 mm. thk.

				LI1	LI2					
D. 150	T1702150	M1	M1	2.884 €	3.020 €	FM-M2	1	4	108.0	1.4
280x120 Ellittico	T1706280			3.819 €	4.010 €		1	4	137.0	1.87

Note:

280x120 Top I04 BLACK - I24 FLAMED WALNUT

Forest Wood

Top 40 mm. thk.

				LS1	LS2					
200x106	T1700200	M1	M1	3.883 €	4.172 €	FM-M2	1	4	142.0	1.4
250x106	T1700250			4.430 €	4.727 €		1	4	169.0	1.73

Version	Code	Legs	Frame	Top	Optional	Q.ty	boxes	Kg	M ³
---------	------	------	-------	-----	----------	------	-------	----	----------------

Forest Ceramic

Top 16 mm. thk. D.150 - Top 18 mm. thk. Elliptical 280x120

				GMA						
D. 150	T1702150	M1	M1	4.008 €		FM-M2	1	4	148.0	1.4
280x120 Ellittico	T1706280			5.694 €			1	4	202.0	1.87

Version	Code	Legs	Frame	Top	Optional	Q.ty	boxes	Kg	M ³
---------	------	------	-------	-----	----------	------	-------	----	----------------

Forest Marble

Top 20 mm. thk.

				GMM						
D. 150	T1702150	M1	M1	5.458 €		FM-M2	1	4	180.0	1.4
280x120 Ellittico	T1706280			6.880 €			1	4	250.0	1.9

Note:

For D.150 NO Crystal Ceramic top GMA K46

Frame finishes

Metal	
M1	WHITE BB , BROWN E6 , SAND EC , GRAPHITE EG , BLACK EN

Legs finishes

Metal	
M1	WHITE BB , BROWN E6 , SAND EC , GRAPHITE EG , BLACK EN

Top finishes

Veneer	
L11	BLACK I04 , WHITE I05 , NATURAL I40
L12	NATURAL OAK I22 , FLAMED WALNUT I24

Solid wood	
LS1	IM OAK STRAIGHT EDGE WR1
LS2	SOLID WALNUT BARK EDGE WN1

Crystal Ceramic and glossy Ceramic	
GMA	MARBLE CALACATTA GLOSSY WHITE K32 , BLACK GREEK MARBLE K33 , MARBLE GLOSSY NOIR DESIR K35 , MARBLE CALACATTA MATT WHITE K42 , MARBLE MATT NOIR DESIR K45 , MARBLE MATT GREEN TINOS K46

Marble	
GMM	BEIGE TRAVERTINO ROMANO MB2 , WHITE CALACATTA VAGLI MB4 , BLACK MARQUINIA MN4 , GREEN TINOS MVE

Optionals:

	Value	Options/notes
FM-M2	Indoor matt metal M2	+ 198 €
		ASH GREY ES , BRONZE E2 , BRONZE EZ + TRANSP., BULGARO RED FP , CHERRY RED EQ , DARK GREEN EL , FACEPOWDER PINK E8 , FANGO E3 , GOLDEN YELLOW EO , LIGHT BLUE E0 , LIGHT GREY ET , OCEAN BLUE E1 , OCHER YELLOW E7 , PAPAYA ORANGE EA , PASTEL YELLOW E4 , PINE GREEN EJ , RED ER , SAGE GREEN E9

D. 150

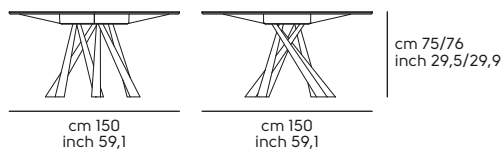

280x120 Ellittico

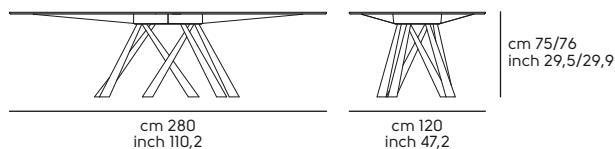

200x106

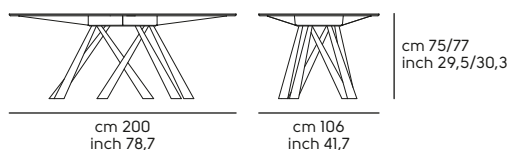

250x106

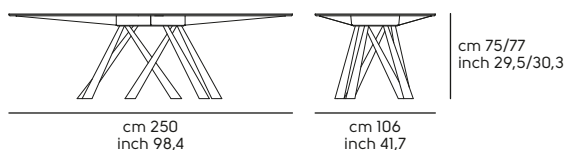

Gran Sasso design Andrea Lucatello

Table Gran Sasso

Frame in: baydur with hide inserts



Version	Code	Insert	Frame	Top	Optional	Q.ty	boxes	Kg	M ³
---------	------	--------	-------	-----	----------	------	-------	----	----------------

Gran Sasso Glass

Top 15 mm. thk. - 250x120 CATAS certificated

				GVB	GVE	GVH					
220x116 Botte	T1821220	CK	PBI	3.572 €	3.925 €	4.388 €	FP-B2 RV-CT	1	2	150.0	0.77
250x120 Botte	T1821250			4.013 €	4.278 €	4.642 €		1	2	165.0	0.77

Gran Sasso Ceramic

Top 18 mm. thk. - 250x120 CATAS certificated

				GMA							
220x116 Botte	T1821220	CK	PBI				FP-B2 RV-CT	1	2	175.0	0.77
250x120 Botte	T1821250							5.154 €	1	2	195.0

Frame finishes

Baydur

PBI	WHITE BB4 , ASH GREY BGS , DARK GREY BGW
------------	---

Insert finishes

Hide

CK	HIDE_TK
-----------	---------

Top finishes

Glossy Glass

GVB	EXTRA CLEAR TRANSPARENT J01
GVE	GLOSSY FUME' J05

Glass with Bucciato finish

GVH	BUCCIATO FUME' J50
------------	---------------------------

Crystal Ceramic and glossy Ceramic

GMA	MARBLE CALACATTA GLOSSY WHITE K32 , BLACK GREEK MARBLE K33 , MARBLE GLOSSY NOIR DESIR K35 , MARBLE CALACATTA MATT WHITE K42 , MARBLE MATT NOIR DESIR K45 , MARBLE MATT GREEN TINOS K46
------------	--

Optionals:

		Value	Options/notes
FP-B2	Baydur PB2	+ 982 €	BRUSHED CONCRETE DARK GREY CGW , BRUSHED CONCRETE LIGHT GREY CGT
RV-CT	Tuscan hide	+ 88 €	TUSCAN HIDE

220x116 Botte

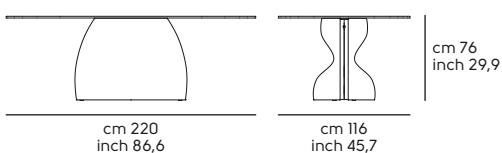

250x120 Botte

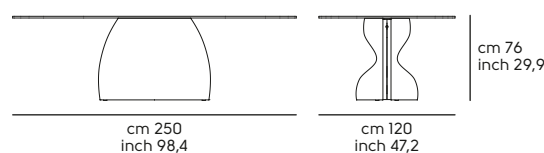

Infinity design Midj R&D

Table Infinity

Frame in: metal



Version	Code	--	Frame	Top	Optional	Q.ty	boxes	Kg	M ³
---------	------	----	-------	-----	----------	------	-------	----	----------------

Infinity Melamine HL

Top 18 mm. thk. D. 60-70-80- Top 36 mm. thk. D.90-100-120

				HL1					
Base D.44 / Top D. 60	T0190D06			368 €		1	2	16.5	0.23
Base D.44 / Top D. 70	T0190D07			391 €		1	2	19.5	0.24
Base D.44 / Top D. 80	T0190D08		MI	414 €	FM-M2 FM-M3	1	2	22.5	0.26
Base D.70 / Top D. 90	T0190D09			434 €		1	2	28.0	0.2
Base D.70 / Top D.100	T0190D10			589 €		1	2	35.0	0.2
Base D.70 / Top D.120	T0190D12			638 €		1	2	44.0	0.25

Infinity HPL

Top 10 mm. thk.

				HH1	HH2	HH3					
Base D.44 / Top D. 60	T0190D06			436 €	447 €	480 €	FM-M2 FM-M3	1	2	16.5	0.23
Base D.44 / Top D. 70	T0190D07		MI	494 €	505 €	539 €		1	2	19.5	0.24
Base D.44 / Top D. 80	T0190D08			510 €	521 €	550 €		1	2	22.5	0.26
Base D.70 / Top D. 90	T0190D09			689 €	698 €	715 €		1	2	26.0	0.26

Infinity Fenix

Top 19 mm. thk.

				HF1						
Base D.44 / Top D. 60	T0190D06			497 €	FM-M2 FM-M3	1	2	16.5	0.23	
Base D.44 / Top D. 70	T0190D07		MI	519 €		1	2	19.5	0.24	
Base D.44 / Top D. 80	T0190D08			541 €		1	2	22.5	0.26	
Base D.70 / Top D. 90	T0190D09			695 €		1	2	28.0	0.2	
Base D.70 / Top D.100	T0190D10			734 €		1	2	35.0	0.2	
Base D.70 / Top D.120	T0190D12			805 €		1	2	44.0	0.25	

Infinity Laminato

Top 19 mm. thk.

				HLO						
Base D.44 / Top D. 60	T0190D06			397 €	FM-M2 FM-M3	1	2	16.5	0.23	
Base D.44 / Top D. 70	T0190D07		MI	415 €		1	2	19.5	0.24	
Base D.44 / Top D. 80	T0190D08			433 €		1	2	22.5	0.26	
Base D.70 / Top D. 90	T0190D09			555 €		1	2	28.0	0.2	
Base D.70 / Top D.100	T0190D10			588 €		1	2	35.0	0.2	
Base D.70 / Top D.120	T0190D12			644 €		1	2	44.0	0.25	

Infinity Glass

Top 10 mm. thk.

					GVB						
Base D.44 / Top D. 60	T0190D06				531 €			1	2	16.5	0.23
Base D.44 / Top D. 70	T0190D07				550 €			1	2	19.5	0.24
Base D.44 / Top D. 80	T0190D08				573 €			1	2	22.5	0.26
Base D.70 / Top D. 90	T0190D09		M1		757 €			1	2	30.0	0.2
Base D.70 / Top D.100	T0190D10				860 €			1	2	35.0	0.2
Base D.70 / Top D.120	T0190D12				941 €			1	2	44.0	0.25

Infinity Ceramic

Top 11 mm. thk. D. 60-80- 13 mm. thk. D.100-120 | ATTENTION! Calacatta: Top 14 mm. thk. D. 60-80- Top 16 mm. thk. D.100-120

					GKA	GKB	GMA					
Base D.44 / Top D. 60	T0190D06				743 €	795 €	838 €		1	2	16.5	0.23
Base D.44 / Top D. 70	T0190D07				877 €	987 €	1.048 €		1	2	19.5	0.24
Base D.44 / Top D. 80	T0190D08				1.046 €	1.151 €	1.252 €		1	2	22.5	0.26
Base D.70 / Top D. 90	T0190D09		M1		1.092 €	1.158 €	1.322 €	FM-M2 FM-M3	1	2	28.0	0.2
Base D.70 / Top D.100	T0190D10				1.106 €	1.265 €	1.348 €		1	2	35.0	0.2
Base D.70 / Top D.120	T0190D12				--	--	1.604 €		1	2	44.0	0.25

Infinity Metal

Top 15 mm. thk.

					M1	M2						
Base D.44 / Top D. 60_MT	T0191D06				435 €	462 €			1	2	16.5	0.23
Base D.44 / Top D. 70_MT	T0191D07			M1	460 €	487 €			1	2	19.5	0.24
Base D.44 / Top D. 80_MT	T0191D08				523 €	550 €			1	2	22.5	0.26

Infinity Metal

Top 3 mm. thk.

					M1	M2						
Base D.44 / Top D. 70_SP.3	T0192D07			M1	475 €	512 €			1	2	19.5	0.24
Base D.44 / Top D. 80_SP.3	T0192D08				541 €	582 €			1	2	22.5	0.26

Frame finishes

Metal

MI	WHITE BB , BROWN E6 , SAND EC , GRAPHITE EG , BLACK EN
-----------	---

Top finishes

Melamine

HL1	WHITE M01 , GRAFITE M02 , BLACK M04 , SAND M07
------------	--

HPL

HH1	WHITE/Black Core HB4 , BLACK/Black Core HN4
HH2	CEMENT/Black Core HC6 , CORTEN/Brown Core HC7 , DARK GREY/Black Core HGW
HH3	WHITE/White Core WB4

Fenix

HFI	BLACK FX4 , WHITE FX5
------------	-------------------------------------

Crystal Ceramic and Ceramic

GKA	PIOMBO K01 , CHARCOAL SAVOIA K11 , CEMENT SAVOIA K12 , EMPERADOR MARBLE BRUSH.MATT BROWN K31
GKB	RUST OXIDE K23 , WHITE CALCE K24

Metal

MI	WHITE BB , BROWN E6 , SAND EC , GRAPHITE EG , BLACK EN
M2	LIGHT BLUE E0 , OCEAN BLUE E1 , BRONZE E2 , FANGO E3 , PASTEL YELLOW E4 , OCHER YELLOW E7 , FACEPOWDER PINK E8 , SAGE GREEN E9 , PAPAYA ORANGE EA , PINE GREEN EJ , DARK GREEN EL , GOLDEN YELLOW EO , CHERRY RED EQ , RED ER , ASH GREY ES , LIGHT GREY ET , BULGARO RED FP

Laminate

HLO	BLUE LBB , GRAFITE GREY LGD , ASH GREY LGS , CHERRY RED LRC , RED BULGARO LRS , SAND LS2
------------	--

Glossy Glass

GVB	EXTRA CLEAR TRANSPARENT J01
------------	------------------------------------

Crystal Ceramic and glossy Ceramic

GMA	MARBLE CALACATTA GLOSSY WHITE K32 , BLACK GREEK MARBLE K33 , MARBLE GLOSSY NOIR DESIR K35 , MARBLE CALACATTA MATT WHITE K42 , MARBLE MATT NOIR DESIR K45 , MARBLE MATT GREEN TINOS K46
------------	--

Optionals:

		Value	Options/notes
FM-M3	Indoor glossy metal M3	+ 66 €	CHROME CC
FM-M2	Indoor matt metal M2	+ 132 €	ASH GREY ES , BRONZE E2 , BULGARO RED FP , CHERRY RED EQ , DARK GREEN EL , FACEPOWDER PINK E8 , FANGO E3 , GOLDEN YELLOW EO , LIGHT BLUE E0 , LIGHT GREY ET , OCEAN BLUE E1 , OCHER YELLOW E7 , PAPAYA ORANGE EA , PASTEL YELLOW E4 , PINE GREEN EJ , RED ER , SAGE GREEN E9

Base D.44 / Top D. 60

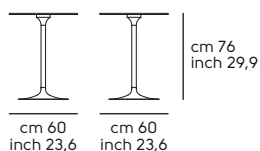

Base D.44 / Top D. 70

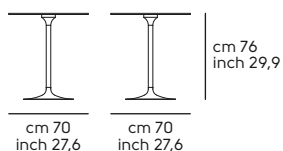

Base D.44 / Top D. 80

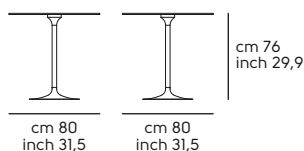

Base D.70 / Top D.90

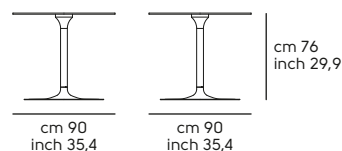

Base D.70 / Top D.100

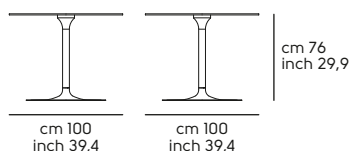

Base D.70 / Top D.120

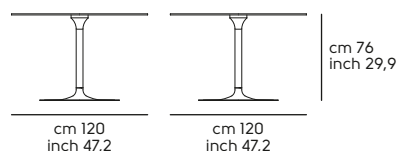

Lea design Paolo Vernier

T A B L E S

Table Lea

Frame in: metal



Version	Code	--	Frame	Top	Optional	Q.ty	boxes	Kg	M³
---------	------	----	-------	-----	----------	------	-------	----	----

Lea Veneer

Top 19 mm. thk.

				L11	L12					
190x115	T1940190		M1	2.481 €	2.613 €	FM-M2	1	3	100.0	0.35
220x120	T1940220		M1	2.636 €	2.889 €		1	3	140.0	0.53

Lea Ceramic

Top 16 mm. thk.

				GKA	GMA					
190x115	T1940190		M1	3.297 €	3.726 €	FM-M2	1	3	100.0	0.35
220x120	T1940220		M1	3.738 €	3.959 €		1	3	140.0	0.53

Frame finishes

Metal

MI WHITE **BB**, BROWN **E6**, SAND **EC**, GRAPHITE **EG**, BLACK **EN**

Legs finishes

Metal

MI WHITE **BB**, BROWN **E6**, SAND **EC**, GRAPHITE **EG**, BLACK **EN**

Top finishes

Veneer

L11 BLACK **I04**, NATURAL **I40**

L12 NATURAL OAK **I22**, FLAMED WALNUT **I24**

Crystal Ceramic and glossy Ceramic

GKA EMPERADOR MARBLE BRUSH.MATT BROWN **K31**

GMA MARBLE CALACATTA GLOSSY WHITE **K32**, BLACK GREEK MARBLE **K33**, MARBLE GLOSSY NOIR DESIR **K35**, MARBLE CALACATTA MATT WHITE **K42**, MARBLE MATT NOIR DESIR **K45**, MARBLE MATT GREEN TINOS **K46**

Optionals:

		Value	Options/notes
FM-M2	Indoor matt metal M2	+ 166 €	ASH GREY ES , BRONZE E2 , BULGARO RED FP , CHERRY RED EQ , DARK GREEN EL , FACEPOWDER PINK E8 , FANGO E3 , GOLDEN YELLOW EO , LIGHT BLUE EO , LIGHT GREY ET , OCEAN BLUE E1 , OCHER YELLOW E7 , PAPAYA ORANGE EA , PASTEL YELLOW E4 , PINE GREEN EJ , RED ER , SAGE GREEN E9

190x115

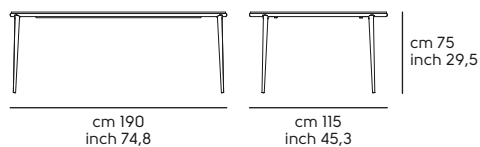

220x120

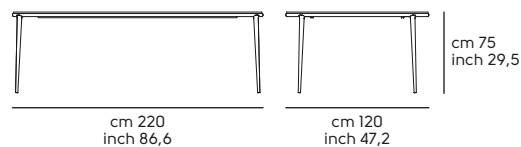

Link design Studio 28

Table Link

Frame in: metal



Version	Code	Legs	Frame	Top and extensions	Optional	Q.ty	boxes	Kg	M³
---------	------	------	-------	--------------------	----------	------	-------	----	----

Link Veneer

Top and extensions 20 mm thk.

				L11	L12				
D. 120/180	T0220D12			2.544 €	2.571 €				
120/180x120 - Botte	T0220I20	MI	MI	2.496 €	2.545 €	FM-M2	1	2	51.0 0.92
							1	2	51.0 0.92

Link Ceramic

Top 13 mm. thk - Extensions 19 mm thk. | GMA: Top 16 mm. thk. - Extensions 22 mm. thk.

				GKA	GKB				
D. 120/180	T0220D12			3.762 €	3.862 €				
120/180x120 - Botte	T0220I20	MI	MI	3.732 €	3.834 €	FM-M2	1	2	51.0 0.92
							1	2	51.0 0.92

Note:

For wooden or Glass ceramic tops, extensions in the same material

Frame finishes

Metal

MI WHITE **BB**, BROWN **E6**, SAND **EC**, GRAPHITE **EG**, BLACK **EN**

Legs finishes

Metal

MI WHITE **BB**, BROWN **E6**, SAND **EC**, GRAPHITE **EG**, BLACK **EN**

Top and extensions finishes

Veneer

L11 BLACK **I04**, WHITE **I05**, NATURAL **I40**

L12 NATURAL OAK **I22**, FLAMED WALNUT **I24**

Crystal Ceramic and Ceramic

GKA PIOMBO **K01**, CHARCOAL SAVOIA **K11**, CEMENT SAVOIA **K12**, EMPERADOR MARBLE BRUSH.MATT BROWN **K31**

GKB RUST OXIDE **K23**, WHITE CALCE **K24**

Optionals:

	Value	Options/notes
FM-M2 Indoor matt metal M2	+ 166 €	ASH GREY ES , BRONZE E2 , BULGARO RED FP , CHERRY RED EQ , DARK GREEN EL , FACEPOWDER PINK E8 , FANGO E3 , GOLDEN YELLOW EO , LIGHT BLUE E0 , LIGHT GREY ET , OCEAN BLUE E1 , OCHER YELLOW E7 , PAPAYA ORANGE EA , PASTEL YELLOW E4 , PINE GREEN EJ , RED ER , SAGE GREEN E9

D. 120/180

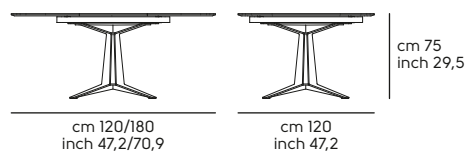

120/180x120 - Botte

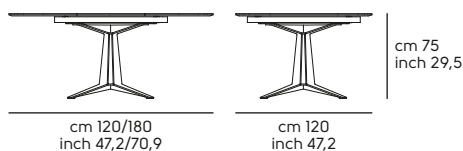

Marcopolo design Paolo Vernier

Table Marcopolo

Frame in: metal



Version	Code	Legs	Frame	Top and extensions	Optional	Q.ty	boxes	Kg	M ³
---------	------	------	-------	--------------------	----------	------	-------	----	----------------

Marcopolo Glass

Top and extensions 10 mm thk.

				GVC	GVD					
140/230x140	T1848140	M1	M1	3.128 €	3.293 €	FM-M2	1	3	116.0	1.35

Marcopolo Ceramic

Top and extensions 11 mm thk. | ATTENTION ! GMA: Top and Extensions 14 mm thk.

				GKA	GMA					
140/230x140	T1848140	M1	M1	4.295 €	4.953 €	FM-M2	1	3	116.0	1.35

Marcopolo Veneer

Top and extensions 14 mm thk.

				LI1	LI2					
140/230x140	T1840140	M1	M1	4.400 €	5.204 €	FM-M2	1	3	85.0	1.35

Frame finishes

Metal

MI WHITE **BB**, BROWN **E6**, SAND **EC**, GRAPHITE **EG**, BLACK **EN**

Legs finishes

Metal

MI WHITE **BB**, BROWN **E6**, SAND **EC**, GRAPHITE **EG**, BLACK **EN**

Top and extensions finishes

Veneer

LI1 BLACK **I04**
LI2 NATURAL OAK **I22**, FLAMED WALNUT **I24**

Satin Glass

GVC MATT GRAFITE ANTISCRATCH **J31**, MATT SAND ANTISCRATCH **J32**
GVD EXTRA CLEAR MATT WHITE ANTISCRATCH **J41**

Crystal Ceramic and Ceramic

GKA CHARCOAL SAVOIA **K11**, CEMENT SAVOIA **K12**

Crystal Ceramic and glossy Ceramic

GMA MARBLE CALACATTA GLOSSY WHITE **K32**, BLACK GREEK MARBLE **K33**, MARBLE GLOSSY NOIR DESIR **K35**, MARBLE CALACATTA MATT WHITE **K42**, MARBLE MATT NOIR DESIR **K45**

Optionals:

	Value	Options/notes
FM-M2	Indoor matt metal M2	+ 166 € ASH GREY ES , BRONZE E2 , BULGARO RED FP , CHERRY RED EQ , DARK GREEN EL , FACEPOWDER PINK E8 , FANGO E3 , GOLDEN YELLOW EO , LIGHT BLUE EO , LIGHT GREY ET , OCEAN BLUE E1 , OCHER YELLOW E7 , PAPAYA ORANGE EA , PASTEL YELLOW E4 , PINE GREEN EJ , RED ER , SAGE GREEN E9

140/230x140

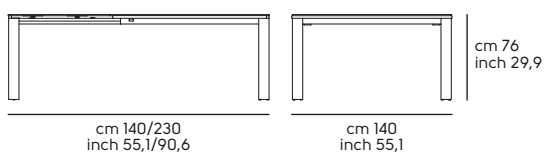

Master design Paolo Vernier

Table Master

Frame in: metal



T
A
B
L
E
S

Version	Code	Legs	Frame	Top / Top and extensions	Optional	Q.ty	boxes	Kg	M ³
---------	------	------	-------	--------------------------	----------	------	-------	----	----------------

Master Fenix

Top and extensions 25 mm thk.

				HF1					
190x100	T1710190			1.590 €	1	3	70.0	0.39	
140/190 x90	T1715140	MI	MI	1.733 €	1	4	52.0	0.49	
160/210 x90	T1715160			1.869 €	1	4	64.5	0.51	

Note:

For Fenix tops, extensions ONLY in Fenix

Frame finishes

Metal

MI WHITE BB, BLACK EN

Legs finishes

Metal

MI WHITE BB, BLACK EN

Top and extensions finishes

Fenix

HF1 BLACK FX4, WHITE FX5

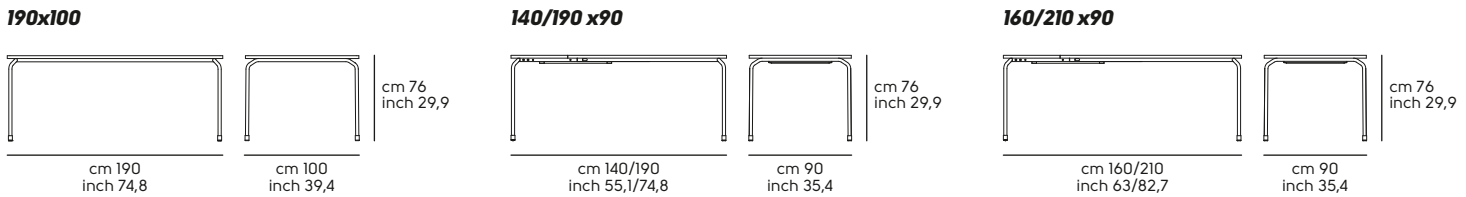

Moonlight design Franco Poli

Table Moonlight

Frame in: baydur



Version	Code	--	Frame	Top	Optional	Q.ty	boxes	Kg	M ³
---------	------	----	-------	-----	----------	------	-------	----	----------------

Moonlight Glass

Top 12 mm. thk.

				GVB	GVE				
200x100	T0240200		PBI	2.575 €	2.739 €	1	2	88.0	0.6
220x116	T0240220		PBI	2.722 €	2.861 €	1	2	105.0	0.6

Moonlight Ceramic

Top 16 mm. thk.

				GMA					
200x100	T0240200		PBI	4.260 €		1	2	88.0	0.6
220x116	T0240220		PBI	4.627 €		1	2	105.0	0.6

Frame finishes

Baydur

PBI WHITE BB4, DARK GREY BGW

Top finishes

Glossy Glass

GVB EXTRA CLEAR TRANSPARENT J01

GVE GLOSSY FUME' J05

Crystal Ceramic and glossy Ceramic

GMA MARBLE CALACATTA GLOSSY WHITE K32, BLACK GREEK MARBLE K33, MARBLE GLOSSY NOIR DESIR K35, MARBLE CALACATTA MATT WHITE K42, MARBLE MATT NOIR DESIR K45, MARBLE MATT GREEN TINOS K46

200x100

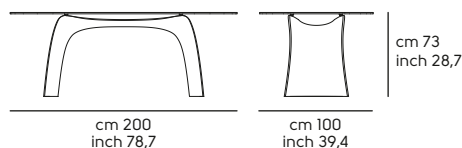

220x116

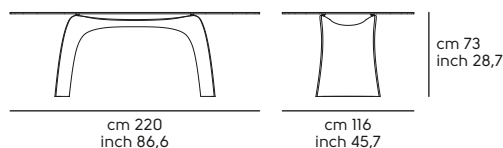

More design Midj R&D

Table More

Frame in: metal



Version	Code	Legs	Frame	Top and extensions	Optional	Q.ty	boxes	Kg	M ³
---------	------	------	-------	--------------------	----------	------	-------	----	----------------

More Melamine HL

Top and extensions 18 mm thk.

				HL1					
100/140 x70	T1811100			849 €		1	4	40.0	0.19
120/170 x80	T1811120			962 €		1	4	46.0	0.23
140/200 x90	T1811140			979 €		1	4	51.0	0.27
L 140/185/230 x90	T1812140	MI	MI	1.108 €	FM-M2	1	5	54.0	0.28
XL 110/155/200/245x 80	T1813110			1.317 €		1	5	55.0	0.32
XL 140/190/240/290x 90	T1813140			1.694 €		1	6	67.0	0.4
XL 160/210/260/310x 90	T1813160			1.825 €		1	6	72.0	0.45

More MDF

Top and extensions 19 mm thk.

				LM1					
140/200 x90	T1811140			1.475 €		1	4	51.0	0.27
L 140/185/230 x90	T1812140	MI	MI	1.812 €	FM-M2	1	5	54.0	0.28
XL 140/190/240/290x 90	T1813140			1.994 €		1	6	67.0	0.4
XL 160/210/260/310x 90	T1813160			2.121 €		1	6	72.0	0.45

More Fenix

Top and extensions 19 mm thk.

				HFI					
100/140 x70	T1815100			1.473 €		1	4	42.0	0.19
120/170 x80	T1815120			1.687 €		1	4	48.0	0.23
140/200 x90	T1815140			1.974 €		1	4	52.0	0.27
L 140/185/230 x90	T1816140	MI	MI	2.183 €	FM-M2	1	5	56.0	0.28
XL 110/155/200/245x 80	T1817110			2.355 €		1	5	56.0	0.32
XL 140/190/240/290x 90	T1817140			2.890 €		1	6	68.0	0.4
XL 160/210/260/310x 90	T1817160			2.966 €		1	6	73.0	0.45

More Laminato

Top and extensions 19 mm thk.

				HLO					
100/140 x70	T1815100			1.235 €		1	4	42.0	0.19
120/170 x80	T1815120			1.389 €		1	4	48.0	0.23
140/200 x90	T1815140			1.428 €		1	4	52.0	0.27
L 140/185/230 x90	T1816140	MI	MI	1.643 €	FM-M2	1	5	56.0	0.28
XL 110/155/200/245x 80	T1817110			1.786 €		1	5	56.0	0.32
XL 140/190/240/290x 90	T1817140			2.227 €		1	6	68.0	0.4
XL 160/210/260/310x 90	T1817160			2.315 €		1	6	73.0	0.45

More Veneer

Top and extensions 19 mm thk.

				LI2							
L 140/185/230 x90	T1816140	M1	M1	1.791 €			FM-M2	1	5	56.0	0.28
XL 160/210/260/310x 90	T1817160			2.337 €				1	6	60.0	0.33

More Glass

Glass top 10 mm thk. MDF extensions 19 mm thk.

				GVB	GVC	GVD					
100/140 x70	T1811100	M1	M1	1.038 €	1.195 €	1.253 €	FM-M2	1	4	49.0	0.19
120/170 x80	T181120			1.196 €	1.331 €	1.421 €		1	4	58.0	0.23
140/200 x90	T181140			1.274 €	1.405 €	1.482 €		1	4	66.0	0.27
L 140/185/230 x90	T1812140			1.637 €	1.751 €	1.959 €		1	5	70.0	0.28
XL 110/155/200/245x 80	T1813110			1.650 €	1.766 €	1.971 €		1	5	67.0	0.32
XL 140/190/240/290x 90	T1813140			2.169 €	2.313 €	2.565 €		1	6	82.0	0.4
XL 160/210/260/310x 90	T1813160			2.283 €	2.525 €	2.762 €		1	6	87.0	0.45

More Ceramic

Ceramic top 11 mm thk and MDF extensions 19 mm thk | ATTENTION! GMA: Top Th. 14 mm. and Extensions Thk 22 mm.

				GKA	GKB	GMA					
100/140 x70	T1811100	M1	M1	1.472 €	1.542 €	1.679 €	FM-M2	1	4	49.0	0.19
120/170 x80	T181120			1.609 €	1.703 €	1.854 €		1	4	58.0	0.23
140/200 x90	T181140			1.772 €	1.882 €	2.043 €		1	4	66.0	0.27
L 140/185/230 x90	T1812140			2.126 €	2.242 €	2.487 €		1	5	70.0	0.28
XL 110/155/200/245x 80	T1813110			2.076 €	2.204 €	2.461 €		1	5	67.0	0.32
XL 140/190/240/290x 90	T1813140			2.603 €	2.861 €	3.157 €		1	6	82.0	0.4
XL 160/210/260/310x 90	T1813160			2.778 €	2.900 €	3.285 €		1	6	87.0	0.45

Note:

For Glass or Crystal Ceramic tops, extensions ONLY in matching lacquered MDF

Frame finishes

Metal

MI WHITE BB, BROWN E6, SAND EC, GRAPHITE EG, BLACK EN

Legs finishes

Metal

MI WHITE BB, BROWN E6, SAND EC, GRAPHITE EG, BLACK EN

Top and extensions finishes

Melamine

HLI	WHITE M01, GRAFITE M02, BLACK M04, SAND M07
------------	---

Fenix

HFI	BLACK FX4, WHITE FX5
------------	----------------------

Veneer

LI2	NATURAL OAK I22, FLAMED WALNUT I24
------------	------------------------------------

Lacquered MDF

LMI	GRAPHITE GREY G02, BLACK G04, WHITE G05, SAND G07, BROWN G41
------------	--

Laminate

HLO	BLUE LBB, GRAFITE GREY LGD, ASH GREY LGS, CHERRY RED LRC, RED BULGARO LRS, SAND LS2
------------	---

Top finishes with matching lacquered MDF extensions

Satin Glass

GVC	MATT GRAFITE ANTISCRATCH J31, MATT SAND ANTISCRATCH J32
GVD	EXTRA CLEAR MATT WHITE ANTISCRATCH J41

Crystal Ceramic and Ceramic

GKA	PIOMBO K01, CHARCOAL SAVOIA K11, CEMENT SAVOIA K12, EMPERADOR MARBLE BRUSH.MATT BROWN K31
GKB	RUST OXIDE K23, WHITE CALCE K24

Glossy Glass

GVB	EXTRA CLEAR GLOSSY WHITE J21, EXTRA CLEAR GLOSSY CHERRY RED J25
------------	---

Crystal Ceramic and glossy Ceramic

GMA	MARBLE CALACATTA GLOSSY WHITE K32, BLACK GREEK MARBLE K33, MARBLE GLOSSY NOIR DESIR K35, MARBLE CALACATTA MATT WHITE K42, MARBLE MATT NOIR DESIR K45, MARBLE MATT GREEN TINOS K46
------------	---

Lacquered MDF extensions finishes, JUST for Glass and Crystal Ceramic tops

Lacquered MDF

LMI	GRAPHITE GREY G02, BLACK G04, WHITE G05, SAND G07, BROWN G41
------------	--

Optionals:

	Value	Options/notes
FM-M2	Indoor matt metal M2	+ 166 € ASH GREY ES, BRONZE E2, BULGARO RED FP, CHERRY RED EQ, DARK GREEN EL, FACEPOWDER PINK E8, FANGO E3, GOLDEN YELLOW EO, LIGHT BLUE E0, LIGHT GREY ET, OCEAN BLUE EI, OCHER YELLOW E7, PAPAYA ORANGE EA, PASTEL YELLOW E4, PINE GREEN EJ, RED ER, SAGE GREEN E9

100/140 x70

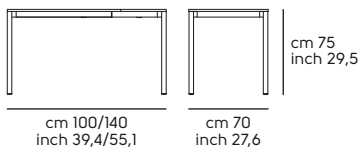

120/170 x80

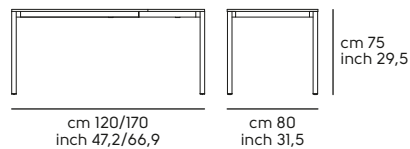

140/200 x90

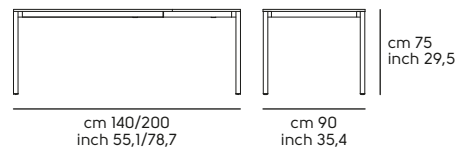

L 140/185/230 x90

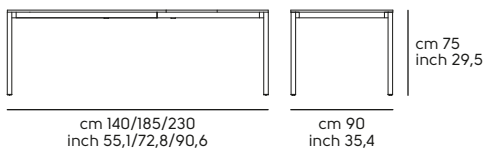

XL 110/155/200/245x 80

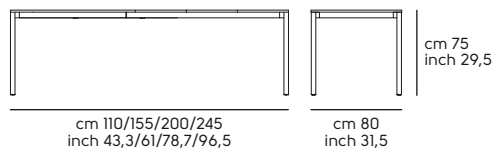

XL 140/190/240/290x 90

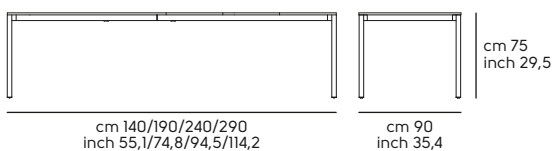

XL 160/210/260/310x 90

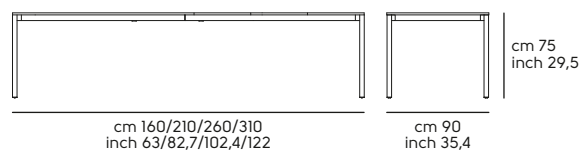

Nenè design Paolo Vernier

Table Nenè

Frame in: metal



Version	Code	Legs	Frame	Top	Optional	Q.ty	boxes	Kg	M ²
---------	------	------	-------	-----	----------	------	-------	----	----------------

Nenè Melamine HL

Top 18 mm. thk.

				HL1					
D. 70	T1370D07			458 €	FM-M2	1	3	16.5	0.25
D. 80	T1370D08			485 €		1	3	19.5	0.25
Triangular	T1370T01	M1	M1	565 €		1	3	19.5	0.28
75 x75	T1370075			559 €		1	3	22.5	0.29
85 x85	T1370085			575 €		1	3	22.5	0.29
140x90	T1370140			747 €		1	3	32.0	0.29

Nenè HPL

Top 10 mm. thk.

				HH1	HH2	HH3					
D. 70	T1370D07			622 €	659 €	683 €	FM-M2	1	3	16.5	0.25
D. 80	T1370D08			637 €	675 €	697 €		1	3	19.5	0.25
Triangular	T1370T01	M1	M1	645 €	681 €	710 €		1	3	19.5	0.28
75 x75	T1370075			697 €	727 €	764 €		1	3	22.5	0.29
85 x85	T1370085			763 €	802 €	891 €		1	3	22.5	0.29

Version	Code	Legs	Frame	Top	Optional	Q.ty	boxes	Kg	M ²
---------	------	------	-------	-----	----------	------	-------	----	----------------

Nenè Fenix

Top 19 mm. thk.

				HF1					
D. 70	T1370D07			786 €	FM-M2	1	3	16.5	0.25
D. 80	T1370D08			857 €		1	3	19.5	0.25
Triangular	T1370T01	M1	M1	865 €		1	3	19.5	0.28
75 x75	T1370075			1.048 €		1	3	22.5	0.29
85 x85	T1370085			1.092 €		1	3	22.5	0.29
140x90	T1370140			1.335 €		1	3	32.0	0.29

Version	Code	Legs	Frame	Top	Optional	Q.ty	boxes	Kg	M ²
---------	------	------	-------	-----	----------	------	-------	----	----------------

Nenè Laminato

Top 19 mm. thk.

				HLO					
D. 70	T1370D07			755 €	FM-M2	1	3	16.5	0.25
D. 80	T1370D08			821 €		1	3	19.5	0.25
Triangular	T1370T01	M1	M1	834 €		1	3	19.5	0.28
75 x75	T1370075			1.019 €		1	3	22.5	0.29
85 x85	T1370085			1.058 €		1	3	22.5	0.29
140x90	T1370140			1.284 €		1	3	32.0	0.29

Note:
75x75 / 85x85 stackable table x 4

Frame finishes

Metal

MI WHITE **BB**, BROWN **E6**, SAND **EC**, GRAPHITE **EG**, BLACK **EN**

Legs finishes

Metal

MI WHITE **BB**, BROWN **E6**, SAND **EC**, GRAPHITE **EG**, BLACK **EN**

Top finishes

Melamine

HLI WHITE **M01**, GRAFITE **M02**, BLACK**M04**, SAND **M07**

HPL

HH1 WHITE/Black Core **HB4**, BLACK/Black Core **HN4**

HH2 CEMENT/Black Core **HC6**, CORTEN/Brown Core **HC7**, DARK GREY/Black Core **HGW**

HH3 WHITE/White Core **WB4**

Fenix

HFI BLACK **FX4**, WHITE **FX5**

Laminate

HLO BLUE **LBB**, GRAFITE GREY **LGD**, ASH GREY **LGS**, CHERRY RED **LRC**, RED BULGARO **LRS**, SAND **LS2**

Optionals:

		Value	Options/notes
FM-M2	Indoor matt metal M2	+ 166 €	ASH GREY ES , BRONZE E2 , BULGARO RED FP , CHERRY RED EQ , DARK GREEN EL , FACEPOWDER PINK E8 , FANGO E3 , GOLDEN YELLOW EO , LIGHT BLUE EO , LIGHT GREY ET , OCEAN BLUE E1 , OCHER YELLOW E7 , PAPAYA ORANGE EA , PASTEL YELLOW E4 , PINE GREEN EJ , RED ER , SAGE GREEN E9

D. 70

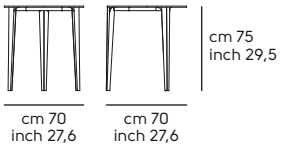

D. 80

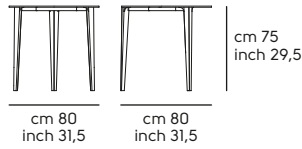

Triangular

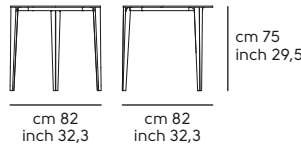

75 x75

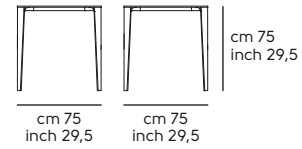

85 x85

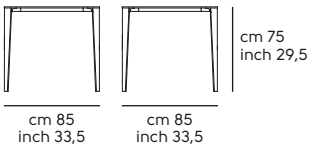

140x90

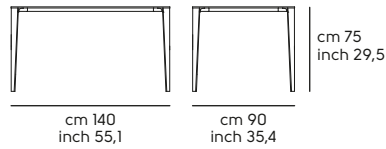

Nexus design Andrea Lucatello

Table Nexus

Frame in: baydur



T
A
B
L
E
S

Version	Code	--	Frame	Top	Optional	Q.ty	boxes	Kg	M ³
---------	------	----	-------	-----	----------	------	-------	----	----------------

Nexus Glass

Top 15 mm. thk.

				GVB					
220x116 Botte	T1834220			3.264 €					
250x120 Botte	T1834250		PB1	3.783 €	FP-B2	1	2	120.0	1.18
280x120 Ellittico	T1836280			4.082 €		1	2	130.0	1.2
						1	2	135.0	1.3

Nexus Ceramic

Top 16 mm. thk.

				GMA					
220x116 Botte	T1834220			4.910 €					
250x120 Botte	T1834250		PB1	5.153 €	FP-B2	1	2	145.0	1.18
280x120 Ellittico	T1836280			5.448 €		1	2	160.0	1.2
						1	2	165.0	1.3

Nexus Wood

Top 40 mm. thk.

				LS1	LS2					
LG 250x106	T1830250		PB1	4.771 €	5.149 €	FP-B2	1	2	115.0	1.1

Frame finishes

Baydur

PBI	WHITE BB4 , ASH GREY BGS , DARK GREY BGW
------------	---

Top finishes

Solid wood

LS1	IM OAK STRAIGHT EDGE WR1
LS2	SOLID WALNUT BARK EDGE WNI

Glossy Glass

GVB	EXTRA CLEAR TRANSPARENT J01
------------	------------------------------------

Crystal Ceramic and glossy Ceramic

GKA	CHARCOAL SAVOIA K11 , CEMENT SAVOIA K12
GMA	MARBLE CALACATTA GLOSSY WHITE K32 , BLACK GREEK MARBLE K33 , MARBLE GLOSSY NOIR DESIR K35 , MARBLE CALACATTA MATT WHITE K42 , MARBLE MATT NOIR DESIR K45 , MARBLE MATT GREEN TINOS K46

Optionals:

		Value	Options/notes
FP-B2	Baydur PB2	+ 904 €	BRUSHED CONCRETE DARK GREY CGW , BRUSHED CONCRETE LIGHT GREY CGT

220x116 Botte

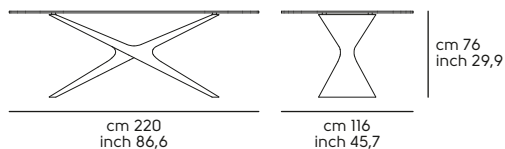

250x120 Botte

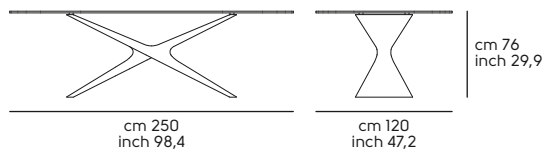

280x120 Ellittico

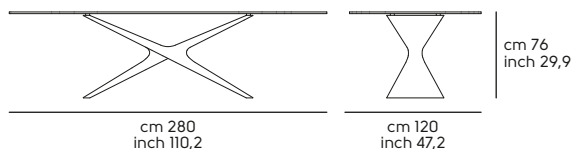

LG 250x106

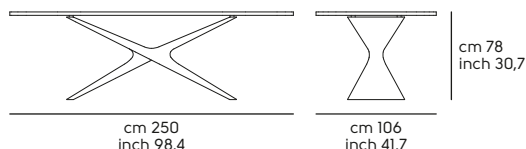

Paul design Midj R&D

Table Paul

Frame in: metal



Version	Code	Legs	Frame	Top and extensions	Optional	Q.ty	boxes	Kg	M ³
---------	------	------	-------	--------------------	----------	------	-------	----	----------------

Paul Veneer

Top and extensions 20 mm thk.

				L11	L12					
D. 120/180	TI970D12	M1	M1	2.337 €	2.453 €	FM-M2	1	2	105.0	0.87
120/180x120 - Botte	TI970I20			2.290 €	2.371 €		1	2	110.0	0.9

Paul Ceramic

Top 13 mm. thk - Extensions 19 mm thk. | GMA: Top 16 mm. thk. - Extensions 22 mm. thk.

				GKA	GKB					
D. 120/180	TI970D12	M1	M1	3.532 €	3.657 €	FM-M2	1	2	130.0	0.87
120/180x120 - Botte	TI970I20			3.526 €	3.656 €		1	2	135.0	0.9

Note:

For wooden or Glass ceramic tops, extensions in the same material

Frame finishes

Metal

M1 WHITE **BB**, BROWN **E6**, SAND **EC**, GRAPHITE **EG**, BLACK **EN**

Legs finishes

Metal

M1 WHITE **BB**, BROWN **E6**, SAND **EC**, GRAPHITE **EG**, BLACK **EN**

Top and extensions finishes

Veneer

L11 BLACK **I04**, WHITE **I05**, NATURAL **I40**

L12 NATURAL OAK **I22**, FLAMED WALNUT **I24**

Crystal Ceramic and Ceramic

GKA PIOMBO **K01**, CHARCOAL SAVOIA **K11**, CEMENT SAVOIA **K12**, EMPERADOR MARBLE BRUSH.MATT BROWN **K31**

GKB RUST OXIDE **K23**, WHITE CALCE **K24**

Optionals:

		Value	Options/notes
FM-M2	Indoor matt metal M2	+ 166 €	ASH GREY ES , BRONZE E2 , BULGARO RED FP , CHERRY RED EQ , DARK GREEN EL , FACEPOWDER PINK E8 , FANGO E3 , GOLDEN YELLOW EO , LIGHT BLUE E0 , LIGHT GREY ET , OCEAN BLUE E1 , OCHER YELLOW E7 , PAPAYA ORANGE EA , PASTEL YELLOW E4 , PINE GREEN EJ , RED ER , SAGE GREEN E9

D. 120/180

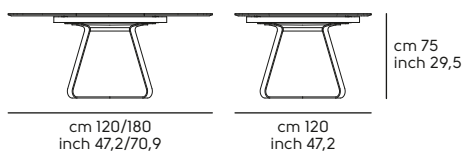

120/180x120 - Botte

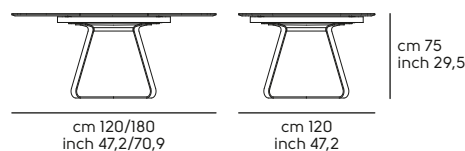

Pechino design Studio Kappa

Table Pechino

Frame in: metal



Version	Code	Legs	Frame	Top	Optional	Q.ty	boxes	Kg	M ³
---------	------	------	-------	-----	----------	------	-------	----	----------------

Pechino Veneer

Top 19 mm. thk.

				LI1					
200x106	T0260200	M1	M1	1.943 €	FM-M2	1	3	153.0	1.14
250x106	T0260250			2.239 €					

Pechino Wood

Top 40 mm. thk.

				LS1	LS2					
200x106	T0260200	M1	M1	3.525 €	3.645 €	FM-M2	1	3	168.0	1.14
250x106	T0260250			3.819 €	3.941 €					

Pechino Glass

Top 12 mm. thk.

				GVB	GVC	GVD					
200x106	T0260200	M1	M1	2.345 €	2.748 €	3.110 €	FM-M2	1	2	153.0	1.03
250x106	T0260250			2.856 €	3.149 €	3.551 €					

Version	Code	Legs	Frame	Top and extensions	Optional	Q.ty	boxes	Kg	M ³
---------	------	------	-------	--------------------	----------	------	-------	----	----------------

Pechino Glass

Top and extensions 12 mm thk.

				GVC	GVD					
160/200/240x106	T0265160	M1	M1	3.510 €	4.088 €	FM-M2	1	4	212.0	1.04
190/240/290x106	T0265190			3.930 €	4.409 €					

Note:

For Glass or Crystal Ceramic tops, extensions in the same material

Frame finishes

Metal

MI	WHITE BB, BROWN E6, SAND EC, GRAPHITE EG, BLACK EN
-----------	--

Legs finishes

Metal

MI	WHITE BB, BROWN E6, SAND EC, GRAPHITE EG, BLACK EN
-----------	--

Top finishes

Veneer

LII	BLACK I04
------------	-----------

Solid wood

LS1	IM OAK STRAIGHT EDGE WRI
LS2	SOLID WALNUT BARK EDGE WNI

Glossy Glass

GVB	EXTRA CLEAR TRANSPARENT J01
------------	-----------------------------

Top and extensions finishes

Satin Glass

GVC	MATT GRAFITE ANTISCRATCH J31, MATT SAND ANTISCRATCH J32
GVD	EXTRA CLEAR MATT WHITE ANTISCRATCH J41

Plissé

Optionals:

		Value	Options/notes
FM-M2	Indoor matt metal M2	+ 166 €	ASH GREY ES, BRONZE E2, BULGARO RED FP, CHERRY RED EQ, DARK GREEN EL, FACEPOWDER PINK E8, FANGO E3, GOLDEN YELLOW EO, LIGHT BLUE EO, LIGHT GREY ET, OCEAN BLUE EI, OCHER YELLOW E7, PAPAYA ORANGE EA, PASTEL YELLOW E4, PINE GREEN EJ, RED ER, SAGE GREEN E9

200x106

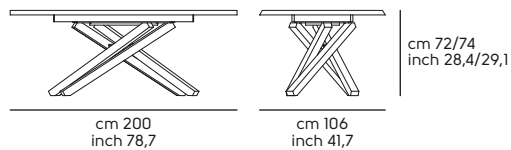

250x106

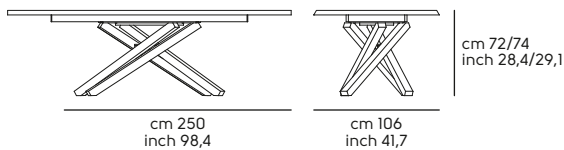

160/200/240x106

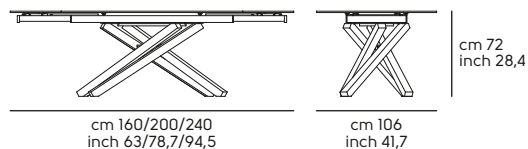

190/240/290x106

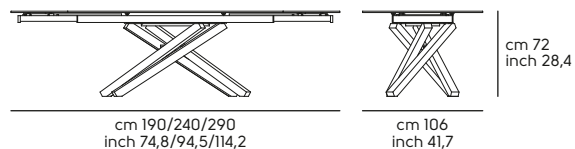

Plissé design Paola Navone

Table Plissé

Frame in: metal



Version	Code	Frame	--	Top	Optional	Q.ty	boxes	Kg	M ³
---------	------	-------	----	-----	----------	------	-------	----	----------------

Plissé Veneer

Top Ø150 20 mm. thk. - Ø180 25 mm. thk.

				LI1	LI2					
D. 150	T2220150	MI		2.327 €	2.470 €	FM-M2	1	3	84.0	0.8
D. 180	T2220180			3.175 €	3.628 €		1	3	114.0	0.82

Plissé Ceramic

Top 16 mm. thk.

				GMA					
D. 150	T2220150	MI		3.506 €	FM-M2	1	3	132.0	0.8

Plissé Marble

Top 20 mm. thk.

				GMM					
D. 150	T2220150	MI		5.199 €	FM-M2	1	3	159.0	0.8
D. 180	T2220180			6.406 €		1	3	203.0	0.82

Note:

Top Marble D.180 Only BLACK MARQUINIA [MN4] and WHITE CALACATTA VAGLI [MB4] -Top Ceramic D.150/180 not available GMA K46

Optionals:

		Value	Options/notes
FM-M2	Indoor matt metal M2	+ 198 €	ASH GREY ES , BRONZE E2 , BULGARO RED FP , CHERRY RED EQ , DARK GREEN EL , FACEPOWDER PINK E8 , FANGO E3 , GOLDEN YELLOW EO , LIGHT BLUE EO , LIGHT GREY ET , OCEAN BLUE E1 , OCHER YELLOW E7 , PAPAYA ORANGE EA , PASTEL YELLOW E4 , PINE GREEN EJ , RED ER , SAGE GREEN E9

Lazy Susan

Top: Ceramic, Marble



Version	Code	Top Thickness	--	Top	Optional	Q.ty	boxes	Kg	M ²
Lazy Susan Ceramic									
Top Ø60 6 mm. thk.									
				GMA					
LS D. 60 H. 2.6	A2220060	0.6		375 €		1	1	7.0	0.01

Lazy Susan Marble

Top Ø60 20 mm. thk.

				GMM					
LS D. 60 H. 4.0	A2220060	2		662 €		1	1	16.0	0.02

Note:

--

Frame finishes

Metal

MI WHITE **BB**, BROWN **E6**, SAND **EC**, GRAPHITE **EG**, BLACK **EN**

Top finishes

Veneer

L11 BLACK **I04**, WHITE **I05**, NATURAL **I40**

L12 NATURAL OAK **I22**, FLAMED WALNUT **I24**

Marble

GMM BEIGE TRAVERTINO ROMANO **MB2**, WHITE CALACATTA VAGLI **MB4**, BLACK MARQUINIA **MN4**, GREEN TINOS **MVE**

Crystal Ceramic and Ceramic

GMA MARBLE CALACATTA GLOSSY WHITE **K32**, BLACK GREEK MARBLE **K33**, MARBLE GLOSSY NOIR DESIR **K35**, MARBLE CALACATTA MATT WHITE **K42**, MARBLE MATT NOIR DESIR **K45**, MARBLE MATT GREEN TINOS **K46**

D. 150

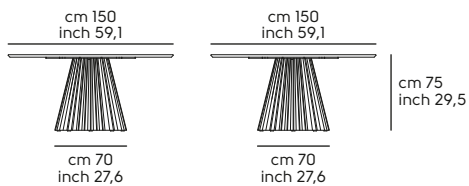

D. 180

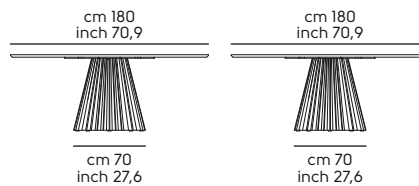

LS D. 60

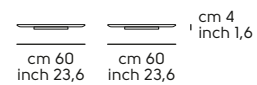

Spike design Giulio Iacchetti

Table Spike

Frame in: metal



Version	Code	Frame	--	Top	Optional	Q.ty	boxes	Kg	M³
---------	------	-------	----	-----	----------	------	-------	----	----

Spike Glass

Top 12 mm. thk.

				GVA	GVE					
D. 140	T2240D14	MI		4.035 €	4.179 €	FM-M2	1	2	160.5	0.65
200x100	T2240200			4.179 €	4.289 €	FM-M4	1	2	178.0	0.66

Frame finishes

Metal

MI WHITE **BB**, BROWN **E6**, SAND **EC**, GRAPHITE **EG**, BLACK **EN**

Top finishes

Glossy Glass

GVA TRANSPARENT **J02**

GVE GLOSSY FUME' **J05**

Optionals:

		Value	Options/notes
FM-M2	Indoor matt metal M2	+ 198 €	ASH GREY ES , BRONZE E2 , BULGARO RED FP , CHERRY RED EQ , DARK GREEN EL , FACEPOWDER PINK E8 , FANGO E3 , GOLDEN YELLOW EO , LIGHT BLUE E0 , LIGHT GREY ET , OCEAN BLUE E1 , OCHER YELLOW E7 , PAPAYA ORANGE EA , PASTEL YELLOW E4 , PINE GREEN EJ , RED ER , SAGE GREEN E9
FM-M4	Indoor glossy Metal M4	+ 276 €	MATT BLACK NICKEL DY , MATT GOLDEN BRONZE DC

D. 140

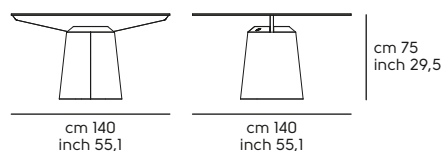

200x100

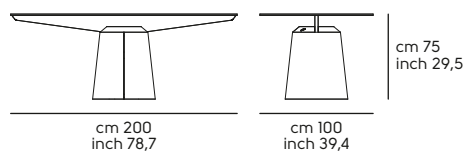

Suite design Ateliernanni

Table Suite

Frame in: wood with metal insert



Version	Code	Insert	Frame	Top	Optional	Q.ty	boxes	Kg	M ³
---------	------	--------	-------	-----	----------	------	-------	----	----------------

Suite Glass

Top 15 mm. thk.

				GVB	GVE	GVH					
220x116 Botte	T1754220	MI	LFI	2.630 €	2.693 €	3.369 €	FM-M2	1	3	98.0	0.74
250x120 Botte	T1754250			3.149 €	3.417 €	--	FM-M4	1	3	98.0	0.82

Frame finishes

Solid ash

LFI	Ash wood painted GREY F02 , Ash wood painted GRAFITE GREY F03 , Ash wood painted BLACK F04 , Ash wood painted WHITE F05 , Ash wood painted BLUE F06 , Ash wood painted RED F08 , Ash wood painted CHERRY RED F09 , Ash wood painted FLAMED WALNUT F24 , Ash wood painted DARK BROWN F26 , Ash wood painted NATURAL F40 , Ash wood painted NATURAL OAK F52
------------	--

Insert finishes

Metal

MI	WHITE BB , BROWN E6 , SAND EC , GRAPHITE EG , BLACK EN
-----------	---

Top finishes

Glossy Glass

GVB	EXTRA CLEAR TRANSPARENT J01
GVE	GLOSSY FUME' J05

Glass with Bucciato finish

GVH	BUCCIATO FUME' J50
------------	---------------------------

Optionals:

		Value	Options/notes
FM-M2	Indoor matt metal M2	+ 100 €	ASH GREY ES , BRONZE E2 , BULGARO RED FP , CHERRY RED EQ , DARK GREEN EL , FACEPOWDER PINK EB , FANGO E3 , GOLDEN YELLOW EO , LIGHT BLUE ED , LIGHT GREY ET , OCEAN BLUE EI , OCHER YELLOW E7 , PAPAYA ORANGE EA , PASTEL YELLOW E4 , PINE GREEN EJ , RED ER , SAGE GREEN E9
FM-M4	Indoor glossy Metal M4	+ 206 €	BLACK NICKEL DZ , CHAMPAGNE GOLD DG , GOLDEN BRONZE DB , MATT BLACK NICKEL DY , MATT GOLDEN BRONZE DC , PINK GOLD DR

220x116 Botte

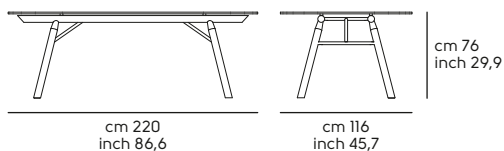

250x120 Botte

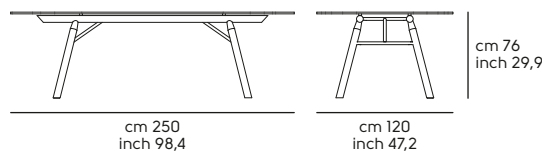

Woody design Midj R&D

Table Woody

Frame in: metal. Legs: covered with solid ash



Version	Code	Legs	Frame	Top / Top and extensions	Optional	Q.ty	boxes	Kg	M ³
---------	------	------	-------	--------------------------	----------	------	-------	----	----------------

Woody Laminato

Top and extensions 19 mm thk.

				HLO					
120x 80	T2150120	LFI	MI	1.478 €	FM-M2	1	3	50.0	0.23
140x 90	T2150140			1		3	53.0	0.27	
160x 90	T2150160			1		3	66.0	0.51	
180x100	T2150180			1		3	69.0	0.52	
120/170x 80	T2151120			1		4	52.0	0.23	
140/190/240x 90	T2151140			1		5	70.0	0.52	
160/210/260/310x 90	T2151160			1		6	72.0	0.52	
180/230/280x100	T2151180			1		5	75.0	0.55	

Woody Fenix

Top and extensions 19 mm thk.

				HF1					
120x 80	T2150120	LFI	MI	1.643 €	FM-M2	1	3	50.0	0.23
140x 90	T2150140			1		3	53.0	0.27	
160x 90	T2150160			1		3	66.0	0.51	
180x100	T2150180			1		3	69.0	0.52	
120/170x 80	T2151120			1		4	52.0	0.23	
140/190/240x 90	T2151140			1		5	70.0	0.52	
160/210/260/310x 90	T2151160			1		6	72.0	0.52	
180/230/280x100	T2151180			1		5	75.0	0.55	

Woody Veneer

Top and extensions 19 mm thk.

				L11					
120x 80	T2150120	LFI	MI	1.478 €	FM-M2	1	3	50.0	0.23
140x 90	T2150140			1		3	53.0	0.27	
140x140	T2150141			1		3	60.0	0.3	
160x 90	T2150160			1		3	66.0	0.51	
180x100	T2150180			1		3	69.0	0.52	
120/170x 80	T2151120			1		4	52.0	0.23	
140/190/240x 90	T2151140			1		5	70.0	0.52	
140/200x140	T2151141			1		3	70.0	0.52	
160/210/260/310x 90	T2151160			1		6	72.0	0.52	
180/230/280x100	T2151180			1		5	75.0	0.55	

Woody Glass

Top in Glass thickness 10 mm. Extensions in LAMINATE thickness 19 mm.

				GVB	GVC	GVD					
120x 80	T2150120			1.389 €	1.528 €	1.604 €		1	3	60.0	0.23
140x 90	T2150140			1.455 €	1.601 €	1.681 €		1	3	63.0	0.27
140x140	T2150141			1.852 €	2.037 €	2.139 €		1	3	70.0	0.3
160x 90	T2150160			1.599 €	1.759 €	1.847 €		1	3	76.0	0.51
180x100	T2150180			1.643 €	1.807 €	1.897 €		1	3	79.0	0.52
120/170x 80	T2151120	LFI	MI	1.547 €	1.701 €	1.786 €	FM-M2	1	4	62.0	0.23
140/190/240x 90	T2151140			2.020 €	2.222 €	2.333 €		1	5	80.0	0.52
140/200x140	T2151141			2.337 €	2.571 €	2.700 €		1	3	80.0	0.52
160/210/260/310x 90	T2151160			2.784 €	3.063 €	3.215 €		1	6	82.0	0.52
180/230/280x100	T2151180			2.746 €	3.020 €	3.171 €		1	5	85.0	0.55

Woody Ceramic

Top in Glass thickness 10 mm. Extensions in LAMINATE thickness 19 mm.

				GKA	GKB					
120x 80	T2150120			1.803 €	1.911 €		1	3	60.0	0.23
140x 90	T2150140			2.150 €	2.279 €		1	3	63.0	0.27
140x140	T2150141			2.894 €			1	3	70.0	0.3
160x 90	T2150160			2.660 €	2.819 €		1	3	76.0	0.51
180x100	T2150180			2.790 €	2.957 €		1	3	79.0	0.52
120/170x 80	T2151120	LFI	MI	1.979 €	2.098 €	FM-M2	1	4	62.0	0.23
140/190/240x 90	T2151140			2.613 €	2.770 €		1	5	80.0	0.52
140/200x140	T2151141			3.148 €			1	3	80.0	0.52
160/210/260/310x 90	T2151160			3.299 €	3.498 €		1	6	82.0	0.52
180/230/280x100	T2151180			3.253 €	3.447 €		1	5	85.0	0.55

Note:

For Glass or Crystal Ceramic tops, extensions ONLY in LAMINATO/FENIX

Table Woody H.105

Frame in: metal. Legs: covered with solid ash

Version	Code	Legs	Frame	Top	Optional	Q.ty	boxes	Kg	M ³
---------	------	------	-------	-----	----------	------	-------	----	----------------

Woody Laminato

Top 19 mm. thk.

				HLO					
140x 90 H.105	T2157140	LFI	MI	1.852 €	FM-M2	1	3	59.0	0.3
160x 90 H.105	T2157160			1.971 €		1	3	72.0	0.55

Woody Fenix

Top 19 mm. thk.

				HFI					
140x 90 H.105	T2157140	LFI	MI	2.034 €	FM-M2	1	3	59.0	0.3
160x 90 H.105	T2157160			2.166 €		1	3	72.0	0.55

Woody Veneer

Top 19 mm. thk.

				LII					
140x 90 H.105	T2157140	LFI	MI	1.852 €	FM-M2	1	3	59.0	0.3
160x 90 H.105	T2157160			2.166 €		1	3	72.0	0.55

Woody Glass

Glass top 10 mm thk.

				GVB	GVC	GVD					
140x 90 H.105	T2157140	LFI	MI	1.671 €	1.815 €	1.896 €	FM-M2	1	3	69.0	0.3
160x 90 H.105	T2157160			1.813 €	1.974 €	2.062 €		1	3	82.0	0.55

Woody Ceramic

Ceramic top 11 mm thk

				GKA	GKB					
140x 90 H.105	T2157140	LFI	MI	2.365 €	2.494 €	FM-M2	1	3	69.0	0.3
160x 90 H.105	T2157160			2.874 €	3.035 €		1	3	82.0	0.55

Note:

Frame finishes

Metal

MI	WHITE BB , BROWN E6 , SAND EC , GRAPHITE EG , BLACK EN
-----------	---

Legs finishes

Solid ash

LFI	Ash wood painted GREY F02 , Ash wood painted GRAFITE GREY F03 , Ash wood painted BLACK F04 , Ash wood painted WHITE F05 , Ash wood painted BLUE F06 , Ash wood painted RED F08 , Ash wood painted CHERRY RED F09 , Ash wood painted FLAMED WALNUT F24 , Ash wood painted DARK BROWN F26 , Ash wood painted NATURAL F40 , Ash wood painted NATURAL OAK F52
------------	--

Top and extensions finishes

Laminate

HLO	BLUE LBB , GRAFITE GREY LGD , ASH GREY LGS , CHERRY RED LRC , RED BULGARO LRS , SAND LS2
------------	--

Fenix

HFI	BLACK FX4 , WHITE FX5
------------	-------------------------------------

Veneer

LII	BLACK I04 , WHITE I05 , NATURAL I40
------------	--

Satin Glass

GVC	MATT GRAFITE ANTISCRATCH J31, MATT SAND ANTISCRATCH J32
GVD	EXTRA CLEAR MATT WHITE ANTISCRATCH J41

Glossy Glass

GVB	EXTRA CLEAR GLOSSY WHITE J21, EXTRA CLEAR GLOSSY CHERRY RED J25
------------	---

Crystal Ceramic and Ceramic

GKA	CHARCOAL SAVOIA K11, CEMENT SAVOIA K12
GKB	WHITE CALCE K24

Optionals:

	Value	Options/notes
FM-M2	Indoor matt metal M2 + 110 €	ASH GREY ES , BRONZE E2 , BULGARO RED FP , CHERRY RED EQ , DARK GREEN EL , FACEPOWDER PINK E8 , FANGO E3 , GOLDEN YELLOW EO , LIGHT BLUE EO , LIGHT GREY ET , OCEAN BLUE EI , OCHER YELLOW E7 , PAPAYA ORANGE EA , PASTEL YELLOW E4 , PINE GREEN EJ , RED ER , SAGE GREEN E9

120x 80

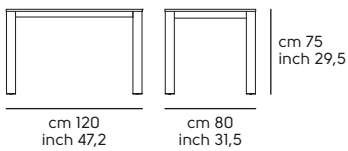

140x 90

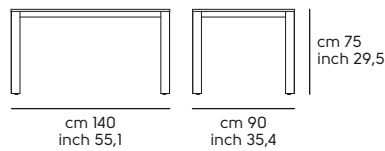

140x140

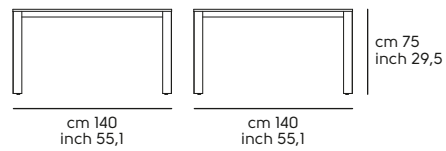

160x 90

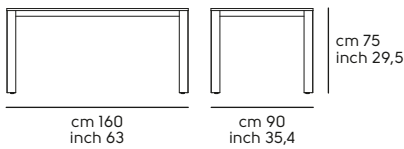

180x100

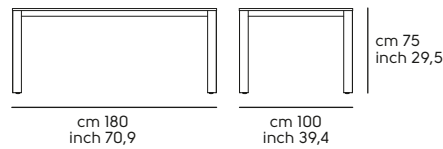

120/170x 80

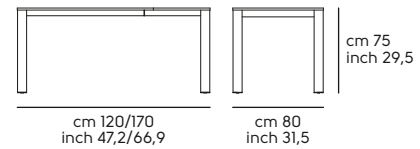

140/190/240x 90

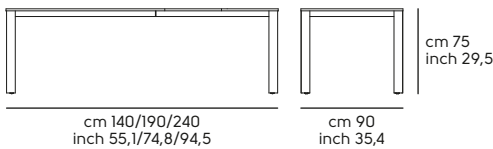

140/200x140

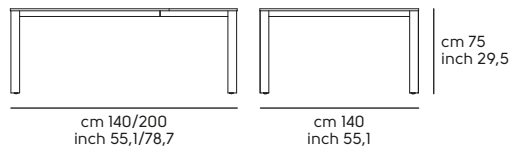

160/210/260/310x 90

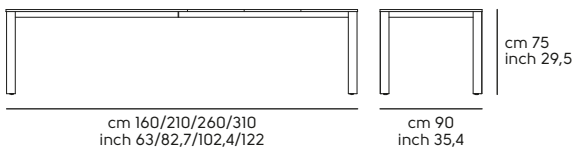

180/230/280x100

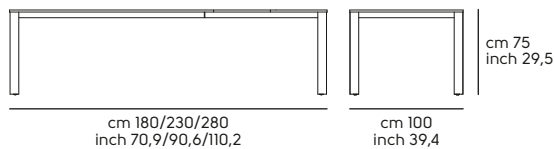

140x 90 H.105

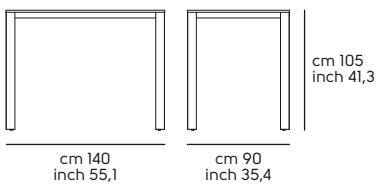

160x 90 H.105

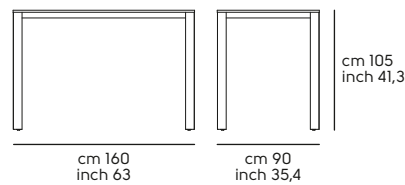

Zeus design Maurizio e Silvia Varsi

Table Zeus

Frame in: metal or lacquered solid ash



Version	Code	Legs	Frame	Top	Optional	Q.ty	boxes	Kg	M ³
---------	------	------	-------	-----	----------	------	-------	----	----------------

Zeus Veneer

Top 30 mm. thk.

				L12					
MT 200x106	T0302200			2.454 €		1	5	94.0	0.41
MT 250x106	T0302250	M1	M1	2.738 €		1	5	112.0	0.44
MT 200/250/300x106	T0303200			3.157 €		1	6	99.0	0.53

Zeus Wood

Top 40 mm. thk.

				LS1	LS2					
MT 200x106	T0302200	M1	M1	3.994 €	4.111 €		1	4	94.0	0.37
MT 250x106	T0302250			4.664 €	4.781 €		1	4	113.0	0.44

Zeus Glass

Top 12 mm. thk.

				GVB					
MT 200x106	T0302200	M1	M1	2.058 €		1	4	118.0	0.37
MT 250x106	T0302250			2.461 €		1	4	143.0	0.26

Zeus Ceramic

Top 36 mm. thk.

				GMA					
MT 200x100	T0300200	M1	M1	3.157 €		1	5	127.0	0.37
MT 250x100	T0300250			3.588 €		1	5	153.0	0.26

Zeus Marble

Top 20 mm. thk.

				GMM					
MT 200x100	T0300200	M1	M1	4.125 €		1	4	127.0	0.37

Zeus Veneer

Top 30 mm. thk.

				L12					
LG 200x106	T0307200	L12	L12	3.389 €		1	5	75.0	0.39
LG 250x106	T0307250			3.699 €		1	5	90.0	0.44

Zeus Wood

Top 40 mm. thk.

				LS1	LS2					
LG 200x106	T0307200	L12	L12	4.291 €	4.407 €		1	4	75.0	0.36
LG 250x106	T0307250	L12	L12	5.205 €	5.321 €		1	4	89.0	0.44

Zeus Glass

Top 12 mm. thk.

				GVB					
LG 200x106	T0307200	LI2	LI2	3.157 €		1	4	87.0	0.26
LG 250x106	T0307250			3.674 €		1	4	106.0	0.37

Zeus Ceramic

Top 36 mm. thk.

				GMA					
LG 200x100	T0305200	LI2	LI2	3.955 €		1	5	108.0	0.37
LG 250x100	T0305250			4.511 €		1	5	116.0	0.37

Zeus Marble

Top 20 mm. thk.

				GMM					
LG 200x100	T0305200	LI2	LI2	5.067 €		1	4	108.0	0.37

Frame finishes

Metal

MI	GRAPHITE EG
-----------	-------------

Veneer

LI2	FLAMED WALNUT I24
------------	-------------------

Legs finishes

Metal

MI	GRAPHITE EG
-----------	-------------

Veneer

LI2	FLAMED WALNUT I24
------------	-------------------

Top finishes

Veneer

LI2	NATURAL OAK I22, FLAMED WALNUT I24
------------	------------------------------------

Solid wood

LS1	IM OAK STRAIGHT EDGE WRI
LS2	SOLID WALNUT BARK EDGE WNI

Glossy Glass

GVB	EXTRA CLEAR TRANSPARENT J01
------------	-----------------------------

Crystal Ceramic and glossy Ceramic

GMA	MARBLE CALACATTA GLOSSY WHITE K32, BLACK GREEK MARBLE K33, MARBLE GLOSSY NOIR DESIR K35, MARBLE CALACATTA MATT WHITE K42, MARBLE MATT NOIR DESIR K45, MARBLE MATT GREEN TINOS K46
------------	---

Marble

GMM	BEIGE TRAVERTINO ROMANO MB2, WHITE CALACATTA VAGLI MB4, BLACK MARQUINIA MN4, GREEN TINOS MVE
------------	--

200x106

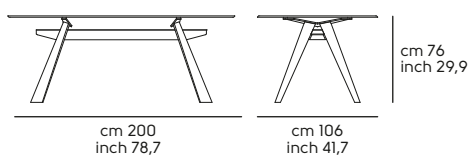

250x106

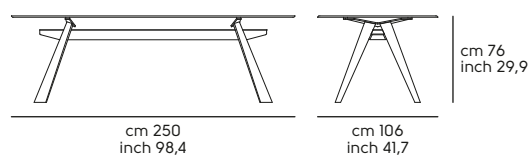

200/250/300x106

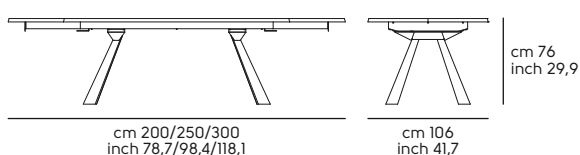

Coffee Table

Apelle design Beatriz Sempere

Coffee Table APELLE CHIC

Frame in: metal



Version	Code	Mod.	Frame	Top	Optional	Q.ty	boxes	Kg	M ³
---------	------	------	-------	-----	----------	------	-------	----	----------------

Apelle Chic Hide

Top 6 mm. thk.

				CU	CT					
APELLE CHIC H43_CU	T1000C43	H43	M1	201 €	227 €	FM-M2 FM-M4	1	1	6.0	0.08
APELLE CHIC H63_CU	T1000C63	H63	M1	225 €	249 €	FM-M2 FM-M4	1	1	7.0	0.12
APELLE CHIC H73_CU	T1000C73	H73	M1	254 €	286 €	FM-M2 FM-M4	1	1	7.5	0.15

Apelle Chic Ceramic

Top 8 mm. thk.

				GKA	GKB	GMA					
APELLE CHIC H43_KR	T1000H43	H43	M1	205 €	223 €	235 €	FM-M2 FM-M4	1	1	6.0	0.08
APELLE CHIC H63_KR	T1000H63	H63	M1	229 €	250 €	269 €	FM-M2 FM-M4	1	1	7.0	0.12
APELLE CHIC H73_KR	T1000H73	H73	M1	256 €	267 €	288 €	FM-M2 FM-M4	1	1	7.5	0.15

Frame finishes

Metal

MI	WHITE BB , INDUSTRIAL E5 , BROWN E6 , SAND EC , GRAPHITE EG , BLACK EN
-----------	--

Top finishes

Hide

CU	HIDE
CT	TUSCAN HIDE

Crystal Ceramic and Ceramic

GKA	PIOMBO K01 , CHARCOAL SAVOIA K11 , CEMENT SAVOIA K12 , EMPERADOR MARBLE BRUSH.MATT BROWN K31
GKB	RUST OXIDE K23 , WHITE CALCE K24

Crystal Ceramic and glossy Ceramic

GMA	MARBLE CALACATTA GLOSSY WHITE K32 , BLACK GREEK MARBLE K33 , MARBLE GLOSSY NOIR DESIR K35 , MARBLE CALACATTA MATT WHITE K42 , MARBLE MATT NOIR DESIR K45 , MARBLE MATT GREEN TINOS K46
------------	--

Optionals:

		Value	Options/notes
FM-M2	Indoor matt metal M2	+ 88 €	ASH GREY ES , BRONZE E2 , BULGARO RED FP , CHERRY RED EQ , DARK GREEN EL , FACEPOWDER PINK E8 , FANGO E3 , GOLDEN YELLOW EO , LIGHT BLUE EO , LIGHT GREY ET , OCEAN BLUE E1 , OCHER YELLOW E7 , PAPAYA ORANGE EA , PASTEL YELLOW E4 , PINE GREEN EJ , RED ER , SAGE GREEN E9
FM-M4	Indoor glossy Metal M4	+ 103 €	BLACK NICKEL DZ , CHAMPAGNE GOLD DG , GOLDEN BRONZE DB , MATT BLACK NICKEL DY , MATT GOLDEN BRONZE DC , PINK GOLD DR

Apelle Chic H43

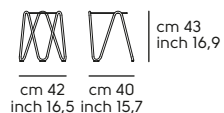

Apelle Chic H63

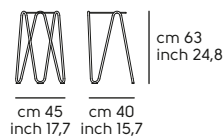

Apelle Chic H73

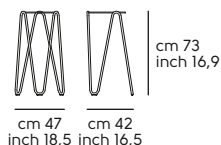

Coffee Table APELLE CT

Frame in: metal



Version	Code	Mod.	Frame	Top	Optional	Q.ty	boxes	Kg	M ³	
Apelle Hide Top 6 mm. thk.										
				CU	CT					
APELLE CT	T10000CT	CT	M1	213 €	254 €	FM-M2 FM-M4	1	1	7.0	0.09

Coffee Table APELLE TRIO

Frame in: metal



Version	Code	Mod.	Frame	Top	Optional	Q.ty	boxes	Kg	M ³	
Apelle Hide Top 6 mm. thk.										
				CU	CT					
APELLE TRIO_CU	T1000CTR	TR	M1	416 €	505 €	FM-M2 FM-M4	1	1	15.0	0.25

Apelle Ceramic

Top 8 mm. thk.

Version	Code	Mod.	Frame	GKA	GKB	GMA	Optional	Q.ty	boxes	Kg	M ³
APELLE TRIO_KR	T1000HTR	TR	M1	538 €	602 €	627 €	FM-M2 FM-M4	1	1	15.0	0.25

Frame finishes

Metal

MI	WHITE BB , BROWN E6 , SAND EC , GRAPHITE EG , BLACK EN
-----------	---

Top finishes

Hide

CU	HIDE
CT	TUSCAN HIDE

Crystal Ceramic and Ceramic

GKA	PIOMBO K01 , CHARCOAL SAVOIA K11 , CEMENT SAVOIA K12 , EMPERADOR MARBLE BRUSH.MATT BROWN K31
GKB	RUST OXIDE K23 , WHITE CALCE K24

Crystal Ceramic and glossy Ceramic

GMA	MARBLE CALACATTA GLOSSY WHITE K32 , BLACK GREEK MARBLE K33 , MARBLE GLOSSY NOIR DESIR K35 , MARBLE CALACATTA MATT WHITE K42 , MARBLE MATT NOIR DESIR K45 , MARBLE MATT GREEN TINOS K46
------------	--

Optionals:

		Value	Options/notes
FM-M2	Indoor matt metal M2	+ 88 €	ASH GREY ES , BRONZE E2 , BULGARO RED FP , CHERRY RED EQ , DARK GREEN EL , FACEPOWDER PINK E8 , FANGO E3 , GOLDEN YELLOW EO , LIGHT BLUE EO , LIGHT GREY ET , OCEAN BLUE E1 , OCHER YELLOW E7 , PAPAYA ORANGE EA , PASTEL YELLOW E4 , PINE GREEN EJ , RED ER , SAGE GREEN E9
FM-M4	Indoor glossy Metal M4	+ 103 €	BLACK NICKEL DZ , CHAMPAGNE GOLD DG , GOLDEN BRONZE DB , MATT BLACK NICKEL DY , MATT GOLDEN BRONZE DC , PINK GOLD DR

Apelle CT

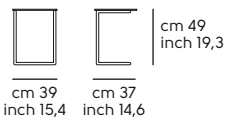

Apelle TR

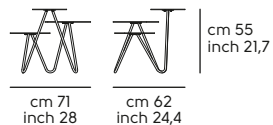

Bloom design Studio Pastina

Coffee Table BLOOM

Frame in: upholstered metal



Version	Code	Mod.	Frame and Top	Upholstery									Optional	Q.ty	boxes	Kg	M ³
Bloom Top Metal																	
Top 4 mm. thk.																	
				TA	TB	TC	TD	TE	SF	SV	COM	COL					
BLOOM H40 D. 70_MT	T2041D70	H40	M1	563 €	583 €	632 €	635 €	660 €	643 €	665 €	563 €	632 €	FM-M2 IM-M2	1	2	13.0	0.15
BLOOM H50 D. 60_MT	T2041D60	H50	M1	508 €	523 €	560 €	552 €	573 €	563 €	583 €	508 €	560 €	FM-M2 IM-M2	1	2	13.0	0.12

Bloom Top HPL -HHI

Top 10 mm. thk.

				TA	TB	TC	TD	TE	SF	SV	COM	COL					
BLOOM H40 D. 70	T2040D70_HHI	H40	M1 - HHI	571 €	592 €	642 €	645 €	673 €	656 €	676 €	571 €	642 €	FM-M2 FH-H2 FH-H3	1	2	13.0	0.15
BLOOM H50 D. 60	T2040D60_HHI	H50	M1 - HHI	500 €	521 €	569 €	568 €	590 €	571 €	603 €	500 €	569 €	FM-M2 FH-H2 FH-H3	1	2	13.0	0.12

Frame finishes

Metal	
MI	WHITE BB , BROWN E6 , SAND EC , GRAPHITE EG , BLACK EN



Top finishes

Metal	
MI	WHITE BB , BROWN E6 , SAND EC , GRAPHITE EG , BLACK EN
HPL	
HHI	WHITE/Black Core HB4 , BLACK/Black Core HN4



Base finishes

Upholstery			
TA	FAUX LEATHER Secret , FABRIC Mirage , FABRIC Cotton Club	TB	FAUX LEATHER Vintage , FABRIC Fenix Wool , FABRIC Novabuk , FABRIC Manhattan , FABRIC Visual
TC	VELVET SUPERB, FABRIC Second , FABRIC Main Line Flax , FABRIC Oceanic	TD	FABRIC Yoredale , FABRIC Remix 3
TE	FABRIC Uniform Melange	SF	LEATHER Fiore
SV	LEATHER Vintage		

COM/COL - Minimum Q.ty 1 pc. for each material. For weft or patterned fabrics see specific pages

	Base type H40: Mtl. 0.30 h. 1.40 Each		Base type H40: Mq. 0.45 Each
--	---------------------------------------	---	------------------------------

COM/COL - Minimum Q.ty 1 pc. for each material. For weft or patterned fabrics see specific pages

	Base type H50: Mtl. 0.40 h. 1.40 Each		Base type H50: Mq. 0.60 Each
--	---------------------------------------	---	------------------------------

Optionals:

		Value	Options/notes
FM-M2	Indoor matt metal M2	+ 66 €	ASH GREY ES , BRONZE E2 , BRONZE EZ + TRANSP., BULGARO RED FP , CHERRY RED EQ , DARK GREEN EL , FACEPOWDER PINK E8 , FANGO E3 , GOLDEN YELLOW EO , LIGHT BLUE EO , LIGHT GREY ET , OCEAN BLUE E1 , OCHER YELLOW E7 , PAPAYA ORANGE EA , PASTEL YELLOW E4 , PINE GREEN EJ , RED ER , SAGE GREEN E9
IM-M2	Top Indoor matt metal M2	+ 66 €	ASH GREY ES , BRONZE EZ + TRANSP., BULGARO RED FP , CHERRY RED EQ , DARK GREEN EL , FACEPOWDER PINK E8 , FANGO E3 , GOLDEN YELLOW EO , LIGHT BLUE EO , LIGHT GREY ET , OCEAN BLUE E1 , OCHER YELLOW E7 , PAPAYA ORANGE EA , PASTEL YELLOW E4 , PINE GREEN EJ , RED ER , SAGE GREEN E9
FH-H2	Top HPL HH2	+ 15 €	CEMENT/Black Core HC6 , CORTEN/Brown Core HC7 , DARK GREY/Black Core HGW
FH-H3	Top HPL HH3	+ 21 €	WHITE/White Core WB4

Bloom H40

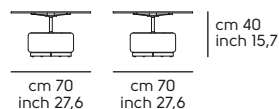

Bloom H50

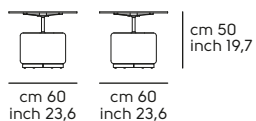

Bolle design Paola Navone

Coffee Table BOLLE

Frame in: metal



Version	Code	Mod.	Frame	Top	Optional	Q.ty	boxes	Kg	M ³
---------	------	------	-------	-----	----------	------	-------	----	----------------

Bolle HPL

Top 10 mm. thk.

				HH1	HH2	HH3					
BOLLE D. 60	T2200D60	D60	M1	386 €	407 €	431 €	FM-M2 FM-O1 FM-O2 PD-F0	1	2	11.0	0.15
BOLLE 100x100	T2200Q10	Q100	M1	602 €	733 €	856 €	FM-M2 FM-O1 FM-O2 PD-F0	1	2	20.5	0.33

Version	Code	Mod.	Frame	Top	Optional	Q.ty	boxes	Kg	M ³
---------	------	------	-------	-----	----------	------	-------	----	----------------

Bolle Metal

Top 4 mm. thk.

				M1	M2	O1	O2					
BOLLE D. 60 MT	T2201D60	D60	M1	231 €	255 €	307 €	331 €	FM-M2 FM-O1 FM-O2 PD-F0	1	2	14.0	0.15
BOLLE 100x100 MT	T2201Q10	Q100	M1	520 €	551 €	547 €	579 €	FM-M2 FM-O1 FM-O2 PD-F0	1	2	30.5	0.33

Version	Code	Mod.	Frame	Top	Optional	Q.ty	boxes	Kg	M ³
---------	------	------	-------	-----	----------	------	-------	----	----------------

Bolle Marble

Top 20 mm. thk.

				GMM							
BOLLE D. 60 MR	T2202D60	D60	M1	620 €			FM-M2 FM-O1 FM-O2 PD-F0	1	2	20.5	0.15
BOLLE 100x100 MR	T2202Q10	Q100	M1	1.554 €			FM-M2 FM-O1 FM-O2 PD-F0	1	2	59.5	0.33

Frame and top finishes

Metal

M1	WHITE BB , INDUSTRIAL E5 , BROWN E6 , SAND EC , GRAPHITE EG , BLACK EN
M2	LIGHT BLUE E0 , OCEAN BLUE E1 , BRONZE E2 , FANGO E3 , PASTEL YELLOW E4 , OCHER YELLOW E7 , FACEPOWDER PINK E8 , SAGE GREEN E9 , PAPAYA ORANGE EA , PINE GREEN EJ , DARK GREEN EL , GOLDEN YELLOW EO , CHERRY RED EQ , RED ER , ASH GREY ES , LIGHT GREY ET , BULGARO RED FP

Outdoor Metal

O1	Outdoor BROWN E6 , Outdoor WHITE BB , Outdoor SAND EC , Outdoor GRAFITE EG , Outdoor BLACK EN
O2	Outdoor LIGHT BLUE E0 , Outdoor OCEAN BLUE E1 , Outdoor BRONZE E2 , Outdoor FANGO E3 , Outdoor PASTEL YELLOW E4 , Outdoor OCHER YELLOW E7 , Outdoor FACEPOWDER PINK E8 , Outdoor SAGE GREEN E9 , Outdoor PINE GREEN EJ , Outdoor DARK GREEN EL , Outdoor GOLD YELLOW EO , Outdoor RED BULGARO FP , Outdoor CHERRY RED EQ , Outdoor RED ER , Outdoor ASH GREY ES , Outdoor LIGHT GREY ET , Outdoor PAPAYA ORANGE EA

Top finishes

HPL

HH1	WHITE/Black Core HB4 , BLACK/Black Core HN4
HH2	CEMENT/Black Core HC6 , CORTEN/Brown Core HC7 , DARK GREY/Black Core HGW
HH3	WHITE/White Core WB4

Marble

GMM	BEIGE TRAVERTINO ROMANO MB2 , WHITE CALACATTA VAGLI MB4 , BLACK MARQUINIA MN4 , GREEN TINOS MVE
------------	---

Optionals:

		Value	Options/notes
FM-M2	Indoor matt metal M2	+ 84 €	ASH GREY ES , BRONZE E2 , BULGARO RED FP , CHERRY RED EQ , DARK GREEN EL , FACEPOWDER PINK E8 , FANGO E3 , GOLDEN YELLOW EO , LIGHT BLUE E0 , LIGHT GREY ET , OCEAN BLUE E1 , OCHER YELLOW E7 , PAPAYA ORANGE EA , PASTEL YELLOW E4 , PINE GREEN EJ , RED ER , SAGE GREEN E9
FM-O1	Outdoor metal O1	+ 95 €	Outdoor BLACK EN , Outdoor BROWN E6 , Outdoor GRAFITE EG , Outdoor SAND EC , Outdoor WHITE BB
FM-O2	Outdoor metal O2	+ 147 €	Outdoor ASH GREY ES , Outdoor BRONZE E2 , Outdoor CHERRY RED EQ , Outdoor DARK GREEN EL , Outdoor FACEPOWDER PINK E8 , Outdoor FANGO E3 , Outdoor GOLD YELLOW EO , Outdoor LIGHT BLUE E0 , Outdoor LIGHT GREY ET , Outdoor OCEAN BLUE E1 , Outdoor OCHER YELLOW E7 , Outdoor PAPAYA ORANGE EA , Outdoor PASTEL YELLOW E4 , Outdoor PINE GREEN EJ , Outdoor RED BULGARO FP , Outdoor RED ER , Outdoor SAGE GREEN E9
PD-F0	Felt pad feet	+ 6 €	PD-F0

BOLLE D60

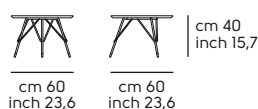

BOLLE Q100

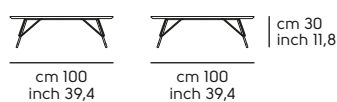

Clessidra design Paolo Vernier

Coffee Table CLESSIDRA

Frame in: metal



Version	Code	Mod.	Frame	Top	Optional	Q.ty	boxes	Kg	M³
---------	------	------	-------	-----	----------	------	-------	----	----

Clessidra MDF

Top 19 mm. thk.

				LM1					
CLESSIDRA H26 D70	T19652770L	H26 D70	M1	557 €	FM-M2	1	2	22.5	0.12
CLESSIDRA H30 D80	T19653480L	H30 D80	M1	639 €	FM-M2	1	2	30.0	0.15
CLESSIDRA H40 D40	T19654040L	H40 D40	M1	439 €	FM-M2	1	2	15.5	0.04
CLESSIDRA H50 D50	T19655050L	H50 D50	M1	465 €	FM-M2	1	2	18.5	0.06

Version	Code	Mod.	Frame	Top	Optional	Q.ty	boxes	Kg	M³
---------	------	------	-------	-----	----------	------	-------	----	----

Clessidra Metal

Top 2,5 mm. thk.

				M1	M2					
CLESSIDRA H26 D70	T19652770M	H26 D70	M1	549 €	585 €	FM-M2	1	2	26.0	0.12
CLESSIDRA H30 D80	T19653480M	H30 D80	M1	600 €	627 €	FM-M2	1	2	34.0	0.15
CLESSIDRA H40 D40	T19654040M	H40 D40	M1	433 €	460 €	FM-M2	1	2	17.0	0.04
CLESSIDRA H50 D50	T19655050M	H50 D50	M1	446 €	475 €	FM-M2	1	2	20.0	0.06

Version	Code	Mod.	Frame	Top	Optional	Q.ty	boxes	Kg	M³
---------	------	------	-------	-----	----------	------	-------	----	----

Clessidra Hide

Top 5 mm. thk.

				CU	CT					
CLESSIDRA H26 D70	T19652770C	H26 D70	M1	601 €	629 €	FM-M2	1	2	28.0	0.12
CLESSIDRA H30 D80	T19653480C	H30 D80	M1	655 €	693 €	FM-M2	1	2	36.5	0.15
CLESSIDRA H40 D40	T19654040C	H40 D40	M1	460 €	482 €	FM-M2	1	2	18.0	0.04
CLESSIDRA H50 D50	T19655050C	H50 D50	M1	479 €	510 €	FM-M2	1	2	21.0	0.06

Version	Code	Mod.	Frame	Top	Optional	Q.ty	boxes	Kg	M³
---------	------	------	-------	-----	----------	------	-------	----	----

Clessidra Ceramic

Top 6 mm. thk.

				GKA	GKB	GMA					
CLESSIDRA H26 D70	T19652770V	H26 D70	M1	639 €	669 €	696 €	FM-M2	1	2	29.0	0.12
CLESSIDRA H30 D80	T19653480V	H30 D80	M1	706 €	725 €	761 €	FM-M2	1	2	38.0	0.15
CLESSIDRA H40 D40	T19654040V	H40 D40	M1	490 €	508 €	524 €	FM-M2	1	2	18.0	0.04
CLESSIDRA H50 D50	T19655050V	H50 D50	M1	539 €	557 €	572 €	FM-M2	1	2	21.5	0.06

Version	Code	Mod.	Frame	Top	Optional	Q.ty	boxes	Kg	M ³
---------	------	------	-------	-----	----------	------	-------	----	----------------

Clessidra Marble
Top 20 mm. thk.

				GMM					
CLESSIDRA H26 D70	T19652770Z	H26 D70	M1	1.038 €	FM-M2	1	2	36.0	0.12
CLESSIDRA H30 D80	T19653480Z	H30 D80	M1	1.242 €	FM-M2	1	2	48.0	0.15
CLESSIDRA H40 D40	T19654040Z	H40 D40	M1	580 €	FM-M2	1	2	20.0	0.04
CLESSIDRA H50 D50	T19655050Z	H50 D50	M1	706 €	FM-M2	1	2	34.0	0.06

Frame and top finishes

Metal

M1	WHITE BB , BROWN E6 , SAND EC , GRAPHITE EG , BLACK EN	M2	LIGHT BLUE E0 , OCEAN BLUE E1 , BRONZE E2 , FANGO E3 , PASTEL YELLOW E4 , OCHER YELLOW E7 , FACEPOWDER PINK E8 , SAGE GREEN E9 , PAPAYA ORANGE EA , PINE GREEN EJ , DARK GREEN EL , GOLDEN YELLOW EO , CHERRY RED EQ , RED ER , ASH GREY ES , LIGHT GREY ET , BULGARO RED FP
-----------	---	-----------	---

Insert finishes

Metal

M1	WHITE BB , BROWN E6 , SAND EC , GRAPHITE EG , BLACK EN
M2	LIGHT BLUE E0 , OCEAN BLUE E1 , BRONZE E2 , FANGO E3 , PASTEL YELLOW E4 , OCHER YELLOW E7 , FACEPOWDER PINK E8 , SAGE GREEN E9 , PAPAYA ORANGE EA , PINE GREEN EJ , DARK GREEN EL , GOLDEN YELLOW EO , CHERRY RED EQ , RED ER , ASH GREY ES , LIGHT GREY ET , BULGARO RED FP
M4	GOLDEN BRONZE DB , MATT GOLDEN BRONZE DC , CHAMPAGNE GOLD DG , PINK GOLD DR , MATT BLACK NICKEL DY , BLACK NICKEL DZ

Top finishes

Lacquered MDF

LMI	GRAPHITE GREY G02 , BLACK G04 , WHITE G05 , SAND G07 , BROWN G41
------------	---

Hide

CU	HIDE
CT	TUSCAN HIDE

Crystal Ceramic and Ceramic

GKA	PIOMBO K01 , CHARCOAL SAVOIA K11 , CEMENT SAVOIA K12 , EMPERADOR MARBLE BRUSH.MATT BROWN K31
GKB	RUST OXIDE K23 , WHITE CALCE K24
GMA	MARBLE CALACATTA GLOSSY WHITE K32 , BLACK GREEK MARBLE K33 , MARBLE GLOSSY NOIR DESIR K35 , MARBLE CALACATTA MATT WHITE K42 , MARBLE MATT NOIR DESIR K45 , MARBLE MATT GREEN TINOS K46

Marble

GMM	BEIGE TRAVERTINO ROMANO MB2 , WHITE CALACATTA VAGLI MB4 , BLACK MARQUINIA MN4 , GREEN TINOS MVE
------------	---

Optionals:

	Value	Options/notes
FM-M2	Indoor matt metal M2	+ 100 € ASH GREY ES , BRONZE E2 , BULGARO RED FP , CHERRY RED EQ , DARK GREEN EL , FACEPOWDER PINK E8 , FANGO E3 , GOLDEN YELLOW EO , LIGHT BLUE E0 , LIGHT GREY ET , OCEAN BLUE E1 , OCHER YELLOW E7 , PAPAYA ORANGE EA , PASTEL YELLOW E4 , PINE GREEN EJ , RED ER , SAGE GREEN E9

CLESSIDRA H26 D70

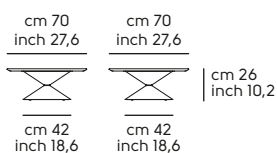

CLESSIDRA H30 D80

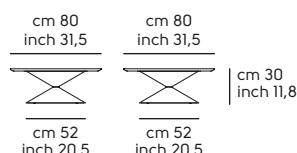

CLESSIDRA H40 D40

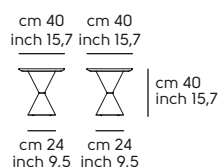

CLESSIDRA H50 D50

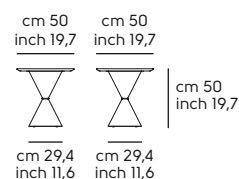

Dalia design Beatriz Sempere

Coffee Table DALIA

Frame in: wood



Version	Code	Mod.	Frame	Top	Optional	Q.ty	boxes	Kg	M ³	
Dalia Veneer										
Top 17 mm. thk.										
				LI1	LI2					
DALIA CTS_H45	T1850H45	CTS	LI1-LI2	424 €	462 €	PD-F0	1	1	3.6	0.09
DALIA CTM_H40	T1850H40	CTM	LI1-LI2	529 €	568 €	PD-F0	1	1	4.45	0.12
DALIA CTL_H35	T1850H35	CTL	LI1-LI2	758 €	816 €	PD-F0	1	1	9.55	0.25

Note:

--

Frame finishes

Veneer

LI1	Veneered wood painted BLACK I04 , Veneered wood painted NATURAL I40
LI2	Veneered wood NATURAL OAK I22 , Veneered wood FLAMED WALNUT I24

Top finishes

Wood

LI1	BLACK I04 , NATURAL I40
LI2	NATURAL OAK I22 , FLAMED WALNUT I24

Optionals:

		Value	Options/notes
PD-F0	Felt pad feet	+ 6 €	PD-F0

Dalia CTS

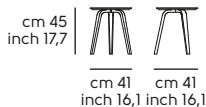

Dalia CTM

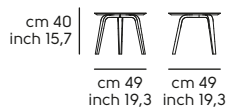

Dalia CTL



Guapa design Sempere e Poli

Coffee Table GUAPA

Frame in: metal



Version	Code	Mod.	Frame	Top	Optional	Q.ty	boxes	Kg	M ³
Guapa Hide Top 18 mm. thk.									
				CU	CT				
GUAPA CT-S	TI150CTS	CTS	MI	305 €	344 €	FM-M2 FM-M3 FM-M4	1 2	5.0	0.12
GUAPA CT-M	TI150CTM	CTM	MI	393 €	471 €	FM-M2 FM-M3 FM-M4	1 2	8.1	0.2
GUAPA CT-L	TI150CTL	CTL	MI	710 €	899 €	FM-M2 FM-M3 FM-M4	1 2	16.0	0.45

Frame finishes

Metal

MI WHITE **BB**, BROWN **E6**, SAND **EC**, GRAPHITE **EG**, BLACK **EN**

Top finishes

Hide

CU HIDE

CT TUSCAN HIDE

Optionals:

		Value	Options/notes
FM-M2	Indoor matt metal M2	+ 51 €	ASH GREY ES , BRONZE E2 , BULGARO RED FP , CHERRY RED EQ , DARK GREEN EL , FACEPOWDER PINK E8 , FANGO E3 , GOLDEN YELLOW EO , LIGHT BLUE E0 , LIGHT GREY ET , OCEAN BLUE E1 , OCHER YELLOW E7 , PAPAYA ORANGE EA , PASTEL YELLOW E4 , PINE GREEN EJ , RED ER , SAGE GREEN E9
FM-M3	Indoor glossy metal M3	+ 25 €	CHROME CC
FM-M4	Indoor glossy Metal M4	+ 103 €	BLACK NICKEL DZ , CHAMPAGNE GOLD DG , GOLDEN BRONZE DB , MATT BLACK NICKEL DY , MATT GOLDEN BRONZE DC , PINK GOLD DR

Guapa CTS

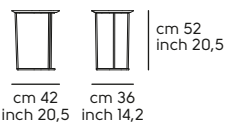

Guapa CTM

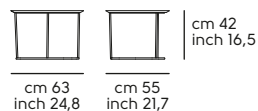

Guapa CTL

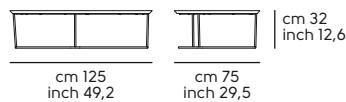

Hoodi design Roberto Paoli

Coffee Table HOODI

Frame in: metal



Version	Code	Mod.	--	Frame and Top	Optional	Q.ty	boxes	Kg	M ³
---------	------	------	----	---------------	----------	------	-------	----	----------------

Hoodi Metal

Top 4 mm. thk.

				M1	M2					
HOODI CTS_MT	T2060CTS	CTS		164 €	216 €		1	1	7.0	0.08
HOODI CTM_MT	T2060CTM	CTM		182 €	235 €		1	1	7.5	0.11
HOODI CTL_MT	T2060CTL	CTL		205 €	256 €		1	1	8.0	0.15

Version	Code	Mod.	Frame	Top	Optional	Q.ty	boxes	Kg	M ³
---------	------	------	-------	-----	----------	------	-------	----	----------------

Hoodi Hide

Top 7 mm. thk.

				CU	CT					
HOODI CTS_CU	T2062CTS	CTS	M1	216 €	256 €	FM-M2 FM-M4	1	1	7.5	0.08
HOODI CTM_CU	T2062CTM	CTM	M1	251 €	315 €	FM-M2 FM-M4	1	1	8.0	0.11
HOODI CTL_CU	T2062CTL	CTL	M1	290 €	393 €	FM-M2 FM-M4	1	1	9.0	0.15

Frame and top finishes

Metal

M1	WHITE BB , BROWN E6 , SAND EC , GRAPHITE EG , BLACK EN	M2	LIGHT BLUE E0 , OCEAN BLUE E1 , BRONZE E2 , FANGO E3 , PASTEL YELLOW E4 , OCHER YELLOW E7 , FACEPOWDER PINK E8 , SAGE GREEN E9 , PAPAYA ORANGE EA , PINE GREEN EJ , DARK GREEN EL , GOLDEN YELLOW EO , CHERRY RED EQ , RED ER , ASH GREY ES , LIGHT GREY ET , BRONZE EZ + TRANSP., BULGARO RED FP
-----------	---	-----------	---

Top finishes

Hide

CU	HIDE	CT	TUSCAN HIDE
-----------	------	-----------	-------------

Optionals:

		Value	Options/notes
FM-M2	Indoor matt metal M2	+ 61 €	ASH GREY ES , BRONZE E2 , BULGARO RED FP , CHERRY RED EQ , DARK GREEN EL , FACEPOWDER PINK E8 , FANGO E3 , GOLDEN YELLOW EO , LIGHT BLUE E0 , LIGHT GREY ET , OCEAN BLUE E1 , OCHER YELLOW E7 , PAPAYA ORANGE EA , PASTEL YELLOW E4 , PINE GREEN EJ , RED ER , SAGE GREEN E9
FM-M4	Indoor glossy Metal M4	+ 129 €	BLACK NICKEL DZ , CHAMPAGNE GOLD DG , GOLDEN BRONZE DB , MATT BLACK NICKEL DY , MATT GOLDEN BRONZE DC , PINK GOLD DR

Hoodi CTS

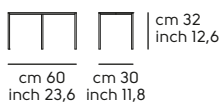

Hoodi CTM

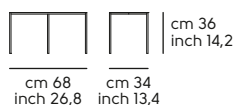

Hoodi CTL

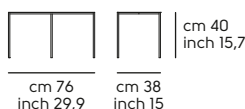

Joint design Midj R&D

Coffee Table JOINT

Frame in: metal



Version	Code	Mod.	Frame	Top	Optional	Q.ty	boxes	Kg	M ³	
Joint Hide Top 30 mm. thk.										
				CU	CT					
JOINT H35 D. 50_CU	T0200C35	H35_5	MI	607 €	696 €	FM-M2 FM-M3 FM-M4	1	1	9.0	0.12
JOINT H60 D. 50_CU	T0200C60	H60_5	MI	632 €	721 €	FM-M2 FM-M3 FM-M4	1	1	10.0	0.19
JOINT H35 D.100_CU	T0200CA1	H3510	MI	1.019 €	1.148 €	FM-M2 FM-M3 FM-M4	1	1	16.0	0.21

Joint Ceramic

Top 30 mm. thk.

				GKA	GKB	GMA					
JOINT H35 D. 50_KR	T0200H35	H35_5	MI	637 €	669 €	769 €	FM-M2 FM-M3 FM-M4	1	1	9.0	0.12
JOINT H60 D. 50_KR	T0200H60	H60_5	MI	644 €	677 €	778 €	FM-M2 FM-M3 FM-M4	1	1	10.0	0.19
JOINT H35 D.100_KR	T0200HA1	H3510	MI	1.051 €	1.083 €	1.133 €	FM-M2 FM-M3 FM-M4	1	1	16.0	0.21

Frame finishes

Metal

MI WHITE **BB**, BROWN **E6**, SAND **EC**, GRAPHITE **EG**, BLACK **EN**

Top finishes

Hide

CU HIDE

CT TUSCAN HIDE

Crystal Ceramic and Ceramic

GKA PIOMBO **K01**, CHARCOAL SAVOIA **K11**, CEMENT SAVOIA **K12**, EMPERADOR MARBLE BRUSH.MATT BROWN **K31**

GKB RUST OXIDE **K23**, WHITE CALCE **K24**

Crystal Ceramic and glossy Ceramic

GMA MARBLE CALACATTA GLOSSY WHITE **K32**, BLACK GREEK MARBLE **K33**, MARBLE GLOSSY NOIR DESIR **K35**, MARBLE CALACATTA MATT WHITE **K42**, MARBLE MATT NOIR DESIR **K45**, MARBLE MATT GREEN TINOS **K46**

Optionals:

		Value	Options/notes
FM-M2	Indoor matt metal M2	+ 88 €	ASH GREY ES , BRONZE E2 , BULGARO RED FP , CHERRY RED EQ , DARK GREEN EL , FACEPOWDER PINK E8 , FANGO E3 , GOLDEN YELLOW EO , LIGHT BLUE EO , LIGHT GREY ET , OCEAN BLUE E1 , OCHER YELLOW E7 , PAPAYA ORANGE EA , PASTEL YELLOW E4 , PINE GREEN EJ , RED ER , SAGE GREEN E9
FM-M3	Indoor glossy metal M3	+ 66 €	CHROME CC
FM-M4	Indoor glossy Metal M4	+ 105 €	BLACK NICKEL DZ , CHAMPAGNE GOLD DG , GOLDEN BRONZE DB , MATT BLACK NICKEL DY , MATT GOLDEN BRONZE DC , PINK GOLD DR

Joint H35_5

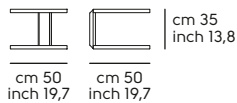

Joint H60_5

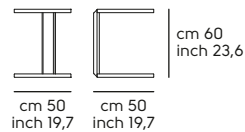

Joint H35_10

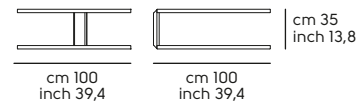

Lea design Paolo Vernier

Coffee Table LEA

Frame in: metal



Version	Code	Mod.	Frame	Top	Optional	Q.ty	boxes	Kg	M ³
---------	------	------	-------	-----	----------	------	-------	----	----------------

Lea Veneer

Top 16 mm. thk.

				LI1	LI2					
LEA CT-S_LG	T1940CTS	CTS	MI	374 €	406 €	FM-M2 FM-M4 PD-F0	1	1	8.5	0.1
LEA CT-M_LG	T1940CTM	CTM	MI	439 €	477 €	FM-M2 FM-M4 PD-F0	1	1	10.5	0.11
LEA CT-L_LG	T1940CTL	CTL	MI	542 €	595 €	FM-M2 FM-M4 PD-F0	1	1	12.5	0.16

Lea Ceramic

Top 13 mm. thk. |GMA Top 16 mm. thk.

				GKA	GKB	GMA					
LEA CT-S_KR	T1940CTS	CTS	MI	459 €	480 €	509 €	FM-M2 FM-M4 PD-F0	1	1	8.5	0.1
LEA CT-M_KR	T1940CTM	CTM	MI	513 €	541 €	579 €	FM-M2 FM-M4 PD-F0	1	1	10.5	0.11
LEA CT-L_KR	T1940CTL	CTL	MI	669 €	699 €	747 €	FM-M2 FM-M4 PD-F0	1	1	12.5	0.16

Frame finishes**Metal****MI** WHITE **BB**, BROWN **E6**, SAND **EC**, GRAPHITE **EG**, BLACK **EN****Top finishes****Wood****LI1** BLACK **I04**, NATURAL **I40****LI2** NATURAL OAK **I22**, FLAMED WALNUT **I24****Crystal Ceramic and Ceramic****GKA** PIOMBO **K01**, CHARCOAL SAVOIA **K11**, CEMENT SAVOIA **K12**, EMPERADOR MARBLE BRUSH.MATT BROWN **K31****GKB** RUST OXIDE **K23**, WHITE CALCE **K24****Crystal Ceramic and glossy Ceramic****GMA** MARBLE CALACATTA GLOSSY WHITE **K32**, BLACK GREEK MARBLE **K33**, MARBLE GLOSSY NOIR DESIR **K35**, MARBLE CALACATTA MATT WHITE **K42**, MARBLE MATT NOIR DESIR **K45**, MARBLE MATT GREEN TINOS **K46****Optionals:**

		Value	Options/notes
FM-M2	Indoor matt metal M2	+ 88 €	ASH GREY ES , BRONZE E2 , BULGARO RED FP , CHERRY RED EQ , DARK GREEN EL , FACEPOWDER PINK E8 , FANGO E3 , GOLDEN YELLOW EO , LIGHT BLUE EO , LIGHT GREY ET , OCEAN BLUE E1 , OCHER YELLOW E7 , PAPAYA ORANGE EA , PASTEL YELLOW E4 , PINE GREEN EJ , RED ER , SAGE GREEN E9
FM-M4	Indoor glossy Metal M4	+ 154 €	BLACK NICKEL DZ , CHAMPAGNE GOLD DG , GOLDEN BRONZE DB , MATT BLACK NICKEL DY , MATT GOLDEN BRONZE DC , PINK GOLD DR
PD-F0	Felt pad feet	+ 6 €	PD-F0

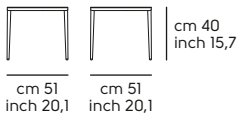
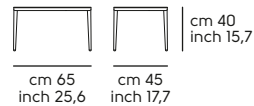
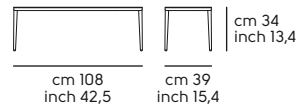
Lea CTS**Lea CTM****Lea CTL**

Ola design Paolo Vernier

Coffee Table OLA

Frame in: metal



Version	Code	Mod.	--	Frame and Top	Optional	Q.ty	boxes	Kg	M ³
---------	------	------	----	---------------	----------	------	-------	----	----------------

Ola Metal

Top 1 mm. thk.

				M1	M2	O1	O2					
OLA CT 45	T1400M04	45	--	128 €	174 €	206 €	243 €		1	1	6.0	0.11
OLA CT 105	T1400M10	105	--	247 €	314 €	378 €	431 €		1	1	10.0	0.24

Frame and top finishes

Metal

M1	WHITE BB , INDUSTRIAL E5 , BROWN E6 , SAND EC , GRAPHITE EG , BLACK EN
-----------	--

Metal

M2	LIGHT BLUE E0 , OCEAN BLUE E1 , BRONZE E2 , FANGO E3 , PASTEL YELLOW E4 , OCHER YELLOW E7 , FACEPOWDER PINK E8 , SAGE GREEN E9 , PAPAYA ORANGE EA , PINE GREEN EJ , DARK GREEN EL , GOLDEN YELLOW EO , CHERRY RED EQ , RED ER , ASH GREY ES , LIGHT GREY ET , BULGARO RED FP
-----------	---

Outdoor Metal

O1	Outdoor BROWN E6 , Outdoor WHITE BB , Outdoor SAND EC , Outdoor GRAFITE EG , Outdoor BLACK EN
-----------	--

Outdoor Metal

O2	Outdoor LIGHT BLUE E0 , Outdoor OCEAN BLUE E1 , Outdoor BRONZE E2 , Outdoor FANGO E3 , Outdoor PASTEL YELLOW E4 , Outdoor OCHER YELLOW E7 , Outdoor FACEPOWDER PINK E8 , Outdoor SAGE GREEN E9 , Outdoor PINE GREEN EJ , Outdoor DARK GREEN EL , Outdoor GOLD YELLOW EO , Outdoor RED BULGARO FP , Outdoor CHERRY RED EQ , Outdoor RED ER , Outdoor ASH GREY ES , Outdoor LIGHT GREY ET , Outdoor PAPAYA ORANGE EA
-----------	---

Ola 45

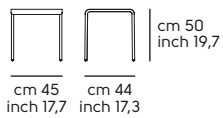

Ola 105

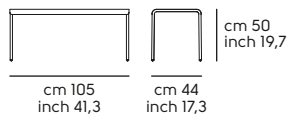

P47 design Franco Poli

Coffee Table P47

Frame in: metal



Version	Code	Mod.	Frame	Top Metal (Hide CK)			Optional	Q.ty	boxes	Kg	M ³
P47 Metal-Hide											
Top 5 mm. thk.											
				M1	M2	M5					
P47 CT-S H60	T2140CTS	CTS	M1	406 €	447 €	424 €	FM-M2 FM-M3 FM-M4 RV-CT	1	1	9.0	0.128
P47 CT-M H50	T2140CTM	CTM	M1	499 €	539 €	515 €	FM-M2 FM-M3 FM-M4 RV-CT	1	1	11.0	0.16
P47 CT-L H40	T2140CTL	CTL	M1	581 €	622 €	599 €	FM-M2 FM-M3 FM-M4 RV-CT	1	1	13.5	0.182

Frame finishes

Metal

M1 WHITE **BB**, BROWN **E6**, SAND **EC**, GRAPHITE **EG**, BLACK **EN**

Hide finishes

Upholstery

CK HIDE_TK

Top finishes

Metal

M1 WHITE **BB**, BROWN **E6**, SAND **EC**, GRAPHITE **EG**, BLACK **EN**

M2

LIGHT BLUE **E0**, OCEAN BLUE **E1**, BRONZE **E2**, FANGO **E3**, PASTEL YELLOW **E4**, OCHER YELLOW **E7**, FACEPOWDER PINK **E8**, SAGE GREEN **E9**, PAPAYA ORANGE **EA**, PINE GREEN **EJ**, DARK GREEN **EL**, GOLDEN YELLOW **EO**, CHERRY RED **EQ**, RED **ER**, ASH GREY **ES**, LIGHT GREY **ET**, BULGARO RED **FP**

M5 SATIN STAINLESS STEEL **HS**

Optionals:

		Value	Options/notes
FM-M2	Indoor matt metal M2	+ 66 €	ASH GREY ES , BRONZE E2 , BULGARO RED FP , CHERRY RED EQ , DARK GREEN EL , FACEPOWDER PINK E8 , FANGO E3 , GOLDEN YELLOW EO , LIGHT BLUE E0 , LIGHT GREY ET , OCEAN BLUE E1 , OCHER YELLOW E7 , PAPAYA ORANGE EA , PASTEL YELLOW E4 , PINE GREEN EJ , RED ER , SAGE GREEN E9
FM-M3	Indoor glossy metal M3	+ 44 €	CHROME CC
FM-M4	Indoor glossy Metal M4	+ 88 €	BLACK NICKEL DZ , CHAMPAGNE GOLD DG , GOLDEN BRONZE DB , MATT BLACK NICKEL DY , MATT GOLDEN BRONZE DC , PINK GOLD DR
RV-CT	Tuscan hide	+ 93 €	TUSCAN HIDE

P47 CTS

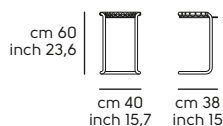

P47 CTM

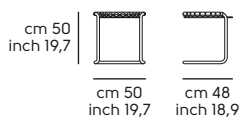

P47 CTL

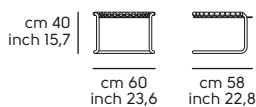

Paw design Studio Pastina

Coffee Table PAW

Frame in: metal



Version	Code	Mod.	--	Frame and Top	Optional	Q.ty	boxes	Kg	M³
---------	------	------	----	---------------	----------	------	-------	----	----

Paw Metal

Top 6 mm. thk.

				M1	M2					
PAW H30 50x90_MT	T2050H30	CTS		461 €	513 €		1	1	12.0	0.14
PAW H40 50x50_MT	T2050H40	CTM		401 €	461 €		1	1	8.0	0.11
PAW H50 50x90_MT	T2050H50	CTL		492 €	555 €		1	1	13.0	0.24

Version	Code	Mod.	Frame	Top	Optional	Q.ty	boxes	Kg	M³
---------	------	------	-------	-----	----------	------	-------	----	----

Paw Ceramic

Top 12 mm. thk.

				GKA	GKB	GMA					
PAW H30 50x90_KR	T2051H30	CTS	M1	833 €	843 €	912 €	FM-M2	1	1	13.0	0.14
PAW H40 50x50_KR	T2051H40	CTM	M1	656 €	668 €	702 €	FM-M2	1	1	9.0	0.11
PAW H50 50x90_KR	T2051H50	CTL	M1	861 €	874 €	943 €	FM-M2	1	1	14.0	0.24

Note:

OUTDOOR

Frame and top finishes

Metal

M1	WHITE BB , BROWN E6 , SAND EC , GRAPHITE EG , BLACK EN	M2	LIGHT BLUE E0 , OCEAN BLUE E1 , FANGO E3 , PASTEL YELLOW E4 , OCHER YELLOW E7 , FACEPOWDER PINK E8 , SAGE GREEN E9 , PAPAYA ORANGE EA , PINE GREEN EJ , DARK GREEN EL , GOLDEN YELLOW EO , CHERRY RED EQ , RED ER , ASH GREY ES , LIGHT GREY ET , BRONZE EZ + TRANSP., BULGARO RED FP
-----------	---	-----------	--

Top finishes

Crystal Ceramic and glossy Ceramic

GKA	PIOMBO K01 , CHARCOAL SAVOIA K11 , CEMENT SAVOIA K12 , EMPERADOR MARBLE BRUSH.MATT BROWN K31	GKB	RUST OXIDE K23 , WHITE CALCE K24
GMA	MARBLE CALACATTA GLOSSY WHITE K32 , BLACK GREEK MARBLE K33 , MARBLE GLOSSY NOIR DESIR K35 , MARBLE CALACATTA MATT WHITE K42 , MARBLE MATT NOIR DESIR K45 , MARBLE MATT GREEN TINOS K46		

Optionals:

	Value	Options/notes
FM-M2	Indoor matt metal M2	+ 61 €
		ASH GREY ES , BRONZE EZ + TRANSP., BULGARO RED FP , CHERRY RED EQ , DARK GREEN EL , FACEPOWDER PINK E8 , FANGO E3 , GOLDEN YELLOW EO , LIGHT BLUE E0 , LIGHT GREY ET , OCEAN BLUE E1 , OCHER YELLOW E7 , PAPAYA ORANGE EA , PASTEL YELLOW E4 , PINE GREEN EJ , RED ER , SAGE GREEN E9

Paw CTS

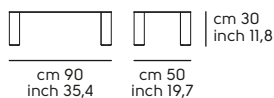

Paw CTM

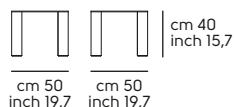

Paw CTL

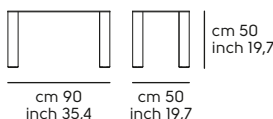

Suite design Ateliernanni

Coffee Table SUITE

Frame in: wood



Version	Code	Mod.	Frame	Top	Optional	Q.ty	boxes	Kg	M ³
---------	------	------	-------	-----	----------	------	-------	----	----------------

Suite Hide

Top 28 mm. thk.

				CU	CT					
SUITE CT H30 D. 55_CU	T1750C30	H30 D55	LF1	333 €	390 €		1	1	5.0	0.12
SUITE CT H30 55x55_CU	T1750C35	H30 55x55	LF1	370 €	434 €		1	1	5.0	0.12
SUITE CT H30 70x35_CU	T1750C37	H30 70x35	LF1	383 €	427 €		1	1	5.0	0.11
SUITE CT H40 D. 55_CU	T1750C40	H40 D55	LF1	345 €	402 €		1	1	5.5	0.16
SUITE CT H40 55x55_CU	T1750C45	H40 55x55	LF1	384 €	445 €		1	1	5.5	0.16
SUITE CT H40 70x35_CU	T1750C47	H40 70x35	LF1	395 €	460 €		1	1	5.5	0.12
SUITE CT H50 D. 55_CU	T1750C50	H50 D55	LF1	358 €	415 €		1	1	6.0	0.2
SUITE CT H50 55x55_CU	T1750C55	H50 55x55	LF1	396 €	460 €		1	1	6.0	0.2
SUITE CT H50 70x35_CU	T1750C57	H50 70x35	LF1	410 €	471 €		1	1	6.0	0.16

Suite Ceramic

Top 30 mm. thk.

				GMA					
SUITE CT H30 D. 55_KR	T1750H30	H30 D55	LF1	513 €		1	1	5.0	0.12
SUITE CT H30 55x55_KR	T1750H35	H30 55x55	LF1	583 €		1	1	5.0	0.12
SUITE CT H30 70x35_KR	T1750H37	H30 70x35	LF1	564 €		1	1	5.0	0.11
SUITE CT H40 D. 55_KR	T1750H40	H40 D55	LF1	526 €		1	1	5.5	0.16
SUITE CT H40 55x55_KR	T1750H45	H40 55x55	LF1	595 €		1	1	5.5	0.16
SUITE CT H40 70x35_KR	T1750H47	H40 70x35	LF1	575 €		1	1	5.5	0.12
SUITE CT H50 D. 55_KR	T1750H50	H50 D55	LF1	537 €		1	1	6.0	0.2
SUITE CT H50 55x55_KR	T1750H55	H50 55x55	LF1	610 €		1	1	6.0	0.2
SUITE CT H50 70x35_KR	T1750H57	H50 70x35	LF1	589 €		1	1	6.0	0.16

Frame finishes

Solid ash

LFI	Ash wood painted GREY F02 , Ash wood painted GRAFITE GREY F03 , Ash wood painted BLACK F04 , Ash wood painted WHITE F05 , Ash wood painted BLUE F06 , Ash wood painted RED F08 , Ash wood painted CHERRY RED F09 , Ash wood painted FLAMED WALNUT F24 , Ash wood painted DARK BROWN F26 , Ash wood painted NATURAL F40 , Ash wood painted NATURAL OAK F52
------------	--

Top finishes

Hide	
CU	HIDE
CT	TUSCAN HIDE

Crystal Ceramic and glossy Ceramic	
GMA	MARBLE CALACATTA GLOSSY WHITE K32 , BLACK GREEK MARBLE K33 , MARBLE GLOSSY NOIR DESIR K35 , MARBLE CALACATTA MATT WHITE K42 , MARBLE MATT NOIR DESIR K45 , MARBLE MATT GREEN TINOS K46

Suite H30 D55

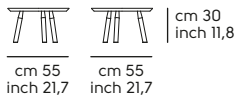

Suite H30 55x55

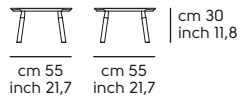

Suite H30 70x35

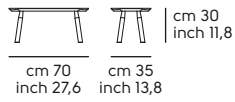

Suite H40 D55

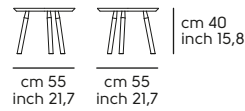

Suite H40 55x55

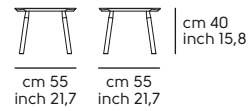

Suite H40 70x35

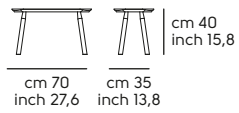

Suite H50 D55

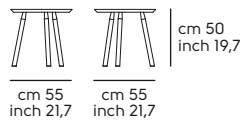

Suite H50 55x55

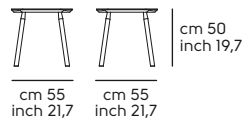

Suite H50 70x35

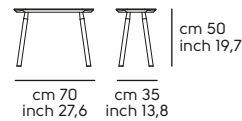

Trampoliere design Roberto Paoli

Coffee Table TRAMPOLIERE

Frame in: metal



Version	Code	Mod.	Frame	Top	Optional	G.ty	boxes	Kg	M ³
---------	------	------	-------	-----	----------	------	-------	----	----------------

Trampoliere Melamine HL

Top 18 mm. thk.

				HL1					
TRAMPOLIERE H34 D. 70	T1550H34	H34	M1	227 €	FM-M2	1	2	15.5	0.2
TRAMPOLIERE H44 D. 60	T1550H44	H44	M1	198 €	FM-M2	1	2	13.5	0.16
TRAMPOLIERE H54 D. 50	T1550H54	H54	M1	186 €	FM-M2	1	2	14.5	0.15

Trampoliere HPL

Top 10 mm. thk.

				HH1	HH2	HH3					
TRAMPOLIERE H34 D. 70	T1550H34	H34	M1	333 €	347 €	374 €	FM-M2	1	2	15.5	0.2
TRAMPOLIERE H44 D. 60	T1550H44	H44	M1	315 €	329 €	343 €	FM-M2	1	2	13.5	0.16
TRAMPOLIERE H54 D. 50	T1550H54	H54	M1	269 €	277 €	286 €	FM-M2	1	2	14.5	0.15

Frame finishes

Metal

M1	WHITE BB , BROWN E6 , SAND EC , GRAPHITE EG , BLACK EN
-----------	---

Top finishes

Melamine HL

HL1	WHITE M01 , GRAFITE M02 , BLACK M04 , SAND M07
------------	--

HPL

HH1	WHITE/Black Core HB4 , BLACK/Black Core HN4
HH2	CEMENT/Black Core HC6 , CORTEN/Brown Core HC7 , DARK GREY/Black Core HGW
HH3	WHITE/White Core WB4

Optionals:

	Value	Options/notes
FM-M2	Indoor matt metal M2 + 61 €	ASH GREY ES , BRONZE E2 , BULGARO RED FP , CHERRY RED EQ , DARK GREEN EL , FACEPOWDER PINK E8 , FANGO E3 , GOLDEN YELLOW EO , LIGHT BLUE E0 , LIGHT GREY ET , OCEAN BLUE E1 , OCHER YELLOW E7 , PAPAYA ORANGE EA , PASTEL YELLOW E4 , PINE GREEN EJ , RED ER , SAGE GREEN E9

Trampoliere H34

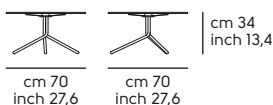

Trampoliere H44

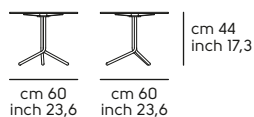

Trampoliere H54

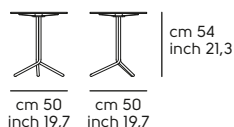

Trip design Paolo Vernier

Coffee Table TRIP

Frame in: metal



Version	Code	Mod.	Frame	Top	Optional	G.ty	boxes	Kg	M ²
Trip Hide Top 6 mm. thk.									
				CU	CT				
TRIP H45_CU	T0280C45	H45	MI	246 €	271 €	FM-M2 FM-M4	1 1	5.0	0.06
TRIP H50_CU	T0280C50	H50	MI	273 €	299 €	FM-M2 FM-M4	1 1	6.0	0.09
TRIP H60_CU	T0280C60	H60	MI	310 €	335 €	FM-M2 FM-M4	1 1	7.0	0.16

Trip Ceramic

Top 8 mm. thk.

				GKA	GKB	GMA	Optional	G.ty	boxes	Kg	M ²
TRIP H45_KR	T0280H45	H45	MI	261 €	280 €	289 €	FM-M2 FM-M4	1	1	5.0	0.06
TRIP H50_KR	T0280H50	H50	MI	296 €	305 €	317 €	FM-M2 FM-M4	1	1	6.0	0.09
TRIP H60_KR	T0280H60	H60	MI	334 €	345 €	358 €	FM-M2 FM-M4	1	1	7.0	0.16

Frame finishes

Metal

MI WHITE **BB**, BROWN **E6**, SAND **EC**, GRAPHITE **EG**, BLACK **EN**

Top finishes

Hide

CU HIDE

CT TUSCAN HIDE

Crystal Ceramic and Ceramic

GKA PIOMBO **K01**, CHARCOAL SAVOIA **K11**, CEMENT SAVOIA **K12**, EMPERADOR MARBLE BRUSH.MATT BROWN **K31**

GKB RUST OXIDE **K23**, WHITE CALCE **K24**

Crystal Ceramic and glossy Ceramic

GMA MARBLE CALACATTA GLOSSY WHITE **K32**, BLACK GREEK MARBLE **K33**, MARBLE GLOSSY NOIR DESIR **K35**, MARBLE CALACATTA MATT WHITE **K42**, MARBLE MATT NOIR DESIR **K45**, MARBLE MATT GREEN TINOS **K46**

Optionals:

	Value	Options/notes
FM-M2	+ 56 €	ASH GREY ES , BRONZE E2 , BULGARO RED FP , CHERRY RED EQ , DARK GREEN EL , FACEPOWDER PINK E8 , FANGO E3 , GOLDEN YELLOW EO , LIGHT BLUE E0 , LIGHT GREY ET , OCEAN BLUE E1 , OCHER YELLOW E7 , PAPAYA ORANGE EA , PASTEL YELLOW E4 , PINE GREEN EJ , RED ER , SAGE GREEN E9
FM-M4	+ 78 €	BLACK NICKEL DZ , CHAMPAGNE GOLD DG , GOLDEN BRONZE DB , MATT BLACK NICKEL DY , MATT GOLDEN BRONZE DC , PINK GOLD DR

Trip H45

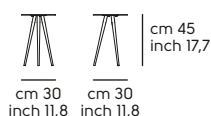

Trip H50

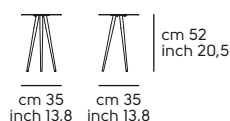

Trip H60

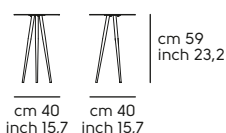

Walter design Walter Hösel

Coffee Table WALTER

Frame in: metal



Version	Code	Mod.	Frame	Top	Optional	G.ty	boxes	Kg	M ³
Walter Metallo									
Top 5 mm. thk.									
				M5					
WALTER H50 40x40_MT	T0290Q40	H50_4	M1	142 €	FM-M2 FM-M3 FM-M4	1	1	9.0	0.12
WALTER H50 60x40_MT	T0290R60	H50_6	M1	174 €	FM-M2 FM-M3 FM-M4	1	1	12.0	0.17

Walter Ceramic

Top 8 mm. thk.

				GKA	GKB	GMA					
WALTER H50 40x40_KR	T0291Q40	H50_4	M1	277 €	291 €	317 €	FM-M2 FM-M3 FM-M4	1	1	9.0	0.12
WALTER H50 60x40_KR	T0291R60	H50_6	M1	332 €	352 €	386 €	FM-M2 FM-M3 FM-M4	1	1	12.0	0.17

Frame finishes

Metal

M1	WHITE BB , BROWN E6 , SAND EC , GRAPHITE EG , BLACK EN
-----------	---

Top finishes

Metal

M5	SATIN STAINLESS STEEL HS
-----------	---------------------------------

Crystal Ceramic and Ceramic

GKA	PIOMBO K01 , CHARCOAL SAVOIA K11 , CEMENT SAVOIA K12 , EMPERADOR MARBLE BRUSH.MATT BROWN K31
GKB	RUST OXIDE K23 , WHITE CALCE K24

Crystal Ceramic and glossy Ceramic

GMA	MARBLE CALACATTA GLOSSY WHITE K32 , BLACK GREEK MARBLE K33 , MARBLE GLOSSY NOIR DESIR K35 , MARBLE CALACATTA MATT WHITE K42 , MARBLE MATT NOIR DESIR K45 , MARBLE MATT GREEN TINOS K46
------------	--

Optionals:

	Value	Options/notes
FM-M2	Indoor matt metal M2	+ 56 €
		ASH GREY ES , BRONZE E2 , BULGARO RED FP , CHERRY RED EQ , DARK GREEN EL , FACEPOWDER PINK E8 , FANGO E3 , GOLDEN YELLOW EO , LIGHT BLUE EO , LIGHT GREY ET , OCEAN BLUE E1 , OCHER YELLOW E7 , PAPAYA ORANGE EA , PASTEL YELLOW E4 , PINE GREEN EJ , RED ER , SAGE GREEN E9
FM-M3	Indoor glossy metal M3	+ 34 €
		CHROME CC
FM-M4	Indoor glossy Metal M4	+ 88 €
		BLACK NICKEL DZ , CHAMPAGNE GOLD DG , GOLDEN BRONZE DB , MATT BLACK NICKEL DY , MATT GOLDEN BRONZE DC , PINK GOLD DR

Walter H50_4

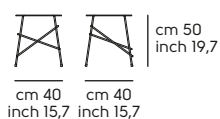

Walter H50_6

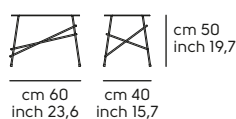



Complements

Apelle design Beatriz Sempere

Desk Apelle

Frame in: metal

Model	Code	Lampshade	Frame	Top		Optional	Q.ty	boxes	Kg	M ³
				LI1	LI2					
 Desk Apelle with lighting	T1001136	CU	M1	1.960 €	2.124 €	FM-M2 FM-M4 RV-CT	1	2	17.0	0.95

Model	Code	--	--	Upholstery		Optional	Q.ty	boxes	Kg	M ³
				CU	CT					
 Desk Pad APELLE	A1001UHO			122 €	160 €		1	1	3.0	0.01

Frame finishes

Metal

M1 WHITE **BB**, BROWN **E6**, SAND **EC**, GRAPHITE **EG**, BLACK **EN**

Mesh finishes

Hide

CU HIDE

Top finishes

Wood

LI1

Veneered wood painted GREY **I02**, Veneered wood painted GRAFITE GREY **I03**, Veneered wood painted BLACK **I04**, Veneered wood painted WHITE **I05**, Veneered wood painted BLUE **I06**, Veneered wood painted RED **I08**, Veneered wood painted CHERRY RED **I09**, Veneered wood painted DARK BROWN **I26**, Veneered wood painted NATURAL **I40**, Veneered wood painted NATURAL OAK **I52**

LI2

Veneered wood NATURAL OAK **I22**, Veneered wood FLAMED WALNUT **I24**

Desk pad finishes

Upholstery

CU HIDE

CT TUSCAN HIDE

Optionals:

	Value	Options/notes
FM-M2	Indoor matt metal M2 + 65 €	ASH GREY ES , BRONZE E2 , BULGARO RED FP , CHERRY RED EQ , DARK GREEN EL , FACEPOWDER PINK E8 , FANGO E3 , GOLDEN YELLOW EO , LIGHT BLUE EO , LIGHT GREY ET , OCEAN BLUE E1 , OCHER YELLOW E7 , PAPAYA ORANGE EA , PASTEL YELLOW E4 , PINE GREEN EJ , RED ER , SAGE GREEN E9
FM-M4	Indoor glossy Metal M4 + 180 €	BLACK NICKEL DZ
RV-CT	Tuscan hide + 219 €	TUSCAN HIDE

Desk APELLE

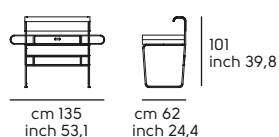

Desk Pad APELLE

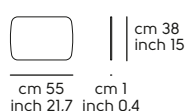

Suite design Ateliernanni

Desk Suite

Frame : wood and metal

Model	Code	Frame Insert	Legs	Top			Optional	Q.ty	boxes	Kg	M³
				GVB	GVE	GVH					
 Desk SUITE	T1754140	M1	LFI	1.407 €	1.476 €	2.010 €	FM-M2 FM-M4	1	3	54.5	0.37

Model	Code	--	--	Upholstery		Optional	Q.ty	boxes	Kg	M³
				CU	CT					
 Magazine Rack SUITE	A1750PR			212 €	301 €		1	1	5.0	0.03

Frame finishes

Metal

M1 WHITE **BB**, BROWN **E6**, SAND **EC**, GRAPHITE **EG**, BLACK **EN**

Legs finishes

Wood

LFI Ash wood painted GREY **F02**, Ash wood painted GRAFITE GREY **F03**, Ash wood painted BLACK **F04**, Ash wood painted WHITE **F05**, Ash wood painted BLUE **F06**, Ash wood painted RED **F08**, Ash wood painted CHERRY RED **F09**, Ash wood painted FLAMED WALNUT **F24**, Ash wood painted DARK BROWN **F26**, Ash wood painted NATURAL **F40**, Ash wood painted NATURAL OAK **F52**

Top finishes

Glass with Bucciato finish

GVH BUCCIATO FUME' **J50**

Glossy Glass

GVB EXTRA CLEAR TRANSPARENT **J01**

GVE GLOSSY FUME' **J05**

Magazine rack

Hide

CU HIDE

CT TUSCAN HIDE

Optionals:

		Value	Options/notes
FM-M2	Indoor matt metal M2	+ 65 €	ASH GREY ES , BRONZE E2 , BULGARO RED FP , CHERRY RED EQ , DARK GREEN EL , FACEPOWDER PINK E8 , FANGO E3 , GOLDEN YELLOW EO , LIGHT BLUE E0 , LIGHT GREY ET , OCEAN BLUE E1 , OCHER YELLOW E7 , PAPAYA ORANGE EA , PASTEL YELLOW E4 , PINE GREEN EJ , RED ER , SAGE GREEN E9
FM-M4	Indoor glossy Metal M4	+ 188 €	BLACK NICKEL DZ , CHAMPAGNE GOLD DG , GOLDEN BRONZE DB , MATT BLACK NICKEL DY , MATT GOLDEN BRONZE DC , PINK GOLD DR

Desk SUITE

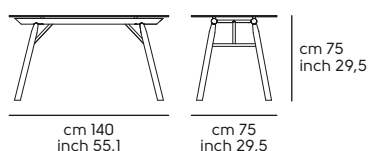

Magazine Rack SUITE

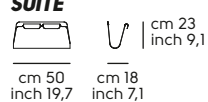

Apelle design Beatriz Sempere

Sideboard Apelle

Frame in: metal

Model	Code	Base	Doors and Drawer	Frame		Optional	Q.ty	boxes	Kg	M³
				L11	L12					
	A1001MD0	M1	CU	2.307 €	2.552 €	FM-M2 FM-M4 RV-CT	1	1	40.0	0.55

Base finishes

Metal

M1 WHITE **BB**, BROWN **E6**, SAND **EC**, GRAPHITE **EG**, BLACK **EN**

Doors-drawer finishes

Hide

CU HIDE

Frame finishes

Wood

L11 Veneered wood painted GREY **I02**, Veneered wood painted GRAFITE GREY **I03**, Veneered wood painted BLACK **I04**, Veneered wood painted WHITE **I05**, Veneered wood painted BLUE **I06**, Veneered wood painted RED **I08**, Veneered wood painted CHERRY RED **I09**, Veneered wood painted DARK BROWN **I26**, Veneered wood painted NATURAL **I40**, Veneered wood painted NATURAL OAK **I52**

L12 Veneered wood NATURAL OAK **I22**, Veneered wood FLAMED WALNUT **I24**

Optionals:

		Value	Options/notes
FM-M2	Indoor matt metal M2	+ 103 €	ASH GREY ES , BRONZE E2 , BULGARO RED FP , CHERRY RED EQ , DARK GREEN EL , FACEPOWDER PINK E8 , FANGO E3 , GOLDEN YELLOW EO , LIGHT BLUE ED , LIGHT GREY ET , OCEAN BLUE E1 , OCHER YELLOW E7 , PAPAYA ORANGE EA , PASTEL YELLOW E4 , PINE GREEN EJ , RED ER , SAGE GREEN E9
FM-M4	Indoor glossy Metal M4	+ 154 €	BLACK NICKEL DZ
RV-CT	Tuscan hide	+ 78 €	TUSCAN HIDE

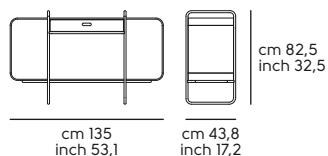

Sideboard APELLE









Lea design Paolo Vernier



Sideboard Lea

Frame in: metal

Model	Code	Base	Frame	Doors and Top									Optional	Q.ty	boxes	Kg	M ³
				LM1													
Sideboard LEA H73_LC-LC 	A1940MD1	M1	LM1	2.435 €									FM-M4	1	2	74.0	1.52
Sideboard LEA H55_LC-LC 	A1941MD1	M1	LM1	1.920 €									FM-M4	1	2	55.0	0.98
Sideboard LEA H132 LC-LC 	A1942MD1	M1	LM1	2.393 €									FM-M4	1	2	84.0	0.53

Model	Code	Base	Frame and Top	Doors										Optional	Q.ty	boxes	Kg	M ³
				TA	TB	TC	TD	TE	SF	SV	COM	COL						
Sideboard LEA H73_LC-TS 	A1940MD2	M1	LM1	2.878 €	2.909 €	2.966 €	3.045 €	3.225 €	3.036 €	3.063 €	2.878 €	2.966 €	FM-M4	1	2	76.0	1.52	
Sideboard LEA H55_LC-TS 	A1941MD2	M1	LM1	2.179 €	2.198 €	2.214 €	2.346 €	2.526 €	2.223 €	2.235 €	2.179 €	2.214 €	FM-M4	1	2	56.0	0.98	
Sideboard LEA H132 LC-TS 	A1942MD2	M1	LM1	2.856 €	2.892 €	2.952 €	2.991 €	3.101 €	3.001 €	3.108 €	2.856 €	2.952 €	FM-M4	1	2	85.0	0.53	

Model	Code	Base	Frame and Doors	Top									Optional	Q.ty	boxes	Kg	M ³
GMA																	
Sideboard LEA H73_KR-LC 	A1940MD5	M1	LM1	3.157 €									FM-M4	1	2	88.0	1.52
Sideboard LEA H55_KR-LC 	A1941MD5	M1	LM1	2.552 €									FM-M4	1	2	65.0	0.98
Sideboard LEA H132_KR-LC 	A1942MD5	M1	LM1	2.894 €									FM-M4	1	2	94.0	0.53

Model	Code	Base	Frame and Top	Doors									Optional	Q.ty	boxes	Kg	M ³
				TA	TB	TC	TD	TE	SF	SV	COM	COL					
Sideboard LEA H73_KR-TS 	A1940MD6	M1	LM1 - GMA	3.599 €	3.631 €	3.688 €	3.767 €	3.947 €	3.757 €	3.785 €	3.599 €	3.688 €	FM-M4	1	2	90.0	1.52
Sideboard LEA H55_KR-TS 	A1941MD6	M1	LM1 - GMA	2.809 €	2.828 €	2.846 €	2.977 €	3.156 €	2.853 €	2.867 €	2.809 €	2.846 €	FM-M4	1	2	66.0	0.98
Sideboard LEA H132_KR-TS 	A1942MD6	M1	LM1 - GMA	3.357 €	3.394 €	3.453 €	3.492 €	3.602 €	3.503 €	3.610 €	3.357 €	3.453 €	FM-M4	1	2	95.0	0.53

Note:

Sideboard LEA H.73 - Internal shelves in transparent Glass

Base finishes

Metal	
MI	WHITE BB , BROWN E6 , SAND EC , GRAPHITE EG , BLACK EN

Frame and doors finishes

Wood	
LMI	Mdf GRAPHITE G02 , Mdf BLACK G04 , Mdf WHITE G05 , Mdf SAND G07

Top finishes

Crystal Ceramic and glossy Ceramic

GMA	MARBLE CALACATTA GLOSSY WHITE K32 , BLACK GREEK MARBLE K33 , MARBLE GLOSSY NOIR DESIR K35 , MARBLE CALACATTA MATT WHITE K42 , MARBLE MATT NOIR DESIR K45 , MARBLE MATT GREEN TINOS K46
------------	--

Door finishes

Upholstery

TA	FAUX LEATHER Secret , FABRIC Mirage , FABRIC Cotton Club	TB	FAUX LEATHER Vintage , FABRIC Fenix Wool , FABRIC Novabuk , FABRIC Manhattan , FABRIC Visual
TC	VELVET SUPERB, FABRIC Second , FABRIC Main Line Flax , FABRIC Oceanic	TD	FABRIC Yoredale , FABRIC Remix 3
TE	FABRIC Uniform Melange	SF	LEATHER Fiore
SV	LEATHER Vintage		

Optionals:

		Value	Options/notes
FM-M4	Indoor glossy Metal M4	+ 232 €	BLACK NICKEL DZ

Sideboard LEA H73

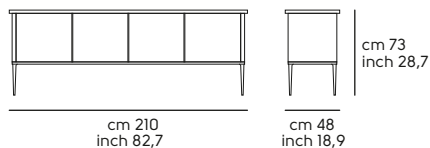

Sideboard LEA H55

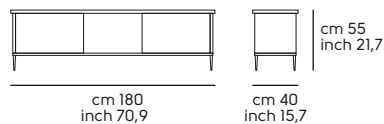



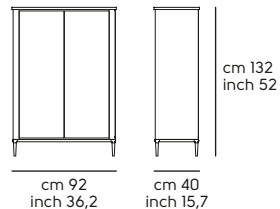

Sideboard LEA H132



Apelle design Beatriz Sempere

Bookcase Apelle

Frame in: metal

Model	Code	--	Frame	Shelves		Optional	G.ty	boxes	Kg	M³
				L11	L12					
	A1001M41		M1	1.028 €	1.234 €	FM-M2 FM-M4	1	2	6.0	0.3
	A1001M42		M1	1.969 €	2.384 €	FM-M2 FM-M4	1	3	9.0	0.46
	A1001M43		M1	2.902 €	3.524 €	FM-M2 FM-M4	1	4	12.0	0.7
	A1001M44		M1	3.815 €	4.643 €	FM-M2 FM-M4	1	5	15.0	0.95

Frame finishes

Metal

M1	WHITE BB , BROWN E6 , SAND EC , GRAPHITE EG , BLACK EN
-----------	---

Shell finishes

Wood

L11	Veneered wood painted GREY I02 , Veneered wood painted GRAFITE GREY I03 , Veneered wood painted BLACK I04 , Veneered wood painted WHITE I05 , Veneered wood painted BLUE I06 , Veneered wood painted RED I08 , Veneered wood painted CHERRY RED I09 , Veneered wood painted DARK BROWN I26 , Veneered wood painted NATURAL I40 , Veneered wood painted NATURAL OAK I52
L12	Veneered wood NATURAL OAK I22 , Veneered wood FLAMED WALNUT I24

Optionals:

		Valore	Opzioni/Note
FM-M2	Indoor matt metal M2	+ 103 €	ASH GREY ES , BRONZE E2 , BULGARO RED FP , CHERRY RED EQ , DARK GREEN EL , FACEPOWDER PINK E8 , FANGO E3 , GOLDEN YELLOW EO , LIGHT BLUE EO , LIGHT GREY ET , OCEAN BLUE E1 , OCHER YELLOW E7 , PAPAYA ORANGE EA , PASTEL YELLOW E4 , PINE GREEN EJ , RED ER , SAGE GREEN E9
FM-M4	Indoor glossy Metal M4	+ 154 €	BLACK NICKEL DZ

Model	Code	--	--	Upholstery		Optional	Q.ty	boxes	Kg	M³
				CU	CT					
Bookcase drawer APELLE 40 	A1001BC4			154 €	219 €		1	1	3.0	0.04

drawer finishes

Upholstery

CU HIDE	CT TUSCAN HIDE
----------------	-----------------------

Bookcase APELLE 1 P.40

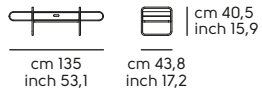

Bookcase APELLE 2 P.40

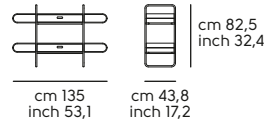

Bookcase APELLE 3 P.40

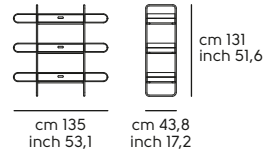

Bookcase APELLE 4 P.40

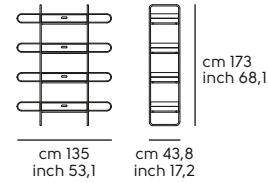

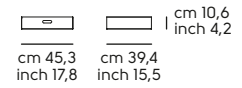

Drawer APELLE 40





Sienna design Balutto Associati

Bookcase Sienna

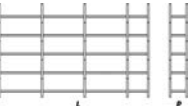
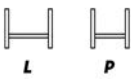
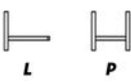
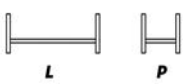
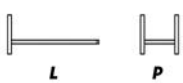
Frame in: wood

Model	Code	Type	Frame	Shelves	Optional	Q.ty	boxes	Kg	M ³
					M1				
Composition "A"_MT 	A2030M0A	A	LF1	970 €		1	4	14.0	0.04
Composition "B"_MT 	A2030M0B	B	LF1	1.191 €		1	4	20.5	0.04
Composition "C"_MT 	A2030M0C	C	LF1	5.005 €		1	20	88.0	0.2
					M1				
End Module 40_MT 	A2030E40M0	TC_40	LF1	242 €		1	1	3.5	0.01
Internal Module 40_MT 	A2030I40M0	IN_40	LF1	200 €		1	1	3.1	0.01
End Module 80_MT 	A2030E80M0	TC_80	LF1	298 €		1	1	5.1	0.01
Internal Module 80_MT 	A2030I80M0	IN_80	LF1	255 €		1	1	4.7	0.01

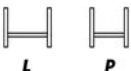
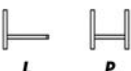
COMPLEMENTS

				GVA	GVE					
End Module 40_VT		A2030E40V0	TC_40	LFI	246 €	258 €	1	1	3.6	0.01
Internal Module 40_VT		A2030I40V0	IN_40	LFI	202 €	215 €	1	1	3.2	0.01
End Module 80_VT		A2030E80V0	TC_80	LFI	293 €	299 €	1	1	5.2	0.01
Internal Module 80_VT		A2030I80V0	IN_80	LFI	251 €	256 €	1	1	4.8	0.01

Frame finishes

Wood

LFI

Ash wood painted GREY **F02**, Ash wood painted GRAFITE GREY **F03**, Ash wood painted BLACK **F04**, Ash wood painted WHITE **F05**, Ash wood painted BLUE **F06**, Ash wood painted RED **F08**, Ash wood painted CHERRY RED **F09**, Ash wood painted FLAMED WALNUT **F24**, Ash wood painted DARK BROWN **F26**, Ash wood painted NATURAL **F40**, Ash wood painted NATURAL OAK **F52**

Shell finishes

Metal

MI

WHITE **BB**, BROWN **E6**, SAND **EC**, GRAPHITE **EG**, BLACK **EN**

Shell finishes

Glossy Glass

GVA

TRANSPARENT **J02**

GVE

GLOSSY FUME' **J05**

Module TC_40

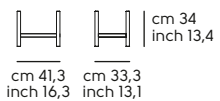

Module IN_40

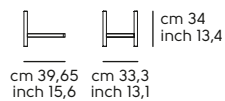

Module TC_80

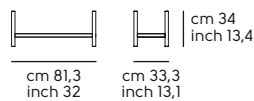

Module IN_80

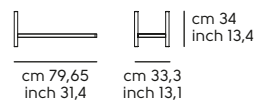

Composition "A"

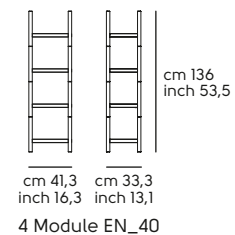

Composition "B"

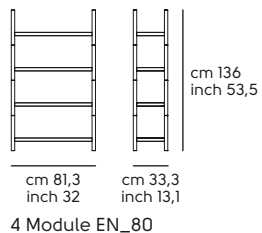

4 Module EN_80

Composition "C"

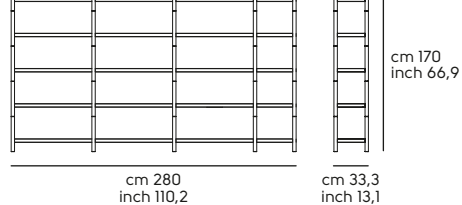

5 Module EN_80
10 Module IN_80
5 Module IN_40

Suite design Ateliernanni

Bookcase Suite

Frame in: wood and metal

Model	Code	Support	Frame	Shelves		Optional	Q.ty	boxes	Kg	M³
				M1	M2					
Bookcase SUITE										
	A1750L0	M1	LF1	1.777 €	1.947 €	FM-M2	1	1	70.0	1.1

Finishes support

Metal

M1 WHITE **BB**, BROWN **E6**, SAND **EC**, GRAPHITE **EG**, BLACK **EN**

Frame finishes

Wood

LF1 Ash wood painted GREY **F02**, Ash wood painted GRAFITE GREY **F03**, Ash wood painted BLACK **F04**, Ash wood painted WHITE **F05**, Ash wood painted BLUE **F06**, Ash wood painted RED **F08**, Ash wood painted CHERRY RED **F09**, Ash wood painted FLAMED WALNUT **F24**, Ash wood painted DARK BROWN **F26**, Ash wood painted NATURAL **F40**, Ash wood painted NATURAL OAK **F52**

Shell finishes

Metal

M1 WHITE **BB**, BROWN **E6**, SAND **EC**, GRAPHITE **EG**, BLACK **EN**

M2

LIGHT BLUE **E0**, OCEAN BLUE **E1**, BRONZE **E2**, FANGO **E3**, PASTEL YELLOW **E4**, OCHER YELLOW **E7**, FACEPOWDER PINK **E8**, SAGE GREEN **E9**, PAPAYA ORANGE **EA**, PINE GREEN **EJ**, DARK GREEN **EL**, GOLDEN YELLOW **EO**, CHERRY RED **EQ**, RED **ER**, ASH GREY **ES**, LIGHT GREY **ET**, BULGARO RED **FP**

Optionals:

	Value	Options/notes
FM-M2	+ 103 €	ASH GREY ES , BRONZE E2 , BULGARO RED FP , CHERRY RED EQ , DARK GREEN EL , FACEPOWDER PINK E8 , FANGO E3 , GOLDEN YELLOW EO , LIGHT BLUE E0 , LIGHT GREY ET , OCEAN BLUE E1 , OCHER YELLOW E7 , PAPAYA ORANGE EA , PASTEL YELLOW E4 , PINE GREEN EJ , RED ER , SAGE GREEN E9

Bookcase SUITE



cm 120
inch 47,2



cm 38,6
inch 15,2

cm 200
inch 78,7

Apelle design Beatriz Sempere

Coat Hanger Apelle

Frame in: metal

Model	Code	--	Frame	Upholstery		Optional	Q.ty	boxes	Kg	M ³
				CK	CT					
 Coat Hanger APELLE TREE	A1000A0		M1	280 €	301 €	FM-M2 FM-M4	1	2	9.0	0.06

Note:

Hide upholstered base only for FM-M4 finish

Frame finishes

Metal

MI WHITE **BB**, BROWN **E6**, SAND **EC**, GRAPHITE **EG**, BLACK **EN**

Upholstery finishes

Hide

CK HIDE_TK

CT TUSCAN HIDE

Optionals:

		Value	Options/notes
FM-M2	Indoor matt metal M2	+ 78 €	ASH GREY ES , BRONZE E2 , BULGARO RED FP , CHERRY RED EQ , DARK GREEN EL , FACEPOWDER PINK E8 , FANGO E3 , GOLDEN YELLOW EO , LIGHT BLUE E0 , LIGHT GREY ET , OCEAN BLUE E1 , OCHER YELLOW E7 , PAPAYA ORANGE EA , PASTEL YELLOW E4 , PINE GREEN EJ , RED ER , SAGE GREEN E9
FM-M4	Indoor glossy Metal M4	+ 129 €	BLACK NICKEL DZ , CHAMPAGNE GOLD DG , GOLDEN BRONZE DB , MATT BLACK NICKEL DY , MATT GOLDEN BRONZE DC , PINK GOLD DR

APELLE TREE

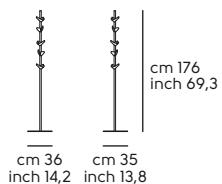

Guapa design Franco Poli

Coat Hanger Guapa

Frame in: metal

Model	Code	--	Frame	Upholstery		Optional	Q.ty	boxes	Kg	M ³
				CK	CT					
 Coat Hanger GUAPA	A1150A0		M1	384 €	463 €	FM-M2 FM-M4	1	1	7.9	0.25

Frame finishes

Metal

M1	WHITE BB , BROWN E6 , SAND EC , GRAPHITE EG , BLACK EN
-----------	---

Upholstery finishes

Hide

CK	HIDE_TK
CT	TUSCAN HIDE

Optionals:

		Value	Options/notes
FM-M2	Indoor matt metal M2	+ 78 €	ASH GREY ES , BRONZE E2 , BRONZE EZ + TRANSP., CHERRY RED EQ , DARK GREEN EL , FACEPOWDER PINK E8 , FANGO E3 , GOLDEN YELLOW EO , LIGHT BLUE EO , LIGHT GREY ET , OCEAN BLUE E1 , OCHER YELLOW E7 , PAPAYA ORANGE EA , PASTEL YELLOW E4 , PINE GREEN EJ , RED ER , SAGE GREEN E9
FM-M4	Indoor glossy Metal M4	+ 129 €	BLACK NICKEL DZ , CHAMPAGNE GOLD DG , GOLDEN BRONZE DB , MATT BLACK NICKEL DY , MATT GOLDEN BRONZE DC , PINK GOLD DR

GUAPA

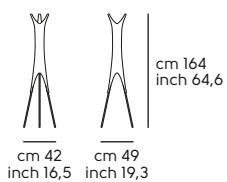

Pippi design Roberto Paoli

Coat Hanger Pippi - Completely upholstered in fabric

Frame in: upholstered metal

Model	Code	--	feet	Upholstery		Optional	Q.ty	boxes	Kg	M ³
				TB	TE					
 Coat Hanger PIPPI	A1950A0		M1	384 €	428 €	FM-M2 FM-M4	1	1	7.0	0.33

Feet finishes

Metal

MI WHITE **BB**, BROWN **E6**, SAND **EC**, GRAPHITE **EG**, BLACK **EN**

Upholstery finishes

Fabric and faux leather

TB FABRIC **Visual**, FABRIC **Fenix Wool**

Upholstery finishes

Fabric and faux leather

TE FABRIC **Uniform Melange**

Optionals:

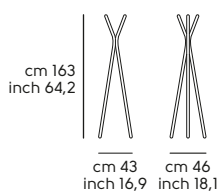

		Value	Options/notes
FM-M2	Indoor matt metal M2	+ 25 €	ASH GREY ES , BRONZE E2 , BULGARO RED FP , CHERRY RED EQ , DARK GREEN EL , FACEPOWDER PINK E8 , FANGO E3 , GOLDEN YELLOW EO , LIGHT BLUE E0 , LIGHT GREY ET , OCEAN BLUE E1 , OCHER YELLOW E7 , PAPAYA ORANGE EA , PASTEL YELLOW E4 , PINE GREEN EJ , RED ER , SAGE GREEN E9
FM-M4	Indoor glossy Metal M4	+ 65 €	BLACK NICKEL DZ , CHAMPAGNE GOLD DG , GOLDEN BRONZE DB , MATT BLACK NICKEL DY , MATT GOLDEN BRONZE DC , PINK GOLD DR

PIPPI





Bold design Andrea Lucatello

Mirror Bold

Model	Code	Type	Mirror Frame Bronz										Optional	Q.ty	boxes	Kg	M ³
			ZC														
Mirror BOLD H120																	
	A2250S0	H120	1.089 €											1	1	33.5	0.15
Mirror BOLD H200																	
	A2250S1	H200	1.274 €											1	1	44.0	0.18

Mirror Bold Upholstery

Model	Code	Type	Mirror Frame Upholstered										Optional	Q.ty	boxes	Kg	M ³
			TA	TB	TC	TD	TE	SF	SV	COM	COL						
Mirror BOLD H120																	
	A2250T0	H120	1.235 €	1.276 €	1.343 €	1.388 €	1.513 €	1.092 €	985 €	1.235 €	1.343 €			1	1	34.5	0.15
Mirror BOLD H200																	
	A2250T1	H200	1.411 €	1.464 €	1.551 €	1.610 €	1.770 €	1.561 €	1.689 €	1.411 €	1.551 €			1	1	45.0	0.18

Finishes Mirror

Upholstery

TA	FAUX LEATHER Secret , FABRIC Mirage , FABRIC Cotton Club	TB	FAUX LEATHER Vintage , FABRIC Fenix Wool , FABRIC Novabuk , FABRIC Manhattan , FABRIC Visual
TC	VELVET SUPERB, FABRIC Second , FABRIC Main Line Flax , FABRIC Oceanic	TD	FABRIC Yoredale , FABRIC Remix 3
TE	FABRIC Uniform Melange	SF	LEATHER Fiore
SV	LEATHER Vintage		

BOLD H120

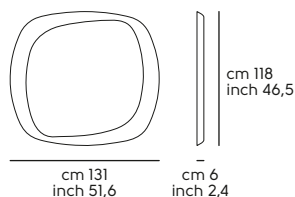

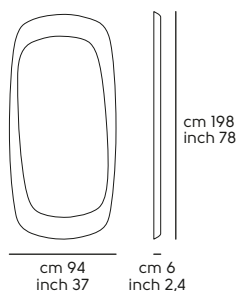

BOLD H200



Peek design Studio Pastina

Mirror Peek

Model	Code	Type	Mirror with smoked insert	Optional	Q.ty	boxes	Kg	M ³
			ZC					
Mirror PEEK S 	A1990SP	S	504 €		1	1	10.0	0.035
Mirror PEEK M 	A1990SM	M	592 €		1	1	18.0	0.06
Mirror PEEK L 	A1990SG	L	831 €		1	1	35.0	0.12

PEEK S

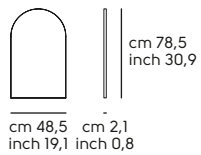

PEEK M

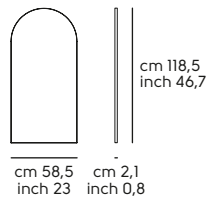

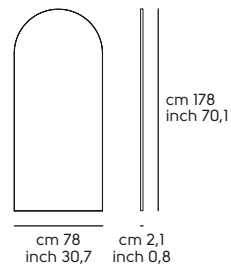

PEEK L



Spot design Nicola Bonriposi

Mirror Spot

Model	Code	Type	Mirror	Optional	G.ty	boxes	Kg	M ³
				ZC				
Mirror SPOT S								
	A2080SS	S	604 €		1	1	15.0	0.05
Mirror SPOT M								
	A2080SM	M	889 €		1	1	28.0	0.09
Mirror SPOT L								
	A2080SL	L	948 €		1	1	30.0	0.1

SPOT S

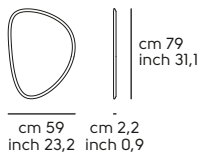

SPOT M

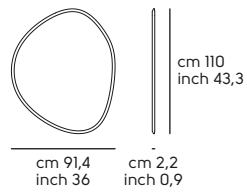

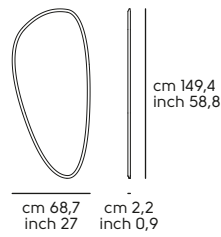

SPOT L



Bolle design Paola Navone

Lamp Bolle

Frame in: metal - Base in concrete

Model	Code	Type	--	Frame		Optional	Q.ty	boxes	Kg	M³
				M1	M2					
Suspension BOLLE S 	A2200L1	S		689 €	806 €		1	1	7.0	0.09
Suspension BOLLE L 	A2200L2	L		956 €	1.082 €		1	1	11.5	0.39
Floor lamp BOLLE 	A2200LT	F		910 €	1.028 €		1	1	27.0	0.36

Note:

Bulb INCLUDED - Cable in Black Fabric - Base in concrete

Frame finishes

Metal

M1	M2
WHITE BB , BROWN E6 , SAND EC , GRAPHITE EG , BLACK EN	LIGHT BLUE E0 , OCEAN BLUE E1 , BRONZE E2 , FANGO E3 , PASTEL YELLOW E4 , OCHER YELLOW E7 , FACEPOWDER PINK E8 , SAGE GREEN E9 , PAPAYA ORANGE EA , PINE GREEN EJ , DARK GREEN EL , GOLDEN YELLOW EO , CHERRY RED EQ , RED ER , ASH GREY ES , LIGHT GREY ET , BULGARO RED FP

BOLLE S

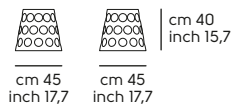

BOLLE L

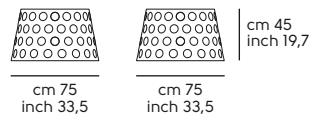



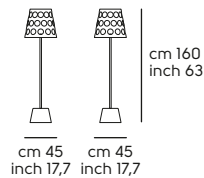

BOLLE F



Charlotte design Tomas Dalla Torre

Lamp Charlotte

Frame in: metal

Model	Code	Type	--	Frame	Optional	G.ty	boxes	Kg	M ³
					M1				
Table lamp CHARLOTTE 	A3030A1	T		334 €		1	1	2.0	0.02
Floor lamp CHARLOTTE 	A3030T1	F		632 €		1	1	9.0	0.215
Sospensione CHARLOTTE 	A3030L1	S		374 €		1	1	1.5	0.01
Chandelier CHARLOTTE 	A3030L6	C		1.133 €		1	1	8.0	0.32

Note:

Bulb not included - E27 socket

Frame finishes

Metal

M1	BLACK EN
-----------	----------

CHARLOTTE T

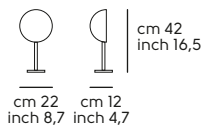

CHARLOTTE F

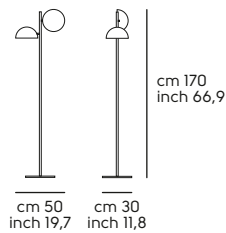

CHARLOTTE S

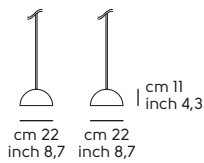

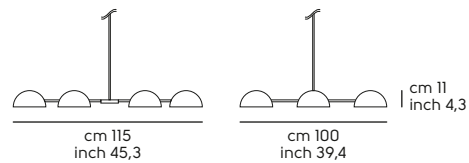

CHARLOTTE C



Ghost design Studio F+B

Lamp Ghost

Frame in: metal

Model	Code	Type	--	Frame	Optional	Q.ty	boxes	Kg	M ³
				M1					
Table lamp GHOST									
	A3020A1	T		374 €		1	1	2.0	0.03
Floor lamp GHOST									
	A3020T1	F		696 €		1	1	5.8	0.25
Sospensione GHOST									
	A3020L1	S		463 €		1	1	2.0	0.03

Note:

Bulb not included - PTL GU 10 socket

Frame finishes

Metal

MI BLACK EN

GHOST T

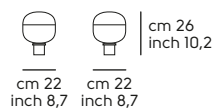

GHOST F

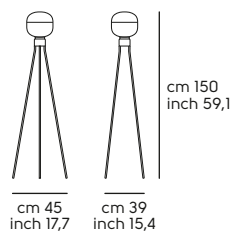

GHOST S

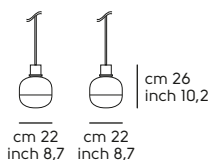

Guapa design Franco Poli

Lamp Guapa

Frame in: metal

Model	Code	--	Frame	Upholstery		Optional	G.ty	boxes	Kg	M ³
				CK	CT					
 Floor lamp GUAPA	A1150L1		M1	877 €	1.056 €	FM-M2	1	2	14.0	0.47

Frame finishes

Metal

M1 WHITE **BB**, BROWN **E6**, SAND **EC**, GRAPHITE **EG**, BLACK **EN**

Upholstery finishes

Hide

CK HIDE_TK

CT TUSCAN HIDE

Optionals:

		Value	Options/notes
FM-M2	Indoor matt metal M2	+ 65 €	ASH GREY ES , BRONZE E2 , BULGARO RED FP , CHERRY RED EQ , DARK GREEN EL , FACEPOWDER PINK E8 , FANGO E3 , GOLDEN YELLOW EO , LIGHT BLUE EO , LIGHT GREY ET , OCEAN BLUE E1 , OCHER YELLOW E7 , PAPAYA ORANGE EA , PASTEL YELLOW E4 , PINE GREEN EJ , RED ER , SAGE GREEN E9



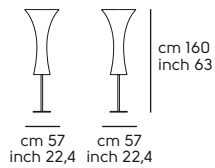



GUAPA F



Japan design Opaca Lab+Tosca Design

Lamp Japan

Frame in: metal

Model	Code	Type	--	Frame	Optional	Q.ty	boxes	Kg	M ³
				M1					
Floor lamp JAPAN 	A3000T1	F		761 €		1	1	18.0	0.26
Sospensione JAPAN S 	A3000L1	S		381 €	RS-M1	1	1	1.5	0.023
Sospensione JAPAN M 	A3000L2	M		406 €	RS-M1	1	1	1.6	0.033
Sospensione JAPAN L 	A3000L3	L		439 €	RS-M1	1	1	2.5	0.06
Suspension rose JAPAN 	A3000R0	R		45 €		1	1	0.3	0.002
Suspension multiple rose JAPAN (6) 	A3000R0	RM		45 €	RS-M2	1	1	0.8	0.005

Note:

Bulb not included - PTL GU 10 socket

Frame finishes

Metal

MI WHITE BB, BLACK EN

Optionals:

		Value	Options/notes
RS-M1	Single lamp rose	+ 45 €	RS-M1
RS-M2	Multiple lamp rose	+ 5 €	RS-M2

JAPAN F

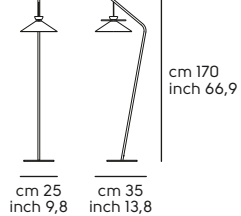

JAPAN S

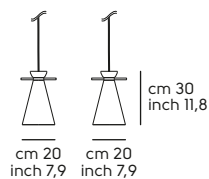

JAPAN M

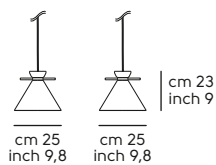

JAPAN L

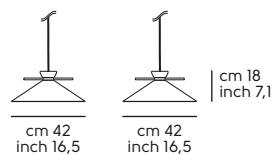

JAPAN R

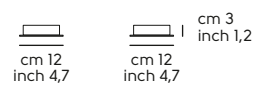

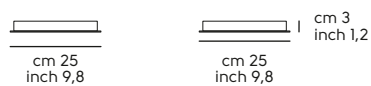

JAPAN RM



Suspense design Studio F+B

Lamp Suspense

Frame in: metal

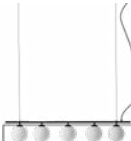
Model	Code	Type	--	Frame	Optional	Q.ty	boxes	Kg	M ³
				M1					
Table lamp SUSPENSE									
	A3010A1	T		342 €		1	1	2.9	0.024
Floor lamp SUSPENSE									
	A3010T1	F		890 €		1	1	16.5	0.215
Chandelier SUSPENSE									
	A3010L5	C		1.195 €		1	1	11.25	0.114

Note:

Bulb not included - Type G9 Led socket

Frame finishes

Metal

MI BLACK EN

SUSPENSE T

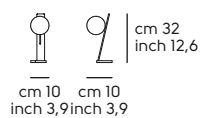

SUSPENSE F

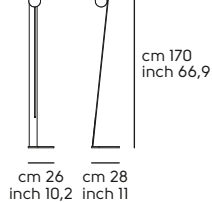

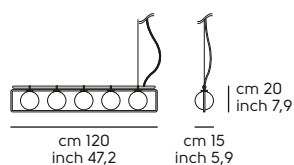

SUSPENSE C



Sunrise design Franco Poli

Separè Sunrise

Frame in: metal

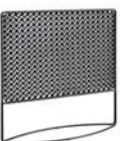
Model	Code	--	Frame	Mesh		Optional	G.ty	boxes	Kg	M ²
				CK	CT					
Separè SUNRISE H.190 	A2100SP01		M1	696 €	852 €	FM-M2 FM-M4	1	1	14.0	0.65
Separè SUNRISE H.170 	A2100SP02		M1	728 €	897 €	FM-M2 FM-M4	1	1	14.5	0.68
Separè SUNRISE H.128 	A2100SP03		M1	757 €	928 €	FM-M2 FM-M4	1	1	15.0	0.82

Frame finishes

Metal

M1 WHITE **BB**, BROWN **E6**, SAND **EC**, GRAPHITE **EG**, BLACK **EN**

Mesh finishes

Hide

CK HIDE_TK

CT TUSCAN HIDE

Optionals:

		Value	Options/notes
FM-M2	Indoor matt metal M2	+ 103 €	ASH GREY ES , BRONZE E2 , BULGARO RED FP , CHERRY RED EQ , DARK GREEN EL , FACEPOWDER PINK E8 , FANGO E3 , GOLDEN YELLOW EO , LIGHT BLUE EO , LIGHT GREY ET , OCEAN BLUE E1 , OCHER YELLOW E7 , PAPAYA ORANGE EA , PASTEL YELLOW E4 , PINE GREEN EJ , RED ER , SAGE GREEN E9
FM-M4	Indoor glossy Metal M4	+ 154 €	BLACK NICKEL DZ , CHAMPAGNE GOLD DG , GOLDEN BRONZE DB , MATT BLACK NICKEL DY , MATT GOLDEN BRONZE DC , PINK GOLD DR

SUNRISE H.190

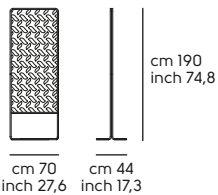

SUNRISE H.170

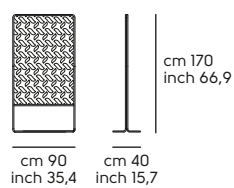

SUNRISE H.128

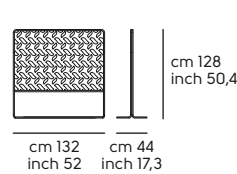







Bases

Break design Midj R&D

Frame Break

Frame in: metal. Top NOT included

Version	Code	H	--	Frame				Optional	 G.ty	 boxes	 Kg	 M³
Break H. 73												
BREAK /3 H 73 Top Max Ø 70 	T1040BT3	H. 73		M1	M2	O1	O2					
				126 €	205 €	164 €	238 €	1	2	6.0	0.2	
BREAK /4 H 73 Top Max 70x70 - Ø 80 	T1040BT4	H. 73		M1	M2	O1	O2					
				137 €	215 €	175 €	250 €	1	2	6.5	0.2	

Frame finishes

Metal

M1	WHITE BB , BROWN E6 , SAND EC , GRAPHITE EG , BLACK EN
M2	LIGHT BLUE E0 , OCEAN BLUE E1 , BRONZE E2 , FANGO E3 , PASTEL YELLOW E4 , OCHER YELLOW E7 , FACEPOWDER PINK E8 , SAGE GREEN E9 , PAPAYA ORANGE EA , PINE GREEN EJ , DARK GREEN EL , GOLDEN YELLOW EO , CHERRY RED EQ , RED ER , ASH GREY ES , LIGHT GREY ET , BULGARO RED FP

Outdoor Metal

O1	Outdoor BROWN E6 , Outdoor WHITE BB , Outdoor SAND EC , Outdoor GRAFITE EG , Outdoor BLACK EN
O2	Outdoor LIGHT BLUE E0 , Outdoor OCEAN BLUE E1 , Outdoor BRONZE E2 , Outdoor FANGO E3 , Outdoor PASTEL YELLOW E4 , Outdoor OCHER YELLOW E7 , Outdoor FACEPOWDER PINK E8 , Outdoor SAGE GREEN E9 , Outdoor PINE GREEN EJ , Outdoor DARK GREEN EL , Outdoor GOLD YELLOW EO , Outdoor RED BULGARO FP , Outdoor CHERRY RED EQ , Outdoor RED ER , Outdoor ASH GREY ES , Outdoor LIGHT GREY ET , Outdoor PAPAYA ORANGE EA

Break /3 H 73

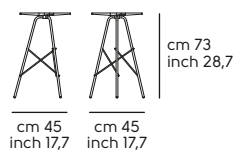

Break /4 H 73

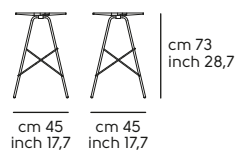

Clessidra design Paolo Vernier

Frame Clessidra

Frame in: metal. Top NOT included

Version	Code	H	--	Frame	Optional	Q.ty	boxes	Kg	M ³
Clessidra M42									
				M1					
				M2					
CLESSIDRA M42 H73 Top Ø70-Ø80-Ø90	T1960M420	H. 73		541 €		1	1	23.5	0.08



Note:

--

Frame finishes

Metal

M1	WHITE BB , BROWN E6 , SAND EC , GRAPHITE EG , BLACK EN
M2	LIGHT BLUE E0 , OCEAN BLUE E1 , BRONZE E2 , FANGO E3 , PASTEL YELLOW E4 , OCHER YELLOW E7 , FACEPOWDER PINK E8 , SAGE GREEN E9 , PAPAYA ORANGE EA , PINE GREEN EJ , DARK GREEN EL , GOLDEN YELLOW EO , CHERRY RED EQ , RED ER , ASH GREY ES , LIGHT GREY ET , BULGARO RED FP

Insert finishes

Metal

M1	WHITE BB , BROWN E6 , SAND EC , GRAPHITE EG , BLACK EN
M2	LIGHT BLUE E0 , OCEAN BLUE E1 , BRONZE E2 , FANGO E3 , PASTEL YELLOW E4 , OCHER YELLOW E7 , FACEPOWDER PINK E8 , SAGE GREEN E9 , PAPAYA ORANGE EA , PINE GREEN EJ , DARK GREEN EL , GOLDEN YELLOW EO , CHERRY RED EQ , RED ER , ASH GREY ES , LIGHT GREY ET , BULGARO RED FP
M4	GOLDEN BRONZE DB , MATT GOLDEN BRONZE DC , CHAMPAGNE GOLD DG , PINK GOLD DR , MATT BLACK NICKEL DY , BLACK NICKEL DZ

CLESSIDRA M42 H73

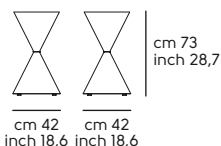

Composit design Midj R&D

Frame Composit

Frame in: metal. Top NOT included

Version	Code	H	Base	Column	Optional				
---------	------	---	------	--------	----------	---	---	---	---

Composit H. 73

Version for Wood and HPL Top

				M1	M3					
 COMPOSIT/1 Base 45x45 - Col. 8x8 Top Max 80x80 - Ø 90	T1061Q45	H. 73	M1	254 €	276 €	FM-M5	1	3	24.5	0.05

Optionals:

		Value	Options/notes
FM-M5	Stainless steel M5	+ 20 €	POLISHED STAINLESS STEEL HL

 COMPOSIT/1 Base 55x55 - Col. 8x8 Top Max 90x90 - Ø 100	T1061Q55	H. 73	M1	308 €	329 €	FM-M5	1	3	30.0	0.06
---	----------	-------	----	-------	-------	-------	---	---	------	------

Optionals:

		Value	Options/notes
FM-M5	Stainless steel M5	+ 20 €	POLISHED STAINLESS STEEL HL

 COMPOSIT/2 Base 45x45 - Col. Ø 8 Top Max 80x80 - Ø 90	T1062Q45	H. 73	M1	247 €	264 €	FM-M5	1	3	24.5	0.05
--	----------	-------	----	-------	-------	-------	---	---	------	------

Optionals:

		Value	Options/notes
FM-M5	Stainless steel M5	+ 20 €	POLISHED STAINLESS STEEL HL

 COMPOSIT/2 Base 55x55 - Col. Ø 8 Top Max 90x90 - Ø 100	T1062Q55	H. 73	M1	276 €	303 €	FM-M5	1	3	30.0	0.06
---	----------	-------	----	-------	-------	-------	---	---	------	------

Optionals:

		Value	Options/notes
FM-M5	Stainless steel M5	+ 20 €	POLISHED STAINLESS STEEL HL

COMPOSIT/3 Base Ø 45 - Col. Ø 8
Top Max 70x70 - Ø 80



T1063D45	H. 73	M1	236 €	254 €	FM-M5	1	3	24.5	0.05
----------	-------	----	-------	-------	-------	---	---	------	------

Optionals:

		Value	Options/notes
FM-M5	Stainless steel M5	+ 20 €	POLISHED STAINLESS STEEL HL

COMPOSIT/3 Base Ø 55 - Col. Ø 8
Top Max 70x70 - Ø 90



T1063D55	H. 73	M1	274 €	294 €	FM-M5	1	3	30.0	0.06
----------	-------	----	-------	-------	-------	---	---	------	------

Optionals:

		Value	Options/notes
FM-M5	Stainless steel M5	+ 20 €	POLISHED STAINLESS STEEL HL

Version	Code	Base	Column	Optional	Q.ty	boxes	Kg	M³
---------	------	------	--------	----------	------	-------	----	----

Composit H. 73

Version for Glass top

			M1	M3						
COMPOSIT/1 Base 45x45 - Col. Øx8 *Vtr Top Max 80x80 - Ø 90	T1066Q45	H. 73	M1	248 €	269 €	FM-M5	1	2	23.5	0.05

Optionals:

		Value	Options/notes
FM-M5	Stainless steel M5	+ 20 €	POLISHED STAINLESS STEEL HL

COMPOSIT/1 Base 55x55 - Col. Øx8 *Vtr
Top Max 90x90 - Ø 100



T1066Q55	H. 73	M1	300 €	323 €	FM-M5	1	2	29.0	0.06
----------	-------	----	-------	-------	-------	---	---	------	------

Optionals:

		Value	Options/notes
FM-M5	Stainless steel M5	+ 20 €	POLISHED STAINLESS STEEL HL

COMPOSIT/2 Base 45x45 - Col. Ø 8 *Vtr
Top Max 80x80 - Ø 90



T1067Q45	H. 73	M1	239 €	255 €	FM-M5	1	2	23.5	0.05
----------	-------	----	-------	-------	-------	---	---	------	------

Optionals:

		Value	Options/notes
FM-M5	Stainless steel M5	+ 20 €	POLISHED STAINLESS STEEL HL

COMPOSIT/2 Base 55x55 - Col. Ø 8 *Vtr
Top Max 90x90 - Ø 100



T1067Q55	H. 73	M1	256 €	296 €	FM-M5	1	2	29.0	0.06
----------	-------	----	-------	-------	-------	---	---	------	------

Optionals:

		Value	Options/notes
FM-M5	Stainless steel M5	+ 20 €	POLISHED STAINLESS STEEL HL

COMPOSIT/3 Base Ø 45 - Col. Ø 8 *Vtr
Top Max 70x70 - Ø 80



T1068D45	H. 73	M1	228 €	248 €	FM-M5	1	2	23.5	0.05
----------	-------	----	-------	-------	-------	---	---	------	------

Optionals:

		Value	Options/notes
FM-M5	Stainless steel M5	+ 20 €	POLISHED STAINLESS STEEL HL

COMPOSIT/3 Base Ø 55 - Col. Ø 8 *Vtr
Top Max 70x70 - Ø 90



T1068D55	H. 73	M1	255 €	289 €	FM-M5	1	2	29.0	0.06
----------	-------	----	-------	-------	-------	---	---	------	------

Optionals:

		Value	Options/notes
FM-M5	Stainless steel M5	+ 20 €	POLISHED STAINLESS STEEL HL

Base finishes

Metal

M1	WHITE BB, BLACK EN
-----------	--------------------

Column finishes

Metal

M1	WHITE BB, BLACK EN
M3	CHROME CC

COMPOSIT/1 H. 73
Base 45x45 - Col. 8x8

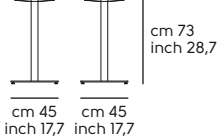

COMPOSIT/1 H. 73 Base
55x55 - Col. 8x8

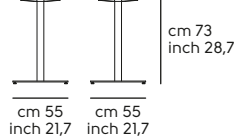

COMPOSIT/2 H. 73
Base 45x45 - Col. Ø 8

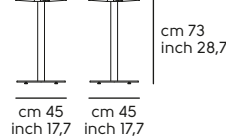

COMPOSIT/2 H. 73
Base 55x55 - Col. Ø 8

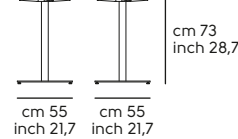

COMPOSIT/3 H. 73
Base Ø 45 - Col. Ø 8

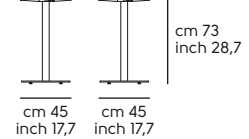

COMPOSIT/3 H. 73 Base
Ø 55 - Col. Ø 8

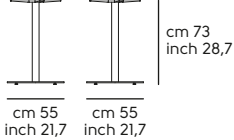

Version	Code	H	Base	Column	Optional	Q.ty	boxes	Kg	M ³
---------	------	---	------	--------	----------	------	-------	----	----------------

Composit H.107

Version for Wood and HPL Top

				M1	M3				
 <p>COMPOSIT/1 Base 45x45 - Col. 8x8 Top Max 70x70 - Ø 80</p>									
	T1061Q45	H.107	M1	278 €	300 €	FM-M5	1	3	28.5

Optionals:

		Value	Options/notes
FM-M5	Stainless steel M5	+ 20 €	POLISHED STAINLESS STEEL HL

 <p>COMPOSIT/1 Base 55x55 - Col. 8x8 Top Max 80x80 - Ø 90</p>									
	T1061Q55	H.107	M1	332 €	353 €	FM-M5	1	3	34.0

Optionals:

		Value	Options/notes
FM-M5	Stainless steel M5	+ 20 €	POLISHED STAINLESS STEEL HL

 <p>COMPOSIT/2 Base 45x45 - Col. Ø 8 Top Max 70x70 - Ø 80</p>									
	T1062Q45	H.107	M1	271 €	288 €	FM-M5	1	3	28.5

Optionals:

		Value	Options/notes
FM-M5	Stainless steel M5	+ 20 €	POLISHED STAINLESS STEEL HL

 <p>COMPOSIT/2 Base 55x55 - Col. Ø 8 Top Max 80x80 - Ø 90</p>									
	T1062Q55	H.107	M1	300 €	327 €	FM-M5	1	3	34.0

Optionals:

		Value	Options/notes
FM-M5	Stainless steel M5	+ 20 €	POLISHED STAINLESS STEEL HL

 <p>COMPOSIT/3 Base Ø 45 - Col. Ø 8 Top Max 70x70 - Ø 80</p>									
	T1063D45	H.107	M1	260 €	278 €	FM-M5	1	3	28.5

Optionals:

		Value	Options/notes
FM-M5	Stainless steel M5	+ 20 €	POLISHED STAINLESS STEEL HL

COMPOSIT/3 Base Ø 55 - Col. Ø 8

Top Max 70x70 - Ø 80



T1063D55	H.107	M1	298 €	318 €	FM-M5	1	3	34.0	0.06
----------	-------	----	-------	-------	-------	---	---	------	------

Optionals:

	Value	Options/notes
FM-M5	Stainless steel M5	+ 20 € POLISHED STAINLESS STEEL HL

Version	Code	Base	Column	Optional	Q.ty	boxes	Kg	M ²
---------	------	------	--------	----------	------	-------	----	----------------

Composit H.107

Version for Glass top

			M1	M3						
COMPOSIT/1 Base 45x45 - Col. 8x8 *Vtr										
Top Max 70x70 - Ø 80										
	T1066Q45	H.107	M1	272 €	293 €	FM-M5	1	2	27.5	0.05

Optionals:

	Value	Options/notes
FM-M5	Stainless steel M5	+ 20 € POLISHED STAINLESS STEEL HL

COMPOSIT/1 Base 55x55 - Col. 8x8 *Vtr

Top Max 80x80 - Ø 90



T1066Q55	H.107	M1	324 €	347 €	FM-M5	1	2	33.0	0.06
----------	-------	----	-------	-------	-------	---	---	------	------

Optionals:

	Value	Options/notes
FM-M5	Stainless steel M5	+ 20 € POLISHED STAINLESS STEEL HL

COMPOSIT/2 Base 45x45 - Col. Ø 8 *Vtr

Top Max 70x70 - Ø 80



T1067Q45	H.107	M1	263 €	279 €	FM-M5	1	2	27.5	0.05
----------	-------	----	-------	-------	-------	---	---	------	------

Optionals:

	Value	Options/notes
FM-M5	Stainless steel M5	+ 20 € POLISHED STAINLESS STEEL HL

COMPOSIT/2 Base 55x55 - Col. Ø 8 *Vtr

Top Max 80x80 - Ø 90



T1067Q55	H.107	M1	280 €	320 €	FM-M5	1	2	33.0	0.06
----------	-------	----	-------	-------	-------	---	---	------	------

Optionals:		Value	Options/notes
FM-M5	Stainless steel M5	+ 20 €	POLISHED STAINLESS STEEL HL

COMPOSIT/3 Base Ø 45 - Col. Ø 8 *Vtr
Top Max 70x70 - Ø 80

	T1068D45	H.107	MI	252 €	272 €	FM-M5	1	2	28.5	0.05
--	----------	-------	----	-------	-------	-------	---	---	------	------

Optionals:		Value	Options/notes
FM-M5	Stainless steel M5	+ 20 €	POLISHED STAINLESS STEEL HL

COMPOSIT/3 Base Ø 55 - Col. Ø 8 *Vtr
Top Max 70x70 - Ø 80

	T1068D55	H.107	MI	279 €	313 €	FM-M5	1	2	33.0	0.06
--	----------	-------	----	-------	-------	-------	---	---	------	------

Optionals:		Value	Options/notes
FM-M5	Stainless steel M5	+ 20 €	POLISHED STAINLESS STEEL HL

Base finishes

Metal	
MI	WHITE BB, BLACK EN

Column finishes

Metal	
MI	WHITE BB, BLACK EN
M3	CHROME CC

COMPOSIT/1 H.107
Base 45x45 - Col. 8x8

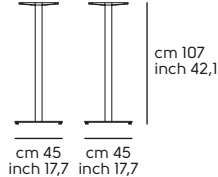

COMPOSIT/1 H.107
Base 55x55 - Col. 8x8

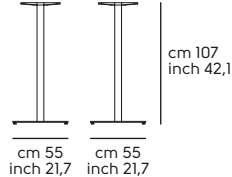

COMPOSIT/2 H.107
Base 45x45 - Col. Ø 8

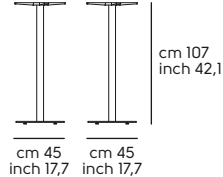

COMPOSIT/2 H.107
Base 55x55 - Col. Ø 8

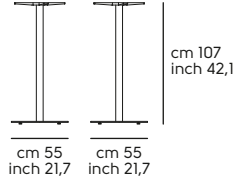

COMPOSIT/3 H.107
Base Ø 45 - Col. Ø 8

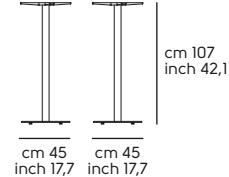

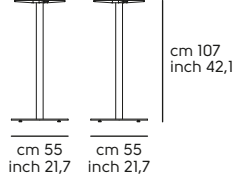

COMPOSIT/3 H.107
Base Ø 55 - Col. Ø 8



Dama design Jacopo Maria Giagnoni

Frame Dama

Frame in: metal. Top NOT included

Version	Code	H	--	Frame				Optional	Q.ty	boxes	Kg	M ³
Dama												
				M1	M2	O1	O2					
DAMA H.73 Top Max 80x80 - Ø 80 	T2070B04	H.73		243 €	270 €	320 €	348 €		1	1	10.5	0.23
DAMA H.103 Top Max 80x80 - Ø 80 	T2070B04	H.103		270 €	297 €	347 €	375 €		1	1	13.5	0.32

Note:

Frame finishes

Metal

M1	WHITE BB , BROWN E6 , SAND EC , GRAPHITE EG , BLACK EN	M2	LIGHT BLUE E0 , OCEAN BLUE E1 , BRONZE E2 , FANGO E3 , PASTEL YELLOW E4 , OCHER YELLOW E7 , FACEPOWDER PINK E8 , SAGE GREEN E9 , PAPAYA ORANGE EA , PINE GREEN EJ , DARK GREEN EL , GOLDEN YELLOW EO , CHERRY RED EQ , RED ER , ASH GREY ES , LIGHT GREY ET , BULGARO RED FP
-----------	---	-----------	---

Outdoor Metal

O1	Outdoor WHITE BB , Outdoor BROWN E6 , Outdoor SAND EC , Outdoor GRAFITE EG , Outdoor BLACK EN	O2	Outdoor LIGHT BLUE E0 , Outdoor OCEAN BLUE E1 , Outdoor BRONZE E2 , Outdoor FANGO E3 , Outdoor PASTEL YELLOW E4 , Outdoor OCHER YELLOW E7 , Outdoor FACEPOWDER PINK E8 , Outdoor SAGE GREEN E9 , Outdoor PINE GREEN EJ , Outdoor DARK GREEN EL , Outdoor GOLD YELLOW EO , Outdoor RED BULGARO FP , Outdoor CHERRY RED EQ , Outdoor RED ER , Outdoor ASH GREY ES , Outdoor LIGHT GREY ET , Outdoor PAPAYA ORANGE EA
-----------	--	-----------	---

Dama H. 73

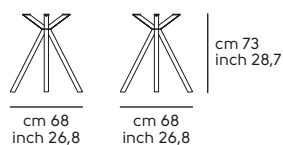



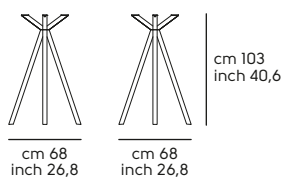



Dama H. 103



Liù design Archirivolto

Frame Liù

Frame in: metal-wood. Top NOT included

Version	Code	H	Legs	Metallic insert		Optional	Q.ty	boxes	Kg	M ³
Liù										
				M1	M2					
LIU' ML H 40 Top Max 60x60 - Ø 70										
	T1285B04	H. 40	LF1	203 €	242 €	PD-FO	1	1	4.0	0.08
LIU' ML H 50 Top Max 60x60 - Ø 70										
	T1285B04	H. 50	LF1	227 €	266 €	PD-FO	1	1	5.0	0.1
LIU' ML H 73 Top Max 70x70 - Ø 80										
	T1285B04	H. 73	LF1	255 €	294 €	PD-FO	1	1	6.5	0.21
LIU' ML H 107 Top Max 60x60 - Ø 70										
	T1285B04	H.107	LF1	309 €	348 €	PD-FO	1	1	8.0	0.29
LIU' ML GEO H 40 Top 120x50										
	T1285B14	H. 40	LF1	264 €	320 €	PD-FO	1	1	8.0	0.24
LIU' ML GEO H 50 Top 120x50										
	T1285B14	H. 50	LF1	273 €	329 €	PD-FO	1	1	9.0	0.28

Legs finishes

Wood

LFI	Ash wood painted GREY F02 , Ash wood painted GRAFITE GREY F03 , Ash wood painted BLACK F04 , Ash wood painted WHITE F05 , Ash wood painted BLUE F06 , Ash wood painted RED F08 , Ash wood painted CHERRY RED F09 , Ash wood painted FLAMED WALNUT F24 , Ash wood painted DARK BROWN F26 , Ash wood painted NATURAL F40 , Ash wood painted NATURAL OAK F52
------------	--

Insert finishes

Metal

M1	WHITE BB , BROWN E6 , SAND EC , GRAPHITE EG , BLACK EN
M2	LIGHT BLUE E0 , OCEAN BLUE E1 , BRONZE E2 , FANGO E3 , PASTEL YELLOW E4 , OCHER YELLOW E7 , FACEPOWDER PINK E8 , SAGE GREEN E9 , PAPAYA ORANGE EA , PINE GREEN EJ , DARK GREEN EL , GOLDEN YELLOW EO , CHERRY RED EQ , RED ER , ASH GREY ES , LIGHT GREY ET , BULGARO RED FP

Optionals:

		Value	Options/notes
PD-F0	Felt pad feet	+ 6 €	PD-F0

LIU' ML H 40

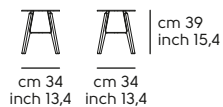

LIU' ML H 50

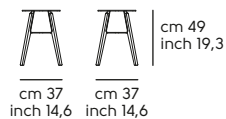

LIU' ML H 73

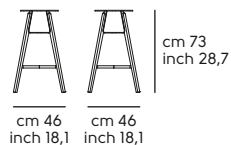

LIU' ML H 107

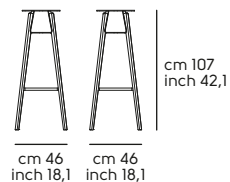

LIU' ML GEO H 40

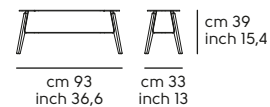



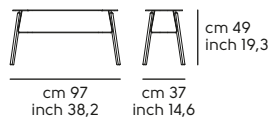

LIU' ML GEO H 50



Luna design Paolo Vernier

Frame Luna

Frame in: metal. Top NOT included

Version	Code	H	--	Frame				Optional	Q.ty	boxes	Kg	M ³
Luna												
				M1	M2	O1	O2					
LUNA Base 52x52 Top Max 80x80 - Ø 80  	T0311B40	H. 73		229 €	243 €	268 €	291 €		1	1	7.0	0.1
LUNA Base 52x52 Top Max 80x80 - Ø 80  	T0311B40	H.103		246 €	260 €	285 €	308 €		1	1	8.0	0.14

Frame finishes

Metal

M1	WHITE BB , BROWN E6 , SAND EC , GRAPHITE EG , BLACK EN
M2	LIGHT BLUE E0 , OCEAN BLUE E1 , BRONZE E2 , FANGO E3 , PASTEL YELLOW E4 , OCHER YELLOW E7 , FACEPOWDER PINK E8 , SAGE GREEN E9 , PAPAYA ORANGE EA , PINE GREEN EJ , DARK GREEN EL , GOLDEN YELLOW EO , CHERRY RED EQ , RED ER , ASH GREY ES , LIGHT GREY ET , BULGARO RED FP

Outdoor Metal

O1	Outdoor BROWN E6 , Outdoor WHITE BB , Outdoor SAND EC , Outdoor GRAFITE EG , Outdoor BLACK EN
O2	Outdoor LIGHT BLUE E0 , Outdoor OCEAN BLUE E1 , Outdoor BRONZE E2 , Outdoor FANGO E3 , Outdoor PASTEL YELLOW E4 , Outdoor OCHER YELLOW E7 , Outdoor FACEPOWDER PINK E8 , Outdoor SAGE GREEN E9 , Outdoor PINE GREEN EJ , Outdoor DARK GREEN EL , Outdoor GOLD YELLOW EO , Outdoor RED BULGARO FP , Outdoor CHERRY RED EQ , Outdoor RED ER , Outdoor ASH GREY ES , Outdoor LIGHT GREY ET , Outdoor PAPAYA ORANGE EA

Luna H. 73

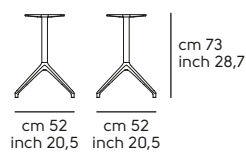



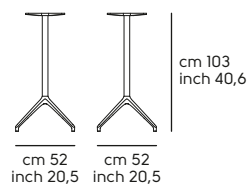





Luna H. 103



Ola design Paolo Vernier

Frame Ola

Frame in: metal. Top NOT included

Version	Code	H	--	Frame				Optional				
Ola												
				M1	M2	O1	O2					
OLA/3 H 73 Top Max Ø90-Min Ø60  	T1400B03	H. 73		140 €	155 €	184 €	205 €		1	1	4.5	0.25
OLA/4 H 73 Top Max 90x90-Min 75x75  	T1400B04	H. 73		203 €	226 €	271 €	292 €		1	1	6.5	0.39

Frame finishes

Metal

M1	WHITE BB , INDUSTRIAL E5 , BROWN E6 , SAND EC , GRAPHITE EG , BLACK EN
M2	LIGHT BLUE E0 , OCEAN BLUE E1 , BRONZE E2 , FANGO E3 , PASTEL YELLOW E4 , OCHER YELLOW E7 , FACEPOWDER PINK E8 , SAGE GREEN E9 , PAPAYA ORANGE EA , PINE GREEN EJ , DARK GREEN EL , GOLDEN YELLOW EO , CHERRY RED EQ , RED ER , ASH GREY ES , LIGHT GREY ET , BULGARO RED FP

Outdoor Metal

O1	Outdoor BROWN E6 , Outdoor WHITE BB , Outdoor SAND EC , Outdoor GRAFITE EG , Outdoor BLACK EN
O2	Outdoor LIGHT BLUE E0 , Outdoor OCEAN BLUE E1 , Outdoor BRONZE E2 , Outdoor FANGO E3 , Outdoor PASTEL YELLOW E4 , Outdoor OCHER YELLOW E7 , Outdoor FACEPOWDER PINK E8 , Outdoor SAGE GREEN E9 , Outdoor PINE GREEN EJ , Outdoor DARK GREEN EL , Outdoor GOLD YELLOW EO , Outdoor RED BULGARO FP , Outdoor CHERRY RED EQ , Outdoor RED ER , Outdoor ASH GREY ES , Outdoor LIGHT GREY ET , Outdoor PAPAYA ORANGE EA

OLA/3 H 73

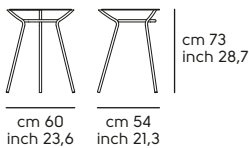



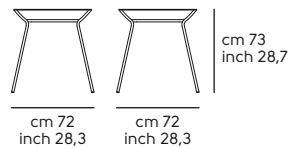

OLA/4 H 73



Plissé design Paola Navone

Frame Plissé

Frame in: metal. Top NOT included

Version	Code	H	--	Frame				Optional	Q.ty	boxes	Kg	M ³
Plissé												
PLISSÉ Top Ø 60-70-80-90				M1	M2	O1	O2					
 	T2220BT0	H. 73		872 €	897 €	960 €	985 €		1	1	25.0	0.17
PLISSÉ Top Ø 60-70												
 	T2220BT0	H.103		992 €	1.017 €	1.080 €	1.105 €		1	1	27.5	0.24

Frame finishes

Metal

M1	WHITE BB , BROWN E6 , SAND EC , GRAPHITE EG , BLACK EN
M2	LIGHT BLUE E0 , OCEAN BLUE E1 , BRONZE E2 , FANGO E3 , PASTEL YELLOW E4 , OCHER YELLOW E7 , FACEPOWDER PINK E8 , SAGE GREEN E9 , PAPAYA ORANGE EA , PINE GREEN EJ , DARK GREEN EL , GOLDEN YELLOW EO , CHERRY RED EQ , RED ER , ASH GREY ES , LIGHT GREY ET , BULGARO RED FP

Outdoor Metal

O1	Outdoor BROWN E6 , Outdoor WHITE BB , Outdoor SAND EC , Outdoor GRAFITE EG , Outdoor BLACK EN
O2	Outdoor LIGHT BLUE E0 , Outdoor OCEAN BLUE E1 , Outdoor BRONZE E2 , Outdoor FANGO E3 , Outdoor PASTEL YELLOW E4 , Outdoor OCHER YELLOW E7 , Outdoor FACEPOWDER PINK E8 , Outdoor SAGE GREEN E9 , Outdoor PINE GREEN EJ , Outdoor DARK GREEN EL , Outdoor GOLD YELLOW EO , Outdoor RED BULGARO FP , Outdoor CHERRY RED EQ , Outdoor RED ER , Outdoor ASH GREY ES , Outdoor LIGHT GREY ET , Outdoor PAPAYA ORANGE EA

Plissé H. 73

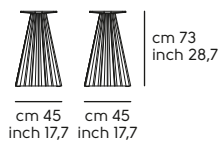



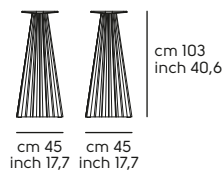

Plissé H. 103



Smart design Midj R&D

Frame Smart

Frame in: metal. Top NOT included

Version	Code	H	--	Base and Column					Optional	Q.ty	boxes	Kg	M ³
Smart H. 73													
SMART/1 Base 39x39 - Col. 6x6 Top Max 70x70 - Ø 80				M1	M2	M5	O1	B1					
 T1504Q39	H. 73			172 €	191 €	217 €	226 €	267 €	1	3	21.0	0.04	
SMART/1 Base 48x48 - Col. 6x6 Top Max 80x80 - Ø 90													
 T1504Q48	H. 73			226 €	247 €	288 €	300 €	335 €	1	3	25.0	0.04	
SMART/2 Base Ø 42 - Col. Ø 6 Top Max 70x70 - Ø 70													
 T1505D42	H. 73			150 €	170 €	190 €	201 €	243 €	1	3	23.0	0.05	
SMART/2 Base Ø 50 - Col. Ø 6 Top Max 70x70 - Ø 90													
 T1505D50	H. 73			176 €	197 €	229 €	258 €	272 €	1	3	27.0	0.05	

Base and Column Finishes

Metal

M1	WHITE BB, INDUSTRIAL E5, BROWN E6, SAND EC, GRAPHITE EG, BLACK EN
M2	LIGHT BLUE E0, OCEAN BLUE E1, BRONZE E2, FANGO E3, PASTEL YELLOW E4, OCHER YELLOW E7, FACEPOWDER PINK E8, SAGE GREEN E9, PAPAYA ORANGE EA, PINE GREEN EJ, DARK GREEN EL, GOLDEN YELLOW EO, CHERRY RED EQ, RED ER, ASH GREY ES, LIGHT GREY ET, BULGARO RED FP
M5	SATIN STAINLESS STEEL HS

Outdoor Metal

O1	Outdoor WHITE BB, Outdoor BLACK EN
-----------	------------------------------------

Seaside Zone Metal

B1	Bathing area WHITE NB, Bathing area BLACK NN
-----------	--

SMART/1 H. 73 Base 39x39 - Col. 6x6

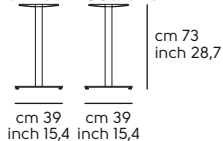

SMART/1 H. 73 Base 48x48 - Col. 6x6

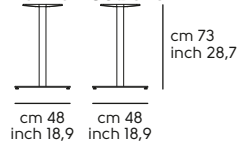

SMART/2 H. 73 Base Ø 42 - Col. Ø 6

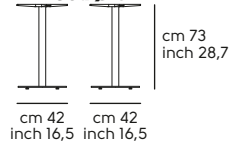



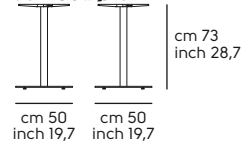



SMART/2 H. 73 Base Ø 50 - Col. Ø 6

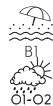

Version	Code	H	--	Base and Column	Optional	Q.ty	boxes	Kg	M ³
---------	------	---	----	-----------------	----------	------	-------	----	----------------

Smart H.107

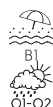
				M1	M2	M5	O1	B1				
SMART/1 Base 39x39 - Col. 6x6 Top Max 70x70 - Ø 70  	T1504Q39	H.107		198 €	217 €	243 €	252 €	293 €	1	3	23.0	0.04
SMART/1 Base 48x48 - Col. 6x6 Top Max 70x70 - Ø 70  	T1504Q48	H.107		252 €	273 €	314 €	326 €	361 €	1	3	27.0	0.04
SMART/2 Base Ø 42 - Col. Ø 6 Top Max 70x70 - Ø 70  	T1505D42	H.107		176 €	196 €	216 €	227 €	269 €	1	3	25.0	0.05
SMART/2 Base Ø 50 - Col. Ø 6 Top Max 70x70 - Ø 70  	T1505D50	H.107		202 €	223 €	255 €	284 €	298 €	1	3	29.0	0.05

Base and Column Finishes

Metal

M1	WHITE BB , INDUSTRIAL E5 , BROWN E6 , SAND EC , GRAPHITE EG , BLACK EN
M2	LIGHT BLUE E0 , OCEAN BLUE E1 , BRONZE E2 , FANGO E3 , PASTEL YELLOW E4 , OCHER YELLOW E7 , FACEPOWDER PINK E8 , SAGE GREEN E9 , PAPAYA ORANGE EA , PINE GREEN EJ , DARK GREEN EL , GOLDEN YELLOW EO , CHERRY RED EQ , RED ER , ASH GREY ES , LIGHT GREY ET , BULGARO RED FP
M5	SATIN STAINLESS STEEL HS

Outdoor Metal

O1	Outdoor WHITE BB , Outdoor BLACK EN
-----------	---

Seaside Zone Metal

B1	Bathing area WHITE NB , Bathing area BLACK NN
-----------	---

SMART/1 H.107 Base 39x39 - Col. 6x6

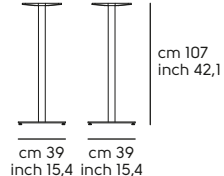

SMART/1 H.107 Base 48x48 - Col. 6x6

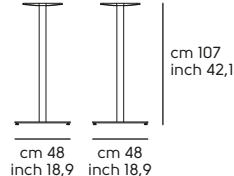

SMART/2 H.107 Base Ø 42 - Col. Ø 6

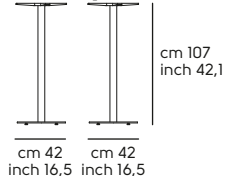

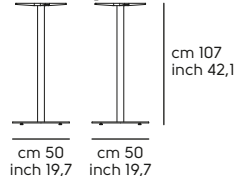

SMART/2 H.107 Base Ø 50 - Col. Ø 6



Square design Balutto Associati

Frame Square

Frame in: metal. Top NOT included

Version	Code	H	--	Frame				Optional	Q.ty	boxes	Kg	M ³
Square H. 73												
				M1	M2	O1	O2					
SQUARE 3G H 73 Top Max Ø 80 	T1900B03	H. 73		217 €	246 €	263 €	289 €		1	1	7.0	0.28
SQUARE 3G H 73 Folding Top Max Ø 80 	T1900BR3	H. 73		251 €	278 €	298 €	345 €		1	1	7.0	0.28
SQUARE 4G H 73 Top Max 80x80 - Ø 80 	T1900B04	H. 73		246 €	272 €	289 €	307 €		1	1	8.0	0.28

Frame finishes

Metal

M1	WHITE BB , BROWN E6 , SAND EC , GRAPHITE EG , BLACK EN
M2	LIGHT BLUE E0 , OCEAN BLUE E1 , BRONZE E2 , FANGO E3 , PASTEL YELLOW E4 , OCHER YELLOW E7 , FACEPOWDER PINK E8 , SAGE GREEN E9 , PAPAYA ORANGE EA , PINE GREEN EJ , DARK GREEN EL , GOLDEN YELLOW EO , CHERRY RED EQ , RED ER , ASH GREY ES , LIGHT GREY ET , BULGARRO RED FP

Outdoor Metal

O1	Outdoor BROWN E6 , Outdoor WHITE BB , Outdoor SAND EC , Outdoor GRAFITE EG , Outdoor BLACK EN
O2	Outdoor LIGHT BLUE E0 , Outdoor OCEAN BLUE E1 , Outdoor BRONZE E2 , Outdoor FANGO E3 , Outdoor PASTEL YELLOW E4 , Outdoor OCHER YELLOW E7 , Outdoor FACEPOWDER PINK E8 , Outdoor SAGE GREEN E9 , Outdoor PINE GREEN EJ , Outdoor DARK GREEN EL , Outdoor GOLD YELLOW EO , Outdoor RED BULGARRO FP , Outdoor CHERRY RED EQ , Outdoor RED ER , Outdoor ASH GREY ES , Outdoor LIGHT GREY ET , Outdoor PAPAYA ORANGE EA

SQUARE 3G H 73

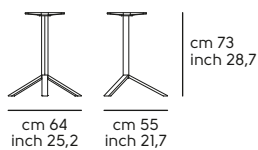

SQUARE 3G H 73 Folding

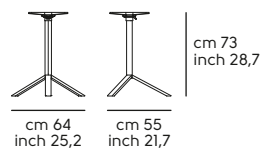



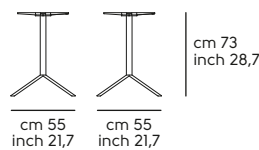



SQUARE 4G H 73



Version	Code	H	--	Frame	Optional	Q.ty	boxes	Kg	M ³
---------	------	---	----	-------	----------	------	-------	----	----------------

Square H.107

				M1	M2	O1	O2				
SQUARE 3G H 107 Top Max Ø 70  	T1900B03	H.107		237 €	266 €	283 €	309 €	1	1	9.0	0.42
	SQUARE 3G H 107 Folding Top Max Ø 70  	T1900BR3	H.107		272 €	299 €	319 €	366 €	1	1	9.0
SQUARE 4G H 107 Top Max 70x70 - Ø 70  		T1900B04	H.107		259 €	285 €	302 €	320 €	1	1	10.0

Frame finishes

Metal

M1	WHITE BB , BROWN E6 , SAND EC , GRAPHITE EG , BLACK EN
M2	LIGHT BLUE E0 , OCEAN BLUE E1 , BRONZE E2 , FANGO E3 , PASTEL YELLOW E4 , OCHER YELLOW E7 , FACEPOWDER PINK E8 , SAGE GREEN E9 , PAPAYA ORANGE EA , PINE GREEN EJ , DARK GREEN EL , GOLDEN YELLOW EO , CHERRY RED EQ , RED ER , ASH GREY ES , LIGHT GREY ET , BULGARO RED FP

Outdoor Metal

O1	Outdoor BROWN E6 , Outdoor WHITE BB , Outdoor SAND EC , Outdoor GRAFITE EG , Outdoor BLACK EN
O2	Outdoor LIGHT BLUE E0 , Outdoor OCEAN BLUE E1 , Outdoor BRONZE E2 , Outdoor FANGO E3 , Outdoor PASTEL YELLOW E4 , Outdoor OCHER YELLOW E7 , Outdoor FACEPOWDER PINK E8 , Outdoor SAGE GREEN E9 , Outdoor PINE GREEN EJ , Outdoor DARK GREEN EL , Outdoor GOLD YELLOW EO , Outdoor RED BULGARO FP , Outdoor CHERRY RED EQ , Outdoor RED ER , Outdoor ASH GREY ES , Outdoor LIGHT GREY ET , Outdoor PAPAYA ORANGE EA

SQUARE 3G H 107

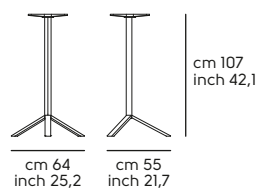

SQUARE 3G H 107 Folding

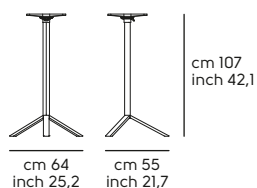

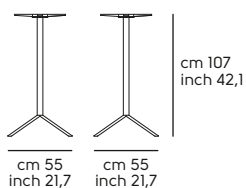

SQUARE 4G H 107



Trampoliere design Roberto Paoli

Frame Trampoliere

Frame in: metal. Top NOT included

Version	Code	H	--	Frame				Optional	Q.ty	boxes	Kg	M ³
Trampoliere												
				M1	M2	O1	O2					
TRAMPOLIERE H 73 Top Max Ø 80 	T1550B3G	H.73		153 €	172 €	194 €	211 €		1	2	10.5	0.31
TRAMPOLIERE H 107 Top Max Ø 80 	T1550B3G	H.107		172 €	191 €	213 €	230 €		1	2	11.5	0.44

Frame finishes

Metal

M1	WHITE BB , BROWN E6 , SAND EC , GRAPHITE EG , BLACK EN
M2	LIGHT BLUE E0 , OCEAN BLUE E1 , BRONZE E2 , FANGO E3 , PASTEL YELLOW E4 , OCHER YELLOW E7 , FACEPOWDER PINK E8 , SAGE GREEN E9 , PAPAYA ORANGE EA , PINE GREEN EJ , DARK GREEN EL , GOLDEN YELLOW EO , CHERRY RED EQ , RED ER , ASH GREY ES , LIGHT GREY ET , BULGARO RED FP

Outdoor Metal

O1	Outdoor BROWN E6 , Outdoor WHITE BB , Outdoor SAND EC , Outdoor GRAFITE EG , Outdoor BLACK EN
O2	Outdoor LIGHT BLUE E0 , Outdoor OCEAN BLUE E1 , Outdoor BRONZE E2 , Outdoor FANGO E3 , Outdoor PASTEL YELLOW E4 , Outdoor OCHER YELLOW E7 , Outdoor FACEPOWDER PINK E8 , Outdoor SAGE GREEN E9 , Outdoor PINE GREEN EJ , Outdoor DARK GREEN EL , Outdoor GOLD YELLOW EO , Outdoor RED BULGARO FP , Outdoor CHERRY RED EQ , Outdoor RED ER , Outdoor ASH GREY ES , Outdoor LIGHT GREY ET , Outdoor PAPAYA ORANGE EA

TRAMPOLIERE H. 73

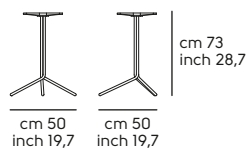

TRAMPOLIERE H.107

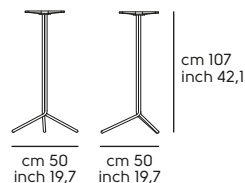

Top

Top design Midj R&D

Glass Top

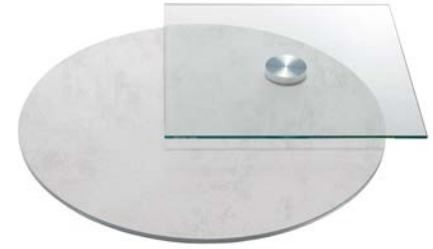

Version	Cod.	Thickness	Finish	Optional	Q.tà	colli	Kg	M³
---------	------	-----------	--------	----------	------	-------	----	----

Top Tondo Glass C/1 Boccola

				GVB				
Top Ø 60	TT10VD06	1.0		232 €	1	1	9.0	0.04
Top Ø 70	TT10VD07			246 €	1	1	11.5	0.05
Top Ø 80	TT10VD08			266 €	1	1	14.0	0.07
Top Ø 90	TT10VD09			305 €	1	1	18.0	0.09

Version	Cod.	Thickness	Finish	Optional	Q.tà	colli	Kg	M³
---------	------	-----------	--------	----------	------	-------	----	----

Top Square Glass with 1 Bush

				GVB				
Top 60x60	TT10VQ06	1.0		273 €	1	1	11.0	0.04
Top 70x70	TT10VQ07			299 €	1	1	14.0	0.05
Top 80x80	TT10VQ08			339 €	1	1	18.0	0.07
Top 90x90	TT10VQ09			370 €	1	1	23.0	0.09

Version	Cod.	Thickness	Finish	Optional	Q.tà	colli	Kg	M³
---------	------	-----------	--------	----------	------	-------	----	----

Top Round CristalCeramic C/4 Bush

				GKA	GKB	GMA				
Top Ø 50	TT14CD05	1.1 - 1.4		164 €	182 €	197 €	1	1	7.5	0.02
Top Ø 60	TT14CD06			204 €	226 €	252 €	1	1	9.5	0.04
Top Ø 70	TT14CD07			229 €	259 €	286 €	1	1	12.0	0.05
Top Ø 80	TT14CD08			274 €	292 €	329 €	1	1	15.0	0.07
Top Ø 90	TT14CD09			320 €	353 €	402 €	1	1	19.0	0.09

Version	Cod.	Thickness	Finish	Optional	Q.tà	colli	Kg	M³
---------	------	-----------	--------	----------	------	-------	----	----

Top Square CristalCeramic C/4 Bush

				GKA	GKB	GMA				
Top 50x50	TT14CQ05	1.1 - 1.4		164 €	182 €	197 €	1	1	8.5	0.02
Top 60x60	TT14CQ06			204 €	226 €	252 €	1	1	11.5	0.04
Top 70x70	TT14CQ07			229 €	259 €	286 €	1	1	15.0	0.05
Top 80x80	TT14CQ08			274 €	292 €	329 €	1	1	19.0	0.07
Top 90x90	TT14CQ09			320 €	353 €	402 €	1	1	23.5	0.09

Top finishes

Glossy Glass

GVB	EXTRA CLEAR TRANSPARENT J01 , EXTRA CLEAR GLOSSY WHITE J21
------------	--

Top finishes

Crystal Ceramic and Ceramic

GKA	PIOMBO K01 , CHARCOAL SAVOIA K11 , CEMENT SAVOIA K12 , EMPERADOR MARBLE BRUSH.MATT BROWN K31
GKB	RUST OXIDE K23 , WHITE CALCE K24

Crystal Ceramic and glossy Ceramic

GMA	MARBLE CALACATTA GLOSSY WHITE K32 , BLACK GREEK MARBLE K33 , MARBLE GLOSSY NOIR DESIR K35 , MARBLE CALACATTA MATT WHITE K42 , MARBLE MATT NOIR DESIR K45 , MARBLE MATT GREEN TINOS K46
------------	--

Marble Top



Version	Cod.	Thickness	Finish	Optional	Q.tà	colli	Kg	M³
---------	------	-----------	--------	----------	------	-------	----	----

Marble Round Top

				GMM				
Top Ø 60	TT20ND06	2.0		585 €	1	1	15.0	0.04
Top Ø 70	TT20ND07			695 €	1	1	20.0	0.05
Top Ø 80	TT20ND08			805 €	1	1	26.0	0.07

Top finishes

Marble

GMM	BEIGE TRAVERTINO ROMANO MB2 , WHITE CALACATTA VAGLI MB4 , BLACK MARQUINIA MN4 , GREEN TINOS MVE
------------	---

T
O
P

Top Melamine



Version	Cod.	Thickness	Finish	Optional	Q.tà	colli	Kg	M²
---------	------	-----------	--------	----------	------	-------	----	----

Melamine Round Top

				HLI				
Top Ø 50	TT18MD05	1.8		62 €	1	1	5.0	0.02
Top Ø 60	TT18MD06			66 €	1	1	6.0	0.04
Top Ø 70	TT18MD07			89 €	1	1	7.5	0.05
Top Ø 80	TT18MD08			113 €	1	1	9.0	0.07
Top Ø 90	TT36MD09	3.6		133 €	1	1	10.5	0.09
Top Ø 100	TT36MD10			169 €	1	1	13.5	0.11
Top Ø 120	TT36MD12			217 €	1	1	18.5	0.15

Version	Cod.	Thickness	Finish	Optional	Q.tà	colli	Kg	M²
---------	------	-----------	--------	----------	------	-------	----	----

Melamine Square Top

				HLI				
Top 50x50	TT18MQ05	1.8		60 €	1	1	5.0	0.02
Top 60x60	TT18MQ06			71 €	1	1	7.0	0.04
Top 70x70	TT18MQ07			92 €	1	1	9.0	0.05
Top 80x80	TT18MQ08			119 €	1	1	11.5	0.07
Top 90x90	TT36MQ09	3.6		142 €	1	1	14.5	0.09

Version	Cod.	Thickness	Finish	Optional	Q.tà	colli	Kg	M²
---------	------	-----------	--------	----------	------	-------	----	----

Melamine oval Top

				HLI				
Top 120x50 Oval	TT18MG12	1.8		119 €	1	1	9.0	0.02

Top finishes

Melamine

HLI WHITE **M01**, GRAFITE **M02**, BLACK**M04**, SAND **M07**

Top MDF

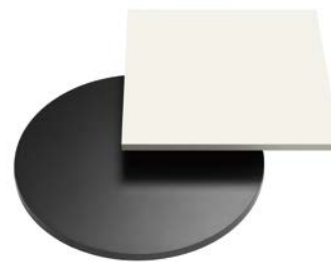

Version	Cod.	Thickness	Finish	Optional	Q.tà	colli	Kg	M ³
---------	------	-----------	--------	----------	------	-------	----	----------------

MDF Round Top

				LM1				
Top Ø 50	TT19LD05	1.9		90 €	1	1	4.0	0.02
Top Ø 60	TT19LD06			116 €	1	1	5.0	0.04
Top Ø 70	TT19LD07			147 €	1	1	6.5	0.05
Top Ø 80	TT19LD08			185 €	1	1	8.0	0.07
Top Ø 90	TT19LD09			226 €	1	1	9.5	0.09

Version	Cod.	Thickness	Finish	Optional	Q.tà	colli	Kg	M ³
---------	------	-----------	--------	----------	------	-------	----	----------------

MDF Square Top

				LM1				
Top 50x50	TT19LQ05	1.9		97 €	1	1	5.0	0.02
Top 60x60	TT19LQ06			120 €	1	1	6.5	0.04
Top 70x70	TT19LQ07			154 €	1	1	8.0	0.05
Top 80x80	TT19LQ08			190 €	1	1	10.0	0.07
Top 90x90	TT19LQ09			234 €	1	1	12.0	0.09

Top finishes

Lacquered MDF

LMI GRAPHITE GREY **G02**, BLACK **G04**, WHITE **G05**, SAND **G07**, BROWN **G41**

Top Fenix

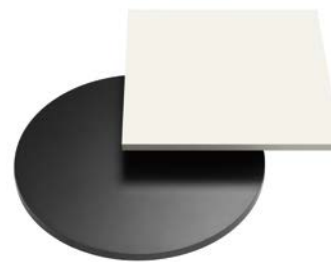

Version	Cod.	Thickness		Finish	Optional	Q.tà	colli	Kg	M ²
---------	------	-----------	--	--------	----------	------	-------	----	----------------

Fenix Round Top

				HF1					
Top Ø 50	TT19FD05			124 €		1	1	4.0	0.02
Top Ø 60	TT19FD06			152 €		1	1	5.0	0.04
Top Ø 70	TT19FD07	1.9		190 €		1	1	6.5	0.05
Top Ø 80	TT19FD08			243 €		1	1	8.0	0.07
Top Ø 90	TT19FD09			298 €		1	1	9.5	0.09

Version	Cod.	Thickness		Finish	Optional	Q.tà	colli	Kg	M ²
---------	------	-----------	--	--------	----------	------	-------	----	----------------

Fenix Square Top

				HF1					
Top 50x50	TT19FQ05			127 €		1	1	5.0	0.02
Top 60x60	TT19FQ06			154 €		1	1	6.5	0.04
Top 70x70	TT19FQ07	1.9		196 €		1	1	8.0	0.05
Top 80x80	TT19FQ08			248 €		1	1	10.0	0.07
Top 90x90	TT19FQ09			302 €		1	1	12.0	0.09

Top finishes

Fenix

HF1 BLACK FX4, WHITE FX5

Laminate Top



Version	Cod.	Thickness	Finish	Optional	Q.tà	colli	Kg	M ³
---------	------	-----------	--------	----------	------	-------	----	----------------

Laminate Round Top

				HLO				
Top Ø 50	TTI9HD05	1.9		105 €	1	1	4.0	0.02
Top Ø 60	TTI9HD06			130 €	1	1	5.0	0.04
Top Ø 70	TTI9HD07			164 €	1	1	6.5	0.05
Top Ø 80	TTI9HD08			208 €	1	1	8.0	0.07
Top Ø 90	TTI9HD09			254 €	1	1	9.5	0.09

Version	Cod.	Thickness	Finish	Optional	Q.tà	colli	Kg	M ³
---------	------	-----------	--------	----------	------	-------	----	----------------

Laminate Square Top

				HLO				
Top 50x50	TTI9HQ05	1.9		108 €	1	1	5.0	0.02
Top 60x60	TTI9HQ06			134 €	1	1	6.5	0.04
Top 70x70	TTI9HQ07			171 €	1	1	8.0	0.05
Top 80x80	TTI9HQ08			215 €	1	1	10.0	0.07
Top 90x90	TTI9HQ09			263 €	1	1	12.0	0.09

Top finishes

Laminate

HLO	BLUE LBB, GRAFITE GREY LGD, ASH GREY LGS, CHERRY RED LRC, RED BULGARO LRS, SAND LS2
------------	---

Top HPL



Version	Code	Thickness		Finish	Optional	Q.ty	boxes	Kg	M³	
HPL Round Top										
				HH1	HH2	HH3				
Top Ø 50	TT10HD05			123 €	129 €	155 €	1	1	5.0	0.02
Top Ø 60	TT10HD06			135 €	150 €	190 €	1	1	5.0	0.04
Top Ø 70	TT10HD07	1.0		196 €	206 €	212 €	1	1	6.5	0.05
Top Ø 79,2	TT10HD08			212 €	222 €	237 €	1	1	9.5	0.07
Top Ø 90	TT10HD09			261 €	271 €	289 €	1	1	14.0	0.09

Version	Code	Thickness		Finish	Optional	Q.ty	boxes	Kg	M³	
HPL Square Top Radius 10										
				HH1	HH2	HH3				
Top 50x50 Radius 10	TT10HQ05			129 €	138 €	155 €	1	1	6.0	0.02
Top 60x60 Radius 10	TT10HQ06			150 €	158 €	176 €	1	1	6.5	0.04
Top 70x70 Radius 10	TT10HQ07	1.0		196 €	206 €	223 €	1	1	8.0	0.05
Top 79,2x79,2 Radius 10	TT10HQ08			212 €	219 €	240 €	1	1	10.5	0.07
Top 90x90 Radius 10	TT10HQ09			261 €	271 €	296 €	1	1	13.0	0.09

Version	Code	Thickness		Finish	Optional	Q.ty	boxes	Kg	M³	
HPL Square Top Radius 60										
				HH1	HH2	HH3				
Top 75x75 Radius 60	TT10HQ75	1.0		268 €	280 €	298 €	1	1	10.5	0.07
Top 85x85 Radius 60	TT10HQ85			312 €	326 €	345 €	1	1	13.0	0.09

Version	Code	Thickness		Finish	Optional	Q.ty	boxes	Kg	M³	
HPL oval Top										
				HH1	HH2	HH3				
Top 120x50 Ovale	TT10HG12	1.0		250 €	265 €	286 €	1	1	9.0	0.02

Top finishes

HPL

HH1	WHITE/Black Core HB4 , BLACK/Black Core HN4	HH2	CEMENT/Black Core HC6 , CORTEN/Brown Core HC7 , DARK GREY/Black Core HGW
HH3	WHITE/White Core WB4		

Top sheet metal



Version	Code	Thickness	Finish				Optional	Q.ty	boxes	Kg	M ³
Top sheet metal											
			M1	M2	O1	O2					
Top Ø 50	TT03ID05	0.3	89 €	116 €	118 €	138 €		1	1	4.5	0.02
Top Ø 60	TT03ID06		102 €	127 €	128 €	153 €		1	1	8.5	0.04
Top Ø 70	TT03ID07		113 €	142 €	142 €	171 €		1	1	13.5	0.05
Top Ø 80	TT03ID08		129 €	156 €	153 €	181 €		1	1	15.5	0.07
Top Ø 90	TT03ID09		149 €	176 €	173 €	201 €		1	1	16.5	0.09

Version	Code	Thickness	Finish				Optional	Q.ty	boxes	Kg	M ³
Top sheet metal											
			M1	M2	O1	O2					
Top 50x50 Radius 60	TT03IQ50	0.3	93 €	120 €	125 €	151 €		1	1	7.5	0.02
Top 60x60 Radius 60	TT03IQ60		106 €	131 €	142 €	169 €		1	1	10.0	0.04
Top 70x70 Radius 60	TT03IQ70		112 €	139 €	153 €	180 €		1	1	13.0	0.05
Top 75x75 Radius 60	TT03IQ75		118 €	142 €	153 €	180 €		1	1	16.0	0.05
Top 80x80 Radius 60	TT03IQ80		127 €	153 €	156 €	183 €		1	1	16.5	0.07
Top 85x85 Radius 60	TT03IQ85		131 €	156 €	160 €	186 €		1	1	20.0	0.07
Top 90x90 Radius 60	TT03IQ90		137 €	163 €	168 €	194 €		1	1	20.5	0.09

Top metal



Version	Code	Thickness	Finish				Optional	Q.ty	boxes	Kg	M ²
Square Metal Top											
			M1	M2	O1	O2					
Top Ø 60	TT15LD06	1.5	133 €	161 €	161 €	189 €		1	1	5.0	0.04
Top Ø 70	TT15LD07		160 €	190 €	188 €	216 €		1	1	6.5	0.05
Top Ø 80	TT15LD08		225 €	254 €	254 €	280 €		1	1	9.5	0.07

Version	Code	Thickness	Finish				Optional	Q.ty	boxes	Kg	M ²
Square Metal Top											
			M1	M2	O1	O2					
Top 50x50	TT15LQ50	1.5	153 €	180 €	177 €	204 €		1	1	6.5	0.02
Top 60x60	TT15LQ60		162 €	190 €	190 €	216 €		1	1	8.5	0.04
Top 70x70	TT15LQ70		176 €	203 €	203 €	230 €		1	1	10.5	0.05
Top 80x80	TT15LQ80		214 €	240 €	240 €	268 €		1	1	12.5	0.07
Top 90x90	TT15LQ90		237 €	264 €	264 €	291 €		1	1	14.0	0.09

Note:

NOT AVAILABLE in Industrial E5 finish

Top finishes

Metal

M1	WHITE BB , INDUSTRIAL E5 , BROWN E6 , SAND EC , GRAPHITE EG , BLACK EN
M2	LIGHT BLUE E0 , OCEAN BLUE E1 , FANGO E3 , PASTEL YELLOW E4 , OCHER YELLOW E7 , FACEPOWDER PINK E8 , SAGE GREEN E9 , PAPAYA ORANGE EA , PINE GREEN EJ , DARK GREEN EL , GOLDEN YELLOW EO , CHERRY RED EQ , RED ER , ASH GREY ES , LIGHT GREY ET , BRONZE EZ + TRANSP., BULGARO RED FP





Outdoor Metal

O1	Outdoor BROWN E6 , Outdoor WHITE BB , Outdoor SAND EC , Outdoor GRAFITE EG , Outdoor BLACK EN
O2	Outdoor LIGHT BLUE E0 , Outdoor OCEAN BLUE E1 , Outdoor FANGO E3 , Outdoor PASTEL YELLOW E4 , Outdoor OCHER YELLOW E7 , Outdoor FACEPOWDER PINK E8 , Outdoor SAGE GREEN E9 , Outdoor PINE GREEN EJ , Outdoor DARK GREEN EL , Outdoor GOLD YELLOW EO , Outdoor RED BULGARO FP , Outdoor CHERRY RED EQ , Outdoor RED ER , Outdoor ASH GREY ES , Outdoor LIGHT GREY ET , Outdoor PAPAYA ORANGE EA , Outdoor BRONZE EZ +TRANSP.

Accessories

Accessoires design Midj R&D

Accessoires



Model	Code	--	--	Set 20 linking device	Optional	 Q.ty	 boxes	 Kg	 M³
				ZC					
Set 20 linking device 	A1920AGU0N			49 €		1	1	1.5	0.01

Note:

ATTENTION !: Kit 20 Pcs. - AVAILABLE only for Base Type T

Linking device

Calla S MT

	cm 4,8 inch 1,9
	cm 2 inch 0,8
	cm 14,5 inch 5,7

Finishes

Similpelle Secret - Secret Faux leather

Cat. TA



EOB4
Bianco - White



EOV2
Vaniglia - Vanilla



EOB2
Beige

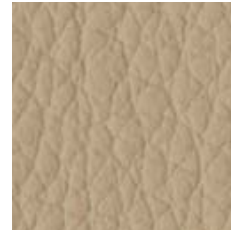

EOS2
Sabbia - Sand

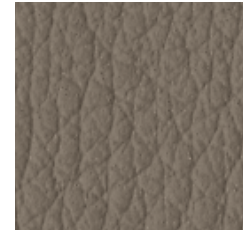

EOTR
Tortora



EORR
Rosso - Red



EORS
Rosso Bulgaro - Bulgaro red

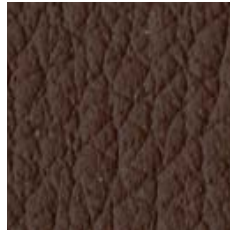

EOM2
Marrone - Brown

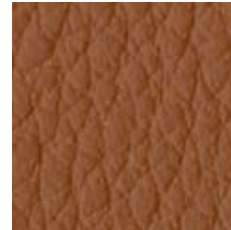

EONA
Nocciola - Hazel

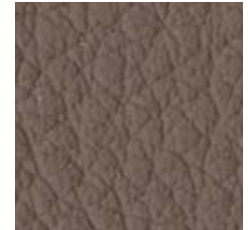

EOF2
Fango



EOA8
Arancio - Orange

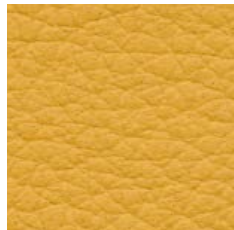

EOO2
Giallo ocre - Ocher yellow

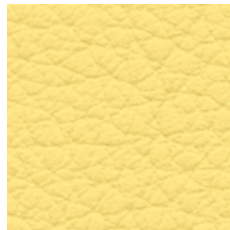

EOG5
Giallo pastello - Pastel yellow

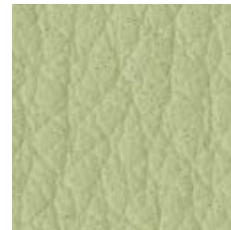

EOVI
Verde pastello - Pastel green



EOLB
Lime



EOGS
Grigio cenere - Ash grey

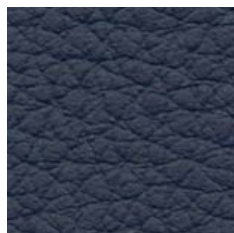

EOBB
Blu - Blue

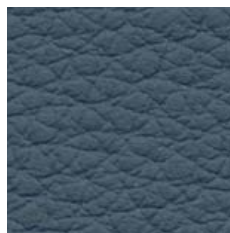

EOAM
Blu avio - Air force blue



EOVJ
Verde pino - Pine green



EOVE
Verde - Green

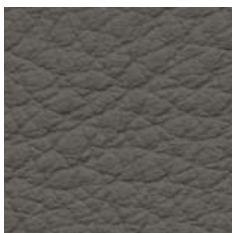

EOGV
Grigio polvere - Dust grey

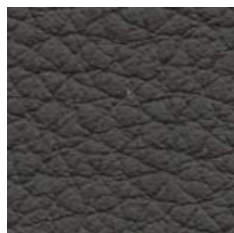

EOA6
Grigio antracite - Anthracite grey

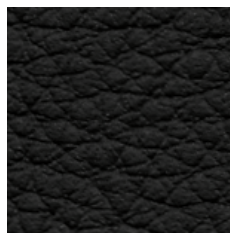

EOA4
Nero - Black

Tessuto Mirage - Mirage fabric

Cat. TA



TIB2
Beige



TIF2
Fango



TIAK
Havana



TINA
Nocciola - Hazel

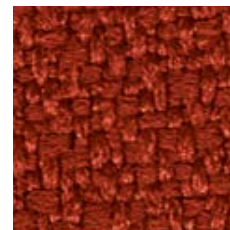

TIA9
Arancio mattone - Brick orange

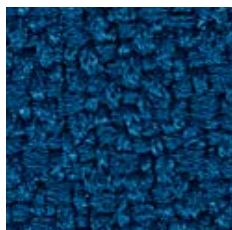

TIBB
Blu - Blue

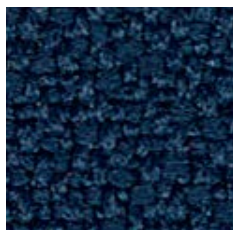

TIO4
Blu oltremare - Ultramarine blue

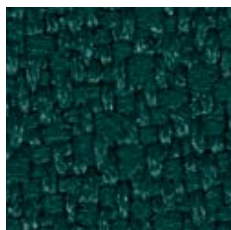

TIVJ
Verde pino - Pine green



TIG4
Giallo - Yellow

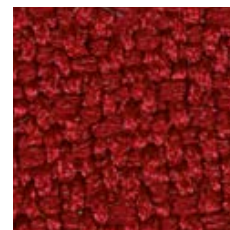

TIR5
Rosso bulgaro - Bulgaro red

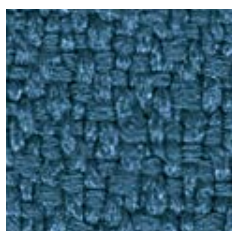

TIAM
Blu avio - Air force blue



TIGT
Grigio chiaro - Light grey



TIGW
Grigio scuro - Dark grey



TIGV
Grigio polvere - Dust grey

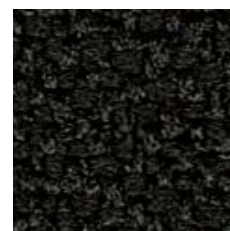

TIN4
Nero - Black

Tessuto Cotton Club - Cotton Club fabric

Cat. TA

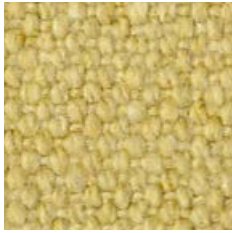

T7LB
Lime



T7B2
Beige



T7S4
Sahara



T7S2
Sabbia - Sand



T7F2
Fango

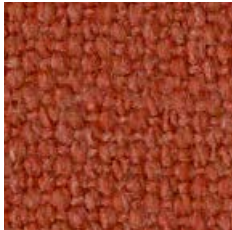

T7A8
Arancio - Orange



T7R2
Rosso - Red

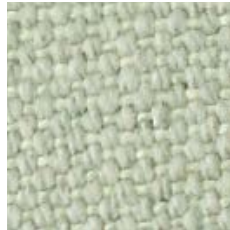

T7VK
Verde salvia - Sage green

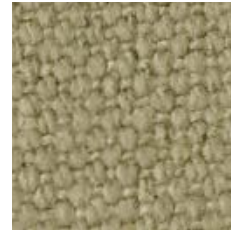

T7VH
Verde Oliva - Olive green



T7VE
Verde - Green



T7GT
Grigio chiaro - Light grey

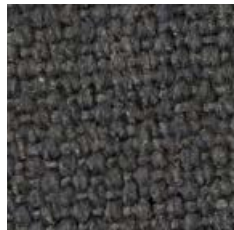

T7GD
Grigio grafite - Graphite grey



T7BB
Blu - Blue

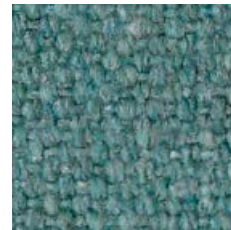

T7AZ
Azzurro - Light blue

Similpelle Vintage - Vintage faux leather

Cat. TB



E2B2
Beige



E2CU
Cuoio - Hide

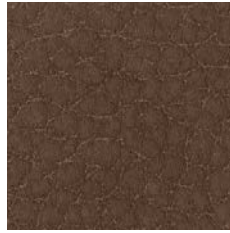

E2M2
Marrone - Brown



E2F2
Fango



E2T4
Testa di moro - Dark brown



E2RR
Rosso - Red



E2VE
Verde - Green



E2VL
Verde scuro - Dark green



E2BB
Blu - Blue

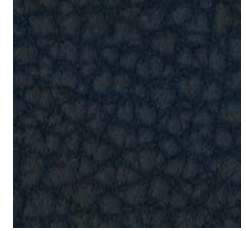

E2BE
Blu scuro - Dark blue



E2N4
Nero - Black

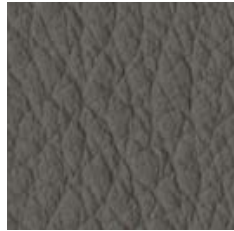

E2GR
Grigio - Grey

Tessuto Fenix Wool - Fenix Wool fabric

Cat. TB



T3G4
Giallo - Yellow



T3O2
Giallo ocre - Ocher yellow



T3A8
Arancio - Orange

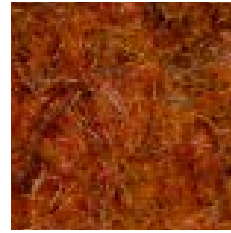

T3A9
Arancio mattone - Brick orange

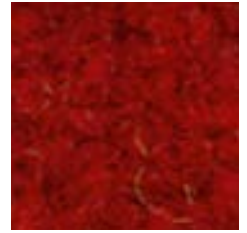

T3RR
Rosso - Red



T3VH
Verde oliva - Olive green



T3VF
Verde mela - Apple green



T3B2
Beige

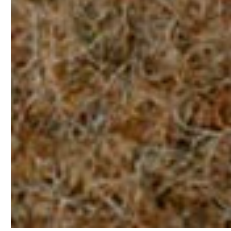

T3M2
Marrone - Brown

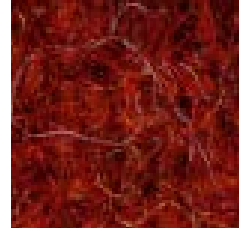

T3RS
Rosso bulgaro - Bulgaro red



T3BE
Blu scuro - Dark blue



T3J5
Blue jeans



T3GU
Grigio cielo - Sky grey



T3C6
Grigio cemento - Concrete grey



T3GV
Grigio polvere - Dust grey

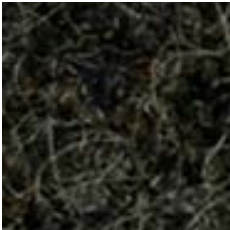

T3GR
Grigio - Grey

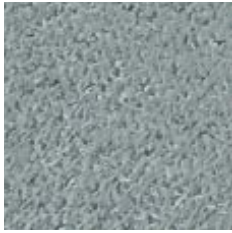

TGAZ
Azzurro - Light blue

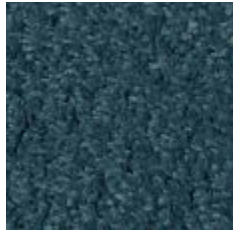

TGBC
Blu oceano - Ocean blue



TGVJ
Verde scuro - Dark green

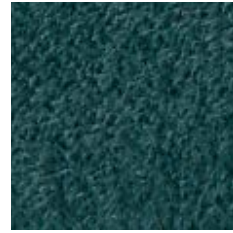

TGVJ
Verde pino - Pine green



TGG6
Giallo oro - Golden yellow



TGO2
Giallo ocra - Ocher yellow



TGA7
Arancio papaya - Papaya orange



TGRR
Rosso - Red

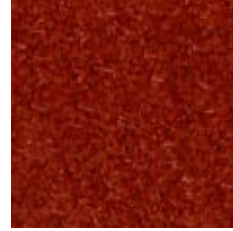

TGRC
Rosso ciliegia - Cherry red

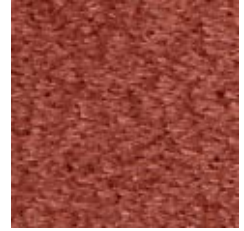

TGRS
Rosso bulgaro - Bulgaro red



TGB4
Bianco - White

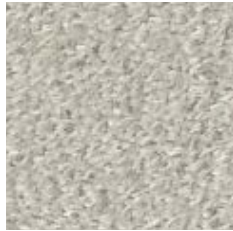

TGCT
Grigio chiaro - Light grey

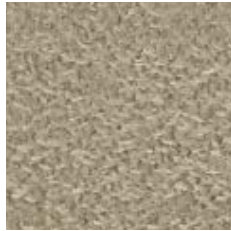

TGG5
Grigio cenere - Ash grey



TGF2
Fango

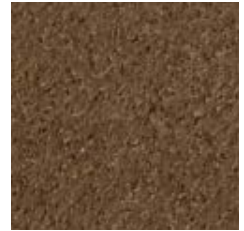

TGM2
Marrone - Brown



TGGW
Grigio scuro - Dark grey

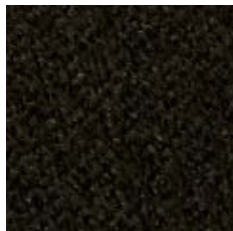

TGN4
Nero - Black

Tessuto Manhattan - Manhattan fabric

Cat. TB



TDF2
Fango



TDGW
Grigio scuro - Dark grey



TDGT
Grigio chiaro - Light grey



TDV2
Vaniglia - Vanilla



TDB2
Beige



TDS2
Sabbia - Sand



TDR3
Rosa chiaro - Light pink



TDM2
Marrone - Brown



TDC2
Caffè - Coffee



TDA8
Arancio - Orange



TDBC
Blu oceano - Ocean blue



TDBF
Blu ottanio - Teal blue

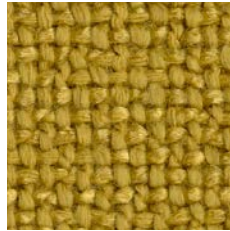

TDLB
Lime

Tessuto Visual - Visual fabric

Cat. TB

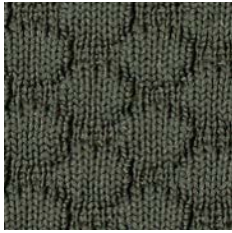

TCVJ
Verde pino - Pine green



TCB8
Blu - Blue

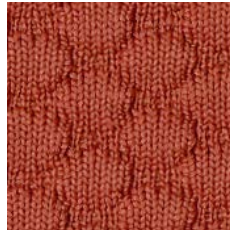

TCR5
Rosso bulgaro - Bulgaro red



TCRR
Rosso - Red



TCA8
Arancio - Orange



TCM2
Marrone - Brown



TCS2
Sabbia - Sand



TCLB
Lime



TCO2
Giallo ocra - Ocher yellow



TCRI
Rosa - Pink

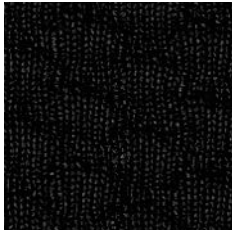

TCN4
Nero - Black



TCGW
Grigio scuro - Dark grey



TCGT
Grigio chiaro - Light grey

Velluto Superb - Superb velvet

Cat. TC



T6R3
Rosa chiaro - Light pink



T6R2
Rosa antico - Antique pink



T6RS
Rosso Bulgaro - Bulgaro red

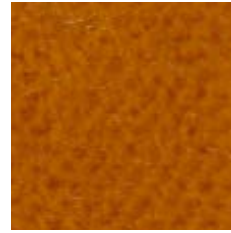

T6A8
Arancio - Orange

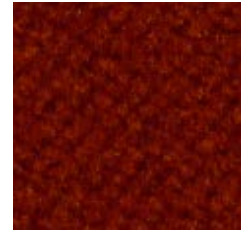

T6A9
Arancio mattone - Brick orange



T6O2
Giallo ocre - Ocher yellow



T6G4
Giallo - Yellow



T6VH
Verde oliva - Olive green

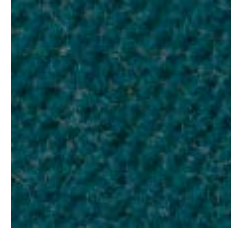

T6VJ
Verde pino - Pine green



T6A2
Acciaio - Steel

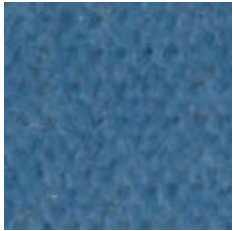

T6AZ
Azzurro - Light blue



T6BD
Blu oltremare - Ultramarine blue



T6GT
Grigio chiaro - Light grey

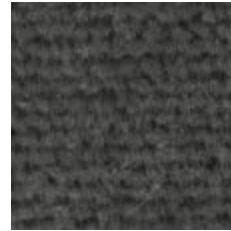

T6GR
Grigio - Grey

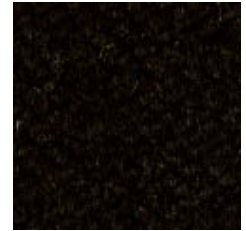

T6A6
Grigio antracite - Anthracite grey



T6TR
Tortora

Tessuto Main Line Flax - Main Line Flax fabric

Cat. TC 



TAAZ
Azzurro - Light blue



TAAM
Blu avio - Air force blue



TABC
Blu oceano - Ocean blue



TAVJ
Verde pino - Pine green



TAVE
Verde - Green



TAVH
Verde oliva - Olive green



TALB
Lime



TAA8
Arancio - Orange



TARS
Rosso Bulgaro - Bulgaro red



TAA9
Arancio mattone - Brick orange



TAS4
Sahara



TAM2
Marrone - Brown



TAS2
Sabbia - Sand



TAGT
Grigio chiaro - Light grey



TAGW
Grigio scuro - Dark grey



TAN4
Nero - Black

Tessuto Second - Second fabric

Cat. TC



T9RS
Rosso bulgario - Bulgario red

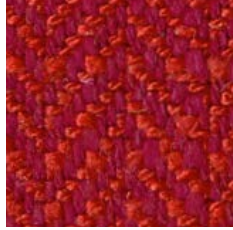

T9RR
Rosso - Red

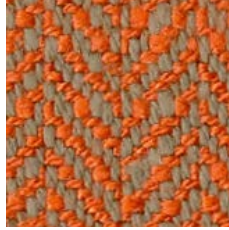

T9A8
Arancio - Orange



T9BC
Blu oceano - Ocean blue

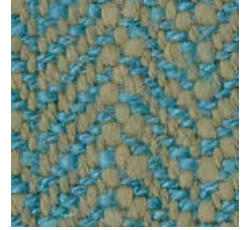

T9AZ
Azzurro - Light blue



T9M2
Marrone - Brown



T9F2
Fango



T9S2
Sabbia - Sand

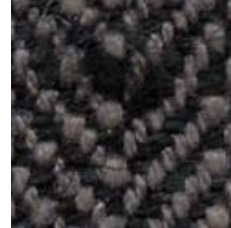

T9N4
Nero - Black



T9GD
Grigio grafite - Graphite grey



T9GT
Grigio chiaro - Light grey

Tessuto Oceanic - Oceanic fabric

Cat. TC



TER3
Rosa chiaro - Light pink

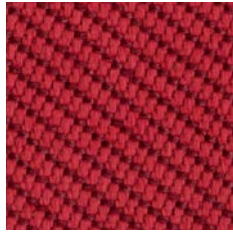

TERR
Rosso - Red

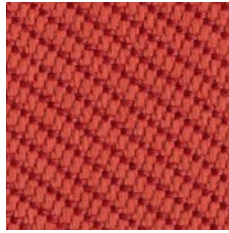

TEA8
Arancio - Orange

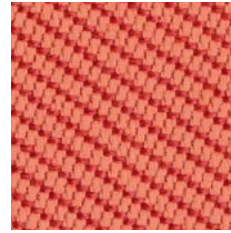

TEA7
Arancio papaya - Papaya orange



TEG4
Giallo - Yellow

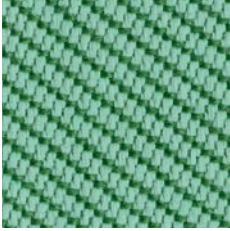

TEVK
Verde salvia - Sage green

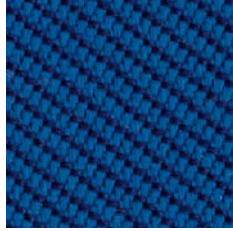

TEBC
Blu oceano - Ocean blue

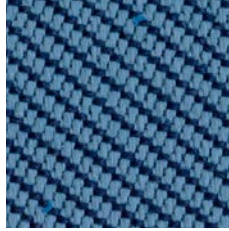

TED5
Blu denim - Denim blue

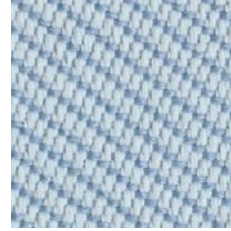

TEAZ
Azzurro - Light blue



TEGT
Grigio chiaro - Light grey



TEGR
Grigio - Grey



TETR
Tortora

Tessuto Remix 3 - Remix 3 fabric

Cat. TD



THAZ
Azzurro - Light blue



THJ5
Blue jeans

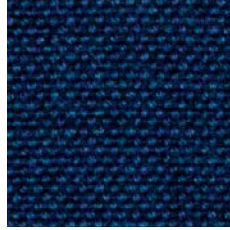

THBB
Blu - Blue

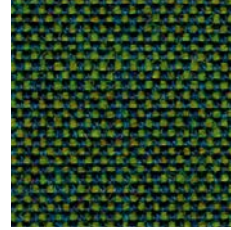

THVL
Verde scuro - Dark green



THVK
Verde salvia - Sage green

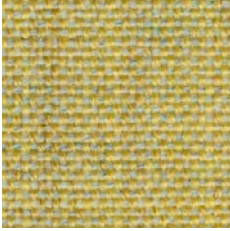

THG5
Giallo pastello - Pastel yellow

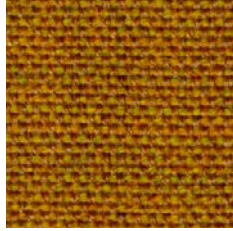

THO2
Giallo ocre - Ocher yellow



THA8
Arancio - Orange



THA7
Arancio papaya - Papaya orange

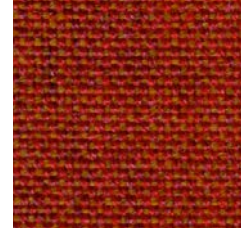

THRR
Rosso - Red



THB2
Beige

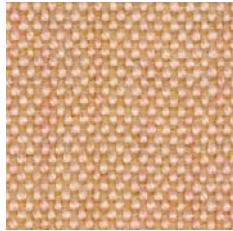

THR4
Rosa cipria - Facepowder pink

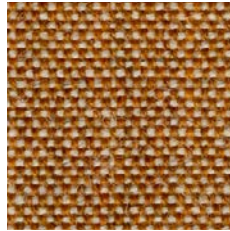

THNA
Nocciola - Hazel



THT2
Terracotta

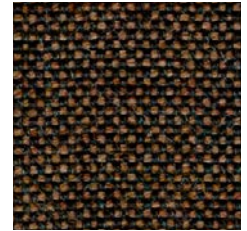

THM2
Marrone - Brown



THS2
Sabbia - Sand



THF2
Fango



THGW
Grigio scuro - Dark grey

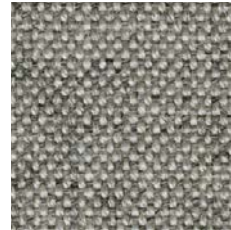

THGS
Grigio cenere - Ash grey

Tessuto Yoredale - Yoredale fabric

Cat. TD



TFRC
Rosso ciliegia - Cherry red

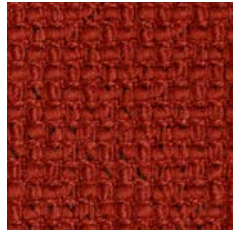

TFRS
Rosso Bulgaro - Bulgaro red



TFA8
Arancio - Orange



TFA7
Arancio papaya - Papaya orange

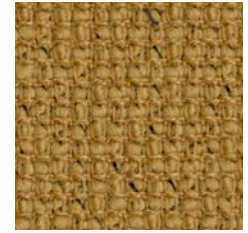

TFO2
Giallo ocre - Ocher yellow

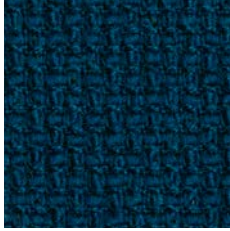

TFBF
Blu ottanio - Teal blue



TFAZ
Azzurro - Light blue



TFR3
Rosa chiaro - Light pink



TFNA
Nocciola - Hazel

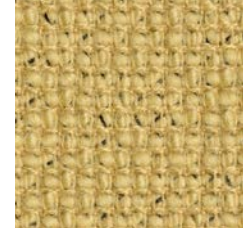

TFG5
Giallo pastello - Pastel yellow



TFBB
Blu - Blue



TFN4
Nero - Black



TFGW
Grigio scuro - Dark grey



TFGR
Grigio - Grey

Tessuto Uniform Melange - Uniform Melange fabric

Cat. TE

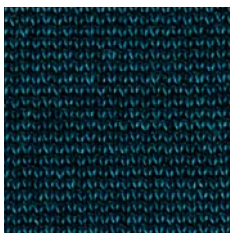

TIBC
Blu oceano - Ocean blue

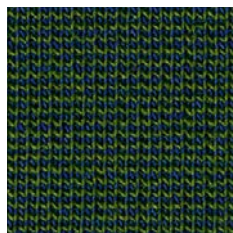

TIVL
Verde scuro - Dark green

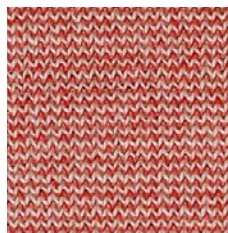

TIRR
Rosso - Red

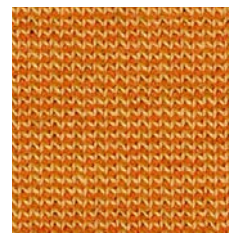

TIO2
Giallo ocre - Ocher yellow

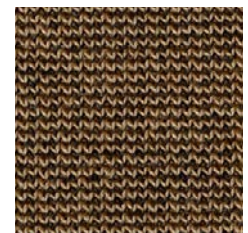

TIF2
Fango



TIGR
Grigio - Grey

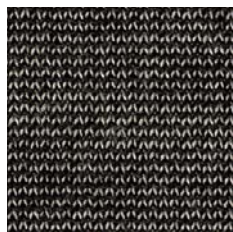

TIGD
Grigio grafite - Graphite grey



POB4
Bianco - White



POV2
Vaniglia - Vanilla



POS4
Sahara



PONA
Nocciola - Hazel

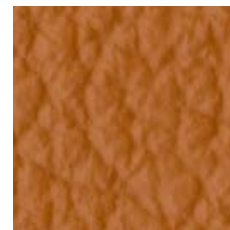

POCU
Cuio - Hide

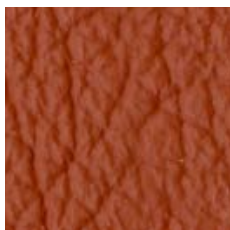

POT2
Terracotta

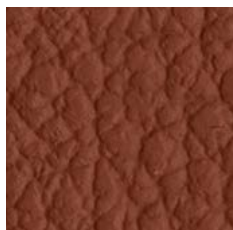

POBR
Marrone - Brown



POBK
Rosso bordeaux -
Bordeaux red

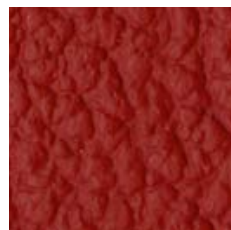

PORT
Rosso scuro - Dark red

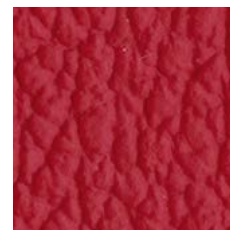

PORR
Rosso - Red

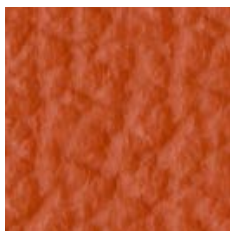

POA8
Arancio - Orange



POA9
Arancio mattone - Brick
orange



POF2
Fango



POFU
Fumo - Smoke

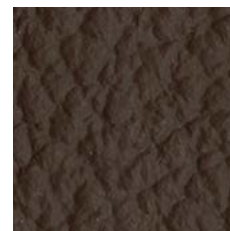

POT4
Testa di moro - Dark brown

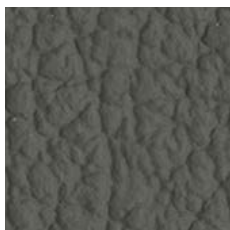

POGV
Grigio polvere - Dust grey



POGS
Grigio cenere - Ash grey



POSK
Azzurro sky - Light blue
sky



POD5
Blu denim - Denim blue

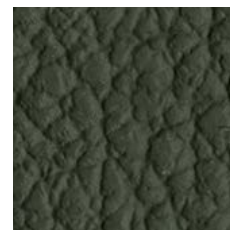

POVE
Verde - Green



PON4
Nero - Black

Pelle Vintage - Vintage leather

Cat. SV



P2S2
Sabbia - Sand



P2NA
Nocciola - Hazel

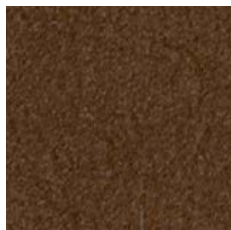

P2M2
Marrone - Brown



P2CU
Cuoio - Hide



P2G5
Grigio cenere - Ash grey



P2GR
Grigio - Grey



P2VH
Verde oliva - Olive green

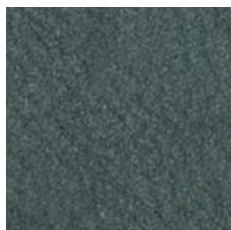

P2D5
Blu denim - Denim blue



C0BC
Blu oceano - Ocean blue



C0AZ
Azzurro - Light blue



C0VK
Verde salvia - Sage green



C0VJ
Verde pino - Pine green



C0GW
Grigio scuro - Dark grey

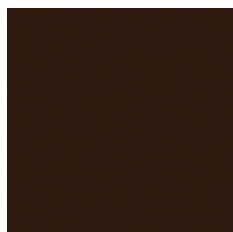

C0T4
Testa di moro - Dark brown

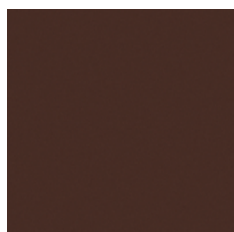

C0C2
Caffè - Coffee



C0F2
Fango

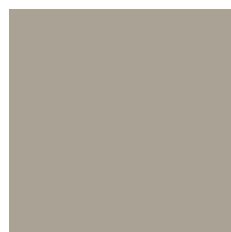

C0G5
Grigio cenere - Ash grey



C0N4
Nero - Black

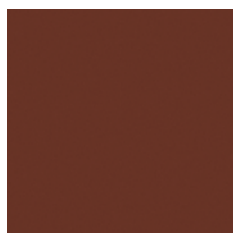

C0RS
Rosso Bulgaro - Bulgaro red



C0RC
Rosso ciliegia - Cherry red

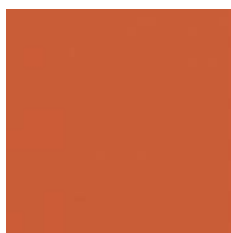

C0A7
Arancio papaya - Papaya orange



C0O2
Giallo ocre - Ocher yellow



C0S4
Sahara



C0R4
Rosa cipria - Facepowder pink



C0V2
Vaniglia - Vanilla

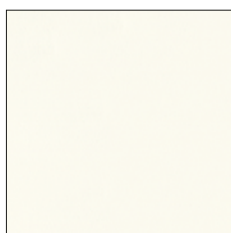

C0B4
Bianco - White

Cuoio TK - TK hide

Cat. CK



C2BC
Blu oceano - Ocean blue



C2AZ
Azzurro - Light blue



C2VK
Verde salvia - Sage green



C2VJ
Verde pino - Pine green



C2F2
Fango

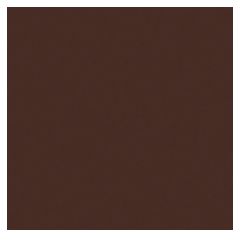

C2C2
Caffè - Coffee

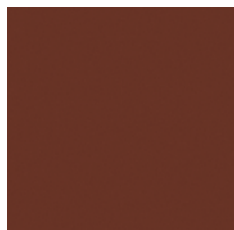

C2RS
Rosso Bulgaro - Bulgaro red



C2RC
Rosso ciliegia - Cherry red



C2O2
Giallo ocre - Ocher yellow



C2G5
Grigio cenere - Ash grey



C2R4
Rosa cipria - Facepowder pink

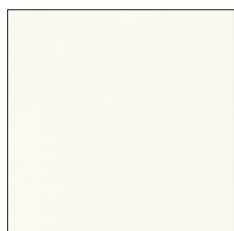

C2B4
Bianco - White

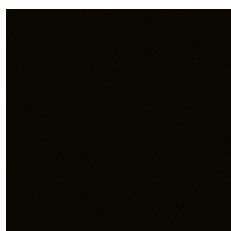

C2N4
Nero - Black

Collezioni Guapa, P47 e Sunrise disponibili solo in cuoio TK
Guapa, P47 and Sunrise collections available only in TK hide

Cuoio Toscano - Tuscan hide

Cat. CT

Nabuk

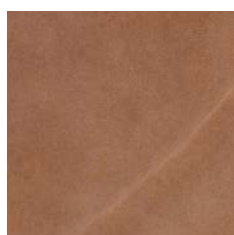

C3M2
Marrone - Brown



C3N4
Nero - Black

Fiore

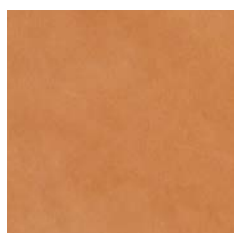

C3N2
Naturale - Natural

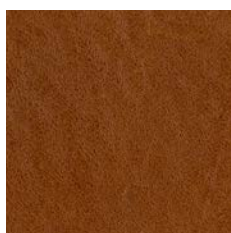

C3CU
Cuoio - Hide



C3T4
Testa di moro - Dark brown

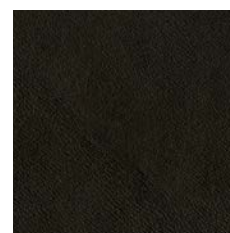

C3N5
Nero - Black

Plastica - Plastic

Polipropilene - Polypropylene

Cat. PPI

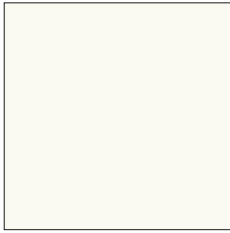

PB4
Bianco - White



PS2
Sabbia - Sand

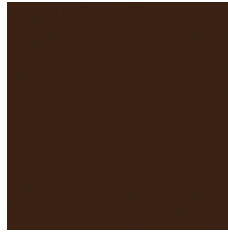

PM2
Marrone - Brown

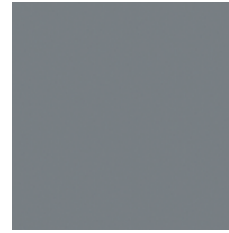

PGU
Grigio cielo - Sky grey

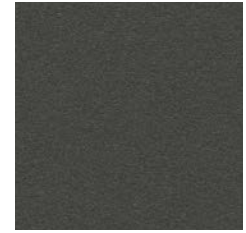

PGD
Grigio grafite - Graphite grey

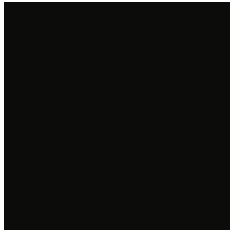

PN4
Nero - Black

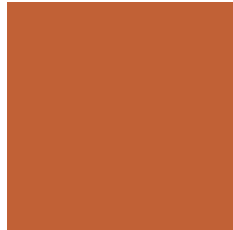

PT2
Terracotta



PRS
Rosso bulgaro - Bulgaro red



PRR
Rosso - Red



PO2
Giallo ocra - Ocher yellow

Plastica - Plastic

Baydur

Cat. PB1 - PB2



Cat. PB1

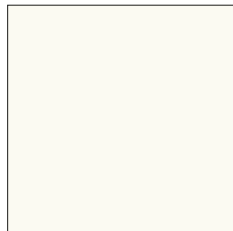

BB4
Bianco - White

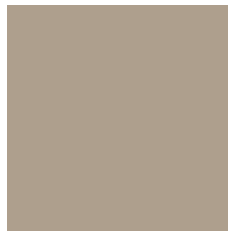

BGS
Grigio cenere - Ash grey

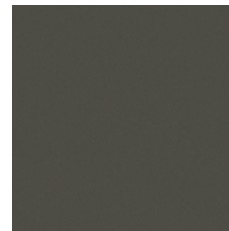

BGW
Grigio scuro - Dark grey

Cat. PB2



CGT
Cemento spatolato grigio chiaro - Light grey troweled concrete



CGW
Cemento spatolato grigio scuro - Dark grey troweled concrete

Metallo - Metal

Cat. M1 - M2

Cat. O1 - O2



Cat. M1

Cat. O1



BB
Bianco - White



EC
Corda - Sand

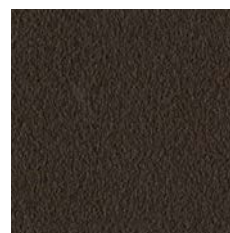

E6
Marrone - Brown



EG
Grafite - Graphite



EN
Nero - Black



E5*
Industrial

Cat. M2

Cat. O2



E9
Verde salvia - Sage green



EJ
Verde pino - Pine green

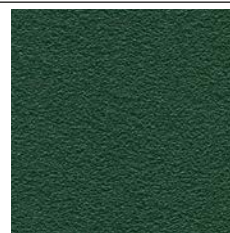

EL
Verde scuro - Dark green



ET
Grigio chiaro - Light grey



E3
Fango - Fango



E2
Bronzo - Bronze



EO
Azzurro - Light blue



EI
Blu oceano - Ocean blue



ES
Grigio cenere - Ash grey



EA
Arancio papaya - Papaya orange



E7
Giallo ocre - Ocher yellow



EO
Giallo oro - Golden yellow



E4
Giallo pastello - Pastel yellow

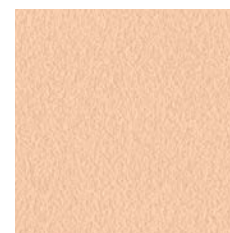

EB
Rosa cipria - Facepowder pink



ER
Rosso - Red



EQ
Rosso ciliegia - Cherry red



FP
Rosso bulgaro - Bulgaro red

* Non disponibile versione outdoor - Outdoor version not available

Cat. M3



CC
Cromo - Chrome

Cat. M4



DR
Oro rosa - Pink gold



DB
Bronzo dorato - Golden bronze



DG
Oro champagne - Champagne gold



DZ
Nichel nero - Black nickel



DY
Nichel nero opaco - Matt black nickel

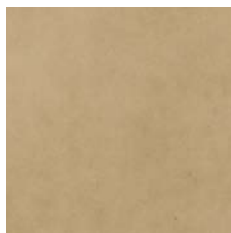

DC
Bronzo dorato opaco - Matt golden bronze

Cat. M5

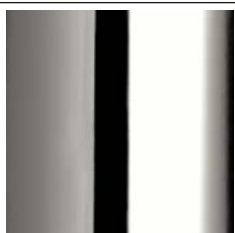

HL
Inox lucido - Polished stainless steel



HS
Inox satinato - Satin stainless steel

Nobilitato - Ennobled

Cat. HL1

Melaminico - Melamine

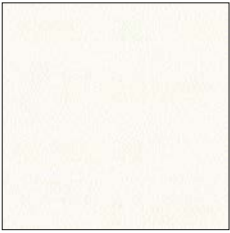

M01
Bianco - White

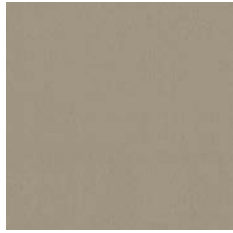

M07
Corda - Sand



M02
Grafite - Graphite



M04
Nero - Black

Laminato - Laminate

Cat. HL0



LRC
Rosso ciliegia - Cherry red



LRS
Rosso bulgaro - Bulgaro red



LBB
Blu - Blue



LS2
Sabbia - Sand



LGS
Grigio cenere - Ash grey

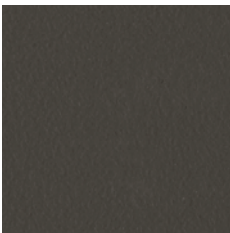

LGD
Grigio grafite - Graphite grey

Laminato - Laminate

Cat. HF1

Fenix



FX5
Bianco - White

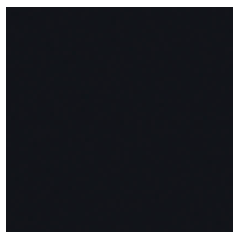

FX4
Nero - Black

Stratificato - Stratified

Cat. HH1 - HH2 - HH3



HPL

Cat. HH1



HB4
Bianco - White



HN4
Nero - Black

Cat. HH2



HC6
Grigio cemento -
Concrete grey



HGW
Grigio scuro - Dark grey



HC7
Corten

Cat. HH3



WB4
Bianco bordo bianco -
White and white edge

Legno - Wood

Cat. LM1

MDF laccato - Lacquered MDF

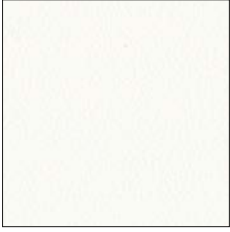

G05
Bianco - White



G07
Corda - Sand

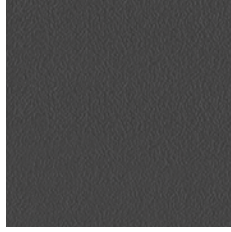

G02
Grigio grafite - Graphite grey



G41
Marrone - Brown

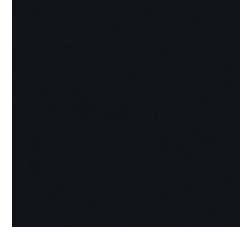

G04
Nero - Black

Legno - Wood

Cat. LF1

Frassino tinto - Lacquered ash



F40
Tinto naturale - Stained natural



F52
Tinto rovere naturale - Stained natural oak



F26
Tinto moro - Stained dark brown

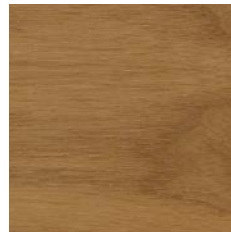

F24
Tinto noce fiammato - Stained flamed walnut

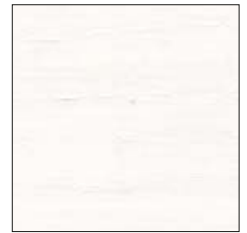

F05
Tinto bianco - Stained white

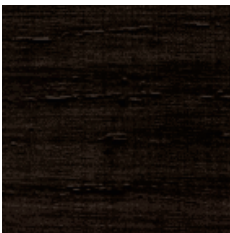

F04
Tinto nero - Stained black



F08
Tinto rosso - Stained red



F09
Tinto rosso ciliegia - Stained red cherry



F06
Tinto blu - Stained blue



F02
Tinto grigio - Stained grey



F03
Tinto grigio grafite - Stained graphite grey

Legno - Wood

Cat. LI1 - LI2

Impiallacciato tinto - Stained veneer

Cat. LI1

Essenza: frassino
Essence: ash



140
Tinto naturale - Stained natural



152
Tinto rovere naturale - Stained natural oak



126
Tinto moro - Stained dark brown



102
Tinto grigio - Stained grey

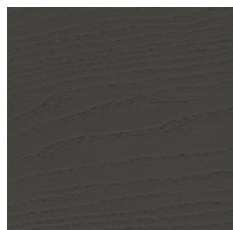

103
Tinto grigio grafite - Stained graphite grey



104
Tinto nero - Stained black



108
Tinto rosso - Stained red



109
Tinto rosso ciliegia - Stained red cherry

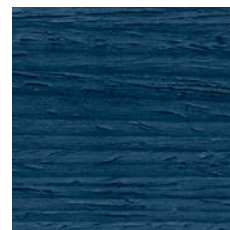

106
Tinto blu - Stained blue



105
Tinto bianco - Stained white

Cat. LI2

Essenza: noce
Essence: walnut

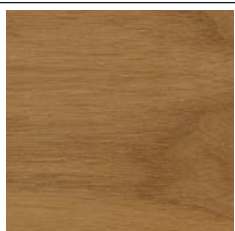

124
Fiammato - Flamed

Essenza: rovere
Essence: oak

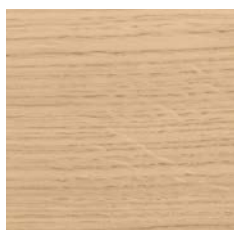

122
Naturale - Natural

Legno - Wood

Cat. LS1 - LS2

Massello - Solid wood

Cat. LS1

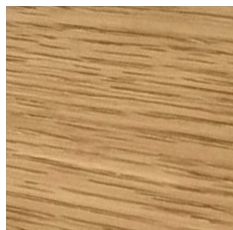

WRI
Rovere bordo dritto
Oak straight edge

Cat. LS2



WNI
Noce bordo corteccia
Walnut bark edge

Cat. GVB

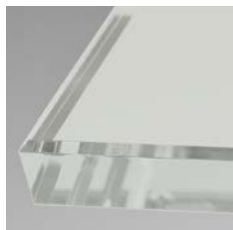

J01
Trasparente extra chiaro
Extra clear transparent

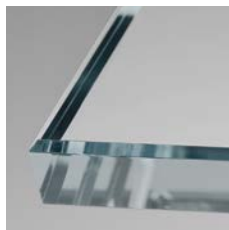

J21
Lucido extra chiaro bianco
Extra clear glossy white

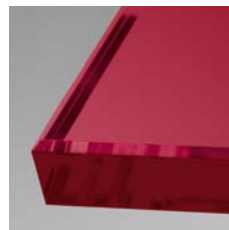

J25
Lucido extra chiaro rosso ciliegia
Extra clear glossy cherry red

Cat. GVC

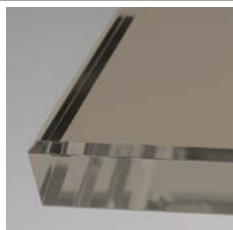

J32
Satinato antigraffio corda
Matt sand antiscratch

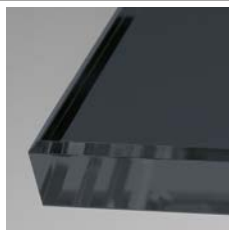

J31
Satinato antigraffio grafite
Matt graphite antiscratch

Cat. GVD

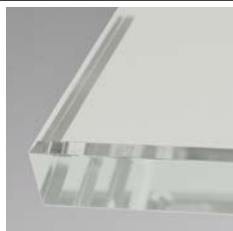

J41
Satinato antigraffio extra chiaro bianco
Extra clear matt white antiscratch

Cat. GVE

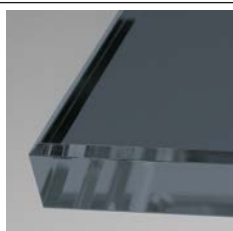

J05
Lucido fumè
Glossy fumè

Cat. GVH



J50
Bucciato fumè

Cristalceramica - Crystalceramic

Cat. GKA



K12
Savoia cemento - Savoia concrete



K01
Piombo - Lead



K11
Savoia antracite - Savoia charcoal



K31
Marmo opaco Emperador - Matt Emperador marble

Cristalceramica - Crystalceramic

Cat. GKB

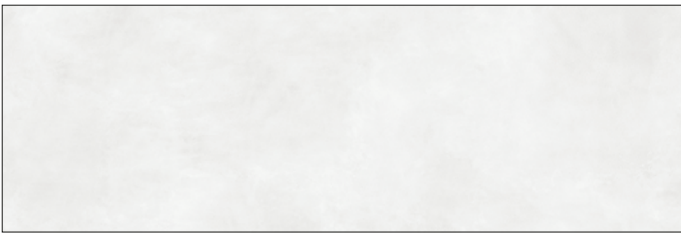

K24
Calce bianco - Lime white



K23
Corten

Cristalceramica - Crystalceramic

Cat. GMA



K32
Marmo lucido Calacatta - Glossy white Calacatta marble



K42
Marmo opaco Calacatta - Matt Calacatta marble



K33
Marmo lucido greco nero - Glossy Greek black marble



K46
Marmo opaco verde Tinos - Tinos green matt marble

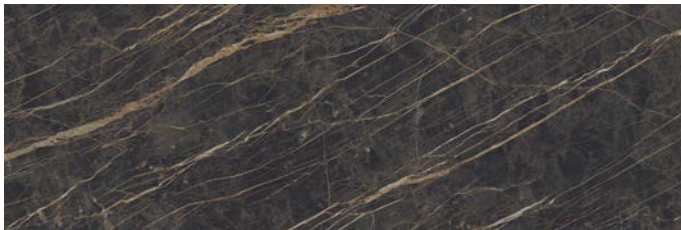

K35
Marmo lucido Noir Desir - Noir Desir glossy marble

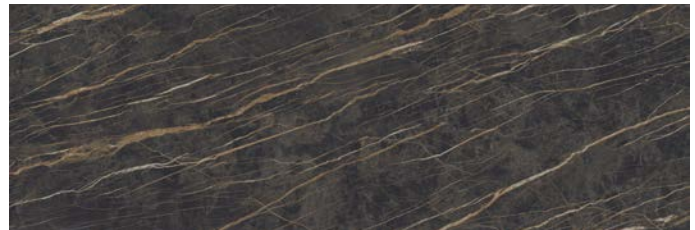

K45
Marmo opaco Noir Desir - Matt Noir Desir marble

Marmo - Marble

Cat. GMM



MB4
Bianco Calacatta Vagli - White Calacatta Vagli



MB2
Beige Travertino Romano

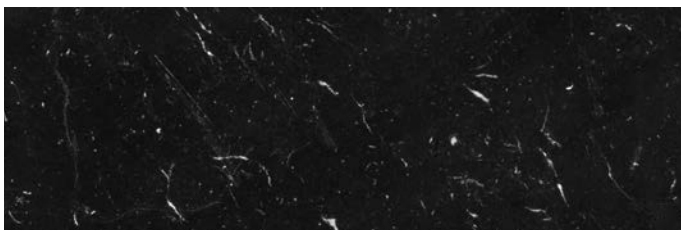

MN4
Nero Marquina

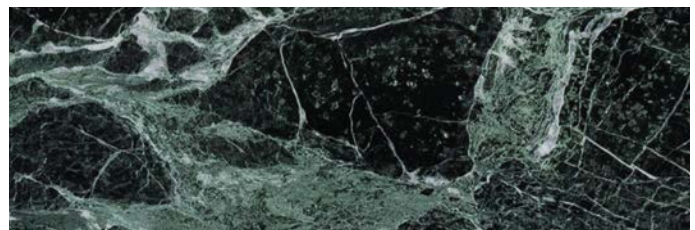

MVE
Verde Tinos - Green Tinos

Midj S.p.A. reserves the right to modify its equipment at any time without updating this manual. The colors shown are for guidance only and may be different than the reality.

All the priced listed on the price list are VAT excluded.

All the products which are inside Midj catalogues and not included in the current price list are to be consider out of production.

All rights reserved.



FSC® C146936
Il marchio della gestione forestale responsabile

Only the products that are identified as such on this document are FSC certified

price list 04/23

MIDJ S.p.A.
Via Madonna di Campagna2/A
33075 Cordovado (PN) - Italy
T +39.0434690122
F +39.0434690202
www.midj.com
info@midj.com

midj.com

