



*INDEX*

CONTRACT COLLECTION 2024

Produits conformes aux normes européennes EN 581-1, 581-2 et 581-3 :  
produits testés en sécurité, résistance et stabilité pour un usage domestique et collectif.

Complies with the European standards EN 581-1, 581-2 and 581-3:  
product tested for safety, resistance and stability for domestic and contract use.

Dimensions données à titre indicatif.  
Dimensions given as an indication.



Produit à destination intérieure  
For indoor use

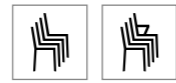

Empilable  
Stackable



Produit à destination extérieure  
Product for outdoor use



Positions réglables  
Adjustable positions



Déhoussable  
Removable



Positions réglables  
Adjustable positions



Tissu déperlant  
Water repellent fabrics

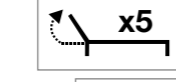

Positions réglables  
Adjustable positions



Lavage machine à 40°C  
Wash at 40°C



Positions réglables  
Adjustable positions



Nombre de places possibles  
Number of possible places



Patins réglables  
Adjustable bungs



Extensible  
Extendable



Rabattable  
Folding



Encastrable  
Embeddable



Changement de toile en 5 min  
Change of sling in 5 min

# CHAISES & FAUTEUILS

## CHAIRS & ARMCHAIRS

### RAMATUELLE 73'



### SUNSET CONFORT

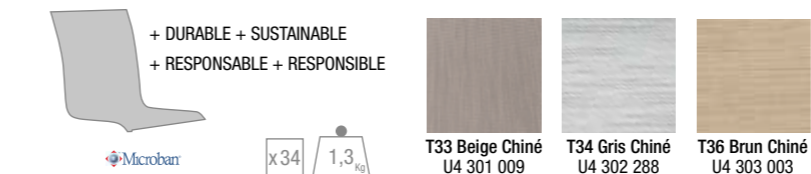

# SUNSET

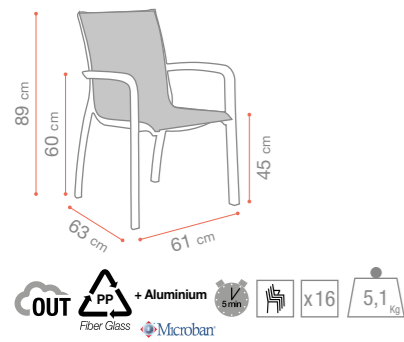

**Blanc Glacier**  
T28 Blanc  
49 015 096

**Blanc Glacier**  
T33 Beige Chiné  
49 027 096

**Blanc Glacier**  
T35 Turquoise Chiné  
49 031 096

**Gris Platinium**  
T30 Gris  
49 021 289

**Gris Platinium**  
T33 Beige Chiné  
49 027 289



**Noir Volcanique**  
T29 Noir  
49 008 288

**Noir Volcanique**  
T30 Gris  
49 021 288

**Noir Volcanique**  
T34 Gris Chiné  
49 028 288

**Bronze Fusion**  
T31 Cognac  
49 026 599

**Bronze Fusion**  
T36 Brun Chiné  
49 037 599

+ DURABLE + SUSTAINABLE

+ RESPONSABLE  
+ RESPONSIBLE

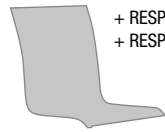

x36 1,3 kg



**T28 Blanc**  
43 012 096

**T29 Noir**  
43 014 288

**T30 Gris**  
43 015 289

**T31 Cognac**  
43 013 599

**T33 Beige Chiné**  
43 030 009

**T34 Gris Chiné**  
43 031 288

**T35 Turquoise Chiné**  
43 032 096

**T36 Brun Chiné**  
43 033 003

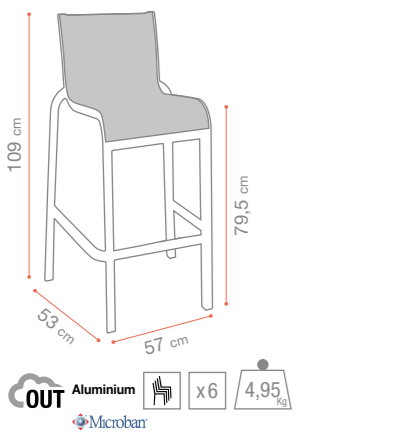

**Blanc Glacier**  
T28 Blanc  
34 300 096

**Gris Platinium**  
T30 Gris  
34 301 289

**Noir Volcanique**  
T34 Gris Chiné  
R8 401 288

**Bronze Fusion**  
T31 Cognac  
34 302 599

# CANNES

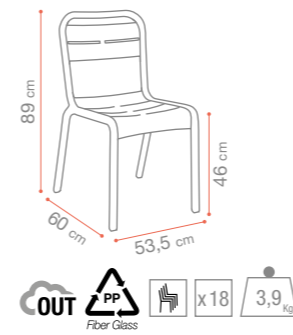

**Havane**  
U2 801 011

**Anthracite**  
U2 801 002

**Terracotta**  
U2 801 814

**Jaune Indien**  
U2 801 737

**Vert Tender**  
U2 801 736

**Bleu Minéral**  
U2 801 784

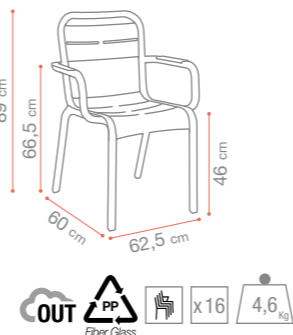

**Havane**  
U2 901 011

**Anthracite**  
U2 901 002

**Terracotta**  
U2 901 814

**Jaune Indien**  
U2 901 737

**Vert Tender**  
U2 901 736

**Bleu Minéral**  
U2 901 784



**Havane**  
U6 101 011

**Anthracite**  
U6 101 002

**Terracotta**  
U6 101 814

# ORONET 17



Nettoyant Textylene/PVC  
textyle cleanser

47 039 031

# MOON

# SLAT NEW

# VÉGÉTAL

# TULIPE

# FACTORY

## SUNDAY

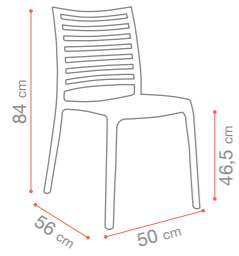

Blanc Glacier  
49 042 096



Anthracite  
49 042 002



Lin  
49 042 581



Bleu Denim  
49 042 680



Vert Tender  
49 042 736\*



Rouge Bossa Nova  
49 042 712

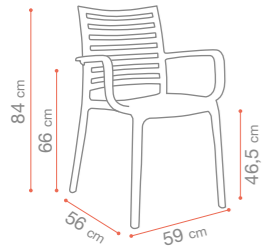

Blanc Glacier  
49 109 096



Anthracite  
49 109 002



Lin  
49 109 581



Bleu Denim  
49 109 680



Vert Tender  
49 109 736\*



Rouge Bossa Nova  
49 109 712

## CLIP

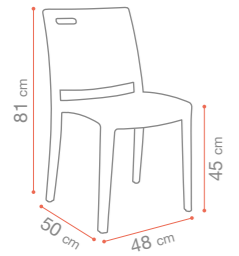

Blanc Glacier  
35 200 096



Lin  
35 200 581



Rouge Archi  
35 200 202



Vert Cactus  
35 200 282



Jaune Indien  
35 200 737

## MILTON

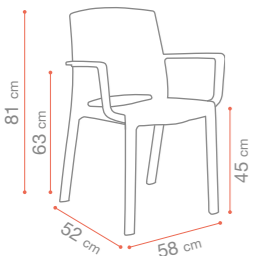

Blanc Glacier  
49 009 096



Anthracite  
49 009 002



Lin  
49 009 581



Taupe  
49 009 181



Bleu Ether  
49 009 711\*

## MIAMI BISTROT

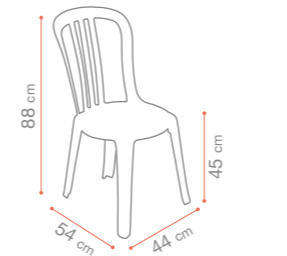

Blanc  
49 150 004



Noir  
35 000 317



Anthracite  
49 150 002



Lin  
49 150 581



Taupe  
49 150 181



Vert Amazonie  
35 000 378



Acajou  
35 000 367\*



Vert Tender  
49 150 736



Rouge Bossa Nova  
49 150 712



Jaune Indien  
49 150 737\*

## MIAMI PLIANTE

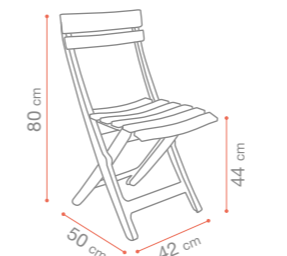

Blanc  
49 036 004



Anthracite  
49 036 002



Lin  
49 036 581



Taupe  
49 036 181



Vert Tender  
49 036 736



Rouge Bossa Nova  
49 036 712



Jaune Indien  
49 036 737



Forest Green  
03 101 818



Bleu Minéral  
03 101 784

## PALAO

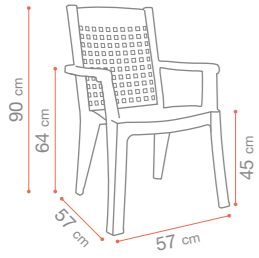

**Anthracite**  
49 473 002



## MIAMI CLUB

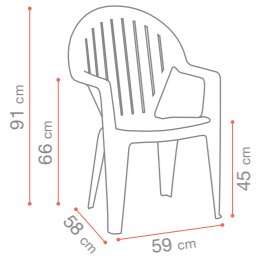

**Blanc**  
49 504 004



**Anthracite**  
49 504 002



**Taupe**  
49 504 181



**Vert Amazonie**  
04 601 078



## MADRAS

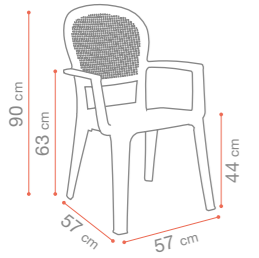

**Blanc**  
46 131 904



**Anthracite**  
01 601 002



**Vert Amazonie**  
46 131 978



## MIAMI

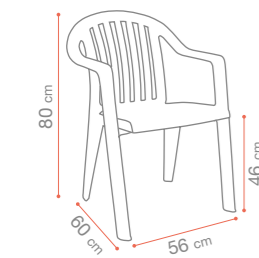

**Blanc**  
49 023 004



**Anthracite**  
00 501 002



**Taupe**  
00 501 181



**Vert Amazonie**  
49 023 078



## DENVER

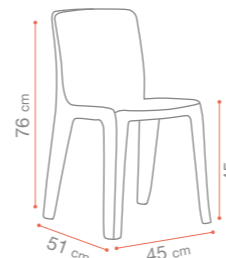

**M2 Anthracite**  
33 600 002



**M2 Bordeaux**  
33 600 027



**M2 Beige**  
33 400 003



**M2 Gris**  
33 600 009



**M4 Beige**  
33 510 003

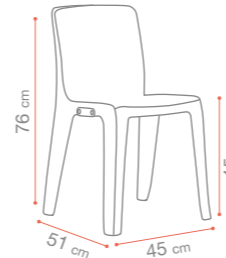

**M2 Anthracite**  
39 201 002



**M2 Bordeaux**  
39 201 027



**M2 Beige**  
39 110 003



**M2 Gris**  
39 201 009



**Barre d'attache**  
73 221 131



**Chariot**  
36 110 231

## CAMPUS

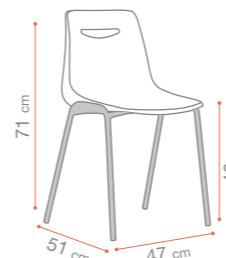

**M2 Noir**  
33 846 017 \*



**M2 Rouge**  
33 846 202 \*



**M2 Beige**  
33 846 003 \*



**M2 Acajou**  
33 846 067 \*



**M2 Bleu**  
33 846 005 \*

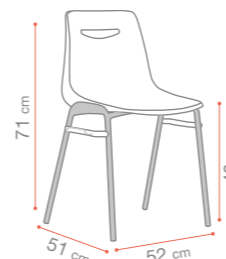

**M2 Noir**  
39 210 017 \*



**M2 Rouge**  
39 210 202 \*



**M2 Beige**  
39 210 003 \*



**M2 Acajou**  
39 210 067 \*



**M2 Bleu**  
39 210 005 \*



**Barre d'attache**  
73 201 831 \*

# TABLES

## RAMATUELLE 73'



Crème Absolute  
S7 501 710



Gris Pavement  
S7 501 713

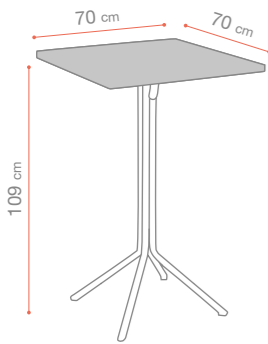

Crème Absolute  
S7 601 710



Gris Pavement  
S7 601 713 \*

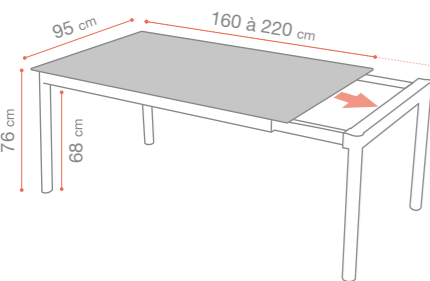
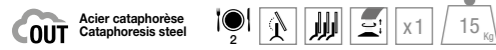

**NEW**



Gris Cryptic / Gris Pavement  
S8 002 713



Brun Cryptic / Grège  
S8 002 821

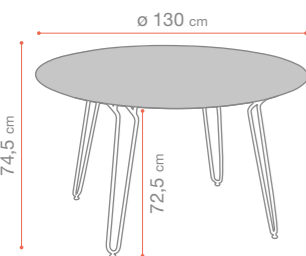

Naturale / Crème Absolute  
52 364 710



Naturale / Bleu Ether  
52 364 711



Nero / Rouge Bossa Nova  
52 364 712



Nero / Gris Pavement  
52 364 713

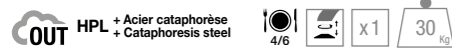

## SUNSET

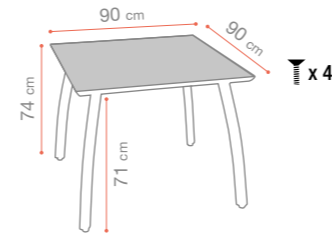

Blanc - Blanc Glacier  
R4 101 096 + 55 729 096



Gris Cryptic - Gris Platinium  
R4 101 788 + 55 729 289



Gris Cryptic- Noir volcanique  
R4 101 788 + 55 729 288



Brun Cryptic + Bronze Fusion  
R4 101 789 + 55 729 599

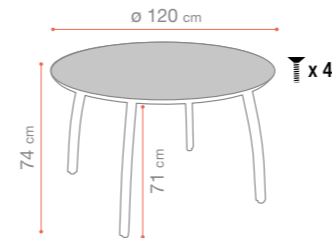
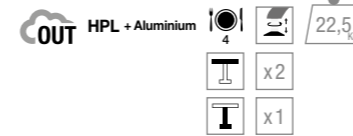

Blanc - Blanc Glacier  
R5 001 096 + 55 734 096



Gris Cryptic - Gris Platinium  
R5 001 788 + 55 734 289



Gris Cryptic- Noir volcanique  
R5 001 788 + 55 734 288



Brun Cryptic + Bronze Fusion  
R5 001 789 + 55 734 599

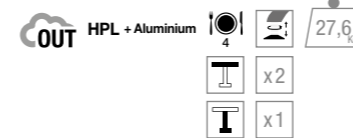

## CANNES

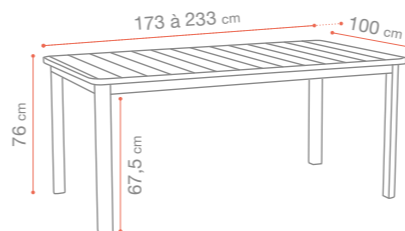

Anthracite  
U3 801 002



Havane  
U3 801 011





Anthracite - Gris Cryptic  
U3 901 002 + U5 301 788



Anthracite - Walnut  
U3 901 002 + U5 301 722



Havane - Gris Cryptic  
U3 901 011 + U5 301 788



Havane - Walnut  
U3 901 011 + U5 301 722

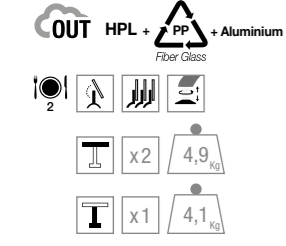

Terracotta - Gris Cryptic  
U3 901 814 + U5 301 788



Terracotta - Walnut  
U3 901 814 + U5 301 722

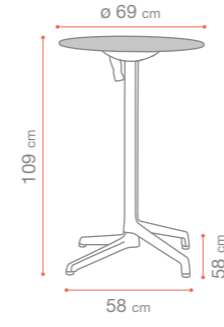

Anthracite - Gris Cryptic  
U4 001 002 + U5 301 788



Anthracite - Walnut  
U4 001 002 + U5 301 722



Havane - Gris Cryptic  
U4 001 011 + U5 301 788



Havane - Walnut  
U4 001 011 + U5 301 722

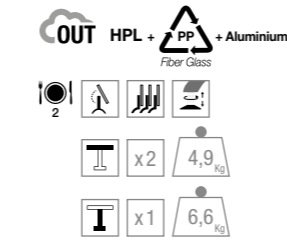

Terracotta - Gris Cryptic  
U4 001 814 + U5 301 788



Terracotta - Walnut  
U4 001 814 + U5 301 722

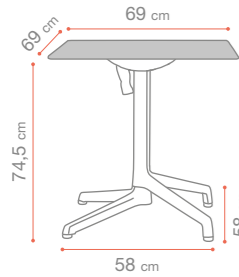

Anthracite - Gris Cryptic  
U3 901 002 + U4 901 788



Anthracite - Walnut  
U3 901 002 + U4 901 722



Havane - Gris Cryptic  
U3 901 011 + U4 901 788



Havane - Walnut  
U3 901 011 + U4 901 722

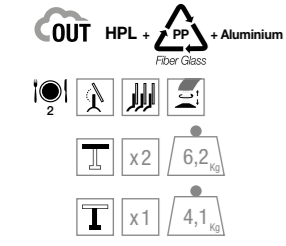

Terracotta - Gris Cryptic  
U3 901 814 + U4 901 788



Terracotta - Walnut  
U3 901 814 + U4 901 722

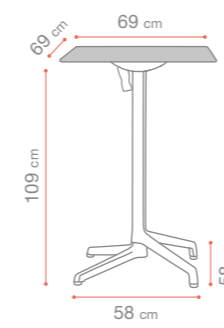

Anthracite - Gris Cryptic  
U4 001 002 + U4 901 788



Anthracite - Walnut  
U4 001 002 + U4 901 722



Havane - Gris Cryptic  
U4 001 011 + U4 901 788



Havane - Walnut  
U4 001 011 + U4 901 722

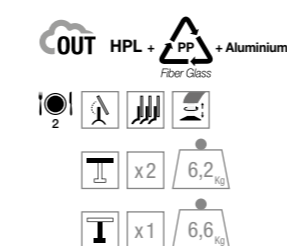

Terracotta - Gris Cryptic  
U4 001 814 + U4 901 788



Terracotta - Walnut  
U4 001 814 + U4 901 722

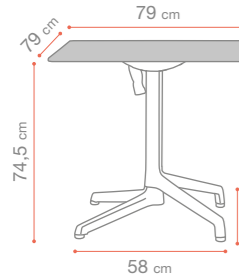

Anthracite - Gris Cryptic  
U3 901 002 + U5 001 788



Anthracite - Walnut  
U3 901 002 + U5 001 722



Havane - Gris Cryptic  
U3 901 011 + U5 001 788



Havane - Walnut  
U3 901 011 + U5 001 722

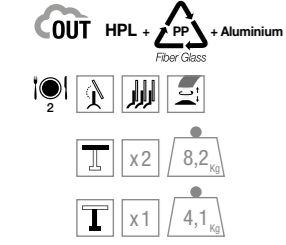

Terracotta - Gris Cryptic  
U3 901 814 + U5 001 788



Terracotta - Walnut  
U3 901 814 + U5 001 722

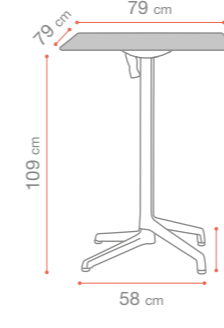

Anthracite - Gris Cryptic  
U4 001 002 + U5 001 788



Anthracite - Walnut  
U4 001 002 + U5 001 722



Havane - Gris Cryptic  
U4 001 011 + U5 001 788



Havane - Walnut  
U4 001 011 + U5 001 722

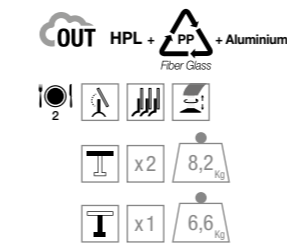

Terracotta - Gris Cryptic  
U4 001 814 + U5 001 788



Terracotta - Walnut  
U4 001 814 + U5 001 722



# CANNES NEW

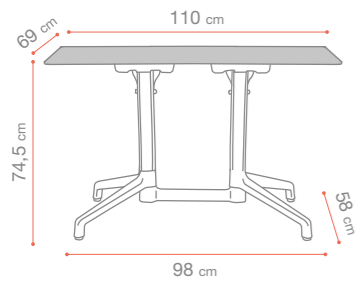

**Anthracite - Gris Cryptic**  
U4 101 002 + U5 101 788



**Anthracite - Walnut**  
U4 101 002 + U5 101 722



**Havane - Gris Cryptic**  
U4 101 011 + U5 101 788



**Terracotta - Gris Cryptic**  
U4 101 814 + U5 101 788



**Terracotta - Walnut**  
U4 101 814 + U5 101 722



**Havane - Walnut**  
U4 101 011 + U5 101 722

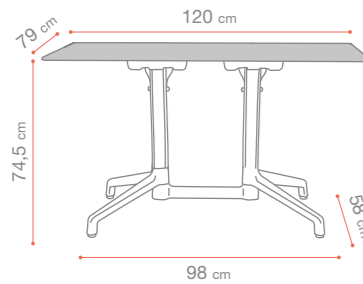
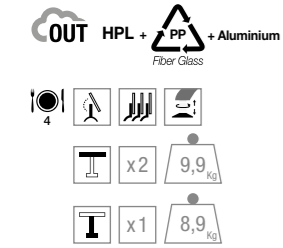

**Anthracite - Gris Cryptic**  
U4 101 002 + U5 201 788



**Anthracite - Walnut**  
U4 101 002 + U5 201 722



**Havane - Gris Cryptic**  
U4 101 011 + U5 201 788



**Terracotta - Gris Cryptic**  
U4 101 814 + U5 201 788



**Terracotta - Walnut**  
U4 101 814 + U5 201 722



**Havane - Walnut**  
U4 101 011 + U5 201 722

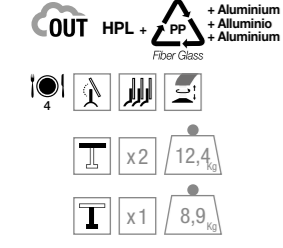

# GREGGIA

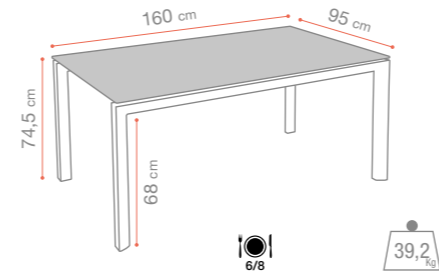

**Gris Platinum 160**  
S7 301 289

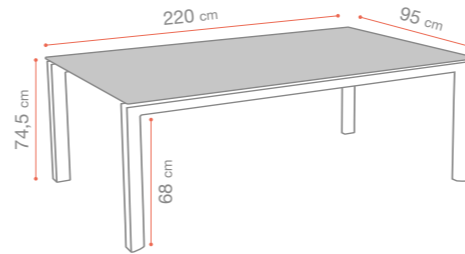

**Gris Platinum 220**  
S7 401 289



# ALPHA

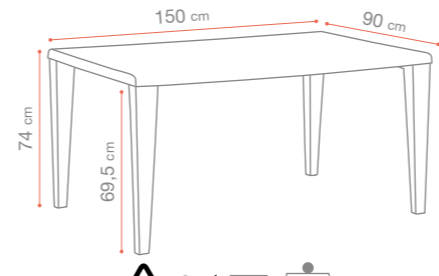

**Blanc Glacier**  
52 352 096



**Anthracite**  
52 352 002



**Lin**  
52 352 581



# MIAMI\*

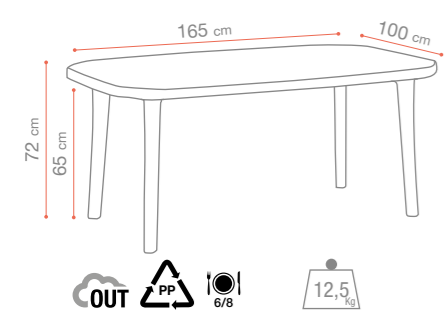

Blanc  
52 260 004 \*



Vert Amazonie  
52 260 078 \*



Taupe  
52 072 181 \*

x1

x6



# TABLE ECOFIX

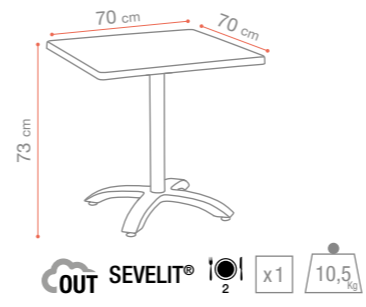

Blanc  
56 000 004



Anthracite  
56 000 002



Taupe  
56 000 181



# PALMA

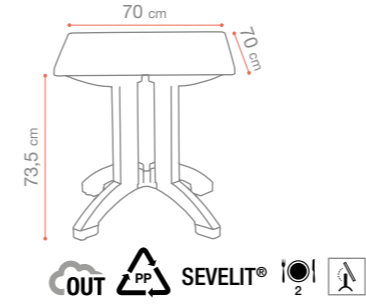

Anthracite  
56 951 002



# VEGA

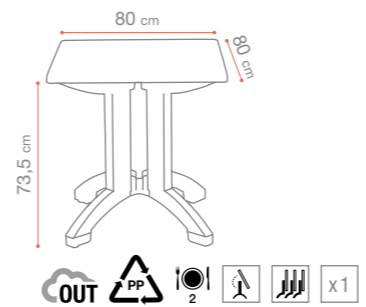

Anthracite  
23 401 002 \*



# SUN

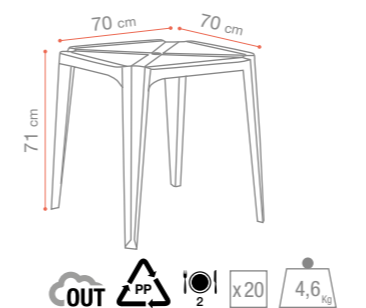

Blanc  
55 902 004



Anthracite  
55 902 002



Taupe  
55 902 181



Vert Amazonie  
55 902 078



# PIEDS - LEGS

X2.O **NEW**



**Anthracite**  
U3 901 002

**Gris Platinum**  
U3 901 289

**Havane**  
U3 901 011

**Terracotta**  
U3 901 814

OUT + Aluminium x1 **4,1 kg**  
Plateaux 70x70 Ø 70  
Piani tavoli 80x80 Ø 80  
Platten 80x80 Ø 80



**Anthracite**  
U4 001 002

**Gris Platinum**  
U4 001 289

**Havane**  
U4 001 011

**Terracotta**  
U4 001 814

OUT + Aluminium x1 **6,6 kg**  
Plateaux 70x70 Ø 70  
Piani tavoli 80x80 Ø 80  
Platten 80x80 Ø 80



**Anthracite**  
U4 101 002

**Gris Platinum**  
U4 101 289

OUT + Aluminium x1 **8,9 kg**  
Plateaux 110x70  
Piani tavoli 120x80  
Platten 120x80



**Havance**  
U4 101 011

**Terracotta**  
U4 101 814

# XONE



**Aluminium**  
55 721 009

**Noir**  
55 721 017

OUT + Aluminium x1 **7,5 kg**  
Plateaux 60x60 Ø 60  
Piani tavoli 70x70 Ø 70  
Platten 80x80 Ø 80



**Aluminium**  
55 723 009

**Noir**  
55 723 017

OUT + Aluminium x1 **7,6 kg**  
Plateaux 80x80 Ø 80  
Piani tavoli 90x90 Ø 90  
Platten 90x90 Ø 90



**Aluminium**  
55 731 009

**Noir**  
55 731 017

OUT + Aluminium x1 **8,7 kg**  
Plateaux 60x60 Ø 60  
Piani tavoli 70x70 Ø 70  
Platten 80x80 Ø 80



**Aluminium**  
55 722 009

**Noir**  
55 722 017

OUT + Aluminium x1 **14 kg**  
Plateaux 110x70  
Piani tavoli 120x80  
Platten 120x80

# QUATTRO NEW

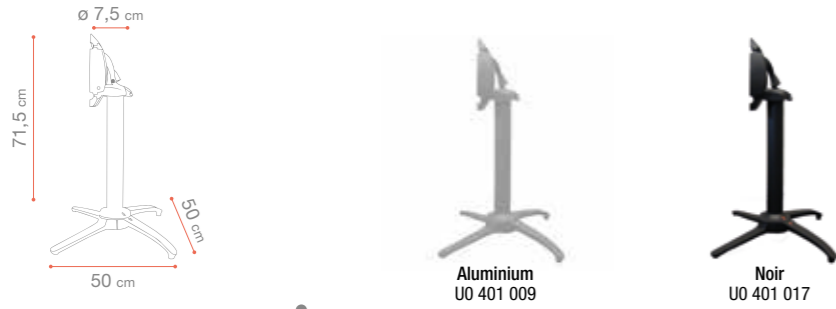

**OUT** + Aluminium **x1** **5,2** kg  
 Plateaux 60x60 Ø 60  
 Piani tavoli 70x70 Ø 70  
 Platten 80x80 Ø 80



**OUT** + Aluminium **x1** **5,8** kg  
 Plateaux 60x60 Ø 60  
 Piani tavoli 70x70 Ø 70  
 Platten 80x80 Ø 80

# TETRA INOX

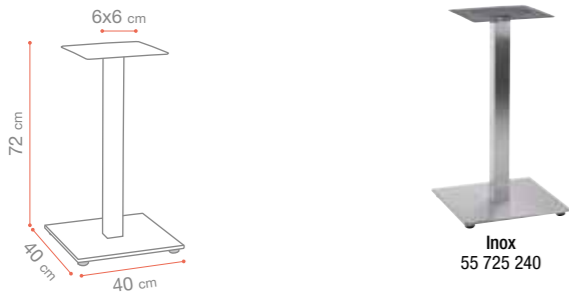

**IN** **OUT** **x1** **17,5** kg  
 Plateaux 70x70 Ø 70  
 Piani tavoli 80x80 Ø 80  
 Platten

# DOMOS



**IN** **OUT** **x1** **20** kg  
 Plateaux 70x70 Ø 70  
 Piani tavoli 80x80 Ø 80  
 Platten

# ECOFIX



**IN** **OUT** **x1** **7,6** kg  
 Plateaux 70x70 Ø 70  
 Piani tavoli 80x80 Ø 80  
 Platten



**IN** **OUT** **x1** **8,8** kg  
 Plateaux 110x70  
 Piani tavoli 120x80  
 Platten

	OUT						EXTERIOLIT (RAILS)		IN		
	PLATEAUX HPL (RAILS) / HPL TABLE TOPS (RAILS)								COLOR TOP	LAMIDUR	
	Ø60	60x70	69x69	80x80	110x69	120x80	68x68	80x80	70x70	68x68	80x80
X2.0		•	•	•			•	•	•	•	•
X2.0 HAUT		•	•	•			•	•	•	•	•
X2.0 DOUBLE					•	•					
XONE	•	•	•	•			•	•	•	•	•
XONE XL				•				•			•
XONE HAUT	•	•	•	•			•	•	•	•	•
XONE DOUBLE					•	•					
QUATTRO	•	•	•	•			•	•	•	•	•
QUATTRO HAUT	•	•	•	•			•	•	•	•	•
ECOFIX SIMPLE	•	•	•	•			•	•	•	•	•
ECOFIX DOUBLE					•	•					
TETRA	•	•	•	•			•	•	•	•	•
DOMOS	•	•	•	•			•	•	•	•	•

# PLATEAUX - TABLE TOPS

## PLATEAUX HPL (RAILS) - HPL TABLE TOPS (RAILS)



	BLANC TOUCH *	NATURAL TOUCH	WALNUT TOUCH	SWEDEN TOUCH *	VULCANO TOUCH	BÉTON TOUCH	MARBRE KANDIA *
	Cœur Noir Black core	Cœur Brun Brown core	Cœur Brun Brown core	Cœur Brun Brown core	Cœur Noir Black core	Cœur Noir Black core	Cœur Noir Black core
ø 60 cm	-	56 979 723	56 979 722	56 345 076	56 979 051	56 979 174	-
	x1	4,3 kg					
60 x 70 cm	56 977 004 *	56 961 723	56 961 722	-	56 961 051	56 961 174	-
	x2	6,5 kg					
70 x 70 cm	56 940 004 *	56 962 723 *	-	56 940 076 *	56 962 051 *	56 962 174 *	-
69 x 69 cm	17 101 004	17 101 723	17 101 722	17 101 076	17 101 051	17 101 174	17 101 790
	x2	7,4 kg					
80 x 80 cm	56 950 004	56 978 723	56 978 722	56 950 076	56 978 051	56 978 174	56 978 790
	x2	9,4 kg					
110 x 70 cm	56 957 004 *	56 958 723 *	56 958 722 *	56 957 076 *	-	56 958 174 *	56 958 790 *
110 x 69 cm	-	27 701 723	27 701 722	27 701 076	27 701 051	27 701 174	-
	x1	11 kg					
120 x 80 cm	56 887 004	56 959 723	56 959 722	56 887 076	56 959 051	56 959 174	56 959 790
	x1	13,9 kg					

## COLOR TOP



					
70 cm	Apache U2 601 786	Gypsy Rouge U2 601 774	Jungle Wood Full U2 601 771	Jungle Wood U2 601 785	Zebrure Noir U2 601 775
					
x2	Bois Naturel U2 601 777	Bois Oxydé U2 601 787	Patchwork U2 601 772	Marbre U2 601 773	Mesh Concrete Bronze U2 601 776
	7,75 kg				

# PLATEAUX HPL CANNES (INSERTS) - CANNES HPL TABLE TOPS (INSERTS)









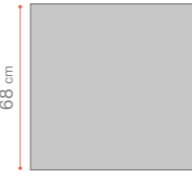

## COMPATIBLE X-ONE & X2 ONLY

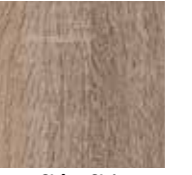
	WALNUT TOUCH	GRIS CRYPTIC
	Cœur Brun Brown core	Cœur Noir Black core
ø 69 cm	U5 301 722	U5 301 788
	x2	4,3 kg
69 x 69 cm	U4 901 722	U4 901 788
	x2	7,4 kg
69 x 110 cm	U5 101 722	U5 101 788
	x2	7,4 kg
79 x 79 cm	U5 001 722	U5 001 788
	x2	9,4 kg
120 x 79 cm	U5 201 722	U5 201 788
	x2	13,9 kg

## EXTERIOLIT



				
68 cm	Gris Béton S8 401 247	80 cm	Chêne Clair S8 501 088	Gris Béton S8 501 247
				
x1	8,2 kg	x1	10,6 kg	

## LAMIDUR



					
68 cm	Jurassic S7 801 738	Chêne Clair S7 801 739	80 cm	Jurassic S7 901 738	Chêne Clair S7 901 739
					
x1	8,7 kg		x1	12 kg	

# BAIN DE SOLEIL - SUNLOUNGERS

## SUNSET GREEN EDITION **NEW**

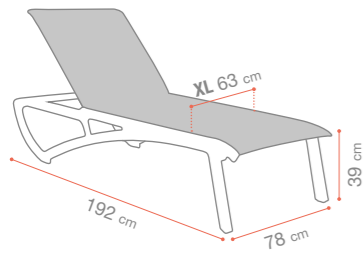

Lichen / T50 coton  
Q8 601 852

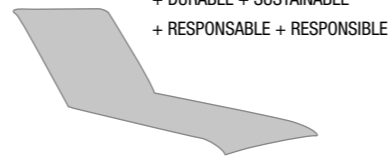

Toile T50 Coton  
R5 702 852

## SUNSET

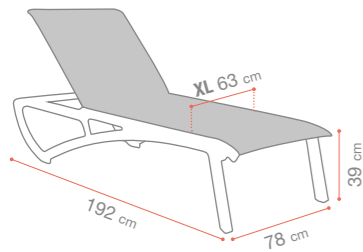

Gris Platinum / T30 Gris  
47 034 289



Gris Platinum / T33 Beige chiné  
47 045 289



Bronze Fusion / T31 Cognac  
47 035 599



Bronze Fusion / T36 Brun chiné  
47 049 599



Blanc Glacier / T28 Blanc  
47 033 096



Blanc Glacier / T33 Beige chiné  
47 044 096



Blanc Glacier / T35 Turquoise chiné  
47 048 096



Blanc Glacier / T41 Bleu Madras  
Q8 604 096



Noir volcanique / T30 Gris  
47 034 288



Noir volcanique / T34 Gris chiné  
47 047 288

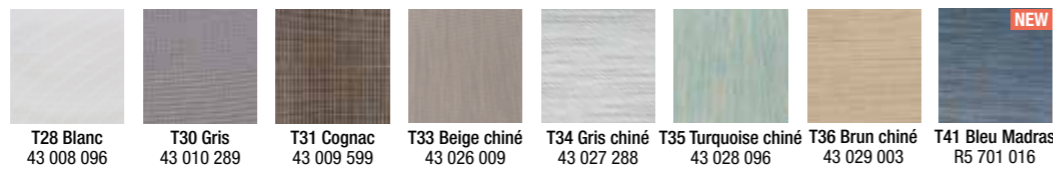
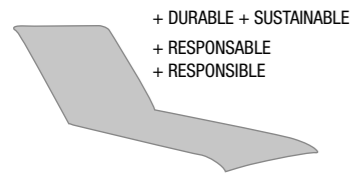

T28 Blanc 43 008 096  
T30 Gris 43 010 289  
T31 Cognac 43 009 599  
T33 Beige chiné 43 026 009  
T34 Gris chiné 43 027 288  
T35 Turquoise chiné 43 028 096  
T36 Brun chiné 43 029 003  
T41 Bleu Madras R5 701 016

## SUNSET CONFORT

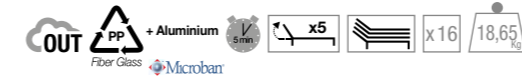
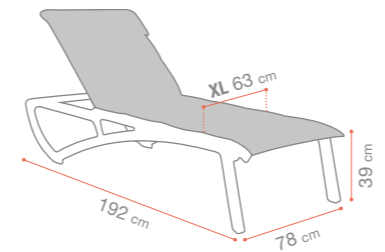

Blanc Glacier / T33 Beige chiné  
R3 701 096



Blanc Glacier / T41 Bleu Madras  
R3 707 096



Gris Platinum / T33 Beige chiné  
R3 702 289



Bronze Fusion / T36 Brun chiné  
R3 703 599



Noir Volcanique / T34 Gris chiné  
R3 706 288

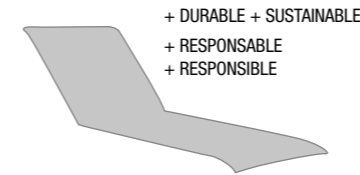

T33 Beige chiné U4 201 009  
T34 Gris chiné U4 202 288  
T36 Brun chiné U4 203 003  
T41 Bleu Madras U4 204 016

## SUNSET & SUNSET CONFORT

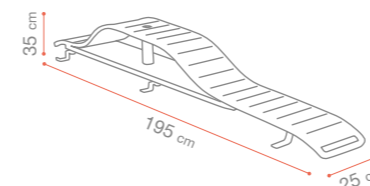

Blanc Glacier  
53 005 096



Gris Platinum  
53 005 289



Noir volcanique  
53 005 288\*



Bronze Fusion  
53 005 599

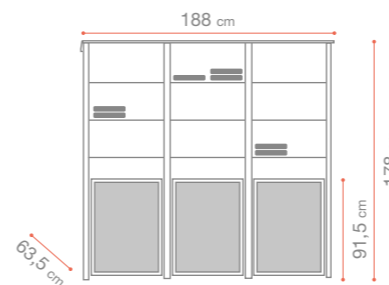

Gris Platinum / T30 Gris  
U1 201 289



Bronze Fusion / T36 Brun chiné  
U1 201 599



Panière  
U3 101 017

## BALI CONFORT



## BALI



## JAMAÏCA BEACH



## MIAMI



## ORONET 17



Nettoyant Textylène/PVC  
textyle cleanser

47 039 031

# REPOS - LOUNGE

## CANNES **NEW**

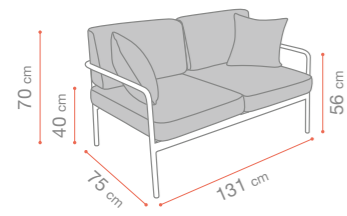

Havane/Gris chiné  
U6 901 011

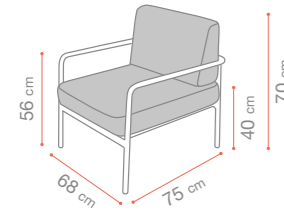

Terracotta/Gris Chiné  
U6 901 814

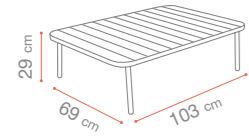

## YÉYÉ 72'

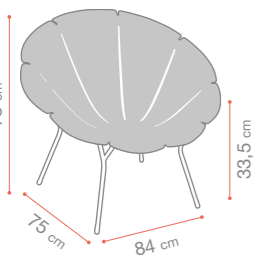

Blanc  
49 178 004 \*

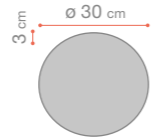

sunbrella



Jaune Chiné  
47 132 031 \*



## SUNSET & SUNSET CONFORT



x1 0,9 kg



Blanc Glacier  
CT 416 096



Gris Platinum  
CT 416 289



Noir Volcanique  
CT 416 288



Bronze Fusion  
CT 416 599

## SUNSET CONFORT

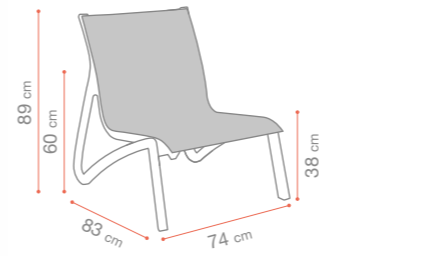

Blanc Glacier / T33 Beige Chiné  
U2 402 096



Gris Platinum / T33 Beige Chiné  
U2 402 289



Noir Volcanique / T34 Gris Chiné  
U2 401 288



Bronze Fusion / T36 Brun Chiné  
U2 403 599

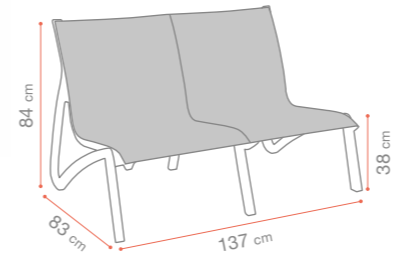

Blanc Glacier / T33 Beige Chiné  
U2 502 096



Gris Platinum / T33 Beige Chiné  
U2 502 289



Noir Volcanique / T34 Gris Chiné  
U2 501 288



Bronze Fusion / T36 Brun Chiné  
U2 503 599

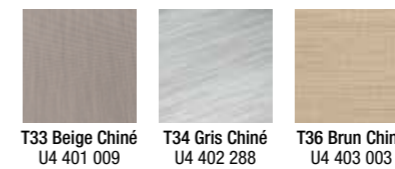
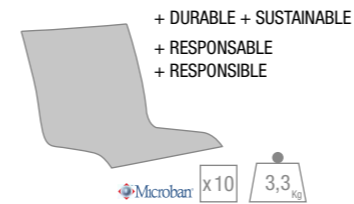

T33 Beige Chiné  
U4 401 009

T34 Gris Chiné  
U4 402 288

T36 Brun Chiné  
U4 403 003



# SUNSET

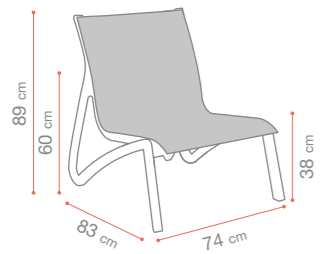

Blanc Glacier / T28 Blanc  
58 002 096



Blanc Glacier / T33 Beige Chiné  
58 007 096



Blanc Glacier / T35 Turquoise Chiné  
58 008 096



Gris Platiniun / T30 Gris  
58 002 289



Gris Platiniun / T33 Beige Chiné  
58 007 289



Noir Volcanique / T30 Gris  
58 003 288



Noir Volcanique / T34 Gris Chiné  
58 009 288



Bronze Fusion / T31 Cognac  
58 002 599



Bronze Fusion / T36 Brun Chiné  
58 010 599

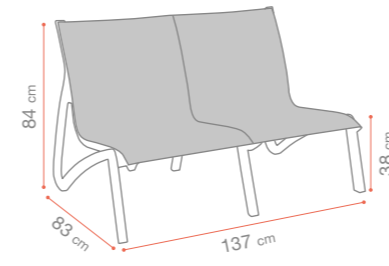

Blanc Glacier / T28 Blanc  
58 001 096



Blanc Glacier / T33 Beige Chiné  
R4 501 096



Blanc Glacier / T35 Turquoise Chiné  
R4 502 096



Gris Platiniun / T30 Gris  
58 001 289



Gris Platiniun / T33 Beige Chiné  
R4 501 289



Noir Volcanique / T30 Gris  
58 004 288



Noir Volcanique / T34 Gris Chiné  
R4 503 288



Bronze Fusion / T31 Cognac  
58 001 599



Bronze Fusion / T36 Brun Chiné  
R4 504 599

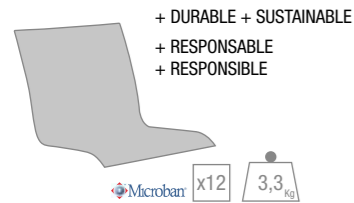

T28 Blanc 43 020 096  
T30 Gris 43 021 289  
T31 Cognac 43 025 599  
T33 Beige Chiné R8 202 009  
T34 Gris Chiné R8 203 288  
T35 Turquoise Chiné R8 204 096  
T36 Brun Chiné R8 201 003

## SUNSET



Blanc Glacier / T28 Blanc  
R7 705 096



Blanc Glacier / T33 Beige Chiné  
R7 709 096 \*



Blanc Glacier / T35 Turquoise Chiné  
R7 707 096 \*



Bronze Fusion / T36 Brun Chiné  
R7 708 599



Gris Platiniu / T30 Gris  
R7 706 289



Gris Platiniu / T33 Beige Chiné  
R7 709 289



Noir Volcanique / T30 Gris  
R7 706 288



Noir Volcanique / T34 Gris Chiné  
R7 710 288

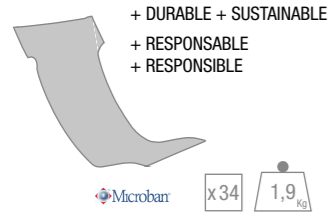

T28 Blanc  
43 022 096



T30 Gris  
43 023 289



T33 Beige Chiné  
R8 104 009



T35 Turquoise Chiné  
R8 102 096



T36 Brun Chiné  
R8 101 003



T34 Gris Chiné  
R8 103 288

## SUNSET & SUNSET CONFORT

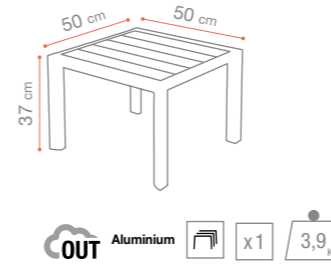

OUT Aluminium x1 3,9 kg



Blanc Glacier  
53 010 096



Gris Platiniu  
53 010 289



Noir Volcanique  
53 010 288



Bronze Fusion  
53 010 599



Vert Lichen  
R5 301 852

NEW

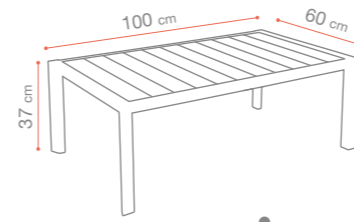

OUT Aluminium x1 7 kg



Blanc Glacier  
53 004 096



Gris Platiniu  
53 004 289



Noir Volcanique  
53 004 288



Bronze Fusion  
53 004 599

## WESTPORT

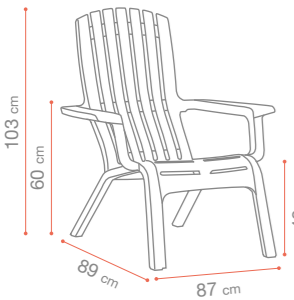

Blanc  
U2 701 004



Taupe  
U2 701 181



## ORONET 17



Nettoyant Textylene/PVC  
textyle cleanser

47 039 031

## MIAMI

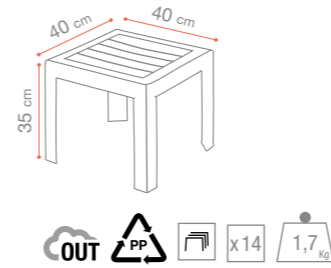

OUT PP x14 1,7 kg



Blanc  
ML 756 004



Anthracite  
ML 756 002



Lin  
ML 756 581



Taupe  
ML 756 181



Vert Amazonie  
ML 756 078



Bois  
ML 756 008



Vert Tender  
ML 756 736



Jaune Indien  
ML 756 737



Rouge Bossa Nova  
ML 756 712



Forest Green  
23 001 818

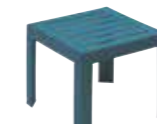

Bleu Minéral  
23 001 784

# PARASOLS

## GREENWICH

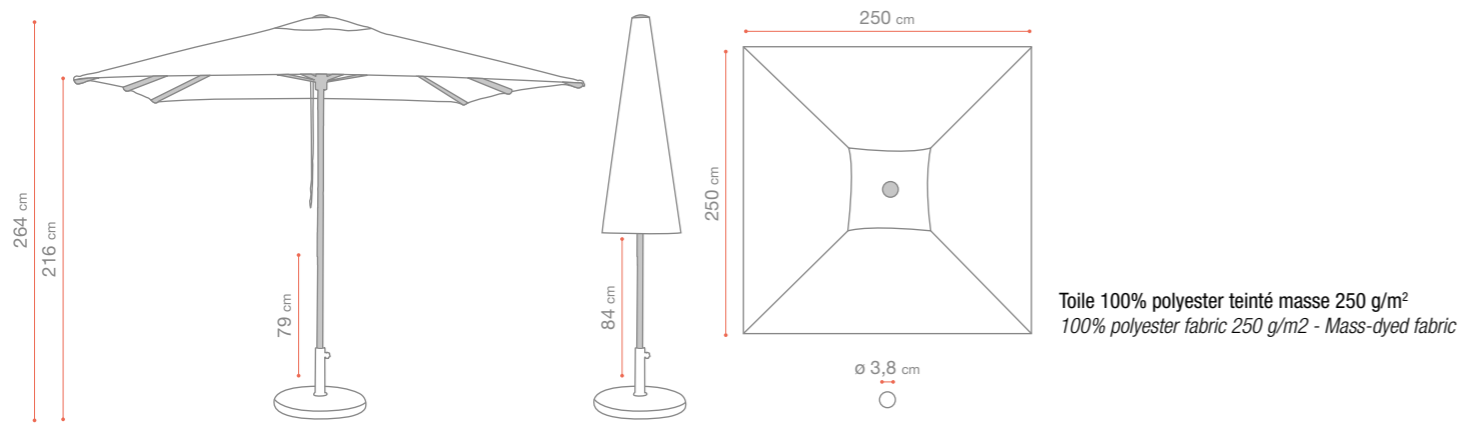

Blanc  
U4 601 096



Beige  
U4 601 003

## WINDMASTER

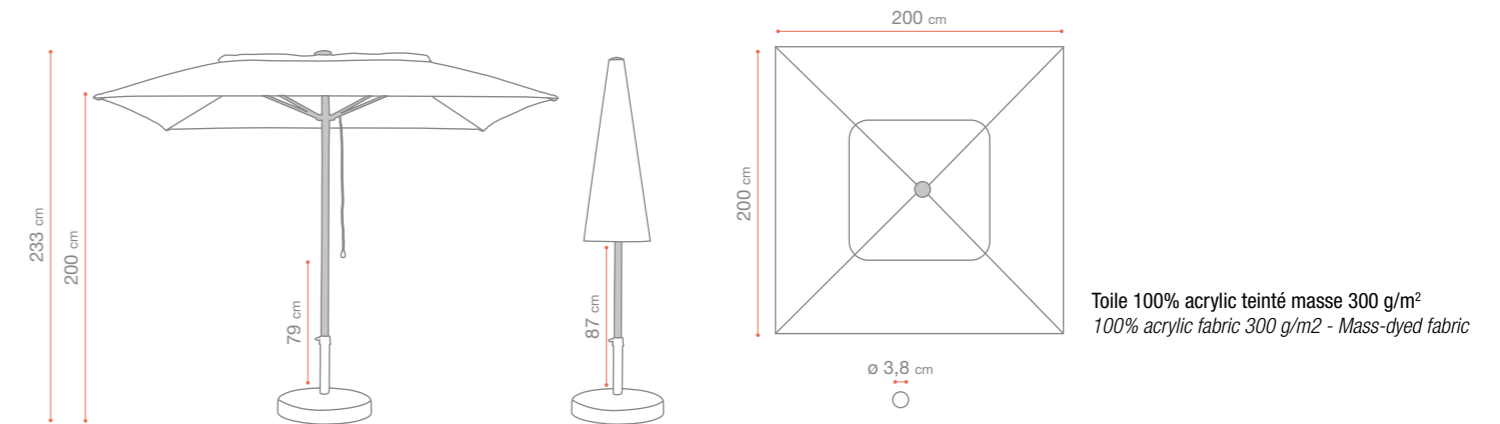

Blanc  
U4 501 096



Beige  
U4 501 003



Gris  
U4 501 235

## SUNSET



Toile 100% Olefin teinté masse 200 g/m<sup>2</sup>  
100% olefin fabric 200 g/m<sup>2</sup> - Mass-dyed polypropylene fabric



## BASES PARASOL - PARASOL BASES

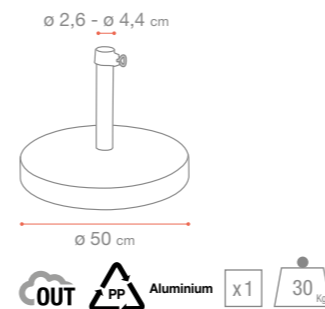

Blanc  
47 108 004

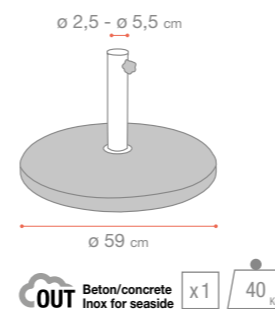

Béton  
47 109 002

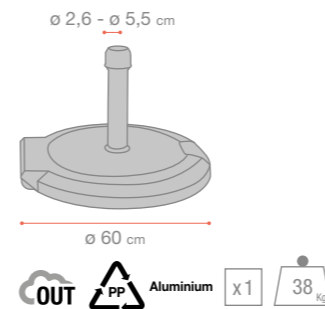

Blanc  
47 104 004



Anthracite  
47 104 002

## HOUSSÉ PARASOL - PARASOL COVER

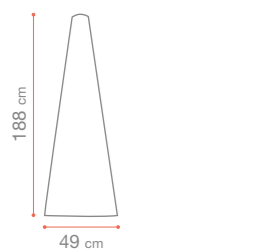

Housse universelle polyester  
U4 801 017

# BAC - POT

## TOKYO

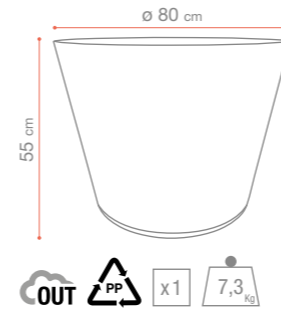
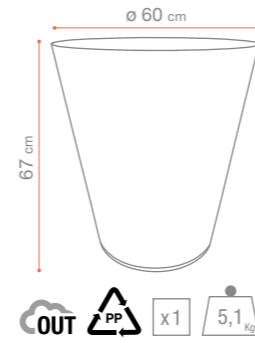
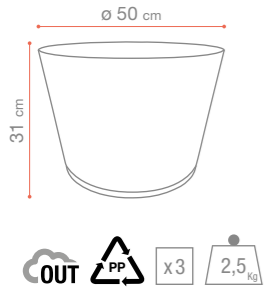

## DUO

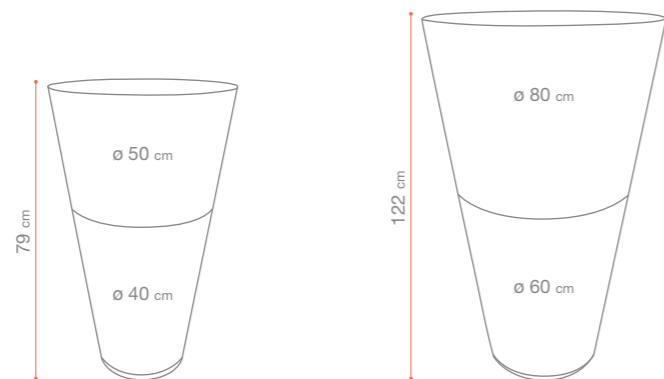



## FRANCE

Grosfillex S.A.S  
Rue de Lac  
CS 60401 Arbent  
01117 Oyonnax Cedex  
Tél. : 00 33 (0) 4 74 73 30 30  
Fax : 00 33 (0) 4 74 73 32 30  
[dpe.contract@grosfillex.com](mailto:dpe.contract@grosfillex.com)

## EXPORT DEPARTMENT

Tél. : 00 33 (0) 4 74 73 30 53  
Fax : 00 33 (0) 4 74 73 32 30  
[export@grosfillex.com](mailto:export@grosfillex.com)

## GROSFILLEX UK

Peek House  
20 Eastcheap  
EC3M 1EB  
London  
United Kingdom  
Tél. : 00 44 (0) 2 077 238 389  
Fax : 00 44 (0) 2 077 883 408  
[grosfillexuk@grosfillex.com](mailto:grosfillexuk@grosfillex.com)

## ESPAÑA - PORTUGAL CARIBE AMERICA DEL SUR AMERICA CENTRAL

City Park  
Carretera de Hospitalet, 147-149  
Edificio Berlin  
08940 Cornellá de Llobregat  
Barcelona  
Tél. : 00 34 93 474 01 19  
Fax : 00 34 93 474 54 10  
[espana@grosfillex.com](mailto:espana@grosfillex.com)

## ITALIA

Sede Legale: Via Fieno 3  
20123 Milano  
Tél. : 0039 02 38 23 07 91  
Tél. : 0039 03 21 53 93 11  
[italia@grosfillex.com](mailto:italia@grosfillex.com)

## DEUTSCHLAND, ÖSTERREICH, OSTEUROPA

Grosfillex GmbH  
Rheinstr. 96/F1  
D-56235 Ransbach-Baumbach  
Tél. : 00 49 2623 606 476 00  
Fax : 00 49 2623 606 476 66  
[deutschland@grosfillex.com](mailto:deutschland@grosfillex.com)

## BENELUX

Loopkantstraat 25  
5405 AC Uden  
Nederland  
Tel: 00 31 (0) 413 247 145  
Tel: 00 32 (0) 69 89 00 24  
[nederland@grosfillex.com](mailto:nederland@grosfillex.com)  
[email-belux@grosfillex.com](mailto:email-belux@grosfillex.com)

## SUISSE SCHWEIZ SVIZZERA

Case postale 30  
Chemin de la Combe 4  
1297 Founex (VD)  
Tél. : 00 41 22 960 98 10  
Fax : 00 41 22 776 44 29  
[switzerland@grosfillex.com](mailto:switzerland@grosfillex.com)



[www.grosfillex-expert.com](http://www.grosfillex-expert.com)