

VALIDO DAL 1 GENNAIO 2024 / VALID FROM 1ST JANUARY 2024

50
1974 - 2024

*DESIGN CATALOGUE
LISTINO PREZZI AL PUBBLICO*

RETAIL PRICE LIST / PREISLISTE

FINEST ITALIAN SHADE

50
1974 - 2024

*50 ANNI DI TRADIZIONE, INNOVAZIONE
E CREATIVITÀ MADE IN ITALY:
L'ARTE DELL'ECCELLENZA*

*50 YEARS OF TRADITION, INNOVATION
AND CREATIVITY MADE IN ITALY:
THE ART OF EXCELLENCE*

IT

Dal 1974 i nostri ombrelloni sono affidabili, in linea con le tendenze dell'outdoor e destinati a durare nel tempo, grazie alla sostenibilità dei migliori materiali utilizzati. Da generazioni, l'Italia è sinonimo di eccellenza artigianale, con un patrimonio culturale che abbraccia secoli di tradizione e maestria. Questa eredità si riflette nella nostra azienda, dove rispettiamo e preserviamo il meglio del passato, ma guardiamo costantemente al futuro. Vivere all'aria aperta è un'esigenza sana e sempre più sentita, in ogni luogo. Offrire comfort e sicurezza con ombrelloni dallo stile raffinato è il nostro lavoro da 50 anni.

Investiamo in tecnologie all'avanguardia per migliorare la qualità dei nostri prodotti e rendere il nostro processo di produzione, interamente 100% Made in Italy, sempre più efficiente. La ricerca e lo sviluppo sono i pilastri su cui costruiamo il nostro futuro, consentendoci di offrire ai nostri clienti soluzioni all'avanguardia che soddisfano le esigenze del mondo moderno. Le competenze manifatturiere e il know-how, la passione per la bellezza e l'attenzione ai dettagli si uniscono per creare prodotti unici, che rappresentano il meglio dello stile Italiano.

Questo rende Scolaro un'azienda leader che si impone in mercati anche molto diversi tra loro, ma uguali nello scegliere la qualità migliore.

I nostri primi cinquant'anni ci hanno dato la soddisfazione di una crescita continua. La stabilità e la solidità economica si abbina alla forza di un brand di alto livello, sempre più conosciuto e riconoscibile, capace di distribuire i propri prodotti nelle location più prestigiose ed esclusive al mondo.

EN

Since 1974 our umbrellas are reliable, in line with the trends of the outdoor and intended to last over time, thanks to the sustainability of the quality of the materials used. For generations, Italy has been synonymous of artisanal excellence, with a cultural heritage spanning centuries of tradition and craftsmanship. This legacy is reflected in our company, where we respect and preserve the best of the past, but constantly looking to the future. Living in the open air is a healthy and highly demanded, in every place. Offering comfort and safety with refined style umbrellas has been our job for 50 years.

We invest in cutting-edge technologies to improve the quality of our products and make our production process, 100% Made in Italy, increasingly efficient. Research and development are the pillars on which we build our future, enabling us to offer our customers state of the art solutions that meet the needs of the modern world. Manufacturing skills and know-how, passion for beauty and attention to detail come together to create unique products that represent the best of Italian style.

This makes Scolaro a leading company that stands out in markets that are also very different from each other but equivalent in choosing the best quality. Our first fifty years have given us the satisfaction of continuous growth. The stability and economic solidity is combined with the strength of a high level brand, increasingly known and recognizable, able to distribute its products in the most prestigious and exclusive locations in the world.



CONDIZIONI GENERALI DI VENDITA LEGGERE CON ATTENZIONE

- Listino.** Il presente listino e le presenti condizioni generali di vendita sostituiscono tutti i precedenti e si applicano al rapporto di compravendita tra Scolaro Parasol srl Unipersonale (di seguito Scolaro) e il soggetto Acquirente (di seguito Acquirente) e si intendono integralmente accettati in caso di trasmissione, anche solo verbale, dell'ordine o di ricezione della merce.
- Ordini.** La vendita sarà da considerarsi conclusa solo con l'accettazione scritta dell'ordine da parte di Scolaro o a seguito della spedizione della merce. Eventuali ordini verbali, anche telefonici, avranno efficacia solo se confermati per iscritto da Scolaro o in caso di spedizione della merce. Scolaro potrà a propria discrezione rifiutare gli ordini dell'Acquirente. In caso di accettazione di un ordine da parte di Scolaro con indicazione del pagamento anticipato di una parte o dell'intero ammontare ordine, il contratto si considererà concluso solo a seguito dell'effettivo pagamento richiesto; i termini di consegna decorreranno dalla data del pagamento medesimo.
- Pagamento.** Il pagamento deve avvenire al domicilio di Scolaro. Ai sensi degli articoli 1523 e seguenti del Codice Civile, l'Acquirente diverrà proprietario della merce acquistata solo dopo l'integrale pagamento del prezzo. In caso di mancato o ritardato pagamento in tutto o in parte del prezzo o di mancato incasso di eventuali titoli di pagamento, l'Acquirente decadrà dal beneficio del termine, ai sensi dell'art. 1186 c.c., anche con riferimento ad altri ordini/acquisti del medesimo Acquirente, e Scolaro potrà scegliere se chiedere il pagamento integrale del prezzo ancora dovuto, maggiorato degli interessi di mora ex art. 5 D. Lgs. 231/2002, ovvero se avvalersi della clausola di riserva di proprietà, chiedendo la restituzione della merce; in tale ultimo caso l'eventuale porzione di prezzo già pagata resterà acquisita a Scolaro a titolo di indennità. La parte Acquirente non potrà opporre eccezioni al fine di evitare o ritardare il pagamento del prezzo. Scolaro ha il diritto di sospendere le consegne delle merci in caso di inadempimento, anche parziale, da parte dell'Acquirente, senza che ciò possa far sorgere alcuna pretesa di risarcimento danni da parte dell'Acquirente.
- I termini di consegna** hanno valore indicativo e non garantiscono il pieno rispetto dei tempi previsti, eccezione fatta per impegni esplicitamente espressi nell'ordinazione e confermati per iscritto.
- Resa.** La merce è venduta franco fabbrica e viaggia a rischio e pericolo dell'Acquirente, anche in caso di trasporto effettuato in porto franco. I termini di consegna hanno valore meramente indicativo. Il montaggio dei prodotti è sempre a cura dell'Acquirente, che dovrà attenersi scrupolosamente alle istruzioni fornite da Scolaro, presenti nell'imballo. In caso di ritardi nelle consegne, nessuna penale o addebito potrà essere richiesta a Scolaro dall'Acquirente, né l'ordine potrà essere annullato in tutto o in parte. Scolaro è in ogni caso esonerata da ogni responsabilità in caso di impossibilità ad effettuare le forniture nei tempi previsti o in caso di ritardi sui tempi di consegna dovuti a caso fortuito o forza maggiore. La richiesta di consegna con sponda idraulica deve essere effettuata al momento dell'ordine per iscritto e prevede un supplemento da quantificare. Non sono incluse consegne ai piani e servizio di facchinaggio.
- Reclami.** La merce deve essere controllata dall'Acquirente al momento del ricevimento e/o prima del ritiro. Eventuali reclami relativi a stato dell'imballo, quantità, numero, caratteristiche esteriori del prodotto o ad altri vizi visibili dovranno essere comunicati dall'Acquirente prima del ritiro o al momento della ricezione della merce inviata da Scolaro, con onere dell'Acquirente di formulare riserva scritta sul documento di trasporto al momento dello scarico e denunciare l'evento a Scolaro entro 8 giorni dal ricevimento della merce. Con la denuncia dovranno essere forniti la copia del documento di trasporto con riserva e le immagini fotografiche chiare e la descrizione completa dei vizi contestati.

Nessuna segnalazione verrà esaminata se priva della documentazione indicata. In mancanza di apposizione della riserva o di mancata comunicazione a Scolaro nei termini indicati, Scolaro non sarà tenuta alla garanzia per vizi e difetti della merce venduta individuabili mediante un diligente controllo. L'Acquirente è comunque tenuto a verificare l'integrità degli articoli prima di trasferirli a terzi. A seguito del trasferimento, Scolaro non accetterà reclami per danni riconducibili al trasporto.

La nostra responsabilità per vizi o difetti di produzione è limitata al solo valore del prodotto con esclusione dei costi di trasporto e di ogni altro danno. La merce inviata in sostituzione dei prodotti difettosi viaggia a carico dell'Acquirente.

I ritorni di merce devono essere autorizzati per iscritto. Non si accettano resi di merce non difettosa.

La merce che abbia subito manipolazione o alterazioni da parte dell'Acquirente non può costituire oggetto del reclamo.

- Vendita online.** Al fine di preservare le legittime esigenze di tutela del marchio, dello stile e dell'immagine di prestigio che accompagna i suoi prodotti, Scolaro potrà richiedere all'Acquirente che la commercializzazione online venga esercitata con determinate modalità e che vengano garantiti l'adozione di una grafica del sito di qualità; la predisposizione di uno spazio virtuale esclusivo dedicato al marchio e ai prodotti Scolaro, senza riferimenti pubblicitari a prodotti differenti; l'esistenza di un negozio non virtuale. Fotografie, nome prodotti, logo e marchio sono di proprietà di Scolaro e possono essere pubblicati solo a seguito di espressa autorizzazione da parte di Scolaro. Tale autorizzazione può essere revocata in qualsiasi momento.
- Controversie.** Per ogni controversia relativa all'interpretazione ed all'esecuzione della vendita e dei rapporti tra Scolaro e l'Acquirente la giurisdizione esclusiva è quella italiana e sarà competente in via esclusiva il Foro di Padova.

A seguito delle ulteriori variazioni ed instabilità che continuano ad evolversi, relative agli aumenti generalizzati di tutte le materie prime (legno, metallo, alluminio, tessuti ecc.) e di molte altre voci collegate ai costi di produzione QUESTO LISTINO È DA CONSIDERARSI VALIDO FINO A PROSSIMA EVENTUALE REVISIONE.

IMPORTANTE: i prezzi, s'intendono IVA esclusa, e possono subire variazioni senza alcun preavviso. Misure e dati contenuti nel presente documento sono indicativi. Le informazioni contenute nel listino e catalogo o in altri stampati pubblicitari della ditta Scolaro, quali caratteristiche tecniche dei prodotti o dei componenti, dimensioni, schemi di montaggio, colori, ecc., hanno valore meramente indicativo, in ragione delle specifiche tecniche e della evoluzione tecnologica dei prodotti aziendali. Al fine di migliorare la qualità del prodotto, la ditta si riserva il diritto di modificare lo stesso senza alcun preavviso e anche dopo l'accettazione dell'ordine. L'azienda si riserva di apportare modifiche parziali o totali ai prodotti senza preavviso declinando ogni responsabilità su eventuali dati inesatti. Eventuali lievi variazioni di tonalità dei colori e delle finiture rientrano nelle normali caratteristiche dei materiali impiegati. Tutte le differenze sopraindicate non sono tali da modificare significativamente i prodotti stessi e non costituiscono motivo di reso o sostituzione della merce o di contestazione.

GENERAL SALES CONDITION READ CAREFULLY

- Price list.** This price list and these general sales condition replace all the previous ones and apply to the sales relationship between Scolaro Parasol srl Unipersonale (hereinafter Scolaro) and the Buyer (hereinafter Buyer) and are understood to be fully accepted in the event of transmission, even just verbal, of the order or receipt of the goods.
- Orders.** The sale will be considered concluded only with the written acceptance of the order by Scolaro or following the shipment of the goods. Any verbal orders, even by phone, will be effective only if confirmed in writing by Scolaro or in case of shipment of the goods. Scolaro may at its discretion refuse the Buyer's orders. In case of acceptance of an order by Scolaro with indication of the advance payment of a part or of the entire amount of the order, the contract will be considered concluded and the production will start only upon receipt of the payment requested.
- Payment.** The payment must take place at Scolaro's domicile. In accordance with the article 1523 and Civil Code, the Buyer will become the owner of the goods purchased only after full payment. In case of failure or delay in paying the entire or part of the amount, the Buyer will lose the benefit of the term, according to the art. 1186 of the Civil Code, also with reference to other orders/purchases of the same Buyer, Scolaro can choose whether to request the full payment due, increased by default interests according to art. 5 Legislative Decree 231/2002, or whether to make use of the retention of title clause, requiring the return of the goods; in that case, any portion of the already paid amount will remain with Scolaro as an indemnity. The Buyer may not make exceptions in order to avoid or delay payment of the order amount. Scolaro has the right to suspend deliveries of the goods in case of non-fulfilment, even partial, by the Buyer, without this giving rise to any claim for damages by the Buyer.
- Lead times** are indicative and do not guarantee full compliance with the scheduled times, except for commitments explicitly expressed in the order and confirmed in writing.
- Delivery term.** The goods are sold ex works and travel at the Buyers' risk, even in the case of transport carried out free destination. The lead time is indicative. The assembly of the products is always the responsibility of the Buyer, who must scrupulously follow the instructions provided by Scolaro and included in the packaging. In case of delays in deliveries, no penalty or charge can be requested from Scolaro by the Buyer nor can the order be canceled completely or in part. Scolaro is in any case exonerated from any responsibility in case of impossibility to carry out supplies within the foreseen times or in the event of delays in delivery times due to unforeseeable circumstances or force majeure. The request for delivery with tail lift must be agreed at the time of the order in writing and provides for a supplement to be quantified. Deliveries to floors and portorage service are not included.
- Complaints.** The goods must be checked by the Buyer upon receipt and/or before collection. Any complaints relating to the state of the packaging, quantity, number, external characteristics of the product or other visible defects must be communicated by the Buyer before collection or upon receipt of the goods sent by Scolaro, with the Buyer's responsibility to formulate reservations written on the delivery note at the time of unloading and report the event to Scolaro within 8 days of receipt of the goods. With the complaint, a copy of the delivery note with reserve and clear photographic images and a complete description of the alleged defects must be provided. No claim will be examined without the specified documentation. In case of missing reserve or failure to notify Scolaro within the terms indicated, Scolaro will not be required to guarantee for faults and defects of the goods sold identifiable through a diligent inspection. In any case, the Buyer is required

to verify the integrity of the articles before transferring them to third parties. Following the transfer, Scolaro will not accept claims for damages attributable to transport.

Our liability for faults or manufacturing defects is limited to the value of the product only, excluding transportation costs and any other damages. The goods sent in replacement of the defective products travel at the Customer's expense.

Returns of goods must be authorized in writing. Returns of non-defective goods will not be accepted.

Goods that have been manipulated or altered by the Customer cannot be the subject of a claim.

- Online sales.** In order to preserve the legitimate requirements for the protection of the brand, the style and the prestigious image that accompanies its products, Scolaro may ask the Buyer that the on-line marketing line is exercised in certain ways and that the adoption of quality site graphics is guaranteed; the preparation of an exclusive virtual space dedicated to the Scolaro brand and products, without advertising references to different products; the existence of a non-virtual shop. Pictures, product names, logos and trademarks are the property of Scolaro and can only be published following Scolaro's permission. This authorization can be revoked at any time.
- Disputes.** For any dispute relating to the interpretation and execution of the sale and the relationship between Scolaro and the Buyer, the exclusive jurisdiction is the Italian one and the Court of Padua will have exclusive jurisdiction.

Following the further variations and instability that continue to evolve, relating to the generalized increases of all raw materials (wood, metal, aluminum, fabrics, etc.) and many other items connected to production costs, THIS PRICELIST IS TO BE CONSIDERED VALID UNTIL NEXT POSSIBLE REVISION.

IMPORTANT: prices do not include VAT and may vary without notice. Measurements and data contained in this document are indicative. The information contained in the price list and brochure or in other advertising printed materials, such as technical characteristics of the products or components, dimensions, assembly diagrams, colours, etc., are merely indicative, due to the technical specifications and technological evolution of company products. In order to improve the quality of the product, Scolaro reserves the right to change it without notice and even after acceptance of the order. Scolaro reserves the right to make partial or total changes to the products without notice, declining all responsibility for any inaccurate data. Any slight variations in color tone and finish are within the normal characteristics of the materials used. All the above differences don't significantly modify the products and are not a reason for return or replacement of the goods or for a dispute.

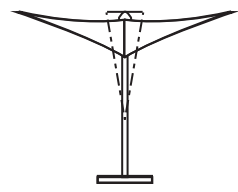

VELA TITANIUM **NEW**



CHARACTERISTICS



A1N

T6N, T9N



	2,0 x 2,0 C2020 VSP	40	4	€ 520	€ 520	€ 64
	3,0 x 3,0 C3030 VSP	50	4	€ 690	€ 690	€ 72

COLOUR RANGE - p.56

ACRILYC 350GR

Senza volant / without volant



A1N T6N T9N

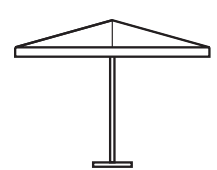

LIDO DARK **NEW**



CHARACTERISTICS



A1N

T6N, T7N, T8N,
T9N, S1N



	2,5 C2500 LDD	40	6	€ 440	€ 490	€ 64
	2,0 x 2,0 C2020 LDD	40	4	€ 360	€ 398	€ 64



COLOUR RANGE - p.56

ACRILYC 350GR

Senza volant / without volant

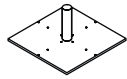
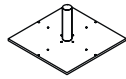
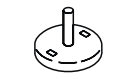
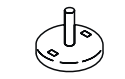
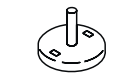
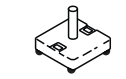

A1N T6N T7N T8N T9N S1N

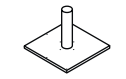
	BASES p.40						GROUND FIXING p.49	
								
	BF6565D € 350	BF6666D € 660	BC35MA4 € 82	BC55MA4 € 98	BC80MA4 € 130	BC5151GRA4 € 165	BTC+BTT € 96	CP3030ZS + BTT € 170

2,0 x 2,0 C2020 VSP	3	4	1	3	4		5 +BTT45	5 +BTT45
3,0 x 3,0 C3030 VSP	2	3	/	2	3		5 +BTT55	5 +BTT55

Base non compresa nel prezzo | Base not included in the price

IT

Canaline con velcro su richiesta

Telaio in alluminio con finitura effetto titanium. Viteria in acciaio inox e componenti in nylon colore nero.

Vedi catalogo a pag. 13

EN

Rain gutter with velcro on request

Aluminum frame with titanium effect finish. Stainless steel hardware and black-colored nylon components.

See catalogue on page 13

DE



Regenrinnen mit Klettverschluss auf Anfrage

Alugestell mit Pulverbeschichtung Farbe Titanium. Edelstahlschrauben und Nylonzubehoer in schwarz.

Siehe katalog auf seite 13

VERIFICA LA STABILITÀ - p.50

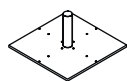
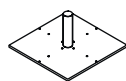
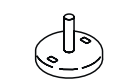
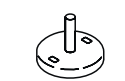
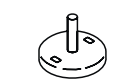
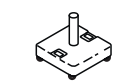
Check stability - Vérifiez la stabilité - Stabilität prüfen - Compruebe la estabilidad - Controleer de stabiliteit

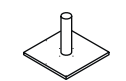
	BASES p.40						GROUND FIXING p.49	
								
	BF6565D € 350	BF6666D € 660	BC35MA4 € 82	BC55MA4 € 98	BC80MA4 € 130	BC5151GRA4 € 165	BTC+BTT € 96	CP3030ZS + BTT € 170

2,5 C2500 LDD	3	4	1	3	4		5 +BTT45	5 +BTT45
2,0 x 2,0 C2020 LDD	3	4	1	3	4		5 +BTT55	5 +BTT55

Base non compresa nel prezzo | Base not included in the price

IT

Canaline con velcro su richiesta

Telaio in alluminio con verniciatura a polveri colore grigio antracite. Viteria in acciaio inox e componenti in nylon. Sistema di corone in plastica completamente rinnovato, con design e funzionalità che rendono questo prodotto esclusivo.

Vedi catalogo a pag. 21

EN

Rain gutter with velcro on request

Aluminum frame with powder coating anthracite grey. Stainless steel hardware and nylon components. Completely renovated plastic crown system with new design and increased functionality that make this product unique.

See catalogue on page 21

DE

Regenrinnen mit Klettverschluss auf Anfrage

Aluminiumgestell pulverbeschichtet Farbe Anthrazitgrau. Edelstahlschrauben und Nylonbestandteile. Komplett erneuertes Kunststoffkronensystem. Einzigartiges und funktionelles Design.

Siehe katalog auf seite 21

VERIFICA LA STABILITÀ - p.50

Check stability - Vérifiez la stabilité - Stabilität prüfen - Compruebe la estabilidad - Controleer de stabiliteit

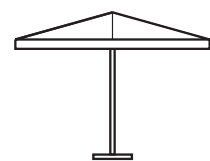

LIDO STARWHITE **NEW**

CHARACTERISTICS



A1N

T6N, T7N, T8N,
T9N, S1N



	2,5 C2500 LDW	40	6	€ 440	€ 490	€ 64
	2,0 x 2,0 C2020 LDW	40	4	€ 360	€ 398	€ 64

COLOUR RANGE - p.56

ACRILYC 350GR

Senza volant / without volant



A1N T6N T7N T8N T9N S1N

	BASES p.40						GROUND FIXING p.49	
	BF6565W € 380	BF6666W € 690	BC35MA4 € 82	BC55MA4 € 98	BC80MA4 € 130	BC5151GRA4 € 165	BTC+BTT € 96	CP3030ZS + BTT € 170

2,5 C2500 LDW	3	4	1	3	4		5 +BTT45	5 +BTT45
2,0 x 2,0 C2020 LDW	3	4	1	3	4		5 +BTT55	5 +BTT55

Base non compresa nel prezzo | Base not included in the price

IT

Canaline con velcro su richiesta

Telaio in alluminio con verniciatura a polveri colore bianco opaco. Viteria in acciaio inox e componenti in nylon. Sistema di corone in plastica completamente rinnovato, con design e funzionalità che rendono questo prodotto esclusivo.

Vedi catalogo a pag. 25

EN

Rain gutter with velcro on request

Aluminum frame with powder coating matt white. Stainless steel hardware and nylon components. Completely renovated plastic crown system with new design and increased functionality that make this product unique.

See catalogue on page 25

DE

Regenrinnen mit Klettverschluss auf Anfrage

Aluminiumgestell pulverbeschichtet Mattweiss. Edelstahlzubehoer und Nylonbestandteile. Komplett erneuertes Kunststoffkronensystem. Einzigartiges und funktionelles Design.

Siehe katalog auf seite 25

VERIFICA LA STABILITÀ - p.50

Check stability - Vérifiez la stabilité - Stabilität prüfen - Compruebe la estabilidad - Controleer de stabiliteit

6

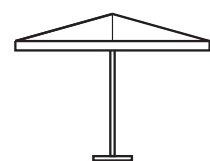

LIDO TITANIUM **NEW**

CHARACTERISTICS



A1N

T6N, T7N, T8N,
T9N, S1N



	2,5 C2500 LDT	40	6	€ 490	€ 540	€ 64
	2,0 x 2,0 C2020 LDT	40	4	€ 400	€ 440	€ 64

COLOUR RANGE - p.56

ACRILYC 350GR

Senza volant / without volant



A1N T6N T7N T8N T9N S1N

	BASES p.40						GROUND FIXING p.49	
	BF6565D € 350	BF6666D € 660	BC35MA4 € 82	BC55MA4 € 98	BC80MA4 € 130	BC5151GRA4 € 165	BTC+BTT € 96	CP3030ZS + BTT € 170

2,5 C2500 LDT	3	4	1	3	4		5 +BTT45	5 +BTT45
2,0 x 2,0 C2020 LDT	3	4	1	3	4		5 +BTT55	5 +BTT55

Base non compresa nel prezzo | Base not included in the price

IT

Canaline con velcro su richiesta

Telaio in alluminio anodizzato Titanium. Viteria in acciaio inox e componenti in nylon. Sistema di corone in plastica completamente rinnovato, con design e funzionalità che rendono questo prodotto esclusivo.

Vedi catalogo a pag. 29

EN

Rain gutter with velcro on request

Aluminum frame with anodized Titanium finish. Stainless steel hardware and nylon components. Completely renovated plastic crown system with new design and increased functionality that make this product unique.

See catalogue on page 29

DE

Regenrinnen mit Klettverschluss auf Anfrage

Aluminiumgestell mit Titanium- Effekt-Finish. Edelstahlzubehoer und Nylonbestandteile. Komplett erneuertes Kunststoffkronensystem. Einzigartiges und funktionelles Design.

Siehe katalog auf seite 29

VERIFICA LA STABILITÀ - p.50

Check stability - Vérifiez la stabilité - Stabilität prüfen - Compruebe la estabilidad - Controleer de stabiliteit

7

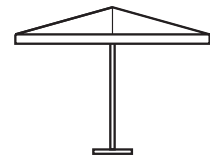

NAPOLI STANDARD

CHARACTERISTICS



A1S

A1N

T2S, T3S

T2N, T3N

T6N, T7N, T8N, T9N, S1N



	3,5 C3500 NAS	50	8	/	€ 690	/	€ 820	€ 820	€ 72
	3,0 x 3,0 C3030 NAS	50	8	€ 690	€ 690	€ 810	/	€ 810	€ 72
	2,0 x 3,0 C2030 NAS	50	6	€ 590	€ 590	/	/	/	€ 72
	3,0 x 4,0 C3040 NAS	50	8	€ 830	€ 830	€ 980	/	€ 980	€ 88

COLOUR RANGE - p.56

ACRILYC 350GR

Con volant / with volants



A1S T2S T3S

Senza volant / without volants



A1N T2N T3N T6N T7N T8N T9N S1N

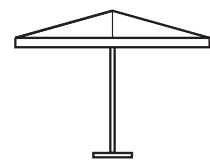

RIMINI STANDARD

CHARACTERISTICS



A1S

A1N

T2S, T3S

T2N, T3N

T6N, T7N, T8N, T9N, S1N



	3,5 C3500 RIS	50	8	/	€ 710	/	€ 840	€ 840	€ 72
	3,0 x 3,0 C3030 RIS	50	8	€ 710	€ 710	€ 830	/	€ 830	€ 72
	3,0 x 4,0 C3040 RIS	50	8	€ 850	€ 850	€ 1.000	/	€ 1.000	€ 88

COLOUR RANGE - p.56

ACRILYC 350GR

Con volant / with volants



A1S T2S T3S

Senza volant / without volants



A1N T2N T3N T6N T7N T8N T9N S1N

BASES p.40

BALLAST p.48

GROUND FIXING p.49

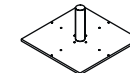

BF6565D
€ 350

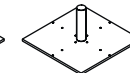

BF6666D
€ 660



BC55MA4
€ 98



BC80MA4
€ 130



BC5151GRA4
€ 165



BQ8080DS
€ 198



BUD8080DS
€ 420



BC4040
-



BTC+BTT
€ 96



CP3030ZS + BTT
€ 170

3,5 C3500 NAS	2	3	2	3	4	/	◆	5 +BTT55	5 +BTT55
3,0 x 3,0 C3030 NAS	2	3	2	3	4	5	◆	5 +BTT55	5 +BTT55
2,0 x 3,0 C2030 NAS	3	4	3	4	/	/	/	5 +BTT55	5 +BTT55
3,0 x 4,0 C3040 NAS	1	2	1	2	/	3	4	5 +BTT55	5 +BTT55

Base non compresa nel prezzo | Base not included in the price

IT

Canaline con velcro su richiesta

Telaio in alluminio verniciato a polveri colore antracite. Viteria in acciaio inox e componenti in nylon colore nero.

Vedi catalogo a pag. 37

EN

Rain gutter with velcro on request

Frame: aluminium powder coated anthracite grey. Stainless steel screws and components in black nylon.

See catalogue on page 37

DE

Regenrinnen mit Klettverschluss auf Anfrage

Gestell: Pulverbeschichtetes Aluminium Farbe Anthrazitgrau. Edelstahlschrauben und Zubehoer aus Nylon. Farbe schwarz.

Siehe katalog auf seite 37

VERIFICA LA STABILITÀ - p.50

Check stability - Vérifiez la stabilité - Stabilität prüfen - Compruebe la estabilidad - Controleer de stabiliteit

BASES p.40

BALLAST p.48

GROUND FIXING p.49

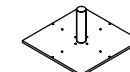

BF6565W
€ 380

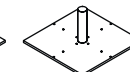

BF6666W
€ 690



BC55MA4
€ 98



BC80MA4
€ 130



BC5151GRA4
€ 165



BQ8080ZS
€ 180



BUD8080BS
€ 420



BC4040
-



BTC+BTT
€ 96



CP3030ZS + BTT
€ 170

3,5 x 3,5 C3500 RIS	2	3	2	3	4	/	◆	5 +BTT55	5 +BTT55
3,0 x 3,0 C3030 RIS	2	3	2	3	4	5	◆	5 +BTT55	5 +BTT55
3,0 x 4,0 C3040 RIS	1	2	1	2	/	3	4	5 +BTT55	5 +BTT55

Base non compresa nel prezzo | Base not included in the price

IT

Canaline con velcro su richiesta

Telaio in alluminio verniciato a polveri colore Starwhite. Viteria in inox e componenti in nylon colore bianco.

Vedi catalogo a pag. 45

EN

Rain gutter with velcro on request

Aluminium frame epoxy coated color Starwhite. Stainless steel Screws and components in nylon color white.

See catalogue on page 45

DE

Regenrinnen mit Klettverschluss auf Anfrage

Aluminiumgestell pulverbeschichtet Starwhite. Schrauben aus Edelstahl und Zubehoer aus Nylon Farbe weiss.

Siehe katalog auf seite 45

VERIFICA LA STABILITÀ - p.50

Check stability - Vérifiez la stabilité - Stabilität prüfen - Compruebe la estabilidad - Controleer de stabiliteit

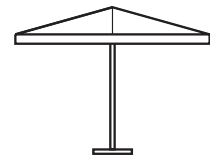

PALLADIO STANDARD

CHARACTERISTICS



A1S

A1N

T2S, T3S

T2N, T3N

T6N, T7N, T8N,
T9N, S1N



				A1S	A1N	T2S, T3S	T2N, T3N	T6N, T7N, T8N, T9N, S1N	
	2,5 C2500 PAS	38	6	/	€ 390	/	/	/	€ 64
	2,5 C2500 PAS	48	6	/	€ 410	/	/	/	€ 64
	3,0 C3000 PAS	48	8	/	€ 590	/	/	/	€ 64
	3,5 C3500 PAS	48	8	/	€ 640	/	€ 770	€ 770	€ 72
	4,0 C4000 PAS	58	8	/	€ 850	/	/	/	€ 72
	2,0 x 2,0 C2020 PAS	48	4	€ 390	€ 360	/	/	/	€ 64
	3,0 x 3,0 C3030 PAS	48	8	€ 650	€ 650	€ 770	/	€ 770	€ 72
	3,5 x 3,5 C3535 PAS	58	8	€ 890	€ 890	€ 1.060	/	€ 1.060	€ 88
	4,0 x 4,0 C4040 PAS	58	8	€ 1.020	€ 1.020	€ 1.230	/	€ 1.230	€ 88
	2,0 x 3,0 C2030 PAS	48	6	€ 520	€ 520	/	/	/	€ 72
	3,0 x 4,0 C3040 PAS	58	8	€ 830	€ 830	€ 980	/	€ 980	€ 88

COLOUR RANGE - p.56

ACRILYC 350GR

Con volant / with volant



A1S T2S T3S

Senza volant / without volant



A1N T2N T3N T6N T7N T8N T9N S1N

BASES p.40

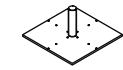

BF6565D
€350
BF6565W
€380

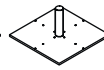

BF6666D
€660
BF6666W
€690



BC35MA4
€ 82



BC55MA4
€ 98



BC80MA4
€ 130



BC5151GRA4
€ 165

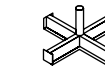

BQ8080ZS
€ 180
BQ8080DS
€ 198

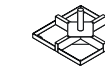

BUD8080DS
€ 420
BUD8080BS
€ 420



BC4040
-



BTC+BTT
€ 96

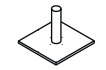

CP3030ZS
+ BTT
€ 170

BALLAST p.48 GROUND FIXING p.49

2,5 C2500 PAS	3	4	1	3	4	5	/	/	/	5 +BTT45 /BTT55	5 +BTT45 /BTT55
2,5 C2500 PAS	3	4	1	3	4	5	/	/	/	5 +BTT45 /BTT55	5 +BTT45 /BTT55
3,0 C3000 PAS	3	4	/	3	4	5	/	/	/	5 +BTT55	5 +BTT55
3,5 C3500 PAS	2	3	/	2	3	5	4	/	/	5 +BTT55	5 +BTT55
4,0 C4000 PAS	1	2	/	1	2	/	3	4	◆	5 +BTT65	5 +BTT65
2,0 x 2,0 C2020 PAS	3	4	1	3	4	5	/	/	/	5 +BTT55	5 +BTT55
3,0 x 3,0 C3030 PAS	2	3	/	2	3	5	4	5	◆	5 +BTT55	5 +BTT55
3,5 x 3,5 C3535 PAS	1	2	/	1	2	/	3	4	◆	5 +BTT65	5 +BTT65
4,0 x 4,0 C4040 PAS	/	1	/	/	1	/	3	4	◆	5 +BTT65	5 +BTT65
2,0 x 3,0 C2030 PAS	3	4	/	3	4	5	/	/	/	5 +BTT55	5 +BTT55
3,0 x 4,0 C3040 PAS	1	2	/	1	2	/	3	4	◆	5 +BTT65	5 +BTT65

Base non compresa nel prezzo | Base not included in the price

IT

Canaline con velcro su richiesta
Telaio in legno Iroko selezionato,
trattato con vernice protettiva per esterni.

Vedi catalogo a pag. 53

EN

Rain gutter with velcro on request
Frame: Selected Iroko wood.
Varnished and treated.

See catalogue on page 53

DE

Regenrinnen mit Klettverschluss auf Anfrage
Gestell: Erstklassiges Irokoholz mit
umweltfreundlicher Schutzlasur.

Siehe katalog auf seite 53

VERIFICA LA STABILITÀ - p.50

Check stability - Vérifiez la stabilité - Stabilität prüfen - Compruebe la estabilidad - Controleer de stabiliteit

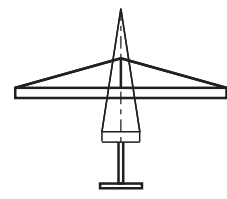

LEONARDO TELESCOPIC

CHARACTERISTICS			A1S	A1N	T2S, T3S	T6N, T7N, T8N, T9N, S1N	
3,5 x 3,5 C3535 LET	55	8	€ 1.020	€ 1.020	€ 1.190	€ 1.190	€ 88
4,0 x 4,0 C4040 LET	55	8	€ 1.190	€ 1.190	€ 1.400	€ 1.400	€ 88
3,0 x 4,0 C3040 LET	55	8	€ 950	€ 950	€ 1.100	€ 1.100	€ 88

COLOUR RANGE - p.56

ACRILYC 350GR

Con volant / with volant

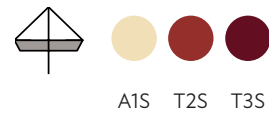

Senza volat / without volant



	BASES p.40						BALLAST p.48	GROUND FIXING p.49	
	BF6565D € 350	BF6666D € 660	BC55MA4 € 98	BC80MA4 € 130	BQ8080DS € 198	BUD8080DS € 420	BC4040 -	BTC+BTT € 96	CP3030ZS + BTT € 170
3,5 x 3,5 C3535 LET	1	2	1	2	3	4	◆	5 +BTT65	5 +BTT65
4,0 x 4,0 C4040 LET	/	1	/	1	3	4	◆	5 +BTT65	5 +BTT65
3,0 x 4,0 C3040 LET	1	2	1	2	3	4	◆	5 +BTT65	5 +BTT65

Base non compresa nel prezzo | Base not included in the price

IT

Canaline con velcro su richiesta

Sistema di apertura telescopico.

Telaio: Alluminio verniciato a polveri colore antracite. Viteria in acciaio inox e componenti in nylon colore nero.

Vedi catalogo a pag. 63

EN

Rain gutter with velcro on request

Telescopic opening system.

Frame: Aluminium powder coated anthracite grey. Stainless steel screws and components in black nylon.

See catalogue on page 63

DE

Regenrinnen mit Klettverschluss auf Anfrage

Teleskopöffnungssystem Gestell:

Pulverbeschichtetes Aluminium Farbe Anthrazitgrau. Edelstahlschrauben und Zubehör aus schwarz Nylon.

Siehe katalog auf seite 63

VERIFICA LA STABILITÀ - p.50

Check stability - Vérifiez la stabilité - Stabilität prüfen - Compruebe la estabilidad - Controleer de stabiliteit

12

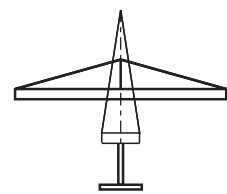

PALLADIO TELESCOPIC

CHARACTERISTICS			A1S	A1N	T2S, T3S	T6N, T7N, T8N, T9N, S1N	
5,0 C5000 PAT	58	10	/	€ 1.290	/	/	€ 88
4,0 x 4,0 C4040 PAT	58	8	€ 1.120	€ 1.120	€ 1.330	€ 1.330	€ 88
3,0 x 4,0 C3040 PAT	58	8	€ 890	€ 890	€ 1.040	€ 1.040	€ 88

COLOUR RANGE - p.56

ACRILYC 350GR

Con volat / with volant



Senza volat / without volant



	BASES p.40						BALLAST p.48	GROUND FIXING p.49	
	BF6565D € 350 BF6565W € 380	BF6666D € 660 BF6666W € 690	BC55MA4 € 98	BC80MA4 € 130	BQ8080ZS € 180 BQ8080DS € 198	BUD8080DS € 420 BUD8080BS € 420	BC4040 -	BTC+BTT € 96	CP3030ZS + BTT € 170
5,0 C5000 PAT	/	1	/	1	2	3	◆	5 +BTT65	5 +BTT65
4,0 x 4,0 C4040 PAT	/	1	/	1	3	4	◆	5 +BTT65	5 +BTT65
3,0 x 4,0 C3040 PAT	1	2	1	2	3	4	◆	5 +BTT65	5 +BTT65

Base non compresa nel prezzo | Base not included in the price

IT

Canaline con velcro su richiesta

Sistema di apertura telescopico. Telaio in legno Iroko selezionato, trattato con vernice protettiva per esterni.

Vedi catalogo a pag. 71

EN

Rain gutter with velcro on request

Telescopic opening system. Frame: Selected Iroko wood. Varnished and treated.

See catalogue on page 71

DE

Regenrinnen mit Klettverschluss auf Anfrage

Teleskopöffnungssystem. Gestell: Erstklassiges Irokoholz mit umweltfreundlicher Schutzlasur.

Siehe katalog auf seite 71

VERIFICA LA STABILITÀ - p.50

Check stability - Vérifiez la stabilité - Stabilität prüfen - Compruebe la estabilidad - Controleer de stabiliteit

13

NAPOLI BRACCIO

CHARACTERISTICS	Con volant / with volant		Senza volant / without volant					
	A1S	A1N	T2S, T3S	T2N, T3N	T6N, T7N, T8N, T9N, S1N			
3,5 C3500 NAB	75x75	8	/	€ 1.260	/	€ 1.390	€ 1.390	€ 110
3,0 x 3,0 C3030 NAB	75x75	8	€ 1.260	€ 1.260	€ 1.380	/	€ 1.380	€ 110
2,0 x 3,0 C2030 NAB	75x75	6	€ 1.160	€ 1.160	/	/	/	€ 110
3,0 x 2,0 C3020 NAB	75x75	6	€ 1.160	€ 1.160	/	/	/	€ 110
3,0 x 4,0 C3040 NAB	75x75	8	€ 1.400	€ 1.400	€ 1.550	/	€ 1.550	€ 110

COLOUR RANGE - p.56

ACRILYC 350GR

Con volant / with volant

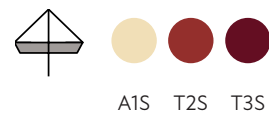

Senza volant / without volant



RIMINI BRACCIO

CHARACTERISTICS	Con volant / with volant		Senza volant / without volant					
	A1S	A1N	T2S, T3S	T2N, T3N	T6N, T7N, T8N, T9N, S1N			
3,5 C3500 RIB	75x75	8	/	€ 1.290	/	€ 1.420	€ 1.420	€ 110
3,0 x 3,0 C3030 RIB	75x75	8	€ 1.290	€ 1.290	€ 1.410	/	€ 1.410	€ 110
3,0 x 4,0 C3040 RIB	75x75	8	€ 1.430	€ 1.430	€ 1.580	/	€ 1.580	€ 110

COLOUR RANGE - p.56

ACRILYC 350GR

Con volant / with volant

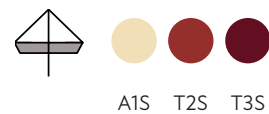

Senza volant / without volant



CHARACTERISTICS	BASES p.40				BALLAST p.48	GROUND FIXING p.49		
	B1DS	PL1DS	BUD8080DS	-	BTAZS	CP3030ZS	CP6565ZS	
3,5 C3500 NAB	€ 230	€ 390	€ 420	◆	€ 98	€ 140	€ 360	
3,0 x 3,0 C3030 NAB	€ 230	€ 390	€ 420	◆	€ 98	€ 140	€ 360	
2,0 x 3,0 C2030 NAB	€ 230	€ 390	€ 420	◆	€ 98	€ 140	€ 360	
3,0 x 2,0 C3020 NAB	€ 230	€ 390	€ 420	◆	€ 98	€ 140	€ 360	
3,0 x 4,0 C3040 NAB	€ 230	€ 390	€ 420	◆	€ 98	€ 140	€ 360	

Base non compresa nel prezzo | Base not included in the price

IT

Canaline con velcro su richiesta
Ombrellone a braccio laterale. Telaio in alluminio e componenti in acciaio; verniciato a polveri colore antracite. Accessori in nylon.

Vedi catalogo a pag. 79

VERIFICA LA STABILITÀ - p.50

Check stability - Vérifiez la stabilité - Stabilität prüfen - Compruebe la estabilidad - Controleer de stabiliteit

EN

Rain gutter with velcro on request
Cantilever parasol. Frame: Powder coated aluminium anthracite grey. Nylon accessories.

See catalogue on page 79

DE

Regenrinnen mit Klettverschluss auf Anfrage
Seitenarmschirm. Gestell aus pulverbeschichtetem Aluminium und Bestandteile aus Stahl Farbe Anthrazitgrau. Zubehoer aus Nylon.

Siehe katalog auf seite 79

CHARACTERISTICS	BASES p.40				BALLAST p.48	GROUND FIXING p.49		
	B1BS	PL1BS	BUD8080BS	-	BTAZS	CP3030ZS	CP6565ZS	
3,5 C3500 RIB	€ 230	€ 390	€ 420	◆	€ 98	€ 140	€ 360	
3,0 x 3,0 C3030 RIB	€ 230	€ 390	€ 420	◆	€ 98	€ 140	€ 360	
3,0 x 4,0 C3040 RIB	€ 230	€ 390	€ 420	◆	€ 98	€ 140	€ 360	

Base non compresa nel prezzo | Base not included in the price

IT

Canaline con velcro su richiesta
Ombrellone a braccio laterale. Telaio in alluminio e componenti in acciaio; verniciato a polveri colore antracite. Accessori in nylon.

Vedi catalogo a pag. 87

VERIFICA LA STABILITÀ - p.50

Check stability - Vérifiez la stabilité - Stabilität prüfen - Compruebe la estabilidad - Controleer de stabiliteit

EN

Rain gutter with velcro on request
Cantilever parasol. Frame: Powder coated aluminium anthracite grey. Nylon accessories.

See catalogue on page 87

DE

Regenrinnen mit Klettverschluss auf Anfrage
Seitenarmschirm. Gestell aus pulverbeschichtetem Aluminium und Bestandteile aus Stahl Farbe Anthrazitgrau. Zubehoer aus Nylon.

Siehe katalog auf seite 87

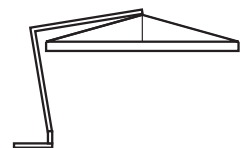

TORINO BRACCIO

CHARACTERISTICS



A1S

A1N

T2S, T3S

T2N, T3N

T6N, T7N, T8N,
T9N, S1N



				A1S	A1N	T2S, T3S	T2N, T3N	T6N, T7N, T8N, T9N, S1N	
	3,5 C3500 TOB	75x75	8	/	€ 1.160	/	€ 1.290	€ 1.290	€ 110
	3,0 x 3,0 C3030 TOB	75x75	8	€ 1.160	€ 1.160	€ 1.280	/	€ 1.280	€ 110
	2,0 x 3,0 C2030 TOB	75x75	6	€ 1.050	€ 1.050	/	/	/	€ 110
	3,0 x 2,0 C3020 TOB	75x75	6	€ 1.050	€ 1.050	/	/	/	€ 110
	3,0 x 4,0 C3040 TOB	75x75	8	€ 1.290	€ 1.290	€ 1.440	/	€ 1.440	€ 110

COLOUR RANGE - p.56

ACRILYC 350GR

Con volant / with volant



A1S T2S T3S

Senza volant / without volant



A1N T2N T3N T6N T7N T8N T9N S1N

	BASES p.40			BALLAST p.48	GROUND FIXING p.49		
	B1DS	PL1DS	BUD8080DS	-	BTAZS	CP3030ZS	CP6565ZS
3,5 C3500 TOB	€ 230	€ 390	€ 420	◆	€ 98	€ 140	€ 360
3,0 x 3,0 C3030 TOB	€ 230	€ 390	€ 420	◆	€ 98	€ 140	€ 360
2,0 x 3,0 C2030 TOB	€ 230	€ 390	€ 420	◆	€ 98	€ 140	€ 360
3,0 x 2,0 C3020 TOB	€ 230	€ 390	€ 420	◆	€ 98	€ 140	€ 360
3,0 x 4,0 C3040 TOB	€ 230	€ 390	€ 420	◆	€ 98	€ 140	€ 360

Base non compresa nel prezzo | Base not included in the price

IT

Canaline con velcro su richiesta

Ombrellone braccio laterale. Sostegno in alluminio finitura legno Iroko. Stecche in legno Iroko. Componenti in alluminio e acciaio verniciato a polveri colore antracite. Accessori in nylon.

Vedi catalogo a pag. 95

EN

Rain gutter with velcro on request

Cantilever parasol. Aluminium support provided with Iroko wood finishing, Iroko wood ribs and aluminium components epoxy coated colour anthracite grey.

See catalogue on page 95

DE

Regenrinnen mit Klettverschluss auf Anfrage

Seitenarmschirm. Alumast mit Irokoholzoptik. Streben aus Irokoholz. Alu- und Stahlbestandteile aus Aluminium pulverbeschichtet Farbe Anthrazitgrau.

Siehe katalog auf seite 95

VERIFICA LA STABILITÀ - p.50

Check stability - Vérifiez la stabilité - Stabilität prüfen - Compruebe la estabilidad - Controleer de stabiliteit

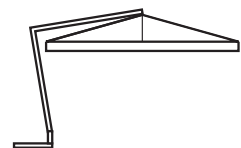

LEONARDO BRACCIO

CHARACTERISTICS



A1S

A1N

T2S, T3S

T6N, T7N, T8N, T9N, S1N



				A1S	A1N	T2S, T3S	T6N, T7N, T8N, T9N, S1N	
	4,0 C4000 LEB	92x92	8	/	€ 1.730	/	/	€ 110
	3,0 x 3,0 C3030 LEB	92x92	8	€ 1.500	€ 1.500	€ 1.620	€ 1.620	€ 110
	3,5 x 3,5 C3535 LEB	92x92	8	€ 1.730	€ 1.730	€ 1.900	€ 1.900	€ 110
	4,0 x 4,0 C4040 LEB	92x92	8	€ 2.190	€ 2.190	€ 2.400	€ 2.400	€ 130
	3,0 x 4,0 C3040 LEB	92x92	8	€ 1.660	€ 1.660	€ 1.810	€ 1.810	€ 110

COLOUR RANGE - p.56

ACRILYC 350GR

Con volant / with volant



A1S T2S T3S

Senza volant / without volant



A1N T6N T7N T8N T9N S1N

	BASES p.40			BALLAST p.48	GROUND FIXING p.49		
	B1DS	PL1DS	BUD8080DS	-	BTAZS	CP3030ZS	CP6565ZS
4,0 C4000 LEB	€ 230	€ 390	€ 420	◆	€ 98	€ 140	€ 360
3,0 x 3,0 C3030 LEB	€ 230	€ 390	€ 420	◆	€ 98	€ 140	€ 360
3,5 x 3,5 C3535 LEB	€ 230	€ 390	€ 420	◆	€ 98	€ 140	€ 360
4,0 x 4,0 C4040 LEB	/	€ 390	/	◆	€ 98	€ 140	€ 360
3,0 x 4,0 C3040 LEB	€ 230	€ 390	€ 420	◆	€ 98	€ 140	€ 360

Base non compresa nel prezzo | Base not included in the price

IT

Canaline con velcro su richiesta

Ombrellone a braccio laterale robusto.
Telaio: Alluminio e componenti in acciaio;
verniciato a polveri colore antracite.
Accessori in nylon.

Vedi catalogo a pag. 103

EN

Rain gutter with velcro on request

Strong cantilever parasol. Frame: Powder coated aluminium anthracite grey. Nylon accessories.

See catalogue on page 103

DE

Regenrinnen mit Klettverschluss auf Anfrage



Starker Pendelschirm. Gestell aus pulverbeschichtetem Aluminium Farbe Anthrazitgrau. Zubehoer aus Nylon.

Siehe katalog auf seite 103

VERIFICA LA STABILITÀ - p.50

Check stability - Vérifiez la stabilité - Stabilität prüfen - Compruebe la estabilidad - Controleer de stabiliteit

POMPEI BRACCIO

CHARACTERISTICS		A1S	A1N	T2S, T3S	T6N, T7N, T8N, T9N, S1N			
	3,0 x 3,0 C3030 PMB	92x92	8	€ 1.530	€ 1.530	€ 1.650	€ 1.650	€ 110
	3,5 x 3,5 C3535 PMB	92x92	8	€ 1.760	€ 1.760	€ 1.930	€ 1.930	€ 110
	3,0 x 4,0 C3040 PMB	92x92	8	€ 1.690	€ 1.690	€ 1.840	€ 1.840	€ 110

COLOUR RANGE - p.56

ACRILYC 350GR

Con volant / with volant



A1S T2S T3S

Senza volant / without volant



A1N T6N T7N T8N T9N S1N

PALLADIO BRACCIO

CHARACTERISTICS		A1S	A1N	T2S, T3S	T2N, T3N	T6N, T7N, T8N, T9N, S1N			
	3,5 C3500 PAB	92x92	8	/	€ 1.420	/	€ 1.550	€ 1.550	€ 110
	3,0 x 3,0 C3030 PAB	92x92	8	€ 1.420	€ 1.420	€ 1.540	/	€ 1.540	€ 110
	3,5 x 3,5 C3535 PAB	92x92	8	€ 1.650	€ 1.650	€ 1.820	/	€ 1.820	€ 110
	3,0 x 4,0 C3040 PAB	92x92	8	€ 1.580	€ 1.580	€ 1.730	/	€ 1.730	€ 110

COLOUR RANGE - p.56

ACRILYC 350GR

Con volant / with volant





A1S T2S T3S

Senza volant / without volant

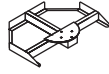
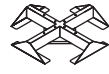
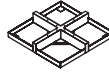

A1N T2N T3N T6N T7N T8N T9N S1N

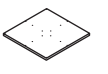
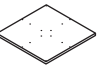
	BASES p.40			BALLAST p.48	GROUND FIXING p.49		
							
	B1BS	PL1BS	BUD8080BS	-	BTAZS	CP3030ZS	CP6565ZS
3,0 x 3,0 C3030 PMB	€ 230	€ 390	€ 420	◆	€ 98	€ 140	€ 360
3,5 x 3,5 C3535 PMB	€ 230	€ 390	€ 420	◆	€ 98	€ 140	€ 360
3,0 x 4,0 C3040 PMB	€ 230	€ 390	€ 420	◆	€ 98	€ 140	€ 360

Base non compresa nel prezzo | Base not included in the price

IT

Canaline con velcro su richiesta

Ombrellone a braccio laterale robusto. Struttura in alluminio con verniciatura a polveri epossidiche colore Starwhite.

Vedi catalogo a pag. 111

EN

Rain gutter with velcro on request

Strong cantilever parasol. Alluminium frame epoxy coated Starwhite.

See catalogue on page 111

DE



Regenrinnen mit Klettverschluss auf Anfrage

Starker Seitenarmschirm. Gestell aus Aluminium pulverbeschichtet Starwhite.

Siehe katalog auf seite 111

VERIFICA LA STABILITÀ - p.50

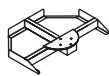
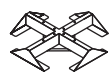
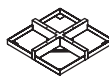
Check stability - Vérifiez la stabilité - Stabilität prüfen - Compruebe la estabilidad - Controleer de stabiliteit

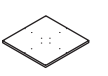
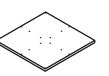
	BASES p.40			BALLAST p.48	GROUND FIXING p.49		
							
	B1DS	PL1DS	BUD8080DS	-	BTAZS	CP3030ZS	CP6565ZS
3,5 C3500 PAB	€ 230	€ 390	€ 420	◆	€ 98	€ 140	€ 360
3,0 x 3,0 C3030 PAB	€ 230	€ 390	€ 420	◆	€ 98	€ 140	€ 360
3,5 x 3,5 C3535 PAB	€ 230	€ 390	€ 420	◆	€ 98	€ 140	€ 360
3,0 x 4,0 C3040 PAB	€ 230	€ 390	€ 420	◆	€ 98	€ 140	€ 360

Base non compresa nel prezzo | Base not included in the price

IT

Canaline con velcro su richiesta

Ombrellone a braccio laterale robusto. Sostegno in alluminio con finitura legno, stecche in legno Iroko, componenti in alluminio e acciaio verniciato a polveri colore antracite. Accessori in nylon.

Vedi catalogo a pag. 119

EN

Rain gutter with velcro on request

Strong cantilever parasol. Aluminium support provided with Iroko wood finishing, Iroko wood ribs and aluminium components epoxy coated colour anthracite grey.

See catalogue on page 119

DE

Regenrinnen mit Klettverschluss auf Anfrage

Starker Seitenarmschirm. Alumast mit Holzoptik. Streben aus Irokoholz. Aluund Stahlbestandteile aus Aluminium pulverbeschichtet Farbe Anthrazitgrau.

Siehe katalog auf seite 119

VERIFICA LA STABILITÀ - p.50

Check stability - Vérifiez la stabilité - Stabilität prüfen - Compruebe la estabilidad - Controleer de stabiliteit

GALILEO DARK

CHARACTERISTICS	A1S	A1N	T2S, T3S	T6N, T7N, T8N, T9N, S1N	
3,0 x 3,0 C3030 GDR	82x82	8	€ 1.830	€ 1.830 € 1.950 € 1.950	€ 130
3,5 x 3,5 C3535 GDR	82x82	8	€ 2.160	€ 2.160 € 2.330 € 2.330	€ 130
3,0 x 4,0 C3040 GDR	82x82	8	€ 2.090	€ 2.090 € 2.240 € 2.240	€ 130

COLOUR RANGE - p.56

ACRILYC 350GR

Con volant / with volant



A1S T2S T3S

Senza volant / without volant



A1N T6N T7N T8N T9N S1N

	BASES p.40	BALLAST p.48	GROUND FIXING p.49				
	B1DS	PL1DS	BUD8080DS	-	BTASZ	CP3030ZS	CP6565ZS
3,0 x 3,0 C3030 GDR	€ 230	€ 390	€ 420	◆	€ 98	€ 140	€ 360
3,5 x 3,5 C3535 GDR	€ 230	€ 390	€ 420	◆	€ 98	€ 140	€ 360
3,0 x 4,0 C3040 GDR	€ 230	€ 390	€ 420	◆	€ 98	€ 140	€ 360

Base non compresa nel prezzo | Base not included in the price

IT

Canaline con velcro su richiesta
Telaio disponibile in 3 varianti: Dark grigio antracite – Starwhite – Wood. Ombrellone a braccio laterale con sistema di apertura e chiusura retrattile. Telaio in alluminio verniciato a polveri epossidiche. Accessori in nylon.

Vedi catalogo a pag. 127

EN

Rain gutter with velcro on request
Frame available in 3 variants: Dark anthracite – Starwhite – Wood. Cantilever parasol with retractable opening and closing system. Aluminium frame epoxy coated. Accessories in nylon.

See catalogue on page 127

DE

Regenrinnen mit Klettverschluss auf Anfrage
Gestell in 3 Varianten erhältlich: Dark Anthrazitgrau – Starwhite - Wood. Seitenarmschirm mit einziehbarem Öffnungs- und Schliessungssystem. Gestell aus pulverbeschichtetem Aluminium. Zubehör aus Nylon.

Siehe katalog auf seite 127

VERIFICA LA STABILITÀ - p.50

Check stability - Vérifiez la stabilité - Stabilität prüfen - Compruebe la estabilidad - Controleer de stabiliteit

GALILEO STARWHITE

CHARACTERISTICS	A1S	A1N	T2S, T3S	T6N, T7N, T8N, T9N, S1N	
3,0 x 3,0 C3030 GWR	82x82	8	€ 1.920	€ 1.920 € 2.030 € 2.030	€ 130
3,5 x 3,5 C3535 GWR	82x82	8	€ 2.240	€ 2.240 € 2.410 € 2.410	€ 130
3,0 x 4,0 C3040 GWR	82x82	8	€ 2.170	€ 2.170 € 2.320 € 2.320	€ 130

COLOUR RANGE - p.56

ACRILYC 350GR

Con volant / with volant



A1S T2S T3S

Senza volant / without volant



A1N T6N T7N T8N T9N S1N

	BASES p.40	BALLAST p.48	GROUND FIXING p.49				
	B1BS	PL1BS	BUD8080BS	-	BTASZ	CP3030ZS	CP6565ZS
3,0 x 3,0 C3030 GWR	€ 230	€ 390	€ 420	◆	€ 98	€ 140	€ 360
3,5 x 3,5 C3535 GWR	€ 230	€ 390	€ 420	◆	€ 98	€ 140	€ 360
3,0 x 4,0 C3040 GWR	€ 230	€ 390	€ 420	◆	€ 98	€ 140	€ 360

Base non compresa nel prezzo | Base not included in the price

IT

Canaline con velcro su richiesta
Telaio disponibile in 3 varianti: Dark grigio antracite – Starwhite – Wood. Ombrellone a braccio laterale con sistema di apertura e chiusura retrattile. Telaio in alluminio verniciato a polveri epossidiche. Accessori in nylon.

Vedi catalogo a pag. 131

EN

Rain gutter with velcro on request
Frame available in 3 variants: Dark anthracite – Starwhite – Wood. Cantilever parasol with retractable opening and closing system. Aluminium frame epoxy coated. Accessories in nylon.

See catalogue on page 131

DE



Regenrinnen mit Klettverschluss auf Anfrage
Gestell in 3 Varianten erhältlich: Dark Anthrazitgrau – Starwhite - Wood. Seitenarmschirm mit einziehbarem Öffnungs- und Schliessungssystem. Gestell aus pulverbeschichtetem Aluminium. Zubehör aus Nylon.

Siehe katalog auf seite 131

VERIFICA LA STABILITÀ - p.50

Check stability - Vérifiez la stabilité - Stabilität prüfen - Compruebe la estabilidad - Controleer de stabiliteit

GALILEO WOOD NEW

CHARACTERISTICS	A1S		A1N		T2S, T3S		T6N, T7N, T8N, T9N, S1N	
	Icon	Value	Icon	Value	Icon	Value	Icon	Value
 3,0 x 3,0 C3030 GLR	82x82	8	€ 1.990	€ 1.990	€ 2.110	€ 2.110	€ 130	
 3,5 x 3,5 C3535 GLR	82x82	8	€ 2.390	€ 2.390	€ 2.560	€ 2.560	€ 130	
 3,0 x 4,0 C3040 GLR	82x82	8	€ 2.290	€ 2.290	€ 2.440	€ 2.440	€ 130	

COLOUR RANGE - p.56

ACRILYC 350GR

Con volant / with volant

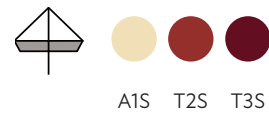

A1S T2S T3S

Senza volant / without volant



A1N T6N T7N T8N T9N S1N

	BASES p.40			BALLAST p.48	GROUND FIXING p.49		
	B1DS	PL1DS	BUD8080DS	-	BTAZS	CP3030ZS	CP6565ZS
3,0 x 3,0 C3030 GLR	€ 230	€ 390	€ 420	◆	€ 98	€ 140	€ 360
3,5 x 3,5 C3535 GLR	€ 230	€ 390	€ 420	◆	€ 98	€ 140	€ 360
3,5 x 3,5 C4040 GLR	€ 230	€ 390	€ 420	◆	€ 98	€ 140	€ 360

Base non compresa nel prezzo | Base not included in the price

IT

Canaline con velcro su richiesta

Telaio disponibile in 3 varianti: Dark grigio antracite – Starwhite – Wood. Ombrellone a braccio laterale con sistema di apertura e chiusura retrattile. Telaio in alluminio verniciato a polveri epossidiche. Accessori in nylon.

Vedi catalogo a pag. 135

EN

Rain gutter with velcro on request

Frame available in 3 variants: Dark anthracite – Starwhite – Wood. Cantilever parasol with retractable opening and closing system. Aluminium frame epoxy coated. Accessories in nylon.

See catalogue on page 135

DE

Regenrinnen mit Klettverschluss auf Anfrage

Gestell in 3 Varianten erhältlich: Dark Anthrazitgrau – Starwhite - Wood. Seitenarmschirm mit einziehbarem Öffnungs- und Schliessungssystem. Gestell aus pulverbeschichtetem Aluminium. Zubehör aus Nylon.

Siehe katalog auf seite 135

VERIFICA LA STABILITÀ - p.50

Check stability - Vérifiez la stabilité - Stabilität prüfen - Compruebe la estabilidad - Controleer de stabiliteit

GALILEO MAXI DARK

CHARACTERISTICS	A1S	A1N	T2S, T3S	T6N, T7N, T8N, T9N, S1N			
 4,0 x 4,0 C4040 GDR	92x92	8	€ 2.950	€ 2.950	€ 3.160	€ 3.160	€ 160

COLOUR RANGE - p.56

ACRILYC 350GR

Con volant / with volant

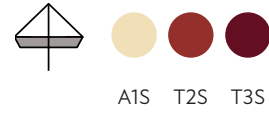

Senza volant / without volant



BASES p.40

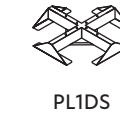

PL1DS

BALLAST p.48



-



BTAZS

GROUND FIXING p.49



CP3030ZS

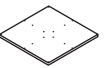

CP6565ZS

4,0 x 4,0 C4040 GDR	€ 390	◆	€ 98	€ 140	€ 360
-------------------------------	-------	---	------	-------	-------

Base non compresa nel prezzo | Base not included in the price

IT

Canaline con velcro su richiesta

Ombrellone a braccio laterale con sistema di apertura e chiusura retrattile. Telaio: Alluminio e componenti in acciaio; verniciato a polveri colore antracite o bianco. Accessori in nylon e meccanismo irrobustito.

Vedi catalogo a pag. 143

EN

Rain gutter with velcro on request

Cantilever parasol with retractable opening and closing. Frame: powder coated aluminium anthracite grey or white. Nylon accessories and strengthened mechanism.

See catalogue on page 143

DE

Regenrinnen mit Klettverschluss auf Anfrage

Pendelschirm mit einziehbarem Öffnungssystem. Gestell: Pulverbeschichtetes Aluminium Farbe Anthrazitgrau oder weiss. Nylonzubehoer und verstaerkter Mechanismus.

Siehe katalog auf seite 143

VERIFICA LA STABILITÀ - p.50

Check stability - Vérifiez la stabilité - Stabilität prüfen - Compruebe la estabilidad - Controleer de stabiliteit

26

GALILEO MAXI STARWHITE

CHARACTERISTICS	A1S	A1N	T2S, T3S	T6N, T7N, T8N, T9N, S1N			
 4,0 x 4,0 C4040 GWR	92x92	8	€ 3.050	€ 3.050	€ 3.260	€ 3.260	€ 160

COLOUR RANGE - p.56

ACRILYC 350GR

Con volant / with volant

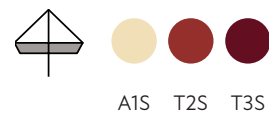

Senza volant / without volant



BASES p.40

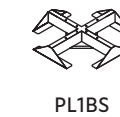

PL1BS

BALLAST p.48



-



BTAZS

GROUND FIXING p.49

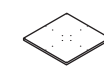

CP3030ZS



CP6565ZS

4,0 x 4,0 C4040 GWR	€ 390	◆	€ 98	€ 140	€ 360
-------------------------------	-------	---	------	-------	-------

Base non compresa nel prezzo | Base not included in the price

IT

Canaline con velcro su richiesta

Ombrellone a braccio laterale con sistema di apertura e chiusura retrattile. Telaio: Alluminio e componenti in acciaio; verniciato a polveri colore antracite o bianco. Accessori in nylon e meccanismo irrobustito.

Vedi catalogo a pag. 143

EN

Rain gutter with velcro on request

Cantilever parasol with retractable opening and closing. Frame: powder coated aluminium anthracite grey or white. Nylon accessories and strengthened mechanism.

See catalogue on page 147

DE

Regenrinnen mit Klettverschluss auf Anfrage

Pendelschirm mit einziehbarem Öffnungssystem. Gestell: Pulverbeschichtetes Aluminium Farbe Anthrazitgrau oder weiss. Nylonzubehoer und verstaerkter Mechanismus.

Siehe katalog auf seite 147

VERIFICA LA STABILITÀ - p.50

Check stability - Vérifiez la stabilité - Stabilität prüfen - Compruebe la estabilidad - Controleer de stabiliteit

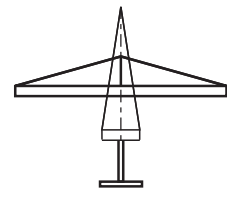

CAPRI DARK

CHARACTERISTICS



A1S

A1N

T2S, T3S

T2N, T3N

T6N, T7N, T8N,
T9N, S1N

A1

T2, T3, T6, T7,
T8, T9, S1

				A1S	A1N	T2S, T3S	T2N, T3N	T6N, T7N, T8N, T9N, S1N	A1	T2, T3, T6, T7, T8, T9, S1	
	4,0 x 4,0 C4040 CAT	100	8	€ 2.680	€ 2.680	€ 2.890	€ 2.890	€ 2.890	€ 130	€ 150	€ 160
	5,0 x 5,0 C5050 CAT	100	8	€ 3.390	€ 3.390	€ 3.750	€ 3.750	€ 3.750	€ 260	€ 300	€ 280
	6,0 x 6,0 C6060 CAT	100	8	€ 4.130	€ 4.130	€ 4.630	€ 4.630	€ 4.630	€ 260	€ 300	€ 280
	3,0 x 4,0 C3040 CAT	100	8	€ 2.590	€ 2.590	€ 2.740	€ 2.740	€ 2.740	€ 130	€ 150	€ 160
	4,0 x 5,0 C4050 CAT	100	8	€ 3.250	€ 3.250	€ 3.590	€ 3.590	€ 3.590	€ 260	€ 300	€ 280
	5,0 x 6,0 C5060 CAT	100	8	€ 3.950	€ 3.950	€ 4.390	€ 4.390	€ 4.390	€ 260	€ 300	€ 280

COLOUR RANGE - p.56

ACRILYC 350GR

Con volant / with volant



A1S T2S T3S

Senza volant / without volant



A1N T2N T3N T6N T7N T8N T9N S1N

Set canaline / Raingutter set



A1 T2 T3 T6 T7 T8 T9 S1

BASES p.40

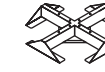

PL1DS

BALLAST p.48

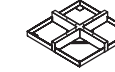

BUD8080DS



-

GROUND FIXING p.49



BTBS



CP6565ZS

4,0 x 4,0 C4040 CAT	€ 390	€ 420	◆	€ 190	€ 360
5,0 x 5,0 C5050 CAT	€ 390	/	◆	€ 190	€ 360
6,0 x 6,0 C6060 CAT	€ 390	/	◆	€ 190	€ 360
3,0 x 4,0 C3040 CAT	€ 390	€ 420	◆	€ 190	€ 360
4,0 x 5,0 C4050 CAT	€ 390	/	◆	€ 190	€ 360
5,0 x 6,0 C5060 CAT	€ 390	/	◆	€ 190	€ 360

Base non compresa nel prezzo | Base not included in the price

IT

Canaline con velcro su richiesta

Ombrellone gigante. Telaio con sistema di apertura telescopico in alluminio, componenti in acciaio verniciato a polveri colore antracite o bianca.

Vedi catalogo a pag. 155

EN

Rain gutter with velcro on request

Giant parasol. Telescopic opening system. Frame: powder coated aluminium, steel components anthracite grey or white.

See catalogue on page 155

DE

Regenrinnen mit Klettverschluss auf Anfrage

Riesenschirm. Teleskopöffnungssystem. Gestell: Pulverbeschichtetes Aluminium. Farbe Anthrazitgrau oder weiss, Bestandteile aus Stahl.

Siehe katalog auf seite 155

VERIFICA LA STABILITÀ - p.50

Check stability - Vérifiez la stabilité - Stabilität prüfen - Compruebe la estabilidad - Controleer de stabiliteit

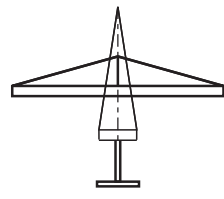

CAPRI STARWHITE

CHARACTERISTICS



A1S

A1N

T2S, T3S

T2N, T3N

T6N, T7N, T8N,
T9N, S1N



A1



T2, T3, T6, T7,
T8, T9, S1



				A1S	A1N	T2S, T3S	T2N, T3N	T6N, T7N, T8N, T9N, S1N	A1	T2, T3, T6, T7, T8, T9, S1	
	4,0 x 4,0 C4040 CAW	100	8	€ 2.760	€ 2.760	€ 2.970	€ 2.970	€ 2.970	€ 130	€ 150	€ 160
	5,0 x 5,0 C5050 CAW	100	8	€ 3.490	€ 3.490	€ 3.850	€ 3.850	€ 3.850	€ 260	€ 300	€ 280
	6,0 x 6,0 C6060 CAW	100	8	€ 4.260	€ 4.260	€ 4.760	€ 4.760	€ 4.760	€ 260	€ 300	€ 280
	3,0 x 4,0 C3040 CAW	100	8	€ 2.670	€ 2.670	€ 2.820	€ 2.820	€ 2.820	€ 130	€ 150	€ 160
	4,0 x 5,0 C4050 CAW	100	8	€ 3.350	€ 3.350	€ 3.690	€ 3.690	€ 3.690	€ 260	€ 300	€ 280
	5,0 x 6,0 C5060 CAW	100	8	€ 4.080	€ 4.080	€ 4.520	€ 4.520	€ 4.520	€ 260	€ 300	€ 280

COLOUR RANGE - p.56

ACRILYC 350GR

Con volant / with volant

Senza volant / without volant

Set canaline / Raingutter set



A1S T2S T3S



A1N T2N T3N T6N T7N T8N T9N S1N



A1 T2 T3 T6 T7 T8 T9 S1

BASES p.40

BALLAST p.48

GROUND FIXING p.49

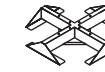

PL1BS

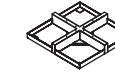

BUD8080BS



-



BTBS

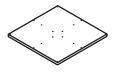

CP6565ZS

4,0 x 4,0 C4040 CAW	€ 390	€ 420	◆	€ 190	€ 360
5,0 x 5,0 C5050 CAW	€ 390	/	◆	€ 190	€ 360
6,0 x 6,0 C6060 CAW	€ 390	/	◆	€ 190	€ 360
3,0 x 4,0 C3040 CAW	€ 390	€ 420	◆	€ 190	€ 360
4,0 x 5,0 C4050 CAW	€ 390	/	◆	€ 190	€ 360
5,0 x 6,0 C5060 CAW	€ 390	/	◆	€ 190	€ 360

Base non compresa nel prezzo | Base not included in the price

IT

Canaline con velcro su richiesta

Ombrellone gigante. Telaio con sistema di apertura telescopico in alluminio, componenti in acciaio verniciato a polveri colore antracite o bianca.

Vedi catalogo a pag. 159

EN

Rain gutter with velcro on request

Giant parasol. Telescopic opening system. Frame: powder coated aluminium, steel components anthracite grey or white.

See catalogue on page 159

DE

Regenrinnen mit Klettverschluss auf Anfrage

Riesenschirm. Teleskopöffnungssystem. Gestell: Pulverbeschichtetes Aluminium. Farbe Anthrazitgrau oder weiss, Bestandteile aus Stahl.

Siehe katalog auf seite 159

VERIFICA LA STABILITÀ - p.50

Check stability - Vérifiez la stabilité - Stabilität prüfen - Compruebe la estabilidad - Controleer de stabiliteit

ALU POKER DARK

CHARACTERISTICS	A1S	A1N	T2S, T3S	T6N, T7N, T8N, T9N, S1N	A1	T2, T3, T6, T7, T8, T9, S1		
 6,0 x 6,0 C6060 APO	120x120	€ 6.220	€ 6.220	€ 6.700	€ 6.700	€ 520	€ 600	€ 440
 7,0 x 7,0 C7070 APO	120x120	€ 7.130	€ 7.130	€ 7.810	€ 7.810	€ 520	€ 600	€ 440

COLOUR RANGE - p.56

ACRILYC 350GR

Con volant / with volant

Senza volant / without volant

Set canaline / Raingutter set



BASES p.40

BALLAST p.48

GROUND FIXING p.49

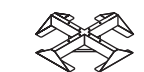

PL1DS

-

BTBS

CP6565ZS

6,0 x 6,0 C6060 APO	€ 390	◆	€ 190	€ 360
7,0 x 7,0 C7070 APO	€ 390	◆	€ 190	€ 360

Base non compresa nel prezzo | Base not included in the price

IT

Canaline con velcro su richiesta
Struttura robusta composta da 4 ombrelloni (Poker) oppure da 2 ombrelloni (Double). Telaio in alluminio e componenti in acciaio; verniciato a polveri colore antracite/bianco. Accessori in nylon e meccanismo irrobustito.

Vedi catalogo a pag. 167

EN

Rain gutter with velcro on request
Strong structure made of 4 cantilever parasols (Poker) or 2 cantilever parasols (Double). Frame in coated aluminium and steel components powder coated anthracite grey/white. Nylon accessories and strengthened mechanism.

See catalogue on page 167

DE

Regenrinnen mit Klettverschluss auf Anfrage
Starke Gestell mit 4 Pendelschirmen (Poker) oder 2 Pendelschirmen (Double) Gestell aus pulverbeschichtetem Aluminium und Bestandteile aus Stahl Farbe Anthrazitgrau/Weiß. Nylonzubehoer und verstaerkter Mechanismus.

Siehe katalog auf seite 167

VERIFICA LA STABILITÀ - p.50

Check stability - Vérifiez la stabilité - Stabilität prüfen - Compruebe la estabilidad - Controleer de stabiliteit

ALU DOUBLE DARK

CHARACTERISTICS	A1S	A1N	T2S, T3S	T6N, T7N, T8N, T9N, S1N	A1	T2, T3, T6, T7, T8, T9, S1		
 3,0 x 6,0 C3060 ADO	120x120	€ 3.630	€ 3.630	€ 3.870	€ 3.870	€ 130	€ 150	€ 220
 3,5 x 7,0 C3570 ADO	120x120	€ 4.220	€ 4.220	€ 4.560	€ 4.560	€ 130	€ 150	€ 220

COLOUR RANGE - p.56

ACRILYC 350GR

Con volant / with volant

Senza volant / without volant

Set canaline / Raingutter set



BASES p.40

BALLAST p.48

GROUND FIXING p.49



PL1DS

-

BTBS

CP6565ZS

3,0 x 6,0 C3060 ADO	€ 390	◆	€ 190	€ 360
3,5 x 7,0 C3570 ADO	€ 390	◆	€ 190	€ 360

Base non compresa nel prezzo | Base not included in the price

IT

Canaline con velcro su richiesta
Struttura robusta composta da 4 ombrelloni (Poker) oppure da 2 ombrelloni (Double). Telaio in alluminio e componenti in acciaio; verniciato a polveri colore antracite/bianco. Accessori in nylon e meccanismo irrobustito.

Vedi catalogo a pag. 167

EN

Rain gutter with velcro on request
Strong structure made of 4 cantilever parasols (Poker) or 2 cantilever parasols (Double). Frame in coated aluminium and steel components powder coated anthracite grey/white. Nylon accessories and strengthened mechanism.

See catalogue on page 167

DE

Regenrinnen mit Klettverschluss auf Anfrage
Starke Gestell mit 4 Pendelschirmen (Poker) oder 2 Pendelschirmen (Double) Gestell aus pulverbeschichtetem Aluminium und Bestandteile aus Stahl Farbe Anthrazitgrau/Weiß. Nylonzubehoer und verstaerkter Mechanismus.

Siehe katalog auf seite 167

VERIFICA LA STABILITÀ - p.50

Check stability - Vérifiez la stabilité - Stabilität prüfen - Compruebe la estabilidad - Controleer de stabiliteit

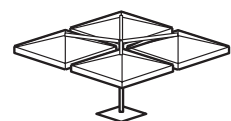

ALU POKER STARWHITE

CHARACTERISTICS	A1S	A1N	T2S, T3S	T6N, T7N, T8N, T9N, S1N	A1	T2, T3, T6, T7, T8, T9, S1		
6,0 x 6,0 C6060 APW	120x120	€ 6.370	€ 6.370	€ 6.850	€ 6.850	€ 520	€ 600	€ 440
7,0 x 7,0 C7070 APW	120x120	€ 7.280	€ 7.280	€ 7.960	€ 7.960	€ 520	€ 600	€ 440

COLOUR RANGE - p.56

ACRILYC 350GR

Con volant / with volant

Senza volant / without volant

Set canaline / Raingutter set



BASES p.40

BALLAST p.48

GROUND FIXING p.49



	PL1BS	-	BTBS	CP6565ZS
6,0 x 6,0 C6060 APW	€ 390	◆	€ 190	€ 360
7,0 x 7,0 C7070 APW	€ 390	◆	€ 190	€ 360

Base non compresa nel prezzo | Base not included in the price

IT

Canaline con velcro su richiesta

Struttura robusta composta da 4 ombrelloni (Poker) oppure da 2 ombrelloni (Double).

Telaio in alluminio e componenti in acciaio; verniciato a polveri colore antracite/bianco.

Accessori in nylon e meccanismo irrobustito.

EN

Rain gutter with velcro on request

Strong structure made of 4 cantilever parasols (Poker) or 2 cantilever parasols (Double). Frame in coated aluminium and steel components

powder coated anthracite grey/white. Nylon accessories and strengthened mechanism.

DE

Regenrinnen mit Klettverschluss auf Anfrage

Starke Gestell mit 4 Pendelschirmen (Poker) oder 2 Pendelschirmen (Double) Gestell aus pulverbeschichtetem Aluminium und

Bestandteile aus Stahl Farbe Anthrazitgrau/Weiß. Nylonzubehoer und verstaerkter Mechanismus.

Mechanismus.

Vedi catalogo a pag. 171

See catalogue on page 171

Siehe katalog au seite 171

VERIFICA LA STABILITÀ - p.50

Check stability - Vérifiez la stabilité - Stabilität prüfen - Compruebe la estabilidad - Controleer de stabiliteit

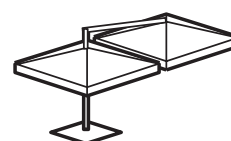

ALU DOUBLE STARWHITE

CHARACTERISTICS	A1S	A1N	T2S, T3S	T6N, T7N, T8N, T9N, S1N	A1	T2, T3, T6, T7, T8, T9, S1		
3,0 x 6,0 C3060 ADW	120x120	€ 3.750	€ 3.750	€ 3.990	€ 3.990	€ 130	€ 150	€ 220
3,5 x 7,0 C3570 ADW	120x120	€ 4.340	€ 4.340	€ 4.680	€ 4.680	€ 130	€ 150	€ 220

COLOUR RANGE - p.56

ACRILYC 350GR

Con volant / with volant

Senza volant / without volant

Set canaline / Raingutter set



BASES p.40

BALLAST p.48

GROUND FIXING p.49

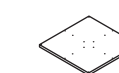

	PL1BS	-	BTBS	CP6565ZS
3,0 x 6,0 C3060 ADW	€ 390	◆	€ 190	€ 360
3,5 x 7,0 C3570 ADW	€ 390	◆	€ 190	€ 360

Base non compresa nel prezzo | Base not included in the price

IT

Canaline con velcro su richiesta

Struttura robusta composta da 4 ombrelloni (Poker) oppure da 2 ombrelloni (Double).

Telaio in alluminio e componenti in acciaio; verniciato a polveri colore antracite/bianco.

Accessori in nylon e meccanismo irrobustito.

EN

Rain gutter with velcro on request

Strong structure made of 4 cantilever parasols (Poker) or 2 cantilever parasols (Double). Frame in coated aluminium and steel components

powder coated anthracite grey/white. Nylon accessories and strengthened mechanism.

DE

Regenrinnen mit Klettverschluss auf Anfrage

Starke Gestell mit 4 Pendelschirmen (Poker) oder 2 Pendelschirmen (Double) Gestell aus pulverbeschichtetem Aluminium und

Bestandteile aus Stahl Farbe Anthrazitgrau/Weiß. Nylonzubehoer und verstaerkter Mechanismus.

Mechanismus.

Vedi catalogo a pag. 171

See catalogue on page 171

Siehe katalog auf seite 171

VERIFICA LA STABILITÀ - p.50

Check stability - Vérifiez la stabilité - Stabilität prüfen - Compruebe la estabilidad - Controleer de stabiliteit

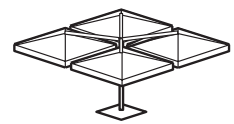

WOOD POKER

CHARACTERISTICS	A1S	A1N	T2S, T3S	T6N, T7N, T8N, T9N, S1N	A1	T2, T3, T6, T7, T8, T9, S1		
6,0 x 6,0 C6060 WPO	120x120	€ 5.630	€ 5.630	€ 6.110	€ 6.110	€ 440	€ 520	€ 600
7,0 x 7,0 C7070 WPO	120x120	€ 6.540	€ 6.540	€ 7.220	€ 7.220	€ 440	€ 520	€ 600

COLOUR RANGE - p.56

ACRILYC 350GR

Con volant / with volant

Senza volant / without volant

Set canaline / Raingutter set

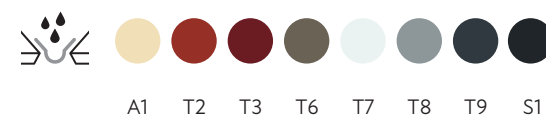

BASES p.40

BALLAST p.48

GROUND FIXING p.49

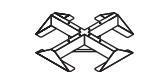

	PL1DS	-	BTBS	CP6565ZS
6,0 x 6,0 C6060 WPO	€ 390	◆	€ 190	€ 360
7,0 x 7,0 C7070 WPO	€ 390	◆	€ 190	€ 360

Base non compresa nel prezzo | Base not included in the price

IT

Canaline con velcro su richiesta

Struttura robusta composta da 4 ombrelloni (Poker) oppure da 2 ombrelloni (Double). Telaio in alluminio e componenti in acciaio; verniciato a polveri colore antracite/bianco. Accessori in nylon e meccanismo irrobustito.

Vedi catalogo a pag. 175

EN

Rain gutter with velcro on request

Strong structure made of 4 cantilever parasols (Poker) or 2 cantilever parasols (Double). Frame in coated aluminium and steel components powder coated anthracite grey/white. Nylon accessories and strengthened mechanism.

See catalogue on page 175

DE

Regenrinnen mit Klettverschluss auf Anfrage

Starke Gestell mit 4 Pendelschirmen (Poker) oder 2 Pendelschirmen (Double) Gestell aus pulverbeschichtetem Aluminium und Bestandteile aus Stahl Farbe Anthrazitgrau/Weiß. Nylonzubehoer und verstaerkter Mechanismus.

Siehe katalog auf seite 175

VERIFICA LA STABILITÀ - p.50

Check stability - Vérifiez la stabilité - Stabilität prüfen - Compruebe la estabilidad - Controleer de stabiliteit

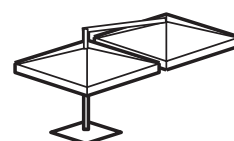

WOOD DOUBLE

CHARACTERISTICS	A1S	A1N	T2S, T3S	T6N, T7N, T8N, T9N, S1N	A1	T2, T3, T6, T7, T8, T9, S1		
3,0 x 6,0 C3060 WDO	120x120	€ 3.420	€ 3.420	€ 3.660	€ 3.660	€ 130	€ 150	€ 220
3,5 x 7,0 C3570 WDO	120x120	€ 3.820	€ 3.820	€ 4.160	€ 4.160	€ 130	€ 150	€ 220

COLOUR RANGE - p.56

ACRILYC 350GR

Con volant / with volant

Senza volant / without volant

Set canaline / Raingutter set



BASES p.40

BALLAST p.48

GROUND FIXING p.49



	PL1DS	-	BTBS	CP6565ZS
3,0 x 6,0 C3060 WDO	€ 390	◆	€ 190	€ 360
3,5 x 7,0 C3570 WDO	€ 390	◆	€ 190	€ 360

Base non compresa nel prezzo | Base not included in the price

IT

Canaline con velcro su richiesta

Struttura robusta composta da 4 ombrelloni (Poker) oppure da 2 ombrelloni (Double). Telaio in alluminio e componenti in acciaio; verniciato a polveri colore antracite/bianco. Accessori in nylon e meccanismo irrobustito.

Vedi catalogo a pag. 175

EN

Rain gutter with velcro on request

Strong structure made of 4 cantilever parasols (Poker) or 2 cantilever parasols (Double). Frame in coated aluminium and steel components powder coated anthracite grey/white. Nylon accessories and strengthened mechanism.

See catalogue on page 175

DE

Regenrinnen mit Klettverschluss auf Anfrage

Starke Gestell mit 4 Pendelschirmen (Poker) oder 2 Pendelschirmen (Double) Gestell aus pulverbeschichtetem Aluminium und Bestandteile aus Stahl Farbe Anthrazitgrau/Weiß. Nylonzubehoer und verstaerkter Mechanismus.

Siehe katalog auf seite 175

VERIFICA LA STABILITÀ - p.50

Check stability - Vérifiez la stabilité - Stabilität prüfen - Compruebe la estabilidad - Controleer de stabiliteit

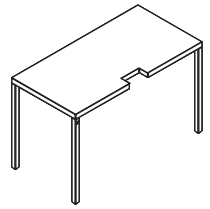

ROMEO **NEW**

CHARACTERISTICS

	KG ↓	€
1200 x 600 x 750 T75D	38 Kg	€ 550
1200 x 600 x 750 T75W	38 Kg	€ 550

COLOUR RANGE



T75D T75W

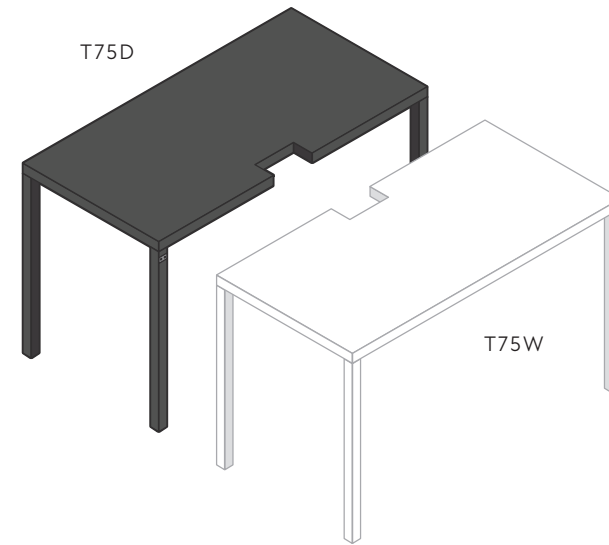

IT

Forma e design essenziale: una proposta ideata per le esigenze della ristorazione. Linee regolari ma eleganti con la massima versatilità per valorizzare spazi prima inutilizzati. Struttura in acciaio zincato e verniciato, adatto per tutte le stagioni. Con calamita per un facile e veloce accoppiamento.

Vedi catalogo a pag. 183

EN

Essential shape and design: a proposal developed for the demands of the HORECA sector. Regular yet elegant lines with maximum versatility to enhance unused spaces. Galvanized and painted steel frame, suitable for all seasons. With magnet for quick and easy coupling. Available in dark and Starwhite finish.

See catalogue on page 183

DE

Minimale Form und Design: geeignet fuer den Gastronomiebedarf. Regelmässige, aber elegante Linien mit maximaler Vielseitigkeit, um bisher ungenutzte Raume aufzuwerten. Struktur aus verzinktem und lackiertem Stahl, fuer alle Jahreszeiten geeignet. Mit Magnet fuer ein schnelles und einfaches Zusammenstellen.

Siehe katalog auf seite 183

38

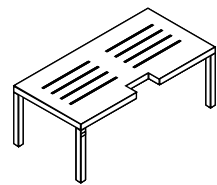

GIULIETTA **NEW**

CHARACTERISTICS

	KG ↓	€
1200 x 600 x 450 P45D	18 Kg	€ 550
1200 x 600 x 450 P45W	18 Kg	€ 550

COLOUR RANGE



P45D P45W

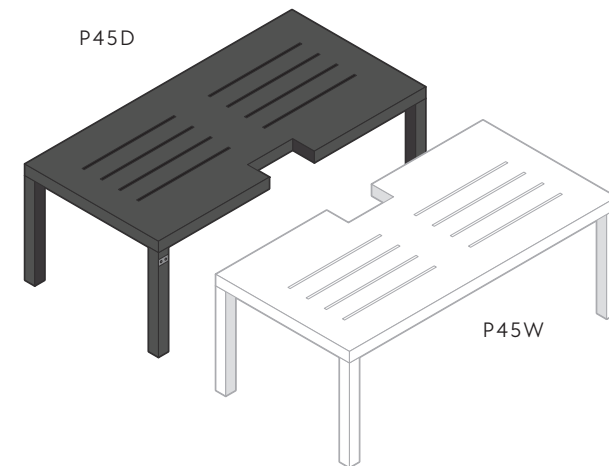

IT

Pratica e robusta, un contributo per tutti i dehor. Sfrutta l'area di ingombro della base trasformandola in un'ulteriore zona di seduta e rendendo l'ombrellone utilizzabile per tutta la sua superficie. Struttura in acciaio zincato e verniciato. Con calamita per un facile e veloce accoppiamento.

Vedi catalogo a pag. 185

EN

Practical and sturdy, a useful contribution to all patios. Capitalizes the footprint area of the base by transforming it into an additional seating area and making the umbrella operable for its entire surface area. Galvanized and painted steel frame, suitable for all seasons. With magnet for quick and easy coupling. Available in dark and starwhite finish.

See catalogue on page 185

DE

Vielseitig und stark, geeignet fuer alle Aussenbereiche. Die Flaechen des Staenders wird genutzt und in eine zusaetzliche Sitzflaechen verwandelt. Somit ist der Schirm auf seiner gesamten Flaechen nutzbar. Gestell aus verzinktem und lackiertem Stahl. Mit Magnet fuer ein schnelles und einfaches Zusammenstellen.

Siehe katalog auf seite 185

39

BASES STANDARD / TELESCOPIC



BT45 - BT55 - BT65

- Tubo in acciaio zincato. Doppio galletto. Viteria inclusa.
- Steel zinced tube. Double wing nut. Screws included.
- Verzinkte Stahlhülse. Doppelte Hutmutter. Schrauben inbegriffen.
- Tube acier zingué. Avec écrou papillon. Visserie incl.
- Tubo de acero galvanizado. Los tornillos incluidos.
- Koker gegalvaniseerd. Inclusief schroeven.

				KG	€
BT45	42 mm	45 mm	36-40 mm		
BT55	52 mm	55 mm	47-50 mm	1 Kg	€ 22
BT65	62 mm	65 mm	55-60 mm		

BTT45 - BTT55 - BTT65

- Tubo acciaio per fissaggio a terra. Eventualmente da abbinare all'articolo BTC.
- Steel tube for ground fixing. Possibility to combine it with Art BTC.
- Stahlhülse fuer Bodenbefestigung. Eventuell mit Art BTC kombinierbar.
- Tube en acier pour fixation au sol. Eventuellement à joindre avec BTC.
- Tubo de acero para sujeción al suelo. Posiblemente para que coincida con el artículo BTC.
- Metalen koker voor betonanker. Te gebruiken in combinatie met artikel BTC.

				KG	€
BTT45	42 mm	45 mm	36-40 mm		
BTT55	52 mm	55 mm	47-50 mm	1 Kg	€ 30
BTT65	62 mm	65 mm	55-60 mm		

BTC

- Supporto da interrare. Da abbinare a BTT55 e BTT65.
- supporta for ground fixing. To combine with BTT55 and BTT65.
- Staender zum einbetonieren. Kombinierbar mit BTT55 und BTT65.
- Pied pour fixation au sol. A joindre avec BTT55 et BTT65.
- Pie para fijar al suelo. Combinar con BTT55 y BTT65.
- Betonanker, te gebruiken in combinatie met BTT55 en BTT65.

		KG	€
BTC	47-50 mm	1,3 Kg	€ 66



BF6565D - BF6666D

- Base in acciaio colore antracite. Tubo incl.
- Steel base colour antracite grey. Tube incl.
- Stahlstaender grau pulverbeschichtet. Hülse inbegriffen.
- Pied en acier vernis coul. gris. Tube incl.
- Pie de acero de color antracita. Tubo incluido.
- Parasolvoet grijs geëpoxeerde metaalplaat. Wordt geleverd met koker.

				KG	€
BF6565D/T45	42 mm	45 mm	36-40 mm		
BF6565D/T55	650x650x15 mm	52 mm	55 mm	47-50 mm	35 Kg € 350
BF6565D/T65	62 mm	65 mm	55-60 mm		
BF6666D/T45	42 mm	45 mm	36-40 mm		
BF6666D/T55	650x650x25 mm	52 mm	55 mm	47-50 mm	70 kg € 660
BF6666D/T65	62 mm	65 mm	55-60 mm		

BF6565W - BF6666W **NEW**

- Base in acciaio Starwhite. Tubo incl.
- Starwhite finish steel base. Tube included.
- Stahlstaender pulverbeschichtet Farbe weiss. Hülse inbegriffen.
- Pied en acier vernis Starwhite. Tube inclus.
- Base de acero pintado Starwhite. Tubo incluido.
- Parasolvoet metaal in witte kleur. Wordt geleverd met koker.

				KG	€
BF6565W/T45	42 mm	45 mm	36-40 mm		
BF6565W/T55	650x650x15 mm	52 mm	55 mm	47-50 mm	35 Kg € 380
BF6565W/T65	62 mm	65 mm	55-60 mm		
BF6666W/T45	42 mm	45 mm	36-40 mm		
BF6666W/T55	650x650x25 mm	52 mm	55 mm	47-50 mm	70 kg € 690
BF6666W/T65	62 mm	65 mm	55-60 mm		

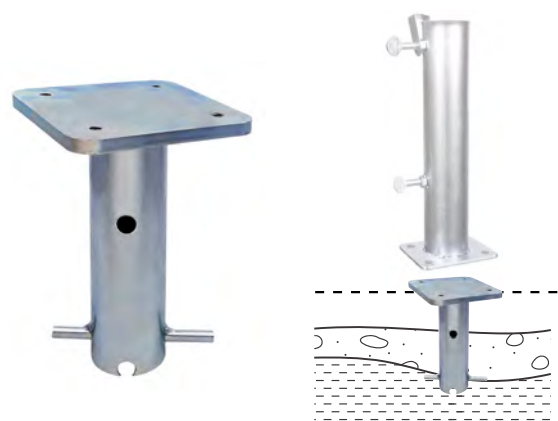



BQ8080ZS

- Base a croce metallica zincata. Disponibile con BTT55 e BTT65. Tubo incluso. Da abbinare a 8 piastre cemento Art.BC4040
- Zinced cross metal base. Available with BTT55 and BTT65. Tube included. To combine with 8 cement plates Art.BC4040
- Verzinkte Stahlplattenstaender. Verfuegbar mit BTT55 und BTT65. Huelse inbegriffen. Zum kombinieren mit 8 Betonplatten Art.BC4040
- Pied en acier galvanisé. Disponible avec BTT55 et BTT65. Tube incl. À combiner avec 8 dalles ciment Art.BC4040
- Base de metal galvanizado. Disponible con BTT55 y BTT65. Tubo incluido. Para combinar con 8 placas de hormigón Art.BC4040
- Metalen basis, verzinkt. Verkrijgbaar met BTT55 en BTT65. Tube inbegrepen. Te combineren met 8 betonplaten Art.BC4040

BQ8080ZS/T55	850x850 mm	52 mm	55 mm	47-50 mm	8 Kg	€ 180
BQ8080ZS/T65		62 mm	65 mm	55-60 mm		



BUD8080BS

- Base a croce metallica colore bianco Starwhite. Disponibile con BTT55 e BTT65. Tubo incluso. Da abbinare a 12 piastre cemento Art.BC4040
- White cross metal base. Available with BTT55 and BTT65. Tube included. To combine with 12 cement plates Art.BC4040
- Weisser Stahlplattenstaender. Verfuegbar mit BTT55 und BTT65. Huelse inbegriffen. Zum kombinieren mit 12 Betonplatten Art.BC4040
- Pied en acier blanc. Disponible avec BTT55 et BTT65. Tube incl. À combiner avec 12 dalles ciment Art.BC4040
- Base de metal blanca. Disponible con BTT55 y BTT65. Tubo incluido. Para combinar con 12 placas de hormigón Art.BC4040
- Wit metalen basis. Verkrijgbaar met BTT55 en BTT65. Tube inbegrepen. Te combineren met 12 betonplaten Art.BC4040

BUD8080BS/T55	850x850 mm	52 mm	55 mm	47-50 mm	32 Kg	€ 420
BUD8080BS/T65		62 mm	65 mm	55-60 mm		



BQ8080DS

- Base a croce metallica colore antracite. Disponibile con BTT55 e BTT65. Tubo incluso. Da abbinare a 8 piastre cemento Art.BC4040
- Dark cross metal base. Available with BTT55 and BTT65. Tube included. To combine with 8 cement plates Art.BC4040
- Stahlplattenstaender Anthrazitgrau. Verfuegbar mit BTT55 und BTT65. Huelse inbegriffen. Zum kombinieren mit 8 Betonplatten Art.BC4040
- Pied en acier gris. Disponible avec BTT55 et BTT65. Tube incl. À combiner avec 8 dalles ciment Art.BC4040
- Base de metal gris. Disponible con BTT55 y BTT65. Tubo incluido. Para combinar con 8 placas de hormigón Art.BC4040
- Metalen basis. Houtskoolgrijs. Verkrijgbaar met BTT55 en BTT65. Tube inbegrepen. Te combineren met 8 betonplaten Art.BC4040

BQ8080DS/T55	850x850 mm	52 mm	55 mm	47-50 mm	8 Kg	€ 198
BQ8080DS/T65		62 mm	65 mm	55-60 mm		



BUD8080DS

- Base a croce metallica colore antracite. Disponibile con BTT55 e BTT65. Tubo incluso. Da abbinare a 12 piastre cemento Art.BC4040
- Dark cross metal base. Available with BTT55 and BTT65. Tube included. To combine with 12 cement plates Art.BC4040
- Stahlplattenstaender anthrazitgrau. Verfuegbar mit BTT55 und BTT65. Huelse inbegriffen. Zum kombinieren mit 12 Betonplatten Art.BC4040
- Pied en acier gris. Disponible avec BTT55 et BTT65. Tube incl. À combiner avec 12 dalles ciment Art.BC4040
- Base de metal gris. Disponible con BTT55 y BTT65. Tubo incluido. Para combinar con 12 placas de hormigón Art.BC4040
- Metalen basis. Houtskoolgrijs. Verkrijgbaar met BTT55 en BTT65. Tube inbegrepen. Te combineren met 12 betonplaten Art.BC4040

BUD8080DS/T55	850x850 mm	52 mm	55 mm	47-50 mm	32 Kg	€ 420
BUD8080DS/T65		62 mm	65 mm	55-60 mm		

BC35MA4 NEW

- Base in cemento graniglia bianca con maniglie. Disponibile con tubo BTT45, BTT55, BTT65. Tubo incluso.
- White cement grit base with handles. Available with tube BTT45, BTT55, BTT65. Tube incl.
- Weisser Kiesbetonstaender mit Handgriffen. Verfuegbar mit Huelse BTT45, BTT55, BTT65. Huelse inbegr.
- Pied ciment grés blanc avec poignées. Disponible avec tube BTT45, BTT55, BTT65. Tube incl.
- Base de cemento y arena blanca con asas. Disponible con tubo BTT45, BTT55, BTT65. Tubo incluido.
- Wit parasolvoet gewassen grind met handgrepen. Inclusief koker, maat naar keuze: BTT45, BTT55, BTT65.

					KG	€
BC35MA4/T45		42 mm	45 mm	36-40 mm		
BC35MA4/T55	Ø 540 mm	52 mm	55 mm	47-50 mm	35 Kg	€ 82
BC35MA4/T65		62 mm	65 mm	55-60 mm		

BC55MA4/BC80MA4

- Base in cemento graniglia bianca con maniglie. Disponibile con tubo BTT45, BTT55, BTT65 Tubo incluso.
- White cement grit base with handles. Available with tube BTT45, BTT55, BTT65. Tube incl.
- Weisser Kiesbetonstaender mit Handgriffen. Verfuegbar mit Huelse BTT45, BTT55, BTT65. Huelse inbegr.
- Pied ciment grés blanc avec poignées. Disponible avec tube BTT45, BTT55, BTT65. Tube incl.
- Base de cemento y arena blanca con asas. Disponible con tubo BTT45, BTT55, BTT65. Tubo incluido.
- Wit parasolvoet gewassen grind met handgrepen. Inclusief koker, maat naar keuze: BTT45, BTT55, BTT65.

					KG	€
BC55MA4/T45		42 mm	45 mm	36-40 mm		
BC55MA4/T55	Ø 600 mm	52 mm	55 mm	47-50 mm	55 Kg	€ 98
BC55MA4/T65		62 mm	65 mm	55-60 mm		
BC80MA4/T45		42 mm	45 mm	36-40 mm		
BC80MA4/T55	Ø 640 mm	52 mm	55 mm	47-50 mm	80 Kg	€ 130
BC80MA4/T65		62 mm	65 mm	55-60 mm		

BC5151GRA4

- Piastra in cemento grigio con maniglie. Disponibile con tubo BTT45, BTT55, BTT65. Tubo incluso.
- Concrete grey cement slab with handles. Available with tube BTT45, BTT55, BTT65. Tube incl.
- Graue Betonplatte mit Handgriffen. Verfuegbar mit Huelse BTT45, BTT55, BTT65. Huelse inbegr.
- Dalles ciment couleur gris avec poignées. Disponible avec tube BTT45, BTT55, BTT65. Tube incl.
- Base de cemento gris con asas. Disponible con tubo BTT45, BTT55, BTT65. Tubo incluido.
- Betontegel grijs met handgrepen. Inclusief koker, maat naar keuze: BTT45, BTT55, BTT65.

					KG	€
BC5151GRA4/T45		42 mm	45 mm	36-40 mm		
BC5151GRA4/T55	500x500 mm	52 mm	55 mm	47-50 mm	60 Kg	€ 165
BC5151GRA4/T65		62 mm	65 mm	55-60 mm		

OPTIONAL CROSS METAL BASES

B1DS

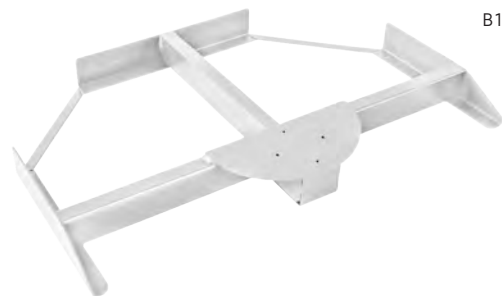

B1BS



PL1DS

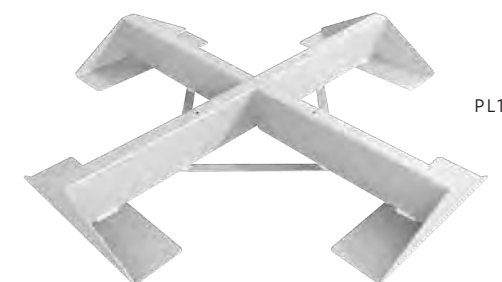

PL1BS

B1DS - B1BS

- Base metallica opzionale per ombrelloni a braccio laterale.
- Optional metal base for side arm parasols.
- Optionaler Metallstaender fuer Ampelschirme.
- Base en métal en option pour parasols à bras déporté.
- Base de metal opcional para sombrillas de brazos laterales.
- Optionele metalen voet voor zijarmparaplu's.

		KG	€
B1DS			
B1BS	1070x710x85 mm	15 Kg	€ 230

PL1DS - PL1BS

- Base a croce metallica opzionale
- Optional cross metal base
- Optionaler Kreuz-Metallstaender
- Base croix en métal en option
- Base cruz de metal opcional
- Optionele kruis metalen

		KG	€
PL1DS			
PL1BS	1090x1090x130 mm	22 Kg	€ 390

Pag. 48

Da completare:

To be completed / Ballast ergaenzen /
A compléter avec ballasts / Completar con losas /
Aan te vullen met voorschakelapparaten

con zavorre

Available ballasts / Verfuegbarer Ballast /
Ballasts disponibles / Losas disponibles /
Beschikbare ballasten

Pag. 50

schema di stabilità

see stability diagram / Stabilitaetsdiagramm /
diagramme de stabilité / diagrama de estabilidad /
stabiliteitsdiagram

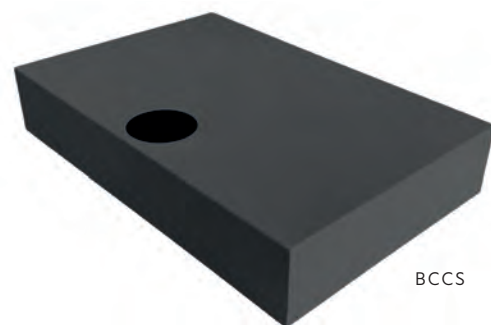

BCCS

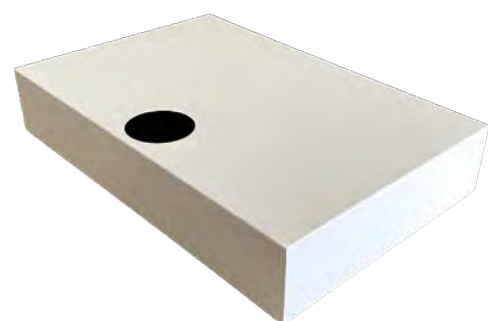

BCWS

BCCS - BCWS

- Carter acciaio zincato e verniciato a polveri. Colori disponibili dark-Starwhite. Compatibile con base B1DS-B1BS.
- Zincated and epoxy coated steel carter. Available colors dark-Starwhite. Compatible with base B1DS-B1BS.
- Verzinkter und pulverbeschichteter Stahlcarter. Erhaeltliche Farben dark-Starwhite. Kompatibel mit Staender B1DS-B1BS.
- Carter acier galvanisé et vernis. Couleurs disponibles dark-Starwhite. Compatible avec socle B1DS-B1BS.
- Carter de acero galvanizado y pintado. Colores disponibles dark-Starwhite. Compatible con base B1DS-B1BS.
- Gegalvaniseerd en geepoxeerde metaalcarter. Beschikbare kleuren dark-Starwhite. Compatibel met basis B1DS-B1BS.

		KG	€
BCCS	1100x720x200 mm	18 Kg	€ 380
BCWS			

BDCS - BDWS

- Carter acciaio zincato e verniciato a polveri. Colori disponibili dark-Starwhite. Compatibile con base PL1DS-PL1BS.
- Zincated and epoxy coated steel carter. Available colors dark-Starwhite. Compatible with base PL1DS-PL1BS.
- Verzinkter und pulverbeschichteter Stahlcarter. Erhaeltliche Farben dark-Starwhite. Kompatibel mit Staender PL1DS-PL1BS.
- Carter acier galvanisé et vernis. Couleurs disponibles dark-Starwhite. Compatible avec socle PL1DS-PL1BS.
- Carter de acero galvanizado y pintado. Colores disponibles dark-Starwhite. Compatible con base PL1DS-PL1BS.
- Gegalvaniseerd en geepoxeerde metaalcarter. Beschikbare kleuren dark-Starwhite. Compatibel met basis PL1DS-PL1BS.

		KG	€
BDCS	1130x1130x120 mm	21 Kg	€ 390
BDWS			



BDC8080DS



BDC8080BS

BDC8080

- Carter acciaio zincato e verniciato a polveri. Colori disponibili Dark-Starwhite. Compatibile con base BUD8080.
- Zincated and epoxy coated steel carter. Available colors Dark-Starwhite. Suitable for base BUD8080.
- Verzinkter und pulverbeschichteter Stahlcarter. Erhaeltliche Farben Dark-Starwhite. Kombinierbar mit Staender BUD8080.
- Carter acier galvanisé et vernis. Couleurs disponibles Dark-Starwhite. Combinable avec pied BUD8080.
- Carter de acero galvanizado y pintado. Colores disponibles Dark-Starwhite. Combinable con base BUD8080.
- Gegalvaniseerd en geepoxeerde metaalcarter. Beschikbare kleuren z ark-Starwhite. Combineerbaar met parasolvoet BUD8080.

		KG	€
BDC8080DS	890x890x140 mm	21 Kg	€ 370
BDC8080BS			

BUD8080

- Base a croce metallica opzionale per ombrellone a braccio da completare con 12 BC4040, non comprese. Compatibile con kit ruote B8080R.
- Optional cross metal base for cantilever parasols to be completed with 12 BC4040, not included. Compatible with wheel kit B8080R.
- Alternativer stahlplattenstaender fuer seitenarmschirme zum kombinieren mit 12 BC4040, nicht inbegriffen. Kompatibel mit Rollen B8080R.
- Pied en acier optionnelle pour parasols bras deporté à combiner avec 12 BC4040, non inclus. Compatible avec kit roulettes B8080R.
- Base de metal opcional para sombrillas brazo lateral para completar con 12 BC4040, no incluido. Compatible con juego de ruedas B8080R.
- Optionele metalen basis voor arm parasol uit te voeren met 12 BC4040, niet inbegrepen. Compatibel met wielkit B8080R

		KG	€
BDC8080DS	890x890x140 mm	21 Kg	€ 420
BDC8080BS			

B8080R

- Kit ruote alta resistenza girevoli e frenanti.
- High resistance rotating and braking wheels kit.
- Hochwiderstands-dreh- und bremsrad set.
- Kit roues rotatives et freinage haute résistance.
- Kit ruedas giratorias y frenos de alta resistenci.
- Kit met hoge weerstand draaiende en remwielen.



B8080R	€
B8080R	€ 150

BALLAST



KG

€

BC4040	400x400 mm	14 Kg	€ 13
BC5050	500x500 mm	20 Kg	€ 16

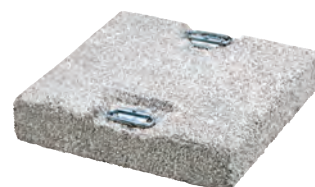

KG

€

BC5151	500x500 mm	60 kg	€ 95
---------------	------------	-------	------



KG

€

BC5151G	500x500 mm	60 kg	€ 95
----------------	------------	-------	------



H

KG

€

BV5050G	500x500 mm	270 mm	80 kg	€ 142
----------------	------------	--------	-------	-------



H

KG

€

BV5050B	500x500 mm	270 mm	80 kg	€ 152
----------------	------------	--------	-------	-------

BC4040 - BC5050

- Piastra in cemento e graniglia. Spessore 4 cm.
- Cement grit slab. Thickness 4 cm.
- Kiesbetonplatte. Dicke 4 cm.
- Dalles ciment et grès. Epaisseur 4 cm.
- Planchas de hormigón y de grava. De espesor 4 cm.
- Gewassen grindtegel. Gewicht 20 kg. Dikte 4 cm.

BC5151

- Piastra in cemento e graniglia bianca con maniglie. Spessore 11cm. Per ombrelloni a braccio.
- White cement grit slab with handles. Thickness 11cm. For cantilever parasols.
- Weisse Kiesbetonplatte mit Handgriffen. Dicke 11cm. Fuer Pendelschirme.
- Dalles ciment et grès avec poignées blanc. Epaisseur 11cm. Pour parasols avec bras deporté.
- Placas blancas de hormigón y arena con asas. De espesor 11 cm. Para parasoles con voladizo.
- Wit gewassen grindtegel met handgrepen. Dikte 11 cm. Geschikt voor vrijhangende parasols.

BC5151G

- Piastra in cemento grigio con maniglie. Spessore 11cm. Per ombrelloni a braccio.
- Concrete grey cement slab with handles. Thickness 11cm. For cantilever parasols.
- Graue Betonplatte mit Handgriffen. Dicke 11cm. Fuer Pendelschirme.
- Dalles ciment couleur gris avec poignées. Epaisseur 11cm. Pour parasols avec bras deporté.
- Base de cemento gris con asas. De espesor 11 cm. Para parasoles con voladizo.
- Betontegel grijs met handgrepen. Dikte 11 cm. Geschikt voor vrijhangende parasols.

BV5050G

- Piastra in cemento grigio con maniglie. Spessore 11cm. Per ombrelloni a braccio.
- Concrete grey cement slab with handles. Thickness 11cm. For cantilever parasols.
- Graue Betonplatte mit Handgriffen. Dicke 11cm. Fuer Pendelschirme.
- Dalles ciment couleur gris avec poignées. Epaisseur 11cm. Pour parasols avec bras deporté.
- Base de cemento gris con asas. De espesor 11 cm. Para parasoles con voladizo.
- Betontegel grijs met handgrepen. Dikte 11 cm. Geschikt voor vrijhangende parasols.

BV5050B

- Vaso in cemento bianco con maniglie. Spessore 11cm. Per ombrelloni a braccio.
- Concrete white cement pot with handles. Thickness 11cm. For cantilever parasols.
- Weisser Betontopf mit Handgriffen. Dicke 11cm. Fuer Pendelschirme.
- Vase ciment couleur blanc avec poignées. Epaisseur 11cm. Pour parasols avec bras deporté.
- Maceta de cerámica con asas de hormigón. De espesor 11 cm. Para parasoles con voladizo.
- Plantenschaal beton met handgrepen. Dikte 11 cm. Geschikt voor vrijhangende parasols.

GROUND FIXING

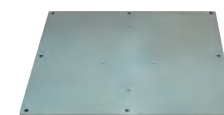

KG

€

CP3030ZS	300x300 mm	7 Kg	€ 140
-----------------	------------	------	-------



KG

€

CP6565ZS	650x650 mm	30 kg	€ 360
-----------------	------------	-------	-------

CP6565ZS

- Contropiastra acciaio zincato per fissaggio a terra. 65x65 cm.
- Metal plate for concrete ground fixation. 65x65 cm.
- Verzinkte Stahlplatte fuer Bodenbefestigung. 65x65 cm.
- Contreplaque acier galvanise pour ancrage au sol. 65x65 cm.
- Placa acero galvanizado fijación a tierra. 65x65 cm.
- Metaal zinkplaat voor grondbevestiging. 65x65 cm.

BTBS

- Supporto da interrare. acciaio zincato.
- In ground anchor. zined steel.
- Bodenanker. verzinktes stahl.
- Base pour ancrage au sol. acier galvanisé.
- Base para fijación a tierra. acero galvanizado.
- Grondanker. gegalvaniseerd staal.



KG

€

BTBS	300x300 mm	10 kg	€ 190
-------------	------------	-------	-------

BTAZS

- Nuovo supporto da interrare. acciaio zincato.
- New in ground anchor. zined steel.
- Neu Bodenanker. Verzinktes Stahl.
- Nouveau base pour ancrage au sol. acier galvanisé.
- Base para fijación a tierra. acero galvanizado.
- Grondanker. gegalvaniseerd staal.



H

KG

€

BTAZS	Ø 160 mm	350 mm	5 kg	€ 98
--------------	----------	--------	------	------

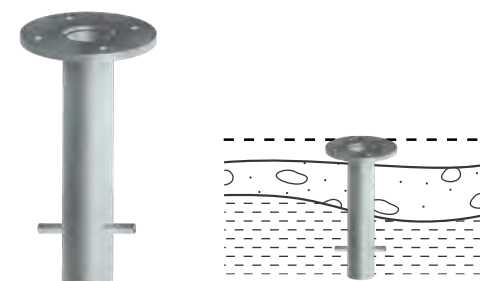
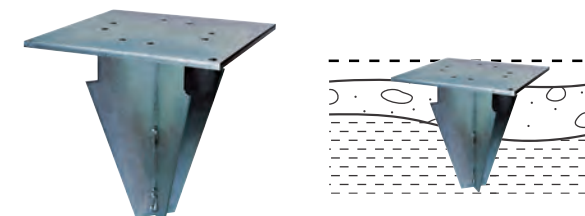



La base e l'eventuale zavorra sono fondamentali per garantire stabilità e sicurezza. Selezionare l'opzione adeguata al momento dell'ordine. In caso di fissaggio a terra si esclude il rischio di ribaltamento dell'ombrellone, ma non il cedimento strutturale di alcuni componenti se sottoposti a condizioni atmosferiche incompatibili con l'uso dei ns prodotti. Queste tabelle sono indicative e prevedono che il pavimento o il terreno di appoggio sia perfettamente piano e regolare. Gli ombrelloni e i rispettivi componenti delle basi devono essere assemblati correttamente rispettando le istruzioni di montaggio. La stabilità degli ombrelloni può variare nel caso di condizioni atmosferiche particolari. L'utilizzatore finale è responsabile del corretto uso dell'ombrellone. Nessuna rivalsa può essere fatta sul produttore.

EN

The base and any ballast are essential to ensure stability and safety. Please select the appropriate option when ordering. In case of ground fixation, the risk of overturning of the parasol is excluded, but not the structural failure of some components, if subjected to atmospheric conditions that are incompatible with the use of our products. This schedule considers statics calculation and foresees that the floor where the parasol has to be positioned is perfectly flat and regular. The parasols and components have to be assembled correctly and respecting the assembly instruction. The schedule has to be considered indicative because many variables that depend from the area of employ and position of the parasols are not foreseeable. No rights can be derived from this. The use of a parasol is always on your own responsibility.



Der Staender und eventueller Ballast sind grundlegend um Stabilitaet und Sicherheit zu gewaehrleisten. Bitte waehlen Sie bei der Bestellung die entsprechende Option aus.

Bei Bodenbefestigung ist das Risiko des Umkippens des Schirms ausgeschlossen, nicht jedoch das strENTurelle Versagen einiger Bestandteile, wenn sie atmosphaerischen Bedingungen ausgesetzt werden, die mit der Verwendung unserer ProdENte nicht vereinbar sind. Diese Aufstellung beinhaltet statistische Kalkulationen und sieht vor, dass der Schirm auf einem ebenen und regelmaessigen Boden positioniert wird. Der Schirm und die Bestandteile des Staenders muessen gemaess Anbauanleitungen montiert werden. Die Stabilitaet der Schirme kann auf Grund besonderer klimatischen Konditionen aendern. Der Endbenutzer ist fuer die ordnungsgemaesse Verwendung des Schirmes verantwortlich.

FR

La base et les eventuels poids sont essentiels pour assurer la stabilité et la sécurité. Svpl. sélectionnez l'option appropriée lors de la commande. En cas de fixation au sol, le risque de renversement du parasol est exclu, mais pas la défaillance structurelle de certains composants s'ils sont soumis à des conditions atmosphériques incompatibles avec l'utilisation de nos produits. Ces tableaux sont à titre indicatif et ils prévoient que la surface sur laquelle est implanté le parasol soit parfaitement plane et lisse. Les parasols et les éléments respectifs des bases doivent être assemblés en respectant scrupuleusement les instructions de montage. La stabilité des parasols peut varier dans le cas de conditions atmosphériques particulières et dépend du lieu et de l'utilisation propre à chaque utilisateur (le parasol doit être fermé en cas de vent fort et/ou de mauvaises conditions météorologiques).

ES

La base y posible balasto son fundamentales para garantizar la estabilidad y la seguridad. Seleccione la opción adecuada al realizar el pedido. En caso de fijación al suelo, se excluye el riesgo de vuelco del parasol, pero no el fallo estructural de algunos componentes si se someten a condiciones atmosféricas incompatibles con el uso de nuestros productos. Estos cuadros son indicativos y requieren que el suelo o el apoyo de tierra sea perfectamente plano y liso. El parasol y los respectivos componentes de la base deben ser montados correctamente respetando las instrucciones. La estabilidad de los parasoles puede variar según las condiciones atmosféricas.

NL

Basis en eventuele ballast zijn essentieel om stabiliteit en veiligheid te garanderen. Selecteer alstublieft de juiste optie bij het bestellen. In het geval van bevestiging aan de grond is het risico dat de parasol omvalt uitgesloten, maar niet het structurele falen van sommige onderdelen als ze worden blootgesteld aan atmosferische omstandigheden die onverenigbaar zijn met het gebruik van onze producten. Dit schema houdt rekening met statische berekeningen en gaat ervan uit dat de vloer waarop de parasol moet worden geplaatst perfect vlak en regelmatig is. De parasols en onderdelen moeten correct en volgens de montagehandleiding worden gemonteerd. Het schema moet als indicatief worden beschouwd omdat veel variabelen die afhangen van het werkgebied en de positie van de parasols niet te voorzien zijn.

STABILITY

1

- Peso minimo richiesto
- Minimum required weight
- Erforderliches Mindestgewicht
- Poids minimum requis
- Peso mínimo requerido
- Minimaal vereist gewicht

2

- Stabilità intermedia
- Intermediate stability
- Mittlere Stabilität
- Stabilité intermédiaire
- Estabilidad intermedia
- Gemiddelde stabiliteit

3

- Peso consigliato in condizioni normali
- Recommended weight under normal conditions
- Empfohlenes Gewicht unter normalen Bedingungen
- Poids recommandé dans des conditions normales
- Peso recomendado en condiciones normales
- Aanbevolen gewicht onder normale omstandigheden

4

- Massima stabilità con base
- Maximum stability with base
- Maximale Stabilität mit Staender
- Stabilité maximale avec socle
- Máxima estabilidad con base
- Maximale stabiliteit met voet

5

- Massima stabilità con fissaggio a terra
- Maximum stability with ground fixation
- Maximale Stabilität bei Bodenbefestigung
- Stabilité maximale avec fixation au sol
- Máxima estabilidad con fijación al suelo
- Maximale stabiliteit door bodembevestiging



- In caso di base con ruote, prestare particolare attenzione in caso di vento. Prima di spostare l'ombrellone è necessario chiuderlo.
- In case of base with wheels, be especially careful in windy conditions. Close the parasol before moving it.
- Bei Staender mit Raeder und Wind besonders vorsichtig sein. Der Schirm kann geschlossen bewegt werden.
- Dans le cas d'une base à roues, faites particulièrement attention par temps venteux. Avant de déplacer le parasol, il est nécessaire de le fermer.
- En el caso de una base con ruedas, tenga especial cuidado en condiciones de viento. Antes de mover la sombrilla es necesario cerrarlo.
- Wees vooral voorzichtig met statieven met wielen en wind. De parasol kan in gesloten toestand worden verplaatst.

		BASES						GROUND FIXING			
		BC35MA4	BC55MA4	BC80MA4	BC5151GRA4	BF6565D BF6565W	BF6666D BF6666W	BUD8080 +N°12 BC4040	BQ8080 +N°8 BC4040	BTC +BTT	CP3030ZS +BTT
PALLADIO	Ø 2,5	1	3	4		3	4	/	/	5	5
LIDO		1	3	4		3	4	/	/	5	5
PALLADIO	Ø 3,0	/	3	4		3	4	/	/	5	5
NAPOLI RIMINI		/	2	3		2	3	/	4	5	5
PALLADIO	Ø 3,5	/	2	3		2	3	/	4	5	5
PALLADIO	Ø 4,0	/	1	2	/	1	2	4	3	5	5
PALLADIO TEL.	Ø 5,0	/	/	1	/	/	1	3	2	5	5
VELA LIDO		1	3	4		3	4	/	/	5	5
PALLADIO	2,0 x 2,0	1	3	4		3	4	/	/	5	5
VELA		/	2	3		2	3	5	4	5	5
PALLADIO	3,0 x 3,0	/	2	3		2	3	5	4	5	5
NAPOLI RIMINI		/	2	3		2	3	5	4	5	5
PALLADIO		/	1	2	/	1	2	4	3	5	5
LEONARDO	3,5 x 3,5	/	1	2	/	1	2	4	3	5	5
PALLADIO		/	/	1	/	/	1	4	3	5	5
LEONARDO PALLADIO TEL.	4,0 x 4,0	/	/	1	/	/	1	4	3	5	5
NAPOLI		/	3	4		3	4	/	/	5	5
PALLADIO	2,0 x 3,0	/	3	4		3	4	/	/	5	5
NAPOLI RIMINI		/	1	2	/	1	2	4	3	5	5
PALLADIO	3,0 x 4,0	/	1	2	/	1	2	4	3	5	5
LEONARDO PALLADIO TEL.		/	1	2	/	1	2	4	3	5	5

	B1						PL1			PL1	BUD8080				GROUND FIXING			
	B1DS/B1BS	n°2 BC5151 n°6 BC5050	n°4 BC5151 n°12 BC5050	n°2 BV5050	BCCS/BCWS	PL1DS/ PL1BS	n°4 BC5151 n°12 BC5050	n°4 BV5050		BDCS/BDWS	BUD8080	+n°12 BC4040	B8080R	BUD8080DS BUD8080BS	CP3030ZS	CP6565ZS	BTBS	BTAZS
SIDE POST	Ø 3,5	◆	1	3	2	◆	4	5		◆	3	/			5	5	/	5
	Ø 4,0	◆	1	3	2	◆	4	5		◆	3	/			5	5	/	5
	3,0 x 3,0	◆	1	3	2	◆	4	5		◆	3	/			5	5	/	5
	3,5 x 3,5	◆	1	3	2	+12 BC5050	◆	4	5	+12 BC5050	◆	3	/	+12 BC4040	5	5	/	5
	4,0 x 4,0	◆	1	/	/	◆	2	3		◆	/	/			5	5	/	5
	2,0 x 3,0 3,0 x 2,0	◆	/	3	2	◆	4	5		◆	3	/			5	5	/	5
	3,0 x 4,0	◆	1	3	2	◆	4	5		◆	3	/			5	5	/	5
GALILEO	3,0 x 3,0	◆	1	3	2	◆	4	5		◆	3		🚫		5	5	/	5
	3,5 x 3,5	◆	/	2	1	+12 BC5050	◆	3	4	+12 BC5050	◆	2	🚫	+12 BC4040	5	5	/	5
	4,0 x 4,0	◆	/	/	/	◆	2	3		◆	/	/		5	5	/	5	
	3,0 x 4,0	◆	/	2	1	◆	3	4		◆	2		🚫		5	5	/	5
CAPRI	4,0 x 4,0	◆	/	/	/	◆	4	5		◆	3		🚫		/	5	5	/
	5,0 x 5,0	◆	/	/	/	◆	2	4		◆	/	/			/	5	5	/
	6,0 x 6,0	◆	/	/	/	+12 BC5050	◆	1	3	+12 BC5050	◆	/	/	+12 BC4040	/	5	5	/
	3,0 x 4,0	◆	/	/	/	◆	4	5		◆	3		🚫		/	5	5	/
	4,0 x 5,0	◆	/	/	/	◆	2	4		◆	/	/			/	5	5	/
	5,0 x 6,0	◆	/	/	/	◆	1	3		◆	/	/			/	5	5	/
DOUBLE	3,0 x 6,0	◆	/	/	/	+12 BC5050	◆	2	4	+12 BC5050	◆	/	/		/	5	5	/
	3,5 x 7,0	◆	/	/	/	◆	1	3		◆	/	/			/	5	5	/
POKER	6,0 x 6,0	◆	/	/	/	+12 BC5050	◆	2	3	+12 BC5050	◆	/	/	+12 BC4040	/	5	5	/
	7,0 x 7,0	◆	/	/	/	◆	2	3		◆	/	/			/	5	5	/

FABRIC COLLECTION

LEGENDA DEL TESSUTO

A1S	T6N
Acilico Dralon 350gr trattato, impermeabilizzato Teflon. Antimuffa. Colore Ecrù. Con volant.	Acilico Dralon 350gr trattato, impermeabilizzato Teflon. Antimuffa. Colore Grigio Taupe. Senza volant.
A1N	T7N
Acilico Dralon 350gr trattato, impermeabilizzato Teflon. Antimuffa. Colore Ecrù. Senza volant.	Acilico Dralon 350gr trattato, impermeabilizzato Teflon. Antimuffa. Colore Bianco. Senza volant.
T2S	T8N
Acilico Dralon 350gr trattato, impermeabilizzato Teflon. Antimuffa. Colore Terracotta. Con volant.	Acilico Dralon 350gr trattato, impermeabilizzato Teflon. Antimuffa. Colore Grigio Perla. Senza volant.
T2N	T9N
Acilico Dralon 350gr trattato, impermeabilizzato Teflon. Antimuffa. Colore Terracotta. Senza volant.	Acilico Dralon 350gr trattato, impermeabilizzato Teflon. Antimuffa. Colore Grigio Antracite. Senza volant.
T3S	S1N
Acilico Dralon 350gr trattato, impermeabilizzato Teflon. Antimuffa. Colore Bordeaux. Con volant.	Acilico Dralon 350gr trattato, impermeabilizzato Teflon. Antimuffa. Colore Nero. Senza volant.
T3N	
Acilico Dralon 350gr trattato, impermeabilizzato Teflon. Antimuffa. Colore Bordeaux. Senza volant.	

FABRIC LEGEND

A1S	T6N
Acryl Dralon 350gr waterproof treated Teflon. Anti mould. Colour Ecrù. With valance	Acryl Dralon 350gr waterproof treated Teflon. Anti mould. Colour Grey Taupe. Without valance
A1N	T7N
Acryl Dralon 350gr waterproof treated Teflon. Anti mould. Colour Ecrù. Without valance	Acryl Dralon 350gr waterproof treated Teflon. Anti mould. Colour White. Without valance
T2S	T8N
Acryl Dralon 350gr waterproof treated Teflon. Anti mould. Colour Terracotta. With valance	Acryl Dralon 350gr waterproof treated Teflon. Anti mould. Colour Silver Grey. Without valance
T2N	T9N
Acryl Dralon 350gr waterproof treated Teflon. Anti mould. Colour Terracotta. Without valance	Acryl Dralon 350gr waterproof treated Teflon. Anti mould. Colour Anthracit Grey. Without valance
T3S	S1N
Acryl Dralon 350gr waterproof treated Teflon. Anti mould. Colour Bordeaux. With valance	Acryl Dralon 350gr waterproof treated Teflon. Anti mould. Colour Black. Without valance
T3N	
Acryl Dralon 350gr waterproof treated Teflon. Anti mould. Colour Bordeaux. Without valance	

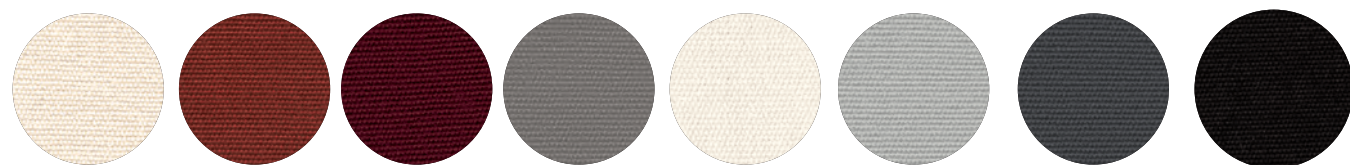

350 GR/M²
ACRYLIC

A1 ECRU NATURAL COL. NATUR	T2 TERRACOTTA ZIEGELROT TERRACOTTA	T3 BORDEAUX	T6 GRIGIO TAUPE GREY TAUPE GRAU TAUPE GRIS TAUPE GRIJS TAUPE	T7 BIANCO WHITE BLANC WEISS	T8 GRIGIO PERLA SILVER GREY SILBERGRAU	T9 GRIGIO ANTRACITE ANTHRACIT GREY ANTHRAZITGRAU	S1 NERO /BLACK SCHWARZ NOIRE NEGRO ZWART
--	--	-----------------------	---	--	--	---	--

I dati forniti, pur essendo frutto di misurazioni scientifiche condotte in laboratori certificati, sono da ritenersi indicativi.
The above mentioned data are indicative, although provided by scientific measurements performed in certified laboratories.



PROFESSIONAL LED LIGHTS

KIT LED OMB. BRACCIO / LED LIGHTS CANTILEVER

	DESCRIPTION	€
KIT LED 50 W - C 3000 K	Luce bianca - collegamento elettrico White light - for electric power connection Weißes Licht - Strombedienung Lumière blanc - connexion électrique Luz blanca - conexión eléctrica	€ 590
KIT LED 50 W - B 3000 K	Luce bianca - kit batteria White light - with battery Weißes Licht - Batteriebedienung Lumière blanc - avec la batterie Luz blanca - kit de batería	€ 740

DISPONIBILE PER: / AVAILABLE FOR:

Galileo / Leonardo Braccio / Pompei Braccio / Palladio Braccio / Napoli Braccio / Rimini Braccio / Torino Braccio /
Alu Poker - Double / Wood Poker - Double / Capri 3x4 - 4x4

KIT LED CAPRI / LED LIGHTS CAPRI

	DESCRIPTION	€
KIT LED 120 W - C 3000 K	Luce bianca - collegamento elettrico White light - for electric power connection Weißes Licht - Strombedienung Lumière blanc - connexion électrique Luz blanca - conexión eléctrica	€ 960
KIT LED 120 W - B 3000 K	Luce bianca - kit batteria White light - with battery Weißes Licht - Batteriebedienung Lumière blanc - avec la batterie Luz blanca - kit de batería	€ 1.090

DISPONIBILE PER: / AVAILABLE FOR:

Mod. Capri: 4x5 / 5x5 / 5x6 / 6x6

NOVITÀ:

- Remote control - Luce dimmerabile
- Attacco con clip calamitata

NEW:

- Remote control - Dimmable light
- Simplify fixing system with magnet

USO E MANUTENZIONE

INDICAZIONI

- Prima dell'uso, conservare e leggere attentamente i manuali e le istruzioni di montaggio che si trovano all'interno della confezione.
- La base deve essere zavorrata. Un peso insufficiente compromette seriamente la stabilità dell'ombrellone.
- Rimuovere sempre la manovella quando non in uso e tenerla fuori dalla portata dei bambini.
- Per evitare danni o lesioni personali, l'ombrellone deve essere chiuso e in alcune condizioni atmosferiche avverse potrebbe essere necessario rimuovere il prodotto e stoccarlo in luogo protetto. Ricorda sempre che l'ombrellone non è una costruzione fissa. La ditta Scolaro non può essere ritenuta responsabile per danni alla merce fornita, o lesioni derivanti da un uso improprio e dal mancato rispetto delle istruzioni e delle linee guida fornite.

IMPIEGO DEL PRODOTTO

Prima di iniziare ad aprire l'ombrellone, assicurarsi che il tessuto non sia rimasto impigliato nelle stecche interne. Per aprire o chiudere l'ombrellone ruotare la maniglia (dove presente) nel senso indicato dalle frecce e dalla scritta "Apri" o "Chiudi". Un funzionamento errato potrebbe strappare la corda o danneggiare il meccanismo. Non forzare mai le corde o maniglie. Se si bloccano, controlla perché è successo ed elimina la possibile causa. Parti in legno: applicare un impregnante per legno a base di cera almeno una volta all'anno prima della stagione invernale. Chiudere l'ombrellone quando le condizioni meteorologicxhe non sono adatte, ad es. forte vento o pioggia battente. Gli ombrelloni Scolaro possono essere abbinati a basi speciali sviluppate per il fissaggio a terra. Qualora si decida di posizionare un ombrellone Scolaro utilizzando solo zavorra, ne viene certificata l'idoneità all'utilizzo in condizioni di vento moderato. Nella tabella specifica sono indicate le zavorre minime. Il Cliente è l'unico responsabile dell'installazione e della gestione dell'ombrellone.

ACCIAIO INOSSIDABILE

Attenzione:

1. NON UTILIZZARE I SEGUENTI PRODOTTI su parti in acciaio inossidabile: Candeggina a base di cloro o detersivi contenenti candeggina (possono corrodere l'acciaio inossidabile). Acido cloridrico o prodotti contenenti cloruri (possono corrodere l'acciaio inossidabile).
2. Il sale, il calcare o gli acidi (bevande e alimenti) possono scolorire le parti in acciaio inossidabile se non pulite tempestivamente.
3. I prodotti o le parti in acciaio inossidabile utilizzati in prossimità del mare o per la decorazione interna delle piscine richiedono una pulizia più frequente per rimuovere i cloriti depositati e per prevenire la corrosione e il deterioramento chimico delle superfici esterne.
4. Macchie o ruggine rilevate sulle superfici in acciaio inossidabile devono essere pulite tempestivamente.
5. Le macchie non rimosse per lunghi periodi possono diventare permanenti.
6. La ruggine può causare reazioni chimiche o corrodere l'acciaio inossidabile.

Per rimuovere macchie o ruggine:

- Applicare un detersivo o lucidante specifico non abrasivo per acciaio inox.
- Sciacquare accuratamente con acqua pulita.
- Infine asciugare bene per evitare che si formino striature, sfregamento nel senso delle fibre.

METALLI VERNICIATI: FERRO E ALLUMINIO

Per una lunga durata dell'ombrellone si consiglia di riporlo in ambienti asciutti, durante il periodo invernale e quando non utilizzato. Si consiglia inoltre di controllare una volta a stagione, soprattutto dopo un lungo periodo di inattività, il corretto funzionamento di tutti i componenti. La nostra garanzia non copre alcun tipo di graffio o abrasione alla finitura causata dal contatto con altri arredi o dalla conseguente corrosione. L'impiego in ambienti marini può portare all'accumulo di sali e cloruri sulla verniciatura a polvere. La mancata esecuzione di una regolare pulizia con acqua dolce può causare la formazione di bolle, ossidazioni, scolorimento e invalidare la garanzia. Per la pulizia delle superfici in metallo verniciato utilizzare acqua fredda e detersivi liquidi non abrasivi o aggressivi. Applicare con un panno morbido. Nel caso di superfici molto sporche e/o invecchiate, dopo la pulizia, si consiglia di trattarle con paraffina liquida. In caso di macchie causate da depositi di calcare su vernici di struttura grossolana (es. ferro antico e marrone d'india) pulirle con uno straccio e una soluzione di aceto di vino bianco diluito in acqua fredda.

LEGNO: IROKO

Legno tradizionale impiegato per l'arredo esterno e l'industria nautica. L'Iroko è un legno duro ad alto contenuto di olio, adatto per uso esterno. Estremamente duraturo. È praticamente inalterabile alla ripetuta esposizione agli agenti atmosferici. Anche se trattato, la superficie assume una patina grigio argento che è la naturale protezione dall'interno del legno, considerato parte essenziale del fascino dell'Iroko. La naturale tendenza del legno ad ingrigire o perdere la brillantezza della vernice può essere prevenuta nelle prime fasi di vita del prodotto. L'ombrellone può essere ripristinato mediante un nuovo trattamento con adeguato prodotti facilmente reperibili nei negozi specializzati. È necessario applicare una soluzione di acqua e olio incolore, a superfici esposte con un panno. L'olio deve essere molto diluito. Le macchie superficiali possono essere rimosse intervenendo per tempo, prima che il legno possa assorbirle completamente. Carteggiare delicatamente la superficie in questione e poi lucidare con un panno ruvido.

TESSUTI SINTETICI: ACRILICO E POLIESTERE

Il tessuto è impermeabile e trattato antimuffa per respingere l'acqua, le macchie e garantire la traspirazione. Si prega di seguire le nostre istruzioni di manutenzione per garantire la lunga durata del tessuto:

- Rimuovere spesso depositi di polvere, macchie e qualsiasi tipo di sporco per evitare tracce dopo la pulizia.
- È molto importante chiudere l'ombrellone solo quando è perfettamente asciutto. Durante l'inverno e quando l'ombrellone non viene utilizzato, deve essere conservato in un ambiente asciutto. Evitare il contatto prolungato con sostanze oleose e/o coloranti che potrebbero essere assorbite dal materiale di rivestimento in PVC e causare macchie permanenti, oltre a danneggiare la struttura del filo. Non utilizzare solventi o detersivi a base di solventi (evitare l'acetone). Usare acqua e detersivi liquidi non abrasivi, incolori, a PH neutro. Lasciare agire il detersivo per qualche minuto. Risciacquare bene con acqua non più calda di 30°C.

COMPONENTI

I componenti in acciaio, la viteria e gli accessori sono trattati antiruggine. Comunque per una lunga durata dell'ombrellone, durante l'inverno e quando non viene utilizzato, l'ombrellone deve essere conservato in ambiente asciutto. Durante ogni stagione è necessario verificare la funzionalità di tutti i componenti, soprattutto dopo un lungo periodo di inattività. La ditta Scolaro è a vostra disposizione per assistenza tecnica.

GARANZIA

Gli ombrelloni Scolaro sono progettati per durare molti anni esposti all'uso esterno.

Come per molti articoli, l'attenzione nell'uso e nella manutenzione e il rispetto delle istruzioni contenute in queste pagine, permette una vita media ancora più lunga del prodotto e la possibilità di godere di un prodotto ancora più efficiente ed esteticamente gradevole.

I prodotti Scolaro sono garantiti 2 anni.

Se si rispettano le indicazioni e i consigli, la garanzia può essere estesa come segue:

LA GARANZIA COPRE SOLO I DIFETTI DI FABBRICAZIONE DI INTEGRITÀ STRUTTURALE. LA GARANZIA NON COPRE DANNI CAUSATI DA AZIONI MECCANICHE, FORZA NATURALE E ATTI DOLOSI.

5 anni di garanzia sui componenti in alluminio e acciaio inox. Inclusa verniciatura e viti.

- Difetti strutturali non derivanti da uso improprio o mancata manutenzione.
- Corrosione invasiva non prodotta da graffi o abrasioni da utilizzo non asportabile mediante normale pulizia e manutenzione.

5 anni di garanzia sui colori e sul trattamento dei tessuti (resistenza).

- La sostituzione della coperta durante il periodo di garanzia è prevista solo in caso di scolorimento prima della fine del periodo di garanzia. Gli utenti devono conservare correttamente i tessuti, affinché la garanzia sia effettiva. Una corretta manutenzione implica una pulizia regolare.
- La garanzia non copre i danni da contatto con oggetti estranei, abrasioni causate dal vento, uso improprio o abuso (strappi, bruciature e fori). L'uso intensivo in ambiente aggressivo (mare e piscina), richiede un regolare risciacquo del tessuto con acqua dolce per prevenire ed evitare l'accumulo di residui salini e clorurati.

2 anni di garanzia su tutti gli elementi metallici e in acciaio in genere

1 anno di garanzia sui meccanismi di apertura con manovella, previo uso corretto e rispettoso delle istruzioni fornite.

2 anni di garanzia in genere per le finiture e altri materiali non specificatamente menzionati e scritti sopra, comprese le basi in cemento e le zavorre

1 anno di garanzia sui kit luci LED e sui componenti elettrici in general.

LA GARANZIA NON SI APPLICA:

- Se il prodotto non è stato assemblato secondo le istruzioni fornite;
- in caso di uso improprio del prodotto o non conforme alla normale destinazione d'uso del bene;
- in caso di mancato rispetto delle istruzioni per l'uso e la manutenzione indicate nel materiale informativo fornito con il prodotto;
- in caso di stoccaggio in condizioni ambientali non idonee al prodotto;
- in caso di modifica o manomissione del prodotto;
- se il prodotto è stato assemblato o combinato con componenti e prodotti non forniti da Scolaro.

Per usufruire della garanzia è necessario esibire l'articolo difettoso o inviare le foto, unitamente alla fattura o scontrino fiscale.

La garanzia comprende la fornitura di parti di ricambio o la sostituzione del prodotto se necessario. La garanzia non comprende la riparazione in loco o il rimborso delle spese sostenute per il mancato utilizzo del prodotto.

In caso di vizio accertato da Scolaro, si riserva il diritto - a propria discrezione - di sostituire il prodotto con uno uguale o equivalente per caratteristiche essenziali o di rimborsare al cliente solo l'importo pagato per il prodotto. Nessuna ulteriore spesa o danno potranno essere richiesti a Scolaro.

Scolaro non sarà responsabile per eventuali danni a cose o persone derivanti da un uso improprio del prodotto.

Politica di servizio e riparazioni

Anche in caso di danneggiamenti e rotture, Scolaro ha sempre adottato un'attenta e puntuale politica di assistenza post vendita.

In qualunque caso di danneggiamento o necessità, consigliamo di contattare la nostra azienda per valutare la possibilità di riparare e recuperare il prodotto, nonché per ottenere assistenza per eseguire l'intervento.

La corrispondenza ad alti standard qualitativi e funzionali dei materiali impiegati costituisce la garanzia principale della robustezza e resistenza nel tempo dei prodotti Scolaro. Un comportamento rispettoso di norme di manutenzione ed uso, come specificato di seguito, assicura una durata ancora maggiore.

Le informazioni contenute in questo catalogo o in altri stampati pubblicitari della ditta Scolaro, quali caratteristiche tecniche dei prodotti o dei componenti, dimensioni, schemi di montaggio, colori, ecc., hanno valore meramente indicativo, in ragione delle specifiche tecniche e della evoluzione tecnologica dei prodotti aziendali. Al fine di migliorare la qualità del prodotto, la ditta si riserva il diritto di modificare lo stesso senza alcun preavviso e anche dopo l'accettazione dell'ordine. L'azienda si riserva di apportare modifiche parziali o totali ai prodotti senza preavviso declinando ogni responsabilità su eventuali dati inesatti. Eventuali lievi variazioni di tonalità dei colori e delle finiture rientrano nelle normali caratteristiche dei materiali impiegati. Tutte le differenze sopraindicate non sono tali da modificare significativamente i prodotti stessi e non costituiscono motivo di reso o sostituzione della merce o di contestazione.

USE AND MAINTENANCE

DIRECTIONS

- Before use, directions and assembling instructions, which are inside the package, have to be kept and read carefully.
- The base has to be ballasted. An insufficient weight will seriously compromise the stability of the parasol.
- Always remove crank when not in use and keep out of reach of children.
- To avoid damage or personal injury, parasol must be closed and in some extreme weather conditions it may be necessary to remove the product and store it in a protected place. Remember always that the parasol is not a fixed construction. The company Scolaro cannot be held responsible for damages to goods supplied, or injury resulting from improper use and failure to follow instruction and guidelines given on.

PRODUCT EMPLOY

Before starting to open the parasol, make sure that the fabric has not got caught in the internal ribs. To open or close the parasol, turn the handle (where available) in the direction indicated by the arrows and the words "Open" or "Close". Incorrect operation could tear the string or damage the mechanism. Never force the ropes or handles. If they get stuck, check why this has happened and eliminate the possible cause. Wooden parts: apply a wax-based wood-stainer at least once a year before the winter season. Close the parasol when the weather conditions are unsuitable, strong wind or heavy rain.

Scolaro parasols can be combined with special bases developed for the ground fixing. If it is decided to position a Scolaro parasol using ballast only, their suitability for use in conditions of moderate wind is certified. In the specific table the minimum ballast weights are indicated. The Customer is the sole party responsible for installing and managing the parasol.

STAINLESS STEEL

Attention:

1. DO NOT USE THE FOLLOWING PRODUCTS on any parts made of stainless steel: Chlorine bleach or detergents containing bleach (they can corrode stainless steel). Hydrochloric acid or products containing chlorides (they can corrode stainless steel).
2. Salt, limestone or acids (drinks and food) may discolour parts made of stainless steel if not cleaned promptly.
3. Products or parts made of stainless steel used near the seaside or for the interior decoration of swimming pools require more frequent cleaning in order to remove chlorites deposited on them and to prevent corrosion and chemical deterioration of the external surfaces.
4. Stains or rust noted on stainless steel surfaces must be cleaned promptly.
5. Stains left in place for long periods may become permanent.
6. Rust may cause chemical reactions or corrode stainless steel.

To remove stains or rust:

- Apply a specific non-abrasive detergent or polish for stainless steel.
- Rinse thoroughly with clean water.
- Lastly, dry thoroughly in order to prevent streaks from occurring, rubbing in the sense of the fibres.

VARNISHED METALS: IRON AND ALUMINIUM

For a long lasting of the parasol we recommend to store it in dry environments, during the winter and when not in use. It's also recommended to check once a season, especially after a long period of inactivity, the proper functioning of all components. Our warranty does not cover any type of scratches or abrasions to finish caused from the contact with other furniture or any resulting corrosion. The employ in marine environments can lead to the accumulation of salt and chlorides on the powder coating. Failure to perform regular cleaning with fresh water can cause blisters, oxidation, discoloration and invalidates the warranty. To clean surfaces in varnished metals, use cold water and non abrasive or aggressive liquid detergents. Apply with a soft cloth. In the case of very dirty and/or aged surfaces, after cleaning, it is advisable to treat them with liquid paraffin. In the event of stains caused by lime deposits on varnishes of coarse structure (eg. antique iron and indian brown) clean them with a cloth and a solution of white wine vinegar diluted in cold water.

WOOD: IROKO

Traditional wood employed for outdoor furniture and the marine industry. Iroko is a hardwood with a high oil content, suitable for external use. Extremely long-lasting. It is practically unalterable to repeated exposure to atmospheric factors. Even if treated, the surface takes a silver-grey coating which is the natural protection from inside the wood, considered an essential part of Iroko's charm. The natural tendency of wood to turn gray or lose the brightness of the paint can be prevented in the early stages of the product life. The parasol can be restored by a new treatment with proper products easy to find in specialized shops. It's necessary to apply a solution of water and colourless oil, to exposed surfaces with a cloth. The oil must be highly diluted. Superficial stains can be removed by intervening in time, before the wood can fully absorb them. Gently sand the surface in question and then polish with a rough cloth.

SYNTHETIC FABRICS: ACRYL AND POLYESTER

The fabric is waterproof and anti mould treated to reject water, spots and grant transpiration. Please follow our maintenance instruction to grant the long lasting of the fabric:

- Remove often dust deposits, spots and any type of dirt in order to avoid trails after cleaning.
- It's very important to close the parasol only when it is perfectly dry. During the winter and when the parasol is not employed, it has to be stored in dry environment. Avoid prolonged contact with oily substances and/or dyes that could be absorbed by the covering material in PVC and cause permanent stains, in addition to damaging the structure of the thread. Do not use solvents or solvent-based detergents (avoid acetone). Use water and non-abrasive, colourless liquid detergents with a neutral PH. Let the detergent act for a few minutes. Rinse well with water no warmer than 30°C.

COMPONENTS

The steel components, screws and accessories are anti rust treated. Anyway for a long lasting of the parasol, during the winter and when the it is not employed, the parasol has to be stored in dry environment. During every season it is necessary to check the functionality of all components, especially after a long period of non-employ. The company Scolaro is at your disposal for technical assistance.

WARRANTY

Scolaro parasols are designed to last for many years exposed to outdoor use.

As with many items, attention in use and maintenance and following the instructions contained in these pages, allows an even longer average life of the product and the possibility of enjoying an even more efficient and aesthetically pleasing product.

Scolaro's products are guaranteed for 2 years.

If you comply with the indications and advices, the warranty can be extended as follows:

THE WARRANTY COVERS ONLY MANUFACTURING DEFECTS OF STRUCTURAL INTEGRITY. THE WARRANTY DOES NOT COVER DAMAGES CAUSED BY MECHANICAL ACTIONS, FORCE OF NATURE AND MALICIOUS ACTS.

5 years warranty on aluminum and stainless steel components. Including painting and screws.

- Structural faults not resulting from improper use or lack maintenance.
- Invasive corrosion not produced by scratches or abrasions from use not removable through normal cleaning and maintenance.

5 year warranty on colors and treatment of fabrics (strength).

- The replacement of the canopy during the warranty period is foreseen only if it loses its color before the end of the warranty period. Users must properly maintain fabrics for the warranty to be effective. Proper maintenance implies regular cleaning.
- The warranty does not cover damage from contact with foreign objects, wind-driven abrasions, misuse or abuse (tears, burns and holes). The intensive employ in an aggressive environment (seaside and pool use), requires a regular rinse of the fabric with fresh water in order to prevent and avoid the build-up of salt and chloride residues.

2 years warranty on all metal and steel elements in general

1 year warranty on the opening mechanisms with crank subject to correct and respectful use according to the instruction given.

2 years warranty in general for finishes and other materials not specifically mentioned and written above, including concrete bases and ballasts.

1 year warranty on LED light kits and electrical components in general. THE WARRANTY DOES NOT APPLY:

- If the product has not been assembled according to the instructions provided;
- in the event of improper use of the product or use that does not conform to normal intended use of the property;
- in case of non-compliance with the instructions for use and maintenance indicated in the information material supplied with the product;
- in case of storage in environmental conditions that are not suitable for the product;
- in case of modification or tampering with the product;
- if the product has been assembled or combined with components and products not provided by Scolaro.

To take advantage of the warranty the faulty item must be shown or pictures must be forwarded, together with the invoice or receipt.

The warranty includes the supply of spare parts or the replacement of the product if necessary.

The warranty does not include the repair on-site or the refund of costs incurred for non-use of the product. In case of defect confirmed by Scolaro, it reserves the right - at its own discretion - to replace the product with an equal or equivalent one for essential characteristics or to refund only the amount paid for the product to the customer.

No further expenses or damages can be requested from Scolaro. Scolaro will not be liable for any damage to properties or individuals deriving from an improper use of the product.

Service and repairs policy

Even in the event of damage and breakage, Scolaro has always adopted a careful and punctual after-sales assistance policy.

In any case of damage or need, we recommend contacting our company to evaluate the possibility of repairing and recovering the product, as well as to get assistance in carrying out the intervention.

The connection between the high qualitative and functional standards of the materials used, constitutes the main guarantee of the sturdiness and the resistance of the company's products over time. Respecting the rules of maintenance and use, specified as follows, will ensure the success of these objects, which were devised with Scolaro quality, to last a long time.

The information contained in this brochures or other Scolaro's advertisements prints, such as product specifications or components, dimensions, assembling instruction, colours, etc., are purely indicative, because of the technical specifications and the technological evolution of the company's products. In order to improve the quality of the product, the company reserves the right to change the same without prior notice and even after acceptance of the order. The company reserves the right to make partial or complete changes to the products without prior notice and declines any responsibility for inaccurate data. Any colour differences and changes of finishing have to be considered normal characteristics of the materials used. These differences do not significantly change the products and aren't reason for return or replacement of the goods or dispute.



- Dimensione (metri)
- Dimensions (meters)
- Masse (Meter)
- Dimensions (mètres)
- Dimensiones (en metros)
- Afmeting in (meters)



- Stecche
- Ribs
- Streben
- Baleines
- Varillas
- Baleinen



- Blocco antivento
- Wind stop
- Windstop
- Block antivent
- Freno para el viento
- Windstop



- Sistema retrattile
- Retractable system
- Einziehbares System
- Système retractile
- Sistema retráctil
- Inklapbaar systeem



- Lunghezza
- Length
- Laenge
- Longueur
- Longitud



- Set canaline
- Raingutter set
- Regerinnen
- Set gouttières
- Canalizador Lluvias
- Set regengoten



- Con meccanismo manovella
- With winding mechanism
- Mit Kurbelmechanismus
- Avec mécanisme manivelle
- Con manivela
- Met opwindmechanisme



- Ombrellone girevole a 360°C
- 360-degree rotating umbrella
- 360° drehbarer Schirm
- Parasol rotatif à 360°
- Parasol giratorio de 360°
- 360° draaibare parasol



- Peso
- Weight
- Gewicht
- Poids
- Peso
- Gewicht

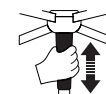

- Apertura semplificata a spinta
- Easy push opening system
- Vereinfachte push-up Oeffnung
- Ouverture par poussée simplifiée
- Apertura por empuje simplificada
- Eenvoudig push-up systeem voor openen en sluiten



- Piastre cemento
- Cement slabs
- Kiesbetonplatten
- Dalles ciment
- Planchas de cemento
- Betontegel



- Inclinazione fino a 20°
- Inclination up to 20°
- Neigung bis zu 20°
- Inclination jusqu'à 20°
- Inclinación hasta 20°



- Volume (m³)
- Volume (m³)
- Volumen (m³)
- Volume (m³)
- Volumen (m³)

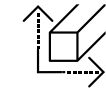

- Sezione stecche
- Rib section
- Strebenprofil
- Section baleines
- Sección varillas
- Profiel baleinen



- Fodero
- Cover bag
- Schutzhuelle
- Housse
- Forro
- Afdekhoes



- Inclinazione fino a 60°
- Inclination up to 60°
- Neigung bis zu 60°
- Inclination jusqu'à 60°
- Inclinación hasta 60°



- Ø Palo (mm)
- Ø Pole (mm)
- Ø Mast (mm)
- Ø Mat (mm)
- Diametro mm (asta)
- Ø Mast (mm)



- Camino antivento
- Wind cap
- Windfang
- Souffle
- Chimenea antiviento
- Windvang



- Doppia carrucola
- Double pulley
- Doppelter Seilzug
- Double poulie
- Doble polea
- Dubbele katrollen

INOX

- Viteria in inox
- Screws in Stainless steel
- Edelstahlschrauben
- Visserie inox
- Tornillos en acero inoxidable
- Schroeven van rvs



- Sezione sostegno (mm)
- Support section (mm)
- Mastprofil (mm)
- Section support (mm)
- Sección soporte (mm)
- Mast (mm)



- Stecca con sistema "easy change"
- Ribs with "easy change" system
- Streben mit "easy change" System
- Baleines avec "easy change" système
- Varillas con sistema de " cambio fácil"
- Baleinen met het "easy change" systeem



- Sistema telescopico
- Telescopic system
- Teleskopsystem
- Système telescopique
- Sistema telescópico
- Telescoop systeem



- Tipo finitura della struttura/sostegno/componenti
- Finishing for frame/structure/components
- Ausfuehrung des Gestells/der StrENtur/der Bestandteile
- Finition armature/structure/composants
- Tipo de acabado de la estructura/Soportes/ componente



- Colore dei componenti/stecche
- Component/Ribs colour
- Farbe der Bestandteile und Streben
- Couleur des composants et baleines
- Color de los componentes ò piezas/Varillas ò listones



SCOLARO PARASOL SRL UNIPERSONALE

Via Liguria, 197 35040 – Casale di Scodosia (PD) - Italy
Tel +39 0429 656687

info@scolaro-parasol.it
scolaro-parasol.it

SCOLARO-PARASOL.IT