

VERGÉS

VERGÉS

Wood, our passion.

Our commitment is to endure over time, we want to continue making solid, durable, comfortable furniture that ages with dignity and beauty. Our motivation is to improve every day and we incorporate innovative techniques that optimise the manufacturing of our pieces and allow us to explore contemporary languages with wood, our greatest passion.



Vergés chairs and furniture are the result of a combination of experience, vocation, quality and design. A family company born in Tortellà, a town in Alta Garrotxa, Vergés has been carrying out its business in the same location for more than 50 years. Such continuance provides insight into the company's philosophy, personality and way of working.

Las sillas y muebles de Vergés son el resultado de la conjunción de experiencia, vocación, calidad y diseño. La empresa familiar nacida en Tortellà, una localidad de la Alta Garrotxa, sigue desarrollando su actividad en el mismo lugar desde su fundación hace más de cincuenta años. Una permanencia que ayuda a entender la filosofía de la empresa, su forma de ser y su manera de trabajar.

The Vergés company is located in La Garrotxa in the province of Girona, a unique rural region halfway between the Mediterranean and the Pyrenees. Its volcanic orography has conditioned the landscape and vegetation, endowing it with spectacular beech tree forests. At any time of year, La Garrotxa is a burst of colours and nuances which contribute to a visual landscape that leaves a deep mark on the region's people.

The small workshop, founded in 1970 for the production of artisanal wicker chairs, as was the tradition in the region, evolved over the years to adapt to an increasingly demanding market. This evolution has required the use of the latest technology and the optimization of resources to turn the original workshop into a modern and dynamic factory. The current driving forces behind this new era for the company are Esteve and Joan, the founders' children, who always remain faithful to its roots, vocation, tradition and attention to detail. These principles are reflected in its current collections, where a dialogue is established between artisanship and modernity, and innovation goes hand in hand with quality materials, design and good finishes.

Today, Vergés products, which are developed by renowned design personalities, represent a benchmark for architects and interior designers in search of contemporary and high-quality chair and furniture collections for hotels, restaurants and public spaces.

Additionally, as interior design and design enthusiasts, Vergés understands that each project is a world in itself. As a result, it can adapt to the needs of any client, offering customized finishes for any model from the catalogue, high-quality fabrics and a wide range of materials and colours.

La empresa Vergés está situada en la Garrotxa, en la provincia de Girona, a medio camino entre el Mediterráneo y los Pirineos, un territorio rural único. Posee una orografía de origen volcánico que ha condicionado el paisaje y la vegetación, con espectaculares bosques de hayas. En cualquier estación del año, la Garrotxa es un estallido de colores y matices que configuran un paisaje visual y marcan profundamente a la gente de la comarca.

Aquel pequeño taller, fundado en 1970, para fabricar sillas artesanales de boga, algo muy ligado al territorio, fue evolucionando a lo largo de los años para adaptarse a un mercado cada vez más exigente. Esta evolución ha requerido emplear las últimas tecnologías y optimizar los recursos para convertir el taller original en una moderna y dinámica factoría. Actualmente son Joan y Esteve, hijos del matrimonio fundador, quienes impulsan la nueva etapa de la empresa, siempre fieles a sus orígenes, al oficio, la tradición y la atención por el detalle. Unos principios reflejados en las colecciones actuales, donde dialogan lo artesanal y lo moderno, en las cuales la innovación va de la mano de la calidad en los materiales, el diseño y los buenos acabados.

Hoy, los productos de Vergés, desarrollados por figuras relevantes del diseño, se han convertido en un referente para arquitectos e interioristas que buscan colecciones de sillas y mobiliario contemporáneo de alta calidad para la hostelería y espacios públicos.

Además, como apasionados del interiorismo y el diseño, Vergés entiende que cada proyecto es un mundo en sí mismo, de aquí, su capacidad de amoldarse a las necesidades de cada cliente, ofreciéndole la personalización de los acabados de cualquier modelo del catálogo con tejidos de alta calidad y una amplia paleta de materiales y colores.

All started here...



In 1970, Silvestre Vergés and Palmira Picart opened a modest workshop for producing the popular wicker chairs. They helped the Vergés company evolve and strengthen its position in the market while always remaining faithful to its roots, the values of local work and artisan tradition. Today, 50 years later, their children Joan and Esteve are overseeing the company's new era with enthusiasm and energy.

En 1970 Silvestre Vergés y Palmira Picart abrieron un modesto taller para fabricar las populares sillas de boga. Siempre fieles a sus orígenes, a los valores del trabajo local y a la tradición artesana consiguieron que la empresa Vergés evolucionara y afianzara su posición en el mercado. Hoy, 50 años después, sus hijos Joan y Esteve lideran con ilusión y energía la nueva etapa de la empresa.

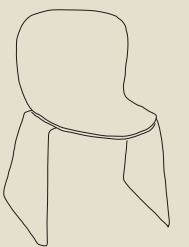
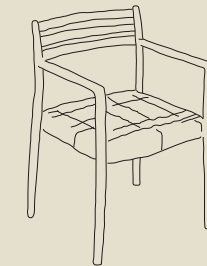
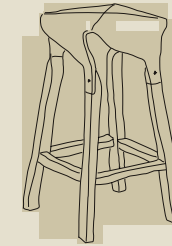
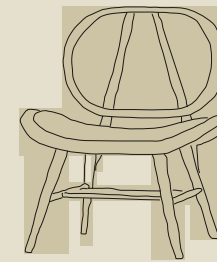
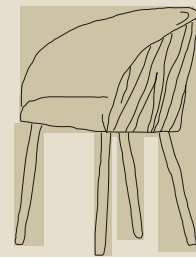

1970

1990

2015

2019

2020

2022



Our Origins

Collaborations with designers: Andreu Carulla, Lázaro Rosa-Violan, Sandra Tarruella, Ricard Trenchs...



New stage with the Artistic Direction Emiliana Design Studio



We celebrate our 50th anniversary by presenting the Bogart chair, designed by Manel Molina Studio



Company



Collections

VERGÉS

Nela Collection

NEW



P.14

Compass Collection



P.40

Goose Collection



P.80

Cistell Original Collection



P.116

ABC Collection



P.140

Atay Collection



P.168

Tura Collection

NEW



P.20

Ona Collection



P.52

Bernardes Collection



P.94

Cistell Curve Collection



P.124

Mim Collection



P.150

Sandwich Collection

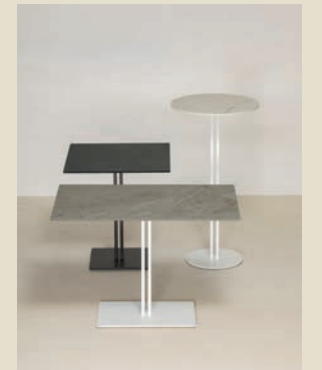

P.178

Conic Collection

NEW



P.30

Bogart Collection



P.64

Naoshima Collection



P.104

Cistell Slim Collection



P.132

Glöwr Collection

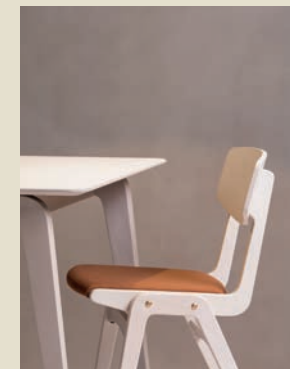

P.160

Dula Collection



P.186

Nela Collection

Designed by Emiliana Design Studio

The Nela collection is characterised by its aesthetic and constructive simplicity. It is manufactured in ash wood and its backrest seems to have been sculpted to delicately mould to the back. The seat can be woven with different materials to offer a soft and comfortable sitting position.

Nela is a quiet, austere, balanced collection, without complexity or visual dominance. Thanks to its versatility and timeless presence, it adapts naturally to any environment.

La colección Nela se caracteriza por su simplicidad estética y constructiva. Está fabricada en madera de fresno y su respaldo parece haber sido esculpido para adaptarse con delicadeza a la espalda. El asiento puede ser tramado con diferentes materiales sobre su estructura para ofrecer una sentada mullida y confortable.

Nela es una colección tranquila, austera, equilibrada, sin complejidad ni protagonismo visual, por su versatilidad y su presencia atemporal se adapta con naturalidad a cualquier entorno.

Nela chair / Ref. 440-02 / Structure and backrest: natural ash EM
Seat: 4cm wide paper wicker





1. Nela chair / Ref. 440-02 / Structure and backrest: natural ash EM
Seat: 4 cm wide paper wicker
2. Nela chair / Ref. 440-01 / Structure, backrest and seat: natural ash EM
3. Conic large table with double column / Plywood column base: Ref. 627-03
Ash table top: SOB - 633 de 290x140cm

Nela Collection

Structure and Backrest / Estructura y respaldo

Ash wood finished in natural wood color or open pore lacquered.

Madera maciza de fresno, acabado en madera natural o lacado a poro abierto.

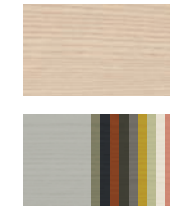

Seat / Asiento

01. Ash plywood finished in natural wood color or open pore lacquered / Contarchapado de fresno acabado en madera natural o lacado a poro abierto



Colour palette P. 200

02. Wrapping paper wicker / Encintado con cinta de papel



Colour palette P. 203

03. Wrapping with polyester belt / Encintado con cinta de poliéster

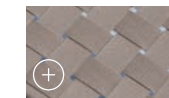

Colour palette P. 203

04. Woven with rope / Trenzado con cuerda



Colour palette P. 202

05. Upholstery / Tapizado

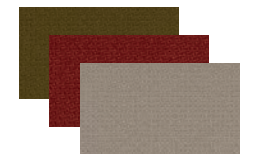

Great selection of fabrics. For more information on finishes, please consult our finishes catalogue.

Gran selección de tejidos. Más información de acabados consultar nuestro catálogo de acabados.

Collection Models



Nela chair

Nela chair / Ref. 440-01 / Structure, backrest and seat: natural ash EM
Conic large table with double column / Plywood column base: Ref. 627-03
Ash table top: SOB - 633 de 290x140cm

Tura Collection

Designed by Manel Molina Studio

The Tura chairs and stools are characterised by their graphically distinctive silhouettes. They are seats with friendly, serene and elegant shapes. The solid wood with its rounded finishes also provides a very warm and pleasant feel to the piece. Its generous dimensions together with its studied ergonomics make it a very comfortable collection that can be adapted to different interior spaces.

Las sillas y taburetes Tura destacan por sus siluetas gráficamente reconocibles. Son asientos de formas amables, serenas y elegantes. La madera maciza con sus acabados redondeados la convierten además en una pieza muy cálida y agradable al tacto. Las dimensiones generosas junto a su estudiada ergonomía hacen que sea una colección muy cómoda y adaptable a diferentes espacios de interior.

1. Tura chair / Ref. 525-01 / Structure, backrest and seat: lacquered ash RAL 8004 PO EM
2. Tura small stool / Ref. 528-01 / Structure and seat: natural ash EM
3. Tura small stool / Ref. 528-01 / Structure and seat: lacquered ash RAL 8004 PO EM





Tura chair / Ref. 525-03 / Structure and backrest: natural ash EM
 Seat: fully upholstered Gabriel Grain 61252
Conic large table / Ref. 627-02/ Base: lacquered ash RAL 9004 EM PO
 Top SOB — 633-01: lacquered ash RAL 9004 EM PO 140x140 cm

1. Tura chair / Ref. 525-01 / Structure, backrest and seat: natural ash EM
2. Conic large table / Ref. 627-02/ Base: lacquered ash RAL 9004 EM PO
 Top SOB — 633-01: lacquered ash RAL 9004 EM PO 140x140 cm
3. Tura chair / Ref. 525-03 / Structure and backrest: natural ash EM
 Seat: fully upholstered Gabriel Grain 61252



Tura chair / Ref. 525-01 / Structure, backrest and seat: lacquered ash RAL 5020 PO EM



Tura Collection



Tura chair / Ref. 525-02 / Structure and backrest: natural ash EM / Seat: upholstered Gabriel Grain 61252 with edge beading

25

Tura high stool / Ref. 526-01 / Structure and seat: lacquered ash RAL 1027 PO EM
Footrest: lacquered steel RAL 1027 matt
Conic high table / Ref. 626-02 / Base: ash plywood column, lacquered RAL 7044 PO EM
Top SOB – 633-01: ash veneer lacquered RAL 7044 PO EM 80x80 cm



Tura Collection



1. **Tura low stool** / Ref. 528-01 / Structure and seat: lacquered ash RAL 8004 PO EM
2. **Tura low stool** / Ref. 528-03 / Structure and seat: natural ash EM
Seat: fully upholstered Gabriel Grain 61252
3. **Tura low stool** / Ref. 528-01 / Structure and seat: natural ash EM
4. **Tura low stool** / Ref. 528-02 / Structure and seat: lacquered ash RAL 7044 PO EM
Seat: upholstered Gabriel Harmony 2103 with edge beading

- 1. **Tura low stool** / Ref. 528-01 / Structure and seat: lacquered ash RAL 8004 PO EM
- 2. **Tura low stool** / Ref. 528-03 / Structure and seat: natural ash EM
Seat: fully upholstered Gabriel Grain 61252
- 3. **Tura low stool** / Ref. 528-01 / Structure and seat: natural ash EM
- 4. **Tura low stool** / Ref. 528-02 / Structure and seat: lacquered ash RAL 7044 PO EM
Seat: upholstered Gabriel Harmony 2103 with edge beading



Tura Collection

Structure / Estructura

Ash wood finished in natural wood color or open pore lacquered.

Madera maciza de fresno, acabado en madera natural o lacado a poro abierto.



Colour palette P. 200

Footrest / Reposapiés

Elliptical iron metal ring painted in RAL colour.

Aro metálico elíptico de hierro pintado en color RAL.

Upholstered Seat / Asiento tapizado

Optional upholstered the interior of the seat or fully upholstered seat.

Opcional tapizado interior del asiento o completamente tapizada.

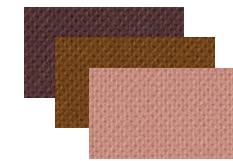

Seat / Asiento

Ash wood finished in natural wood color or open pore lacquered. Optional upholstered seat.

Madera maciza de fresno, acabado en madera natural o lacado a poro abierto. Opcional asiento tapizado.

Collection Models



Tura chair

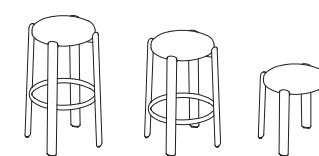

Tura stools
H75 / H65 / H45

Conic Collection

Designed by Emiliana Design Studio

Conic is a highly versatile table programme made up of central bases in plywood and tabletops in different formats and finishes. Its elegant conical shape presents a subtle geometric transition that transforms from a circle to a square, giving each base height its own unique shape.

Conic es un programa de mesas altamente versátil compuesto de bases centrales en tablero de madera contrachapada y sobres de diferentes formatos y acabados. Su elegante forma cónica presenta una sutil transición geométrica que evoluciona del círculo al cuadrado, confiriendo a cada altura de base una forma propia y singular.

1. **Conic large table** / Ref. 627-02 / Base: lacquered ash RAL 9004 EM PO
Top SOB — 633-01: lacquered ash RAL 9004 EM PO 140x140 cm
2. **Conic medium table** / Ref. 628-02 / Base: lacquered ash RAL 9004 EM PO
Top SOB — 633-01: lacquered ash RAL 9004 EM PO 90x90 cm
3. **Nela Chair** / Ref. 440-01 / Structure, backrest and seat: natural ash EM



Conic conference table / Ref. 627-03 / Double base: natural ash EM
Top SOB — 633-01: natural ash EM 290x140 cm
Goose chair / Ref. 874-02 Model A / Backrest: ash veneer single shell, varnished natural EM
Seat: upholstered with natural leather Mariano Farrugia Babel Siena / Structure: polish die-cast aluminium powder coated RAL 9004 matt, with swivel mechanism



Conic high table / Ref. 626-02 / Base: ash plywood column, natural varnished EM
Top SOB — 633-01: natural ash veneer EM 80x80 cm
Goose stool high / Ref. 877-02 / Backrest: ash veneer single shell, varnished natural EM
Seat: upholstered with natural leather Mariano Farrugia Babel Siena / Frame: steel tube
powder coated RAL 1013 matt / Legs: turned ash wood, varnished natural EM
Footrest: stainless steel



Conic high table with double base / Ref. 626-03 / Double base: ash plywood column,
lacquered RAL 8004 PO EM / Top SOB — 633-01: ash veneer lacquered RAL 8004 PO EM
240x80 cm / Connectivity element accessory: 634-I-01
Goose stool high / Ref. 877-02 / Backrest: ash veneer single shell, varnished natural EM
Seat: upholstered with natural leather Mariano Farrugia Babel Siena / Frame: steel tube
powder coated RAL 1013 matt / Legs: turned ash wood, varnished natural EM
Footrest: stainless steel



1. **Conic low table** / Ref. 629-02 / Base: ash plywood column, lacquered RAL 8004 PO EM
Top SOB — 633-01: ash veneer lacquered RAL 8004 PO EM 100x100cm
2. **Conic side table** / Ref. 630-02 / Base: ash plywood column, lacquered RAL 1013 PO EM
Top SOB — 633-01: ash veneer lacquered RAL 1013 PO EM 60x60 cm
3. **Atay pouf** / Ref. 386-01 / Base: ash veneer in samba wood, natural varnished EM
Seat: upholstered Gabriel Grain 68257
4. **Atay pouf** / Ref. 386-01 / Base: ash veneer in samba wood, natural varnished EM
Seat: upholstered Gabriel Grain 61229

Conic low table / Ref. 629-02 / Base: ash plywood column, natural varnished EM
Top SOB — 633-01: natural ash veneer EM 100x100cm
Bogart lounge / Ref. 502-02 / Structure: natural ash PO EM / Seat: upholstered with
natural leather Mariano Farrugia Babel Siena / Cushion Ref. 503-01





Conic Collection

Column / Columna

Ash plywood column, finished in natural or lacquered wood. Optional version with multiple columns.

Madera contrachapada de fresno, acabada en madera natural o lacada. Versión opcional con varias columnas.



Available with Charging System / Disponible con sistema de carga



Collection Models



Conic side table
H45 / Top: 60x60

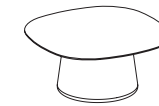

Conic low table
H45 / Top: 100x100



Conic medium table
H75 / Top: 90x90

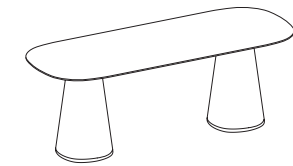

Conic double medium table
H75 / Top: 220x100



Conic large table
H75 / Top: 140x140

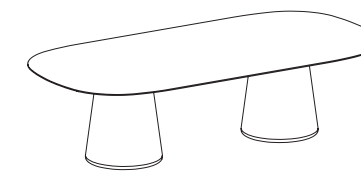

Conic conference table
H75 / Top: 290x140



Conic high table
H105 / Top: 80x80

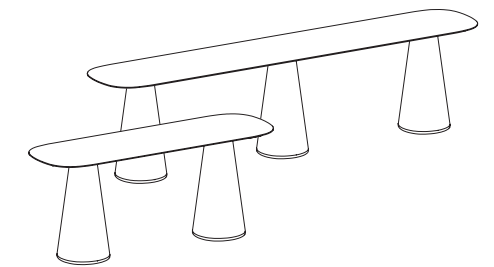

Conic high table - multiple bases
H105 / Top: 240x80

Top / Sobre

Top SOB — 633-01: 25 mm MDF with ash veneer finished in natural or lacquered wood.

Top SOB — 633-01: MDF de 25 mm con chapa de fresno, acabada en madera natural o lacada.



Colour palette
P. 200

Base

Water-repellent MDF lacquered in the same RAL colour. In the case of natural wood, the lacquer is RAL 1013 matt.

DM hidrófugo lacado en el mismo color RAL. En el caso de madera natural el lacado es RAL 1013 mate.

Compass Collection

Designed by Manel Molina Studio

Compass is characterized by its dynamic shape and use. This compact sleek chair is inspired by bistro style. Its original look invites us to socialize and to enjoy it in any space casually. Iconic, versatile and light, with high quality details in solid wood or combined with metal, it supports the most demanding contract.

Compass se caracteriza por su dinamismo en la forma y en el uso. Esta silla estilizada de reducidas dimensiones se inspira en la tipología bistró. Su original gesto nos invita a socializar y a disfrutar libremente de un uso desenfadado en cualquier espacio. Icónica, versátil y ligera, con detalles de alta calidad en madera maciza o combinada con metal, soporta el contract más exigente.



1. **Compass chair with metallic legs** / Ref. 366-01 / Structure: powder coated RAL 7039 textured / Seat and backrest: lacquered ash RAL 7039 PO EM
2. **Compass chair with wooden legs** / Ref. 365-01 / Structure: natural ash EM / Seat and backrest: natural ash EM
3. **Conic medium table** / Ref. 628-02/ Base: ash plywood column, natural varnished EM
Top SOB – 633-01: natural ash veneer EM 80 x 80 cm





P44 Compass chair with wooden legs / Ref. 365-02 / Structure and backrest: natural ash EM
Seat: upholstered with Gabriel Step Melange 61150
P45 Compass chair with wooden legs / Ref. 365-01 / Structure: natural ash EM
Seat and backrest: natural ash EM





Compass Collection



Compass chair with wooden legs / Ref. 365-02 / Structure and backrest: lacquered ash
RAL 6013 PO EM / Seat: upholstered Natural Leather - Mariano Farrugia Babel Stena



P48 Compass chair with metallic legs / Ref. 366-02 / Structure: powder coated RAL 6013 textured / Backrest: natural ash EM / Seat: upholstered Gabriel Cura 61232
P49 Compass chair with metallic legs - stackable / Ref. 367-01 / Structure: powder coated RAL 7039 textured / Seat and backrest: natural ash EM



Compass Collection



Backrest and seat / Respaldo y asiento

Ash wood finished in natural wood color or open pore lacquered.

Madera maciza de fresno, acabados en madera natural o lacado a poro abierto.



Colour palette
P. 200

Seat / Asiento

Optional upholstered seat / Opcional asiento tapizado



Great selection of fabrics. For more information on finishes, please consult our finishes catalogue.

Gran selección de tejidos. Más información de acabados consultar nuestro catálogo de acabados.



Structure / Estructura

Steel tube legs powder coated with RAL colours textured.

Estructura metálica pintada en polvo con colores RAL texturizados.

Structure / Estructura

Ash wood finished in natural wood color or open pore lacquered.

Madera maciza de fresno, acabados en madera natural o lacado a poro abierto.

Collection Models



Compass chair
with wooden legs



Compass chair with
metallic legs



Compass chair with
metallic legs
-stackable-

Ona Collection

Designed by Ramos & Bassols

Ona is a chair crafted from a single sheet of plywood, which expresses its rounded and subtle forms through its simplicity and elegance. Its versatility allows it to adapt to a wide range of needs, both for more challenging spaces as for other settings, where it always brings warmth and style. Combining different finishes and material sit adds multiple solutions to different environments and possibilities.

Ona es una silla conformada por una sola pieza de madera contrachapada, que expresa con sencillez y elegancia sus formas redondeadas y sutiles. Su versatilidad le permite adaptarse a una amplia gama de necesidades, tanto para equipamientos exigentes como para otros entornos, donde siempre aporta calidez y estilo. Combinando diferentes acabados y materiales añade múltiples soluciones a diversos ambientes y posibilidades.

Ona chair with sled base / Ref. 202-01 / Backrest & seat: ash veneer single shell, varnished natural EM / Structure: steel rods powder coated RAL 1013 matt





Ona stool / Ref. 205-01 / Structure: powder coated RAL 9004 matt / Seat: natural ash EM

- 1. **Ona chair with wooden legs** / Ref. 203-03 / Structure: natural ash EM
Seat and backrest: fully upholstered Gabriel Step Melange 68119
- 2. **Ona chair with wooden legs** / Ref. 203-01 / Structure and seat: beech dyed White 13 EM
- 3. **Ona chair with wooden legs** / Ref. 203-01 / Structure and seat: natural ash EM
- 4. **Conic medium table** / Ref. 628-02 / Base: ash plywood column, natural varnished EM
Top SOB — 633-01: natural ash veneer EM 120 x 120 cm





1. **Ona chair with swivel base** / Ref. 200-02 / Seat: lacquered ash RAL 9004 EM PO with upholstered interior natural leather Mariano Farrugia Babel New Cognac / Base: polish die-cast aluminium powder coated RAL 9004 matt, with swivel mechanism
2. **Conic table with double column** / Ref. 628-01/ Base: ash plywood double column, natural varnished EM Top SOB – 628-02: natural ash veneer EM 220x100cm
3. **Ona chair with wooden legs** / Ref. 203-01 / Structure and seat: lacquered ash RAL 9004 EM PO



Ona chair with sled base / Ref. 202-02 / Backrest & seat: ash veneer single shell, varnished natural EM with upholstered interior Gabriel Cura 62125 / Structure: steel rods powder coated RAL 1013 matt





Ona chair with sled base / Ref. 202-01 / Backrest & seat: ash veneer single shell, varnished natural EM / Structure: steel rods powder coated RAL 1013 matt



Ona Collection

Upholstery / Tapizado

Optional upholstered the interior of the seat or fully upholstered seat.

Opcional tapizado interior del asiento o completamente tapizada.

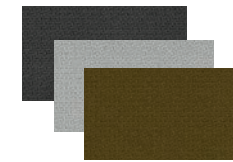

Structure / Estructura

Diferent options: turned legs in natural ash or beech; steel tube legs powder coated in RAL colours; sled base powder coated in RAL colours; frame with swivel mechanism, polished finish or powder coated in white or black.

Diferentes opciones: patas torneadas en fresno natural o haya; patas de acero acabado colores RAL; patas tipo patín acabado colores RAL; estructura con mecanismo giratorio, acabado pulido brillante o pintado en polvo color blanco o negro.



Seat/ Asiento

Single-shell in ash or beech plywood, finished in natural wood, dyed or open pore lacquered.

Monocarcasa en contrachapado de fresno o haya, acabada en madera natural, haya teñida o fresno lacada a poro abierto.



Colour palette P. 200-201

Collection Models



Ona chair with wooden legs
-stackable-



Ona chair with metallic legs
-stackable-



Ona chair with sled base
-stackable-



Ona chair with swivel base with 4 legs

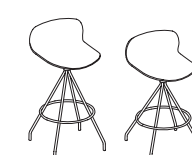

Ona stool
H65 / H75

Bogart Collection

Designed by Manel Molina Studio

The Bogart collection is a contemporary, robust and comfortable reinterpretation of traditional bulrush chairs. Craftsmanship and timelessness are the defining concepts of this iconic seat collection, very present in our collective memory. In all its versions, chair, armchair or stool, the Bogart seats remind us of the quintessential Mediterranean chair.

La colección Bogart propone una relectura contemporánea, robusta y confortable de las tradicionales sillas de enea. Artesanía y atemporalidad son conceptos que definen esta colección de asientos icónicos, muy presentes en nuestra memoria colectiva. En cualquiera de sus versiones, silla, butaquita o taburete, los asientos Bogart nos evocan al arquetipo de la silla mediterránea por excelencia.



1. **Bogart chair with armrests** / Ref. 501-01 / Structure: natural ash PO EM
Seat: woven with natural paper in 2 passes
2. **Bogart chair** / Ref. 500-01 / Structure: lacquered ash RAL 9004 PO EM
Seat: woven with black paper in 4 passes
3. **Bogart chair with armrests** / Ref. 501-02 / Structure: lacquered ash RAL 9004 PO EM / Seat: upholstered Gabriel Fame 60999

Bogart is a timeless, sturdy and comfortable chair that comes in ash or beech structure as its versions with or without arms.

Bogart es una silla atemporal, robusta y confortable que se presenta en estructura de fresno o haya y en sus versiones con y sin brazos.

1. **Bogart high stool with backrest** / Ref. 515-03 / Structure: lacquered ash RAL 7044 PO EM / Seat: wrapping with acrylic polyester belt Graphite / Footrest: stainless steel
2. **Bogart chair with armrests** / Ref. 501-02 / Structure: lacquered ash RAL 6013 PO EM / Seat: upholstered Gabriel Grain 60302
3. **Bogart chair with armrests** / Ref. 501-01 / Structure: natural ash PO EM / Seat: woven with natural paper in 4 passes





Restaurant Space

Bogart chairs with armrests / Ref. 501-01 / Structure: lacquered ash RAL 9004 PO EM
Seat: woven with natural paper in 4 passes



Bogart lounge / Ref. 502-04 / Structure: lacquered ash RAL 9004 PO EM
Seat: wrapping recycled leather Black
Conic side table / Ref. 630-02 / Base: natural ash plywood column / Top Sob 633-01:
varnished natural ash veneer AN 50 x 50 cm

“Craftsmanship, timelessness and a contemporary design are the features of the Bogart chair.”
— Manel Molina



Residential Space

1. Bogart lounge / Ref. 502-01 / Structure: lacquered ash RAL 9004 PO EM

Seat: woven with natural paper in 4 passes

2. Atay hex low table / Ref. 380-01 / Base: metal powder coated RAL 9004 textured / Top: solid oak wood, natural varnished EM



1. **Bogart medium stool with backrest** / Ref. 516-01 / Structure: natural ash PO EM
Seat: woven with natural paper in 4 passes / Footrest: steel lacquered RAL7039 matt

2. **Bogart medium stool with backrest** / Ref. 516-05 / Structure: natural ash PO EM
Seat: wrapping with full grain leather belt Natural / Footrest: steel lacquered RAL 7039 matt



Bogart Collection



Bogart medium stool / Ref. 517-01 / Structure: lacquered ash RAL 9004 PO EM
Seat: woven with black paper in 4 passes / Footrest: stainless steel



Bogart chair / Ref. 500-05 / Structure: natural ash PO EM / Seat: wrapping with full grain leather belt Natural

- 1. Bogart lounge** / Ref. 502-02 / Structure: natural ash PO EM / Seat: upholstered with natural leather Mariano Farrugia Babel Siena / Cushion Ref. 503-01
- 2. Bogart medium stool with backrest** / Ref. 516-05 / Structure: natural ash PO EM / Seat: wrapping with full grain leather belt Natural / Footrest: steel lacquered RAL 7039 matt



1. **Bogart chair** / Ref. 500-03 / Structure: lacquered ash RAL 7044 PO EM / Seat: wrapping with acrylic polyester belt Stone
 2. **Bogart chair** / Ref. 500-01 / Structure: natural ash EM / Seat: woven with natural paper in 2 passes



Bogart Collection

Structure / Estructura

Ash or beech solid wood finished in natural colour, dyed or lacquered open pore.

Madera de fresno o haya maciza, acabado en color natural, tintado o lacado a poro abierto.



Colour palette
P. 200-201



Backrest / Respaldo

Optional upholstered backrest/
Opcional respaldo tapizado

Seat / Asiento

01. Woven / Trenzado

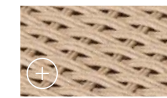

Colour palette
P. 202

02. Upholstery / Tapizado

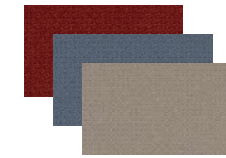

Great selection of fabrics.
For more information on finishes,
please consult our finishes
catalogue.

Gran selección de tejidos.
Más información de acabados
consultar nuestro catálogo de
acabados.

03. Wrapping with polyester belt / Encintado con cinta de poliéster

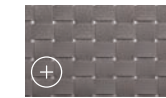

Colour palette
P. 203

04. Wrapping with full grain leather / Encintado con cinta de cuero natural



Colour palette
P. 203

05. Wrapping with recycled leather / Encintado con cinta de cuero reciclado



Colour palette
P. 203

Collection Models



Bogart chair



Bogart chair with armrests

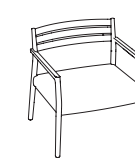

Bogart lounge

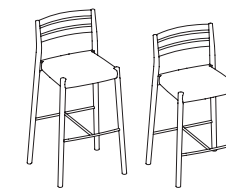

Bogart stool with backrest
H65 / H75

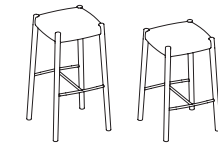

Bogart stool
H65 / H75

Goose Collection

Designed by Emiliana Design Studio

Goose is a versatile collection of comfortable and contact-friendly chairs with organic and fluid lines. With simplicity and precision a single sheet of plywood curves to set up seat and backrest, making the most of the warmth and expressiveness of the material.

Goose es una colección versátil de sillas cómodas y agradables, de líneas orgánicas y fluidas. Con simplicidad y precisión una única lámina de madera contrachapada se curva para configurar asiento y respaldo, aprovechando así al máximo la calidez y expresividad del material.

Goose chair / Ref. 873-01 Model B / Backrest & seat: ash veneer single shell, varnished natural EM
Structure: ash solid wood varnished natural EM



Goose chair / Ref. 873-01 Model B / Backrest & seat: ash veneer single shell, varnished natural EM
Structure: ash solid wood varnished natural EM





Goose chair / Ref. 873-02 Model B / Backrest: ash veneer single shell, varnished natural EM
Seat: upholstered leather Mariano Farrugia Babel Burgundy / Structure: ash solid wood
varnished natural EM



1. Goose stool medium / Ref. 878-01 / Backrest and seat: ash veneer single shell, lacquered RAL 8004 PO EM / Frame: steel tube powder coated RAL 8004 matt / Legs: turned ash wood, lacquered RAL 8004 PO EM / Footrest: stainless steel
2. Goose stool high / Ref. 877-01 / Backrest and seat: ash veneer single shell, varnished natural EM
Frame: steel tube powder coated RAL 1013 matt / Legs: turned ash wood, varnished natural EM
Footrest: stainless steel

Working area

1. **Goose chair** / Ref. 874-01 Model A / Backrest and seat: ash veneer single shell, dyed Blue 54 EM
Structure: polish die-cast aluminium powder coated RAL 5004 matt, with swivel mechanism

2. **Goose chair** / Ref. 872-01 Model C / Backrest and seat: ash single shell, lacquered RAL 8004 PO EM
Structure: steel tube powder coated RAL 8004 textured



Goose Collection

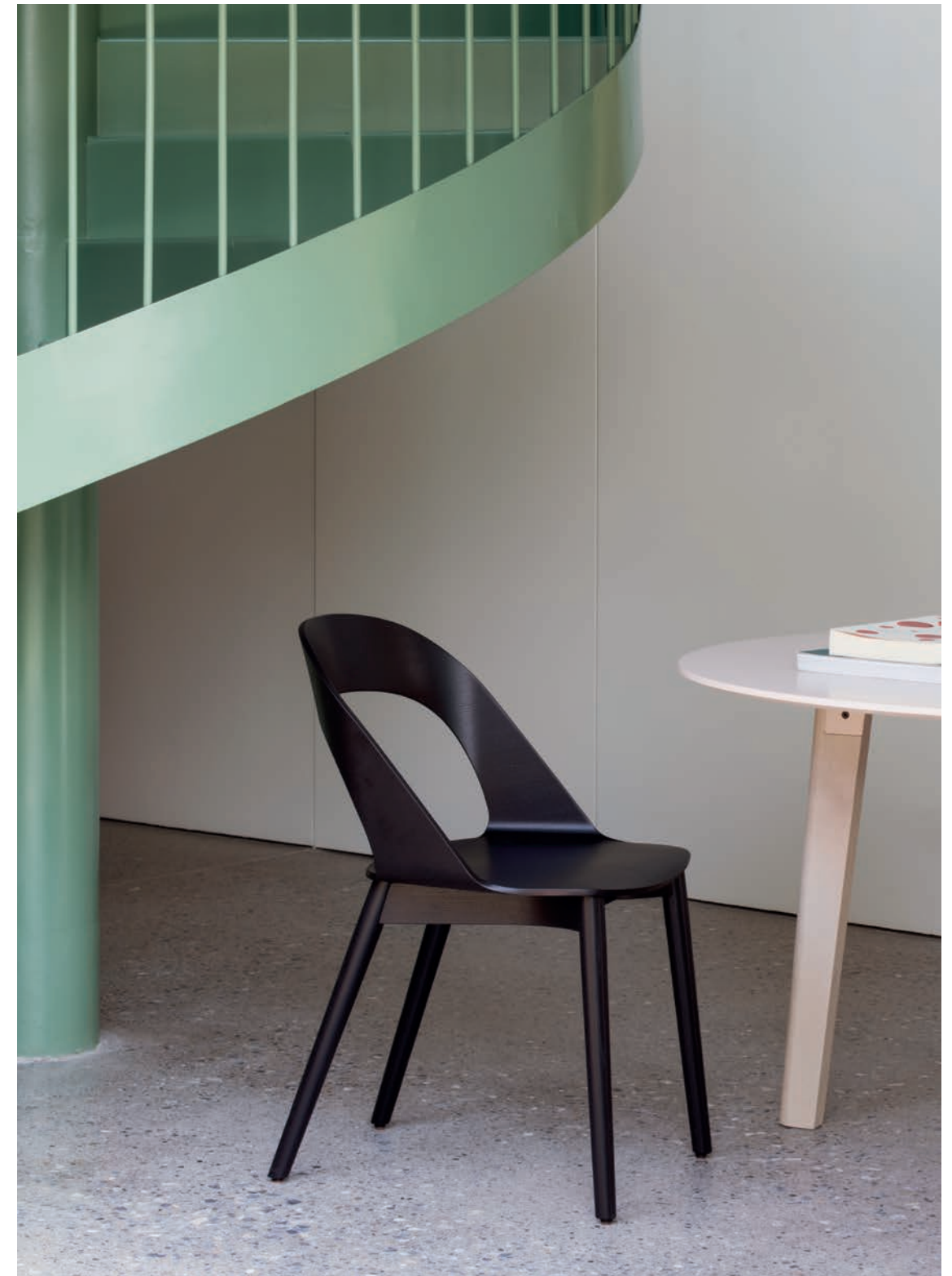

Goose chair / Ref. 873-01 Model D / Backrest & seat: ash single shell, lacquered RAL 9004 PO EM / Structure: ash solid wood lacquered RAL 9004 PO EM

- 1. Goose chair** / Ref. 874-01 model A / Backrest & seat: ash veneer single shell, dyied Blue 54 EM
Frame: polish die-cast aluminium powder coated RAL 5004 matt, with swivel mechanism
- 2. Goose stool** / Ref. 877-01 / Backrest & seat: ash veneer single shell, varnished natural EM / Frame: steel tube powder coated RAL 1013 matt / Legs: turned ash wood varnished natural EM / Footrest: stainless steel
- 3. Goose chair** / Ref. 872-01 model C / Backrest & seat: ash veneer single shell, lacquered RAL 8004 PO EM
Frame: steel tube powder coated RAL 8004 textured
- 4. Goose chair** / Ref. 873-01 model B / Backrest & seat: ash veneer single shell, varnished natural EM
Frame: ash solid wood varnished natural EM
- 5. Goose chair** / Ref. 875-01 model D / Backrest & seat: ash veneer single shell, lacquered RAL 9004 PO EM
Frame: polish die-cast aluminium powder coated RAL 9004 textured, with swivel mechanism

Goose is presented in five different silhouettes, chairs, armchairs and stool, all of them of great comfort and that in turn dialogue with each other following a common aesthetic language.

Goose se presenta en cinco siluetas distintas, sillas, silloncitos y taburete, todas ellas de gran confort y que a su vez dialogan entre sí siguiendo un lenguaje estético común.





Goose Collection



P.90 Goose chair / Ref. 873-01 Model B / Backrest & seat: ash veneer single shell, varnished natural EM / Structure: ash solid wood varnished natural EM
P.91 Goose chair / Ref. 873-02 Model A / Backrest & seat: ash single shell, lacquered RAL 7044 PO EM / Seat: upholstered leather Mariano Farrugia Babel Miel
Structure: ash solid wood lacquered RAL 7044 PO EM

Goose Collection

Shell / Carcasa

4 different shell models in ash plywood, with a natural wood finish or lacquered with open pore.

4 Modelos de recorte de carcasa en contrachapado de fresno acabado maderal natural o lacado a poro abierto.



Seat / Asiento

Optional upholstered seat / Opcional asiento tapizado



Great selection of fabrics. For more information on finishes, please consult our finishes catalogue.

Gran selección de tejidos. Más información de acabados consultar nuestro catálogo de acabados.

Structure / Estructura

Different leg options: solid wood; steel powder coated in RAL colours; swivel base with or without rollers.

Diferentes opciones de pata: de madera maciza (silla y taburete); patas metálicas de acero pintado en polvo con colores RAL; base giratoria con y sin ruedas.

Leg options / Opciones de pata



Goose Collection

Goose Collection



Model A



Goose chair with armrests and metallic legs



Goose chair with armrests and wooden legs



Goose chair with armrests and swivel base with 4 legs



Goose chair with armrests, swivel base with 5 legs, gas lift and rollers



Model B



Goose chair with armrests and metallic legs



Goose chair with armrests and wooden legs



Goose chair with armrests and swivel base with 4 legs



Goose chair with armrests, swivel base with 5 legs, gas lift and rollers



Model C



Goose chair with metallic legs



Goose chair with wooden legs



Goose chair with swivel base with 4 legs



Goose chair with swivel base with 5 legs, gas lift and rollers



Model D



Goose chair with metallic legs



Goose chair with wooden legs



Goose chair with swivel base with 4 legs

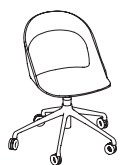

Goose chair with swivel base with 5 legs, gas lift and rollers



Goose stool
H75/ H65

Bernardes Collection

Designed by Andreu Carulla

Bernardes collection aims to capture the image of austerity and discretion that we associate with medieval Roman convents. As a result of this suggestive idea, the collection combines tradition, timelessness and the sobriety of that which must tolerate the passage of time.

La colección Bernardes pretende capturar la imagen de austeridad y discreción que asociamos a los conventos románicos medievales. El resultado de esta sugerente idea es unir en la colección la tradición, la atemporalidad y la sobriedad de aquello que debe soportar el paso del tiempo.

Bernardes lounge / Ref. 293 / Frame: beech solid wood dyed Pink 32 EM
Backrest: rattan mesh dyed Pink 32 EM / Seat: upholstered leather Mariano Farrugia Babel Siena
Bernardes bench / Ref. 292 / Frame: beech solid wood dyed White 13 EM
Backrest: rattan mesh dyed White 93 EM / Seat: upholstered Gabriel Mood 1105



Bernardes lounge / Ref. 293 / Frame: beech solid wood dyed Pink 32 EM
Backrest: rattan mesh dyed Pink 32 EM / Seat: upholstered leather Mariano Farrugia Babel Siena
Bernardes bench / Ref. 292 / Frame: beech solid wood dyed White 13 EM
Backrest: rattan mesh dyed White 13 EM / Seat: upholstered Gabriel Mood 1105



Bernardes, comfortable and sophisticated in its chair, armchair and bench versions, combine beechwood, upholstered fabric or leather, and artisan wickerwork to make robust and long-lasting pieces.

Bernardes, confortables y sofisticadas, en sus versiones de silla, sillón y banco, combinan la madera de haya, la tela o cuero tapizados y la cestería de ratán artesanal, unos materiales que las hacen robustas y duraderas.



1. **Bernardes chair** / Ref. 290 / Structure: beech solid wood dyed Grey 74 EM
Backrest: rattan mesh dyed White 13 EM / Seat: upholstered Gabriel Mood 1104
2. **Bernardes chair** / Ref. 290 / Structure: beech solid wood dyed White 13 EM
Backrest: rattan mesh dyed White 13 EM / Seat: upholstered Gabriel Mood 3101



Bernardes Collection



Bernardes lounge / Ref. 293 / Structure: beech solid wood dyed White 13 EM
Backrest: rattan mesh dyed White 13 EM / Seat: upholstered Gabriel Mood 1105



P.100 Bernardes lounge / Ref. 293 / Structure: beech solid wood dyed White 13 EM
Backrest: rattan mesh dyed White 13 EM / Seat: upholstered leather Mariano Farrugia Babel Siena
P.101 Bernardes bench / Ref. 292 / Frame: beech solid wood dyed White 13 EM
Backrest: rattan mesh dyed White 13 EM / Seat: upholstered Gabriel Mood 1105



Bernardes Collection



Backrest / Respaldo

Paper wicker in the interior of the backrest / Interior del respaldo en rejilla de papel.



Structure / Estructura

Solid beech with a natural or dyed finish.

Madera maciza de haya en acabado natural o tintado.



Colour palette
P. 201



Seat / Asiento

Upholstered seat. /
Asiento tapizado.

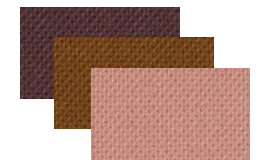

Great selection of fabrics. For more information on finishes, please consult our finishes catalogue.

Gran selección de tejidos. Más información de acabados consultar nuestro catálogo de acabados.

Collection Models



Bernardes
chair



Bernardes
lounge

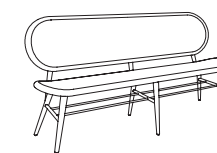

Bernardes
bench

Naoshima Collection

Designed by Emiliana Design Studio

The Naoshima stool collection plays with the expressive and structural potential of curved wood. The virtuously assembled meandering silhouette of the seat suggests visual play between matter and nothingness.

La colección de taburetes Naoshima experimenta con el potencial expresivo y estructural de la madera curvada. La sinuosa silueta del asiento, virtuosamente ensamblado, nos sugiere un juego visual entre la materia y el vacío.

Naoshima medium stool / Ref. 702 / Legs: oak solid wood lacquered RAL 1027 PO AN
Seat: oak veneer lacquered RAL 1027 PO AN





1. Naoshima low stool Ref. 703 / Legs: oak solid wood varnished natural EM
 Seat: oak veneer varnished natural EM
2. Naoshima low stool / Ref. 703 / Legs: oak solid wood lacquered RAL 6006 PO AN
 Seat: oak veneer lacquered RAL 6006 PO AN
3. Naoshima low stool / Ref. 703 / Legs: oak solid wood lacquered RAL 1027 PO AN
 Seat: oak veneer lacquered RAL 1027 PO AN



The visual plasticity of wood makes our Naoshima stool collection unique and special.



Naoshima medium stool / Ref. 702 / Legs: beech solid wood dyed White 13 EM
Seat: beech veneer dyed White 13 EM



Naoshima Collection

1. **Naoshima low stool** / Ref. 703 / Legs: oak solid wood lacquered RAL 1027 PO AN
Seat: oak veneer lacquered RAL 1027 PO AN
2. **Naoshima medium stool** / Ref. 702 / Legs: beech solid wood dyed White 13 EM
Seat: beech veneer dyed White 13 EM
3. **Naoshima high stool** / Ref. 701 / Legs: oak solid wood lacquered RAL 9004 PO EM
Seat: oak veneer lacquered RAL 9004 PO EM
4. **Naoshima medium stool** / Ref. 702 / Legs: oak solid wood varnished natural EM
Seat: oak veneer lacquered RAL 9004 PO EM
5. **Naoshima low stool** Ref. 703 / Legs: oak solid wood varnished natural EM
Seat: oak veneer varnished natural EM



Naoshima Collection



Naoshima Collection



Asiento / Seat

Plywood beech or oak with natural wood finish; dyed beech or lacquered oak. Different combinations of seat and legs finishes.

Madera contrachapada de haya o roble acabado en madera natural; haya tintada o roble lacado. Diferentes combinaciones de acabados entre patas y asiento.

Structure / Estructura

Beech or oak wood with natural wood finish; dyed beech or lacquered oak.

Madera de haya o roble acabado en madera natural; haya tintada o roble lacado.



Colour palette
P. 200-201



Collection Models

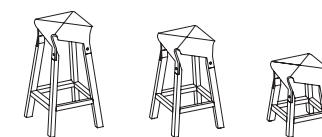

Naoshima stools
H75 / H65 / H45

Cistell Original Collection

Designed by Yago Sarri

Cistell Original is a collection of chairs and armchairs. Cistell Original was the first piece of a collection which, over the years, has become a true icon of Vergés. It is an enveloping and comfortable chair that adapts to meeting and restaurant spaces.

Cistell Original es una familia de sillas y silloncitos. La Cistell Original es la pieza primigenia de una colección que con los años se ha convertido en todo un icono de Vergés. Es una silla envolvente y confortable que se adapta a espacios de reunión y restauración.



Cistell Original lounge / Ref. 795-04 / Backrest and legs: lacquered ash RAL 9004 PO EM
Seat and interior backrest: upholstered natural leather Mariano Farrugia Babel Miel



Cistell Original chair / Ref. 792-09 / Seat and backrest: upholstered Gabriel Select 60051 / Legs: steel tube finished powder coated RAL 9004 textured
Sandwich table / Ref. 359-01 / Column and base: powder coated RAL 9004 textured / Top Sob-051: lacquered ash RAL 9004 PO Ø 140 cm

Cistell Original Collection



Cistell Original chair / Ref. 792-03/ Backrest: ash veneer natural varnished EM
Seat: upholstered Spradling Dolce Moss / Legs: steel tube finished powder coated RAL 9004 textured
Sandwich table / Ref. 356-01 / Base: powder coated RAL 9003 matt covered with wood column
Top SOB-977: natural ash veneer EM Ø 90 cm

We offer a wide range of finishes to meet the needs of different spaces.



Cistell Original chair / Ref. 792-04 / Backrest: natural walnut MI / Seat and interior backrest: upholstered Gabriel Select 61185 / Legs: Solid beech wood dyed Walnut EM





Cistell Original Collection

Backrest / Respaldo

Different backrest finishes: beech or ash plywood, natural wood, dyed or lacquered; upholstered the interior or all of the backrest.

Diferentes acabados de respaldo: en contrachapado de haya o fresno acabado en madera natural, tintada o lacada; tapizado interior o total del respaldo.

Structure / Estructura

Different types of wooden, metallic or sled base legs.

Diferentes versiones de patas de madera, metálicas o de patín.



Seat / Asiento

Upholstered seat. / Asiento tapizado.



Great selection of fabrics. For more information on finishes, please consult our finishes catalogue.

Gran selección de tejidos. Más información de acabados consultar nuestro catálogo de acabados.

Collection Models



Cistell Original chair with wooden legs



Cistell Original chair with metallic legs



Cistell Original chair with sled base



Cistell Original lounge with wooden legs



Cistell Original lounge with metallic legs



Cistell Original lounge with sled base

Cistell Curve Collection

Designed by Yago Sarri

Cistell Curve offers a sinuous design which lengthens the back of the chair into an occasional armrest. It is an enveloping and comfortable chair that adapts to meeting and restaurant spaces. Cistell Curve is available in a chair and lounge model.

La Cistell Curve ofrece un recorte sinuoso que prolonga el respaldo en un reposa brazos ocasional. Es una silla envolvente y confortable que se adapta a espacios de reunión y restauración. La Cistell Curve está disponible en modelos de silla y lounge.



Cistell Curve chair / Ref. 791-01 / Backrest and legs: lacquered ash RAL 5004 PO EM
Seat: upholstered Gabriel Select 66144
Sandwich table / Ref. 351-01 / Column and base: powder coated RAL 5004 PO EM
Top Sob-009: beech dyed white 93 MI 70x70 cm



Cistell Curve Collection



- 1. **Cistell with armrests** / Ref. 791-07 / Seat and Backrest: upholstered Gabriel Select 60133
Legs: Ash PO AN
- 2. **Cistell with armrests** / Ref. 791-01 / Backrest and legs: dyied beech white 13 MI
Seat: upholstered Gabriel Select 60131
- 3. **Cistell with armrests** / Ref. 791-01 / Backrest and legs: lacquered ash RAL 5004 PO EM
Seat: upholstered Gabriel Select 66144



Cistell Curve Collection



Cistell Curve lounge / Ref. 794-02 / Backrest: beech dyed White 13 matt
Seat: upholstered Gabriel Go Uni 61138 / Legs: sled base powder coated
RAL 1013 matt/ Cushion Ref. 823-01

Cistell Curve Collection



Backrest / Respaldo

Different backrest finishes:
beech or ash plywood, natural
wood, dyed or lacquered;
upholstered the interior or all of
the backrest.

Diferentes acabados de respaldo:
en contrachapado de haya o
fresno acabado en madera
natural, tintada o lacada; tapizado
interior o total del respaldo.

Structure / Estructura

Different types of wooden, metallic or
sled base legs.

Diferentes versiones de patas de
madera, metálicas o de patín.



Seat / Asiento

Upholstered seat. /
Asiento tapizado.

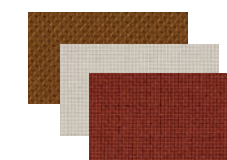

Great selection of fabrics. For
more information on finishes,
please consult our finishes
catalogue.

Gran selección de tejidos.
Más información de acabados
consultar nuestro catálogo de
acabados.

Collection Models



Cistell Curve chair
with wooden legs



Cistell Curve chair
with metallic legs



Cistell Curve chair
with sled base



Cistell Curve lounge
with wooden legs



Cistell Curve lounge
with metallic legs



Cistell Curve lounge
with sled base

Cistell Slim Collection

Designed by Yago Sarri

Cistell Slim is a collection of chairs, armchairs and stools. Cistell Slim is the most synthesized and compact version without renouncing comfort and ideal for small spaces.

Cistell Slim es una familia de sillas, silloncitos y tamburetes. La Cistell Slim es la versión más sintetizada de la familia, de medida compacta sin renunciar al confort, muy indicada para los espacios más reducidos.

Cistell Slim chair with metallic legs / Ref. 790-03 / Backrest: Natural ash PO EM
Seat: upholstered Gabriel Select 60051 / Structure: steel tube finished powder coated RAL 9004 textured





P134 Cistell Slim chair with wooden legs / Ref. 790-01 / Backrest and structure: lacquered ash
RAL 7044 PO EM / Seat: upholstered Gabriel Step 60004
P135 Cistell Slim stool high / Ref. 796-05 / Backrest and seat: Upholstered Gabriel Step 60004
Structure: Natural ash PO EM



Cistell Slim high stool with swivel base / Ref. 798-01 / Backrest: Natural ash PO EM
Seat: Upholstered Gabriel Tonal 60999 / Structure: swivel base powder coated RAL 9004 Matt



Cistell Slim Collection



1. Cistell Slim high stool with metallic sled base / Ref. 797-01 / Backrest: dyed beech
Green 66 MI / Seat: upholstered Gabriel Tonal 67089 / Structure: sled base powder coated
RAL 6006 Matt

2. Cistell Slim high stool with wooden legs / Ref. 796-01 / Backrest and structure:
lacquered ash RAL 5004 PO EM / Seat: upholstered Gabriel Atlantic 66057 / Footrest:
stainless steel

Cistell Slim medium stool with sled base / Ref. 797-02 / Backrest: Natural ash PO EM
 Seat: upholstered Gabriel Cura 68181 / Structure: sled base powder coated RAL 6013 Textured
Cistell Slim lounge with metallic legs / Ref. 793-03 / Backrest: Natural ash PO EM
 Seat: upholstered Gabriel Cura 68181 / Structure: metal tube powder coated RAL 6013 Textured



Cistell Slim Collection

Cistell Slim Collection



Backrest / Respaldo

Different backrest finishes: beech or ash plywood, natural wood, dyed or lacquered; upholstered the interior or all of the backrest.

Diferentes acabados de respaldo: en contrachapado de haya o fresno acabado en madera natural, tintada o lacada; tapizado interior o total del respaldo.

Structure / Estructura

Different types of wooden, metallic or sled base legs.

Diferentes versiones de patas de madera, metálicas o de patín.

Seat / Asiento

Upholstered seat. / Asiento tapizado.

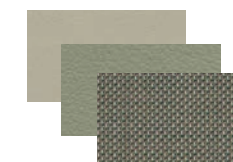

Great selection of fabrics. For more information on finishes, please consult our finishes catalogue.

Gran selección de tejidos. Más información de acabados consultar nuestro catálogo de acabados.

Collection Models



Cistell Slim chair with wooden legs



Cistell Slim chair with metallic legs



Cistell Slim chair with sled base



Cistell Slim lounge with wooden legs



Cistell Slim lounge with metallic legs



Cistell Slim lounge with sled base

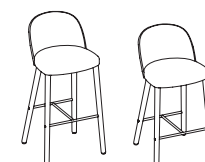

Cistell Slim stool with wooden legs
H75 / H65

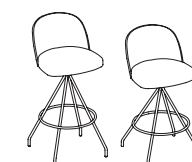

Cistell Slim stool with swivel base
H75 / H65



Cistell Slim stool with sled base
H75 / H65

ABC Collection

Designed by Lázaro Rosa-Violán

In the world of language, ABC represents the alphabet and brings us closer to schools and classrooms, where Lázaro Rosa-Violán found the inspiration to create this collection of elemental chairs. ABC chairs are lightweight and balanced, combining great comfort with strength and durability. They evoke a certain timelessness.

En el mundo del lenguaje, ABC representa el abecedario, también nos acerca al mundo de las aulas y los colegios, en el que Lázaro Rosa-Violán se ha inspirado para crear esta colección de sillas. Las sillas ABC son ligeras y equilibradas, combinan un gran confort con la resistencia y durabilidad, y evocan un cierto carácter de atemporalidad.



ABC chair / Ref. 970-02 / Frame: powder coated RAL 7044 matt / Seat and backrest: beech veneer dyed Grey 74 EM, upholstered Gabriel Crisp 4031



ABC chair with armrests / Ref. 971-02 / Seat and backrest: beech veneer dyed Walnut EM with upholstered interior Spradling Dolce Chocolate / Structure: powder coated RAL 9004 matt

1. ABC chair with armrests / Ref. 973-02 / Frame: powder coated RAL 7030 matt
Seat and backrest: ash veneer natural varnished EM / Legs: ash solid wood natural varnished EM / Seat: upholstered Gabriel Crisp 4033
2. ABC chair / Ref. 972-02 / Frame: powder coated RAL 6013 textured /
Seat and backrest: ash veneer natural varnished EM / Legs: ash solid wood natural varnished EM / Seat: upholstered Gabriel Harmony 4104





ABC chair / Ref. 972-02 / Frame: powder coated RAL 5004 satin / Seat and backrest: ash veneer lacquered RAL 5004 PO AN / Legs: ash solid wood lacquered RAL 5004 PO AN / Seat: upholstered Gabriel Crisp 4125

ABC chair with armrests / Ref. 973-02 / Frame: powder coated RAL 1027 satin / Seat and backrest: ash veneer lacquered RAL 1027 PO AN / Legs: ash solid wood lacquered RAL 1027 PO AN / Seat and backrest: upholstered Gabriel Crisp 4211





ABC Collection



Multi-purpose space

P.148 ABC chair / Ref. 972-01 / Frame: powder coated RAL 8023 satin / Seat and backrest: ash veneer natural varnished EM / Legs: ash solid wood natural varnished EM

P.149 ABC chair with armrests / Ref. 973-01 / Frame: powder coated RAL 8023 satin / Seat and backrest: ash veneer natural varnished EM / Legs: ash lacquered in RAL 8023 satin



ABC Collection

Backrest and seat / Respaldo y asiento

Beech or ash plywood, finished in natural wood, dyed beech or open pore varnished ash. Optional upholstered seat or seat and backrest set.

Contrachapado de haya o fresno, acabados en madera natural, haya tintada y fresno lacado a poro abierto. Opcional tapizado de asiento o el conjunto de asiento y respaldo.

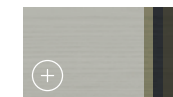

Colour palette
P. 200-201



Structure / Estructura

Steel tube frame powder coated in RAL colours.

Estructura en tubo de acero pintado en polvo con colores RAL.

Legs / Patas

Different version of legs: Steel tube legs powder painted in RAL colours or solid beech or ash legs with metallic cones, finished in natural wood, dyed or lacquered.

Diferentes opciones de patas: en tubo de acero pintado en polvo con colores RAL o patas de madera maciza de haya o fresno con conos metálicos.

Collection Models



ABC chair with metallic legs



ABC chair with armrests and metallic legs



ABC chair with wooden legs



ABC chair with armrests and wooden legs

Mim Collection

Designed by Sandra Tarruella & Ricard Trenchs

Mim is an extensive, visually lightweight collection. Both its versatility in finishes and its timeless and honest language make it perfectly suited for the rustic and sophisticated interiors of restaurants, cafeterias and waiting areas.

Mim es una amplia colección de gran ligereza visual. Tanto su versatilidad en acabados, como su lenguaje atemporal y honesto, la hacen muy adecuada para equipar interiores rústicos y sofisticados, de restaurantes, cafeterías y zonas de espera.

Mim chair / Ref. 754 / Frame: powder coated RAL 7044 matt / Seat: upholstered Gabriel Go Check 60093 / Backrest: oak solid wood varnished natural EM
Mim table / Ref. 764 – Base: powder coated RAL 7044 matt
Top Sob-758: Laminated Dekton Sirius. Oak solid wood edge, varnished natural EM Ø 70 cm





1. **Mim chair** / Ref. 754 / Frame: powder coated RAL 8023 matt / Seat: upholstered Gabriel Go check 63080 / Backrest: beech solid wood lacquered RAL 8023 AN
2. **Mim bench** / Ref. 757 / Frame: powder coated RAL 5004 matt / Seat: upholstered Gabriel Go check 60080 / Backrest: beech solid wood dyed White 93 EM
3. **Mim stool** / Ref. 755 / Frame: powder coated RAL 5004 matt / Seat: upholstered Gabriel Go check 66140 / Backrest: beech solid wood dyed White 93 EM



1. Mim stool / Ref. 755 / Frame: powder coated RAL 9004 matt / Seat: upholstered Gabriel Go Check 60084 / Backrest: oak solid wood varnished natural EM
2. Mim chair / Ref. 754 / Frame: powder coated RAL 9004 matt / Seat: upholstered Gabriel Go Check 60084 / Backrest: oak solid wood varnished natural EM
3. Mim table / Ref. 764 – Base: powder coated RAL 9004 matt
 Top Sob-758: Laminated Dekton Sirius. Oak solid wood edge, varnished natural EM Ø 70 cm





Restaurant Space

Mim chair / Ref. 754 / Frame: powder coated RAL 9004 matt / Seat: upholstered
 Gabriel Go Check 61138 / Backrest: oak solid wood varnished natural EM
Mim table medium / Ref. 763 / Base: powder coated RAL 9004 matt
 Top Sob-758: Laminated Dekton. Oak solid wood edge, varnished natural EM Ø 60 cm

Mim Collection



Mim chair / Ref. 754 / Frame: powder coated RAL 9004 matt / Seat: upholstered
 Gabriel Go Check 61138 / Backrest: oak solid wood varnished natural EM

Mim Collection



Mim chair / Ref. 754 / Frame: powder coated RAL 9004 matt / Seat: upholstered
 Gabriel Go Check 60084 / Backrest: oak solid wood varnished natural EM
Mim table / Ref. 764 - Base: powder coated RAL 9004 matt
 Top Sob-758: Laminated Dekton Sirius. Oak solid wood edge, varnished natural EM Ø 70 cm

Mim Collection

Seat / Asiento

Removable seat with zip in the back. /
 Asiento desenfundable con cremallera posterior.

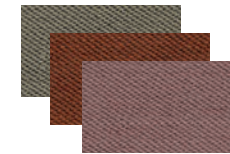

Great selection of fabrics. For more information on finishes, please consult our finishes catalogue.

Gran selección de tejidos. Más información de acabados consultar nuestro catálogo de acabados.

Backrest / Respaldo

Solid curved beech or ash wood, finished in natural colour, dyed or open pore lacquered.

Madera maciza curvada de haya o fresno, acabado en color natural, haya tintada o fresno lacado a poro abierto.

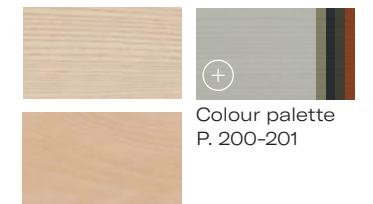

Colour palette P. 200-201

Structure / Estructura

Solid steel rod frame powder coated in RAL colours.

Estructura de varilla maciza de acero pintado en polvo con colores RAL.

Collection Models



Mim chair



Mim stool
 H75 / H65

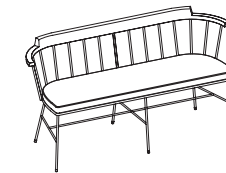

Mim bench



Mim cushion



High Mim table
 H75 / Top: Ø 90 - 100



Medium Mim table
 H65 / Top: Ø 50 - 70



Low Mim table
 H45 / Top: Ø 40 - 50

Glöwr Collection

Designed by Claire Davies

The Glöwr is a warm and welcoming chair. It's a sober, robust and long-lasting piece. Its simple and smooth lines, together with the use of wood, provide domesticity and warmth to restaurant and hotel spaces.

Glöwr es el tipo de silla cálida y acogedora. Es una pieza sobria, robusta y duradera. Sus líneas sencillas y tranquilas, junto al uso de la madera, aportan cierta domesticidad y calidez a los espacios de restauración y hostelería.

Glöwr chair / Ref. 780-02 / Frame and Backrest: solid beech wood dyed White 13 EM
Seat: upholstered Gabriel Tonal 63098
Glöwr table / Ref. 783 - Base: beech solid wood dyed White 13 EM
Top Sob-009: Plywood laminated Infinity Surf F7923 80 x 80 cm. Edge dyed White 13 EM



1. Glöwr chair / Ref. 780 / Frame: solid beech wood dyed White 13 EM
 Backrest: beech veneer dyed White 13 EM / Seat: upholstered Gabriel Crisp 4033
 2. Glöwr table / Ref. 783 / Base: beech solid wood dyed White 13 EM
 Glöwr wooden top code 009 80 x 80 cm / Top: beech plywood dyed Green 63 EM
 3. Glöwr chair / Ref. 780 / Frame: solid beech wood dyed White 13 EM
 Backrest: beech veneer dyed White 13 EM / Seat: upholstered Gabriel Crisp 4761



Glöwr Collection



1. Glöwr stool / Ref. 782-01 / Frame: solid beech wood dyed Green 66 EM
 Seat and backrest: beech veneer dyed Green 66 EM / Seat: upholstered Gabriel Crisp 4761
 2. Glöwr stool / Ref. 782-02 / Frame: solid beech wood dyed White 13 EM / Backrest: beech
 veneer dyed White 13 EM / Seat and front backrest: upholstered Gabriel Crisp 4761



Glöwr Collection



Glöwr lounge / Ref. 781-02 / Frame: solid beech wood dyed Blue 54 EM
Backrest: beech veneer dyed Blue 54 EM / Seat: upholstered Gabriel Crisp 4125

Glöwr lounge / Ref. 781-02 / Frame and Backrest: solid beech wood dyed White 13 EM
Seat: upholstered leather Mariano Ferrugia Babel Siena



Glöwr Collection

Glöwr Collection



Lateral mounting with brass screws. / Fijación lateral con tornillos de latón.

Backrest and seat / Respaldo y asiento

Beech plywood in natural colour or dyed. Optional upholstered seat or seat and backrest set.

Contrachapado de haya, acabado color natural o tinte. Opcional tapizado de asiento o en el conjunto de asiento y respaldo.

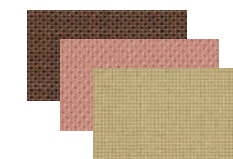

Great selection of fabrics. For more information on finishes, please consult our finishes catalogue.

Gran selección de tejidos. Más información de acabados consultar nuestro catálogo de acabados.

Structure / Estructura

Solid beech wood in natural colour or dyed.

Madera maciza de haya, acabado color natural o tinte.



Colour palette P. 201

Collection Models



Glöwr chair



Glöwr lounge



Glöwr stool

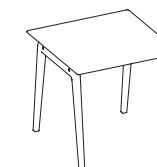

Glöwr table

Atay Collection

Designed by Emiliana Design Studio

The Atay family is a set of side tables and poufs that complement each other in infinitely harmonious combinations bringing sophistication, comfort and colour to waiting areas and meeting spaces. The hexagonal shape characteristic of this collection is a unique look, highlighting the suggestive play of light and shadow on each of the six facets.

Atay es una familia de mesas auxiliares y pufs que permiten infinitas combinaciones entre sí y aportan sofisticación, confort y color a los espacios de espera y reunión. La forma hexagonal confiere a la colección un aspecto singular que queda plasmado por un sugerente juego de luces y sombras en cada una de sus seis caras.



1. **Atay table** / Ref. 384 / Base: metal powder coated RAL 7030 textured / Top Sob-387: oak solid wood Ø 70 cm, varnished natural EM with rounded edge and central recess
2. **Atay pouf** / Ref. 386 / Base: ash veneer in samba wood, natural varnished EM
Seat: upholstered Gabriel Step 61149
3. **Atay pouf** / Ref. 386 / Base: oak veneer in samba wood, natural varnished EM
Seat: upholstered natural leather Mariano Farrugia Babel Miel



Residential Space

Atay pouf / Ref. 386 / Base: ash veneer in samba wood, natural varnished EM
 Seat: upholstered Natural Leather - Mariano Farrugia Babel Siena

- 1. Atay pouf / Ref. 386 / Base: ash veneer in samba wood, natural varnished EM
 Seat: upholstered Gabriel Step 61149
- 2. Atay table / Ref. 384 / Base: metal powder coated RAL 7030 textured / Top Sob-387:
 oak solid wood Ø 70 cm, varnished natural EM with rounded edge and central recess
- 3. Atay pouf / Ref. 386 / Base: oak veneer in samba wood, natural varnished EM
 Seat: upholstered Gabriel Step 68165



The comfortable poufs are available in a wide range of upholstery patterns while the base can be customized in different types of wood, including lacquered or stained finishes to match the tops of the Atay side tables.

Los confortables pufs están disponibles en una amplia gama de tapicerías y su base puede personalizarse en diferentes tipos de madera, también en acabados lacados o teñidos para dialogar así con los sobres de las mesitas.

1. **Atay pouf** / Ref. 386 / Base: samba wood, lacquered RAL 8004 MI
Seat: upholstered Gabriel Step 63075
2. **Atay table** / Ref. 380 / Base: metal powder coated RAL 9004 textured
Top: solid oak wood, natural varnished EM
3. **Atay pouf** / Ref. 386 / Base: oak veneer in samba wood, natural varnished EM
Seat: natural leather Mariano Farrugia Babel Miel
4. **Atay pouf** / Ref. 386 / Base: ash veneer in samba wood, lacquered RAL 9004 EM PO
Seat: upholstered Gabriel Step 60999





1. **Atay pouf** / Ref. 386 / Base: samba wood, lacquered RAL 9004 EM PO
 Seat: upholstered Gabriel Medley 66010
 2. **Atay table** / Ref. 380 / Base: metal powder coated RAL 9004 textured
 Top: solid ash wood, natural varnished EM
 3. **Atay pouf** / Ref. 386 / Base: samba wood, natural varnished EM
 Seat: upholstered Gabriel Medley 66008
 4. **Atay pouf** / Ref. 386 / Base: samba wood, natural varnished EM
 Seat: upholstered Gabriel Medley 62054

1. **Atay table** / Ref. 385 / Base: metal powder coated RAL 5004 matt / Top Sob-387:
 beech solid Ø 55 cm with rounded edge and central recess, stained blue 54 MI
 2. **Atay table** / Ref. 383 / Base: metal powder coated RAL 7044 matt / Top Sob-977:
 MDF veneer and edged Ø 90 cm in beech wood stained grey 74 MI



Atay Collection



Top / Sobre

Hexagonal 10 mm top in solid beech, ash or oak with natural finish, dyed or lacquered.

Hexagonal de 10 mm en madera maciza de haya, fresno o roble acabado natural, tintado o lacado.

Top / Sobre

Different top options with a wide selection of materials and finishes.

Diferentes opciones de sobre con gran selección de materiales y acabados.

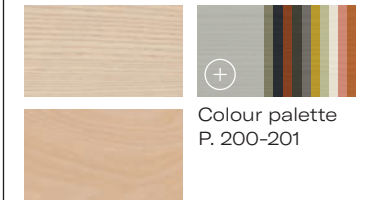

Table Base / Base de Mesa

Metal hexagonal base with or without handles, with levelers, finished in powder coated in RAL colours.

Chapa metálica con o sin asas, con tacos niveladores, acabado pintado en polvo con colores RAL.

Pouf Base / Base de Puf

Natural samba wood or ash veneer finished in natural or lacquered wood.

Madera de samba natural o chapada con fresno acabada en madera natural o lacada.

Upholstery / Tapizado

Great selection of fabrics. For more information on finishes, please consult our finishes catalogue.

Gran selección de tejidos. Más información de acabados consultar nuestro catálogo de acabados.

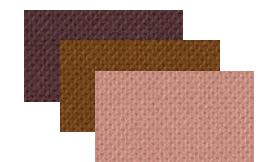

Collection Models



Atay pouf



Atay Hex table
H35 / H45 / H60



Atay round table
H36 / H46 / H61

Sandwich Collection

Designed by Untaller Studio

Sandwich is a collection of tables of great versatility destined to the world of restaurant spaces and coffee shops. Sandwich is a robust and sober table where its “double” column gives a distinctive character.

Sandwich es una colección de mesas de gran polivalencia destinada al mundo de la restauración y cafeterías. Sandwich es una mesa robusta y sobria, en la que su “doble” columna le confiere un carácter distintivo.

1. **Sandwich table** / Ref. 354-01 / Base and column: powder coated RAL 9003 matt
Top: dekton Kairos Ø 60cm
2. **Sandwich table** / Ref. 351-01 / Base and column: powder coated RAL 9004 textured
Top: silestone Charcoal soapstone 70x70cm
3. **Sandwich table** / Ref. 357-01 / Base and column: powder coated RAL 9003 textured
Top: Dekton Sogne 110x70cm



1. **Sandwich table** / Ref. 356-01 / Base and column: powder coated RAL 9003 matt
Top SOB-977: natural ash veneer EM Ø 90 cm
2. **Cistell chair** Ref. 790-03 / Upholstered gabriel select 64213 / Backrest: natural ash EM
Legs: steel tube finished powder coated RAL 7030 textured



Sandwich Collection



1. **Sandwich table** /Ref. 354-01 / Base and column: powder coated RAL 9003 matt
Top: color core Compact Polar White AN Infinity Ø 60 cm
2. **Sandwich table** /Ref. 351-01 / Base and column: powder coated RAL 7044 matt
Top: Formica Infinity Polar with the corner lacquered ash RAL 7044 PO EM 70x70 cm



Sandwich table / Ref. 359-01 / Column: Dekton Fossil / Base: powder coated RAL 9004 textured
 Top Sob-051: Dekton Fossil Ø 140 cm
Cistell chair / Ref. 792-09 / Seat and backrest: upholstered Gabriel Select 60051
 Legs: steel tube finished powder coated RAL 9004 textured

Sandwich table / Ref. 359-01 / Column: natural ash EM 60 / Base: powder coated RAL 9004 matt
 Top SOB-977: natural ash EM Ø 140 cm
Cistell chair / Ref. 790-03 / Backrest: lacquered ash RAL 9004 PO EM / Seat: upholstered Gabriel
 Select 60051 / Legs: steel tube finished powder coated RAL 9004 textured



Sandwich Collection



Sandwich table / Ref. 359-01 / Column: Dekton Fossil / Base: powder coated RAL 9004 textured
 Top SOB-977: Ash lacquered RAL9004 PO Ø 160 cm
Cistell chair / Ref. 792-09 / Seat and backrest: upholstered Gabriel Select 60051
 Legs: steel tube finished powder coated RAL 9004 textured

Sandwich Collection

Top / Sobre

Wide range of tabletops with different dimensions and finishes.

Gran variedad de sobres de mesa con diferentes dimensiones y acabados.



Base

The square or circular base with powder coated RAL colours steel metallic columns.

La base cuadrada o circular con columnas metálicas en acero pintado en polvo con colores RAL.

Column / Columna

Metallic steel column powder coated in RAL colours . Optional veneer finish on the column.

Columna metálica en acero pintado en polvo con colores RAL. Opcional revestir la columna con madera de haya, fresno o roble, acabado natural, tintado o lacado.

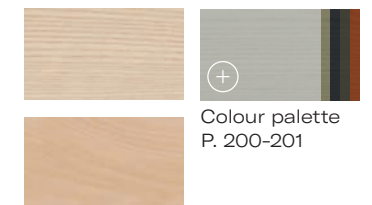

Collection Models

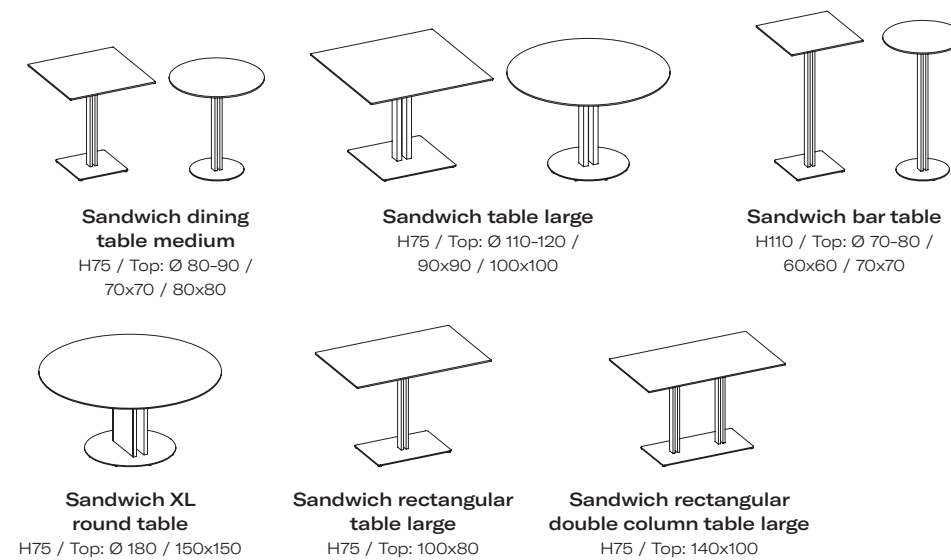

Dula Collection

Designed by Yago Sarri

Dula collection is a versatile system of modular seats, to furnish rest and waiting areas in halls, offices, hotels, etc. Dula seats are comfortable thanks to their large size and simple shapes which can be used to create multiple setups to adapt to the needs of each project.

La colección Dula es un sistema versátil de asientos modulares, para equipar espacios de descanso y espera en halls, oficinas, hoteles. Se caracteriza por su confort, por sus dimensiones generosas y por unas formas sobrias que permiten crear múltiples configuraciones para adaptarse a las necesidades de cada proyecto.





1. **Dula armchair with upholstered armrests** / Ref. 341-01 / Upholstered: Gabriel Fame 68004 / Legs: powder coated RAL 1027 satin
 2. **Dula cushion** / Ref. 348-02 / Upholstered: Gabriel fame 60005
 3. **Dula table** / Ref. 338-03 / Legs: powder coated RAL 7030 textured / Top Sob-051: Dekton Olimpo Ø 110 cm



1. **Dula double seat with wooden armrests** / Ref. 342-02 / Seat and backrest: upholstered Gabriel harmony 2102 / Armrest: Natural Oak EM / Legs: powder coated RAL 7030 textured
 2. **Dula seat with wooden armrests** / Ref. 340-02 / Seat and backrest: upholstered Gabriel harmony 2102 / Armrest: Natural Oak EM / Legs: powder coated RAL 7030 textured
 3. **Dula table** Ref. 338-03 / Legs: powder coated RAL 7030 textured / Top Sob-337: natural ash EM Ø 110 cm



1. **Dula pouf** / Ref. 346-01 / Upholstered: Gabriel Harmony 3102
Legs: powder coated RAL 9003 matt
2. **Dula individual seater** / Ref. 340-01 / Upholstered: Gabriel
Harmony 3102 / Legs: powder coated RAL 9003 matt
3. **Dula table** / Ref. 338-01 / Legs: powder coated RAL 9003 matt
Top Sob-028: MDF RAL 9003 matt 72 x 72 cm



1. **Dula individual seater** / Ref. 340-01 / Upholstered: Gabriel Harmony 3102
Legs: powder coated RAL 9033 matt
2. **Dula table** / Ref. 338-01 / Legs: powder coated RAL 9003 matt
Top Sob-028: MDF RAL 9003 matt 72 x 72 cm
3. **Dula cushion** / Ref. 348-01 / Upholstered: Gabriel Hamony 1101



Dula Collection System



- 1. **Dula individual seater** / Ref. 340-01 / Upholstered: Gabriel Harmony 3102
Legs: powder coated RAL 9033 matt
- 2. **Dula cushion** / Ref. 348-01 / Upholstered: Gabriel Harmony 1101
- 3. **Dula table** / Ref. 338-01 / Legs: powder coated RAL 9003 matt
Top Sob-028: MDF RAL 9003 matt 72 x 72 cm
- 4. **Dula corner connector module** / Ref. 344-01/ Upholstered: Gabriel
Harmony 3102 / Legs: powder coated RAL 9033 matt

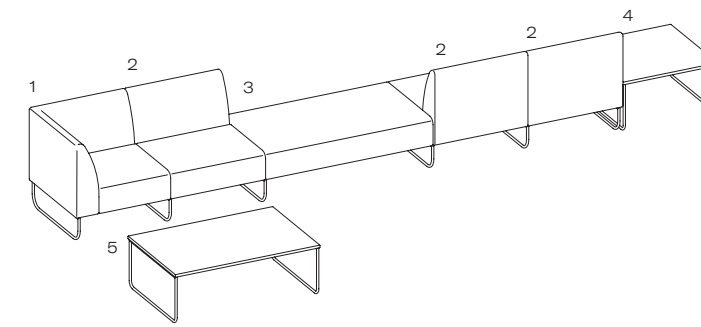

Linear system

System modules that make up the configuration.
Connector system between the modules with shared legs.

- 1. Ref. 345-01 Dula Final Left Module
- 2. Ref. 340-01 Dula Seat
- 3. Ref. 347-01 Dula Double Pouf
- 4. Ref. 338-01 Dula Square Table
- 5. Ref. 338-02 Dula Rectangular Table

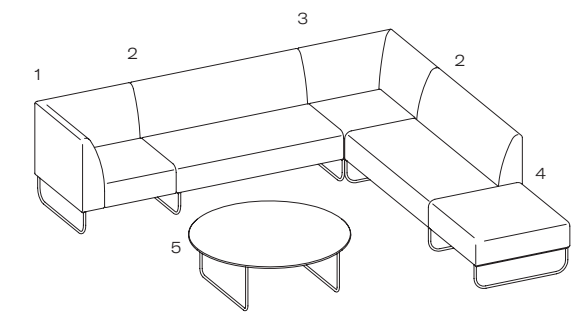

Corner L configuration

System modules that make up the configuration.
Connector system between the modules with shared legs.

- 1. Ref. 345-01 Dula Final Left Module
- 2. Ref. 342-01 Dula Double Seater
- 3. Ref. 344-01 Dula Corner Connector Module
- 4. Ref. 346-01 Dula Individual Pouf
- 5. Ref. 338-03 Dula Round Table

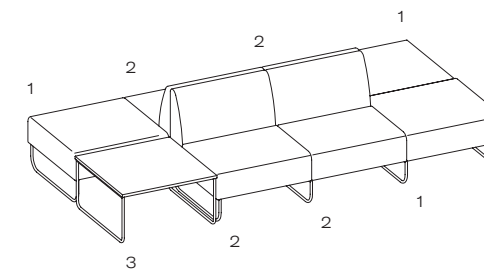

Central configuration back to back

System modules that make up the configuration.
Connector system between the modules with shared legs.

- 1. Ref. 346-01 Dula individual pouf
- 2. Ref. 340-01 Dula seat
- 3. Ref. 338-01 Dula square table

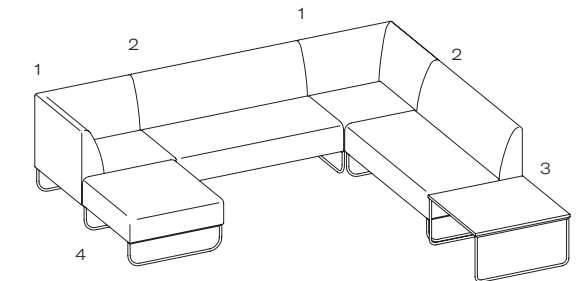

U configuration

System modules that make up the configuration.
Connector system between the modules with shared legs.

- 1. Ref. 344-01 Dula corner connector module
- 2. Ref. 342-01 Dula double seater
- 3. Ref. 338-01 Dula square table
- 4. Ref. 346-01 Dula individual pouf

Connection between modules

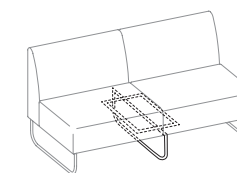

Ref. 339-01
Independent modules
connected by a shared leg.

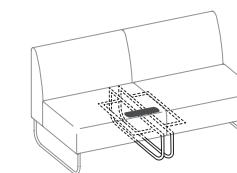

Independent modules
connected by a joining piece.

Dula Collection

Backrest and seat / Respaldo y asiento

Interior plywood frame with elastic webbing, foam and upholstered.

Estructura interior en madera contrachapada, cinchas elásticas, espuma y tapizada.

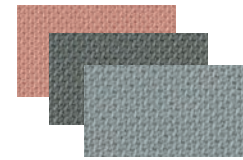

Great selection of fabrics. For more information on finishes, please consult our finishes catalogue.

Gran selección de tejidos. Más información de acabados consultar nuestro catálogo de acabados.



Structure / Estructura

Steel tube base powder painted with RAL colours.

Diferentes versiones de patas de madera, metálicas o de patín.

Armrests options / Opciones de brazos



Dula Collection



Dula individual seater

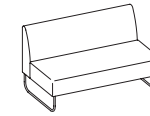

Dula double seater

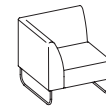

Dula final individual left module

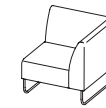

Dula final individual right module

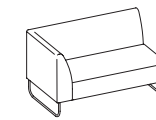

Dula final double seater left module



Dula final double seater right module



Dula corner connector module



Dula final individual left module with wooden armrests

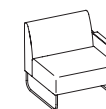

Dula final individual right module with wooden armrests

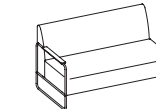

Dula final double left module with wooden armrests

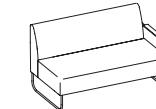

Dula final double right module with wooden armrests

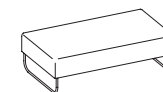

Dula double pouf

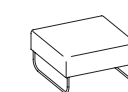

Dula individual pouf



Dula cushion

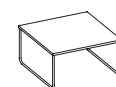

Dula square table

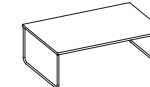

Dula rectangular table



Dula round table

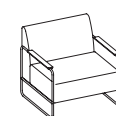

Dula seat with wooden armrests

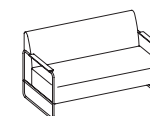

Dula double seat with wooden armrests

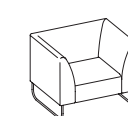

Dula armchair with upholstered armrests

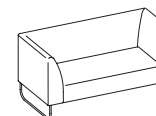

Dula double seat with upholstered armrests

General Finishes

The colours and finishes referenced in this catalogue may vary. For more precise compatibility, check our general collection of material and finish samples. All paint and lacquers are from the RAL portfolio. All our products may be customized to any hotel & restaurant project or community according to the requirements of each client and the relevant specifications.

Los colores y acabados referenciados en este catálogo pueden variar respecto a la realidad. Para una equivalencia más precisa consultar el muestrario general de materiales y acabados. Todos los colores de pinturas y lacas corresponden a la carta RAL. Todos nuestros productos se pueden personalizar a la medida de cada proyecto, de hostelería y colectividades, según los requerimientos de cada cliente y preescriptor.

Wooden Finishes / Acabados madera

Natural varnished wood /
Madera natural embarnizada



Ash / Fresno



Oak / Roble

Lacquered ash & oak wood /
Fresno y roble lacado



RAL
1013 PO



RAL
9003 PO



RAL
7044 PO



RAL
7030 PO



RAL
7039 PO



RAL
8000 PO



RAL
1027 PO



RAL
5004 PO



RAL
8023 PO

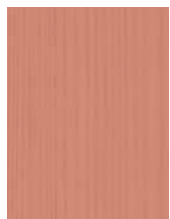

RAL
3012 PO



RAL
3016 PO



RAL
3011 PO



RAL
1000 PO



RAL
6013 PO



RAL
6006 PO

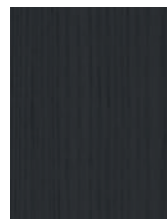

RAL
9004 PO

NEW



RAL
8004 PO



RAL
5020 PO

Varnish Finishes and Laquered RAL Finishes (Open Pore)
EM extra matt / AN satin

Wooden Finishes / Acabados madera

Natural varnished wood /
Madera natural embarnizada



Beech / Haya

Dye beech wood /
Haya tintada



White 13



White 93

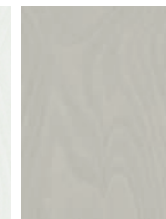

Grey 74

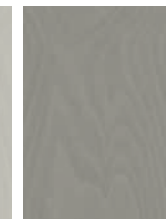

Grey 70



Grey 79



Brown 80



Yellow 17



Blue 54



Orange 83



Pink 32



Red 36



Red 31



Salvia 10



Green 63



Green 66

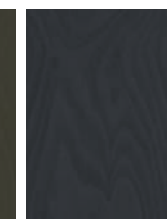

Black 94

Varnish Finishes
MI matt / AN satin

Hand-woven Finishes / Acabados de trenzado a mano

Hand-woven with paper cord /
Trenzado a mano con cuerda
de papel

Cord Colours

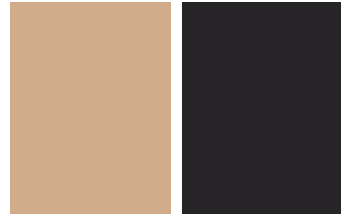

Natural

Black

Types of woven / Tipos de trenzado



Double Weave /
Dos pasadas



Quadruple Weave /
Cuatro pasadas

Webbing Finishes / Acabados de encintado

Webbing with paper tape /
Encintado con cinta de papel

Application



Colours

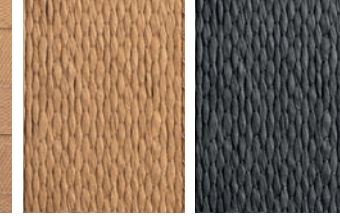

Natural

Black

Webbing with full grain leather /
Encintado con piel natural

Application



Colours

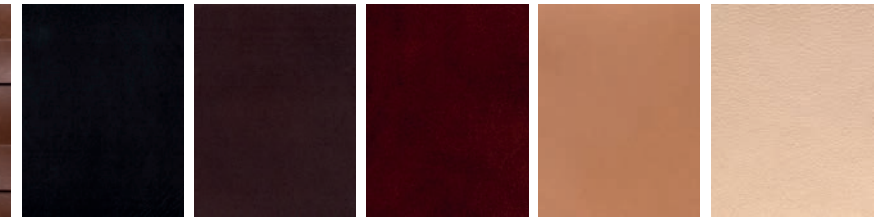

Black

Brown

Cognac

Caramel

Natural

Webbing with recycled leather /
Encintado con piel reciclada

Application

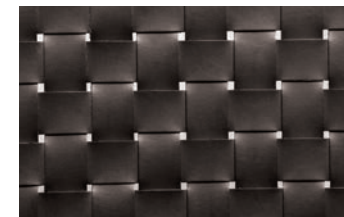

Colours

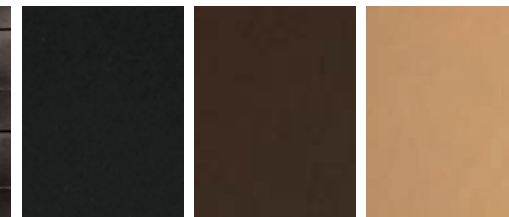

Black

Brown

Cowhide

Webbing with acrylic tape /
Encintado con cinta acrílica

Application

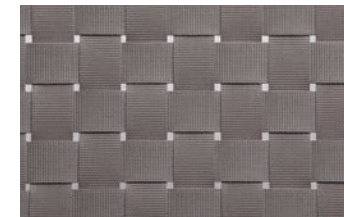

Colours

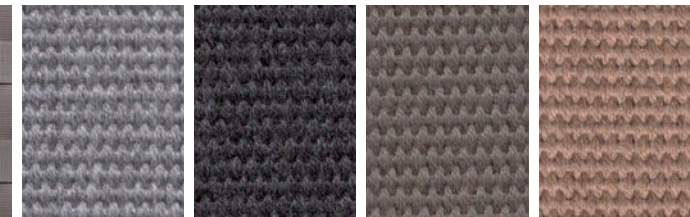

Stone

Graphite

Mineral

Integral

Natural Fiber Mesh Finishes / Acabados de rejilla

Paper fiber mesh /
Rejilla de papel

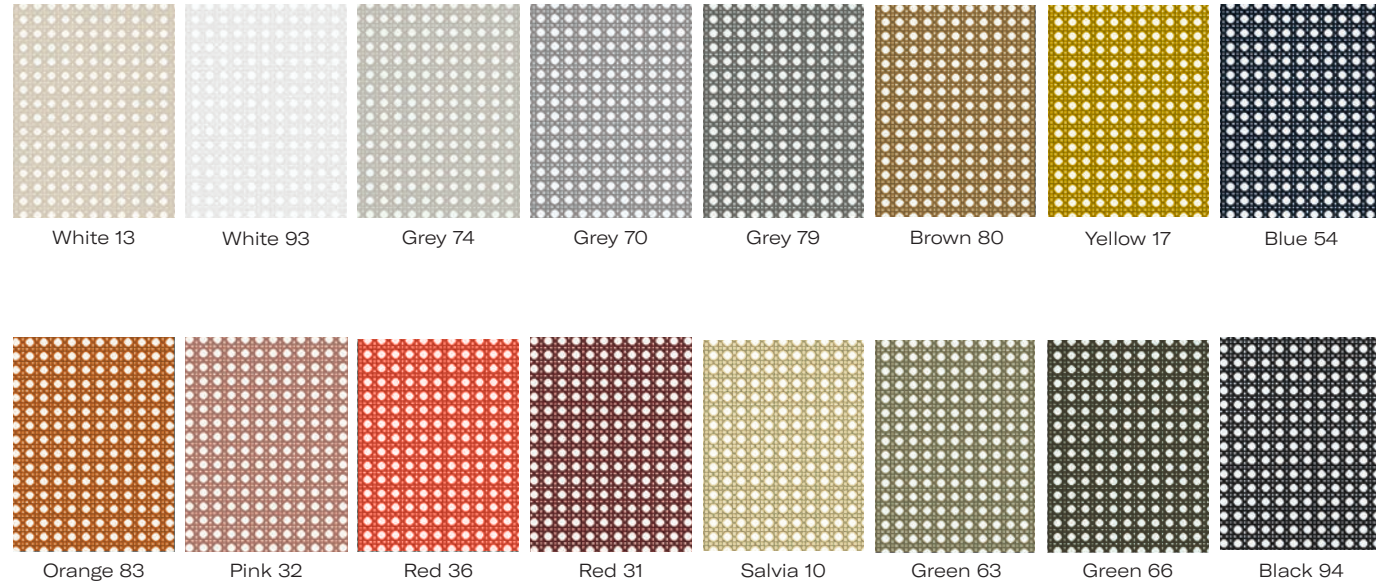

The same colour finish is applied to the fiber mesh as to the chair structure. / Se aplica el mismo acabado de color a la rejilla que a la estructura de la silla.

Product Information

Upholstery Finishes / Acabados de tapizado



Fabric. **Gabriel**
Tonal, Medley, Cura, Cyber, Go Check, Step, Step Melange, Swing, Grain, Crisp, Harmony

Vegan Leather. **Spradling**
Valencia, Dolce

Natural Leather. **Mariano Farrugia**
Babel

Our furniture is designed and manufactured to fit the most demanding contract spaces. For this reason, functionality and durability are essential values in our collections. We want our chairs to last in time, both aesthetically and functionally.

Nuestro mobiliario está diseñado y fabricado para equipar los espacios contract más exigentes. Por esta razón la funcionalidad y la robustez son valores indispensables en nuestras colecciones. Queremos que nuestras sillas perduren en el tiempo tanto estética como funcionalmente.



PQ Residencia (Vaqueira)
Interior design: Trenchs Studio
Photo: David Vilanova



Aliança Restaurant (Anglès, Girona)
Photo: Meritxell Arjalaguer



Ca l'Enric Restaurant (La Vall de Bianya, Girona)
Interior design: Jordi Vayreda
Photo: Francesc Rabat



Courtyard by Marriot (Paris Porte Versailles)
Interior design: Doris Zimmermann
Photo: Francesc Rabat



MACBA Café (Barcelona)
Interior design: Llamazares Pomés Arquitectes
Photo: Enrique Muda



ICON Embassy (Madrid)
Interior design: Sandra Tarruella, Ricard Trenchs
Photo: Meritxell Arjalaguer



Lobito de Mar (Madrid)
Interior design: Astet Studio
Photo: Salva Lopez



Divinum Restaurant (Girona)
Interior design: Lara Pujol
Photo: Merce Gost



Novotel Hotel (Nice)
Photo: Francesc Rabat



KAO Soldeu Restaurant (Andorra)
Interior design: Estudio Pilar Libano
Photo: Meritxell Arjalaguer



Ibis Hotel (Sevilla)
Interior design: Catherine Montfort, Maison Malapert / Photo: Nicolás Anetson

Creative & Art Direction
Emiliana Design Studio

Set Design
Emiliana Design Studio

Product photography
Francesc Rabat

Thanks to:
nanimarquina, Vibia, Bover,
Ceràmica Ferrés

Photography Credits:

Landscape,

Photo: Esteve Serra
p.2-3 / p.200-201

House 1413, Girona
Architecture: Harquitectes
Photo: Meritxell Arjalaguer
p.15-18 / p.37 / p.100

Pin8 House, Girona
Architecture: PMMT Arquitectura,
Photo: Meritxell Arjalaguer
p.41 / p.45 / p.49 / p.72-73 / p.76 /
p.87 / p.105 / p.170

Ca l'Enric Restaurant,
La Vall de Bianya, La Garrotxa
Interior design: Jordi Vayreda
Photo: Francesc Rabat
p.68

Ca la Maria - Nits de Bosc,
Barcelona
Photos: Francesc Rabat
p.101

GSE Group Canteen, Avignon
Photos: Francesc Rabat
p.120 / p.135

Divinum Restaurant, Girona
Interior design: Lara Pujol
Photo: Mercè Gost
p.122

Praktik Coliving, Barcelona
Interior design: Laura Muñoz,
Nora Batlle Belonging Interiors,
DDA Arquitectura,
Photo: Meritxell Arjalaguer
p.142

Casa Seat, Barcelona
Interior design: Lázaro-Rosa Violán
Photos: Eva Guillaumet /
Francesc Rabat
p.146-148

H10 Casa Mimosa, Barcelona
Photo: Francesc Rabat
p.156

Grupo Saona, Madrid
Interior design: Sandra Tarruella,
Ricard Trenchs
Photos: Meritxell Arjalaguer
p.157

Gabriel - Crisscross Instalation,
Barcelona
Design: Emiliana design studio
Photo: Meritxell Arjalaguer
p.174

Ctra. Brunells, s/n
17853 Tortellà, Girona
T. +34 972 287 277

info@verges.design
www.verges.design

