





MADE FOR **SHADE**  
& **OUTDOOR LIVING.**



tilt in height  
inclinable en hauteur  
kantelen in de hoogte



tilt left - right  
inclinable à gauche et à droite  
kantelen naar links en rechts



360° rotation  
rotation de 360°  
360° rotatie



knock down  
à assembler  
te monteren



modular  
modulaire  
modulair



adjustable feet  
pieds réglables  
verstelbare poten



aluminium connector  
connecteur en aluminium



stackable  
empilable  
stapelbaar



foldable  
pliable  
plooibaar



**Fast stock**  
uit voorraad leverbaar  
disponibles sur stock  
available on stock

## OUTDOOR SHADE

### CARACTÈRE

	<b>JCP.1 SERIES</b>	JCP.102 - 230 x 230 cm	10
UPDATED	<b>JCP.2 SERIES</b>	JCP.201 - 400 x 400 cm JCP.202 - 500 x 500 cm JCP.203 - ø 450 cm	11 12 13
UPDATED	<b>JCP.3 SERIES</b>	JCP.301 - 300 x 300 cm JCP.302 - 260 x 260 cm JCP.303 - ø 350 cm	14 15 16
UPDATED	<b>JCP.4 SERIES</b>	JCP.401 - 370 x 370 cm JCP.402 - 425 x 300 cm JCP.403 - ø 400 cm JCP.404 - 250 x 350 cm	17 18 19 20
	<b>JCP.5 SERIES</b>	JCP.501 - 4 * 300 x 300 cm	22
	<b>JCP.6 SERIES</b>	JCP.601 - 2 * 300 x 300 cm	23

### ATTITUDE

UPDATED	<b>AZORE</b>	300 x 300 cm	27
UPDATED	<b>ANTEGO</b>	300 x 200 cm 300 x 300 cm ø 350 cm	28
	<b>KINGSTON</b>	400 x 300 cm 400 x 400 cm	30
NEW	<b>LIMA</b>	400 x 400 cm	31
UPDATED	<b>AMALFI</b>	250 x 250 cm 300 x 300 cm ø 300 cm	32
	<b>MALIBU</b>	210 x 150 cm 200 x 200 cm 250 x 200 cm 240 x 240 cm ø 250 cm ø 300 cm	34
	<b>CUBA</b>	300 x 300 cm ø 350 cm	36
	<b>MOOREA</b>	300 x 300 cm	37
	<b>MORE - PLUS - MEER</b>	bases - parasolvoeten Attitude Luna LED umbrella light	38 97

# OUTDOOR LIVING

## FURNITURE & DECORATION

NEW	<b>NOA</b>	Dining	42	UPDATED	<b>KUDOS</b>	Bistro	82
		Lounge	44				
		Relax	46				
NEW	<b>NERO</b>	Dining	48		<b>MANTRA</b>	Bistro	83
		Lounge	49				
		Relax	50				
UPDATED	<b>TUGU</b>	Dining	52		<b>BYBLOS</b>	Beach chair	85
		Lounge	53				
		Relax	55				
	<b>LEGNA</b>	Dining	56	<b>NESTING TABLES</b>	Side tables	86	
		Lounge	58		Duncan teak block	87	
UPDATED	<b>SCOOP</b>	Lounge	60	NEW	<b>BOLSA</b>	Bean bag	88
		Relax	61				
	<b>MAUROO</b>	Lounge modular	62	<b>DECORATION</b>	Pottery - Pots - Potten	NEW	90
		Concept	65		Lighting - Éclairage - Verlichting	92	
					Rugs - Tapis - Tapijten	93	
	<b>TECCA</b>	Dining	66	Poufs - Poefs	94		
		Relax	68	Deco cushions	95		
				Coussins de décoration			
UPDATED	<b>NATURE</b>	Dining	70	Decokussens			
		Low dining	71				
	<b>FLEXX</b>	Dining	72	Protection & maintenance	96		
		Lounge	75	Entretien & maintenance			
		Relax	77	Onderhoud & bescherming			
	<b>VOLTE</b>	Dining	78	Accessories - Accessoires	97		
		Lounge	80	Materials - Matériaux - Materialen	98		
				Fabrics - Tissus - Stoffen	100		
				Wind scale - Échelle du vent - Windschaal	102		
				Seating capacity per table	104		
				Nombre de sièges par table			
				Aantal zitplaatsen per tafel			

This price list includes recommended retail prices in EURO and replaces all previous versions.  
Valid from 01.10.2022.

## PAYMENT CONDITIONS

Available at [www.jardinico.com](http://www.jardinico.com) or contact our team for more information.

## AFTER-SALES SERVICE

Please address all complaints and questions about the after-sales service to [service@jardinico.com](mailto:service@jardinico.com).  
Please explain the problem and include as many photos as possible to prove it.  
Our team will contact you as soon as possible and help you further.

## WARRANTY

We provide, barring different agreement of more or less, a maximum warranty of 2 years on our products. The warranty takes effect on the day that the product is purchased from an official commercial partner of Jardinico® Parasols (date of invoicing). The warranty applies to production and/or materials errors, caused by normal use. The product shall not be replaced in its entirety if a defective part and/or component can be replaced. Jardinico® Parasols shall by no means be held to provide a warranty if the defects are the result of improper or incorrect use by the final user. Please consult the general terms and conditions on our website to learn more about the exceptions to the warranty.

The representation of colours, dimensions and weights may differ from reality, as may variations when a product is handmade. Prices, dimensions and technical details are subject to change without notice. Jardinico is not responsible for any printing and/or typing errors. Our general sales conditions always apply - see website.  
Jardinico® Parasols BV. All rights reserved.

## PRODUCT REFERENCES

Use our simplified, easy-to-use product references to place your order. Please include the correct codes for each order so that we can provide the best service and reduce the risk of errors.

- Product category (1): UF = umbrella frame, UC = umbrella canopy, UB = umbrella base, ...
- Product or product range (2): JCP.101, JCP.1S, ANT = Antego, KIN = Kingston, AMA = Amalfi, ...
- The product already implies the dimensions of the parasol for the Caractère collection.  
For the Attitude umbrella collection, the size needs to be mentioned (3): 300X300, 200X300, 350XR, ...
- Finishing and/or colour (4): A01 = aluminium white, C001 = canopy natural, S01 = steel white, ...

UFJCP.301-A01



UFANT300X300-A01



UCANT300X300-C001



- Catégorie de produit (1): FU = furniture, CU = cushion, DE = decoration, ...
- Collection (2): TUG = tugu, LEG = legna, SCO = scoop, ...
- Product (3): AC = armchair, 1S = sofa 1S, SL = sunlounger, ...
- Finition et/ou couleur (4): A01 = aluminium white, C008 = cushion linen, W62 = teak, ...

FUTUGAC05-F16

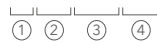

CUTUGAC05-C008

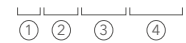

Ce tarif contient des prix de vente recommandés en EURO et remplace toutes les versions précédentes.  
Valable à la partir du 01.10.2022.

## CONDITIONS DE PAIEMENT

Disponible sur [www.jardinico.com](http://www.jardinico.com) ou contactez notre équipe pour plus d'informations.

## SERVICE APRÈS-VENTE

Veillez adresser toute réclamation et demande de service après-vente à [service@jardinico.com](mailto:service@jardinico.com).  
Veillez expliquer le problème et inclure autant de photos que possible pour le démontrer.  
Notre équipe vous assistera dans les plus brefs délais.

## GARANTIE

Nous accordons, sauf autre accord contraire supérieur ou inférieur, maximum 2 ans de garantie sur nos produits. La garantie prend effet le jour où le produit est acheté auprès d'un partenaire officiel de Jardinico® Parasols (date de facturation).  
Le garantie s'applique aux défauts de production et/ou aux défauts de matériau engendrés par un usage normal. Le produit ne sera pas entièrement remplacé si la pièce et/ou le composant défectueux peut être remplacé. Jardinico® Parasols n'offre dans aucun cas une garantie lorsque les défauts sont la conséquence d'un usage impropre ou abusif par l'utilisateur final.  
Veillez consulter les conditions générales sur notre site web pour en savoir plus sur les exceptions à la garantie.

La reproduction des couleurs, les mesures et les poids peuvent différer de la réalité ainsi que des variations chaque fois qu'un produit est fait à la main. Les prix, dimensions et détails techniques peuvent être sujets à changement sans préavis.  
Jardinico n'est pas responsable des erreurs d'impression et/ou de frappe. Nos conditions générales de vente sont toujours applicables - voir notre site web. Jardinico® Parasols BV. Tous les droits sont réservés.

## RÉFÉRENCES DE PRODUITS

Utilisez nos références de produits simplifiées et faciles à utiliser pour passer votre commande. Veuillez inclure les codes corrects avec chaque commande afin que nous puissions fournir le meilleur service et limiter les risques d'erreur.

- Catégorie de produit (1): UF = umbrella frame, UC = umbrella canopy, UB = umbrella base, ...
- Série de produits ou de produits (2): JCP.101, JCP.1S, ANT = Antego, KIN = Kingston, AMA = Amalfi, ...
- Le produit implique déjà les dimensions du parasol d'extérieur pour la collection Caractère.
- Pour la collection Attitude, il faut mentionner la taille (3) : 300X300, 200X300, 350XR, ...
- Finition et/ou couleur (4): A01 = aluminium white, C001 = canopy natural, S01 = steel white, ...

UFJCP.301-A01



UFANT300X300-A01



UCANT300X300-C001



- Catégorie de produit (1): FU = furniture, CU = cushion, DE = decoration, ...
- Collection (2): TUG = tugu, LEG = legna, SCO = scoop, ...
- Product (3): AC = armchair, 1S = sofa 1S, SL = sunlounger, ...
- Finition et/ou couleur (4): A01 = aluminium white, C008 = cushion linen, W62 = teak, ...

FUTUGAC05-F16



CUTUGAC05-C008



Deze prijslijst bevat aanbevolen verkoopprijzen in EURO, en vervangt alle eerdere versies.  
Geldig vanaf 01.10.2022.

## BETALINGSVOORWAARDEN

Beschikbaar op [www.jardinico.com](http://www.jardinico.com) of neem contact op met ons team voor meer informatie.

## DIENST NA VERKOOP

Gelieve alle klachten en vragen over de dienst na verkoop te richten aan [service@jardinico.com](mailto:service@jardinico.com).  
Leg het probleem uit en voeg zoveel mogelijk foto's toe om het probleem aan te tonen.  
Ons team zal zo spoedig mogelijk contact opnemen en verder helpen.

## GARANTIE

Wij verlenen, behoudens andersluidende overeenkomst in meer of in min, maximaal 2 jaar garantie op onze producten.  
De garantie start op de dag dat het product door een officiële handelspartner van JARDINICO Parasols is aangekocht (facturatedatum). De garantie is van toepassing op productie- en/of materiaalfouten, veroorzaakt ten gevolge van een normaal gebruik. Het product zal niet geheel vervangen worden als een defect onderdeel en/of component vervangen kan worden. JARDINICO Parasols zal geenszins tot garantie gehouden zijn wanneer de gebreken het gevolg zijn van een oneigenlijk of verkeerd gebruik door de eindgebruiker. Raadpleeg de algemene voorwaarden op onze website voor meer informatie over de uitzonderingen op de garantie.

De weergave van kleuren, afmetingen en gewichten kan afwijken van de werkelijkheid, evenals variaties wanneer een product handgemaakt is. Prijzen, afmetingen en technische details kunnen zonder voorafgaande kennisgeving worden gewijzigd. Jardinico is niet verantwoordelijk voor eventuele druk- en/of typfouten. Onze algemene verkoopvoorwaarden zijn altijd van toepassing - zie website. Jardinico® Parasols BV. Alle rechten voorbehouden

## PRODUCTREFERENTIES

Gebruik onze vereenvoudigde, gebruiksvriendelijke productreferenties om uw bestelling te plaatsen. Gelieve bij elke bestelling de juiste codes te vermelden zodat wij de beste service kunnen bieden en de kans op fouten beperken.

- Product categorie (1): UF = umbrella frame, UC = umbrella canopy, UB = umbrella base, ...
- Product of product series (2): JCP.101, JCP.1S, ANT = Antego, KIN = Kingston, AMA = Amalfi, ...
- Het product impliceert reeds de afmetingen van de parasol voor de Caractère collectie.  
Voor de Attitude parasol collectie dient de afmeting vermeld te worden (3): 300X300, 200X300, 350XR, ...
- Afwerking en/of kleur (4): A01 = aluminium white, C001 = canopy natural, S01 = steel white, ...

**UFJCP.301-A01**  
① ② ④

**UFANT300X300-A01**  
① ② ③ ④

**UCANT300X300-C001**  
① ② ③ ④

- Product categorie (1): FU = furniture, CU = cushion, DE = decoration, ...
- Collectie (2): TUG = tugu, LEG = legna, SCO = scoop, ...
- Product (3): AC = armchair, 1S = sofa 1S, SL = sunlounger, ...
- Afwerking en/of kleur (4): A01 = aluminium white, C008 = cushion linen, W62 = teak, ...

**FUTUGAC05-F16**  
① ② ③ ④

**CUTUGAC05-C008**  
① ② ③ ④





**OUTDOOR SHADE**  
CARACTÈRE COLLECTION

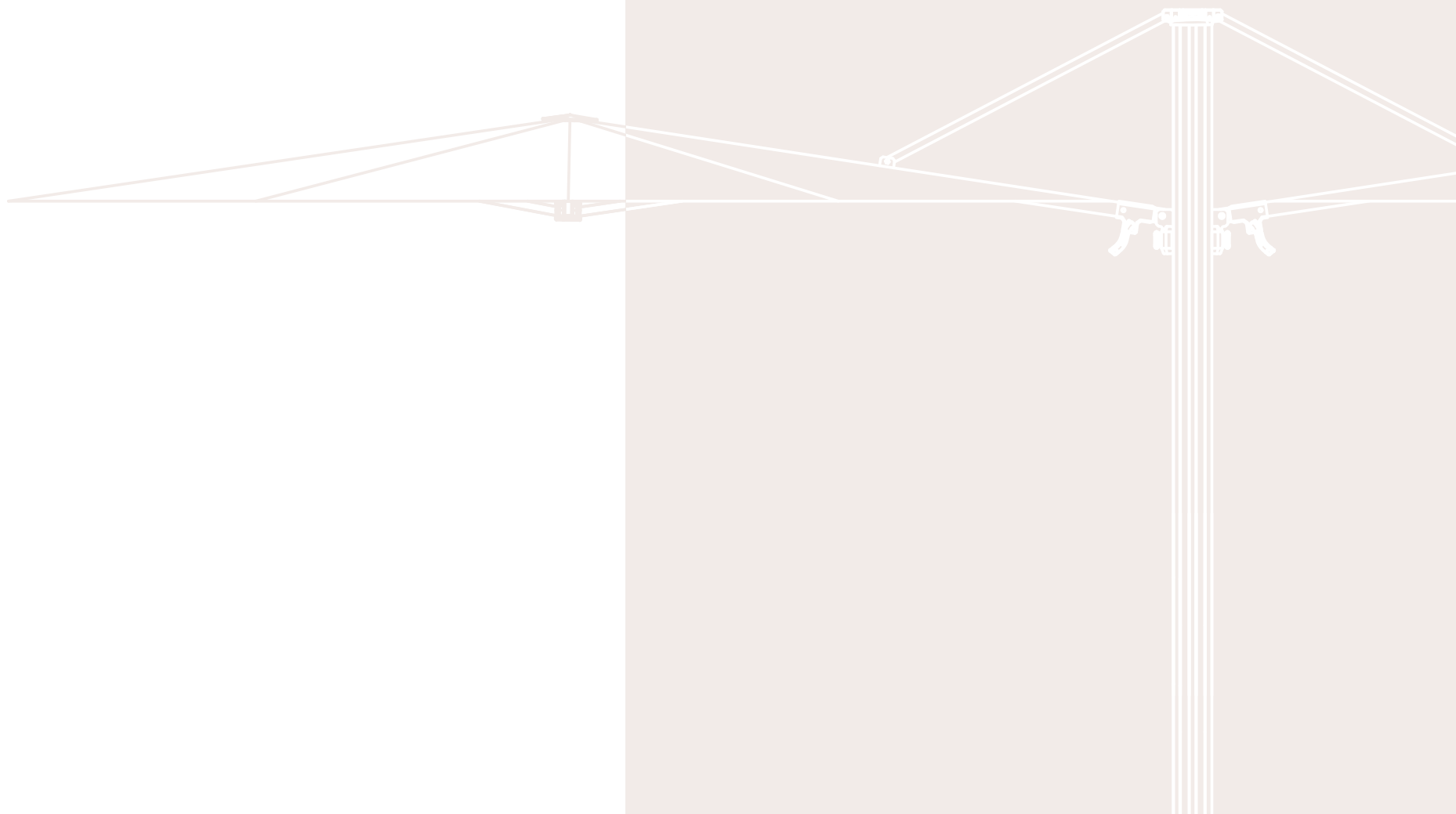

# JCP.1 SERIES

Center pole frame, powder coated aluminium.  
Mât central, aluminium thermolaqué.  
Middenstam parasol, gepoederlakt aluminium.

Canopy 100% solution dyed acrylic, 320 gr/m<sup>2</sup>.  
Toile 100% acrylique teintée en masse, 320 gr/m<sup>2</sup>.  
Doek 100% in de massa gekleurde acryl, 320 gr/m<sup>2</sup>.

Tilt and rotation not applicable.  
Inclinaison non applicable.  
Kantelen en roteren niet van toepassing.

max. 43 km/h, 26.7 mph

## JCP.102 - 230 X 230 CM

### UMJCP.102 FRAME & CANOPY - STRUCTURE & TOILE - FRAME & DOEK

			Base - Voet 44 kg	Base - Voet 65 kg	IGB OGB
FIXED COMBO		A01C101 white & cloud	€ 1.795	€ 2.095	€ 1.295
		A12C001 alu teak & natural			
		A31C101 charcoal & cloud			
		A31C204 charcoal & night			
		A32C208 black & black			

### UFJCP.102 FRAME - STRUCTURE

				Base - Voet 44 kg	Base - Voet 65 kg	IGB OGB	
MIX & MATCH		A01 white		A02 silver	€ 2.295	€ 2.595	€ 1.795
		A03 linen NEW		A12 alu teak			
		A31 charcoal		A32 black			
	UCJCP.102 CANOPY - TOILE - DOEK						
		C003 pearl		C011 cotton			
		C100 ice		C107 mooncrest			
		C207 onyx		C210 pitch			
		C305 umber					
	Free pick: other fabrics on demand - autres tissus sur demande - andere stoffen op aanvraag						

### UBJCP.1S BASE - PARASOLVOET 44 kg

	S01 white		S02 silver	incl.	/	/
	S03 linen NEW		S31 charcoal			
	S32 black					

UBJCP.1S65 BASE - PARASOLVOET 65 kg (same colours as base 44kg)	/	incl.	/
---	---	-------	---

UBIGB-JCP.1S in ground base - ancre de sol - grondanker OR/OU/OF	/	/	incl.
UBOGB-JCP.1S on ground base - plaque de fixation - bevestigingsplaat	/	/	incl.

### COVER - HOUSSE - HOES

	UPJCP.1S-X77 black	incl.	incl.	incl.
--	--------------------	-------	-------	-------

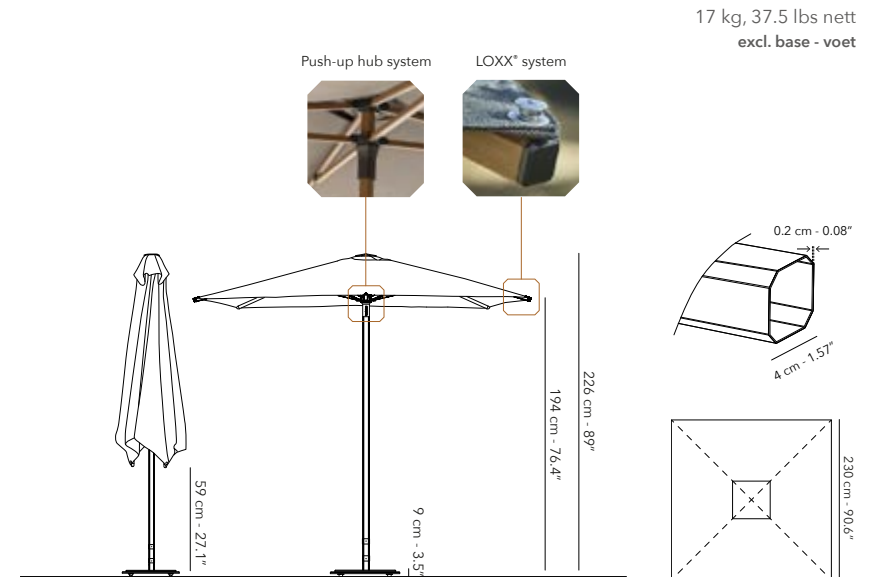

All dimensions exclude the base. - Toutes les dimensions excluent la base. - Alle afmetingen zijn exclusief de parasolvoet.

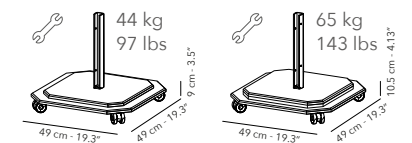

Hot galvanized steel plates, powder coated.  
Four mounted wheels that rotate 360°, each with a brake.  
Has the same colour as its frame. An alu teak frame has a charcoal base.

Tôle d'acier galvanisé à chaud, thermolaqué.  
Quatre roues montées qui tournent à 360°, chacune avec un frein.  
La même couleur que la structure.  
Un mât couleur alu teak a une base couleur charcoal.

Warm verzinkte staalplaten, gepoederlakt.  
Vier gemonteerde wielen die 360° draaien, elk met een rem.  
Heeft dezelfde kleur als het frame.  
Een frame in alu teak heeft een charcoal parasolvoet.



Center pole frame, powder coated aluminium.  
Mât central, aluminium thermolaqué.  
Middenstam parasol, gepoederlakt aluminium.









Canopy 100% solution dyed acrylic, 320 gr/m<sup>2</sup>.  
Toile 100% acrylique teinté en masse, 320 gr/m<sup>2</sup>.  
Doek 100% in de massa gekleurde acryl, 320 gr/m<sup>2</sup>.

Tilt and rotation not applicable.  
Inclinaison non applicable.  
Kantelen en roteren niet van toepassing.

# JCP.2 SERIES

max. 58 km/h, 36 mph

## JCP.201 - 400 X 400 CM

UFJCP.201 FRAME - STRUCTURE				Base Voet	IGB OGB	
MIX & MATCH		A01 white		A02 silver	€ 5.995	€ 4.295
		A31 charcoal				
	UCJCP.201 CANOPY - TOILE - DOEK					
		C003 pearl		C011 cotton		
		C100 ice		C107 mooncrest		
		C207 onyx		C210 pitch		
Free pick: other fabrics on demand - andere stoffen op aanvraag - autres tissus sur demande						

### UBJCP.2S-3S BASE - PARASOLVOET

	S01 white		S02 silver	incl.	/
	S31 charcoal				

UBIGB-JCP.2S-3S in ground base - ancre de sol - grondanker **OR/OU/OF**  
UBOGB-JCP.2S-3S on ground base - plaque de fixation - bevestigingsplaat

/ incl.

### COVER - HOUSSE - HOES

	UPJCP.2S-X77 black	incl.	incl.
--	--------------------	-------	-------

### GUTTERS - GOUTTIÈRES - GOTEN

UAJCP.2S colour of the canopy - couleur de la toile - kleur van het doek	€ 595 / pc.
--	-------------

56 kg, 123.5 lbs nett  
excl. base - voet

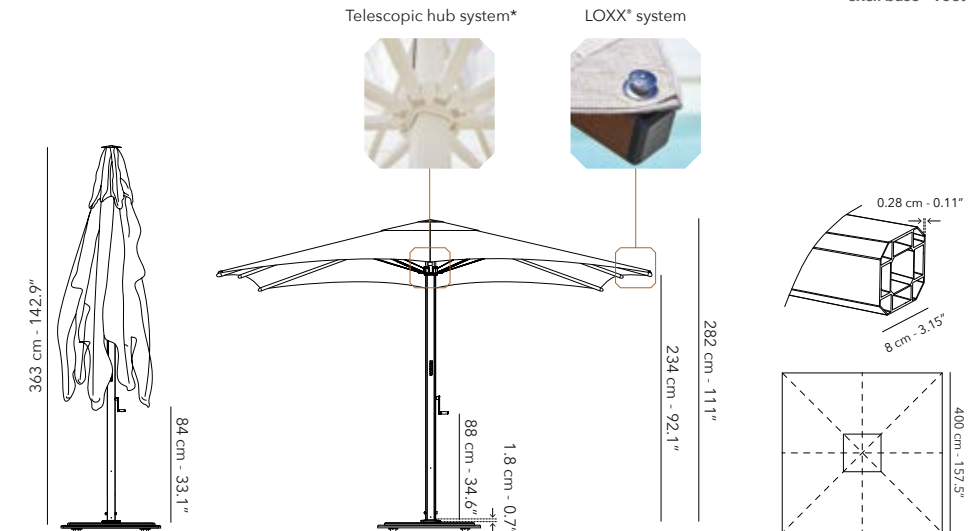

All dimensions exclude the base. - Toutes les dimensions excluent la base. - Alle afmetingen zijn exclusief de parasolvoet.

\* Easy to open and close without touching furniture. - Facile à ouvrir et à fermer sans toucher les meubles.  
Makkelijk te openen en te sluiten zonder meubelen te raken.

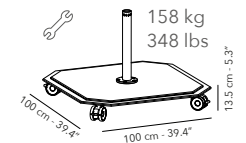

Hot galvanized steel plates, powder coated.  
Four mounted wheels that rotate 360°, each with a brake.  
Has the same colour as its frame.

Tôle d'acier galvanisé à chaud, thermolaqué.  
Quatre roues montées qui tournent à 360°, chacune avec un frein.  
Même couleur que la structure.

Warm verzinkte staalplaten, gepoederlakt.  
Vier gemonteerde wielen die 360° draaien, elk met een rem.  
Heeft dezelfde kleur als het frame.

# JCP.2 SERIES

Center pole frame, powder coated aluminium.  
Mât central, aluminium thermolaqué.  
Middenstam parasol, gepoederlakt aluminium.

Canopy 100% solution dyed acrylic, 320 gr/m<sup>2</sup>.  
Toile 100% acrylique teinté en masse, 320 gr/m<sup>2</sup>.  
Doek 100% in de massa gekleurde acryl, 320 gr/m<sup>2</sup>.

Tilt and rotation not applicable.  
Inclinaison non applicable.  
Kantelen en rotatie niet van toepassing.

max. 58 km/h, 36 mph

## JCP.202 - 500 X 500 CM

UFJCP.202 FRAME - STRUCTURE				Base Voet	IGB OGB	
MIX & MATCH		A01 white		A02 silver	€ 6.555	€ 4.855
		A31 charcoal				
	UCJCP.202 CANOPY - TOILE - DOEK					
		C003 pearl		C011 cotton		
		C100 ice		C107 mooncrest		
		C207 onyx		C210 pitch		
		C305 umber				
Free pick: other fabrics on demand - autres tissus sur demande - andere stoffen op aanvraag						

### UBJCP.2S-3S BASE - PARASOLVOET

	S01 white		S02 silver	incl.	/
	S31 charcoal				

UBIGB-JCP.2S-3S in ground base - ancre de sol - grondanker **OR/OU/OF**  
UBOGB-JCP.2S-3S on ground base - plaque de fixation - bevestigingsplaat

/ incl.

### COVER - HOUSSE - HOES

	UPJCP.2S-X77 black	incl.	incl.
--	--------------------	-------	-------

### GUTTERS - GOUTTIÈRES - GOTEN

UAJCP.2S colour of the canopy - couleur de la toile - kleur van het doek	€ 595 /pc.
--	------------

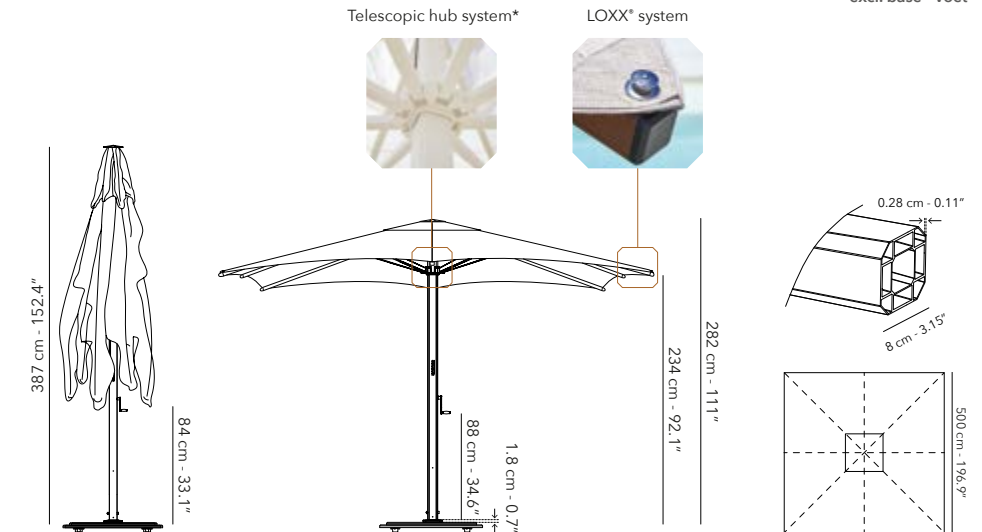

All dimensions exclude the base. - Toutes les dimensions excluent la base. - Alle afmetingen zijn exclusief de parasolvoet.

\* Easy to open and close without touching furniture. - Facile à ouvrir et à fermer sans toucher les meubles.  
Makkelijk te openen en te sluiten zonder meubelen te raken.

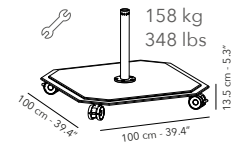

Hot galvanized steel plates, powder coated.  
Four mounted wheels that rotate 360°, each with a brake.  
Has the same colour as its frame.

Tôle d'acier galvanisé à chaud, thermolaqué.  
Quatre roues montées qui tournent à 360°, chacune avec un frein.  
La même couleur que la structure.

Warm verzinkte staalplaten, gepoederlakt.  
Vier gemonteerde wielen die 360° draaien, elk met een rem.  
Heeft dezelfde kleur als het frame.



Center pole frame, powder coated aluminium.  
Structure en mât central, aluminium thermolaqué.  
Middenstam parasol, gepoederlakt aluminium.













Canopy 100% solution dyed acrylic, 320 gr/m<sup>2</sup>.  
Toile 100% acrylique teinté en masse, 320 gr/m<sup>2</sup>.  
Doek 100% in de massa gekleurde acryl, 320 gr/m<sup>2</sup>.

Tilt and rotation not applicable.  
Inclinaison non applicable.  
Kantelen en rotatie niet van toepassing.

# JCP.2 SERIES

max. 58 km/h, 36 mph

## JCP.203 - Ø 450 CM

UFJCP.203 FRAME - STRUCTURE				Base Voet	IGB OGB	
MIX & MATCH		A01 white		A02 silver	€ 5.995	€ 4.295
		A31 charcoal				
	UCJCP.203 CANOPY - DOEK - TOILE					
		C003 pearl		C011 cotton		
		C100 ice		C107 mooncrest		
		C207 onyx		C210 pitch		
Free pick: other fabrics on demand - autres tissus sur demande - andere stoffen op aanvraag						
UBJCP.2S-3S BASE - PARASOLVOET						
	S01 white		S02 silver	incl.	/	
	S31 charcoal					
UBIGB-JCP.2S-3S in ground base - ancre de sol - grondanker OR/OU/OF				/	incl.	
UBOGB-JCP.2S-3S on ground base - plaque de fixation - bevestigingsplaat						
COVER - HOUSSE - HOES						
	UPJCP.2S-X77 black			incl.	incl.	

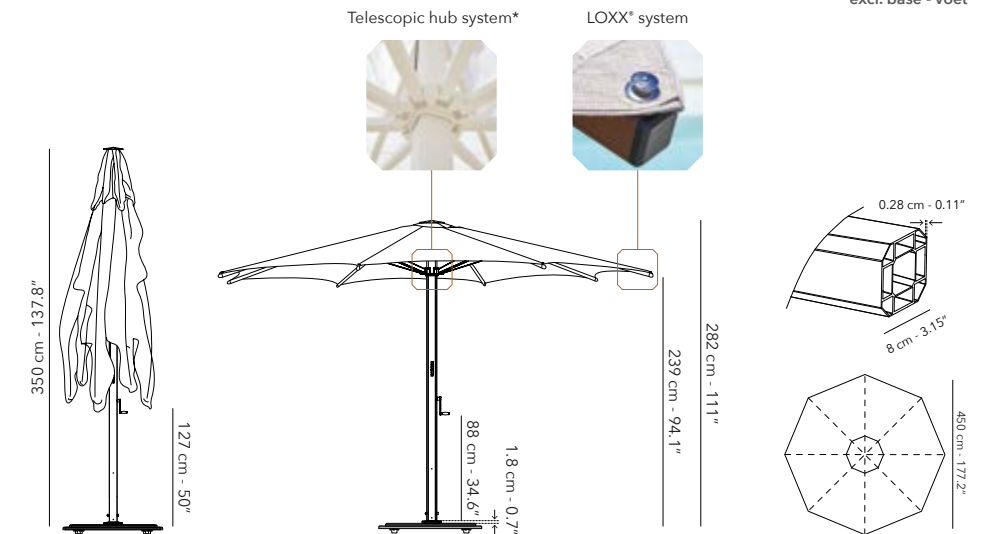

All dimensions exclude the base - Toutes les dimensions excluent la base. - Alle afmetingen zijn exclusief de parasolvoet.

\* Easy to open and close without touching furniture. - Facile à ouvrir et à fermer sans toucher les meubles.  
Makkelijk te openen en te sluiten zonder meubelen te raken.



Hot galvanized steel plates, powder coated.  
Four mounted wheels that rotate 360°, each with a brake.  
Has the same colour as its frame.

Tôle d'acier galvanisé à chaud, thermolaqué.  
Quatre roues montées qui tournent à 360°, chacune avec un frein.  
Même couleur que la structure.

Warm verzinkte staalplaten, gepoederlakt.  
Vier gemonteerde wielen die 360° draaien, elk met een rem.  
Heeft dezelfde kleur als het frame.

# JCP.3 SERIES

Free pole frame, powder coated aluminium.  
Mât déporté, aluminium thermolaqué.  
Vrijhangende parasol, gepoederlakt aluminium.

Canopy 100% solution dyed acrylic, 320 gr/m<sup>2</sup>.  
Toile 100% acrylique teintée en masse, 320 gr/m<sup>2</sup>.  
Doek 100% in de massa gekleurde acryl, 320 gr/m<sup>2</sup>.

Tilt in height, left and right, rotation 360°.  
Inclinable en hauteur, à gauche et à droite, rotation de 360°.  
Kantelen in de hoogte, links & rechts, 360° rotatie.



max. 58 km/h, 36 mph

## JCP.301 - 300 X 300 CM

### UMJCP.301 FRAME & CANOPY - STRUCTURE & TOILE - FRAME & DOEK

		Base Voet	IGB OGB
FIXED COMBO		<b>A01C101</b> white & cloud	€ 4.295
		<b>A12C001</b> alu teak & natural	
		<b>A31C101</b> charcoal & cloud	
		<b>A31C204</b> charcoal & night	
		<b>A32C208</b> black & black	
		€ 2.895	

### UFJCP.301 FRAME - STRUCTURE

				Base Voet	IGB OGB
MIX & MATCH		<b>A01</b> white		<b>A02</b> silver	€ 5.295
		<b>A03</b> linen <b>NEW</b>		<b>A10</b> cappuccino	
		<b>A12</b> alu teak		<b>A31</b> charcoal	
		<b>A32</b> black			
	<b>UCJCP.301 CANOPY - TOILE - DOEK</b>				
		<b>C003</b> pearl		<b>C011</b> cotton	
		<b>C100</b> ice		<b>C107</b> mooncrest	
		<b>C207</b> onyx		<b>C210</b> pitch	
		<b>C305</b> umber			
	Free pick: other fabrics on demand - andere stoffen op aanvraag - autres tissus sur demande				
				€ 3.895	

### UBJCP.2S-3S BASE - PARASOLVOET

	<b>S01</b> white		<b>S02</b> silver	incl.	/
	<b>S03</b> linen <b>NEW</b>		<b>S31</b> charcoal		
	<b>S32</b> black				

<b>UBIGB-JCP.2S-3S</b> in ground base - ancre de sol - grondanker <b>OR/OU/OF</b>	/	incl.
<b>UBOGB-JCP.2S-3S</b> on ground base - plaque de fixation - bevestigingsplaat		

### COVER - HOUSSE - HOES

	<b>UPJCP.3S-X77</b> black	incl.	incl.
--	---------------------------	-------	-------

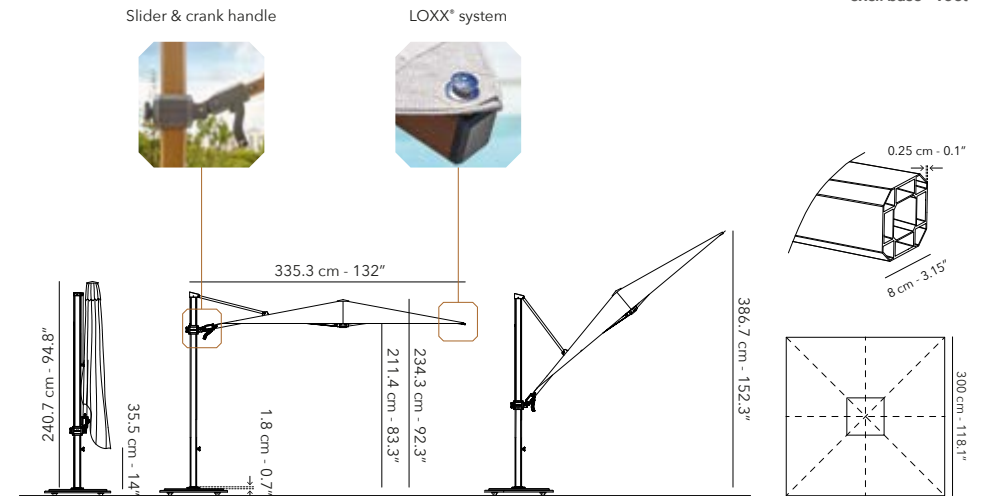

All dimensions exclude the base. - Toutes les dimensions excluent la base. - Alle afmetingen zijn exclusief de parasolvoet.

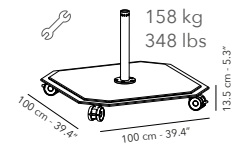

Hot galvanized steel plates, powder coated.  
Four mounted wheels that rotate 360°, each with a brake.  
Has the same colour as its frame. An alu teak frame has a charcoal base.

Tôle d'acier galvanisé à chaud, thermolaqué.  
Quatre roues montées qui tournent à 360°, chacune avec un frein.  
La même couleur que la structure.  
Un mât couleur alu teak a une base couleur charcoal.

Warm verzinkte staalplaten, gepoederlakt.  
Vier gemonteerde wielen die 360° draaien, elk met een rem.  
Heeft dezelfde kleur als het frame.  
Een frame in alu teak heeft een charcoal parasolvoet.



Free pole frame, powder coated aluminium.  
Mât déporté, aluminium thermolaqué.  
Vrijhangende parasol, gepoederlakt aluminium.

Canopy 100% solution dyed acrylic, 320 gr/m<sup>2</sup>  
Toile 100% acrylique teinté en masse, 320 gr/m<sup>2</sup>  
Doek 100% in de massa gekleurde acryl, 320 gr/m<sup>2</sup>

Tilt in height, left and right, rotation 360°.  
Inclinable en hauteur, à gauche et à droite, rotation de 360°.  
Kantelen in de hoogte, links & rechts, 360° rotatie.

# JCP.3 SERIES

## JCP.302 - 260 X 260 CM

UMJCP.302 FRAME & CANOPY - STRUCTURE & TOILE - FRAME & DOEK			Base Voet	IGB OGB
FIXED COMBO		A01C101 white & cloud	€ 3.995	€ 2.295
		A12C001 alu teak & natural		
		A31C101 charcoal & cloud		
		A31C204 charcoal & night		

UFJCP.302 FRAME - STRUCTURE			Base Voet	IGB OGB
MIX & MATCH		A01 white	€ 4.795	€ 3.095
		A02 silver		
		A10 cappuccino		
		A12 alu teak		
UCJCP.302 CANOPY - TOILE - DOEK				
	C003 pearl		C011 cotton	
	C100 ice		C107 mooncrest	
	C207 onyx		C210 pitch	
	C305 umber			
Free pick: other fabrics on demand - autres tissus sur demande - andere stoffen op aanvraag				

UBJCP.2S-3S BASE - PARASOLVOET					
	S01 white		S02 silver	incl.	/
	S31 charcoal				

UBIGB-JCP.2S-3S in ground base - ancre de sol - grondanker	OR/OU/OF	/	incl.
UBOGB-JCP.2S-3S on ground base - plaque de fixation - bevestigingsplaat			

COVER - HOUSSE - HOES				
	UPJCP.3S-X77 black		incl.	incl.



max. 58 km/h, 36 mph

31 kg, 68.3 lbs nett  
excl. base - voet

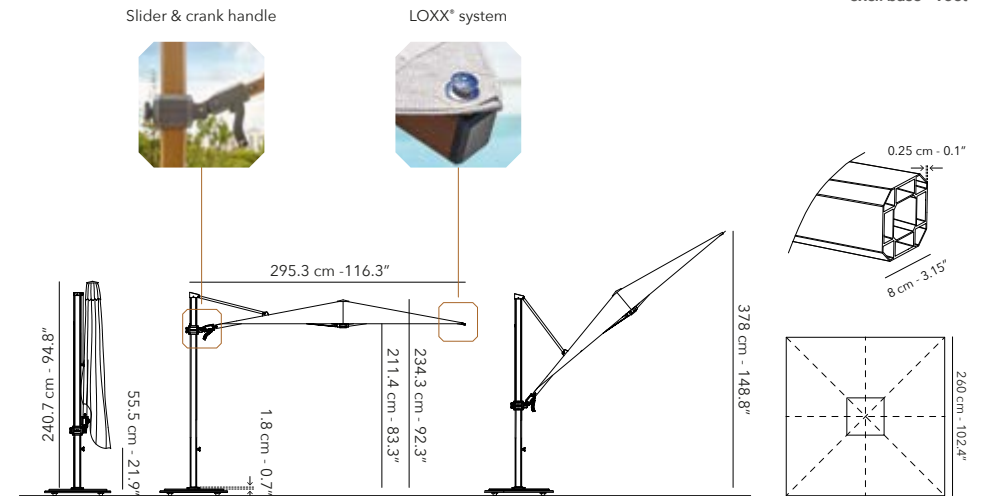

All dimensions exclude the base. - Toutes les dimensions excluent la base. - Alle afmetingen zijn exclusief de parasolvoet.

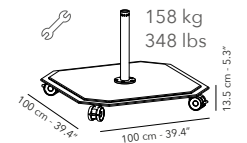

Hot galvanized steel plates, powder coated.  
Four mounted wheels that rotate 360°, each with a brake.  
Has the same colour as its frame. An alu teak frame has a charcoal base.

Tôle d'acier galvanisé à chaud, thermolaqué.  
Quatre roues montées qui tournent à 360°, chacune avec un frein.  
La même couleur que la structure.  
Un mât couleur alu teak a une base couleur charcoal.

Warm verzinkte staalplaten, gepoederlakt.  
Vier gemonteerde wielen die 360° draaien, elk met een rem.  
Heeft dezelfde kleur als het frame.  
Een frame in alu teak heeft een charcoal parasolvoet.



# JCP.3 SERIES

Free pole frame, powder coated aluminium.  
Mât déporté, aluminium thermolaqué.  
Vrijhangende parasol, gepoederlakt aluminium.

Canopy 100% solution dyed acrylic, 320 gr/m<sup>2</sup>  
Toile 100% acrylique teintée en masse, 320 gr/m<sup>2</sup>  
Doek 100% in de massa gekleurde acryl, 320 gr/m<sup>2</sup>

Tilt in height, left and right, rotation 360°.  
Inclinable en hauteur, à gauche et à droite, rotation de 360°.  
Kantelen in de hoogte, links & rechts, 360° rotatie.

## JCP.303 - Ø 350 CM

### UFJCP.303 FRAME - STRUCTURE

		Base Voet	IGB OGB
	A01 white	€ 5.295	€ 3.595
	A02 silver		
	A10 cappuccino		
	A12 alu teak		
	A31 charcoal		
<b>MIX &amp; MATCH</b>			
<b>UCJCP.303 CANOPY - TOILE - DOEK</b>			
	C003 pearl	€ 5.295	€ 3.595
	C011 cotton		
	C100 ice		
	C107 mooncrest		
	C207 onyx		
	C210 pitch		
	C305 umber		
Free pick: other fabrics on demand - andere stoffen op aanvraag - autres tissus sur demande			

### UBJCP.2S-3S BASE - PARASOLVOET

	S01 white	incl.	/
	S02 silver		
	S31 charcoal		
<b>UBIGB-JCP.2S-3S</b> in ground base - ancre de sol - grondanker <b>OR/OU/OF</b>		/	incl.
<b>UBOGB-JCP.2S-3S</b> on ground base - plaque de fixation - bevestigingsplaat			

### COVER - HOES - HOUSSE

	UPJCP.3S-X77 black	incl.	incl.
--	--------------------	-------	-------



max. 58 km/h, 36 mph

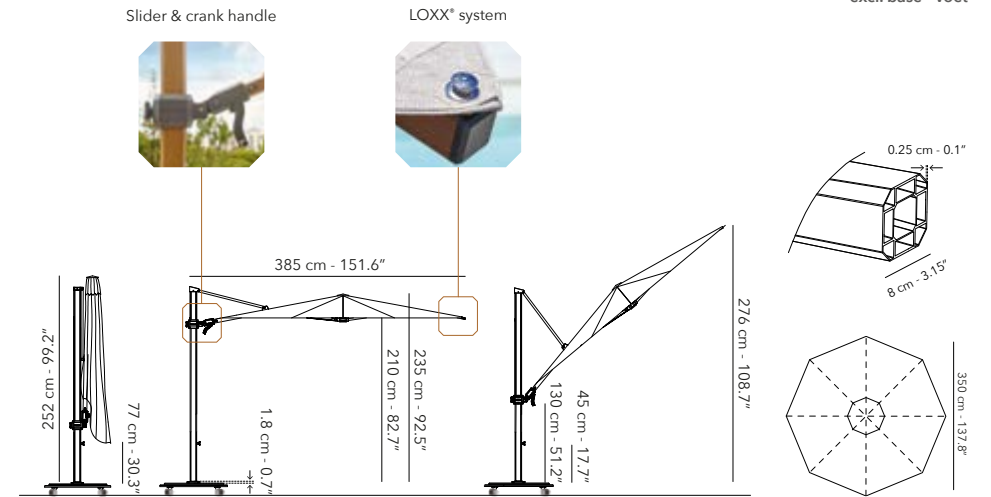

All dimensions exclude the base. - Toutes les dimensions excluent la base. - Alle afmetingen zijn exclusief de parasolvoet.

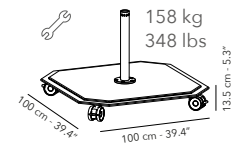

Hot galvanized steel plates, powder coated.  
Four mounted wheels that rotate 360°, each with a brake.  
Has the same colour as its frame. An alu teak frame has a charcoal base.

Tôle d'acier galvanisé à chaud, thermolaqué.  
Quatre roues montées qui tournent à 360°, chacune avec un frein.  
La même couleur que la structure.  
Un mât couleur alu teak a une base couleur charcoal.

Warm verzinkte staalplaten, gepoederlakt.  
Vier gemonteerde wielen die 360° draaien, elk met een rem.  
Heeft dezelfde kleur als het frame.  
Een frame in alu teak heeft een charcoal parasolvoet.





Free pole frame, powder coated aluminium.  
Mât déporté, aluminium thermolaqué.  
Vrijhangende parasol, gepoederlakt aluminium.

Canopy 100% solution dyed acrylic, 320 gr/m<sup>2</sup>  
Toile 100% acrylique teinté en masse, 320 gr/m<sup>2</sup>  
Doek 100% in de massa gekleurde acryl, 320 gr/m<sup>2</sup>

Tilt in height, rotation 360°.  
Inclinable en hauteur, rotation de 360°.  
Kantelen in de hoogte, 360° rotatie.

# JCP.4 SERIES



max. 58 km/h, 36 mph

## JCP.401 - 370 X 370 CM

### UMJCP.401 FRAME & CANOPY - STRUCTURE & TOILE - FRAME & DOEK

			Base Voet	IGB OGB
FIXED COMBO		A01C101 white & cloud	€ 6.995	€ 4.995
		A12C001 alu teak & natural		
		A31C101 charcoal & cloud		
		A31C204 charcoal & night		
		A32C208 black & black		

### UFJCP.401 FRAME - STRUCTURE

				Base Voet	IGB OGB	
MIX & MATCH		A01 white		A02 silver	€ 7.995	€ 5.995
		A03 linen NEW		A10 cappuccino		
		A12 alu teak		A31 charcoal		
		A32 black				
	<b>UCJCP.401 CANOPY - TOILE - DOEK</b>					
	C003 pearl		C011 cotton			
	C100 ice		C107 mooncrest			
	C207 onyx		C210 pitch			
	C305 umber					
Free pick: other fabrics on demand - autres tissus sur demande - andere stoffen op aanvraag						

### UBJCP.4S BASE - PARASOLVOET

	S01 white		S02 silver	incl.	/
	S03 linen NEW		S31 charcoal		
	S32 black				

UBIGB-JCP.4S-5S-6S in ground base - ancre de sol - grondanker OR/OU/OF	/	incl.
UBOGB-JCP.4S-5S-6S on ground base - plaque de fixation - bevestigingsplaat		

### COVER - HOUSSE - HOES

	UPJCP.4S-X77 black	incl.	incl.
--	--------------------	-------	-------

64 kg, 141.1 lbs nett  
excl. base - voet

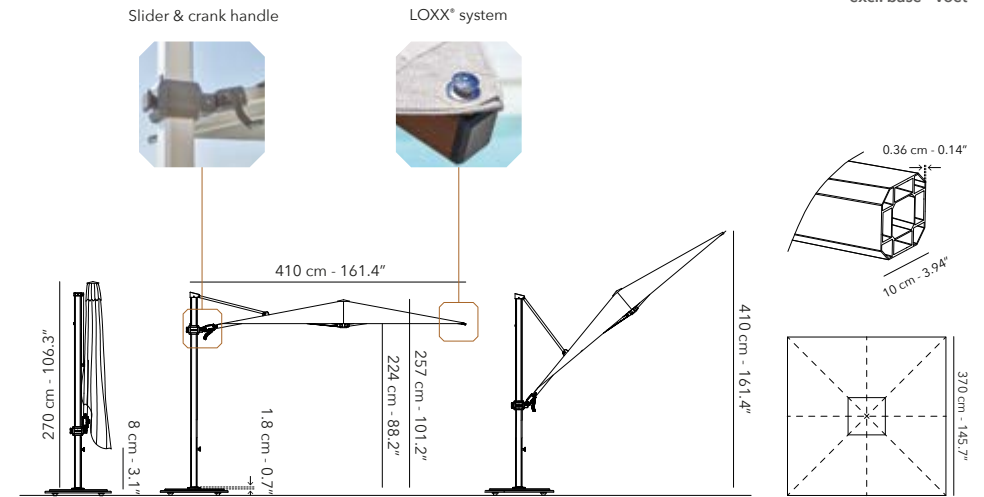

All dimensions exclude the base. - Toutes les dimensions excluent la base. - Alle afmetingen zijn exclusief de parasolvoet.

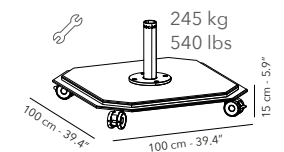

Hot galvanized steel plates, powder coated.  
Four mounted wheels that rotate 360°, each with a brake.  
Has the same colour as its frame. An alu teak frame has a charcoal base.

Tôle d'acier galvanisé à chaud, thermolaqué.  
Quatre roues montées qui tournent à 360°, chacune avec un frein.  
La même couleur que la structure.

Un mât couleur alu teak a une base couleur charcoal.

Warm verzinkte staalplaten, gepoederlakt.  
Vier gemonteerde wielen die 360° draaien, elk met een rem.  
Heeft dezelfde kleur als het frame.

Een frame in alu teak heeft een charcoal parasolvoet.



# JCP.4 SERIES

Free pole frame, powder coated aluminium.  
Mât déporté, aluminium thermolaqué.  
Vrijhangende parasol, gepoederlakt aluminium.

Canopy 100% solution dyed acrylic, 320 gr/m<sup>2</sup>  
Toile 100% acrylique teintée en masse, 320 gr/m<sup>2</sup>  
Doek 100% in de massa gekleurde acryl, 320 gr/m<sup>2</sup>

Tilt in height, rotation 360°.  
Inclinable en hauteur, rotation de 360°.  
Kantelen in de hoogte, 360° rotatie.



max. 58 km/h, 36 mph

## JCP.402 - 425 X 300 CM

UFJCP.402 FRAME - STRUCTURE			Base Voet	IGB OGB		
MIX & MATCH		A01 white				
		A02 silver				
		A10 cappuccino				
		A12 alu teak				
		A31 charcoal				
	UCJCP.402 CANOPY - TOILE - DOEK					
		C003 pearl			€ 7.995	€ 5.995
		C011 cotton				
		C100 ice				
		C107 mooncrest				
	C207 onyx					
	C210 pitch					
Free pick: other fabrics on demand - autres tissus sur demande - andere stoffen op aanvraag						
UBJCP.4S BASE - PARASOLVOET						
	S01 white		S02 silver	incl.	/	
	S31 charcoal					
UBIGB-JCP.4S-5S-6S in ground base - ancre de sol - grondanker OR/OU/OF			/	incl.		
UBOGB-JCP.4S-5S-6S on ground base - plaque de fixation - bevestigingsplaat						
COVER - HOUSSE - HOES						
	UPJCP.4S-X77 black		incl.	incl.		

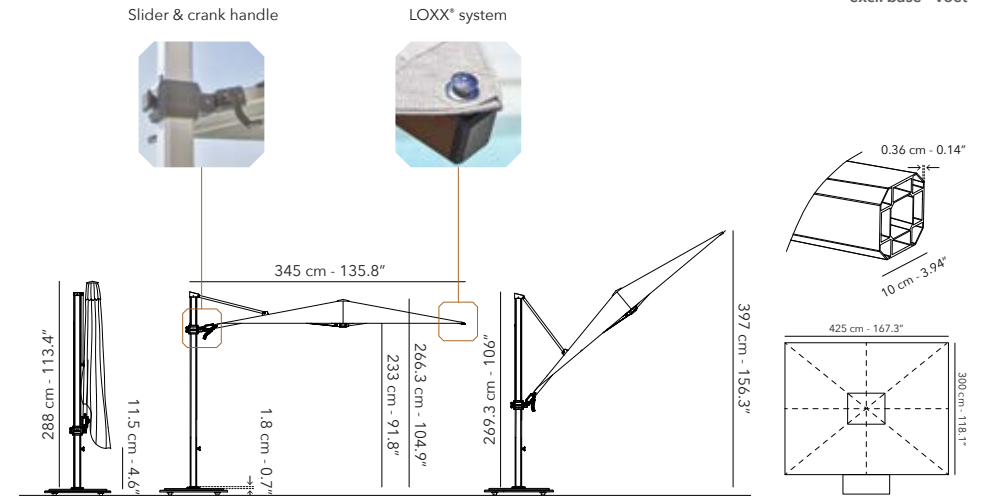

All dimensions exclude the base. - Toutes les dimensions excluent la base. - Alle afmetingen zijn exclusief de parasolvoet.

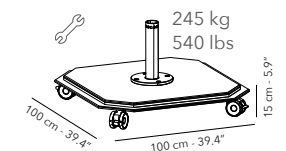

Hot galvanized steel plates, powder coated.  
Four mounted wheels that rotate 360°, each with a brake.  
Has the same colour as its frame. An alu teak frame has a charcoal base.

Tôle d'acier galvanisé à chaud, thermolaqué.  
Quatre roues montées qui tournent à 360°, chacune avec un frein.  
La même couleur que la structure.  
Un mât couleur alu teak a une base couleur charcoal.

Warm verzinkte staalplaten, gepoederlakt.  
Vier gemonteerde wielen die 360° draaien, elk met een rem.  
Heeft dezelfde kleur als het frame.  
Een frame in alu teak heeft een charcoal parasolvoet.



Free pole frame, powder coated aluminium.  
Mât déporté, aluminium thermolaqué.  
Vrijhangende parasol, gepoederlakt aluminium.

Canopy 100% solution dyed acrylic, 320 gr/m<sup>2</sup>  
Toile 100% acrylique teinté en masse, 320 gr/m<sup>2</sup>  
Doek 100% in de massa gekleurde acryl, 320 gr/m<sup>2</sup>

Tilt in height, rotation 360°.  
Inclinable en hauteur, rotation de 360°.  
Kantelen in de hoogte, 360° rotatie.

# JCP.4 SERIES



max. 58 km/h, 36 mph

## JCP.403 - Ø 400 CM

UFJCP.403 FRAME - STRUCTURE			Base Voet	IGB OGB			
MIX & MATCH		A01 white	€ 7.995	€ 5.995			
		A02 silver					
		A10 cappuccino					
		A12 alu teak					
		A31 charcoal					
	UCJCP.403 CANOPY - TOILE - DOEK						
		C003 pearl					
		C011 cotton					
		C100 ice					
		C107 mooncrest					
	C207 onyx						
	C210 pitch						
Free pick: other fabrics on demand - autres tissus sur demande - andere stoffen op aanvraag							

### UBJCP.4S BASE - PARASOLVOET

	S01 white		S02 silver	incl.	/
	S31 charcoal				
UBIGB-JCP.4S-5S-6S in ground base - ancre de sol - grondanker OR/OU/OF			/	incl.	
UBOGB-JCP.4S-5S-6S on ground base - plaque de fixation - bevestigingsplaat					

### COVER - HOUSSE - HOES

	UPJCP.4S-X77 black	incl.	incl.
--	--------------------	-------	-------

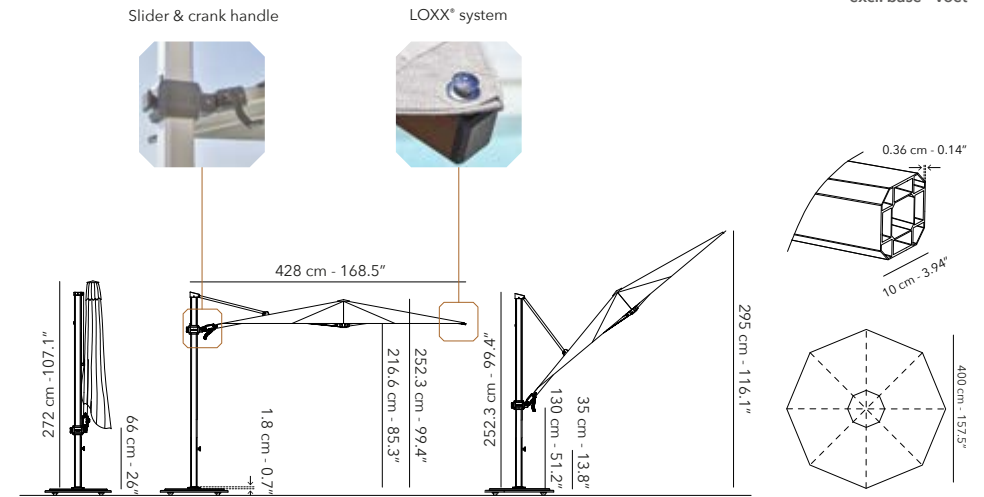

All dimensions exclude the base. - Toutes les dimensions excluent la base. - Alle afmetingen zijn exclusief de parasolvoet.

53 kg, 116.8 lbs nett  
excl. base - voet

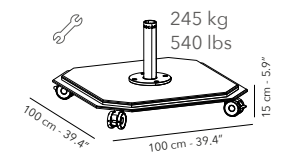

Hot galvanized steel plates, powder coated.  
Four mounted wheels that rotate 360°, each with a brake.  
Has the same colour as its frame. An alu teak frame has a charcoal base.

Tôle d'acier galvanisé à chaud, thermolaqué.  
Quatre roues montées qui tournent à 360°, chacune avec un frein.  
La même couleur que la structure.  
Un mât couleur alu teak a une base couleur charcoal.

Warm verzinkte staalplaten, gepoederlakt.  
Vier gemonteerde wielen die 360° draaien, elk met een rem.  
Heeft dezelfde kleur als het frame.  
Een frame in alu teak heeft een charcoal parasolvoet.



# JCP.4 SERIES

Free pole frame, powder coated aluminium.  
Mât déporté, aluminium thermolaqué.  
Vrijhangende parasol, gepoederlakt aluminium.

Canopy 100% solution dyed acrylic, 320 gr/m<sup>2</sup>  
Toile 100% acrylique teinté en masse, 320 gr/m<sup>2</sup>  
Doek 100% in de massa gekleurde acryl, 320 gr/m<sup>2</sup>

Tilt in height, rotation 360°.  
Inclinable en hauteur, rotation de 360°.  
Kantelen in de hoogte, 360° rotatie.



max. 58 km/h, 36 mph

## JCP.404 - 250 X 350 CM

UFJCP.404 FRAME - STRUCTURE		Base Voet	IGB OGB	
MIX & MATCH	A01 white	€ 6.795	€ 4.795	
	A02 silver			
	A10 cappuccino			A12 alu teak
	A31 charcoal			
	UCJCP.404 CANOPY - TOILE - DOEK			
	C003 pearl			C011 cotton
	C100 ice			C107 mooncrest
	C207 onyx			C210 pitch
	C305 umber			
	Free pick: other fabrics on demand - autres tissus sur demande - andere stoffen op aanvraag			
UBJCP.4S BASE - PARASOLVOET				
S01 white	S02 silver	incl.	/	
S31 charcoal				
UBIGB-JCP.4S-5S-6S in ground base - ancre de sol - grondanker OR/OU/OF		/	incl.	
UBOGB-JCP.4S-5S-6S on ground base - plaque de fixation - bevestigingsplaat				
COVER - HOUSSE - HOES				
UPJCP.4S-X77 black		incl.	incl.	

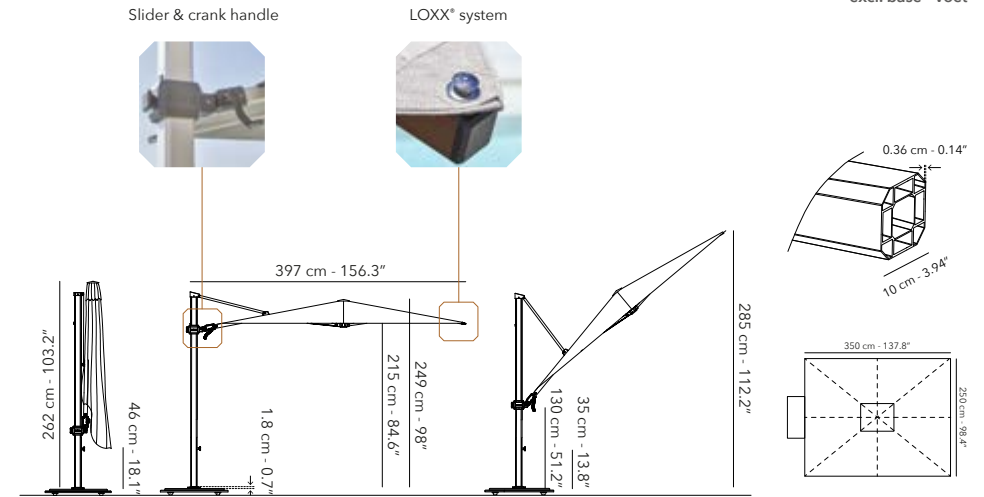

All dimensions exclude the base. - Toutes les dimensions excluent la base. - Alle afmetingen zijn exclusief de parasolvoet.

60 kg, 132.3 lbs nett  
excl. base - voet

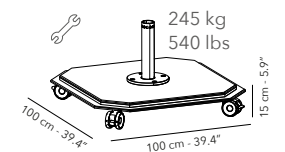

Hot galvanized steel plates, powder coated.  
Four mounted wheels that rotate 360°, each with a brake.  
Has the same colour as its frame. An alu teak frame has a charcoal base.

Tôle d'acier galvanisé à chaud, thermolaqué.  
Quatre roues montées qui tournent à 360°, chacune avec un frein.  
La même couleur que la structure.  
Un mât couleur alu teak a une base couleur charcoal.

Warm verzinkte staalplaten, gepoederlakt.  
Vier gemonteerde wielen die 360° draaien, elk met een rem.  
Heeft dezelfde kleur als het frame.  
Een frame in alu teak heeft een charcoal parasolvoet.





# JCP.5 SERIES

Free pole frame, powder coated aluminium.  
Mât déporté, aluminium thermolaqué.  
Vrijhangende parasol, gepoederlakt aluminium.

Canopy 100% solution dyed acrylic, 320 gr/m<sup>2</sup>  
Toile 100% acrylique teinté en masse, 320 gr/m<sup>2</sup>  
Doek 100% in de massa gekleurde acryl, 320 gr/m<sup>2</sup>

Tilt in height, rotation 360°.  
Inclinable en hauteur, rotation de 360°.  
Kantelen in de hoogte, 360° rotatie.



max. 58 km/h, 36 mph

## JCP.501 - 4\* 300 X 300 CM

UFJCP.501 FRAME - STRUCTURE				Base Voet	IGB OGB			
MIX & MATCH		A02 silver		A12 alu teak	€ 11.995	€ 8.995		
		A31 charcoal						
	UCJCP.501 CANOPY - TOILE - DOEK							
		C003 pearl		C011 cotton				
		C100 ice		C107 mooncrest				
		C207 onyx		C210 pitch				
Free pick: other fabrics on demand - autres tissus sur demande - andere stoffen op aanvraag								

### UBJCP.5S-6S BASE - PARASOLVOET

	S02 silver		S31 charcoal	incl.	/
--	------------	--	--------------	-------	---

UBIGB-JCP.4S-5S-6S in ground base - ancre de sol - grondanker **OR/OU/OF**  
UBOGB-JCP.4S-5S-6S on ground base - plaque de fixation - bevestigingsplaat

/ incl.

### COVER - HOUSSE - HOES

	UPJCP.5S-X77 black	incl.	incl.
--	--------------------	-------	-------

### UAJCP.5S GUTTERS - GOUTTIÈRES - GOTEN (4x)

A fabric from our fast stock - Un tissu du fast stock - Een stof uit fast stock	€ 1.295
Other fabric of your choice - Autre tissu de votre choix - Stof naar keuze	€ 1.395

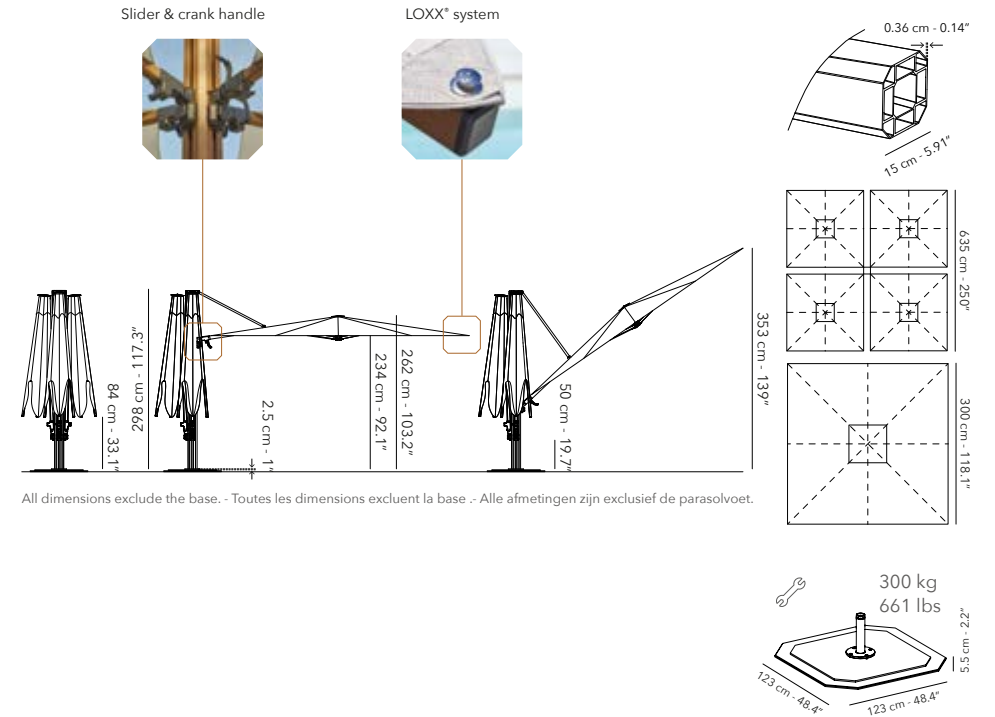

143.5 kg, 316.4 lbs nett  
excl. base - voet

Hot galvanized steel plates, powder coated.  
Bases without wheels.  
Has the same colour as its frame. An alu teak frame has a charcoal base.

Tôle d'acier galvanisé à chaud, thermolaqué.  
Base sans roues.  
La même couleur que la structure.  
Un mât couleur alu teak a une base couleur charcoal.

Warm verzinkte staalplaten, gepoederlakt.  
Parasolvoet zonder wielen.  
Heeft dezelfde kleur als het frame.  
Een frame in alu teak heeft een charcoal parasolvoet.



Free pole frame, powder coated aluminium.  
 Mât déporté, aluminium thermolaqué.  
 Vrijhangende parasol, gepoederlakt aluminium.

Canopy 100% solution dyed acrylic, 320 gr/m<sup>2</sup>  
 Toile 100% acrylique teinté en masse, 320 gr/m<sup>2</sup>  
 Doek 100% in de massa gekleurde acryl, 320 gr/m<sup>2</sup>

Tilt in height, rotation 360°.  
 Incluable en hauteur, rotation de 360°.  
 Kantelen in de hoogte, 360° rotatie.

# JCP.6 SERIES



max. 58 km/h, 36 mph

## JCP.601 - 2\* 300 X 300 CM

UFJCP.601 FRAME - STRUCTURE		Base Voet	IGB OGB		
	A10 cappuccino	€ 8.995	€ 5.995		
	A12 alu teak				
	A31 charcoal				
UCJCP.601 CANOPY - TOILE - DOEK					
	C003 pearl				
	C011 cotton				
	C100 ice				
	C107 mooncrest				
	C207 onyx				
	C210 pitch				
	C305 umber				
Free pick: other fabrics on demand - autres tissus sur demande - andere stoffen op aanvraag					
UBJCP.5S-6S BASE - PARASOLVOET					
	S02 silver	incl.	/		
	S31 charcoal				
UBIGB-JCP.4S-5S-6S in ground base - ancre de sol - grondanker OR/OU/OF		/	incl.		
UBOGB-JCP.4S-5S-6S on ground base - plaque de fixation - bevestigingsplaat					
COVER - HOUSSE - HOES					
	UPJCP.6S-X77 black	incl.	incl.		

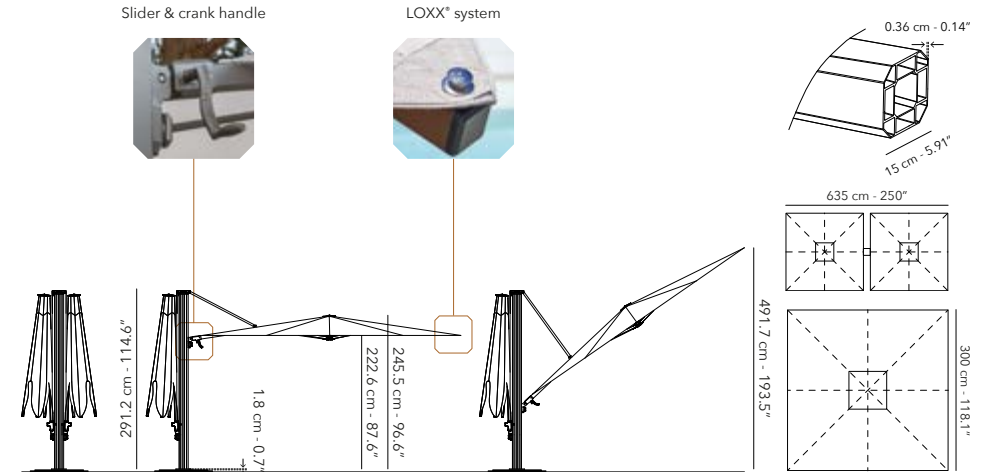

All sizes exclude the base. - Toutes les dimensions excluent la base. - Alle afmetingen zijn exclusief de parasolvoet.

86.5 kg, 190.7 lbs nett  
 excl. base - voet

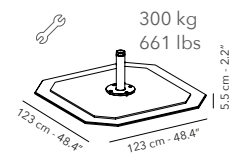
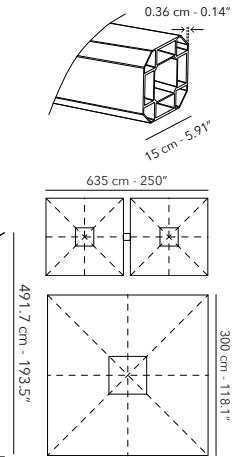

Hot galvanized steel plates, powder coated.  
 Bases without wheels.  
 Has the same colour as its frame. An alu teak frame has a charcoal base.

Tôle d'acier galvanisé à chaud, thermolaqué.  
 Base sans roues.  
 La même couleur que la structure.  
 Un mât couleur alu teak a une base couleur charcoal.

Warm verzinkte staalplaten, gepoederlakt.  
 Parasolvoet zonder wielen.  
 Heeft dezelfde kleur als het frame.  
 Een frame in alu teak heeft een charcoal parasolvoet.







**OUTDOOR SHADE**  
ATTITUDE

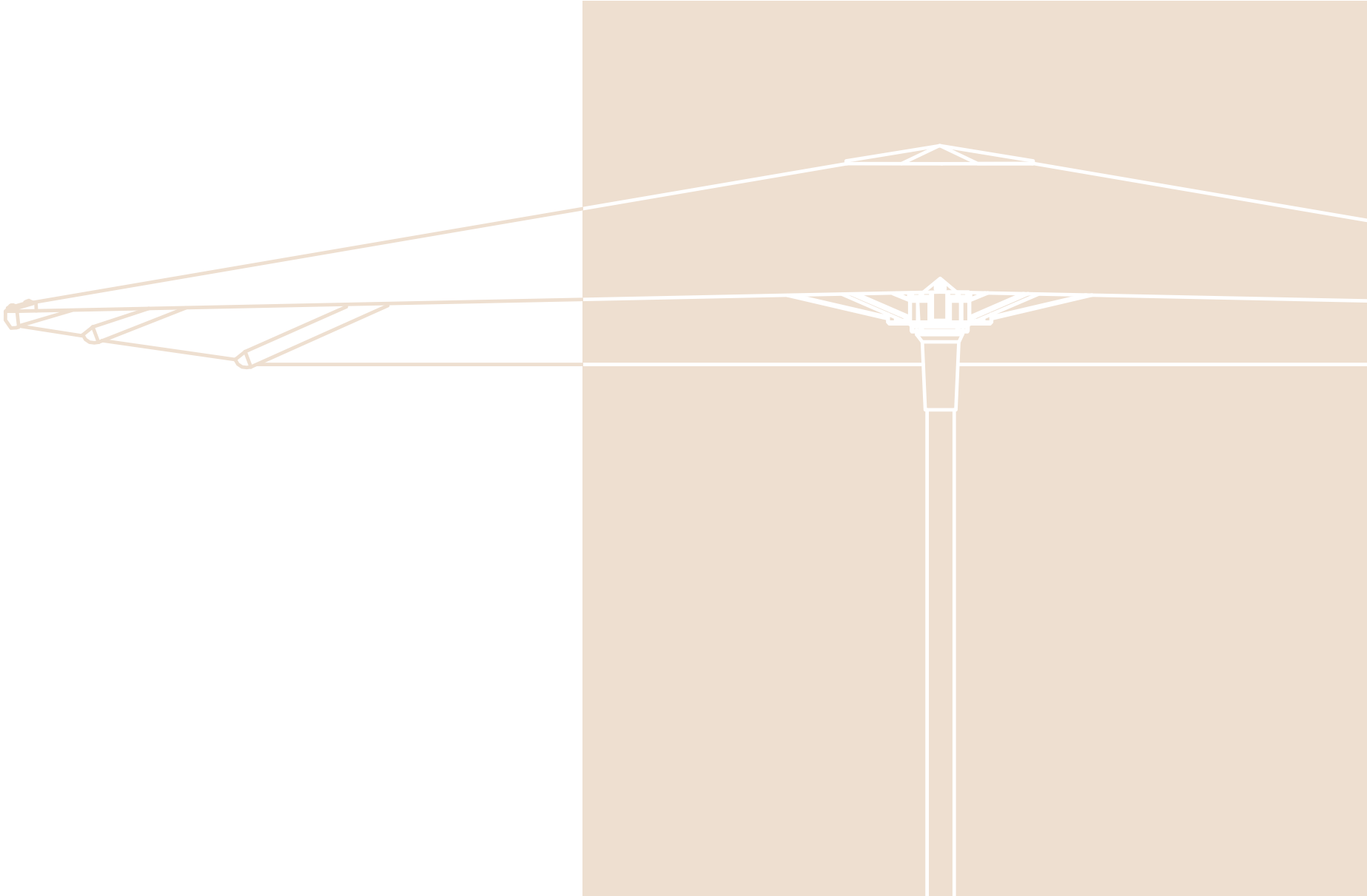



Free pole frame, powder coated aluminium.  
Mât déporté, aluminium thermolaqué.  
Vrijhangende parasol, gepoederlakt aluminium.

Canopy is weatherproof and colour resistant.  
Toile est résistant aux intempéries et aux couleurs.  
Doek is weerbestendig en kleurvast.

Tilt in height, left and right, rotation 360°.  
Inclinable en hauteur, à gauche et à droite, rotation de 360°.  
Kantelen in de hoogte, links & rechts, 360° rotatie.

AZORE

UPDATED with base plate

max. 27 km/h, 17 mph



**AZORE** fully assembled (excl. base)

UMAZO FRAME & CANOPY - STRUCTURE & TOILE - FRAME & DOEK		300 x 300
	<b>A01C101</b> white & cloud	€ 1.295
	<b>A30C204</b> anthracite & night	
	<b>A32C208</b> black & black	

**UB BASE - PARASOLVOET**

	<b>AZO-125CA-G04</b> azore	€ 645
--	----------------------------	-------

<b>IGB-AZO-4G-MEDIUM</b> in ground base - ancre de sol - grondanker	€ 245
---	-------

<b>OGB-AZO-4G-MEDIUM</b> on ground base - plaque de fixation - bevestigingsplaat	€ 125
--	-------

**UP COVER - HOUSSE - HOES**

<b>AZO-M-X75</b> grey	€ 75
-----------------------	------

**UA ACCESSORIES - ACCESSOIRES**

<b>LUN-LED02</b> Luna LED light - lumière - verlichting	€ 175
---	-------

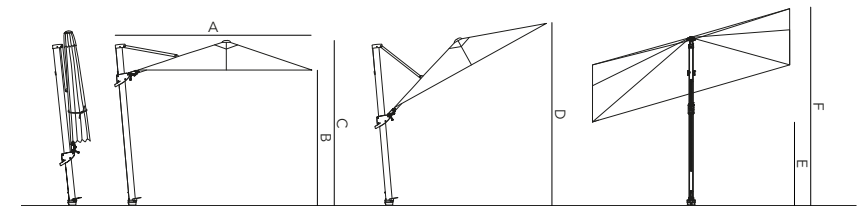
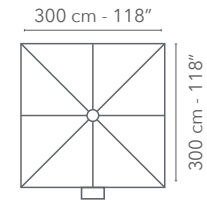

300 X 300 CM			
	27 kg - 59.5 lbs nett excl. base - voet		
A	375 cm - 147.6"	D	355 cm - 139.8"
B	203 cm - 79.9"	E	130 cm - 51.2"
C	262 cm - 103.1"	F	300 cm - 118.1"



300 x 300 cm



**UBAZO-125CA-G04**  
AZORE  
SILK GREY GRANITE

125 kg, 275.6 lbs  
80 x 80 x 7 cm  
31.5 x 31.5 x 2.2"  
incl. wheels - roues - wielen

# ANTEGO

Free pole frame, powder coated aluminium.  
Mât déporté, aluminium thermolaqué.  
Vrijhangende parasol, gepoederlakt aluminium.

Canopy is weatherproof and colour resistant.  
Toile est résistant aux intempéries et aux couleurs.  
Doek is weerbestendig en kleurvast.

Tilt in height, left and right, rotation 360°.  
Inclinable en hauteur, à gauche et à droite, rotation de 360°.  
Kantelen in de hoogte, links & rechts, 360° rotatie.

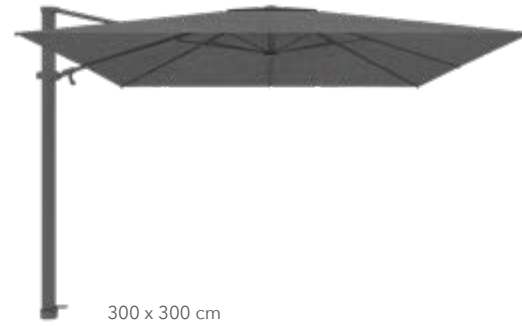

**UBANT-125**  
CONCRETE

125 kg, 275.6 lbs  
92.5 x 92.5 x 6.5 cm  
36.4 x 36.4 x 2.5"

incl. wheels - roues - wielen  
**B03** linen **B32** black



**UBANT-125CA-G04**  
SILK GREY GRANITE

125 kg, 275.6 lbs  
92.5 x 92.5 x 5 cm  
36.4 x 36.4 x 2"

incl. wheels - roues - wielen  
optional: tegels - tuiles (p.38)



**UBANT-125-G13**  
SANDSTONE

125 kg, 275.6 lbs  
92.5 x 92.5 x 5 cm  
36.4 x 36.4 x 2"

incl. wheels - roues - wielen



**UBANT-125-G32**  
BLACK GRANITE

125 kg, 275.6 lbs  
92.5 x 92.5 x 5 cm  
36.4 x 36.4 x 2"

incl. wheels - roues - wielen

max. 39 km/h, 24 mph



## ANTEGO

### UFANT FRAME - STRUCTURE

		300 x 200	300 x 300	ø 350
	A01 white	€ 1.195	€ 1.495	€ 1.495
	A02 silver*			
	A03 linen			
	A11 taupe			
	A12 alu teak	€ 1.195	€ 1.495	€ 1.495
	A14 lava <b>NEW</b>			
	A30 anthracite			
	A32 black			

\* only available in - uniquement disponible en - enkel beschikbaar in 300 x 300 cm

### UCANT CANOPY - TOILE - DOEK

		300 x 200	300 x 300	ø 350
	C001 natural	€ 395	€ 495	€ 495
	C010 latte			
	C101 cloud			
	C106 gris nature			
	C204 night			
	C208 black			
	C211 steel	€ 895	€ 995	€ 995
	C212 gasoline <b>NEW</b>			
	C304 walnut			
	C301 taupe			
	C409 brick			
	C424 spinach			
	C402 tangerine			
	C417 jeans			

Free pick: other fabrics on demand - autres tissus sur demande - andere stoffen op aanvraag

### UB BASE - PARASOLVOET

	ANT-125-B03 / B32 concrete base	€ 695
	ANT-125CA-G04 silk grey granite	€ 745
OPTIONAL	ANT-EW60-G04 silk grey granite tiles - tuiles - tegels (p.38)	€ 595
	ANT-125-G13 sandstone	€ 895
	ANT-125-G32 black granite	€ 895

IGB-FP-5G-MEDIUM in ground base - ancre de sol - grondanker	€ 245
OGB-FP-5G-MEDIUM on ground base - plaque de fixation - bevestigingsplaat	€ 125

### UP COVER - HOUSSE - HOES

ANT-M-X75 grey	€ 75
----------------	------

### UA ACCESSORIES - ACCESSOIRES

LUN-LED02 Luna LED light - lumière - verlichting	€ 175
--	-------

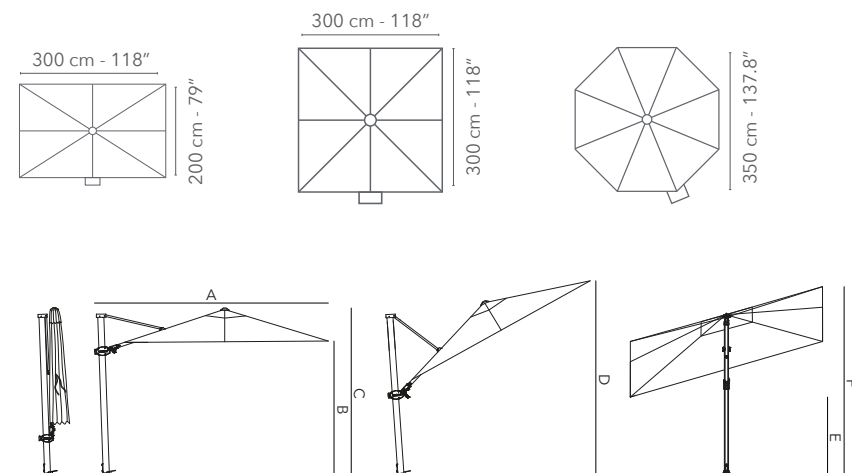

	300 X 200 CM	300 X 300 CM	Ø 350 CM
	33 kg - 72.8 lbs nett excl. base - voet	34 kg - 75 lbs nett excl. base - voet	35 kg - 77.1 lbs nett excl. base - voet
A	275 cm - 108.3"	375 cm - 147.6"	427 cm - 168.1"
B	203 cm - 79.9"	203 cm - 79.9"	188 cm - 74"
C	262 cm - 103.1"	262 cm - 103.1"	261 cm - 102.8"
D	280 cm - 110"	355 cm - 139.8"	441 cm - 173.6"
E	130 cm - 51.2"	130 cm - 51.2"	130 cm - 51.2"
F	300 cm - 118.1"	300 cm - 118.1"	375 cm - 92.5"

# KINGSTON

Free pole frame, aluminium powder coated.  
Mât déporté, aluminium thermolaqué.  
Vrijhangende parasol, aluminium gepoederlakt.

Canopy is weatherproof and colour resistant.  
Toile est résistant aux intempéries et aux couleurs.  
Doek is weerbestendig en kleurvast.

Tilt in height, rotation 360°.  
Inclinable à gauche et à droite, rotation de 360°.  
Kantelen in de hoogte, 360° rotatie.

max. 45 km/h, 28 mph



## KINGSTON

### UFKIN FRAME - STRUCTURE

400 x 300 400 x 400

	A01 white		A30 anthracite	€ 1.995	€ 2.195
	A32 black				

### UCKIN CANOPY - TOILE - DOEK

400 x 300 400 x 400

	C001 natural		C010 latte	€ 535	€ 645
	C101 cloud		C106 gris nature		
	C204 night		C208 black		
	C211 steel		C212 gasoline NEW		
	C301 taupe		C304 walnut	€ 1.295	€ 1.495
	C402 tangerine		C409 brick		
	C417 jeans		C424 spinach		

Free pick: other fabrics on demand - autres tissus sur demande - andere stoffen op aanvraag

### UB BASE - PARASOLVOET

	KIN-300-G04 silk grey granite	€ 1.395
	IGB-FP-LARGE in ground base - ancre de sol - grondanker	€ 265
	OGB-FP-LARGE on ground base - plaque de fixation - bevestigingsplaat	€ 145

### UP COVER - HOUSSE - HOES

KIN-L-X75 grey	€ 95
----------------	------

### UA ACCESSORIES - ACCESSOIRES

LUN-LED02 Luna LED light - lumière - verlichting	€ 175
--	-------

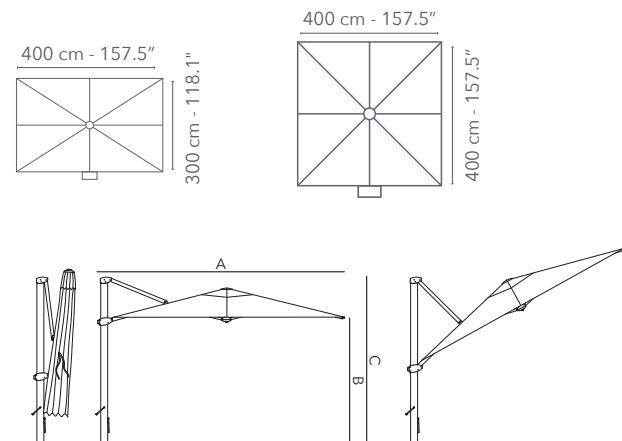

	400 X 300 CM	400 X 400 CM
	46 kg - 101.4 lbs nett excl. base - voet	54 kg - 119 lbs nett excl. base - voet
A	364 cm - 106.7"	464 cm - 182.7"
B	240 cm - 94.5"	240 cm - 94.5"
C	290 cm - 114.2"	290 cm - 114.2"
D	384 cm - 151.2"	364 cm - 143.3"



UBKIN-300-G04  
SILK GREY GRANITE

300 kg, 661.4 lbs  
100 x 100 x 10 cm  
36.4 x 36.4 x 2"  
incl. wheels - roues - wielen

Free pole frame, powder coated aluminium.  
Mât déporté, aluminium thermolaqué.  
Vrijhangende parasol, gepoederlakt aluminium.

Canopy is weatherproof and colour resistant.  
Toile est résistant aux intempéries et aux couleurs.  
Doek is weerbestendig en kleurvast.

Tilt in height, rotation 360°.  
Inclinable à gauche et à droite, rotation de 360°.  
Kantelen in de hoogte, 360° rotatie.

LIMA  
NEW

max. 45 km/h, 28 mph



## LIMA

### UFLIM FRAME - STRUCTURE 400 x 400

	A01 white		A03 linen	€ 2.495
	A30 anthracite		A32 black	

### UCLIM CANOPY - TOILE - DOEK 400 x 400

	C001 natural		C010 latte	€ 645
	C101 cloud		C106 gris nature	
	C204 night		C208 black	
	C211 steel		C212 gasoline	
	C301 taupe		C304 walnut	
	C402 tangerine		C409 brick	€ 1.495
	C417 jeans		C424 spinach	

Free pick: other fabrics on demand - autres tissus sur demande - andere stoffen op aanvraag

### UB BASE - PARASOLVOET

	KIN-300-G04 silk grey granite	€ 1.395
IGB-FP-LARGE in ground base - ancre de sol - grondanker		€ 265
OGB-FP-LARGE on ground base - plaque de fixation - bevestigingsplaat		€ 145

### UP COVER - HOUSSE - HOES

KIN-L-X75 grey	€ 95
----------------	------

### UA ACCESSORIES - ACCESSOIRES

LUN-LED02 Luna LED light - lumière - verlichting	€ 175
--	-------

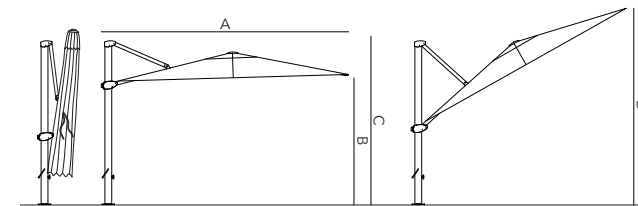
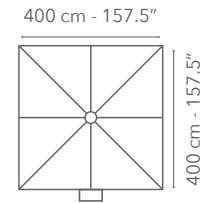

400 X 400 CM

	54 kg - 119 lbs nett excl. base - voet
A	464 cm - 182.7"
B	240 cm - 94.5"
C	290 cm - 114.2"
D	364 cm - 143.3"



UBLIM-300-G04  
SILK GREY GRANITE

300 kg, 661.4 lbs  
100 x 100 x 10 cm  
36.4 x 36.4 x 2"  
incl. wheels - roues - wielen

AMALFI

UPDATED

Mid pole frame, powder coated aluminium.  
Mât central, aluminium thermolaqué.  
Middenstam parasol, gepoederlakt aluminium.

Canopy is weatherproof and colour resistant.  
Toile est résistant aux intempéries et aux couleurs.  
Doek is weerbestendig en kleurvast.

Diameter of the pole: ø 40 mm, 1.6".  
Diamètre du mât : ø 40 mm, 1.6".  
Diameter van de mast: ø 40 mm, 1.6".



250 x 250 cm



300 x 300 cm



ø 300 cm



**UBELB-44**  
ELBA MEDIUM  
STAAL - ACIER

44 kg, 97 lbs  
54.5 x 54.5 x 1.8 cm,  
21.5 x 21.5 x 0.7"

incl. wheels - roues - wielen

**S01** white, **S03** linen, **S31** charcoal



**UBLUC-60**  
LUCCA HEAVY  
BETON

60 kg, 132.3 lbs  
59 x 59 x 8 cm  
23.2 x 23.2 x 3.1"

**B01** white, **B30** anthracite

optional: wheels - roues - wielen (p.35)



max. 39 km/h, 24 mph

## AMALFI

### UFAMA FRAME - STRUCTURE

250 x 250 300 x 300 ø 300

	A01 white		A03 linen	€ 745	€ 895	€ 745
	A12 alu teak		A30 anthracite			
	A32 black					

### UCAMA CANOPY - TOILE - DOEK

250 x 250 300 x 300 ø 300

	C001 natural		C010 latte	€ 365	€ 465	€ 365
	C101 cloud		C106 gris nature			
	C204 night		C208 black			
	C211 steel		C212 gasoline <b>NEW</b>			
	C301 taupe		C304 walnut			
	C402 tangerine		C409 brick	€ 645	€ 745	€ 645
	C417 jeans		C424 spinach			

Free pick: other fabrics on demand - autres tissus sur demande - andere stoffen op aanvraag

### UB BASE - PARASOLVOET

	ELB-44-S01 / -S03 / -S31 elba medium	€ 695
	LUC-60-B01 / -B30 lucca heavy	€ 245
OPTIONAL	UALUC-WHE.60 lucca heavy wheels - roues - wielen (p.38)	€ 85
IGB-MP-SMALL in ground base - ancre de sol - grondanker		€ 245

### UP COVER - HOUSSE - HOES

AMA-M-X75 grey	€ 75
----------------	------

### UA ACCESSORIES - ACCESSOIRES

LUN-LED02 Luna LED light - lumière - verlichting	€ 175
--	-------

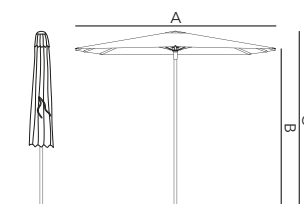
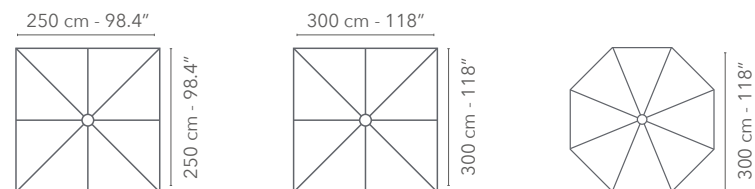

	250 X 250 CM	300 X 300 CM	Ø 300 CM
	14.9 kg - 32.8 lbs nett excl. base - voet	17 kg - 37.5 lbs nett excl. base - voet	17 kg - 37.5 lbs nett excl. base - voet
A	250 cm - 98.4"	300 cm - 118.1"	300 cm - 118.1"
B	216 cm - 85"	216 cm - 85"	216 cm - 85"
C	250 cm - 98.4"	250 cm - 98.4"	250 cm - 98.4"

# MALIBU

Mid pole frame, powder coated aluminium.  
Mât central, aluminium thermolaqué.  
Middenstam parasol, gepoederlakt aluminium.

Canopy is weatherproof and colour resistant.  
Toile est résistant aux intempéries et aux couleurs.  
Doek is weerbestendig en kleurvast.

Diameter of the pole: ø 38 mm, 1.5".  
Diamètre du mât : ø 38 mm, 1.5".  
Diameter van de mast: ø 38 mm, 1.5".



210 x 250 cm



200 x 200 cm



ø 250 cm



250 x 200 cm



240 x 240 cm



ø 300 cm



**UBLON-35**  
LONDON  
BETON

35 kg, 77.2 lbs  
ø 50 cm, 19.7"  
black - noir - zwart  
incl. wheels - roues - wielen



**MIB37NAP-1B**  
NAPOLI  
BETON

37 kg, 81.6 lbs  
50 x 50 x 3 cm  
19.7 x 19.7 x 1.2"  
black - noir - zwart  
optional: wheels - roues - wielen (p.39)



**UBCHI-50-B32**  
CHICAGO  
BETON

50 kg, 110.2 lbs  
ø 50 cm, 19.7"  
black - noir - zwart  
incl. wheels - roues - wielen



**UBLUC-25**  
LUCCA HALF  
BETON

25 kg, 55.1 lbs  
51 x 29 x 8 cm  
20 x 7 x 3.1"  
**B01** white, **B30** anthracite



**UBLUC-35**  
LUCCA LIGHT  
BETON

35 kg, 77.2 lbs  
45 x 45 x 8.5 cm  
17.7 x 17.7 x 3.3"  
**B01** white, **B30** anthracite  
optional: wheels - roues - wielen (p.39)



**UBELB-28**  
ELBA LIGHT  
STEEL - ACIER - STAAL

28 kg, 63.9 lbs  
49 x 49 x 1.6 cm,  
19.3 x 19.3 x 0.6"  
incl. wheels - roues - wielen  
**S01** white, **S31** charcoal

max. 17 km/h, 10.6 mph



## MALIBU fully assembled (excl. base)

UMMAL FRAME & CANOPY - STRUCTURE & TOILE - FRAME & DOEK		210 x 150	∅ 250 200 x 200	∅ 300 250 x 200	240 x 240
	A01C002 white & white	€ 245	€ 265	€ 295	€ 325
	A01C105 white & light grey				
	A01C418 white & ocean				
	A01C421 white & kiwi				
	A12C002 alu teak & white*				
	A12C109 alu teak & speckle*				
	A30C002 anthracite & white				
	A30C105 anthracite & light grey				
	A30C109 anthracite & speckle				
	A30C200 anthracite & dark grey				
	A30C302 anthracite & mocca				
	A30C405 anthracite & orange				
	A30C407 anthracite & red				
	A32C209 black & coal				

\*Only available in - Uniquement disponible en - Enkel beschikbaar in ∅ 300 cm, 250 x 200 cm, 240 x 240 cm.

### UB BASE - VOET

	LON-35 london	€ 115
	MIB37NAP-1B napoli <b>NEW</b>	€ 125
OPTIONAL	UANAP-WHE35 napoli wheels - roues - wielen <b>NEW</b>	€ 45
	CHI-50 chicago	€ 165
	LUC-25-B01 / -B30 lucca half	€ 165
	LUC-35-B01 / -B30 lucca light	€ 195
OPTIONAL	UALUC-WHE.35 lucca light wheels - roues - wielen	€ 55
	ELB-28-S01 / -S31 elba light	€ 495
IGB-MP-SMALL in ground base - grondanker - ancre de sol		€ 245
UP COVER - HOUSSE - HOES		
UMB-S-X75 grey		€ 65
UA ACCESSORIES - ACCESSOIRES		
LUN-LED02 Luna LED light - lumière - verlichting		€ 175

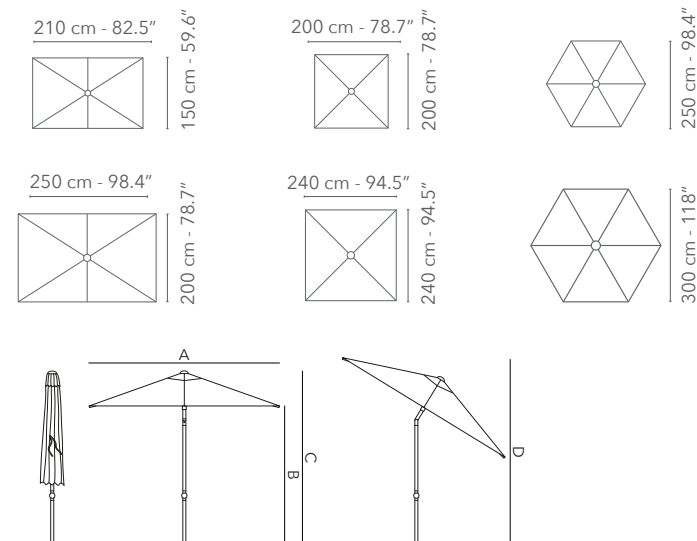

	210 X 150 CM	200 X 200 CM	∅ 250 CM
	5 kg - 11 lbs nett excl. base - voet	6 kg - 13.2 lbs nett excl. base - voet	5.5 kg - 12.1 lbs nett excl. base - voet
A	210 cm - 82.7"	200 cm - 78.7"	250 cm - 98.4"
B	195 cm - 76.8"	195 cm - 76.8"	195 cm - 76.8"
C	255 cm - 100.4"	255 cm - 100.4"	255 cm - 100.4"
D	245 cm - 96.5"	253 cm - 99.6"	255 cm - 100.4"
	250 X 200 CM	240 X 240 CM	∅ 300 CM
	6 kg - 13.2 lbs nett excl. base - voet	7 kg - 15.4 lbs nett excl. base - voet	7.2 kg - 15.9 lbs nett excl. base - voet
A	250 cm - 98.4"	240 cm - 94.5"	300 cm - 118.1"
B	195 cm - 76.8"	195 cm - 76.8"	195 cm - 76.8"
C	255 cm - 100.4"	255 cm - 100.4"	255 cm - 100.4"
D	255 cm - 100.4"	260 cm - 102.4"	275 cm - 108.3"

# CUBA

Mid pole frame, eucalyptus.  
Mât central, eucalyptus.  
Middenstam parasol, eucalyptus.

















Canopy is weatherproof and colour resistant.  
Toile est résistant aux intempéries et aux couleurs.  
Doek is weerbestendig en kleurvast.

Diameter of the pole: ø 61 mm, 2.4".  
Diamètre du mât : ø 61 mm, 2.4".  
Diameter van de mast: ø 61 mm, 2.4".

max. 39 km/h, 24.2 mph

## CUBA

<b>UFCUB FRAME - STRUCTURE</b>		<b>300 x 300</b>	<b>ø 350</b>
	<b>W60 eucalyptus</b>	€ 1.175	€ 1.175

<b>UCCUB CANOPY - TOILE - DOEK</b>		<b>300 x 300</b>	<b>ø 350</b>
	<b>C002 white</b>		<b>C105 light grey</b>
	<b>C001 natural</b>		<b>C101 cloud</b>
	<b>C106 gris nature</b>		<b>C204 night</b>
	<b>C208 black</b>		<b>C301 taupe</b>
	<b>C010 latte</b>		<b>C211 steel</b>
	<b>C304 walnut</b>		<b>C212 gasoline NEW</b>
	<b>C402 tangerine</b>		<b>C409 brick</b>
	<b>C417 jeans</b>		<b>C424 spinach</b>
<b>Free pick: other fabrics on demand - autres tissus sur demande - andere stoffen op aanvraag</b>		€ 995	€ 995
		€ 1.095	€ 1.095

### UB BASE - VOET

	<b>ELB-84-S01 / -S31 elba heavy</b>	€ 995
<b>IGB-MP-LARGE in ground base - ancre de sol - grondanker</b>		€ 245
<b>FFP-MP-LARGE on ground base - plaque de fixation - bevestigingsplaat</b>		€ 295

### UP COVER - HOUSSE - HOES

<b>CUB-M</b>	incl.
--------------	-------



300 x 300 cm & ø 350 cm

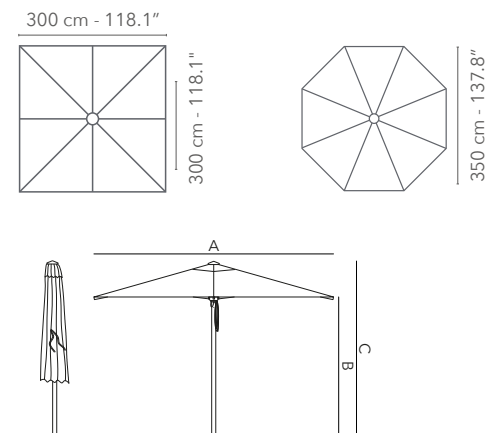

	300 X 300 CM	Ø 350 CM
	22 kg - 48.5 lbs nett excl. base - voet	22 kg - 48.5 lbs nett excl. base - voet
A	300 cm - 118.1"	350 cm - 137.8"
B	265 cm - 104.3"	234 cm - 92.1"
C	300 cm - 118.1"	365 cm - 143.7"



**UBELB-84**  
ELBA HEAVY  
STEEL - ACIER - STAAL

84 kg, 185.2 lbs  
75.5 x 75.5 x 1.8 cm  
29.7 x 29.7 x 0.7"  
incl. wheels - roues - wielen  
**S01 white, S31 charcoal**

Mid pole frame, teak scratched.  
Mât central, teck avec finition rayée  
Middenstam parasol, geborstelde teak.

Canopy is weatherproof and colour resistant.  
Toile est résistant aux intempéries et aux couleurs.  
Doek is weerbestendig en kleurvast.

Diameter of the pole: ø 61 mm, 2.4".  
Diamètre du mât : ø 61 mm, 2.4".  
Diameter van de mast: ø 61 mm, 2.4".

MOOREA

max. 39 km/h, 24.2 mph



















## MOOREA



### UFMOO FRAME - STRUCTURE 300 x 300

	<b>W63</b> teak scratched	€ 1.995
---	---------------------------	---------

### UCCUB CANOPY - TOILE - DOEK 300 x 300

	<b>C002</b> white		<b>C105</b> light grey	€ 495
	<b>C001</b> natural		<b>C101</b> cloud	€ 995
	<b>C106</b> gris nature		<b>C204</b> night	
	<b>C208</b> black		<b>C301</b> taupe	
	<b>C010</b> latte		<b>C211</b> steel	
	<b>C304</b> walnut		<b>C212</b> gasoline <b>NEW</b>	€ 1.095
	<b>C402</b> tangerine		<b>C409</b> brick	
	<b>C417</b> jeans		<b>C424</b> spinach	
<b>Free pick:</b> other fabrics on demand - andere stoffen op aanvraag - autres tissus sur demande				

### UB BASE - VOET

		<b>ELB-84-S01 / -S31</b> elba heavy	€ 995
<b>IGB-MP-LARGE</b> in ground base - ancre de sol - grondanker			€ 245
<b>FFP-MP-LARGE</b> on ground base - plaque de fixation - bevestigingsplaat			€ 295

### UP COVER - HOUSSE - HOES

<b>CUB-M</b>	incl.
--------------	-------



300 x 300 cm

Frame & canopy are supplied seperately to avoid stains.  
Structure & toile sont fournis séparément pour éviter les taches.  
Frame & doek worden apart geleverd om vlekken te voorkomen.

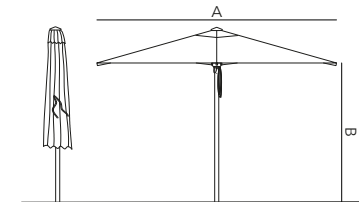
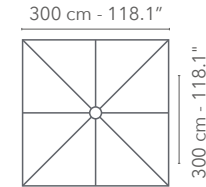

	300 X 300 CM
	28 kg - 61.7 lbs nett excl. base - voet
A	300 cm - 118.1"
B	238 cm - 93.7"
C	272 cm - 107.1"



### UBELB-84 ELBA HEAVY STEEL - ACIER

84 kg, 185.2 lbs  
75.5 x 75.5 x 1.8 cm  
29.7 x 29.7 x 0.7"  
incl. wielen - roues

**S01** white, **S31** charcoal

# BASES - PARASOLVOETEN

## UBAZO-125CA - SILK GREY GRANITE Azore

	125 kg, 275.6 lbs 80 x 80 x 5.5 cm, 31.5 x 31.5 x 2.2"	€ 645
	<b>G04</b> light grey granite, bush hammered lichtgrijze graniet, gebouchardeerd granit gris clair bouchardé  wheels - roues - wielen incl.	

## UBANT-125 - CONCRETE Antego

	125 kg, 275.6 lbs 92.5 x 92.5 x 5 cm, 36.4 x 36.4 x 2"	€ 695
	<b>B03</b> linen, <b>B32</b> black concrete - béton - beton  wheels - roues - wielen incl.	

## UBANT-125CA - SILK GREY GRANITE Antego

	125 kg, 275.6 lbs 92.5 x 92.5 x 5 cm, 36.4 x 36.4 x 2"	€ 745
	<b>G04</b> light grey granite, bush hammered granit gris clair bouchardé lichtgrijze graniet, gebouchardeerd  wheels - roues - wielen incl.	

	<b>UBANT-EW60-G04</b> 2 half tiles - 2 demi-tuiles - 2 halve tegels 2x 30 kg, 2x 66 lbs	€ 595
--	--	-------

## UBANT-125 - SANDSTONE Antego

	125 kg, 275.6 lbs 92.5 x 92.5 x 5 cm, 36.4 x 36.4 x 2"	€ 895
	<b>G13</b> Egyptian sandstone with sandblasted finish - Egyptische zandsteen met gezandstraalde afwerking - grès égyptien à finition sablée  wheels - roues - wielen incl.	



## UBANT-125 - BLACK GRANITE Antego

	125 kg, 275.6 lbs 92.5 x 92.5 x 5 cm, 36.4 x 36.4 x 2"	€ 895
	<b>G32</b> black granite, bush hammered zwarte graniet, gebouchardeerd granit noir bouchardé  wheels - roues - wielen incl.	

## UBLON-35 - LONDON Malibu

	35 kg, 77.2 lbs ø 50 cm, 19.7" tube: ø 58 mm, 2.3"	€ 115
	<b>B32</b> black concrete béton noir zwarte beton  wheels - roues - wielen incl.	

## MIB37NAP-1B - NAPOLI Malibu

	37 kg, 81.6 lbs 50 x 50 x 3 cm, 19.7 x 19.7 x 1.2" adaptor rings: ø 35, 38, 48 mm - 13.8, 14.8, 18.9"	€ 125
	<b>B32</b> black concrete béton noir zwarte beton	
	<b>UANAP-WHE35</b> Set 4 wheels - 4 roues - 4 wielen 4x ø 50 cm, 19.7"	€ 45

## UBCHI-50 - CHICAGO Malibu

	50 kg, 110.2 lbs ø 50 cm, 19.7" tube: ø 58 mm, 2.3"	€ 165
	<b>B32</b> black concrete béton noir zwarte beton  wheels - roues - wielen incl.	

## UBKIN-300 KINGSTON - LIMA

	300 kg, 661.4 lbs 100 x 100 x 10 cm, 39.4 x 39.4 x 4" tube: ø 45 mm, 1.7"	€ 1.395
	<b>G04</b> light grey granite, bush hammered lichtgrijze graniet, gebouchardeerd granit gris clair bouchardé  wheels - roues - wielen incl.	

## UBELB-28 - ELBA LIGHT Malibu

	28 kg, 63.9 lbs 49 x 49 x 1.6 cm, 19.3 x 19.3 x 0.6" tube: ø 45 mm, 1.8"	€ 495
	<b>S01</b> white, <b>S31</b> charcoal metallised & powder coated steel gemetalliseerd & gepoederlakt staal acier lacqué & poudré et métallisé  wheels - roues - wielen incl.	

## UBELB-44 - ELBA MEDIUM Amalfi



	44 kg, 97 lbs 54.5 x 54.5 x 1.8 cm, 21.5 x 21.5 x 0.7" tube: ø 55 mm, 2.2" adaptor ring: ø 40 mm, 1.6"	€ 695
	<b>S01</b> white, <b>S03</b> linen, <b>S31</b> charcoal metallised & powder coated steel acier lacqué & poudré et métallisé gemetalliseerd & gepoederlakt staal  wheels - roues - wielen incl.	

## UBELB-84 - ELBA HEAVY Cuba, Moorea



	84 kg, 185.2 lbs 75.5 x 75.5 x 1.8 cm 29.7 x 29.7 x 0.7" tube: ø 65 mm, 2.6"	€ 995
	<b>S01</b> white, <b>S31</b> charcoal metallised & powder coated steel gemetalliseerd & gepoederlakt staal acier lacqué & poudré et métallisé  wheels - roues - wielen incl.	

# BASES - PARASOLVOETEN

## UBLUC-25 - LUCCA HALF Malibu

 	25 kg, 55.1 lbs 51 x 29 x 8 cm, 20 x 7 x 3.1" tube: ø 25 - 44 mm, 1 - 1.7"	€ 165
	quick release systeem système de libération rapide snelspansysteem  adaptor rings incl.: ø 27 mm - 33 mm, ø 1.1" - 1.3"  <b>B01</b> white, <b>B30</b> anthracite concrete - béton - beton	

## UBLUC-35 - LUCCA LIGHT Malibu

 	35 kg, 77.2 lbs 45 x 45 x 8.5 cm, 17.7 x 17.7 x 3.3" tube: ø 25 - 44 mm, 1 - 1.7"	€ 195
	quick release systeem système de libération rapide snelspansysteem  adaptor rings incl.: ø 27 mm - 33 mm, ø 1.1" - 1.3"  <b>B01</b> white, <b>B30</b> anthracite concrete - béton - beton	

	<b>UALUC-WHE.35</b> Set 4 wheels - 4 roues - 4 wielen 4x ø 50 cm, 19.7"	€ 55
--	---	------

## UBLUC-60 - LUCCA HEAVY Amalfi

 	60 kg, 132.3 lbs 59 x 59 x 8 cm, 23.2 x 23.2 x 3.1" tube: ø 25 - 55 mm, 1 - 2.2"	€ 245
	adaptor rings incl.: ø 27 mm - 33 mm - 45 mm ø 1.1" - 1.3" - 1.8"  <b>B01</b> white, <b>B30</b> anthracite concrete - béton - beton	
	<b>UALUC-WHE.60</b> Set 4 wheels - 4 roues - 4 wielen 4x ø 50 cm, 19.7"	€ 85

## IN GROUND BASE - ANCRE DE SOL GRONDANKER

<b>UBIGB-MP-SMALL</b> Malibu, Amalfi		
	1 kg, 2.2 lbs ø 7 x 72 cm, 2.8 x 28" aluminium anodised - anodisé - geanodiseerd	€ 245
<b>UBIGB-MP-LARGE</b> Cuba, Moorea		
	15 kg, 33 lbs ø 7 x 67 cm, 2.8 x 26.4"  steel - acier - staal	€ 245
<b>UBIGB-AZO-4G-MEDIUM</b> Azore		
	5.7 kg, 12.6 lbs ø 21.5 x 51 cm, 8.5 x 20.1"  steel - acier - staal	€ 245
<b>UBIGB-FP-5G-MEDIUM</b> Antego		
	5.7 kg, 12.6 lbs ø 21.5 x 51 cm, 8.5 x 20.1"  steel - acier - staal	€ 245
<b>UBIGB-FP-LARGE</b> Kingston, Lima		
	8.4 kg, 18.5 lbs ø 25 x 51 cm, 9.8 x 20.1"  steel - acier - staal	€ 265

## ON GROUND BASE - PLAQUES DU FIXATION BEVESTIGINGSPLAAT

<b>UBOGB-MP-LARGE</b> Cuba, Moorea		
	8.4 kg, 18.5 lbs 30 x 30 x 44 cm, 11.8 x 11.8 x 17.3" aluminium anodised - anodisé - geanodiseerd	€ 295
<b>UBOGB-AZO-4G-MEDIUM</b> Azore		
	8 kg, 17.6 lbs ø 21.5 x 2.1 cm, 8.5 x 0.5"  steel - acier - staal	€ 125
<b>UBOGB-FP-5G-MEDIUM</b> Antego		
	8 kg, 17.6 lbs ø 21.5 x 2.1 cm, 8.5 x 0.5"  steel - acier - staal	€ 125
<b>UBOGB-FP-LARGE</b> Kingston, Lima		
	8 kg, 17.6 lbs ø 21.5 x 1.2 cm, 8.5 x 0.5"  steel - acier - staal	€ 145





OUTDOOR LIVING  
FURNITURE

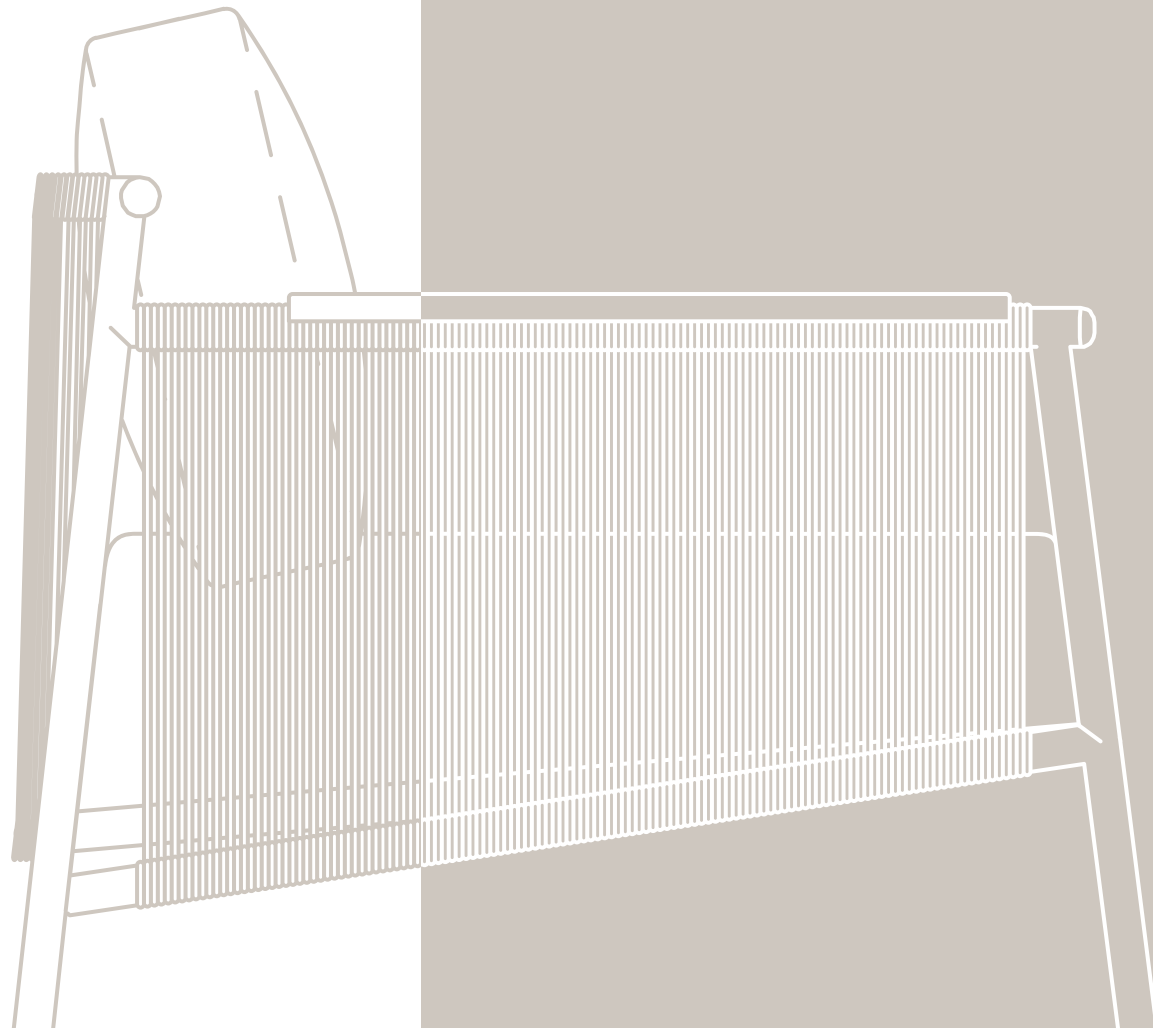

NOA

Teak frame with hand woven strap.  
Structure en teck avec sangles tissée à la main.  
Teak frame met handgeweven strap.





Seat with teak or Essegomma strap 50 mm  
Siège en teak ou sangles d'Essegomma 50 mm.  
Zitting van teak of Essegoma strap 50 mm.

Cushions are weatherproof and colour resistant.  
Coussins sont résistant aux intempéries et aux couleurs.  
Kussens zijn weerbestendig en kleurvast.

Table top in solid teak.  
Dessus de la table en teak massif.  
Tafelblad in massief teak.

**NEW**  
Designed by Enrique Marti

**DINING CHAIR**

	<b>FUNOANC08</b> frame - structure		<b>W62R11</b> teak & artichoke	€ 895
	<b>CUNOAD(N)AC08</b> cushions - coussins - kussens		<b>C015</b> brulé cat. B	€ 135
			<b>C111</b> truffle cat. B	



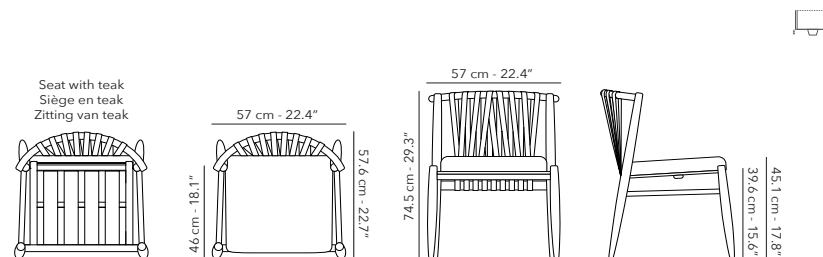

other fabrics - autres tissus - andere stoffen (p.101):  
cat. A € 125, cat. B € 135, cat. C € 145 & cat. D € 175.

cover - housse - hoes:  
€ 195



6.8 kg  
15 lbs

**DINING ARMCHAIR**

	<b>FUNOAAC08</b> frame - structure		<b>W62R11</b> teak & artichoke	€ 995
	<b>CUNOAD(N)AC08</b> cushions - coussins - kussens		<b>C015</b> brulé cat. B	€ 135
			<b>C111</b> truffle cat. B	

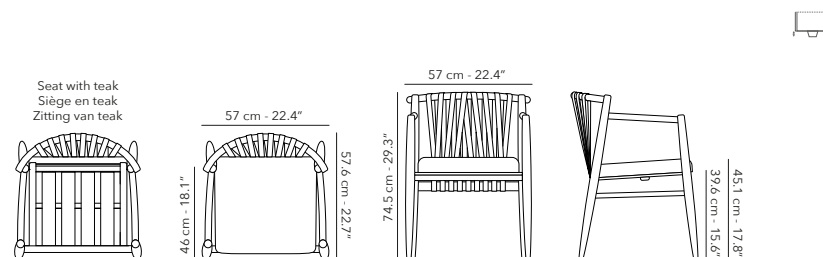

other fabrics - autres tissus - andere stoffen (p.101):  
cat. A € 125, cat. B € 135, cat. C € 145 & cat. D € 175.

cover - housse - hoes:  
€ 195



7.7 kg  
17 lbs



**DINING TABLE** 200 x 100 cm

	<p><b>FUNOADT43</b> frame - structure</p>		<p><b>W62 teak</b></p>	<p>€ 2.995</p>
---	---	---	------------------------	----------------

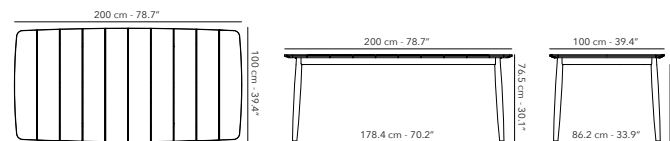
cover - housse - hoes:  
€ 345





**DINING TABLE** 270 x 100 cm

	<p><b>FUNOADT46</b> frame - structure</p>		<p><b>W62 teak</b></p>	<p>€ 3.995</p>
---	---	---	------------------------	----------------

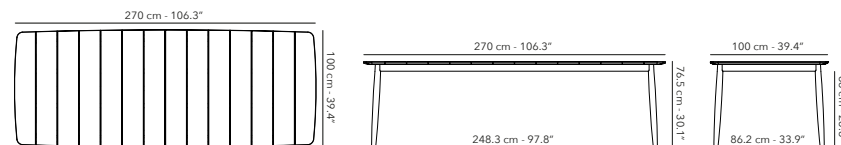
cover - housse - hoes:  
€ 495



**DINING TABLE** 340 x 100 cm

	<p><b>FUNOADT50</b> frame - structure</p>		<p><b>W62 teak</b></p>	<p>€ 4.995</p>
---	---	---	------------------------	----------------

cover - housse - hoes:  
€ 495

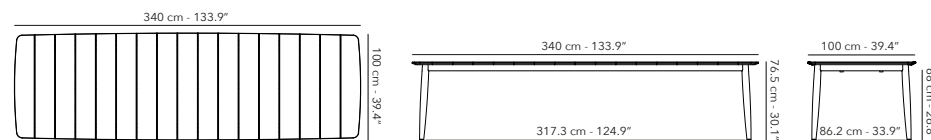

NOA

Teak frame with hand woven strap.  
Structure en teck avec sangles tissée à la main.  
Teak frame met handgeweven strap.





Seat with teak or Essegomma strap 50 mm  
Siège en teak ou sangles d'Essegomma 50 mm.  
Zitting van teak of Essegoma strap 50 mm.

Cushions are weatherproof and colour resistant.  
Coussins sont résistant aux intempéries et aux couleurs.  
Kussens zijn weerbestendig en kleurvast.

Table top in solid teak.  
Dessus de la table en teak massif.  
Tafelblad in massief teak.

**NEW**  
Designed by Enrique Marti

**LOUNGE CHAIR 1S**

	<b>FUNOA1S06</b> frame - structure		<b>W62R11</b> teak & artichoke	€ 1.695
	<b>CUNOA1S06</b> cushions - coussins - kussens		<b>C015</b> brulé cat. B	€ 725
			<b>C111</b> truffle cat. B	



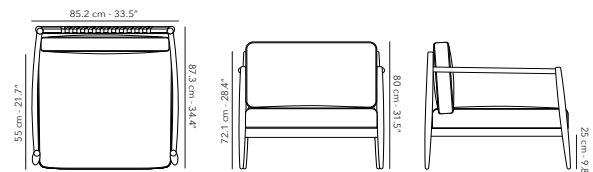

other fabrics - autres tissus - andere stoffen (p.101):  
cat. A € 675, cat. B € 725, cat. C € 730 & cat. D € 845.

cover - housse - hoes:  
€ 215

 20.2 kg  
44.5 lbs



**SOFA 2S**

	<b>FUNOA2S06</b> frame - structure		<b>W62R11</b> teak & artichoke	€ 2.695
	<b>2x CUNOA1S06</b> cushions - coussins - kussens		<b>C015</b> brulé cat. B	€ 1.395
			<b>C111</b> truffle cat. B	



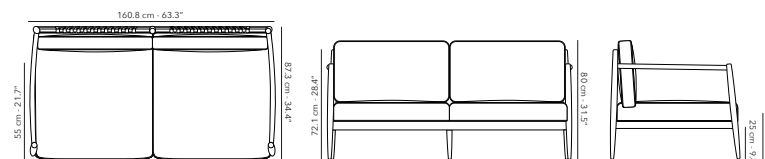

other fabrics - autres tissus - andere stoffen (p.101):  
cat. A € 1.315, cat. B € 1.395, cat. C € 1.425 & cat. D € 1.625.

cover - housse - hoes:  
€ 285

 36.4 kg  
80.3 lbs



**SOFA 3S**

	<b>FUNOA3S06</b> frame - structure		<b>W62R11</b> teak & artichoke	€ 3.695
	<b>3x CUNOA1S06</b> cushions - coussins - kussens		<b>C015</b> brulé cat. B	€ 1.995
			<b>C111</b> truffle cat. B	

other fabrics - autres tissus - andere stoffen (p.101):  
cat. A € 1.965, cat. B € 1.995, cat. C € 2.115 & cat. D € 2.420.

cover - housse - hoes:  
€ 350

 53.7 kg  
118.4 lbs

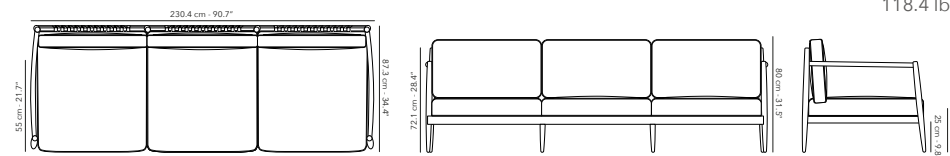

**COFFEE TABLE** 125 x 75 cm



**FUNOALT10**  
frame - structure

 **W62 teak**

€ 1.895

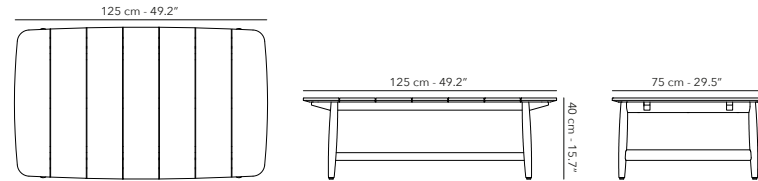

 23.5 kg  
51.8 lbs

**SIDE TABLE** 50 x 50 cm



**FUNOAST08**  
frame - structure

 **W62 teak**

€ 595



 6.4 kg  
14.1 lbs

**SOFA SIDE TABLE**



**FUNOASST01**  
frame - structure

 **W62 teak**

€ 495

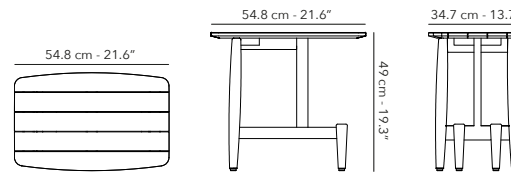

 4.3 kg  
9.5 lbs

NOA

**NEW**  
Designed by Enrique Marti





Teak frame with hand woven strap.  
Structure en teck avec sangles tissée à la main.  
Teak frame met handgeweven strap.

Seat with teak or Essegomma strap 50 mm  
Siège en teak ou sangles d'Essegomma 50 mm.  
Zitting van teak of Essegoma strap 50 mm.

Cushions are weatherproof and colour resistant.  
Coussins sont résistant aux intempéries et aux couleurs.  
Kussens zijn weerbestendig en kleurvast.

Table top in solid teak.  
Dessus de la table en teak massif.  
Tafelblad in massief teak.

**SUNLOUNGER**



	<b>FUNOASL06</b> frame - structure		<b>W62 teak</b>	€ 2.995
	<b>CUNOASL06</b> cushions - coussins - kussens	 	<b>C015 brûlé cat. B</b> <b>C111 truffle cat. B</b>	€ 695

other fabrics - autres tissus - andere stoffen (p.101):  
cat. A € 665, cat. B € 695, cat. C € 740 & cat. D € 895.

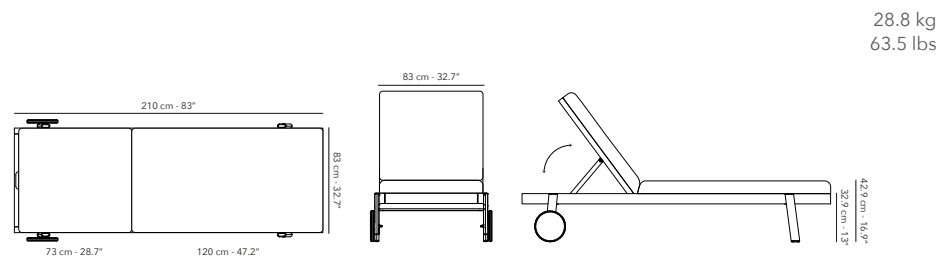
cover - housse - hoes:  
€ 295



**DIVIDER** H150 cm - H180 cm

	<b>FUNOADIV150 (low)</b> frame - structure		<b>W62R11</b> teak & artichoke	€ 1.995
	<b>FUNOADIV180 (high)</b> frame - structure		<b>W62R11</b> teak & artichoke	€ 2.495

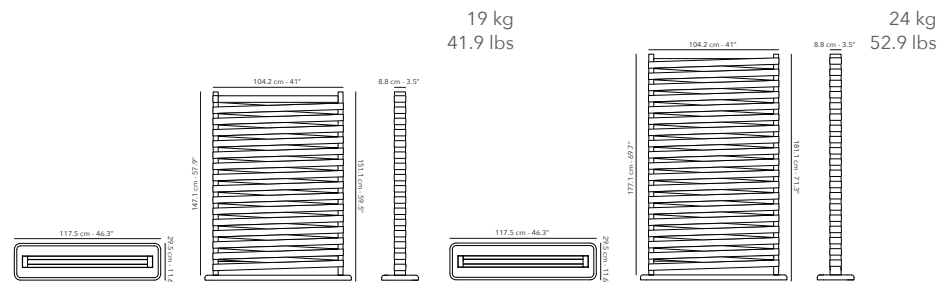



# NERO

## NEW





Black teak frame with hand woven rope.  
Cadre en teck noir avec corde tissée à la main.  
Zwart teak frame met handgeweven touw.

Cushions are weatherproof and colour resistant.  
Coussins sont résistant aux intempéries et aux couleurs.  
Kussens zijn weerbestendig en kleurvast.

Table top in solid teak.  
Dessus de la table en teak massif.  
Tafelblad in massief teak.

Corrector available to touch-up teak.  
Correcteur disponible pour retoucher le teck.  
Corrector beschikbaar om teak bij te werken.

### DINING ARMCHAIR

	<b>FUNERAC09</b> frame - structure		<b>W68R13</b> black teak & sand	€ 695
	<b>CUNERAC09</b> cushions - coussins - kussens		<b>C015</b> brûlé cat. B	€ 105
			<b>C111</b> truffle cat. B	

other fabrics - autres tissus - andere stoffen (p.101):  
cat. A € 115, cat. B € 105, cat. C € 135 & cat. D € 155.

cover - housse - hoes:  
€ 195

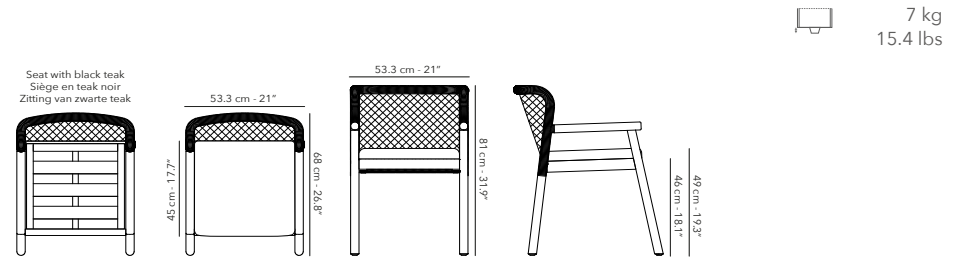



### DINING TABLE 240 x 100 cm

	<b>FUNERDT44</b> frame - structure		<b>W68</b> black teak	€ 2.745
---	---------------------------------------	---	-----------------------	---------

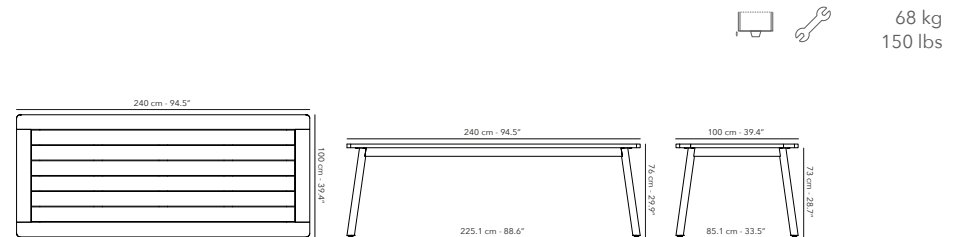
cover - housse - hoes:  
€ 395



### DINING TABLE 300 x 100 cm



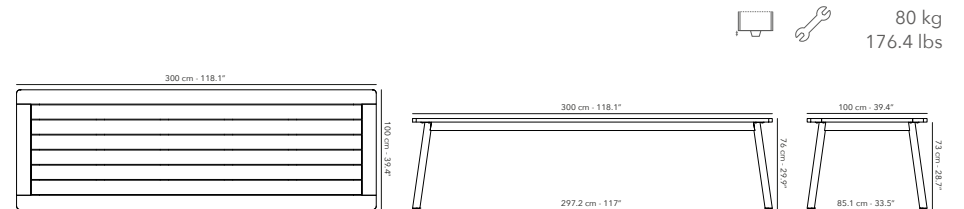

	<b>FUNERDT47</b> frame - structure		<b>W68</b> black teak	€ 3.245
---	---------------------------------------	---	-----------------------	---------

cover - housse - hoes:  
€ 445





**LOUNGE CHAIR 1S**

	<b>FUNER1S07</b> frame - structure		<b>W68R13</b> black teak & sand	€ 1.245
	<b>CUNER1S07</b> cushions - coussins - kussens		<b>C015</b> brulé cat. B	€ 450
			<b>C111</b> truffe cat. B	



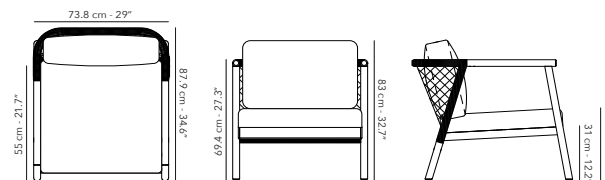

other fabrics - autres tissus - andere stoffen (p.101):  
cat. A € 535, cat. B € 450, cat. C € 580 & cat. D € 675.

cover - housse - hoes:  
€ 215

 15.1 kg  
33.3 lbs



**SOFA 2S**

	<b>FUNER2S07</b> frame - structure		<b>W68R13</b> black teak & sand	€ 2.245
	<b>CUNER2S07</b> cushions - coussins - kussens		<b>C015</b> brulé cat. B	€ 765
			<b>C111</b> truffe cat. B	



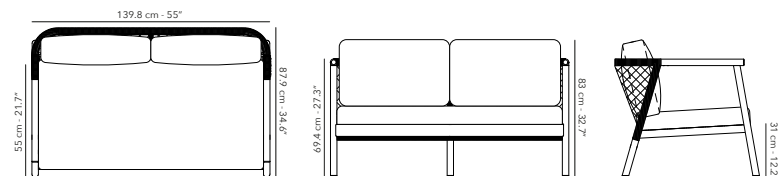

other fabrics - autres tissus - andere stoffen (p.101):  
cat. A € 895, cat. B € 765, cat. C € 965 & cat. D € 1.120.

cover - housse - hoes:  
€ 285

 26.5 kg  
58.4 lbs



**SOFA 3S**

	<b>FUNER3S07</b> frame - structure		<b>W68R13</b> black teak & sand	€ 3.245
	<b>CUNER3S07</b> cushions - coussins - kussens		<b>C015</b> brulé cat. B	€ 995
			<b>C111</b> truffe cat. B	

other fabrics - autres tissus - andere stoffen (p.101):  
cat. A € 1.165, cat. B € 995, cat. C € 1.275 & cat. D € 1.495.

cover - housse - hoes:  
€ 350

 37.7 kg  
83.1 lbs

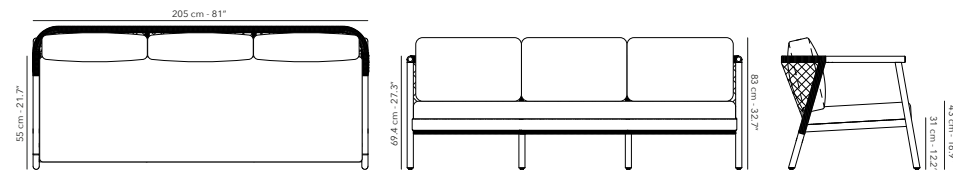

# NERO NEW

Black teak frame with hand woven rope.  
Cadre en teck noir avec corde tissée à la main.  
Zwart teak frame met handgeweven touw.

Cushions are weatherproof and colour resistant.  
Coussins sont résistant aux intempéries et aux couleurs.  
Kussens zijn weerbestendig en kleurvast.

Table top in solid teak.  
Dessus de la table en teak massif.  
Tafelblad in massief teak.

Corrector available to touch-up teak.  
Correcteur disponible pour retoucher le teck.  
Corrector beschikbaar om teak bij te werken.



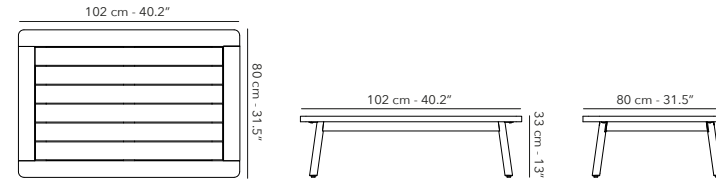

## COFFEE TABLE 120 x 80 cm

	<b>FUNERLT10</b> frame - structure		<b>W68</b> black teak	€ 1.245
---	---------------------------------------	---	-----------------------	---------



19.5 kg  
43 lbs

## SUNLOUNGER

	<b>FUNERSL07</b> frame - structure		<b>W68R13</b> black teak & sand	€ 1.845
	<b>CUNERSL07</b> cushions - coussins - kussens		<b>C015</b> brûlé cat. B	€ 545
		<b>C111</b> truffe cat. B		

other fabrics - autres tissus - andere stoffen (p.101):  
cat. A € 555, cat. B € 545, cat. C € 625 & cat. D € 765.

cover - housse - hoes:  
€ 295

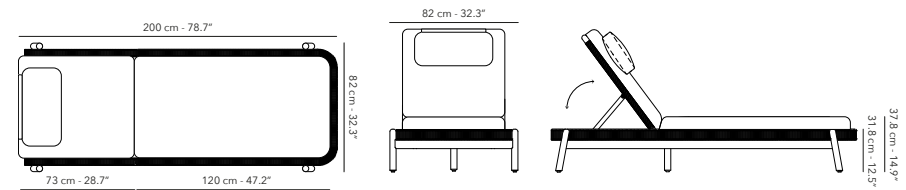

 35 kg  
77.2 lbs







Aluminium frame with hand woven wicker 6 mm.  
Structure en aluminium avec de l'osier 6 mm.  
Aluminium frame met handgeweven wicker 6 mm.

Seat with Essegomma strap 50 mm or (sable) teak.  
Sangles d'Essegomma 50 mm ou teak (sablé).  
Zitting van Essegomma strap 50 mm of (sable) teak.

Table top is made of (sable) solid teak or ceramic 12 mm.  
Dessus de la table est teck massif (sablé) ou céramique 12 mm.  
Tafelblad van (sable) massief teak of keramiek 12 mm.

## DINING CHAIR

	<b>FUTUGNC01</b> frame - structure	 <b>F16W62</b> cottage & teak	€ 645
		 <b>F16W64</b> cottage & sable teak	
	<b>CUTUGNC01</b> cushions - coussins - kussens	 <b>C008</b> linen cat. A	€ 105

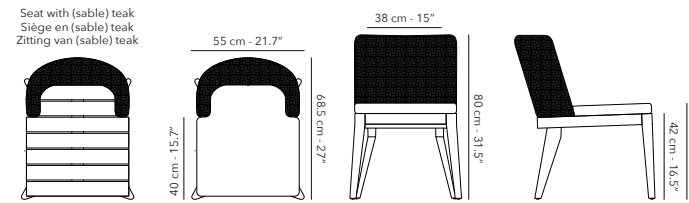

other fabrics - autres tissus - andere stoffen (p.101):  
cat. A € 130, cat. B € 140, cat. C € 160 &  
cat. D € on demand - sur demande - op aanvraag.

cover - housse - hoes:  
€ 195



9.7 kg  
21.4 lbs

## DINING ARMCHAIR

	<b>FUTUGAC05</b> frame - structure	 <b>F16</b> cottage	€ 745
	<b>CUTUGAC05</b> cushions - coussins - kussens	 <b>C008</b> linen cat. A	€ 105

other fabrics - autres tissus - andere stoffen (p.101):  
cat. A € 130, cat. B € 140, cat. C € 160 &  
cat. D € on demand - sur demande - op aanvraag.

cover - housse - hoes:  
€ 195

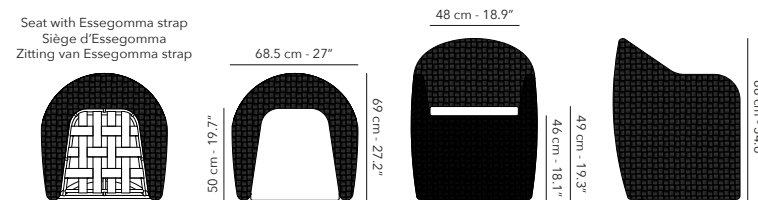

 14.8 kg  
32.6 lbs

**SOFA 1S**

	<b>FUTUG1S03</b> frame - structure		<b>F16 cottage</b>	€ 1.345
	<b>CUTUG1S03</b> cushions - coussins - kussens		<b>C008 linen cat. A</b>	€ 685

360° rotation through the swivel system. - 360° rotatie door het swivel systeem. - cover - housse - hoës: Rotation de 360° grâce au système de pivotement. € 215

other fabrics - autres tissus - andere stoffen (p.101):  
cat. A € 755, cat. B € 805, cat. C € 980 & cat. D € on demand - sur demande - op aanvraag.



30 kg  
66 lbs

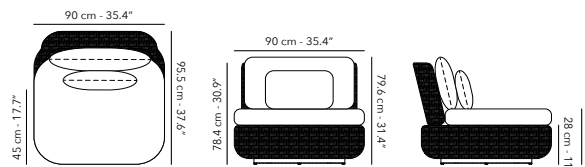

**SOFA 2S**

	<b>FUTUG2S03</b> frame - structure		<b>F16 cottage</b>	€ 1.595
	<b>CUTUG2S03</b> cushions - coussins - kussens		<b>C008 linen cat. A</b>	€ 1.125

other fabrics - autres tissus - andere stoffen (p.101):  
cat. A € 1.170, cat. B € 1.465, cat. C € 1.685 & cover - housse - hoës: cat. D € on demand - sur demande - op aanvraag € 285



41.5 kg  
91.5 lbs

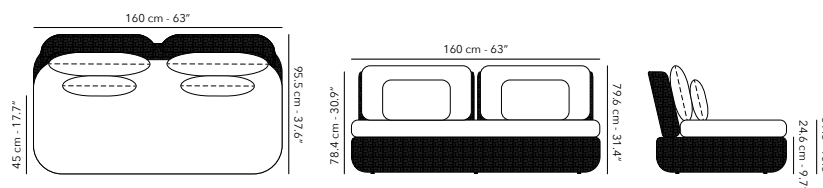

**SOFA 3S**

	<b>FUTUG3S03</b> frame - structure		<b>F16 cottage</b>	€ 2.245
	<b>CUTUG3S03</b> cushions - coussins - kussens		<b>C008 linen cat. A</b>	€ 1.695

other fabrics - autres tissus - andere stoffen (p.101):  
cat. A € 2.045, cat. B € 2.095, cat. C € 2.275 & cover - housse - hoës: cat. D € on demand - sur demande - op aanvraag € 350



60 kg  
132.3 lbs

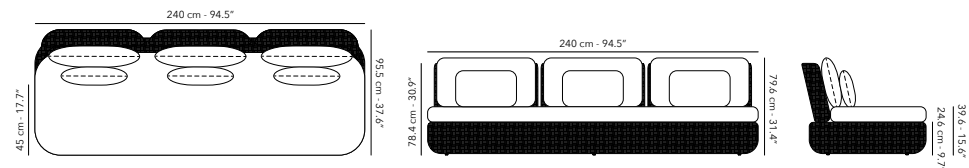



# TUGU

Aluminium frame with hand woven wicker 6 mm.  
Structure en aluminium avec de l'osier 6 mm.  
Aluminium frame met handgeweven wicker 6 mm.

Seat with Essegomma strap 50 mm or (sable) teak.  
Sangles d'Essegomma 50 mm ou teak (sablé).  
Zitting met Essegoma strap 50 mm of (sable) teak.

Table top is made of (sable) solid teak or ceramic 12 mm.  
Dessus de la table est teck massif (sablé) ou céramique 12 mm.  
Tafelblad van (sable) massief teak of keramiek 12 mm.

## OTTOMAN 90 x 90 cm

	<b>FUTUGOT01</b> frame - structure		<b>F16 cottage</b>	€ 795
	<b>CUTUGOT01</b> cushions - coussins - kussens		<b>C008 linen cat. A</b>	€ 465



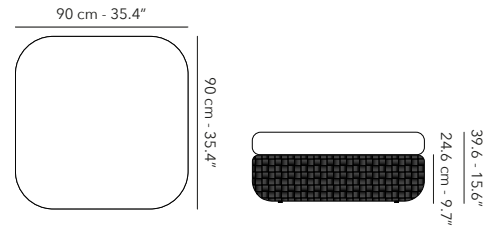

other fabrics - autres tissus - andere stoffen (p.101):  
cat. A € 495, cat. B € 585, cat. C € 680 &  
cat. D € on demand - sur demande - op aanvraag

cover - housse - hoes:  
€ 195



 13.7 kg  
30.2 lbs

## COFFEE TABLE ø 90 cm



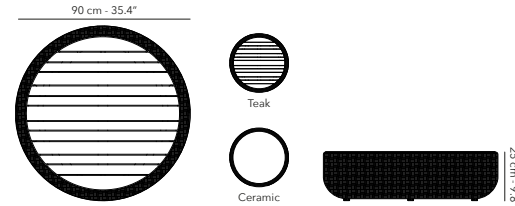

	<b>FUTUGLT08S</b> frame - structure		<b>F16 cottage</b>	choose table top choisissez le dessus kies tafelblad
	<b>FUTUGTOP04</b> Table top Dessus de la table Tafelblad		<b>W62 teak NEW</b>	€ 1.195
			<b>W64 sable teak</b>	€ 1.495
			<b>K14 taupegrey</b>	€ 1.495

cover - housse - hoes:  
€ 240



 13 kg  
28.6 lbs

## COFFEE TABLE ø 120 cm

	<b>FUTUGLT07S</b> frame - structure		<b>F16 cottage</b>	kies tafelblad choisissez le dessus choose table top
	<b>FUTUGTOP06</b> Table top Dessus de la table Tafelblad		<b>W62 teak NEW</b>	€ 1.595
			<b>W64 sable teak</b>	€ 1.995
			<b>K14 taupegrey</b>	€ 1.995

cover - housse - hoes:  
€ 275

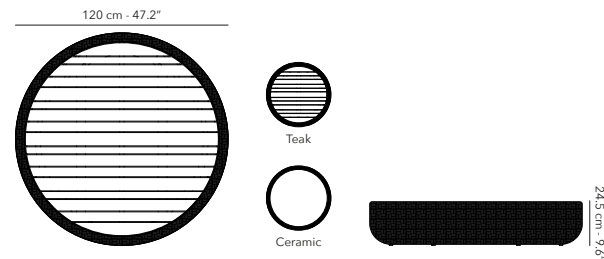

 19 kg  
42 lbs

**SUNLOUNGER**



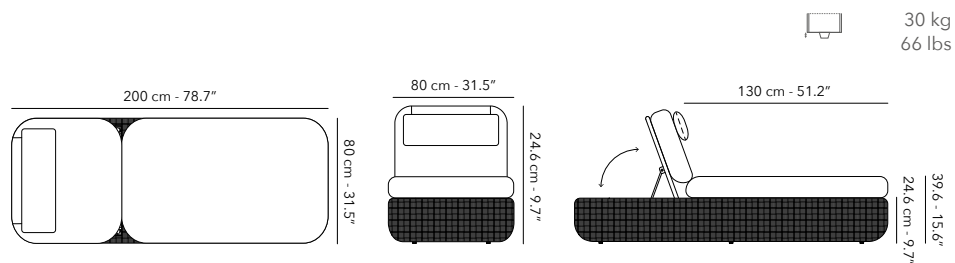

	<b>FUTUGSL02</b> frame - structure		<b>F16 cottage</b>	€ 1.595
	<b>CUTUGSL02</b> cushions - coussins - kussens		<b>C008 linen cat. A</b>	€ 775

other fabrics - autres tissus - andere stoffen (p.101):  
 cat. A € 835, cat. B € 940, cat. C € 1.045 &  
 cat. D € on demand - sur demande - op aanvraag

cover - housse - hoes:  
 € 295



**SIDE TABLE** ø 45 cm

	<b>FUTUGST05S</b> frame - structure		<b>F16 cottage</b>	kies tafelblad choisissez le dessus choose table top
	<b>FUTUGTOP05</b> Table top Dessus de la table Tafelblad		<b>W62 teak NEW</b>	
			<b>W64 sable teak</b>	

cover - housse - hoes:  
 € 195

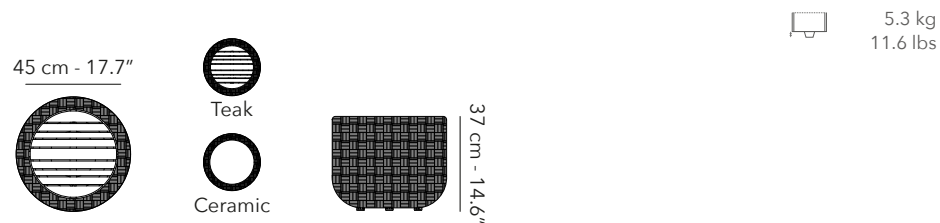

# LEGNA



Sable teak frame with hand woven rope 10 mm.  
Structure en teck sable avec cordage de 10 mm.  
Sable teak frame met handgeweven touw 10 mm.

Cushions are weatherproof and colour resistant.  
Coussins sont résistant aux intempéries et aux couleurs.  
Kussens zijn weerbestendig en kleurvast.

Table top is made of ceramic 12 mm.  
Dessus de la table est céramique 12 mm.  
Tafelblad van keramiek 12 mm.

Corrector available to touch-up teak.  
Correcteur disponible pour retoucher le teck.  
Corrector beschikbaar om teak bij te werken.

## DINING ARMCHAIR

	<b>FULEGAC06</b> frame - structure		<b>W64R12</b> sable teak & cream	€ 895
	<b>CULEGAC06</b> cushions - coussins - kussens		<b>C012</b> cream cat. B	€ 225

other fabrics - autres tissus - andere stoffen (p.101):  
cat. A € 240, cat. B € 260, cat. C € 285 &  
cat. D € on demand - sur demande - op aanvraag

cover - housse - hoes:  
€ 195

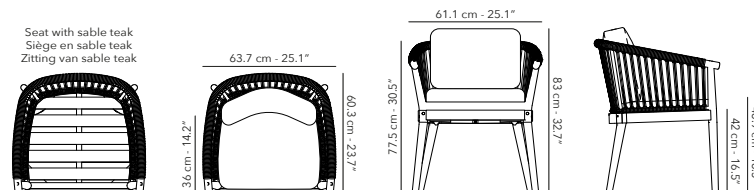





9.2 kg  
20.3 lbs







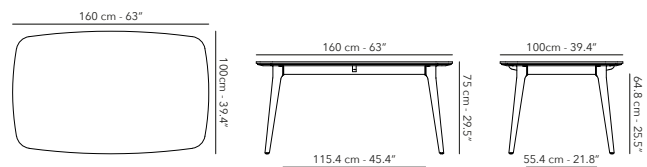

**DINING TABLE** 160 x 100 cm

	<b>FULEGDT41S</b> frame - structure		<b>W64</b> sable teak	€ 3.495
	<b>FULEGTOP41</b> table top dessus de la table tafelblad		<b>K14</b> taupegrey	
			<b>K01</b> white	
			<b>K31</b> charcoal	





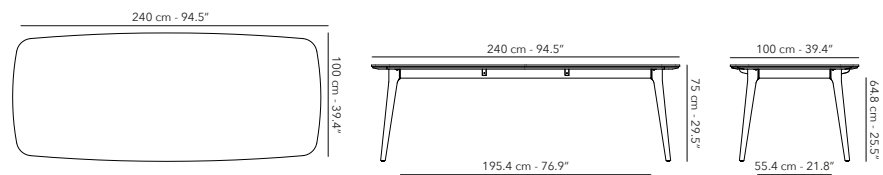

**DINING TABLE** 240 x 100 cm

	<b>FULEGDT44S</b> frame - structure		<b>W64</b> sable teak	€ 4.995
	<b>FULEGTOP44</b> table top dessus de la table tafelblad		<b>K14</b> taupegrey	
			<b>K01</b> white	
			<b>K31</b> charcoal	



**DINING TABLE** 320 x 100 cm

	<b>FULEGDT49S</b> frame - structure		<b>W64</b> sable teak	€ 5.995
	<b>FULEGTOP49</b> table top dessus de la table tafelblad		<b>K14</b> taupegrey	
			<b>K01</b> white	
			<b>K31</b> charcoal	

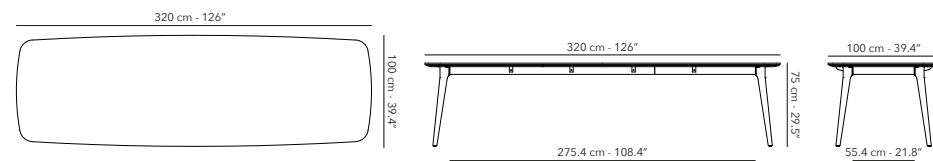

# LEGNA



Sable teak frame with hand woven rope 10 mm.  
Structure en teck sable avec cordage de 10 mm.  
Sable teak frame met handgeweven touw 10 mm.

Cushions are weatherproof and colour resistant.  
Coussins sont résistant aux intempéries et aux couleurs.  
Kussens zijn weerbestendig en kleurvast.

Table top is made of ceramic 12 mm.  
Dessus de la table est céramique 12 mm.  
Tafelblad van keramiek 12 mm.

Corrector available to touch-up teak.  
Correcteur disponible pour retoucher le teck.  
Corrector beschikbaar om teak bij te werken.

## LOUNGE CHAIR 1S



	<b>FULEG1S04</b> frame - structure		<b>W64R12</b> sable teak & cream	€ 1.595
	<b>CULEG1S04</b> cushions - coussins - kussens		<b>C012</b> cream cat. B	€ 575

other fabrics - autres tissus - andere stoffen (p.101):  
cat. A € 630, cat. B € 700, cat. C € 745 &  
cat. D € on demand - sur demande - op aanvraag

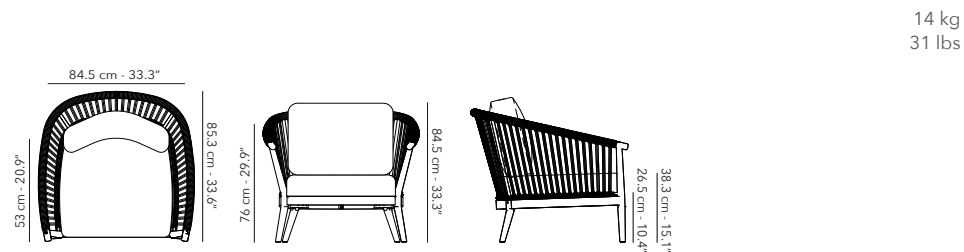
cover - housse - hoes:  
€ 215



## SOFA 2.5S



	<b>FULEG2S04</b> frame - structure		<b>W64R12</b> sable teak & cream	€ 2.495
	<b>CULEG2S04</b> cushions - coussins - kussens		<b>C012</b> cream cat. B	€ 1.445

other fabrics - autres tissus - andere stoffen (p.101):  
cat. A € 1.485, cat. B € 1.580, cat. C € 1.795 &  
cat. D € on demand - sur demande - op aanvraag

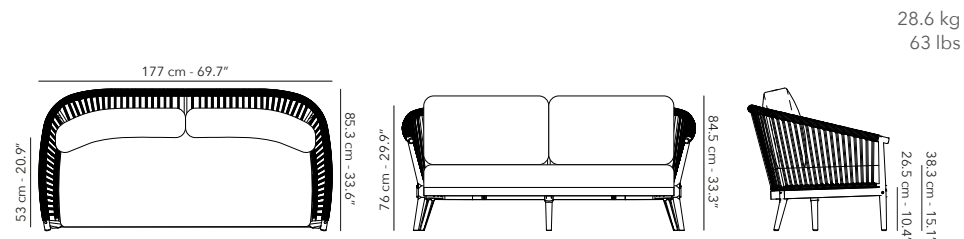
cover - housse - hoes:  
€ 285



## SOFA 3S

	<b>FULEG3S04</b> frame - structure		<b>W64R12</b> sable teak & cream	€ 2.695
	<b>CULEG3S04</b> cushions - coussins - kussens		<b>C012</b> cream cat. B	€ 1.995

other fabrics - autres tissus - andere stoffen (p.101):  
cat. A € 1.980, cat. B € 2.100, cat. C € 2.345 &  
cat. D € on demand - sur demande - op aanvraag

cover - housse - hoes:  
€ 350

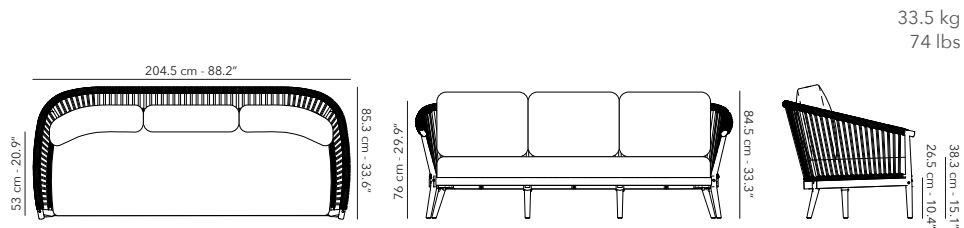

**CHAISE LONGUE**

	<b>FULEGCL03</b> frame - structure		<b>W64R12</b> sable teak & cream	€ 2.295
	<b>CULEGCL03</b> cushions - coussins - kussens		<b>C012</b> cream cat. B	€ 925

other fabrics - autres tissus - andere stoffen (p.101):  
cat. A € 1.020, cat. B € 1.125, cat. C € 1.240 &  
cat. D € on demand - sur demande - op aanvraag

cover - housse - hoes:  
€ 295

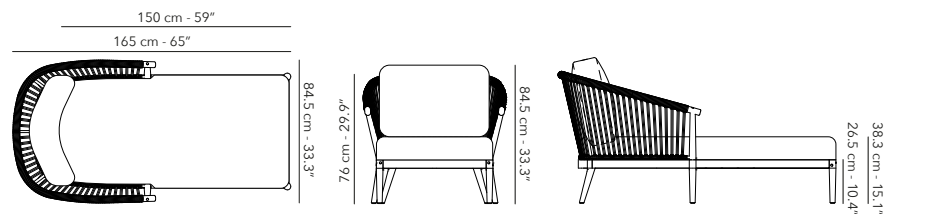

25.6 kg  
56.4 lbs

**COFFEE TABLE** 120 x 60 cm

	<b>FULEGLT09</b> frame - structure		<b>W64</b> sable teak	€ 795
--	---------------------------------------	--	-----------------------	-------

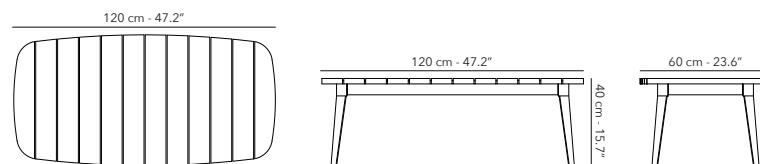

13.5 kg  
29.8 lbs

**SIDE TABLE** 50 x 35 cm

	<b>FULEGST07</b> frame - structure		<b>W64</b> sable teak	€ 395
--	---------------------------------------	--	-----------------------	-------

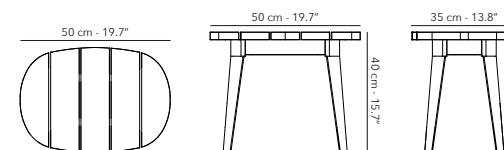

4 kg  
8.8 lbs





# SCOOP

UPDATED with new frame colour A01 white

Aluminium frame with hand woven rope.  
Structure en aluminium et corde tissée à la main.  
Aluminium frame met handgeweven touw.

Cushions are weatherproof and colour resistant.  
Coussins sont résistant aux intempéries et aux couleurs.  
Kussens zijn weerbestendig en kleurvast.

## LOUNGE CHAIR 1S

	<b>FUSCO1S05</b> frame - structure	 <b>A01R02 white silver NEW</b>	€ 1.595
		 <b>A14R14 lava brown</b>	
	<b>CUSCO1S05</b> cushions - coussins - kussens	 <b>C007 beige cat. B</b>	€ 665



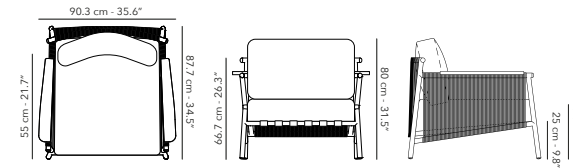

other fabrics - autres tissus - andere stoffen (p.101):  
cat. A € 660, cat. B € 700, cat. C € 730 &  
cat. D € on demand - sur demande - op aanvraag

cover - housse - hoes:  
€ 215



16.5 kg  
36.4 lbs

## SOFA 2S

	<b>FUSCO2S05</b> frame - structure	 <b>A01R02 white silver NEW</b>	€ 2.295
		 <b>A14R14 lava brown</b>	
	<b>CUSCO2S05</b> cushions - coussins - kussens	 <b>C007 beige cat. B</b>	€ 1.195



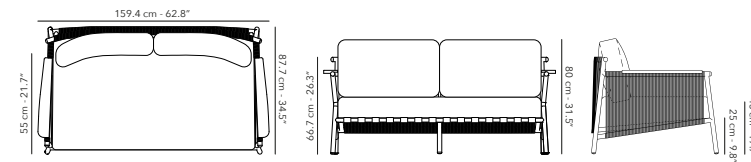

other fabrics - autres tissus - andere stoffen (p.101):  
cat. A € 1.115, cat. B € 1.235, cat. C € 1.355 &  
cat. D € on demand - sur demande - op aanvraag

cover - housse - hoes:  
€ 285



28.5 kg  
62.8 lbs

## SOFA 3S

	<b>FUSCO3S05</b> frame - structure	 <b>A01R02 white silver NEW</b>	€ 2.995
		 <b>A14R14 lava brown</b>	
	<b>CUSCO3S05</b> cushions - coussins - kussens	 <b>C007 beige cat. B</b>	€ 1.685

other fabrics - autres tissus - andere stoffen (p.101):  
cat. A € 1.570, cat. B € 1.770, cat. C € 1.970 &  
cat. D € on demand - sur demande - op aanvraag

cover - housse - hoes:  
€ 350

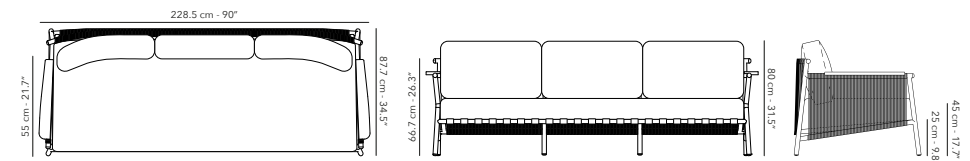

42.5 kg  
93.7 lbs







A01R02 & C007



A14R14 & C007

# SCOOP

## SUNLOUNGER

	<b>FUSCOSL05</b> frame - structure	 <b>A01R02 white silver NEW</b>	€ 2.295
		 <b>A14R14 lava brown</b>	
	<b>CUSCOSL05</b> cushions - coussins - kussens	 <b>C007 beige cat. B</b>	€ 595

other fabrics - autres tissus - andere stoffen (p.101):  
 cat. A € 575, cat. B € 680, cat. C € 785 &  
 cat. D € on demand - sur demande - op aanvraag

cover - housse - hoes:  
 € 295

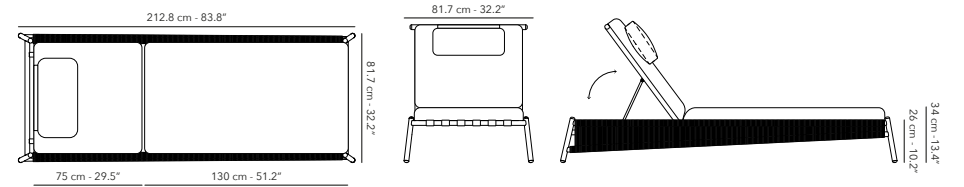

19 kg  
 42 lbs







# MAUROO

Aluminium frame. Each piece has a connector.  
 Structure en aluminium. Chaque pièce a une connecteur.  
 Aluminium frame. Elk meubelstuk heeft een connector.

Cushions are weatherproof and colour resistant.  
 Coussins sont résistant aux intempéries et aux couleurs.  
 Kussens zijn weerbestendig en kleurvast.

## LOUNGE CHAIR 1S



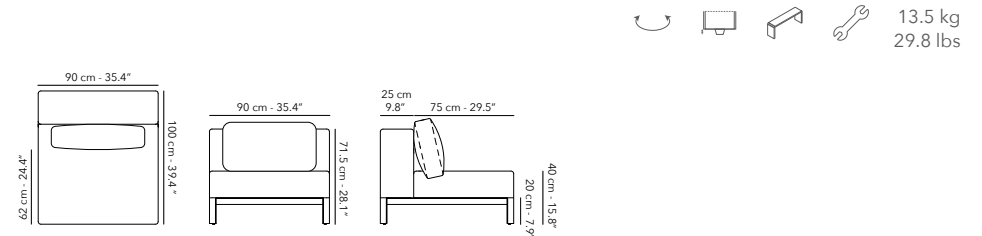

	<b>FUMAUMS02</b> frame - structure	 <b>A01 white</b>	€ 995
		 <b>A31 charcoal</b>	
	<b>CUMAUMS02</b> cushions - coussins - kussens	 <b>C006 vanilla cat. B</b>	€ 1.045
		 <b>C202 smoke grey cat. B</b>	

other fabrics - autres tissus - andere stoffen (p.101):  
 cat. A € 1.115, cat. B € 1.240, cat. C € 1.325 &  
 cat. D € on demand - sur demande - op aanvraag

**cover - housse - hoes:**  
 € 195



## SOFA 2S



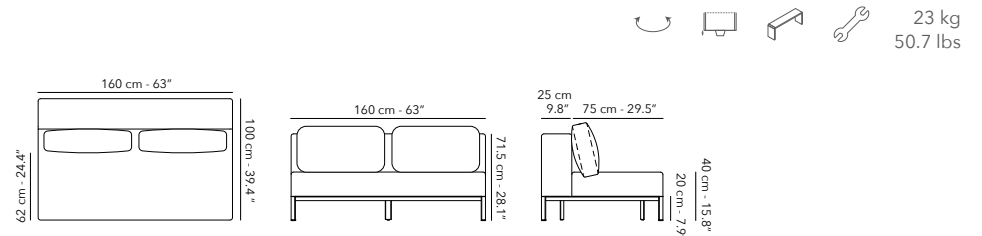

	<b>FUMAUDS02M</b> frame - structure	 <b>A01 white</b>	€ 1.625
		 <b>A31 charcoal</b>	
	<b>CUMAUDS02M</b> cushions - coussins - kussens	 <b>C006 vanilla cat. B</b>	€ 1.695
		 <b>C202 smoke grey cat. B</b>	

other fabrics - autres tissus - andere stoffen (p.101):  
 cat. A € 1.875, cat. B € 2.310, cat. C € 2.465 &  
 cat. D € on demand - sur demande - op aanvraag

**cover - housse - hoes:**  
 € 285



## LONG SOFA WITH TEAK TABLE

	<b>FUMAUDS02LRT</b> frame - structure	 <b>A01W62 white &amp; teak</b>	€ 2.995
		 <b>A31W62 charcoal &amp; teak</b>	
	<b>CUMAUDS02LR</b> cushions - coussins - kussens	 <b>C006 vanilla cat. B</b>	€ 1.995
		 <b>C202 smoke grey cat. B</b>	

The back fits on both sides. - Le dos s'adapte des deux côtés. -  
 De rug past aan beide kanten.

**cover - housse - hoes:**  
 € 350

other fabrics - autres tissus - andere stoffen (p.101):  
 cat. A € 2.055, cat. B € 2.310, cat. C € 2.465 & cat. D € on demand - sur demande - op aanvraag

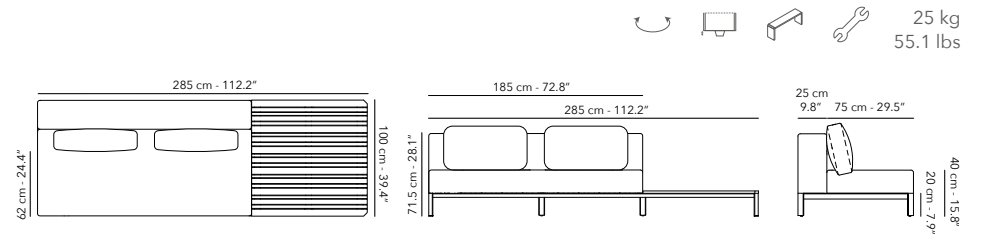



A01 & C006

A31 & C202

**LONG SOFA WITH TEAK TABLE & ARM**

	FUMAUDS02LRT FUMAARM01 frame - structure		A01W62 white & teak	€ 2.995
			A31W62 charcoal & teak	
	CUMAUDS02LRA cushions - coussins - kussens		C006 vanilla cat. B	€ 2.195
			C202 smoke grey cat. B	

The back fits on both sides. - Le dos s'adapte des deux côtés. -  
De rug past aan beide kanten.

**cover - housse - hoes:**  
€ 395

other fabrics - autres tissus - andere stoffen (p.101):

cat. A € 2.195, cat. B € 2.500, cat. C € 2.680 & cat. D € on demand - sur demande - op aanvraag

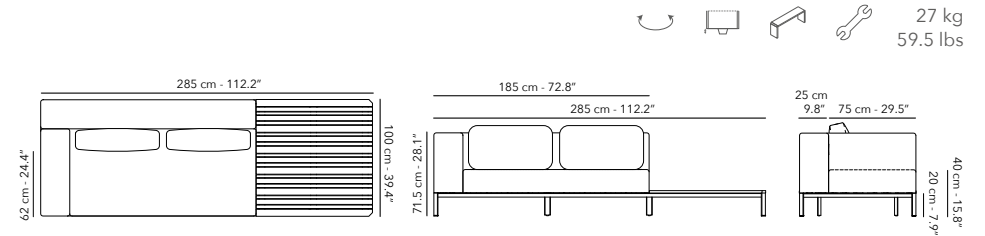

**CHAISE LONGUE**

	FUMAUCLO2LRT frame - structure		A01W62 white & teak	€ 2.395
			A31W62 charcoal & teak	
	CUMAUCLO2 cushions - coussins - kussens		C006 vanilla cat. B	€ 1.795
			C202 smoke grey cat. B	

The teak table top fits on both sides. - Le dessus de la table s'adapte des deux côtés. -  
- Het teak blad past aan beide kanten.

**cover - housse - hoes:**  
€ 295

other fabrics - autres tissus - andere stoffen (p.101):

cat. A € 1.950, cat. B € 2.160, cat. C € 2.300 & cat. D € on demand - sur demande - op aanvraag

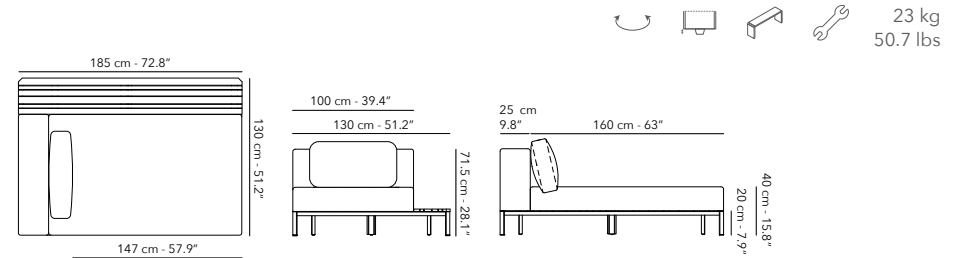

**COFFEE TABLE** 120 x 80 cm

	FUMAULT03 frame - structure		A01W62 white & teak	€ 1.495
			A31W62 charcoal & teak	

**cover - housse - hoes:**  
€ 250

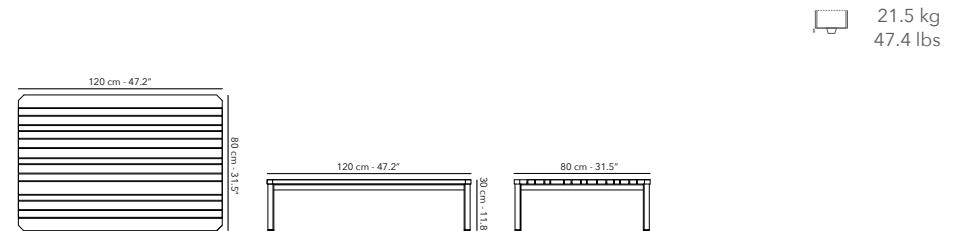



Concept 2 left, excl. arm



## CONCEPT 1

LEFT / RIGHT

frame - structure	1x FUMAUDS02LRT 1x FUMAUDS02M 1x FUMAULT03	 A01 white	€ 6.115
		 A31 charcoal	
cushions - coussins - kussens	1x CUMAUDS02LR 1x CUMAUDS02M	 C006 vanilla cat. B	€ 3.690
		 C202 smoke grey cat. B	

Covers available per module.  
Couvertures disponibles par module.  
Hoezen verkrijgbaar per module.

LEFT

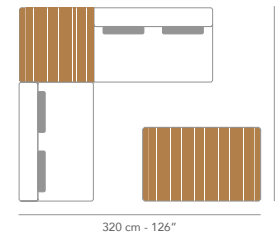



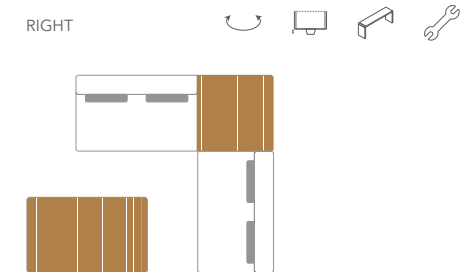

RIGHT



## CONCEPT 2

LEFT / RIGHT

frame - structure	1x FUMAUDS02LRT 1x FUMAUDS02M 1x FUMAUCLO2LRT 1x FUMAULT03	 A01 white	€ 8.510
		 A31 charcoal	
cushions - coussins - kussens	1x CUMAUDS02LR 1x CUMAUDS02M 1x CUMAUCLO2	 C006 vanilla cat. B	€ 5.485
		 C202 smoke grey cat. B	

Covers available per module.  
Couvertures disponibles par module.  
Hoezen verkrijgbaar per module.

LEFT

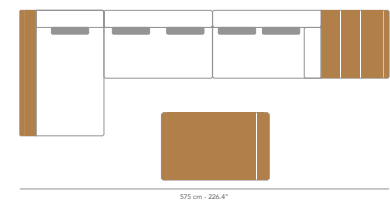



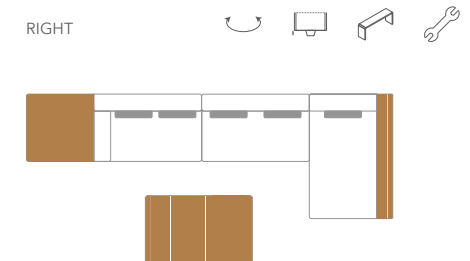

RIGHT



## CONCEPT 3

LEFT / RIGHT

frame - structure	2x FUMAUDS02LRT 1x FUMAUAARM01 1x FUMAUDS02M 1x FUMAULT03	 A01 white	€ 9.110
		 A31 charcoal	
cushions - coussins - kussens	1x CUMAUDS02LRA 1x CUMAUDS02LR 1x CUMAUDS02M	 C006 vanilla cat. B	€ 5.885
		 C202 smoke grey cat. B	

Covers available per module.  
Couvertures disponibles par module.  
Hoezen verkrijgbaar per module.

LEFT

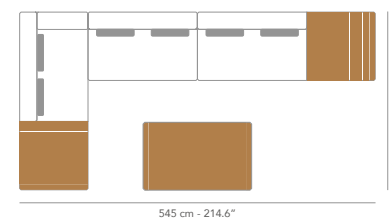

RIGHT

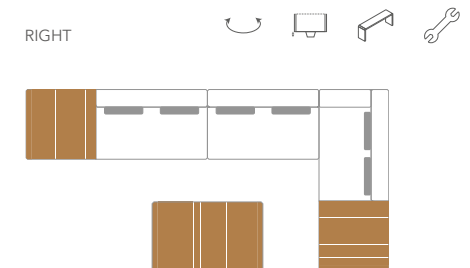

# TECCA

Solid teak frame.  
Structure en teck massif.  
Frame van massief teak.

Cushions are weatherproof and colour resistant.  
Coussins sont résistant aux intempéries et aux couleurs.  
Kussens zijn weerbestendig en kleurvast.



## DINING TABLE 160 x 80 cm

	FUTECDT41 frame - structure		W62 teak	€ 1.695
---	--------------------------------	---	----------	---------

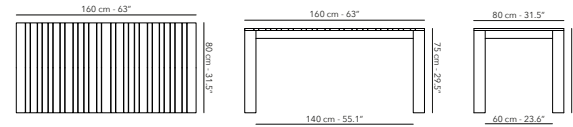
Ideal with **Tecca bench 130 x 38 cm**. Fits under the long sides of the table.  
Idéal avec **Tecca bench 130 x 38 cm**. S'adapte sous les côtés longs de la table.  
Ideaal met **Tecca bench 130 x 38 cm**. Past onder de lange zijden van de tafel.



## DINING TABLE 280 x 100 cm

	FUTECDT46 frame - structure		W62 teak	€ 3.495
---	--------------------------------	---	----------	---------

Ideal with **Tecca bench 130 x 38 cm**. Place two next to each other on the long sides of the table.  
Idéal avec le **Tecca bench 130 x 38 cm**. Placez-en deux l'un à côté de l'autre sur les côtés longs de la table.  
Ideaal met de **Tecca bench 130 x 38 cm**. Plaats er twee naast elkaar aan de lange zijden van de tafel.

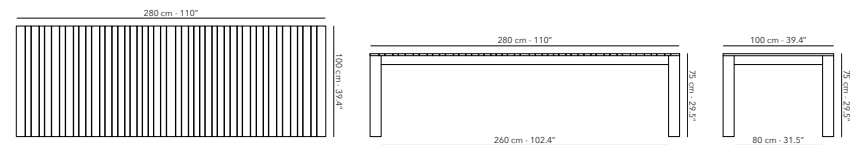



## DINING TABLE 350 x 100 cm

	FUTECDT48 frame - structure		W62 teak	€ 4.295
---	--------------------------------	---	----------	---------

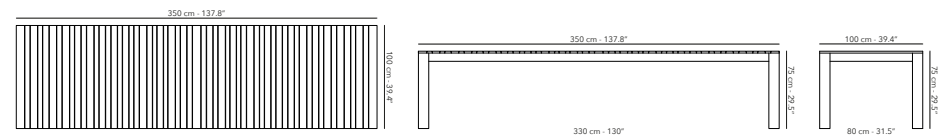
Ideal with **Tecca bench 320 x 38 cm**. Fits under the long sides of the table.  
Idéal avec le **Tecca bench 320 x 38 cm**. S'adapte sous les côtés longs de la table.  
Ideaal met de **Tecca bench 320 x 38 cm**. Past onder de lange zijden van de tafel.





**DINING TABLE** 160 x 160 cm

	<p><b>FUTECDT61</b> frame - structure</p>		<p><b>W62 teak</b></p>	<p>€ 2.995</p>
---	---	---	------------------------	----------------

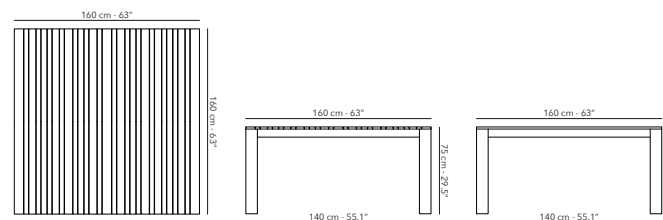
Ideal with **Tecca bench 130 x 38 cm**. Fits either side of the table.  
 Idéal avec le **Tecca bench 130 x 38 cm**. S'adapte à chaque côté de la table.  
 Ideaal met de **Tecca bench 130 x 38 cm**. Past aan elke zijde van de tafel.



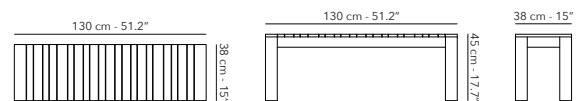

**BENCH** 130 x 38 cm

	<p><b>FUTECBE41</b> frame - structure</p>		<p><b>W62 teak</b></p>	<p>€ 795</p>
---	---	---	------------------------	--------------



**BENCH** 320 x 38 cm



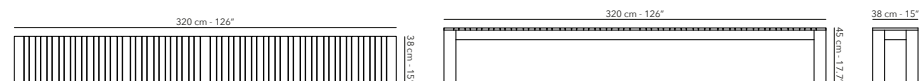

	<p><b>FUTECBE48</b> frame - structure</p>		<p><b>W62 teak</b></p>	<p>€ 2.245</p>
---	---	---	------------------------	----------------



Solid teak frame.  
Structure en teck massif.  
Frame van massief teak.

Cushions are weatherproof and colour resistant.  
Coussins sont résistant aux intempéries et aux couleurs.  
Kussens zijn weerbestendig en kleurvast.

SUNLOUNGER

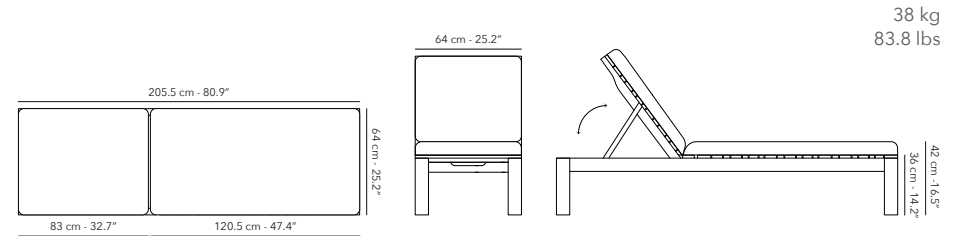

	<b>FUTECSL05</b> frame - structure		<b>W62</b> teak	€ 1.995
	<b>CUTECSL05</b> cushions - coussins - kussens		<b>C007</b> beige cat. B	
			<b>C205</b> ebony cat. B	€ 595

other fabrics - autres tissus - andere stoffen (p.101):  
cat. A € 555, cat. B € 680, cat. C € 780 &  
cat. D € on demand - sur demande - op aanvraag



38 kg  
83.8 lbs

YUNA DINING ARMCHAIR

	<b>FUYUNAC07</b> frame - structure		<b>A03R03</b> linen & linen	€ 595
			<b>A31R31</b> charcoal & charcoal	
	<b>CUYUNAC07</b> cushions - coussins - kussens		<b>C007</b> beige cat. B	€ 115
			<b>C205</b> ebony cat. B	

other fabrics - autres tissus - andere stoffen (p.101):  
cat. A € 130, cat. B € 140, cat. C € 160 &  
cat. D € on demand - sur demande - op aanvraag

cover - housse - hoes:  
€ 195

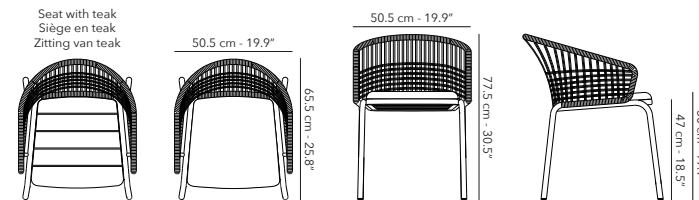

7.2 kg  
16 lbs



# NATURE

## UPDATED



Aluminium powder coated frame.  
Structure en aluminium thermolaqué.  
Aluminium gepoederlakt frame.

Table top is made of raw teak with a thickness of 50 mm.  
Le dessus de la table est en teck massif d'une épaisseur de 50 mm.  
Tafelblad is gemaakt van ruw teak met een dikte van 50 mm.

No piece is the same, each table top is unique.  
Aucune pièce n'est identique, chaque dessus de la table est unique.  
Geen enkel stuk is gelijk, elk tafelblad is uniek.

### LEWIS DINING ARMCHAIR



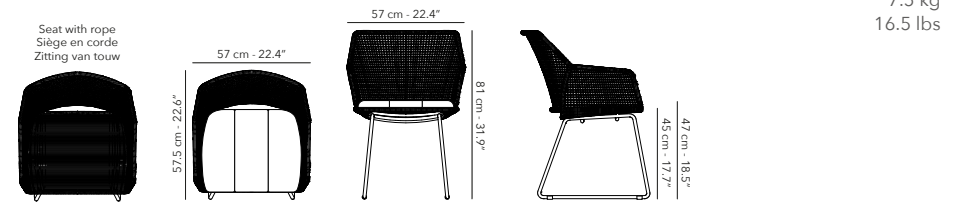

NEW

	<b>FULEWAC10</b> frame - structure		<b>A32R32</b> black & black	€ 545
	<b>CULEW(L)AC01</b> cushions - coussins - kussens		<b>C006</b> vanilla cat. B	€ 125

other fabrics - autres tissus - andere stoffen (p.101):  
cat. A € 110, cat. B € 125, cat. C € 125 & cat. D € 140







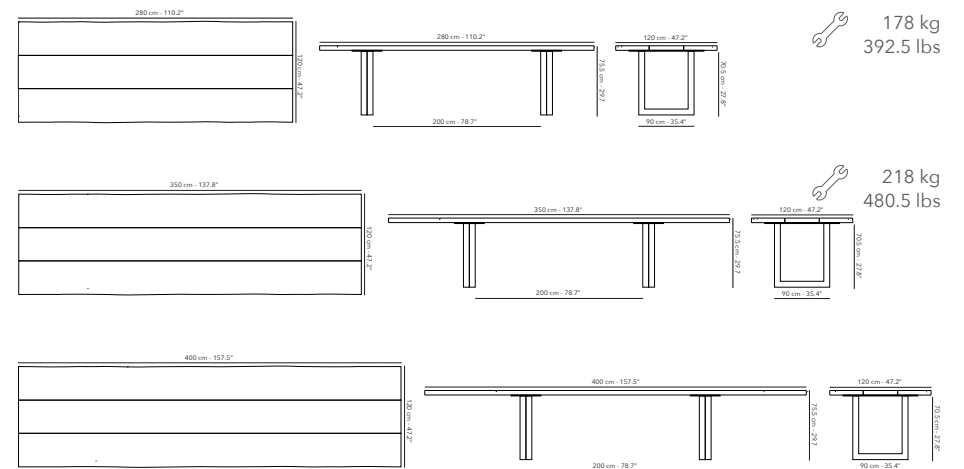

### DINING TABLE 280 x 120 cm - 350 x 120 cm - 400 x 120 cm, 75,5 cm height

	<b>FUNATDT46S</b> frame - structure		<b>A32</b> black	€ 6.295
	<b>FUNATTOP46</b> table top - dessus de la table - tafelblad		<b>W62</b> teak	
	<b>FUNATDT46S</b> frame - structure		<b>A32</b> black	€ 7.495
	<b>FUNATTOP48</b> table top - dessus de la table - tafelblad		<b>W62</b> teak	
	<b>FUNATDT46S</b> frame - structure		<b>A32</b> black	€ 8.495
	<b>FUNATTOP51</b> table top - dessus de la table - tafelblad		<b>W62</b> teak	



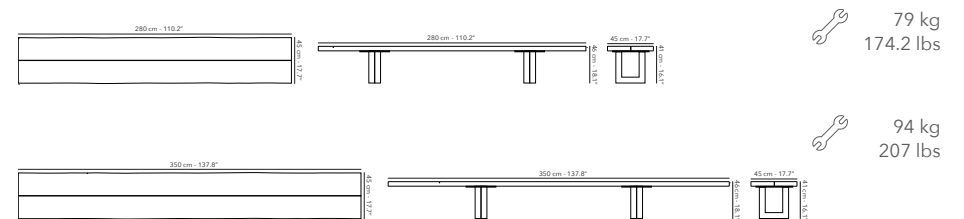

### BENCH 280 cm & 350 cm - 46 cm height

	<b>FUNATBE46S</b> frame - structure		<b>A32</b> black	€ 2.495
	<b>FUNATTOP46B</b> seat - siège - zitting		<b>W62</b> teak	
	<b>FUNATBE46S</b> frame - structure		<b>A32</b> black	€ 2.795
	<b>FUNATTOP48B</b> seat - siège - zitting		<b>W62</b> teak	



**LEWIS LOW DINING ARMCHAIR**

**NEW**

	<b>FULEWLAC01</b> frame - structure		<b>A32R32</b> black & black	€ 545
	<b>CULEW(L)AC01</b> cushions - coussins - kussens		<b>C006</b> vanilla cat. B	€ 125

other fabrics - autres tissus - andere stoffen (p.101):  
cat. A € 110, cat. B € 125, cat. C € 125 & cat. D € 140

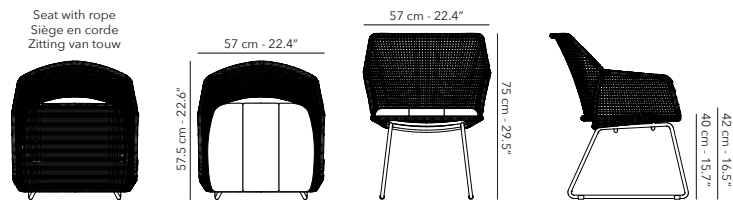

6.6 kg  
14.6 lbs

**LOW DINING TABLE** 280 x 120 - 350 x 120 cm - 400 x 120 cm, 67.5 cm height

**NEW**

	<b>FUNATLDT46S</b> frame - structure		<b>A32</b> black	€ 6.295
	<b>FUNATTOP46</b> table top - dessus de la table - tafelblad		<b>W62</b> teak	
	<b>FUNATLDT46S</b> frame - structure		<b>A32</b> black	€ 7.495
	<b>FUNATTOP48</b> table top - dessus de la table - tafelblad		<b>W62</b> teak	
	<b>FUNATLDT46S</b> frame - structure		<b>A32</b> black	€ 8.495
	<b>FUNATTOP51</b> table top - dessus de la table - tafelblad		<b>W62</b> teak	

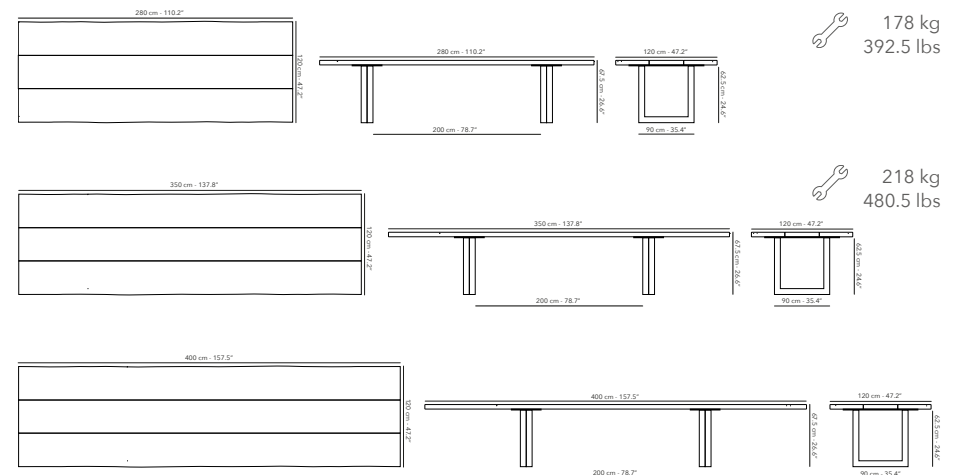



It is not possible to combine a low dining table with a Nature bench.  
Il n'est pas possible de combiner une table à manger basse avec un banc Nature.  
Niet mogelijk om een low dining tafel te combineren met een Nature bench.

Solid teak frame with anthracite 25 mm.  
 Structure en teck massif avec corde anthracite 25 mm.  
 Frame van massief teak met antraciet touw 25 mm.

Cushions are weatherproof and colour resistant.  
 Coussins sont résistant aux intempéries et aux couleurs.  
 Kussens zijn weersbestendig en kleurvast.

**DINING ARMCHAIR**

	<b>FUFLE-AC01</b> frame - structure		<b>W62R30</b> teak & anthracite strap	€ 795
	<b>CUFLEAC01</b> cushions - coussins - kussens		<b>C005</b> marble cat. C	€ 295



other fabrics - autres tissus - andere stoffen (p.101):  
 cat. A € 290, cat. B € 310, cat. C € 345 &  
 cat. D € on demand - sur demande - op aanvraag

cover - housse - hoes:  
 € 195

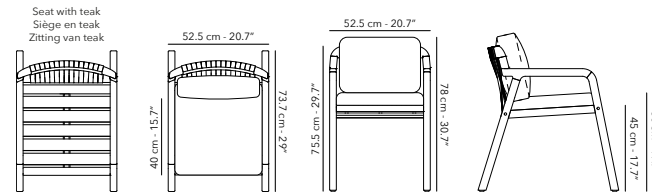
 14.5 kg  
 32 lbs



**BAR CHAIR**

	<b>FUFLE-BC01</b> frame - structure		<b>W62R30</b> teak & anthracite strap	€ 895
	<b>CUFLEAC01</b> cushions - coussins - kussens		<b>C005</b> marble cat. C	€ 295



other fabrics - autres tissus - andere stoffen (p.101):  
 cat. A € 290, cat. B € 310, cat. C € 345 &  
 cat. D € on demand - sur demande - op aanvraag

cover - housse - hoes:  
 € 240

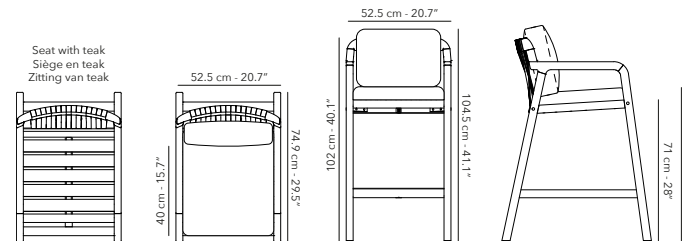
 19.5 kg  
 43 lbs



**COUNTER CHAIR**

	<b>FUFLE-CC01</b> frame - structure		<b>W62R30</b> teak & anthracite strap	€ 825
	<b>CUFLEAC01</b> cushions - coussins - kussens		<b>C005</b> marble cat. C	€ 295

other fabrics - autres tissus - andere stoffen (p.101):  
 cat. A € 290, cat. B € 310, cat. C € 345 &  
 cat. D € on demand - sur demande - op aanvraag

cover - housse - hoes:  
 € 230

 17.5 kg  
 38.6 lbs

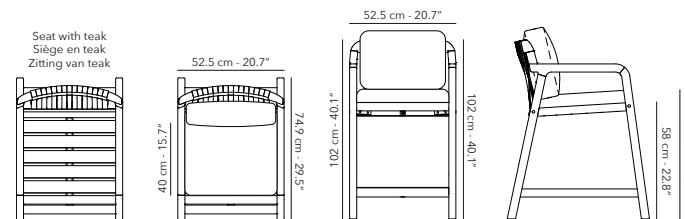



**DINING TABLE** 240 x 100 cm

	<b>FUFLE-DT44</b> frame - structure		<b>W62</b> teak	€ 2.695
--	--	--	-----------------	---------

cover - housse - hoes:  
€ 395

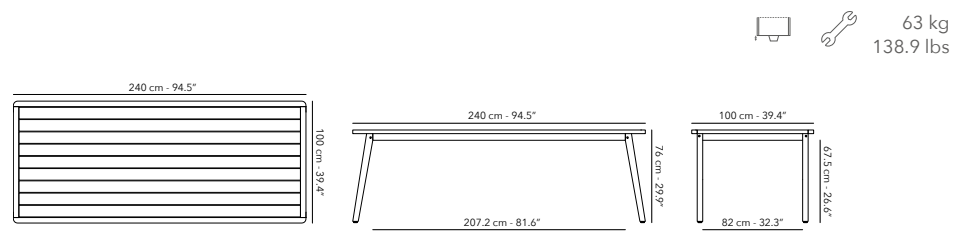

**DINING TABLE** 300 x 100 cm

	<b>FUFLE-DT47</b> frame - structure		<b>W62</b> teak	€ 3.235
--	--	--	-----------------	---------

cover - housse - hoes:  
€ 475

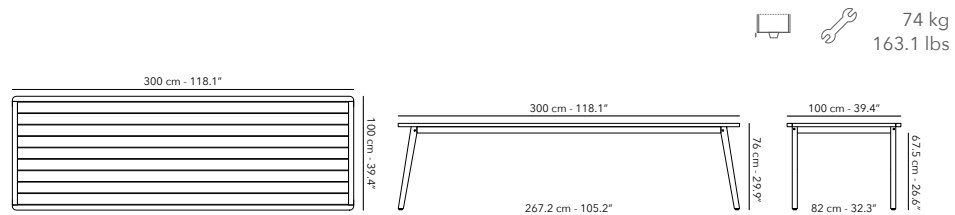

**BISTRO TABLE** 80 x 80 cm

	<b>FUFLE-BI23</b> frame - structure		<b>W62</b> teak	€ 725
--	--	--	-----------------	-------

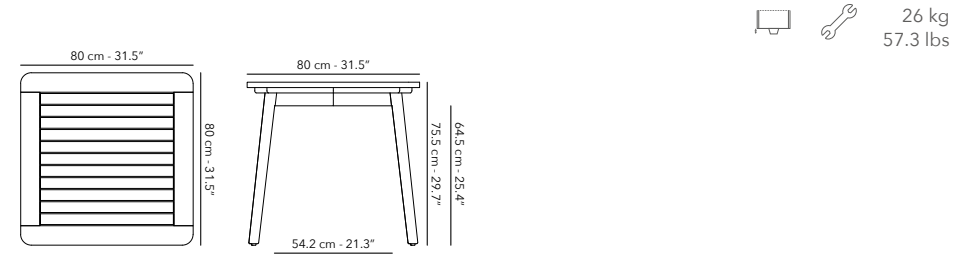

cover - housse - hoes:  
€ 205



Solid teak frame with anthracite 25 mm.  
 Structure en teck massif avec corde anthracite 25 mm.  
 Frame van massief teak met antraciet touw 25 mm.

Cushions are weatherproof and colour resistant.  
 Coussins sont résistant aux intempéries et aux couleurs.  
 Kussens zijn weersbestendig en kleurvast.

**BAR TABLE** 170 x 80 cm

	<p><b>FUFLE-BT01</b> frame - structure</p>		<p><b>W62</b> teak</p>	<p>€ 1.595</p>
---	--	---	------------------------	----------------

cover - housse - hoes:  
€ 330

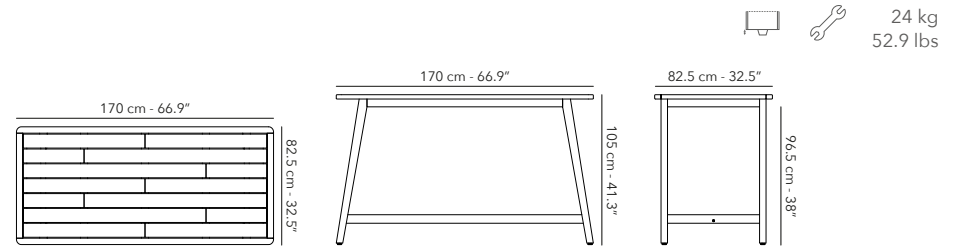



**COUNTER TABLE** 170 x 80 cm

	<p><b>FUFLE-CT01</b> frame - structure</p>		<p><b>W62</b> teak</p>	<p>€ 1.545</p>
---	--	---	------------------------	----------------

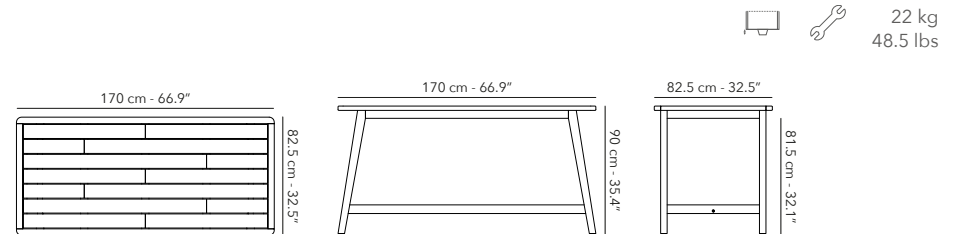
cover - housse - hoes:  
€ 295



**LOUNGE CHAIR 1S**

	<b>FUFLE-1S01</b> frame - structure		<b>W62R30</b> teak & anthracite strap	€ 1.195
	<b>CUFLE1S01</b> cushions - coussins - kussens		<b>C005 marble cat. C</b>	€ 845



other fabrics - autres tissus - andere stoffen (p.101):  
cat. A € 850, cat. B € 900, cat. C € 1.040 &  
cat. D € on demand - sur demande - op aanvraag

cover - housse - hoes:  
€ 215

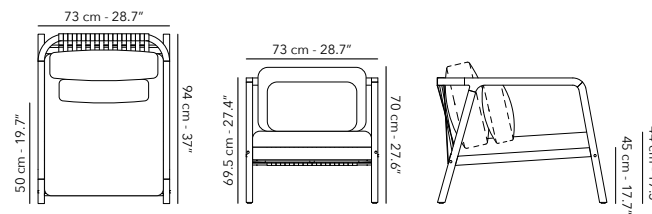
 20.5 kg  
45.2 lbs



**SOFA 2S**

	<b>FUFLE-2S01</b> frame - structure		<b>W62R30</b> teak & anthracite strap	€ 1.995
	<b>CUFLE2S01</b> cushions - coussins - kussens		<b>C005 marble cat. C</b>	€ 1.450



other fabrics - autres tissus - andere stoffen (p.101):  
cat. A € 1.485, cat. B € 1.570, cat. C € 1.780 &  
cat. D € on demand - sur demande - op aanvraag

cover - housse - hoes:  
€ 285

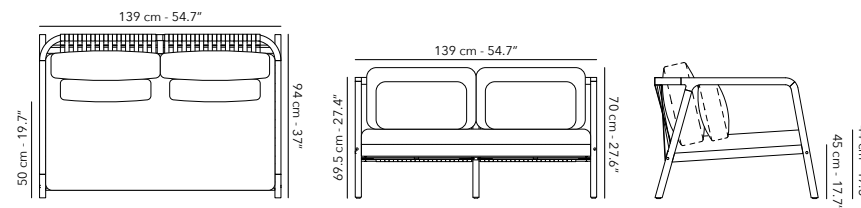
 32.5 kg  
71.7 lbs



**SOFA 3S**

	<b>FUFLE-3S01</b> frame - structure		<b>W62R30</b> teak & anthracite strap	€ 2.795
	<b>CUFLE3S01</b> cushions - coussins - kussens		<b>C005 marble cat. C</b>	€ 1.995

other fabrics - autres tissus - andere stoffen (p.101):  
cat. A € 1.980, cat. B € 2.095, cat. C € 2.345 &  
cat. D € on demand - sur demande - op aanvraag

cover - housse - hoes:  
€ 350

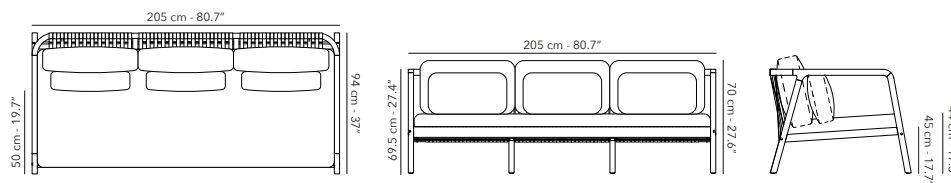

 45 kg  
99.2 lbs



Solid teak frame with anthracite 25 mm.  
 Structure en teck massif avec corde anthracite 25 mm.  
 Frame van massief teak met antraciet touw 25 mm.

Cushions are weatherproof and colour resistant.  
 Coussins sont résistant aux intempéries et aux couleurs.  
 Kussens zijn weersbestendig en kleurvast.

**COFFEE TABLE** 120 x 80 cm

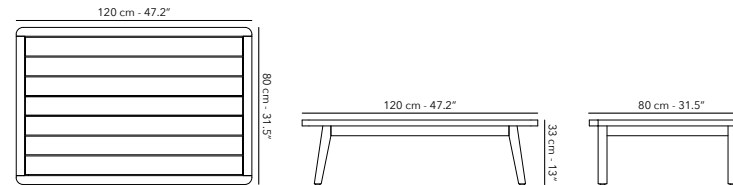

	<b>FUFLE-LT01</b> frame - structure		<b>W62 teak</b>	€ 1.095
---	--	---	-----------------	---------

cover - housse - hoes:  
€ 265





 26 kg  
57.3 lbs

**COFFEE TABLE** 120 x 120 cm

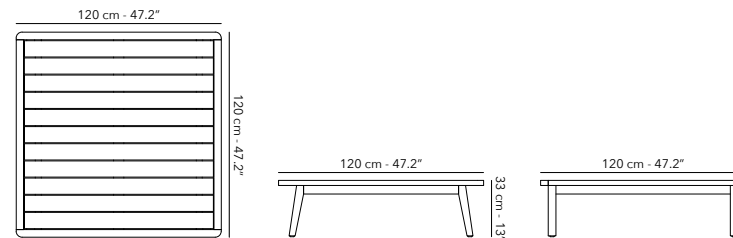

	<b>FUFLE-LT02</b> frame - structure		<b>W62 teak</b>	€ 1.495
---	--	---	-----------------	---------

cover - housse - hoes:  
€ 295



 34 kg  
75 lbs

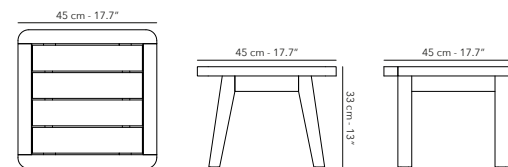

**SIDE TABLE** 45 x 45 cm

	<b>FUFLE-ST01</b> frame - structure		<b>W62 teak</b>	€ 495
---	--	---	-----------------	-------



 6 kg  
13.2 lbs

**SUNLOUNGER**



	<b>FUFLE-SL01</b> frame - structure		<b>W62R30</b> teak & anthracite strap	€ 1.895
	<b>CUFLESL01</b> cushions - coussins - kussens		<b>C005</b> marble cat. C	€ 695

other fabrics - autres tissus - andere stoffen (p.101):  
cat. A € 660, cat. B € 730, cat. C € 890 &  
cat. D € on demand - sur demande - op aanvraag

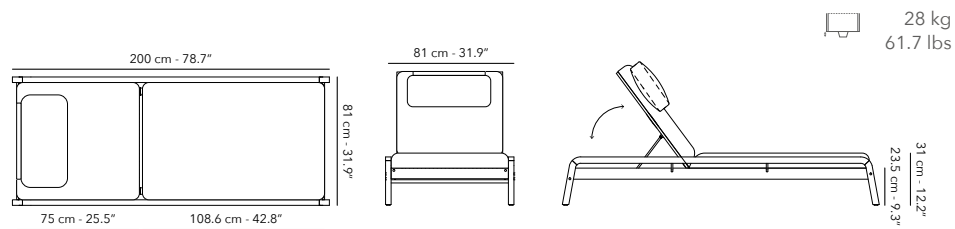
cover - housse - hoes:  
€ 295



**DAYBED**

	<b>FUFLEDB01</b> frame - structure		<b>W62R30</b> teak & anthracite strap	€ 2.995
	<b>CUFLEDB01</b> cushions - coussins - kussens		<b>C005</b> marble cat. C	€ 1.545





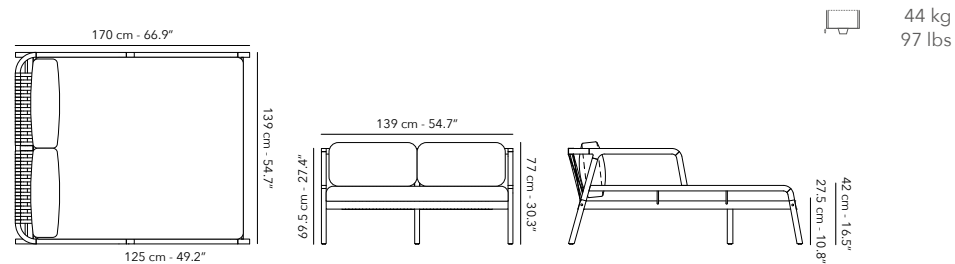

other fabrics - autres tissus - andere stoffen (p.101):  
cat. A € 1.570, cat. B € 1.770, cat. C € 1.990 &  
cat. D € on demand - sur demande - op aanvraag

cover - housse - hoes:  
€ 420



# VOLTE





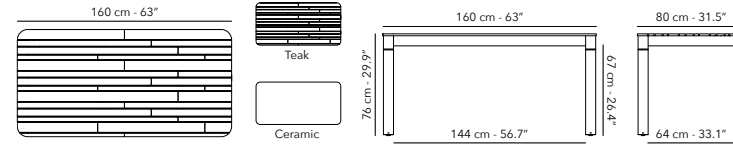

## DINING TABLE 160 x 80 cm

	<b>FUVOLDT41S</b> frame - structure	 <b>A01</b> white	€ 1.095
		 <b>A31</b> charcoal	
	<b>FUVOLTOP41</b> Table top Dessus de la table Tafelblad	 <b>W62</b> teak	€ 895
		 <b>K01</b> white	€ 1.995
		 <b>K31</b> charcoal	

cover - housse - hoes:  
€ 295







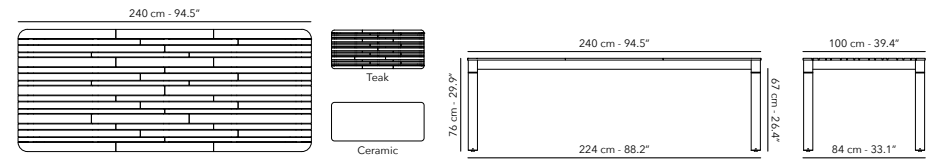

## DINING TABLE 240 x 100 cm

	<b>FUVOLDT44S</b> frame - structure	 <b>A01</b> white	€ 1.495
		 <b>A31</b> charcoal	
	<b>FUVOLTOP44</b> Table top Dessus de la table Tafelblad	 <b>W62</b> teak	€ 1.395
		 <b>K01</b> white	€ 2.695
		 <b>K31</b> charcoal	

cover - housse - hoes:  
€ 395



## DINING TABLE 300 x 100 cm

	<b>FUVOLDT47S</b> frame - structure	 <b>A01</b> white	€ 1.795
		 <b>A31</b> charcoal	
	<b>FUVOLTOP47</b> Table top Dessus de la table Tafelblad	 <b>W62</b> teak	€ 1.695
		 <b>K01</b> white	€ 3.395
		 <b>K31</b> charcoal	

cover - housse - hoes:  
€ 475

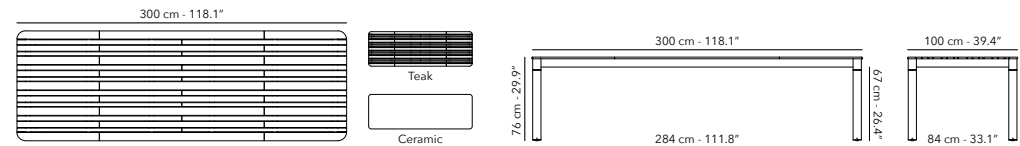









A01 & W62

A01 & K01

A31 & W62

A31 & K31



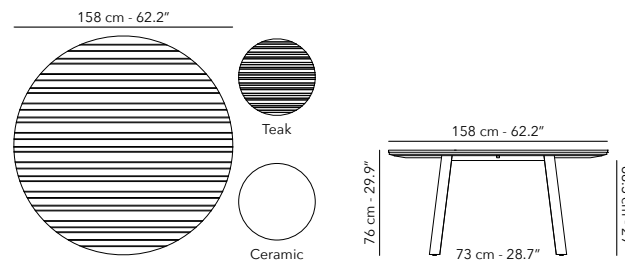

**DINING TABLE** ø 158 cm

	FUVOLDT08S frame - structure	 A01 white	€ 1.095
		 A31 charcoal	
	FUVOLTOP08 Table top Dessus de la table Tafelblad	 W62 teak	€ 1.295
		 K01 white	€ 2.295
 K31 charcoal			

cover - housse - hoes:  
€ 395



**BAR CHAIR**

	FUVOLBC02 frame - structure	 A01R02 white & silver	€ 695
		 A31R31 charcoal	
	CUVOLAC02 cushions - coussins - kussens	 C009 desert cat. C	€ 295
		 C201 charcoal cat. A	€ 265





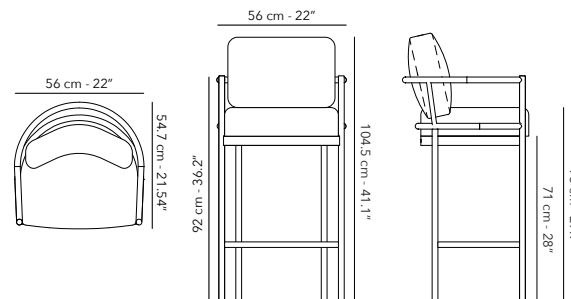

other fabrics - autres tissus - andere stoffen (p.101):  
cat. A € 290, cat. B € 310, cat. C € 335 &  
cat. D € on demand - sur demande - op aanvraag

cover - housse - hoes:  
€ 240



8 kg  
17.6 lbs

**BAR TABLE** 160 x 80 cm

	FUVOLBT02S frame - structure	 A01 white	€ 1.195
		 A31 charcoal	
	FUVOLTOP41 Table top Dessus de la table Tafelblad	 W62 teak	€ 895
		 K01 white	€ 1.995
 K31 charcoal			

cover - housse - hoes:  
€ 330

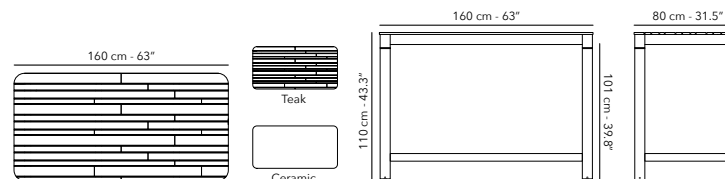







A01R02 & C009

A31R31 & C201

## LOUNGE CHAIR 1S

	<b>FUVOL1S02</b> frame - structure		<b>A01R02</b> white & silver	€ 995
			<b>A31R31</b> charcoal	
	<b>CUVOL1S02</b> cushions - coussins - kussens		<b>C009</b> desert cat. C	€ 695
			<b>C201</b> charcoal cat. A	€ 625



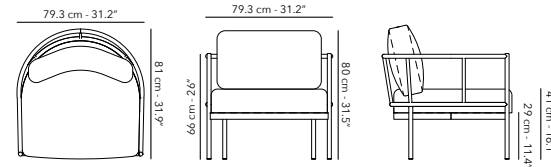

other fabrics - autres tissus - andere stoffen (p.101):  
cat. A € 795, cat. B € 875, cat. C € 935 &  
cat. D € on demand - sur demande - op aanvraag

cover - housse - hoes:  
€ 215



11.5 kg  
25.3 lbs

## LOUNGE SOFA 2S

	<b>FUVOL2S02</b> frame - structure		<b>A01R02</b> white & silver	€ 1.595
			<b>A31R31</b> charcoal	
	<b>CUVOL2S02</b> cushions - coussins - kussens		<b>C009</b> desert cat. C	€ 1.215
			<b>C201</b> charcoal cat. A	€ 1.075



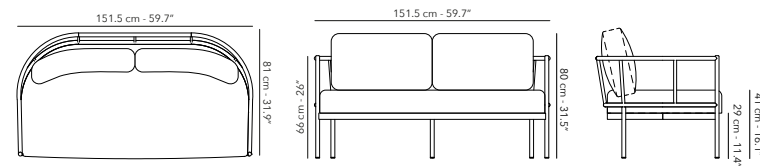

other fabrics - autres tissus - andere stoffen (p.101):  
cat. A € 1.405, cat. B € 1.465, cat. C € 1.580 &  
cat. D € on demand - sur demande - op aanvraag

cover - housse - hoes:  
€ 285



30 kg  
66 lbs

## LOUNGE SOFA 3S

	<b>FUVOL3S02</b> frame - structure		<b>A01R02</b> white & silver	€ 2.145
			<b>A31R31</b> charcoal	
	<b>CUVOL3S02</b> cushions - coussins - kussens		<b>C009</b> desert cat. C	€ 1.615
			<b>C201</b> charcoal cat. A	€ 1.425

other fabrics - autres tissus - andere stoffen (p.101):  
cat. A € 1.840, cat. B € 1.930, cat. C € 2.055 &  
cat. D € on demand - sur demande - op aanvraag

cover - housse - hoes:  
€ 350

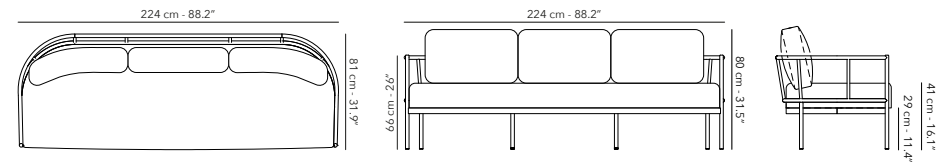

43.3 kg  
95.5 lbs









# KUDOS

UPDATED

Aluminium powder coated frame with steel base.  
Structure en aluminium thermolaqué avec une base en acier.  
Aluminium gepoederlakt frame met stalen voet.

Chairs in full aluminum or with upholstered textile.  
Chaises entièrement en aluminium ou avec textile rembourré.  
Stoelen in volledig aluminium of met gestoffeerd textiel.

## BISTRO CHAIR



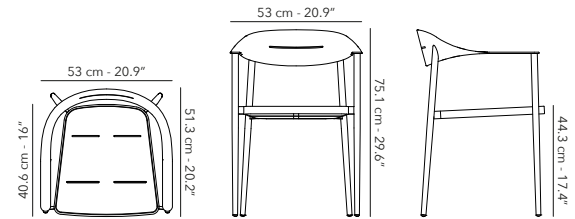

	FUKUDBIA01 frame - structure	 A01 white	€ 495
		 A03 linen <b>NEW</b>	
		 A32 black	
		 A69 lime	

Sold per 3 pieces. 3 pieces in 1 colour per box.  
Vendu par 3 pièces. 3 pièces en 1 couleur par boîte.  
Wordt per 3 stuks verkocht. 3 stuks in 1 kleur per doos.



 5.1 kg  
11.2 lbs



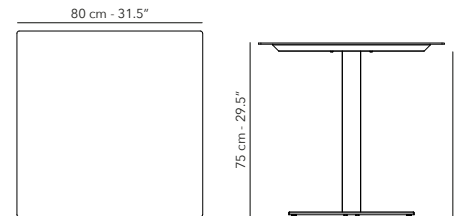

## BISTRO TABLE SQUARE 80 x 80 cm

	FUKUDBIT43 frame - structure	 A01 white	€ 895
		 A03 linen <b>NEW</b>	
		 A32 black	



 26 kg  
57.3 lbs

## BISTRO TABLE ROUND ø 75 cm

	FUKUDBIT03 frame - structure	 A01 white	€ 895
		 A03 linen <b>NEW</b>	
		 A32 black	

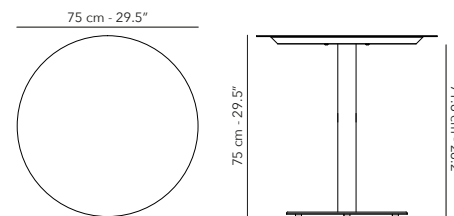

 17.2 kg  
40 lbs



A01R02



A30R30

## BISTRO ARMCHAIR



FUMANBIA02  
frame - structure

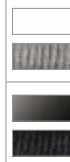

A01R02 white & silver

A30R30 anthracite

€ 395

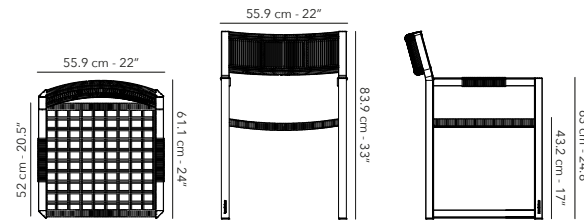

6 kg  
13.2 lbs

## DIRECTOR CHAIR



FUMANDC01  
frame - structure

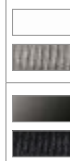

A01T02 white & silver

A30T30 anthracite

€ 345

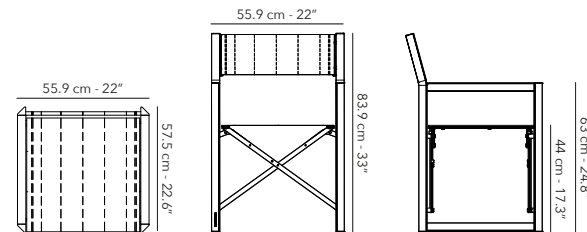





6 kg  
13.2 lbs

# MANTRA

Aluminium powder coated frame with steel base.  
Structure en aluminium thermolaqué avec une base en acier.  
Aluminium gepoederlakt frame met stalen voet.

Chairs in full aluminum or with upholstered textile.  
Chaises entièrement en aluminium ou avec textile rembourré.  
Stoelen in volledig aluminium of met gestoffeerd textiel.



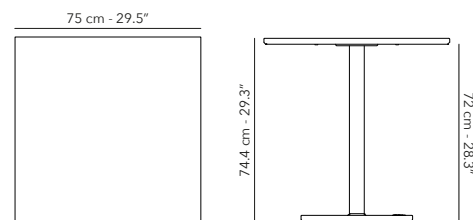

## BISTRO TABLE SQUARE 75 x 75 cm

	<b>FUMANBIT22S</b> frame - structure	 <b>A01 white</b>	€ 595
		 <b>A30 anthracite</b>	
	<b>FUMANBIT22T</b> Table top Dessus de la table Tafelblad	 <b>A01 white</b>	
		 <b>A30 anthracite</b>	



 28.5 kg  
62.8 lbs



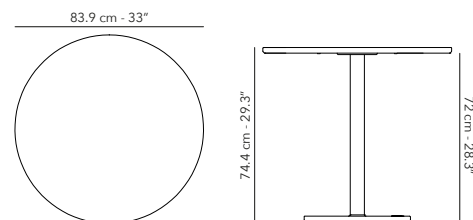

## BISTRO TABLE ROUND ø 80 cm

	<b>FUMANBIT03S</b> frame - structure	 <b>A01 white</b>	€ 595
		 <b>A30 anthracite</b>	
	<b>FUMANBIT03T</b> Table top Dessus de la table Tafelblad	 <b>A01 white</b>	
		 <b>A30 anthracite</b>	



 24.7 kg  
54.4 lbs

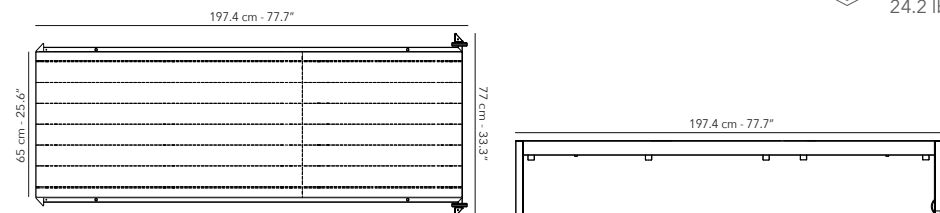

## SUNLOUNGER

	<b>FUMANSL04</b> frame - structure	 <b>A01T02 white &amp; silver</b>	€ 845
		 <b>A30T30 anthracite</b>	
		 <b>A01T02 white &amp; silver</b>	
		 <b>A30T30 anthracite</b>	



 11 kg  
24.2 lbs

BEACH CHAIR

	<p>FUBYBSC01</p>		<p><b>W62T30</b> teak &amp; anthracite</p>	<p>€ 795</p>
---	------------------	---	--	--------------

The headrest is adjustable and can be removed.  
L'appui-tête est réglable et peut être retiré.  
De hoofdsteun is verstelbaar en kan weggenomen worden.

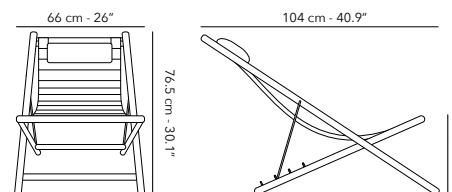

6 kg  
13.2 lbs

STAND

	<p>FUBYBSD01</p>		<p><b>W62</b> teak</p>	<p>€ 95</p>
---	------------------	---	------------------------	-------------

1.5 kg  
3.3 lbs

# NESTING TABLES

## NESTING SIDE TABLE ø 40 cm

	<b>FUVOLST02S</b> frame - structure	<b>A01 white</b>	choose table top choisissez le dessus kies tafelblad
		<b>A31 charcoal</b>	
	<b>FUVOLTOP00</b> Table top Dessus de la table Tafelblad	<b>W62 teak</b>	€ 315
		<b>K01 white</b>	€ 695
		<b>K14 taupegrey</b>	
		<b>K31 charcoal</b>	

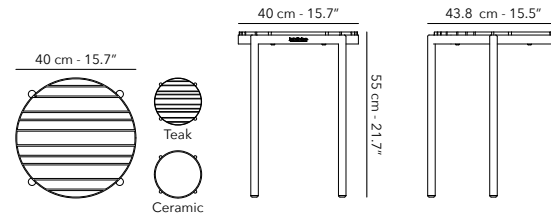

**K01 - K14 - K31**    **W62**  
5.6 kg    3.5 kg  
12.3 lbs    7.7 lbs

## NESTING SIDE TABLE ø 50 cm

	<b>FUVOLST03S</b> frame - structure	<b>A01 white</b>	choose table top choisissez le dessus kies tafelblad
		<b>A14 lava</b>	
		<b>A31 charcoal</b>	
	<b>FUVOLTOP01</b> Table top Dessus de la table Tafelblad	<b>W62 teak</b>	€ 395
		<b>K01 white</b>	€ 745
		<b>K14 taupegrey</b>	
<b>K31 charcoal</b>			

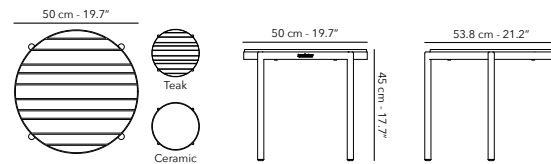

**K01 - K14 - K31**    **W62**  
7.6 kg    5 kg  
16.8 lbs    11 lbs

## NESTING COFFEE TABLE ø 60 cm



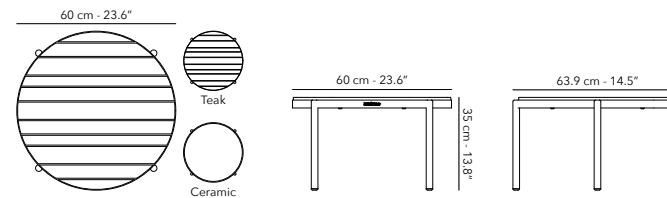





	<b>FUVOLST06S</b> frame - structure	<b>A01 white</b>	choose table top choisissez le dessus kies tafelblad
		<b>A31 charcoal</b>	
		<b>W62 teak</b>	
	<b>FUVOLTOP02</b> Table top Dessus de la table Tafelblad	<b>K01 white</b>	€ 795
		<b>K14 taupegrey</b>	
		<b>K31 charcoal</b>	



**K01 - K14 - K31**    **W62**  
10.5 kg    6 kg  
23.1 lbs    13.2 lbs

# NESTING TABLES







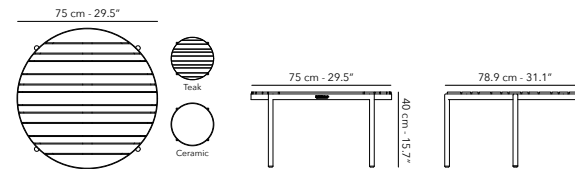

## NESTING COFFEE TABLE ø 75 cm

	<b>FUVOLST04S</b> frame - structure	 <b>A01</b> white	choose table top choisissez le dessus kies tafelblad
		 <b>A14</b> lava	
		 <b>A31</b> charcoal	
	<b>FUVOLTOP03</b> Table top Dessus de la table Tafelblad	 <b>W62</b> teak	€ 495
		 <b>K01</b> white	€ 995
		 <b>K14</b> taupegrey	
 <b>K31</b> charcoal			

 **K01 - K14 - K31**    **W62**  
14.8 kg    8 kg  
32.6 lbs    17.6 lbs





## NESTING COFFEE TABLE ø 90 cm

	<b>FUVOLST05S</b> frame - structure	 <b>A01</b> white	choose table top choisissez le dessus kies tafelblad
		 <b>A14</b> lava	
		 <b>A31</b> charcoal	
	<b>FUVOLTOP04</b> Table top Dessus de la table Tafelblad	 <b>W62</b> teak	€ 595
		 <b>K01</b> white	€ 1.245
		 <b>K14</b> taupegrey	
 <b>K31</b> charcoal			

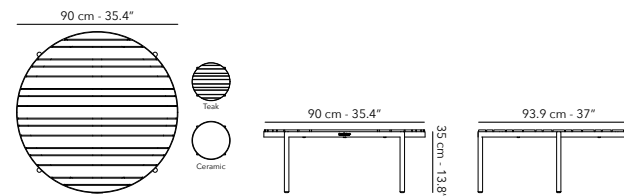
 **K01 - K14 - K31**    **W62**  
20.5 kg    10 kg  
45.2 lbs    22 lbs



## DUNCAN

	<b>DEDECDUN.01</b> Duncan teak block	 <b>W62</b> teak	€ 995
---	---	---	-------

27.4 kg  
60.4 lbs

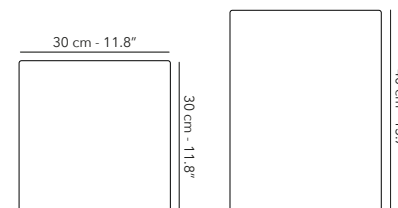

# BOLSA

NEW

Filling of mixed fibre, polyester fibre & EPS beads.  
Remplissage de fibres mixtes, fibres de polyester et de billes EPS.  
Vulling van gemengde vezels, polyestervezel & EPS-parels.

## LOUNGE CHAIR 1S

NEW

	FUBOL1S	Cat. A	€ 1.195
		Cat. B	€ 1.295
		Cat. C	€ 1.495
		Cat. D	€ 1.995

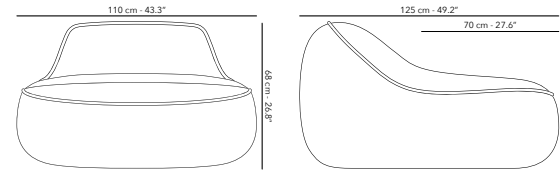

14.5 kg  
31.9 lbs

## CHAISE LONGUE

NEW

	FUBOLCL	Cat. A	€ 1.395
		Cat. B	€ 1.495
		Cat. C	€ 1.695
		Cat. D	€ 2.495

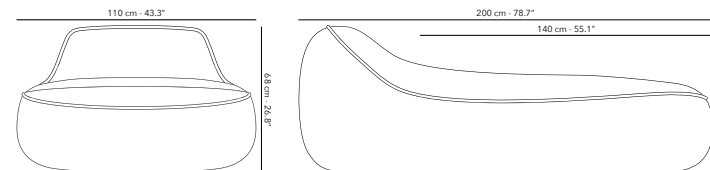

20.5 kg  
45.2 lbs



**OUTDOOR LIVING**  
DECORATION - DECORATIE







# POTTERY - POTS - POTTEN

UPDATED

Each pot is handmade with natural materials, combined with FRP. A robust, yet lightweight pot, UV and frost resistant.  
 Chaque pot est fait à la main avec des matériaux naturels, combinés à du FRP. Un pot robuste, mais léger, résistant aux UV et au gel.  
 Elke pot is handgemaakt met natuurlijke materialen, gecombineerd met FRP. Een robuuste, maar lichte pot, UV- en vorstbestendig.











## TERRA DÔME SET

NEW







	<b>DEPOTTERD-SET1</b> ø 45 x 45 cm, 17.7 x 17.7" ø 61 x 61 cm, 24 x 24" ø 83 x 82 cm, 32.6 x 32.3"	 P03 sabbia	€ 1.195
		 P11 macchiato	
		 P32 nero	

## TERRA CLASSIC













NEW

	<b>DEPOTTERC48.L</b> ø 48 x 57 cm, 19 x 22.5"	 P03 sabbia	€ 245
		 P11 macchiato	
		 P32 nero	
	<b>DEPOTTERC60.M</b> ø 60 x 72 cm, 23.6 x 28.3"	 P03 sabbia	€ 395
		 P11 macchiato	
		 P32 nero	
	<b>DEPOTTERC150.H</b> ø 150 x 180 cm, 59 x 71"	 P11 macchiato	€ 4.995













## TERRA ALTO

	<b>DEPOTERR45.M</b> ø 45 x 112 cm, 18 x 44"	 P03 sabbia	€ 395
		 P11 macchiato	
		 P32 nero	
	<b>DEPOTERR55.H</b> ø 55 x 137 cm, 22 x 54"	 P03 sabbia	€ 625
		 P11 macchiato	
		 P32 nero	

## TERRA CERCHIO









	<b>DEPOTTERB-SET1:</b> DEPOTTERB91.H DEPOTTERB112.H	 P03 sabbia	€ 1.225
		 P11 macchiato	
		 P32 nero	
	<b>DEPOTTERB91.H</b> ø 91 x 56 cm, 36 x 22"	 P03 sabbia	€ 565
		 P11 macchiato	
		 P32 nero	
	<b>DEPOTTERB112.H</b> ø 112 x 67 cm, 44 x 26"	 P03 sabbia	€ 795
		 P11 macchiato	
		 P32 nero	

## TERRA BALLOON

	<b>DEPOTTERB55.L</b> ø 55 x 35 cm, 22 x 14"	 P03 sabbia	€ 195
		 P11 macchiato	
		 P32 nero	
	<b>DEPOTTERB55.M</b> ø 55 x 45 cm, 22 x 18"	 P03 sabbia	€ 225
		 P11 macchiato	
		 P32 nero	
	<b>DEPOTTERB55.H</b> ø 55 x 56 cm, 22 x 22"	 P03 sabbia	€ 295
		 P11 macchiato	
		 P32 nero	



# POTTERY - POTS - POTTEN

## CUMINO ALBERO



	<b>DEPOTCUM-SET1:</b> DEPOTCUM52.L DEPOTCUM68.M DEPOTCUM88.H		P18 ruggine	€ 1.375
	<b>DEPOTCUM52.L</b> ø 52 x 60 cm, 20 x 24"		P18 ruggine	€ 275
	<b>DEPOTCUM68.M</b> ø 68 x 80 cm, 27 x 31"		P18 ruggine	€ 525
	<b>DEPOTCUM88.H</b> ø 88 x 102 cm, 35 x 40"		P18 ruggine	€ 765

## CUMINO FIORE

NEW



	<b>DEPOTCUM-SET2</b> ø 55 x 46 cm, 21.6 x 18" ø 65 x 54 cm, 25.5 x 21.2" ø 80 x 66 cm, 31.5 x 26"		P18 ruggine	€ 995
---	--	---	-------------	-------

## CUMINO FUNGO

	<b>DEPOTCUM114.L</b> ø 114 x 54 cm, 56,7 x 21"		P01 panna	€ 995
---	---	---	-----------	-------

## CUMINO CALICE





NEW

	<b>DEPOTCUMB120.H</b> ø 120 x 130 cm, 47 x 51"		P01 panna	€ 2.995
---	---	---	-----------	---------

## CURVO

	<b>DEPOTCUR-SET1:</b> DEPOTCUR32.L DEPOTCUR45.M DEPOTCUR55.H		P30 caffè	€ 595
	<b>DEPOTCUR32.L</b> ø 32 x 60 cm, 13 x 24"		P30 caffè	€ 145
	<b>DEPOTCUR45.M</b> ø 45 x 80 cm, 18 x 31"		P30 caffè	€ 245
	<b>DEPOTCUR55.H</b> ø 55 x 90 cm, 22 x 35"		P30 caffè	€ 295

## CARTELLO

	<b>DEPOTCAR75.L</b> ø 75 x 35 cm, 30 x 14"		P31 marone	€ 395
	<b>DEPOTCAR75.H</b> ø 75 x 68 cm, 30 x 27"		P31 marone	€ 495







# LIGHTING - ÉCLAIRAGE - VERLICHTING

## ARCO

	<b>DELIGARC.S</b> Small ø 39 x 48.5 cm, 15 x 19"		<b>F18</b> straw	€ 445
	<b>DELIGARC.L</b> Large ø 48 x 60 cm, 19 x 24"		<b>F18</b> straw	€ 545





synthetic material with solar lamp - fibre synthétique avec lumière solaire - synthetisch materiaal met lamp op zonne-energie

## ANTIBES

	<b>DECANANT.S</b> Small 21 x 21 x 50 cm 8 x 8 x 19.7"		<b>W62</b> teak	€ 145
	<b>DECANANT.M</b> Medium 30 x 30 x 60 cm 12 x 12 x 23.6"		<b>W62</b> teak	€ 195
	<b>DECANANT.L</b> Large 32 x 32 x 90 cm 13 x 13 x 35.4"		<b>W62</b> teak	€ 325
	<b>DEDECANT-TUB.01</b> Winetub ø 47 x 24 cm, 19 x 9"		<b>W62</b> teak	€ 325
	<b>DEDECANT-COOL.01</b> Winecooler ø 27 x 30 cm, 11 x 12"		<b>W62</b> teak	€ 195















teak with stainless steel parts - teck avec des pièces en acier inoxydable - teak met RVS onderdelen

## INTEGRA

	<b>DECANINT.S</b> Small ø 30 x 35,5 cm, 12 x 14"		<b>S99</b> black & gold	€ 95
	<b>DECANINT.M</b> Medium ø 35,5 x 40,5 cm, 14 x 16"		<b>S99</b> black & gold	€ 175
	<b>DECANINT.L</b> Large ø 47 x 55,5 cm, 19 x 22"		<b>S99</b> black & gold	€ 295

steel lanterns for indoor use - lanternes en acier pour l'intérieur - stalen windlichten voor binnengebruik

## SOLORE Solar Hybrid module incl.

	<b>DELIGSOL.CS</b> Cube small 25 x 25 cm, 10 x 10"		<b>F15</b> natural	€ 375
			<b>F17</b> taupe	
	<b>DELIGSOL.CM</b> Cube medium 33,5 x 33,5 cm, 13 x 13"		<b>F15</b> natural	€ 455
			<b>F17</b> taupe	
	<b>DELIGSOL.CL</b> Cube large 43 x 43 cm, 17 x 17"		<b>F15</b> natural	€ 495
			<b>F17</b> taupe	
	<b>DELIGSOL.SS</b> Sphere small ø 30 x 24,5 cm, 12 x 10"		<b>F15</b> natural	€ 395
			<b>F17</b> taupe	
	<b>DELIGSOL.SM</b> Sphere medium ø 38,5 x 33,5 cm, 15 x 13"		<b>F15</b> natural	€ 445
			<b>F17</b> taupe	
	<b>DELIGSOL.SL</b> Sphere large ø 47,5 x 43 cm, 19 x 17"		<b>F15</b> natural	€ 495
			<b>F17</b> taupe	

aluminium structure enclosed in HDPE fibre - structure en aluminium, enformé dans HDPE fibre - aluminium structuur, ingesloten in HDPE-vezel

	<b>DEALIGSOL-DSP03</b> Solore Solar Hybrid module	small	€ 195
	<b>DEALIGSOL-DSP01</b> Solore Solar Hybrid module	medium	€ 225

Solar-powered LED lamp for warm outdoor light. Rechargeable battery with solar energy or USB. Can be placed on the ground or hung up. Supplied with rope and USB cable. Control the light with the application "SLS Control". Available in the App Store and Google Play. The Solore Solar Module is included.

Lumière solaire à LED fournissant une lumière extérieure. Batterie rechargeable avec énergie solaire ou USB. Peut se tenir seul ou être suspendu. Fourni avec une corde & câble USB. Fonctionnement de la lumière avec l'application "SLS Control". Disponible à l'App Store et Google Play. Le Solore Solar Module est inclus.

LED-lamp op zonne-energie voor warm buitenlicht. Oplaadbare batterij met zonne-energie of USB. Kan op de grond geplaatst worden of worden opgehangen. Geleverd met touw en USB-kabel. Bedien het licht met de applicatie "SLS Control". Verkrijgbaar in de App Store en Google Play. De Solore Solar Module is inbegrepen.

# RUGS - TAPIS - TAPIJTEN

## LONGI

	<b>DERUGLON200X300</b> 200 x 300 cm, 79 x 118"		<b>D80</b> long hair ecru	€ 995
	<b>DERUGLON250X350</b> 250 x 350 cm, 98 x 138"		<b>D80</b> long hair ecru	€ 1.495
			<b>D81</b> long hair grey	
	<b>DERUGLON300X400</b> 300 x 400 cm, 118 x 157"		<b>D80</b> long hair ecru	€ 1.995
	<b>DERUGLON300XR</b> ø 300 cm, 118"		<b>D80</b> long hair ecru	€ 1.495
			<b>D81</b> long hair grey	









hand woven polyolefin - polyolefin, tissé à la main - handgeweven polyolefin

## JUTE

	<b>DERUGJUT200X300</b> 200 x 300 cm, 79 x 118"		<b>D82</b> jute	€ 595
	<b>DERUGJUT300X400</b> 300 x 400 cm, 118 x 157"		<b>D82</b> jute	€ 1.195



hand braided polyolefin rope - corde en polyolefin, tressé à la main - handgevlochten polyolefin touw

## VASCO

	<b>DERUGVAS170X240</b> 170 x 240 cm, 67 x 95"		<b>D84</b> charcoal	€ 495
			<b>D85</b> aqua	
	<b>DERUGVAS200X300</b> 200 x 300 cm, 79 x 118"		<b>D84</b> charcoal	€ 695
			<b>D85</b> aqua	
	<b>DERUGVAS250X350</b> 250 x 350 cm, 98 x 138"		<b>D84</b> charcoal	€ 995
			<b>D85</b> aqua	
	<b>DERUGVAS250X250</b> 250 x 250 cm, 98 x 98"		<b>D84</b> charcoal	€ 795
			<b>D85</b> aqua	

100% hand woven, recycled PET - PET recyclé, tissé à la main - 100% handgeweven, gerecycleerde PET









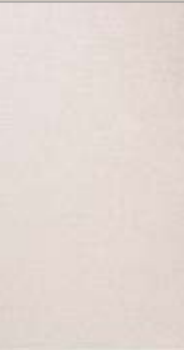

## HAMPTON

	<b>DERUGHAM200X300</b> 200 x 300 cm, 79 x 118"		<b>D90</b> ivory (aqua - ivory)	€ 795
			<b>D91</b> taupe (taupe-taupe)	
			<b>D92</b> grey (ivory - taupe)	
	<b>DERUGHAM250X350</b> 250 x 350 cm, 98 x 138"		<b>D90</b> ivory (aqua - ivory)	€ 1.095
			<b>D91</b> taupe (taupe-taupe)	
			<b>D92</b> grey (ivory - taupe)	
<b>DERUGHAM300X400</b> 300 x 400 cm, 118 x 157"		<b>D90</b> ivory (aqua - ivory)	€ 1.495	
		<b>D91</b> taupe (taupe-taupe)		

PET 80%, polyester 20%, hand woven - handgeweven - tissé à la main

## WILSON

MADE IN BELGIUM

	<b>DERUGWIL200X300</b> 200 x 300 cm, 79 x 118"		<b>D77</b> shell	€ 995
			<b>D78</b> oyster	
			<b>D79</b> greige	
	<b>DERUGWIL250X350</b> 250 x 350 cm, 98 x 138"		<b>D77</b> shell	€ 1.495
			<b>D78</b> oyster	
			<b>D79</b> greige	
	<b>DERUGWIL280X390</b> 280 x 390 cm, 110 x 154"		<b>D77</b> shell	€ 1.845
			<b>D78</b> oyster	
			<b>D79</b> greige	

polyester and high-quality Decolan yarn - polyester et fil Decolan de la plus haute qualité - polyester en hoogwaardige Decolan garen

# POUFS - POEFS

## JUTE

	<b>DEPOUJUT.RL</b> Large ø 75 x 35 cm, 30 x 14"		<b>D82</b> jute	€ 315
---	---	---	-----------------	-------



hand braided polyolefin rope - corde en polyolefin, tressé à la main - handgevlochten polyolefin touw

## DONUT

	<b>DEPOUDONU.RS</b> Small ø 55 x 26 cm, 22 x 10"		<b>F14</b> bohemian	€ 240
	<b>DEPOUDONU.RL</b> Large ø 110 x 36 cm, 43 x 14"		<b>F14</b> bohemian	€ 695

hand woven wicker viro fiber - fibre viro en osier, tissé à la main - handgeweven rieten viro-vezel

## LONGI

	<b>DEPOULON.RS</b> Small ø 50 x 40 cm, 19 x 16"		<b>D80</b> long hair ecru	€ 165
			<b>D81</b> long hair grey	
	<b>DEPOULON.RL</b> Large ø 100 x 40 cm, 39 x 16"		<b>D80</b> long hair ecru	€ 465
			<b>D81</b> long hair grey	

hand woven polyolefin - polyolefin, tissé à la main - handgeweven polyolefin

## HAMPTON

	<b>DEPOUHAM.SS</b> Small 50 x 50 x 40 cm 19 x 19 x 16"		<b>D93</b> oat	€ 240
			<b>D95</b> mustard	
			<b>D96</b> indigo	
	<b>DEPOUHAM.SL</b> Large 100 x 100 x 40 cm 39 x 39 x 16"		<b>D93</b> oat	€ 685
			<b>D94</b> metal	
			<b>D95</b> mustard	
			<b>D96</b> indigo	

PET 80%, polyester 20%, hand woven - tissé à la main - handgeweven

## BAY

	<b>DEPOUBAY.RS</b> Small ø 50 x 40 cm, 19 x 16"	Cat. A	€ 475
		Cat. B	€ 495
		Cat. C	€ 525
		Cat. D	€ 895
		Free pick other fabrics - autres tissus - andere stoffen	€ 595
	<b>DEPOUBAY.RM</b> Medium ø 50 x 50 cm, 19 x 19"	Cat. A	€ 545
		Cat. B	€ 565
		Cat. C	€ 595
		Cat. D	€ 1.195
		Free pick other fabrics - autres tissus - andere stoffen	€ 625
	<b>DEPOUBAY.RL</b> Large ø 80 x 40 cm, 32 x 16"	Cat. A	€ 695
		Cat. B	€ 745
		Cat. C	€ 795
		Cat. D	€ 1.495
		Free pick other fabrics - autres tissus - andere stoffen	€ 895

100% solution dyed acrylic - acrylique teinté en masse - in de massa gekleurde acryl

# DECO CUSHIONS - COUSSINS DE DÉCORATION - DECOKUSSENS

DECO CUSHION		Cat. A	Cat. B	Cat. C	Cat. D
	CUDECO40X40 40 x 40 cm	€ 95	€ 105	€ 115	€ 245
	CUDECO50X50 50 x 50 cm	€ 105	€ 115	€ 125	€ 275

overview of the fabrics - aperçu des tissus - overzicht van de stoffen: p.101

## FAST STOCK DECO CUSHION 40 X 40 CM

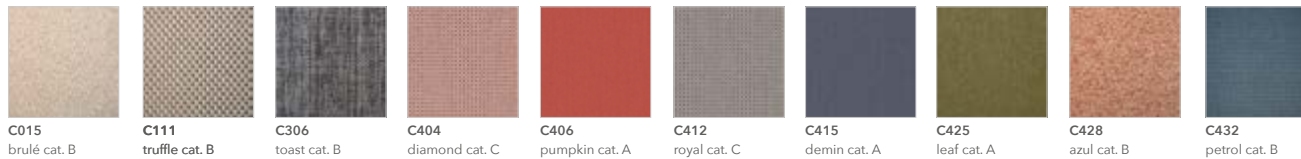



# MAINTENANCE & PROTECTION - ONDERHOUD & BESCHERMING

To enhance the durability and appearance, we recommend following our care instructions regularly. The umbrella should never be used in strong wind or rainy conditions. An open umbrella should never be left unattended. We always suggest storing your furniture and outdoor umbrella in a dry place when not in use or using a protective cover to avoid any blurring or damage.

Pour améliorer la durabilité et l'apparence, nous vous recommandons de suivre nos instructions d'entretien régulièrement. Le parasol ne doit jamais être utilisé dans des conditions fortes ou pluvieuses. Un parasol ouvert ne doit jamais être laissé sans surveillance. Nous suggérons toujours de ranger vos meubles et votre parasol dans un endroit sec lorsqu'ils ne sont pas utilisés ou d'utiliser une housse de protection pour éviter la décoloration et les dommages.

Om de duurzaamheid en het uiterlijk te verbeteren, raden we aan om regelmatig onze instructies op te volgen. De parasol mag nooit gebruikt worden in harde wind of regenachtige omstandigheden. Een geopende parasol mag nooit zonder toezicht worden achtergelaten. We raden altijd aan om uw parasol of meubels op een droge plaats op te bergen wanneer ze niet worden gebruikt, of om een beschermhoes te gebruiken om vervaging of beschadiging te voorkomen.









## COVER - HOUSSE - HOES

	UPJCP.1S-X77	JCP.1 Series	€ 95
	UPJCP.202-X77	JCP. 202	€ 295
	UPJCP.2S-X77	JCP.201 & JCP.203	€ 295
	UPJCP.3S-X77	JCP.3 Series	€ 175
	UPJCP.4S-X77	JCP.4 Series	€ 215
	UPJCP.5S-X77	JCP.5 Series	€ 595
	UPJCP.6S-X77	JCP.6 Series	€ 345
	UPAZO-M-X75	Azore	€ 75
	UPANT-M-X75	Antego	€ 75
	UPKIN-L-X75	Kingston & Lima	€ 95
	UPUMB-S-X75	Malibu	€ 65
	UPAMA-M-X75	Amalfi	€ 75
	UPCUB-M	Cuba & Moorea	€ 175
		FP... X75	Furniture collection

## CARE KIT - ENSEMBLE DE MAINTENANCE - ONDERHOUDSKIT

	<b>SPCARE-TEXT-75CL</b> fabrics tissus stoffen	2 sponges, 3 application cloths 1 textile protector 750ml 1 textile cleaner 750ml  2 sets de récurage, 3 chiffons 1 protecteur textile 750ml 1 nettoyant textile 750ml  2 sponzen, 3 doeken 1 textielbeschermer 750ml 1 textielreiniger 750ml	€ 75
	<b>SPCARE-STONE-50CL</b> natural stone pierre naturelle natuursteen	1 sponge, 1 applicaton cloth 1 natural stone protector 500ml 1 natural stone cleaner 500ml  1 éponge, 1 chiffon d'application 1 protecteur de pierre naturelle 500ml 1 nettoyant de pierre naturelle 500 ml  1 spons, 1 doek 1 natuursteen beschermer 500 ml 1 natuursteen reiniger 500 ml	€ 75

## CORRECTOR PEN 12 ML

	<b>SPCOR-12ML</b>	 <b>A01</b> white	€ 25
		 <b>A03</b> linen	
		 <b>A11</b> taupe	
		 <b>A14</b> lava	
		 <b>A30</b> anthracite	
		 <b>A31</b> charcoal	
		 <b>A32</b> black	

Quick-drying liquid paint with built-in brush for powder-coated surfaces. Ideal for retouching small surface traces (scratches, wear).

Peinture liquide à séchage rapide avec pinceau intégré pour les surfaces thermolaqué. Idéale pour retoucher les petites marques de surface (rayures, abrasion).

Snel drogende vloeibare verf met ingebouwde borstel voor gepoederlakte oppervlakken. Ideaal voor het retoucheren van kleine oppervlaktesporen (krassen, slijtage).





### LUNA LED LIGHT

UALUN-LED02

You create a warm glow by adding this outdoor umbrella light to the built-in holder on the frame. Luna LED light is wireless with 16 LEDs and gives a warm color. Using the BT speaker, the module will play music for six to ten hours.

On peut créer une lueur chaleureuse en ajoutant cette lampe de parasol à un support intégré sur le structure de parasol. La lumière LED Luna est sans fil avec 16 LED et donne une couleur douce. En utilisant le haut-parleur BT, il vous permet d'écouter de la musique pendant six à dix heures.

Je creëert een warme gloed door deze parasollamp toe te voegen aan de ingebouwde houder op het parasolframe. Luna LED light is draadloos met 16 LED's en geeft een warme kleur. Aan de hand van de BT-luidspreker, speelt de module zes tot tien uur lang muziek.

**colour - couleur - kleur:** grey - gris - grijs

**light - lumière - licht:** LED warm light - lumière douce - warm licht

**fits on - s' adapte sur - past op:** Attitude collection; Azore - Antego - Kingston - Lima - Amalfi - Malibu



### GUTTERS

Gutters offer an uninterrupted protection between several umbrellas. By connecting the parasols, large areas have a complete coverage against the sun or rainy weather. A gutter is always attached to the parasol with a slight slope in order to drain the water efficiently in the desired directions.

Our gutters are available in the same colour as the cloth of the parasol to match perfectly. Only applicable on the following parasols: JCP.201 (p. 11), JCP.202 (p. 12) and JCP.501 (p. 22).

### GOUSSIÈRES

Les gouttières offrent une protection ininterrompue entre plusieurs parasols extérieurs. La connexion des parasols permet de grandes zones d'avoir une couverture complète contre le soleil ou les conditions météorologiques pluvieuses. Une gouttière est toujours attachée au parasol à une légère baisse pour permettre à l'eau de s'écouler efficacement dans les directions souhaitées.

Ils sont disponibles dans la même couleur que votre toile pour se fondre parfaitement. Uniquement applicables sur les parasols suivants: JCP.201 (p. 11), JCP.202 (p. 12) and JCP.501 (p. 22).

### GOTEN

Goten bieden ononderbroken bescherming tussen meerdere parasols. Door de parasols aan elkaar te koppelen, hebben grote oppervlakten een volledige dekking tegen de zon of regenachtige weersomstandigheden. Een goot wordt altijd met een lichte helling aan de parasol bevestigd om het water efficiënt in de gewenste richtingen af te voeren.

Onze goten zijn beschikbaar in dezelfde kleur als het doek van de parasol om er perfect bij te passen. Enkel van toepassing op de volgende parasols: JCP.201 (p. 11), JCP.202 (p. 12) and JCP.501 (p. 22).

# MATERIALS - MATERIAUX - MATERIALEN

## ALUMINIUM frame - structure

Aluminium powder coated - gepoederlakt - thermolaqué  
\* A02 silver = aluminium anodised - anodisé - geanodiseerd



A01 white



A02 silver\*



A03 linen



A10 cappuccino



A12 alu teak



A14 lava



A30 anthracite



A31 charcoal



A32 black



A69 lime

## WOOD - BOIS - HOUT frame - structure



W60 eucalyptus



W62 teak



W63 teak scratched

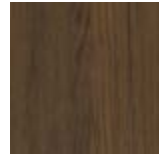

W64 sable teak



W68 black teak

W60 tropical hardwood with smooth finish - bois franc à finition lisse - tropisch hardhout met gladde afwerking  
W64 teak with rough finish - teak à finition rugueux et rayé - tropisch hardhout met ruwe, bekraste afwerking  
W62 teak with matte finish - teck à finition mate - teak met matte afwerking  
W64 & W68 teak with bushed finish and coloured coating - teck à finition brossée et revêtement coloré - teak met geborstelde afwerking en gekleurde coating.

## STEEL - ACIER - STAAL Caractère collection umbrella base - base du parasol - parasolvoet



S01 white



S02 silver



S03 linen

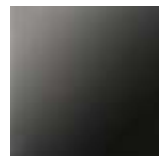

S31 charcoal



S32 black

Hot galvanised powder coated steel plates, heavy and rust free.  
Tôle d'acier galvanisé à chaud et thermolaqué. Un socle lourd et inoxydable.  
Warm verzinkte en gepoederlakte staalplaat, zwaar en roestvrij.

# MATERIALS - MATERIAUX - MATERIALEN

## ROPE - CORDE - TOUW frame - structure

UV-resistant polyolefin, woven by hand.  
Polyoléfine résistante aux UV, tissée à la main.  
UV bestendig polyolefin, hand geweven.



R02 silver



R03 linen



R11 artichoke



R12 cream



R13 sand



R14 brown



R30 anthracite

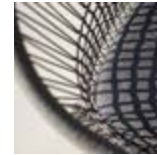

R31 charcoal



R32 black

## WICKER - OSIER frame - structure



F16 cottage

Made of natural clays and mineral colours which are pressed and fired to make a high-performing surface. Thickness of 12 mm, 0,5".  
Fait d'argiles naturelles et de couleurs minérales qui sont pressées et cuites pour créer une surface haute performance. Épaisseur de 12 mm, 0,5".  
Gemaakt van natuurlijke klei en minerale kleuren die worden geperst en gebakken om een hoogwaardig oppervlak te maken. Dikte van 12 mm, 0,5".

## CERAMIC - CÉRAMIQUE - KERAMIEK frame - structure



K01 white



K14 taupe grey



K31 charcoal

Hot galvanised powder coated steel plates, heavy and rust free.  
Tôle d'acier galvanisé à chaud et thermolaqué. Un socle lourd et inoxydable.  
Warm verzinkte en gepoederlakte staalplaat, zwaar en roestvrij.

# FABRICS - TISSUS - STOFFEN

100% solution dyed acrylic or olefin  
colour fastness: 7-8/8  
resing based anti-fungal coating  
water and UV resistant  
scratch- and dirt resistant

100% acrylique teinté en masse  
solidité des couleurs : 7-8/8  
revêtement antifongique à base de résine  
résistant à l'eau et aux UV  
anti-rayures et anti-salissures

100% in de massa gekleurde acryl of olefin  
kleurvastheid: 7-8/8  
anti schimmelcoating op basis van hars  
water- en UV bestendig  
kras- en vuilafstotend

## CARACTÈRE canopy - toile - doek

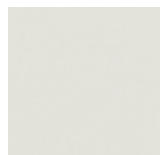

C003 pearl



C011 cotton



C100 ice

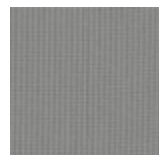

C107 mooncrest



C207 onyx

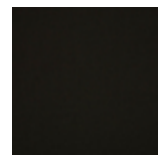

C210 pitch



C305 umber

## ATTITUDE canopy - toile - doek



C001 natural



C010 latte

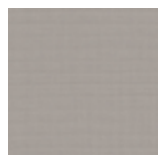

C101 cloud



C106 gris nature



C204 night



C208 black

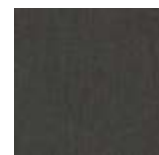

C211 steel



C212 gasoline

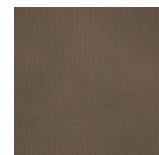

C301 taupe

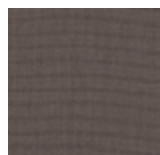

C304 walnut



C402 tangerine

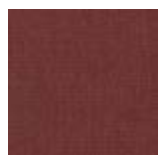

C409 brick



C417 jeans



C418 ocean



C421 kiwi

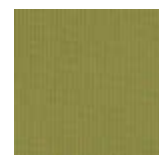

C424 spinach



C002 white

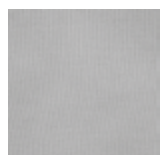

C105 light grey



C109 speckle

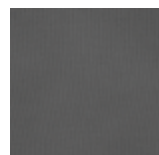

C200 dark grey

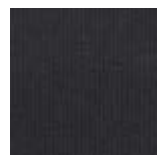

C209 coal

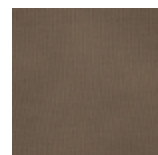

C302 mocca



C405 orange



C407 red

**FAST STOCK**

Outdoor umbrella canopies and cushions available on stock.  
 Des toiles de parasol et des coussins disponibles sur stock.  
 Parasoldoeken en kussens uit voorraad leverbaar.

## FABRICS - TISSUS - STOFFEN

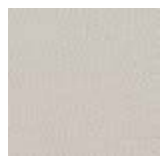
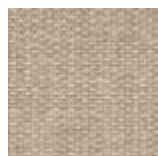
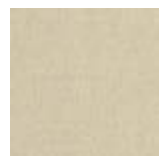
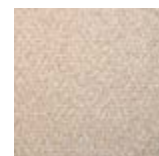
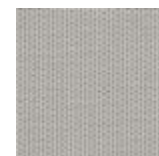
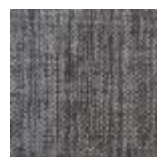
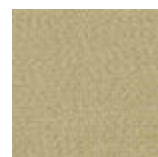
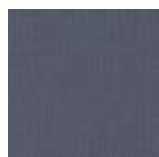
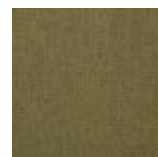
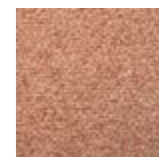
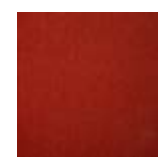
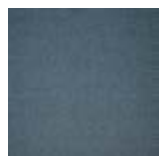
**FURNITURE** cushions - coussins - kussensC005 marble  
cat. CC006 vanilla  
cat. BC007 beige  
cat. BC008 linen  
cat. AC009 desert  
cat. CC012 cream  
cat. BC015 brûlé  
cat. BC103 stone  
cat. AC104 quartz  
cat. CC111 truffle  
cat. BC201 charcoal  
cat. AC202 smoke grey  
cat. BC205 ebony  
cat. BC206 ash  
cat. AC306 toast  
cat. BC401 corn  
cat. CC404 diamond  
cat. CC406 pumpkin  
cat. AC408 flame  
cat. AC411 ruby  
cat. AC412 royal  
cat. CC415 denim  
cat. AC419 lime  
cat. CC420 mint  
cat. AC422 sage  
cat. AC425 leaf  
cat. AC426 kaki  
cat. AC427 blush  
cat. DC428 azul  
cat. BC430 cotta  
cat. DC431 pacific  
cat. DC432 petrol  
cat. B

T02 silver

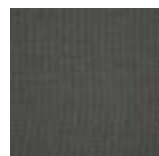

T30 anthracite

# WIND SCALE - ÉCHELLE DU VENT - WINDSCHAAL

De windsnelheid die weergegeven wordt in deze prijslijst is de maximale windsnelheid waaraan de parasol blootgesteld kan worden. Een parasol is het meest kwetsbare meubelstuk in uw tuin of uw terras. De grootste gevaren voor de levensduur van een parasol zijn de weersomstandigheden en externe omgevingsfactoren. Daarom raden wij aan om onze onderhoudsinstructies regelmatig op te volgen.

**Let op:** schade ten gevolg van wind valt niet onder onze garantie. In geval van wind is het aan te raden de parasol te sluiten, van de voet te halen en horizontaal op te bergen. Dit verkleint de kans op schade aan de parasol en andere bezittingen of eigendommen.

## TIPS VOOR DE IDEALE POSITIE VAN DE PARASOL

### VRIJHANGENDE PARASOL

Indien je de parasol in hoogte wilt kantelen (2), adviseren wij om de achterkant van de mast tegen de windrichting in te plaatsen (1). Je kan nu de parasol kantelen zonder dat deze wind van onderaan opvangt.

Wanneer de wind de parasol vanuit een andere richting bereikt, adviseren wij om de parasol altijd horizontaal te plaatsen (3). Zorg ervoor dat de binnenkant van de parasol nooit wind opvangt (5) om te voorkomen dat de parasol omvalt. Het is belangrijk dat de parasol volledig geopend is met spanning op het doek en altijd op een vlakke ondergrond staat.

### PARASOL MET CENTRALE MAST

We adviseren om altijd wind van onderaan te vermijden. Zorg ervoor dat de parasol volledig open is en op een vlakke ondergrond staat.

La vitesse du vent indiquée dans ce tarif est la vitesse maximale du vent à laquelle le parasol peut être exposé. Un parasol d'extérieur est le meuble le plus vulnérable de votre jardin ou de votre terrasse. Les plus grandes menaces pour la durée de vie d'un parasol sont les conditions météorologiques et les facteurs environnementaux. C'est pourquoi nous vous suggérons de suivre régulièrement nos instructions d'entretien.

**Attention :** les dommages dus au vent ne sont pas couverts par notre garantie. En cas de vent, il est recommandé de fermer le parasol, de le retirer de son socle et de le positionner horizontalement. Cela réduira les risques d'endommagement de votre parasol et de vos autres possessions ou biens.

## CONSEILS POUR LA POSITION IDEALE DU PARASOL

### PARASOL À MÂT LIBRE

Si vous souhaitez incliner votre parasol en hauteur (2), nous conseillons de positionner l'arrière du mât dans le sens contraire du vent (1). Vous pouvez ainsi incliner votre parasol sans qu'il ne prenne le vent par le bas. Lorsque le vent atteint le parasol depuis une autre direction, nous conseillons de toujours mettre le parasol horizontalement (3). Pour éviter que le parasol ne tombe, assurez-vous que l'intérieur du parasol n'est jamais face au vent (5). Il est important que le parasol soit complètement ouvert avec une tension totale sur la toile et qu'il repose toujours sur une surface plane.

### PARASOL À MÂT CENTRAL

Nous vous conseillons de toujours éviter le vent par le bas. Veillez à ouvrir complètement le parasol et à le poser sur une surface plane.

The wind speed indicated in this price list is the maximum wind speed the parasol can be exposed to. A parasol is the most vulnerable piece of furniture in your garden or on your terrace. Weather conditions and external environmental factors are the biggest dangers for the life span of a parasol. Therefore, we recommend you to regularly follow our maintenance instructions.

**Please note:** damage caused by wind is not covered by our warranty. In case of wind, it is recommended to close the parasol, take it off its base and store it horizontally. This reduces the chance of damage to the parasol and other belongings.

## TIPS FOR THE IDEAL POSITION OF THE UMBRELLA

### FREE POLE UMBRELLA

If you want to tilt the parasol in height (2), we advise you to position the back side of the pole against the wind direction (1). You will now be able to tilt the parasol without it catching wind from below.

If the wind reaches the parasol from another direction, we advise to always position the parasol horizontally (3)! Make sure the inside of the parasol never catches wind (5) to prevent it from collapsing. It is important that the parasol is fully opened with tension on the cloth and always stands on a flat surface.

### CENTER POLE UMBRELLA

We recommend always avoiding wind from below. Make sure the parasol is fully opened and stands on a flat surface.

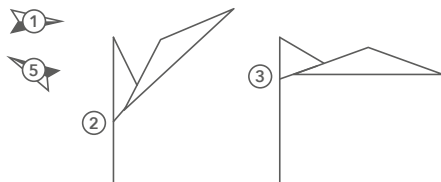

# WIND SCALE - ÉCHELLE DU VENT - WINDSCHAAL



beaufort N°.	description - omschrijving	Km/h	Mph	conditions at sea - conditions de la mer - condities op zee	conditions on land conditions terrestres - condities op het land	Parasol
0	calm calme kalm	< 1	< 1	The sea is like a mirror. La mer est comme un miroir. De zee is als een spiegel.	Calm, smoke rises vertically. Calme, la fumée s'élève verticalement. Kalm, rook stijgt verticaal op.	
1	light air air léger lichte lucht	1 - 5	1 - 3	Ripples form on the surface, without foam ridges. Des ondulations se forment à la surface, sans crêtes d'écume. Rimpelingen aan het oppervlak, zonder schuimruggen.	Smoke drift indicates wind direction. La dérive de la fumée indique la direction du vent. Rookdrift geeft windrichting aan.	
2	light breeze brise légère licht briesje	6 - 11	4 - 6	Small waves. Petites vaguelettes. Kleine golfjes.	Wind can be felt on the face, leaves rustle. Vent ressenti sur le visage, les feuilles bruissent. Wind voelbaar op gezicht, bladeren ritselen.	
3	gentle breeze souffle léger zachte bries	12 - 19	7 - 10	Larger waves of 0.5 to 1 m. Grandes vaguelettes de 0.5 à 1 m. Grotere golfjes van 0.5 tot 1 m.	The leaves and small branches are constantly moving. Les feuilles et les petites brindilles sont en mouvement constant. Bladeren en kleine takjes zijn in beweging.	Malibu
4	moderate breeze brise modérée matige wind	20 - 28	11 - 16	Small wave of 1 to 2 m that grows longer. Petite vague de 1 à 2 m qui s'allonge. Kleine golf van 1 tot 2 m die langer wordt.	Dust, leaves and loose paper come up, small branches move. Poussière, feuilles et papiers détachés soulevés, petites branches bougent. Stof, bladeren en los papier komen omhoog, kleine takken bewegen.	Azore
5	cool breeze brise fraîche frisse bries	29 - 38	17 - 21	Moderate waves of 2 to 3 m. Les vagues modérées de 2 à 3 m. Matige golven van 2 tot 3 m.	Small trees begin to sway. Les petits arbres commencent à se balancer. Kleine bomen beginnen te zwaaien.	
6	strong breeze brise forte sterke bries	39 - 49	22 - 27	Large waves of 3 to 4 metres begin to form. De grandes vagues de 3 à 4 m commencent à se former. Grote golven van 3 tot 4 m beginnen zich te vormen.	Large branches in motion, umbrellas used with difficulty. Grosses branches en mouvement, parapluies sont utilisés avec difficulté. Grote takken in beweging, paraplu's met moeite gebruikt.	JCP.1 series, Cuba Moorea, Kingston, Lima, Antego, Amalfi
7	strong breeze, almost storm vent fort, proche du coup de vent harde wind, bijna storm	50 - 61	28 - 33	Waves of 4.5 to 5 m. The white foam of breaking waves is blown in the direction of the wind. Vagues modérées de 4.5 à 5 m. L'écume blanche des vagues déferlantes est poussée dans la direction du vent. Golven van 4.5 tot 5 m. Het witte schuim van brekende golven wordt in de richting van de wind geblazen.	Trees in motion, discomfort felt when walking against the wind. Arbres en mouvement, inconfortables lorsqu'on marche contre le vent. Bomen in beweging, ongemak gevoeld bij het lopen tegen de wind in.	JCP.2, 3, 4, 5 & 6 series
8	storm coup de vent	62 - 74	34 - 40	Moderately high waves of 5 to 7 m. Des vagues modérément hautes de 5 à 7 m. Matig hoge golven van 5 tot 7 m.	Branches and small branches break off from trees. Des brindilles et des petites branches se sont détachées des arbres. Takjes en kleine takken breken van bomen af.	
9	strong storm coup de vent fort sterke storm	75 - 88	41 - 47	High waves of 7 to 10 m. The sea begins to roll, mist affects visibility. Hautes vagues de 7 à 10 m. La mer commence à rouler, les embruns affectent la visibilité. Hoge golven van 7 tot 10 m. De zee begint te rollen, nevel tast het zicht aan.	Light structural damage. Légers dommages structurels. Takjes en kleine takken breken van bomen af.	
10	severe storm tempête zware storm	89 - 102	48 - 55	Very high waves of 9 to 12 m with long overhanging ridges. Très hautes vagues de 9 à 12 m avec de longues crêtes en surplomb. Zeer hoge golven van 9 tot 12 m met lange overhangende ruggen.	Rarely encountered on land. Trees uprooted, structural damage. Rarement ressenti sur terre. Arbres déracinés, dommages structurels. Zelden op het land ondervonden. Bomen ontworteld, structurele schade.	

# SEATS PER TABLE - NOMBRE DE SIÈGES PAR TABLE - AANTAL ZITPLAATSEN PER TAFEL

## ROUND - ROND

	seats - sièges zitplaatsen	size - taille - maat cm	size - taille - maat inch	Noa p. 42	Nero p. 48	Legna p. 56	Tecca p. 66	Nature p. 70	Flexx p. 72	Volte p. 78	Kudos p. 82	Mantra p. 83
	3	ø 75 cm	ø 29.5"								bistro table	
	3	ø 80 cm	ø 31"									bistro table
	6	ø 158 cm	ø 62"							dining table		

## SQUARE - CARRÉ - VIERKANT

	seats - sièges zitplaatsen	size - taille - maat cm	size - taille - maat inch	Noa p. 42	Nero p. 48	Legna p. 56	Tecca p. 66	Nature p. 70	Flexx p. 72	Volte p. 78	Kudos p. 82	Mantra p. 83
	2 + 2	75 x 75 cm	30 x 30"									bistro table
	2 + 2	80 x 80 cm	31 x 31"						bistro table		bistro table	
	8	160 x 160 cm	62 x 62"				dining table					







# SEATS PER TABLE - NOMBRE DE SIÈGES PAR TABLE - AANTAL ZITPLAATSEN PER TAFEL

## RECTANGULAR - RECTANGLE - RECHTHOEKIG

	seats - sièges zitplaatsen	size - taille - maat cm	size - taille - maat inch	Noa p. 42	Nero p. 48	Legna p. 56	Tecca p. 66	Nature p. 70	Flexx p. 72	Volte p. 78	Kudos p. 82	Mantra p. 83
	4 + 2	160 x 80 cm	62 x 31"				dining table			bar table dining table		
	4 + 2	160 x 100 cm	62 x 39"			dining table						
	4 + 2	170 x 80 cm	70 x 31"						bar table counter table			
	4 + 2	200 x 100 cm	79 x 39"	dining table								
	6 + 2	240 x 100 cm	94 x 39"		dining table	dining table			dining table	dining table		
	8 + 2	270 x 100 cm	106 x 39"	dining table								
	8 + 2	280 x 100 cm	110 x 39"				dining table					
	8 + 2	280 x 120 cm	110 x 47"					dining table low dining table				
	8 + 2	300 x 100 cm	118 x 39"		dining table				dining table	dining table		
	8 + 2	300 x 110 cm	118 x 47"							dining table		
	10 + 2	320 x 100 cm	126 x 39"			dining table						
	10 + 2	340 x 100 cm	134 x 39"									
	10 + 2	350 x 100 cm	138 x 39"				dining table					
	10 + 2	350 x 120 cm	138 x 47"					dining table low dining table				
	12 + 2	400 x 120 cm	157 x 47"					dining table low dining table				









# TABLES PER COLLECTION - TABLES PAR COLLECTION - TAFELS PER COLLECTIE

## FRAME - STRUCTURE

ref.	colour - couleur kleur	swatch - échantillon staal	material - matériel - materiaal	Noa p. 42	Nero p. 48	Legna p. 56	Tecca p. 66	Nature p. 70	Flexx p. 72	Volte p. 78	Kudos p. 82	Mantra p. 83	
W62	teak		tropical hardwood with smooth finish - bois franc à finition lisse - tropisch hardhout met gladde afwerking	X			X		X				
W64	sable teak		teak with bushed finish and coloured coating teck à finition brossée et revêtement coloré			X							
W68	black teak		teak met geborstelde afwerking en gekleurde coating		X								
A01	white		gepoederlakt aluminium aluminium thermolaqué aluminium powder coated							X	X	X	
A30	anthracite												X
A31	charcoal										X		
A32	black								X			X	

# TABLES PER COLLECTION - TABLES PAR COLLECTION - TAFELS PER COLLECTIE

## TABLE TOP - DESSUS DE LA TABLE - TAFELBLAD

ref.	colour - couleur kleur	swatch - échantillon staal	material - matériel - materiaal	Noa p. 42	Nero p. 48	Legna p. 56	Tecca p. 66	Nature p. 70	Flexx p. 72	Volte p. 78	Kudos p. 82	Mantra p. 83	
W62	teak		tropical hardwood with smooth finish - bois franc à finition lisse - tropisch hardhout met gladde afwerking	X			X	X	X	X			
W68	black teak		teak with bushed finish and coloured coating teck à finition brossée et revêtement coloré teak met geborstelde afwerking en gekleurde coating		X								
A01	white		gepoederlakt aluminium aluminium thermolaqué aluminium powder coated								X	X	
A30	anthracite												X
A32	black											X	
K01	white		hot galvanized powder coated steel plates, heavy and rust free			X				X			
K14	taupegrey		tôle d'acier galvanisé à chaud et thermolaqué. Un socle lourd et inoxydable			X							
K31	charcoal		warm verzinkte en gepoederlakte staalplaat, zwaar en roestvrij			X				X			

# GENERAL TERMS & CONDITIONS

## GENERAL

Our general sales and delivery terms and conditions, as outlined here, are deemed to have been accepted by the customer, even if these terms and conditions are at odds with the general or special purchase terms and conditions of our customer. The said terms and conditions shall only have binding effect on us in case we expressly agree with the same. Our agreement can never be derived from the mere fact that the terms and conditions to which the customer refers would have been accepted tacitly by us.

The buyer expressly declares to have taken note of these general terms and conditions and to accept the same. They are consequently deemed to form an integral part of the contractual relationship between the parties.

## ORDERS

Offers and quotations are only provided by way of indication and can never bring about any obligation, unless expressly determined otherwise. As the occasion arises, they shall have a validity of at most one month, unless determined otherwise. Offers are always exclusive of VAT, transport charges, statutory duties and taxes, etc.

## PRICES

Each and every sale is based on prices and general terms and conditions as included in our order confirmation. The prices and technical descriptions in our general catalogue are for information purposes only, without any obligation deriving from the same. We can change our prices at any time on the basis of economic fluctuations. The valid prices are mentioned on the order confirmation on the date of the order. Our prices are always available on request. Errors may occur in the prices, descriptions or images of certain goods in our catalogues or our sales material. We reserve the right to limit orders of these products.

The shipping costs on your invoice differ from those on your confirmation. This is mostly due to instability of the fuel economy. Please take into account that these costs are charged by the carrier and not by JARDINICO Parasols. The shipping costs on the order confirmation therefore provide an approximate indication and the buyer cannot derive any rights from this.

The total amount of the invoice must be paid within the time limit specified on the invoice.

## DELIVERY CONDITIONS

Our delivery and completion time limit shall not have binding effect, unless expressly stipulated otherwise. A delay in the delivery / completion can by no means give cause to compensation or interest. Force majeure, lock-out, industrial action, war, epidemic, etc. both on our part and on the part of our suppliers shall release us from each and every responsibility.

## COMPLAINTS AND EXCHANGES

The complaints regarding deliveries or completion of works must be communicated to us by registered post within 5 days after receipt of the goods or completion / finishing of the works. The complaints regarding invoices must be communicated to us by registered post within 5 days after the date of receipt of the invoice.

Not a single return of goods shall be accepted without our prior consent and without a filled in 'after-sales service' form. This form must be filled in by an official commercial partner of JARDINICO Parasols. This can be done via the website if one is logged in or via your contact person at JARDINICO Parasols. Moreover, they can only be taken back if the return shipment takes place in the same good condition as upon delivery. If a complaint was not received within the aforementioned time limit of 5 days after receipt of the goods or completion / finishing of the works then the buyer is deemed to have received the goods in a good condition and waives each and every claim vis-à-vis the seller.

Goods potentially taken back are credited subject to a reduction of 20% of the invoiced value. Visible defects are assumed to have been accepted failing objections within the aforementioned time limit. For normal invisible defects our liability shall be limited to the indemnification that is commonly provided by our suppliers / subcontractors. Our liability shall be limited to the replacement of the delivered goods within the warranty period as determined below.

## PAYMENTS

Incomplete performance of works can by no means give cause to refusal of payment of the delivered goods or works. Partial invoicing is allowed according to the progress of the goods and/or performance of the works. Each and every payment must take place in cash at our seat upon invoicing, unless stipulated otherwise in advance and in writing. All our invoices are payable in Harelbeke within the due date mentioned on the invoice. Partial payment is allocated in conformity with Section 1254 of the Belgian Civil Code.

## UNPAID ORDERS

In case of full or partial non-payment of the debt on the due date the invoice amount is by operation of law and without prior notice of default increased by an interest rate of 12% per annum from the due date. Failing specification of a particular due date it is deemed to coincide with the date of the invoice. In case of full or partial non-payment of the debt on the due date without serious reason compensation is also by operation of law and without prior notice of default payable at 12% of the principal sum with a minimum of EUR 125.00 and a maximum of EUR 2,500.00, even if grace periods are awarded and without prejudice to the possibilities foreseen by Section 1244 of the Belgian Civil Code.

In case of collection of outstanding invoices and disputes about agreements that were not implemented the statutorily established legal aid fee can be claimed by way of compensation for the costs of the lawyer. Moreover, we can, without prejudice to our right to claim compensation, if the customer does not comply with its obligations in a timely fashion or does not comply either in whole or in part, consider, always with notice by registered post and without prior notice of default, the agreement to be fully or partly inoperative by operation of law. As the occasion arises the customer must forthwith and within 48 hours after receipt of the notice make the identifiable (not incorporated) goods available to us. The non-payment on the due date of an invoice implies that the payable balance of all other invoices immediately falls due by operation of law, regardless of the previously permitted payment conditions.

## OWNERSHIP RIGHTS

Without prejudice to the risk of the customer with regard to the goods, we reserve the title of the goods delivered by us up to payment in full of the price. Upon the conclusion of the agreement and prior to the delivery of the goods the customer is expressly pointed to the said reservation of title and is, barring written objections, at the latest at the moment of the delivery, deemed to agree with the same. We also reserve the right to, provided with prior written notice of default, exercise a right of retention in respect of the goods of the customer that are in our possession by way of security for all outstanding claims.

In case of delivery of goods the risk for loss transfers, unless determined otherwise, as soon as the customer is informed that the goods are available at our seat. If the goods are stored further by us or are transported at the request of the customer then this takes place at the risk and expense of the customer. We, as well as the customer, expressly declare that any and all receivables of any nature whatsoever, present and future, that we have vis-à-vis each other are automatically settled between us with any and all payables of any nature whatsoever, present and future, that we are due vis-à-vis each other and the latter at the moment of the occurrence of the respective receivables and payables, regardless of their exigibility. In case of insolvency or dissolution of the customer of if the customer applies for a voluntary composition or legal restructuring in conformity with the Belgian Act of 31 January 2009 on the continuity of undertakings, we shall be entitled, at the moment of the insolvency declaration, dissolution or application for one of the procedures pursuant to the Belgian Act of 31 January 2009 by the customer, to settle receivables of any nature whatsoever still outstanding in respect of the customer, whether or not due and payable, with the then also still existing payables for our benefit, before one or more payments shall be made to the joint creditors of the insolvent, dissolved customer or customer relying on the Belgian Act of 31 January 2009.

## WARRANTY

We provide, barring different agreement of more or less, a maximum warranty of 2 years on our products. The warranty takes effect on the day that the product is purchased from an official commercial partner of JARDINICO Parasols (date of invoicing). The warranty applies to production and/or materials errors, caused by normal use. The product shall not be replaced in its entirety if a defective part and/or component can be replaced. JARDINICO Parasols shall by no means be held to provide a warranty if the defects are the result of improper or incorrect use by the final user.

## EXCEPTIONS TO THE WARRANTY

The warranty applies to production and/or materials errors, caused by normal use. The product shall not be replaced in its entirety if a defective part and/or component can be replaced. This warranty does not cover defects caused by incorrect assembly, defects as a result of changes by the buyer, intentional damages, incorrect use, abuse or negligence, not buying an associated base or ground anchor and normal wear and tear as a result of ageing and labour or assembly costs. The replacement of components shall be carried out by the final user or the retailer. JARDINICO Parasols limits itself, as the occasion arises, to making the components and/or parts to be replaced available to the said final user or retailer.

Our company reserves the right to remove a model from our collection at any time and without prior notice. All our spare parts remain in stock up to 2 years after the product has been discontinued. If the buyer establishes not to dispose of user instructions or user instructions that are unclear to the buyer then the buyer must report this immediately when making the purchase. If the buyer proceeded with installation of the purchased product, without the said notification, then the warranty expires. Products purchased during the sale before the end of a collection are never replaced or repaid. Parasol ribs fall outside the present warranty.

## DAMAGE DUE TO WIND DOES NOT FALL UNDER OUR LIMITED WARRANTY.

Natural disasters (including but not limited to wind, hurricanes, tornadoes and storms) and natural aspects of the ageing process do not fall under this warranty and are therefore not qualified as a defect. Not a single parasol, regardless of the size or the weight, can be left unattended in an open position. In case of windy circumstances it is recommended to close the parasols, to remove them from their base and to store or position them horizontally. This shall reduce the chance of damage to your parasol and other possessions or belongings.

The warranty does not cover discolouration, the bleeding of colours, changes in textures, scratches, breaks in or damages to lacquer due to use and/or defective maintenance / incorrect use. This enumeration is not exhaustive.

In due course natural teal turns grey. The surface may show discolouration. Appropriate treatments are available to ensure that the parasols retain their original appearance. Do not let dirt accumulate at the base. It is recommended to clean with mild soap and water. Never leave the base of the parasol standing in water. In case of use at the beach or an indoor pool salt and chlorine may accumulate on the powder coating and affect the finishing. To make sure that the base continues looking its best, you can best store it if it is not being used for a longer period of time.

The buyer expressly acknowledges to be informed of the above and also acknowledges that they cannot be qualified as a defect within the meaning of Section 1649ter of the Belgian Civil Code. The buyer moreover expressly acknowledges to have been informed of the fact that during the treatment of fabrics and metals colour differences may occur. The mere establishment of these kinds of colour differences shall never give cause to refusal of a delivery, unless the contrary was stipulated in advance and in writing.

## COMPETENT COURT

Only the courts of the district of Kortrijk are competent in respect of any and all disputes and Belgian law is applicable. Only JARDINICO Parasols can deviate from this.

# CONDITIONS GÉNÉRALES

## GÉNÉRALITÉS

Comme indiqué ci-après, les présentes conditions générales de vente sont réputées avoir été acceptées par le client, même si lesdites conditions sont contraires aux conditions générales ou à d'autres conditions particulières d'achat propres au client. Ces conditions ne peuvent nous engager qu'après notre accord exprès. Notre accord ne peut en aucun cas être supposé d'après quelque fait que ce soit selon lequel le client estime que notre silence vaut accord des conditions. L'acheteur déclare avoir pris connaissance des présentes conditions générales et les accepter. En conséquence, lesdites conditions générales sont réputées faisant partie intégrante de la relation contractuelle existant entre les parties.

## COMMANDES

Les devis et tarifications proposées ne sont que des indications, et ne peuvent en aucun cas former un engagement, sauf si cela est expressément défini. Dans ce cas, les devis et tarifications proposées sont valables un mois maximum, sauf autre accord contraire. Les devis sont toujours exprimés hors TVA, hors frais de transport, hors charges légales, etc. ...

## PRIX

Chaque vente est basée sur les prix et les conditions générales tel qu'indiqué dans notre confirmation de commande. Les prix et descriptions techniques de notre catalogue n'ont qu'un but informatif et ne peuvent en aucun cas former un engagement. Nous nous réservons le droit de modifier nos prix à tout moment en fonction de la situation économique. Les prix applicables sont indiqués sur la confirmation de commande, à la date de la commande. Nos prix sont toujours disponibles sur simple demande. Il peut éventuellement y avoir des erreurs dans les prix, les descriptions ou les représentations de certains articles de notre catalogue ou de nos supports de vente. Nous nous réservons le droit de limiter le nombre de commandes de ces articles. Les frais de livraison indiqués sur votre facture peuvent différer du montant figurant sur votre confirmation. Cela est dû à l'instabilité du marché du carburant. Veuillez tenir compte du fait que ces frais sont calculés par le transporteur et pas par JARDINICO Parasols. Par conséquent, les frais de livraison figurant sur la confirmation de commande ne sont qu'indicatifs, et l'acheteur ne peut en tirer aucun droit. Le montant total de la facture doit être payé dans le délai indiqué sur la facture.

## CONDITIONS DE LIVRAISON

Nos délais de livraison et d'exécution ne sont pas contraignants, sauf autre accord contraire. Un retard de livraison ou d'exécution ne peut en aucun cas donner lieu à un dédommagement ou à des intérêts. Les cas de force majeure, de lock-out, de grève, de conflits armés, d'épidémie, etc., que ce soit pour notre entreprise ou nos fournisseurs, nous libèrent de toute responsabilité.

## RÉCLAMATIONS ET ÉCHANGES

Les réclamations relatives aux livraisons ou à l'exécution des travaux doivent nous être adressées par courrier recommandé dans les 5 jours après réception des marchandises ou après exécution / conclusion des travaux. Les réclamations relatives aux factures doivent nous être adressées par courrier recommandé dans les 5 jours après réception de la facture. Aucune marchandise ne sera reprise sans notre accord préalable et sans le formulaire rempli « service après-vente ». Ce formulaire doit être rempli par un partenaire officiel de JARDINICO Parasols. Cette démarche est possible en se connectant à votre espace ou en contactant votre personne de contact chez JARDINICO Parasols. En outre, les marchandises concernées ne peuvent être reprises que si elles sont en bon état, comme à la livraison. Si aucune réclamation n'est faite dans le délai précité de 5 jours après réception des marchandises ou après exécution / conclusion des travaux, l'acheteur est réputé les avoir accepté(e)s en bon état et renoncer à tout droit à l'égard du vendeur. Les éventuelles marchandises reprises feront l'objet d'un crédit diminué de 20 % du montant de la facture. Les défauts visibles sont réputés acceptés à défaut d'une réclamation dans les délais indiqués précédemment. Pour les défauts cachés et normaux, notre responsabilité se limite à la garantie offerte par nos fournisseurs ou nos sous-traitants. Notre responsabilité se limite au remplacement des marchandises livrées endéans les délais de garantie tel que prévu ci-dessus.

## PAIEMENTS

L'exécution incomplète des travaux ne peut en aucun cas donner lieu à un refus de paiement des marchandises livrées ou des travaux effectués. Une facturation partielle peut être réalisée selon la livraison des marchandises et/ou l'exécution des travaux. Chaque paiement doit être effectué en une seule fois, par facturation à notre siège, sauf autre accord écrit préalable. Toutes nos factures sont payées à Harelbeke dans le délai indiqué sur la facture en question. Le paiement partiel est appliqué conformément à l'art. 1254 du Code civil.

## COMMANDES IMPAYÉES

En cas de non paiement total ou partiel du montant dû à la date d'échéance de la facture, le montant de celle-ci est majoré de droit et sans mise en demeure préalable d'un intérêt de 12 % par an à compter de la date d'échéance. En cas d'absence de date d'échéance, celle-ci est supposée correspondre à la date de facturation. En cas de non-paiement total ou partiel du montant dû à la date d'échéance sans justification appropriée, un dédommagement à hauteur de 12 % du montant facturé est appliqué, avec un minimum de 125,00 EUR et un maximum de 2 500,00 EUR, de droit et sans mise en demeure préalable, même dans le cas où une période de différé a été accordée et sans préjudice des possibilités prévues à l'article 1244 du Code civil.

Dans la **structure** du recouvrement de factures impayées et de contestations quant à des accords non respectés, il peut être fait appel à une aide juridique servant de participation aux frais d'avocat. En outre, si le client ne respecte pas ses obligations dans les délais impartis, ou ne les respecte pas en tout ou en partie à tout moment, et sans préjudice de notre droit à exiger un dédommagement, nous nous réservons le droit de considérer le contrat comme nul, en tout ou en partie, par notification par courrier recommandé et sans mise en demeure préalable. Dans ce cas, le client est tenu de mettre à notre disposition les marchandises identifiables (non incorporées) le plus rapidement possible et au plus tard dans les 48 heures après la notification. Le non-paiement d'une facture rend le montant des autres factures immédiatement exigible de plein droit, peu importe les conditions de paiement acceptées préalablement.

## DROIT DE PROPRIÉTÉ

Sans préjudice du risque du client quant aux marchandises, nous conservons notre réserve de propriété sur les marchandises livrées jusqu'au paiement total du prix correspondant. Le client est expressément informé de cette réserve de propriété au moment de conclure le contrat et avant la livraison des marchandises et, à défaut de réclamation écrite au plus tard au moment de la livraison, il est réputé avoir accepté cette réserve. De plus, nous nous réservons le droit d'exercer un droit de rétention sur les marchandises du client toujours en notre possession pour servir de garantie aux créances en cours, à condition de lui faire parvenir au préalable une mise en demeure écrite. Pour la livraison des marchandises, et sauf autre accord contraire, le risque de perte est transféré dès que le client a été informé que lesdites marchandises sont disponibles à notre siège. Si les marchandises sont conservées dans nos locaux ou, sur demande du client, sont transportées ailleurs, c'est le client qui en porte la responsabilité et le risque. Nous-mêmes ainsi que le client déclarons expressément accepter que toutes les créances, de toute nature que ce soit, actuelles ou futures, et dont nous sommes redevables l'un à l'autre, soient compensées automatiquement par toute créance que ce soit, peu importe sa nature, qu'elle soit actuelle ou future et dont nous sommes redevables l'un à l'autre, et ce, au moment où apparaissent les créances respectives, peu importe leur exigibilité. En cas de faillite ou de dissolution du client, ou si le client demande un accord à l'amiable ou une réorganisation judiciaire, conformément à la loi du 31.01.2009 relative à la continuité des entreprises, nous avons le droit de compenser, à la charge du client, toute créance, de toute nature que ce soit, exigible ou non, encore existante au moment de la déclaration de faillite, de la dissolution ou de la demande de l'une des procédures prévues par la loi du 31.01.2009, avec les créances en notre faveur encore existantes à ce moment-là, avant de procéder à l'un ou l'autre versement aux créanciers communs du client failli, dissolu ou faisant appel à la loi du 31.01.2009.

## GARANTIE

Nous accordons, sauf autre accord contraire supérieur ou inférieur, maximum 2 ans de garantie sur nos produits. La garantie prend effet le jour où le produit est acheté auprès d'un partenaire officiel de JARDINICO Parasols (date de facturation). La garantie s'applique aux défauts de production et

ou aux défauts de matériel engendrés par un usage normal. Le produit ne sera pas entièrement remplacé si la pièce et/ou le composant défectueux peut être remplacé. JARDINICO Parasols n'est aucun cas tenu d'offrir une garantie lorsque les défauts sont la conséquence d'un usage impropre ou abusif par l'utilisateur final.

## EXCLUSIONS DE GARANTIE

La garantie s'applique uniquement aux défauts de production et/ou aux défauts de matériel engendrés par un usage normal. Le produit ne sera pas remplacé si la pièce et/ou le composant défectueux peut être remplacé. La garantie ne couvre pas les défauts causés par une mauvaise installation, par des modifications effectuées par l'acheteur, ni les défauts intentionnels, ou causés par une mauvaise utilisation, une utilisation abusive ou par la négligence. Elle ne couvre pas non plus les défauts causés par le non-achat d'un pied ou d'une base adaptée, ni ceux causés par l'usure normale au fil du temps et de l'utilisation. Enfin, elle ne couvre pas non plus les frais d'installation. Le remplacement de pièces détachées sera effectué par l'utilisateur final ou par le commerçant de détail. Dans ce cas, JARDINICO Parasols s'engage seulement à mettre les pièces détachées et/ou les composants à remplacer à la disposition de l'utilisateur final ou du commerçant de détail. Notre entreprise se réserve le droit de retirer un modèle de sa collection, à tout moment, et sans notification préalable. Toutes les pièces détachées de réserve restent en stock 2 ans après l'arrêt de la production du produit concerné. Si l'acheteur indique ne pas être en possession d'un mode d'emploi ou être en possession d'un mode d'emploi imprécis pour lui, il doit immédiatement le dire au moment de l'achat. Si l'acheteur procède néanmoins à l'installation du produit acheté, sans avoir notifié l'absence de mode d'emploi, la garantie ne pourra pas être appliquée. Les articles achetés en liquidation de fin de série ne sont ni remplacés ni remboursés. Les baleines de parasols sont exclues de la garantie.

## LES DÉGÂTS CAUSÉS PAR LE VENT SONT EXCLUS DE LA GARANTIE.

Les catastrophes naturelles (y compris mais non limitées au vent, aux ouragans, aux tornades et aux tempêtes) ainsi que les aspects naturels du vieillissement sont exclus de la garantie et ne peuvent donc être considérés comme étant à l'origine de défauts. Aucun parasol, peu importe la taille ou le poids, ne doit être laissé en position ouverte sans surveillance. En cas de vents violents, il est fortement conseillé de fermer les parasols, de les enlever de leur pied et de les ranger à l'horizontale. Cela réduit le risque de dégâts sur votre parasol et sur d'autres objets et biens. La garantie ne couvre pas la coloration, la décoloration, la modification de la texture, les rayures, les déchirures ou les dégâts à la peinture en lien avec l'utilisation et/ou le manque d'entretien ou la mauvaise utilisation. Cette liste est non exhaustive. Avec le temps, le teck devient naturellement grisâtre. La surface peut prendre une certaine coloration. Il existe des traitements adaptés permettant de conserver l'état original des parasols. N'entassez aucun déchet au pied du parasol. Il est recommandé de nettoyer le parasol au savon doux et à l'eau. Ne laissez jamais le pied du parasol dans l'eau. En cas d'utilisation à la plage ou en piscine couverte, le sel et le chlore peuvent s'attaquer au revêtement et l'endommager. Pour garder le pied dans son état d'origine, il est recommandé de le ranger à l'abri lorsqu'il n'est pas utilisé sur une période prolongée. L'acheteur déclare avoir été informé des questions traitées ci-dessus et accepte que celles-ci ne pourront pas être considérées comme non-conforme au contrat au sens de l'article 1649ter du Code civil. L'acheteur déclare en outre être au courant du fait que le traitement de tissus et de métaux peut engendrer des variations de couleurs. L'identification simple de ces variations de couleurs ne peut en aucun cas donner lieu au refus de livraison, sauf accord contraire convenu au préalable.

## JURIDICTION

Tous les litiges sont la compétence exclusive des tribunaux de l'arrondissement de Courtrai et sont soumis au droit belge. Seul JARDINICO Parasols peut s'en écarter.

# ALGEMENE VOORWAARDEN

## ALGEMEEN

Onze algemene verkoop- en leveringsvoorwaarden zoals hierbij vermeld worden geacht door de klant te zijn aanvaard, zelfs indien deze voorwaarden in tegenspraak zijn met de eigen algemene of bijzondere aankoopvoorwaarden van onze klant. Deze voorwaarden kunnen ons enkel binden in geval uitdrukkelijk akkoord van onzentwege. Ons akkoord kan nooit worden afgeleid uit het enkele feit dat de voorwaarden waarnaar de klant verwijst door ons stilzwijgen zouden aanvaard zijn. De koper verklaart uitdrukkelijk kennis genomen te hebben van deze algemene voorwaarden en deze aanvaard te hebben. Bijgevolg worden deze geacht integraal deel uit te maken van de contractuele verhouding tussen partijen.

## BESTELLINGEN

Offertes en prijsstellingen worden enkel als inlichting gegeven, maar kunnen nooit enige verbintenissen meebrengen, tenzij uitdrukkelijk anders bepaald. In dergelijk geval gelden zij hoogstens één maand, tenzij anders bepaald. Offertes zijn altijd exclusief BTW, transportkosten, wettelijke lasten en taksen, enz....

## PRIJZEN

Elke verkoop is gevoerd op prijzen en algemene voorwaarden zoals opgenomen in onze bestelbevestiging. De prijzen en technische omschrijvingen in onze algemene catalogus zijn slechts ter informatie, zonder dat daaruit enige verbintenissen voortvloeien. We kunnen onze prijzen op elk moment herzien in functie van economische veranderingen. De geldige prijzen worden vermeld op de bestelbevestiging, op datum van de bestelling. Onze prijzen zijn te allen tijde beschikbaar op aanvraag. Er kunnen fouten voorkomen in de prijzen, beschrijvingen of afbeeldingen van bepaalde goederen in onze catalogus of ons verkoopmateriaal. Wij behouden ons het recht voor om bestellingen van die artikelen te beperken. De verzendkosten op uw factuur kunnen verschillen van die op uw bestelling. Dit komt grotendeels door instabiliteit van de brandstofeconomie. Houd er alstublieft rekening mee dat deze kosten door de vervoerder worden berekend, en niet door JARDINICO Parasols. De verzendkosten op de bestelbevestiging zijn derhalve slechts richtingsgevend en de koper kan hieruit geen enkel recht putten. Het totaalbedrag van de factuur moet betaald worden binnen de termijn die vermeld wordt op de factuur.

## LEVERINGSVOORWAARDEN

Onze levering- en uitvoeringstermijn is niet bindend, tenzij uitdrukkelijk anders overeengekomen. Een vertraging bij de levering/uitvoering kan in geen enkel geval aanleiding geven tot schadevergoeding of interesten. Overmacht, lock-out, staking, oorlog, epidemie, enz. ... zowel bij ons als bij onze leveranciers stellen ons vrij van elke verantwoordelijkheid.

## KLACHTEN EN OMRULINGEN

De klachten nopens leveringen of uitvoering van werken dienen per aangetekende brief aan ons te worden overgemaakt binnen de 5 dagen na ontvangst van de goederen of uitvoering/afwerking van de werken. De klachten nopens facturatie dienen per aangetekende brief aan ons te worden overgemaakt binnen de 5 dagen na datum van ontvangst van de factuur. Geen enkele terugname van goederen zal aanvaard worden zonder voorafgaandelijk akkoord van onzentwege en ingevuld formulier 'dienst na verkoop'. Dit formulier moet ingevuld worden door een officiële handelspartner van JARDINICO Parasols. Dit kan via de website wanneer men is ingelogd of via uw contactpersoon bij JARDINICO Parasols. Daarenboven kunnen zij slechts teruggenomen worden zo de terugzending geschiedt in dezelfde goede staat als bij aflevering. Indien geen klacht werd ontvangen binnen bovenstaande termijn van 5 dagen na ontvangst van de goederen of uitvoering/afwerking van de werken, wordt de koper geacht het goed ontvangen te hebben in een goede staat en ziet hij af van elk verhaal jegens de verkoper. Eventuele teruggenomen goederen worden gecrediteerd met een vermindering van 20% van de gefactureerde waarde. Zichtbare gebreken worden verondersteld aanvaard te zijn bij gebreke aan protest binnen de hoger omschreven termijn. Voor gewone verborgen gebreken zal onze aansprakelijkheid beperkt zijn tot de vrijwaring die gebruikelijk door onze leveranciers/onderaannemers wordt verstrekt. Onze aansprakelijkheid is beperkt tot de vervanging van de geleverde goederen binnen de garantietermijn zoals hieronder bepaald.

## BETALINGEN

Onvolledige uitvoering van werken kan in geen geval aanleiding geven tot weigering van betaling van de geleverde goederen of werken. Gedeeltelijke facturatie mag worden opgemaakt naargelang de levering der goederen en/of uitvoering van de werken. Elke betaling dient contant op onze zetel te gebeuren bij facturatie, tenzij voorafgaandelijk en schriftelijk anders werd overeengekomen. Al onze facturen zijn betaalbaar te Harelbeke binnen de op de factuur vermelde vervalt termijn. Gedeeltelijke betaling wordt toegerekend conform art. 1254 B.W.

## ONBETAALDE BESTELLINGEN

Bij gehele of gedeeltelijke niet betaling van de schuld op de vervaldag wordt van rechtswege en zonder voorafgaandelijke ingebrekestelling het factuurbedrag verhoogd met een rente van 12% per jaar vanaf de vervaldag. Bij gebreke van vermelding van een bijzondere vervaldag wordt deze geacht samen te vallen met de factuurdatum. In geval van gehele of gedeeltelijke niet betaling van de schuld op de vervaldag zonder ernstige reden wordt eveneens van rechtswege en zonder voorgaande ingebrekestelling een schadevergoeding aangerekend ten belope van 12% van de hoofdsom met een minimum van 125,00 EUR en een maximum van 2.500,00 EUR, zelfs bij toekenning van termijnen van respijt en zonder afbraak te doen aan de mogelijkheden voorzien door artikel 1244 B.W.

Bij invordering van openstaande facturen en betwistingen omtrent niet uitgevoerde overeenkomsten kan aanspraak gemaakt worden op de wettelijk vastgelegde rechtsplegingsvergoeding als tegemoetkoming in de kosten van de advocaat. Bovendien kunnen wij, onverminderd ons recht op schadevergoeding, indien de klant zijn verplichtingen niet tijdig nakomt dan wel geheel of gedeeltelijk niet nakomt te allen tijde met kennisgeving per aangetekende post en zonder voorgaande ingebrekestelling het contract van rechtswege geheel of gedeeltelijk als onbestaande beschouwen. In dit geval moet de klant onverwijld en uiterlijk binnen de 48 uur na ontvangst van de kennisgeving de identificeerbare (niet geïncorporeerde) goederen ter onzer beschikking stellen. De niet betaling op de vervaldag van een factuur maakt het verschuldigd saldo van alle andere facturen van rechtswege onmiddellijk opeisbaar, ongezien van de bij voorbaat toegestane betalingsvoorwaarden.

## EIGENDOMSRECHT

Onverminderd het risico van de klant met betrekking tot de goederen behouden wij ons eigendomsvoorbehoud op de geleverde goederen voor tot volledige betaling van de prijs. De klant wordt bij het tot stand komen van de overeenkomst en voor de levering van de goederen uitdrukkelijk gewezen op dit eigendomsvoorbehoud en wordt behoudens schriftelijk protest, uiterlijk op het moment van de levering, verondersteld hiermee in te stemmen. Wij behouden ons tevens het recht voor om mits voorafgaandelijke schriftelijke ingebrekestelling een retentierecht uit te oefenen op de goederen van de klant in ons bezit tot zekerheidsstelling van alle openstaande vorderingen. Bij levering van goederen gaat het risico voor verlies, tenzij anders bepaald, over van zodra de klant verwittigd wordt dat de goederen op onze zetel beschikbaar zijn. Wanneer de goederen verder bij ons bewaard worden, of, op vraag van de klant vervoerd worden, gebeurt dit voor rekening en op risico van de klant. Wij alsmede de klant verklaren uitdrukkelijk dat alle schuldvorderingen van welke aard dan ook, huidige en toekomstige, waarover zij jegens elkaar beschikken, tussen hen onderling automatisch gecompenseerd worden met alle schulden van welke aard ook, huidige en toekomstige, die zij jegens elkaar verschuldigd zijn en dit op het ogenblik van het ontstaan van de respectieve schuldvorderingen en schulden, onafhankelijk van hun opeisbaarheid. In geval van faillissement of ontbinding van de klant of indien de klant het minnelijk akkoord of de gerechtelijke reorganisatie aanvraagt conform de wet van 31.01.2009 op de continuïteit der ondernemingen, zullen wij het recht hebben om de op het ogenblik van de faillietverklaring, ontbinding of aanvraag van één van de procedures van de wet van 31.01.2009 door de klant, ten laste van deze laatste nog bestaande, al dan niet opeisbare schuldvorderingen van welke aard dan ook, te compenseren met de ten voordele van ons op datzelfde ogenblik nog bestaande schulden, vooraleer één of andere storting aan de gezamenlijke schuldeisers van de gefailleerde, ontbonden of de zich op de wet van 31.01.2009 beroepende klant te doen.

## GARANTIE

Wij verlenen, behoudens andersluidende overeenkomst in meer of in min, maximaal 2 jaar garantie op onze producten. De garantie start op de dag dat het product door een officiële handelspartner van JARDINICO Parasols is aangekocht (facturatedatum). De garantie is van toepassing op productie- en/of materiaal fouten, veroorzaakt ten gevolge van een normaal gebruik. Het product zal niet geheel vervangen worden als een defect onderdeel en/of component vervangen kan worden. JARDINICO Parasols zal geenszins tot garantie gehouden zijn wanneer de gebreken het gevolg zijn van een oneigenlijk of verkeerd gebruik door de eindgebruiker.

## UITZONDERINGEN VAN DE GARANTIE

De garantie is enkel van toepassing op productie- en/of materiaal fouten, veroorzaakt ten gevolge van een normaal gebruik. Het product zal niet vervangen worden als een defect onderdeel en/of component vervangen kan worden. Deze garantie dekt geen defecten veroorzaakt door onjuiste montage, defecten als gevolg van wijzigingen door de koper, opzettelijke schade, verkeerd gebruik, misbruik of nalatigheid, het niet aankopen van een bijpassende voet of grondanker en normale slijtage als gevolg van leeftijd en arbeid of montagekosten. Het vervangen van onderdelen zal uitgevoerd worden door de eindgebruiker of de detailhandelaar. Jardinico PARASOLS beperkt zich in dergelijk geval enkel tot het ter beschikking stellen van de te vervangen onderdelen en/of componenten van deze eindgebruiker of de detailhandelaar. Ons bedrijf behoudt zich het recht voor om op elk moment en zonder voorafgaande kennisgeving een Frame te schrappen uit de collectie. Al onze reserveonderdelen blijven in stock tot 2 jaar nadat het product werd stopgezet. Wanneer de koper vaststelt niet over een gebruiksaanwijzing of een voor hem/haar onduidelijke gebruiksaanwijzing te beschikken, moet dit onmiddellijk gemeld worden bij aankoop. Indien de koper is overgegaan tot installatie van het gekochte product, zonder deze voorafgaande melding, vervalt alle garantie. Artikelen aangekocht in uitvoer voor einde collectie worden nooit vervangen of terugbetaald. Parasolribben vallen buiten de huidige garantie.

## SCHADE DOOR WIND VALT NIET ONDER ONZE BEPERKTE GARANTIE.

Natuurrampen (inclusief maar niet beperkt tot wind, orkanen, tornado's en stormen) en natuurlijke aspecten van het verouderingsproces vallen niet onder deze garantie en worden daarom niet als een defect beschouwd. Geen enkele parasol, ongeacht de grootte of het gewicht, mag onbeheerd worden achtergelaten in open positie. Bij minderige omstandigheden wordt aanbevolen om parasols te sluiten, van hun voet te verwijderen en op te bergen of horizontaal neer te leggen. Dit zal de kans op schade aan uw parasol en andere bezittingen of eigendommen verminderen. De garantie dekt geen verkleuring, het uitlopen van kleuren, veranderingen in texturen, krassen, barsten of schade in lak, ontstaan door gebruik en/of gebrekiger onderhoud/verkeerd gebruik. Deze opsomming is niet-limitatief. Na verloop van tijd wordt natuurlijk teak grijs. Het oppervlak kan verkleuring vertonen. Er zijn passende behandelingsmiddelen beschikbaar om ervoor te zorgen dat de parasols hun oorspronkelijke uiterlijk behouden. Laat geen vuil opstapelen op de voet. Het wordt aanbevolen om te reinigen met milde zeep en water. Laat de voet van de parasol nooit in water staan. Bij gebruik aan het strand of een binnenzwembad kunnen zout & chloor zich gaan opstapelen op de powder coating en de afwerking aantasten. Om ervoor te zorgen dat de voet er op zijn best blijft uitzien, kan u ze best opbergen wanneer hij voor langere tijd niet wordt gebruikt. De koper erkent uitdrukkelijk op de hoogte te zijn van bovenstaande zaken en erkent eveneens dat deze niet beschouwd kunnen worden als een gebrek aan overeenstemming in de zin van artikel 1649ter BW. De koper erkent daarnaast uitdrukkelijk in kennis te zijn gesteld dat bij de bewerking van stoffen en metalen kleurverschillen kunnen bestaan. De louterende vaststellingen van dergelijke kleurverschillen zal nooit aanleiding kunnen zijn tot weigering van enige levering, tenzij het tegendeel schriftelijk en op voorhand bedongen werd.

## BEVOEGDE RECHTBANK

Voor alle geschillen zijn alleen de Rechtbanken van het arrondissement Kortrijk bevoegd en is het Belgisch recht van toepassing. Enkel Jardinico PARASOLS kan hiervan afwijken.



jardinico<sup>®</sup>

Evolis 101  
8530 Harelbeke  
Belgium  
+32 (0)56 89 04 10

[info@jardinico.com](mailto:info@jardinico.com)  
[www.jardinico.com](http://www.jardinico.com)

