



Lista PVP - España

Updated Actualizada  
1 / 1 / 2024



Base Collection  
Colección de bases

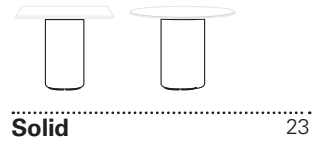
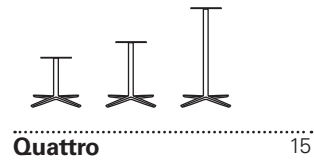
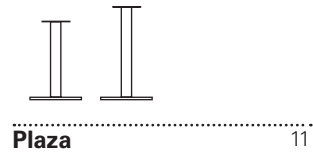
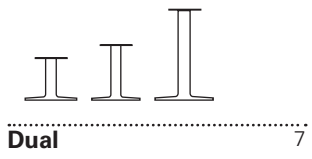

Table tops  
Sobres de mesa

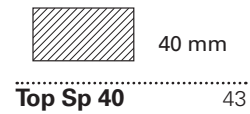
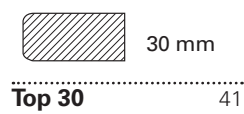
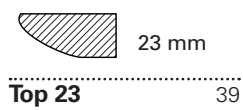
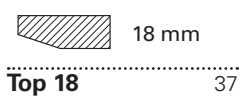
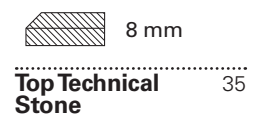
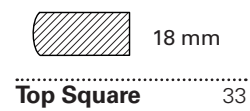
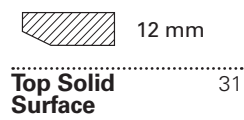
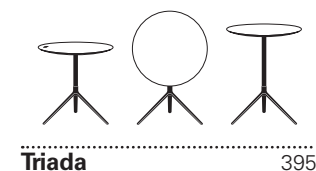
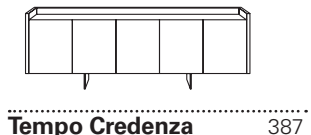
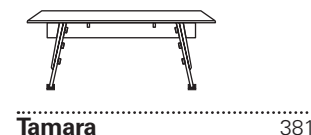
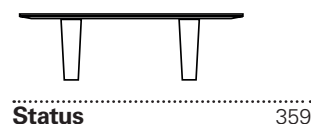
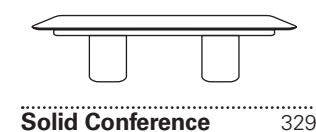
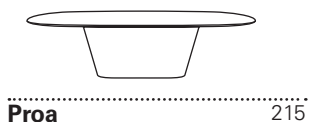
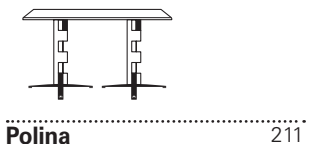
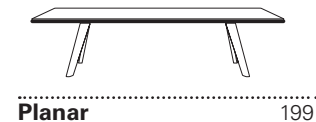
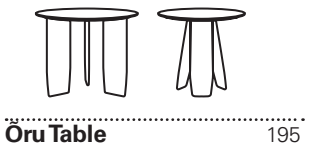
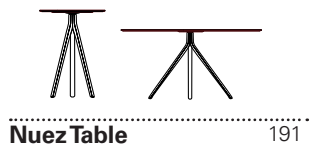
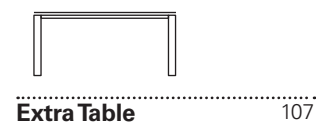
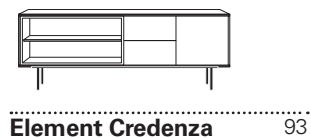
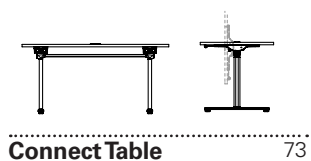
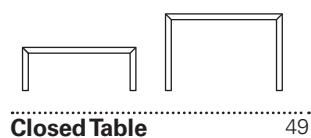

Table Programs  
Programas de mesa



Occasional tables  
Mesas ocasionales



Alla Occasional 401

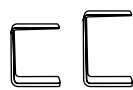

Arc Table 403



Bolete Occasional Table **NEW** 405

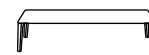

Couvé Table 413



Dual Occasional 417



Element Table 421

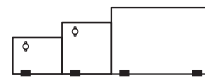

Nazar Occasional 425



Nuez Table Occasional 427



Oliva 431



Oru Table Occasional 433



Quattro Occasional 435



Raglan Table 439



Reverse Occasional 443



Reverse Occasional Wood 453



Reverse Occasional TP 457



Ruta Table 459



Taras Occasional 463



Triada Occasional 465



Uves Occasional 467

.....  
Sales conditions/Remarks 472

Maintenance 474

.....  
Certificate 476

.....  
Condiciones venta/Obs. 473

Mantenimiento 475

.....  
Certificados 476



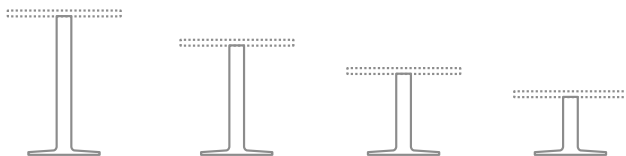

**Description**  
**Descripción**

Injected aluminum table base with an oval column and rounded base plate. Available in 3 different diameters and 4 heights. Offered in polished aluminum, matte white or matte black. Combinable with any model from our Top collection.

Base de mesa con pie circular y columna ovalada de inyección de aluminio. Disponible en 3 diámetros y 4 alturas diferentes. Se ofrece en acabados aluminio pulido, blanco mate o negro mate. Combinable con cualquier modelo de la colección Top.

**Aluminum finish**  
**Acabado aluminio**



**Certificates**  
**Certificados**

Quality - Resistance  
Calidad - Resistencia

UNE CEN/TR 581-4

Durability of exterior-grade furniture.  
Durabilidad de mobiliario de exterior.

**Intellectual property Propiedad intelectual**

All our collections are protected by international industrial design registries, designs patents, copyrights and intellectual Property laws. Unauthorized use of AW International Property is a criminal offence and can lead to prosecution.

Todas nuestras colecciones están protegidas por registros de diseño industrial, diseño de patente, copyright y derechos de propiedad intelectual en todo el mundo. El uso no autorizado de los diseños y propiedad intelectual de AW supone un delito que puede ser sometido a acción judicial.



Dual 45

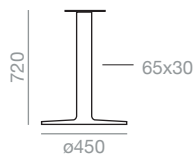

Maximum table top 600x600 / ø700. Minimum table top 470x470 / ø550. Estimated table base assembly time 3 minutes. The price of the unassembled table bases applies only to orders greater than 10 units.

Medida máxima de sobre 600x600 / ø700. Medida mínima de sobre 470x470 / ø550. Tiempo estimado de montaje por base 3 min. El precio de las bases desmontadas se aplicará sólo para pedidos a partir de 10 unidades.

**BM3340**

Polished aluminium Aluminio pulido

Assembled	Montada	330
Unassembled	Desmontada	307

0'17 m3  
16 kg  
x1  
1 boxes bultos

Unassembled  
Desmontada

0'04 m3  
x1

**BM3342**

Matte white or black / Blanco o negro mate

Assembled	Montada	312
Unassembled	Desmontada	290

Dual 45

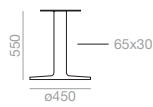

Maximum table top 800x800 / ø800. Minimum table top 470x470 / ø550. Estimated table base assembly time 3 minutes. The price of the unassembled table bases applies only to orders greater than 10 units.

Medida máxima de sobre 800x800 / ø800. Medida mínima de sobre 470x470 / ø550. Tiempo estimado de montaje por base 3 min. El precio de las bases desmontadas se aplicará sólo para pedidos a partir de 10 unidades.

**BM3346**

Polished aluminium Aluminio pulido

Assembled	Montada	311
Unassembled	Desmontada	295

0'13 m3  
11 kg  
x1  
1 boxes bultos

Unassembled  
Desmontada

0'04 m3  
x1

**BM3347**

Matte white or black / Blanco o negro mate

Assembled	Montada	303
Unassembled	Desmontada	285

Dual 45

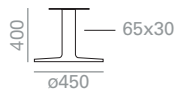

Maximum table top 800x800 / ø800. Minimum table top 470x470 / ø550. Estimated table base assembly time 3 minutes. The price of the unassembled table bases applies only to orders greater than 10 units.

Medida máxima de sobre 800x800 / ø800. Medida mínima de sobre 470x470 / ø550. Tiempo estimado de montaje por base 3 min. El precio de las bases desmontadas se aplicará sólo para pedidos a partir de 10 unidades.

**BM3352**

Polished aluminium Aluminio pulido

Assembled	Montada	306
Unassembled	Desmontada	291

0'1 m3  
10 kg  
x1  
1 boxes bultos

Unassembled  
Desmontada

0'04 m3  
x1

**BM3353**

Matte white or black / Blanco o negro mate

Assembled	Montada	301
Unassembled	Desmontada	277

Dual 50

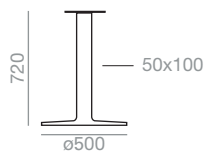

Maximum table top 1000x1000 / ø1000. Minimum table top 520x520 / ø550. Estimated table base assembly time 3 minutes. The price of the unassembled table bases applies only to orders greater than 10 units.

Medida máxima de sobre 1000x1000 / ø1000. Medida mínima de sobre 520x520 / ø550. Tiempo estimado de montaje por base 3 min. El precio de las bases desmontadas se aplicará sólo para pedidos a partir de 10 unidades.

**BM4391**

Polished aluminium Aluminio pulido

Assembled	Montada	466
Unassembled	Desmontada	438

0'2 m3  
24 kg  
x1  
1 boxes bultos

Unassembled  
Desmontada

0'06 m3  
x1

**BM4392**

Matte white or black / Blanco o negro mate

Assembled	Montada	413
Unassembled	Desmontada	382



## Dual 50

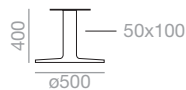

Maximum table top 1000x1000 /  $\varnothing$ 1000. Minimum table top 520x520 /  $\varnothing$ 550. Estimated table base assembly time 3 minutes. The price of the unassembled table bases applies only to orders greater than 10 units.

Medida máxima de sobre 1000x1000 /  $\varnothing$ 1000. Medida mínima de sobre 520x520 /  $\varnothing$ 550. Tiempo estimado de montaje por base 3 min. El precio de las bases desmontadas se aplicará sólo para pedidos a partir de 10 unidades.

### BM4388

Polished aluminium Aluminio pulido

Assembled	Montada	431
Unassembled	Desmontada	402

0'12 m3  
 13 kg  
 x1  
 1 boxes bultos

Unassembled  
Desmontada

0'06 m3  
 x1

### BM4389

Matte white or black / Blanco o negro mate

Assembled	Montada	392
Unassembled	Desmontada	354

## Dual 60

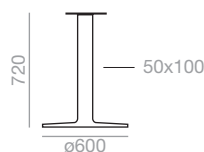

Maximum table top 1200x1200 /  $\varnothing$ 1200. Minimum table top 520x520 /  $\varnothing$ 550. Estimated table base assembly time 3 minutes. The price of the unassembled table bases applies only to orders greater than 10 units.

Medida máxima de sobre 1200x1200 /  $\varnothing$ 1200. Medida mínima de sobre 520x520 /  $\varnothing$ 550. Tiempo estimado de montaje por base 3 min. El precio de las bases desmontadas se aplicará sólo para pedidos a partir de 10 unidades.

### BM3355

Polished aluminium Aluminio pulido

Assembled	Montada	496
Unassembled	Desmontada	467

0'29 m3  
 26 kg  
 x1  
 1 boxes bultos

Unassembled  
Desmontada

0'07 m3  
 x1

### BM3356

Matte white or black / Blanco o negro mate

Assembled	Montada	467
Unassembled	Desmontada	440

## Dual 60

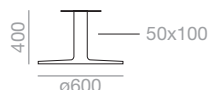

Maximum table top 1200x1200 /  $\varnothing$ 1200. Minimum table top 520x520 /  $\varnothing$ 550. Estimated table base assembly time 3 minutes. The price of the unassembled table bases applies only to orders greater than 10 units.

Medida máxima de sobre 1200x1200 /  $\varnothing$ 1200. Medida mínima de sobre 520x520 /  $\varnothing$ 550. Tiempo estimado de montaje por base 3 min. El precio de las bases desmontadas se aplicará sólo para pedidos a partir de 10 unidades.

### BM3375

Polished aluminium Aluminio pulido

Assembled	Montada	460
Unassembled	Desmontada	433

0'17 m3  
 16 kg  
 x1  
 1 boxes bultos

Unassembled  
Desmontada

0'07 m3  
 x1

### BM3376

Matte white or black / Blanco o negro mate

Assembled	Montada	443
Unassembled	Desmontada	414

## Dual 60

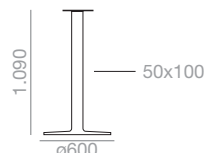

Maximum table top 900x900 /  $\varnothing$ 900. Minimum table top 520x520 /  $\varnothing$ 550. Estimated table base assembly time 3 minutes. The price of the unassembled table bases applies only to orders greater than 10 units.

Medida máxima de sobre 900x900 /  $\varnothing$ 900. Medida mínima de sobre 520x520 /  $\varnothing$ 550. Tiempo estimado de montaje por base 3 min. El precio de las bases desmontadas se aplicará sólo para pedidos a partir de 10 unidades.

### BM4375

Polished aluminium Aluminio pulido

Assembled	Montada	552
Unassembled	Desmontada	525

0'43 m3  
 28 kg  
 x1  
 1 boxes bultos

Unassembled  
Desmontada

0'07 m3  
 x1

### BM4376

Matte white or black / Blanco o negro mate

Assembled	Montada	497
Unassembled	Desmontada	470



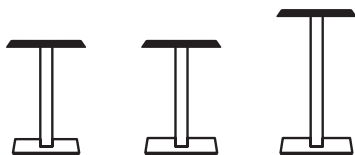

**Description** Table base with central round or square column in solid beech or aluminum with square injected aluminum base available in matte white, matte black or polished aluminum finish. Able to be combined with any of the models from the Top Collection.

**Descripción** Base central de mesa con columna cuadrada o redonda disponible en madera maciza de haya y aluminio, y base cuadrada disponible en madera maciza de haya y aluminio. Combinable con cualquier modelo de la colección Top.

**Wood finish Beech**  
**Acabado madera Haya**



**Wood lacquer finish**  
**Acabado lacas madera**



**Aluminum finish**  
**Acabado aluminio**



**Certificates** Quality - Resistance      UNE CEN/TR 581-4      Durability of exterior-grade furniture.

**Certificados** Calidad - Resistencia      Durabilidad de mobiliario de exterior.

**Intellectual property Propiedad intelectual**

All our collections are protected by international industrial design registries, designs patents, copyrights and intellectual Property laws. Unauthorized use of AW International Property is a criminal offence and can lead to prosecution.  
Todas nuestras colecciones están protegidas por registros de diseño industrial, diseño de patente, copyright y derechos de propiedad intelectual en todo el mundo. El uso no autorizado de los diseños y propiedad intelectual de AW supone un delito que puede ser sometido a acción judicial.



400x400

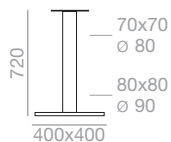

Aluminum  
Wood

Maximum table top 700x700 / ø800.  
Minimum table top 470x470 / ø550.  
Estimated table base assembly time 3 minutes. The price of the unassembled table bases applies only to orders greater than 10 units.

Medida máxima de sobre 700x700 / ø800.  
Medida mínima de sobre 470x470 / ø550.  
Tiempo estimado de montaje por base 3 min.  
El precio de las bases desmontadas se aplicará sólo para pedidos a partir de 10 unidades.

0.13 m3  
15 kg  
x1  
1 box / bulto

Unassembled  
Desmontada  
0.04 m3  
x1

Base Base	Wood column Columna madera	Round wood Redondo madera		Square wood Cuadrado madera		Aluminum column Columna aluminio	Round aluminium Redondo aluminio		Square aluminium Cuadrado aluminio				
		Ref.	€	Ref.	€		Ref.	€	Ref.	€			
Aluminum Aluminio	Beech Haya	BM1060	*	394	BM1063	*	403	BM1066	*	291	BM1071	*	305
			**	374		**	383		**	278		**	289
		BM1062	*	401	BM1065	*	404	BM1068	*	331	BM1073	*	354
			**	381		**	384		**	320		**	338
Beech Haya		BM1116	*	471	BM1117	*	471	BM1118	*	406	BM1120	*	406
			**	461		**	465		**	401		**	404
		BM1119	*	425	BM1121	*	429	BM1119	*	425	BM1121	*	429
			**	422		**	0		**	422		**	0

SERIE  
600

Matte lacquered and premium up charge  
Incremento por lacado mate y premium

| 39 |

\*Assembled \*\*Unassembled  
\*Montada \*\*Desmontada

450x450

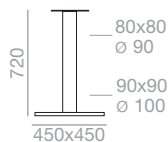

Aluminum  
Wood

Maximum table top 900x900 / ø1000.  
Minimum table top 470x470 / ø550.  
Estimated table base assembly time 3 minutes. The price of the unassembled table bases applies only to orders greater than 10 units.

Medida máxima de sobre 900x900 / ø1000.  
Medida mínima de sobre 470x470 / ø550.  
Tiempo estimado de montaje por base 3 min.  
El precio de las bases desmontadas se aplicará sólo para pedidos a partir de 10 unidades.

0.16 m3  
20 kg  
x1  
1 box / bulto

Unassembled  
Desmontada  
0.04 m3  
x1

Base Base	Wood column Columna madera	Round wood Redondo madera		Square wood Cuadrado madera		Aluminum column Columna aluminio	Round aluminium Redondo aluminio		Square aluminium Cuadrado aluminio						
		Ref.	€	Ref.	€		Ref.	€	Ref.	€					
Aluminum Aluminio	Beech Haya	BM1076	*	421	BM1079	*	425	BM1082	*	309	BM1087	*	324		
			**	401		**	405		**	294		**	312		
		BM1078	*	433	BM1081	*	436	BM1084	*	357	BM1089	*	381		
			**	412		**	415		**	344		**	369		
		Beech Haya	Beech Haya	BM1122	*	501	BM1123	*	504	BM1124	*	438	BM1126	*	429
					**	485		**	485		**	425		**	418
BM1125	*			454	BM1127	*	465	BM1125	**	443	BM1127	**	454		

SERIE  
600

Matte lacquered and premium up charge  
Incremento por lacado mate y premium

\*Assembled \*\*Unassembled  
\*Montada \*\*Desmontada

450x450

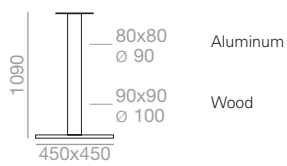

Maximum table top 900x900 / ø1000.  
 Minimum table top 470x470 / ø550.  
 Estimated table base assembly time 3 minutes.  
 The price of the unassembled table bases applies only to orders greater than 10 units.

Medida máxima de sobre 900x900 / ø1000.  
 Medida mínima de sobre 470x470 / ø550.  
 Tiempo estimado de montaje por base 3 min.  
 El precio de las bases desmontadas se aplicará sólo para pedidos a partir de 10 unidades.

0.24 m3  
 20.5 kg  
 x1  
 1 box / bulto

Unassembled  
 Desmontada  
 0.06 m3  
 x1

Base Base	Wood column Columna madera	Round wood Redondo madera		Square wood Cuadrado madera		Aluminum column Columna aluminio	Round aluminium Redondo aluminio		Square aluminium Cuadrado aluminio				
		Ref.	€	Ref.	€		Ref.	€	Ref.	€			
Aluminum Aluminio	Beech Haya	BM1100	*	509	BM1103	*	495	BM1106	*	399	BM1109	*	398
			**	491		**	478		**	389		**	386
		BM1102	*	518	BM1105	*	504	BM1108	*	425	BM1111	*	424
			**	502		**	486		**	415		**	414
		BM1133	*	549	BM1128	*	552	BM1129	*	465	BM1131	*	482
			**	534		**	541		**	454		**	473
BM1130	*	501	BM1132	*	518	BM1130	*	501	BM1132	*	518		
	**	492		**	508		**	492		**	508		

SERIE  
600

Matte lacquered and premium up charge  
 Incremento por lacado mate y premium

\*Assembled \*\*Unassembled  
 \*Montada \*\*Desmontada



**Description**  
**Descripción**

Injected aluminum 4-star base. Available in 2 sizes and 4 heights and offered in polished aluminum, matte white or matte black. Combinable with all Top Collections.

Base de 4 aspas de inyección de aluminio. Disponible en 2 tamaños y 4 alturas diferentes. Se ofrece en acabados aluminio pulido, blanco mate o negro mate. Combinable con cualquier modelo de la colección Top.

**Aluminum finish**  
**Acabado aluminio**



**Certificates**  
**Certificados**

Quality - Resistance  
Calidad - Resistencia

UNE CEN/TR 581-4

Durability of exterior-grade furniture.  
Durabilidad de mobiliario de exterior.

**Intellectual property Propiedad intelectual**

All our collections are protected by international industrial design registries, designs patents, copyrights and intellectual Property laws. Unauthorized use of AW International Property is a criminal offence and can lead to prosecution.

Todas nuestras colecciones están protegidas por registros de diseño industrial, diseño de patente, copyright y derechos de propiedad intelectual en todo el mundo. El uso no autorizado de los diseños y propiedad intelectual de AW supone un delito que puede ser sometido a acción judicial.





Maximum table top 800x800 / ø900. Minimum table top 520x520 / ø600. Estimated table base assembly time 3 minutes. The price of the unassembled table bases applies only to orders greater than 10 units.

Medida máxima de sobre 800x800 / ø900. Medida mínima de sobre 520x520 / ø600. Tiempo estimado de montaje por base 3 min. El precio de las bases desmontadas se aplicará sólo para pedidos a partir de 10 unidades.

**BM4726**

Polished aluminium Aluminio pulido

Assembled	Montada	360
Unassembled	Desmontada	341

0'2 m3  
9 kg  
x1  
1 boxes bultos

Unassembled  
Desmontada

0'06 m3  
x1

**BM4727**

Matte white or black / Blanco o negro mate

Assembled	Montada	282
Unassembled	Desmontada	265



Maximum table top 800x800 / ø900. Minimum table top 520x520 / ø600. Estimated table base assembly time 3 minutes. The price of the unassembled table bases applies only to orders greater than 10 units.

Medida máxima de sobre 800x800 / ø900. Medida mínima de sobre 520x520 / ø600. Tiempo estimado de montaje por base 3 min. El precio de las bases desmontadas se aplicará sólo para pedidos a partir de 10 unidades.

**BM4720**

Polished aluminium Aluminio pulido

Assembled	Montada	329
Unassembled	Desmontada	309

0'11 m3  
7 kg  
x1  
1 boxes bultos

Unassembled  
Desmontada

0'06 m3  
x1

**BM4721**

Matte white or black / Blanco o negro mate

Assembled	Montada	264
Unassembled	Desmontada	240



Maximum table top 800x800 / ø900. Minimum table top 520x520 / ø600. Estimated table base assembly time 3 minutes. The price of the unassembled table bases applies only to orders greater than 10 units.

Medida máxima de sobre 800x800 / ø900. Medida mínima de sobre 520x520 / ø600. Tiempo estimado de montaje por base 3 min. El precio de las bases desmontadas se aplicará sólo para pedidos a partir de 10 unidades.

**BM4723**

Polished aluminium Aluminio pulido

Assembled	Montada	321
Unassembled	Desmontada	316

0'15 m3  
8 kg  
x1  
1 boxes bultos

Unassembled  
Desmontada

0'06 m3  
x1

**BM4724**

Matte white or black / Blanco o negro mate

Assembled	Montada	254
Unassembled	Desmontada	247

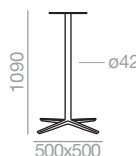

Maximum table top 700x700 / ø800. Minimum table top 520x520 / ø600. Estimated table base assembly time 3 minutes. The price of the unassembled table bases applies only to orders greater than 10 units.

Medida máxima de sobre 700x700 / ø800. Medida mínima de sobre 520x520 / ø600. Tiempo estimado de montaje por base 3 min. El precio de las bases desmontadas se aplicará sólo para pedidos a partir de 10 unidades.

**BM4729**

Polished aluminium Aluminio pulido

Assembled	Montada	392
Unassembled	Desmontada	368

0'3 m3  
12 kg  
x1  
1 boxes bultos

Unassembled  
Desmontada

0'06 m3  
x1

**BM4730**

Matte white or black / Blanco o negro mate

Assembled	Montada	309
Unassembled	Desmontada	297





Maximum table top 1100x1100 /  $\varnothing$ 1200.  
Minimum table top 620x620 /  $\varnothing$ 850.  
Estimated table base assembly time 3 minutes. The price of the unassembled table bases applies only to orders greater than 10 units.

Medida máxima de sobre 1100x1100 /  $\varnothing$ 1200.  
Medida mínima de sobre 620x620 /  $\varnothing$ 850.  
Tiempo estimado de montaje por base 3 min.  
El precio de las bases desmontadas se aplicará sólo para pedidos a partir de 10 unidades.

**BM4738**  
**Polished aluminium Aluminio pulido**

Assembled	Montada	439
Unassembled	Desmontada	399

0'28 m3  
 13 kg  
 x1  
1 boxes bultos

Unassembled  
Desmontada

0'08 m3  
 x1

**BM4739**  
**Matte white or black / Blanco o negro mate**

Assembled	Montada	366
Unassembled	Desmontada	326



Maximum table top 1100x1100 /  $\varnothing$ 1200.  
Minimum table top 620x620 /  $\varnothing$ 850.  
Estimated table base assembly time 3 minutes. The price of the unassembled table bases applies only to orders greater than 10 units.

Medida máxima de sobre 1100x1100 /  $\varnothing$ 1200.  
Medida mínima de sobre 620x620 /  $\varnothing$ 850.  
Tiempo estimado de montaje por base 3 min.  
El precio de las bases desmontadas se aplicará sólo para pedidos a partir de 10 unidades.

**BM4732**  
**Polished aluminium Aluminio pulido**

Assembled	Montada	400
Unassembled	Desmontada	363

0'16 m3  
 9 kg  
 x1  
1 boxes bultos

Unassembled  
Desmontada

0'08 m3  
 x1

**BM4733**  
**Matte white or black / Blanco o negro mate**

Assembled	Montada	337
Unassembled	Desmontada	299



Maximum table top 1100x1100 /  $\varnothing$ 1200.  
Minimum table top 620x620 /  $\varnothing$ 850.  
Estimated table base assembly time 3 minutes. The price of the unassembled table bases applies only to orders greater than 10 units.

Medida máxima de sobre 1100x1100 /  $\varnothing$ 1200.  
Medida mínima de sobre 620x620 /  $\varnothing$ 850.  
Tiempo estimado de montaje por base 3 min.  
El precio de las bases desmontadas se aplicará sólo para pedidos a partir de 10 unidades.

**BM4735**  
**Polished aluminium Aluminio pulido**

Assembled	Montada	414
Unassembled	Desmontada	380

0'22 m3  
 11 kg  
 x1  
1 boxes bultos

Unassembled  
Desmontada

0'08 m3  
 x1

**BM4736**  
**Matte white or black / Blanco o negro mate**

Assembled	Montada	348
Unassembled	Desmontada	311

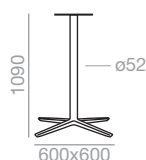

Maximum table top 800x800 /  $\varnothing$ 900.  
Minimum table top 620x620 /  $\varnothing$ 850.  
Estimated table base assembly time 3 minutes. The price of the unassembled table bases applies only to orders greater than 10 units.

Medida máxima de sobre 800x800 /  $\varnothing$ 900.  
Medida mínima de sobre 620x620 /  $\varnothing$ 850.  
Tiempo estimado de montaje por base 3 min.  
El precio de las bases desmontadas se aplicará sólo para pedidos a partir de 10 unidades.

**BM4741**  
**Polished aluminium Aluminio pulido**

Assembled	Montada	496
Unassembled	Desmontada	450

0'43 m3  
 17 kg  
 x1  
1 boxes bultos

Unassembled  
Desmontada

0'08 m3  
 x1

**BM4742**  
**Matte white or black / Blanco o negro mate**

Assembled	Montada	403
Unassembled	Desmontada	359



Maximum table top 800x800 / ø900. Minimum table top 620x620 / ø850.

Medida máxima de sobre 800x800 / ø900. Medida mínima de sobre 620x620 / ø850.

**BM4758**

Thermo-polymer ECO Termopolímero ECO

Assembled

Montada

209

0'2 m3

9 kg

x1

1 boxes bultos



Incremento por sistema abatible  
Folding system upcharge

30



**Description**  
**Descripción**

Central Pure Eco thermo-polymer (100% recycled) available in several colors and gloss lacquer option. It is offered in different colors and base diameters. Combinable with any model from the Top collection.

Base central de mesa de termopolímero Pure Eco (100% reciclado) disponible en diferentes colores y opción de laca brillo. Se ofrece en diferentes colores y diámetros de base. Combinable con cualquier modelo de la colección Top.

**Pure Eco Thermo-polymer finish**  
**Acabado de Termo-polímero Pure Eco**

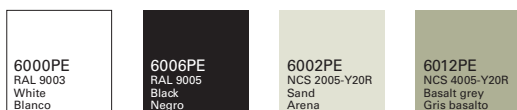

**Certificates**  
**Certificados**

Quality - Resistance  
Calidad - Resistencia

UNE EN 15372

**Intellectual property Propiedad intelectual**

All our collections are protected by international industrial design registries, designs patents, copyrights and intellectual Property laws. Unauthorized use of AW International Property is a criminal offence and can lead to prosecution.  
Todas nuestras colecciones están protegidas por registros de diseño industrial, diseño de patente, copyright y derechos de propiedad intelectual en todo el mundo. El uso no autorizado de los diseños y propiedad intelectual de AW supone un delito que puede ser sometido a acción judicial.



## Reverse 38



Maximum table top 900x900 / ø1000.  
Minimum table top 600x600 / ø750.  
This base is provided with a sand filled counterweight. Amount of sand: 25 kg. The price of the Promo table bases applies only to orders greater than 12 units per color. Counterweight is supplied separately in promotional offers. Suitable for matte finish

Medida máxima de sobre 900x900 / ø1000.  
Medida mínima de sobre 600x600 / ø750.  
Esta base se sirve rellena de arena. Cantidad de arena 25 kg. El precio de las bases en Promoción se aplicará solo para pedidos de más de 12 unidades del mismo color. El contrapeso es opcional. Válido para acabados mate.

### BM4520

Standard Promo	Estandar Promoción	244 211
-------------------	-----------------------	------------

0'12 m3  
 29'9 kg  
 x1  
1 boxes bultos



Incremento por base  
laca brillo  
Bright lacquered base  
up charge

272



Height adjustable  
glides up charge  
Incremento por tacos  
reguladores

42



Cement base up  
charge  
Incremento por base  
de cemento

186

## Reverse 38 High



Maximum table top 1100x1100 / ø1200.  
Minimum table top 600x600 / ø750.  
This base is provided with a sand filled counterweight. Amount of sand: 45 kg. The price of the Promo table bases applies only to orders greater than 6 units per color. Counterweight is supplied separately in promotional offers. Suitable for matte finish

Medida máxima de sobre 1100x1100 / ø1200.  
Medida mínima de sobre 600x600 / ø750.  
Esta base se sirve rellena de arena. Cantidad de arena 45 kg. El precio de las bases en Promoción se aplicará solo para pedidos de más de 6 unidades del mismo color. El contrapeso es opcional. Válido para acabados mate.

### BM4562

Standard Promo	Estandar Promoción	343 273
-------------------	-----------------------	------------

0'21 m3  
 52'1 kg  
 x1  
1 boxes bultos



Incremento por base  
laca brillo  
Bright lacquered base  
up charge

358



Height adjustable  
glides up charge  
Incremento por tacos  
reguladores

42



Cement base up  
charge  
Incremento por base  
de cemento

291

## Reverse 50



Maximum table top 1400x1400 / ø1500. Minimum table top 700x700 / ø950.

Medida máxima de sobre 1400x1400 / ø1500.  
Medida mínima de sobre 700x700 / ø950.

### BM4521

349

0'2 m3  
 51'9 kg  
 x1  
1 boxes bultos



Incremento por base  
laca brillo  
Bright lacquered base  
up charge

323



Height adjustable  
glides up charge  
Incremento por tacos  
reguladores

57



Cement base up  
charge  
Incremento por base  
de cemento

228

## Reverse 50 Counter



Maximum table top 1300x1300 / ø1400. Minimum table top 700x700 / ø950.

Medida máxima de sobre 1300x1300 / ø1400.  
Medida mínima de sobre 700x700 / ø950.

### BM4519

290

0'7 m3  
 60 kg  
 x1  
1 boxes bultos



Incremento por base  
laca brillo  
Bright lacquered base  
up charge

272



Height adjustable  
glides up charge  
Incremento por tacos  
reguladores

42



Cement base up  
charge  
Incremento por base  
de cemento

270

## Reverse 50 High



Maximum table top 1300x1300 / ø1400. Minimum table top 700x700 / ø950.

Medida máxima de sobre 1300x1300 / ø1400. Medida mínima de sobre 700x700 / ø950.

**BM4569**

338

0'3 m3  
52'2 kg  
x1  
1 boxes bultos



Incremento por base  
laca brillo  
Bright lacquered base  
up charge

| 387



Height adjustable  
glides up charge  
Incremento por tacos  
reguladores

| 57



Cement base up  
charge  
Incremento por base  
de cemento

| 317

## Reverse 60

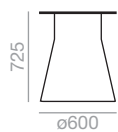

Maximum table top 1600x1600 / ø1800. Minimum table top 800x800 / ø1050.

Medida máxima de sobre 1600x1600 / ø1800. Medida mínima de sobre 800x800 / ø1050.

**BM4564**

564

0'28 m3  
77 kg  
x1  
1 boxes bultos



Incremento por base  
laca brillo  
Bright lacquered base  
up charge

| 401



Height adjustable  
glides up charge  
Incremento por tacos  
reguladores

| 57



Cement base up  
charge  
Incremento por base  
de cemento

| 308

## Reverse 80

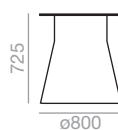

Maximum table top 1900x1900 / ø2100. Minimum table top 800x800 / ø1050.

Medida máxima de sobre 1900x1900 / ø2100. Medida mínima de sobre 800x800 / ø1050.

**BM4568**

705

0'68 m3  
94'9 kg  
x1  
1 boxes bultos



Incremento por base  
laca brillo  
Bright lacquered base  
up charge

| 571



Height adjustable  
glides up charge  
Incremento por tacos  
reguladores

| 57



Cement base up  
charge  
Incremento por base  
de cemento

| 411

## Counterweight / Contrapeso



25 kg counterweight for Reverse 38 table bases.

Contrapeso de 25 kg para bases Reverse 38.

**CW4524**

15

0'07 m3  
25 kg  
x1  
boxes bultos

## Counterweight / Contrapeso



50 kg counterweight for Reverse 42 table bases.

Contrapeso de 50 kg para bases Reverse 42.

**CW4566**

15

 0'07 m3

 25 kg

 x1  
boxes bultos

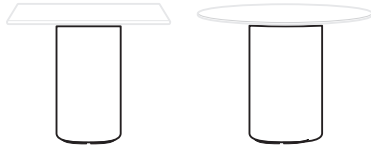

**Description**  
**Descripción**

Bases in Pure Eco thermo-polymer (100% recycled) available in several colors.  
Bases de termopolimero Pure Eco (100% reciclado) disponible en diferentes colores.

**Pure Eco Thermo-polymer finish**  
**Acabado de Termopolimero Pure Eco**



**Intellectual property Propiedad intelectual**

All our collections are protected by international industrial design registries, designs patents, copyrights and intellectual Property laws. Unauthorized use of AW International Property is a criminal offence and can lead to prosecution.  
Todas nuestras colecciones están protegidas por registros de diseño industrial, diseño de patente, copyright y derechos de propiedad intelectual en todo el mundo. El uso no autorizado de los diseños y propiedad intelectual de AW supone un delito que puede ser sometido a acción judicial.



## Solid 38



Maximum table top 1000x1000 /  $\phi$ 1100. Minimum table top 600x600 /  $\phi$ 750.

Medida máxima de sobre 1000x1000 /  $\phi$ 1100. Medida mínima de sobre 600x600 /  $\phi$ 750.

**BM03651**

186

0'14 m<sup>3</sup>

28 kg

x1

1 boxes bultos



Incremento por base  
laca brillo  
Bright lacquered base  
up charge

| 279 |

## Solid 50

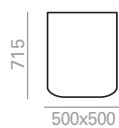

Maximum table top 1400x1400 /  $\phi$ 1500. Minimum table top 700x700 /  $\phi$ 950.

Medida máxima de sobre 1400x1400 /  $\phi$ 1500. Medida mínima de sobre 700x700 /  $\phi$ 950.

**BM03652**

227

0'2 m<sup>3</sup>

50 kg

x1

1 boxes bultos



Incremento por base  
laca brillo  
Bright lacquered base  
up charge

| 297 |

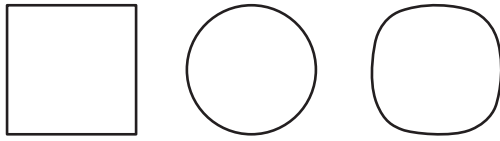



Table tops

Sobres de mesa





**Description**  
**Descripción**

12 mm thick solid core high pressure laminate top (HPL). Suitable for outdoor and high traffic areas. Able to be combined with all central column base collections.

Tablero Compacto laminado de alta presión (HPL) de 12mm. Valido para exterior y áreas de uso intenso. Valido para cualquier base de columna central.

**Compacto HPL finish**  
**Acabado Compacto HPL**



**Compacto HPL finish decorative**  
**Acabado Compacto HPL decorativo**

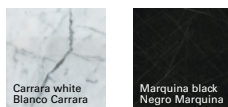

**Edge**  
**Perfil**

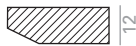

**Certificates**  
**Certificados**

EN 438-2-4, EN 438-2-5, EN 438-2-6, EN 438-2-7, EN 438-2-8, EN 438-2-9, EN 438-2-10, EN 438-2-12, EN 438-2-14, EN 438-2-16, EN 12721, EN 438-2-17, EN 438-2-21, EN 438-2-24, EN 438-2-25, EN 438-2-26, EN 438-2-27, EN 438-2-30, EN ISO 1183-1, ISO 178: 2003, ISO R527: 1996.

**Intellectual property Propiedad intelectual**

All our collections are protected by international industrial design registries, designs patents, copyrights and intellectual Property laws. Unauthorized use of AW International Property is a criminal offence and can lead to prosecution.

Todas nuestras colecciones están protegidas por registros de diseño industrial, diseño de patente, copyright y derechos de propiedad intelectual en todo el mundo. El uso no autorizado de los diseños y propiedad intelectual de AW supone un delito que puede ser sometido a acción judicial.











12 mm thick Compacto high pressure laminate top (HPL)





Tablero Compacto laminado de alta presión (HPL) de 12mm.

Edge / Perfil



	 1		Compacto HPL		Marquina/Carrara	
	 m3	 kg				
600x600	0,05	7	<b>SB4591</b>	165	<b>SB4668</b>	172
700x700	0,06	9	<b>SB4592</b>	201	<b>SB4669</b>	211
800x800	0,08	11	<b>SB4593</b>	227	<b>SB4670</b>	244
900x900	0,1	13	<b>SB4594</b>	266	<b>SB4671</b>	310
1000x1000	0,12	16	<b>SB4595</b>	322	<b>SB4672</b>	376
1100x1100	0,14	19	<b>SB4596</b>	425	<b>SB4673</b>	447
1200x1200	0,17	22	<b>SB4597</b>	427	<b>SB4674</b>	448
1300x1300	0,2	26	<b>SB4598</b>	432	<b>SB4675</b>	453
1400x1400	0,23	30	<b>SB4599</b>	574	<b>SB4676</b>	601

	 1		Compacto HPL		Marquina/Carrara	
	 m3	 kg				
ø600	0,05	7	<b>SB4580</b>	167	<b>SB4659</b>	174
ø700	0,06	8	<b>SB4581</b>	201	<b>SB4660</b>	211
ø800	0,08	10	<b>SB4582</b>	227	<b>SB4661</b>	244
ø900	0,1	12	<b>SB4583</b>	266	<b>SB4662</b>	310
ø1000	0,12	14	<b>SB4584</b>	322	<b>SB4663</b>	376
ø1100	0,14	16	<b>SB4585</b>	425	<b>SB4664</b>	447
ø1200	0,17	18	<b>SB4586</b>	427	<b>SB4665</b>	448
ø1300	0,2	21	<b>SB4587</b>	432	<b>SB4666</b>	453
ø1400	0,23	24	<b>SB4588</b>	574	<b>SB4667</b>	601

	 1		Compacto HPL		Marquina/Carrara	
	 m3	 kg				
600x600	0,05	8	<b>SB4570</b>	171	<b>SB4650</b>	180
700x700	0,06	10	<b>SB4571</b>	207	<b>SB4651</b>	217
800x800	0,08	12	<b>SB4572</b>	235	<b>SB4652</b>	248
900x900	0,1	14	<b>SB4573</b>	274	<b>SB4653</b>	311
1000x1000	0,12	17	<b>SB4574</b>	324	<b>SB4654</b>	379
1100x1100	0,14	19	<b>SB4575</b>	428	<b>SB4655</b>	449
1200x1200	0,17	22	<b>SB4576</b>	428	<b>SB4656</b>	449
1300x1300	0,2	26	<b>SB4577</b>	433	<b>SB4657</b>	455
1400x1400	0,23	29	<b>SB4578</b>	579	<b>SB4658</b>	609

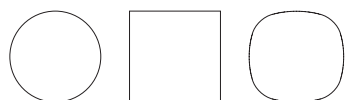

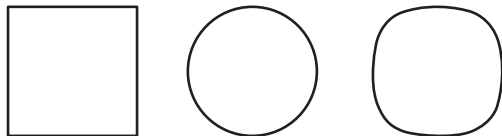

**Description**  
**Descripción**

10mm thick Low Iron Glass available in various colors. Able to be combined with all the central column table Descripción base collections. Suitable for outdoor use. The total thickness of table top is 10 mm. glass + 12 mm. Compacto HPL table top.  
Cristal óptico de 10 mm. de espesor, disponible en varios colores. Válido para cualquier colección de columna central y su uso en exterior. El espesor total del sobre es de 22 mm. (10 mm. de cristal + 12 mm. de soporte de tablero Compacto.)

**Glass finish**  
**Acabado de cristal**

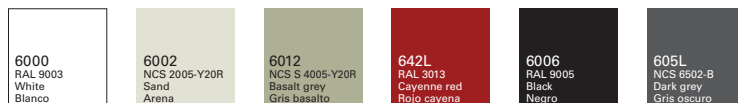

**Edge**  
**Perfil**



**Intellectual property Propiedad intelectual**

All our collections are protected by international industrial design registries, designs patents, copyrights and intellectual Property laws. Unauthorized use of AW International Property is a criminal offence and can lead to prosecution.  
Todas nuestras colecciones están protegidas por registros de diseño industrial, diseño de patente, copyright y derechos de propiedad intelectual en todo el mundo. El uso no autorizado de los diseños y propiedad intelectual de AW supone un delito que puede ser sometido a acción judicial.









10 mm thick glass table top.



Sobre de mesa cristal de 10 mm de espesor.

Edge / Perfil



	 1	 kg	Low Iron Glass Cristal Óptico	
600x600	0,07	13	<b>SB4766</b>	416
700x700	0,09	17	<b>SB4767</b>	450
800x800	0,11	20	<b>SB4768</b>	520
900x900	0,14	24	<b>SB4769</b>	552
1000x1000	0,17	29	<b>SB4770</b>	647
1100x1100	0,2	34	<b>SB4771</b>	736
1200x1200	0,24	40	<b>SB4772</b>	816
1300x1300	0,27	46	<b>SB4773</b>	917
1400x1400	4,91	52	<b>SB4774</b>	1.028
1500x1500	5,83	59	<b>SB4775</b>	1.072

	 1	 kg	Low Iron Glass Cristal Óptico	
ø600	0,07	12	<b>SB4776</b>	432
ø700	0,09	14	<b>SB4777</b>	475
ø800	0,11	17	<b>SB4778</b>	550
ø900	0,14	20	<b>SB4779</b>	593
ø1000	0,17	24	<b>SB4780</b>	704
ø1100	0,2	28	<b>SB4781</b>	839
ø1200	0,24	32	<b>SB4782</b>	868
ø1300	0,27	37	<b>SB4783</b>	992
ø1400	4,91	42	<b>SB4784</b>	1.089
ø1500	5,83	48	<b>SB4785</b>	1.332

	 1	 kg	Low Iron Glass Cristal Óptico	
600x600	0,07	12	<b>SB4786</b>	529
700x700	0,09	15	<b>SB4787</b>	564
800x800	0,11	18	<b>SB4788</b>	629
900x900	0,14	22	<b>SB4789</b>	656
1000x1000	0,17	26	<b>SB4790</b>	736
1100x1100	0,2	30	<b>SB4791</b>	779
1200x1200	0,24	35	<b>SB4792</b>	876
1300x1300	0,27	40	<b>SB4793</b>	1.044
1400x1400	4,91	46	<b>SB4794</b>	1.131
1500x1500	5,83	52	<b>SB4795</b>	1.235

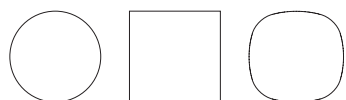

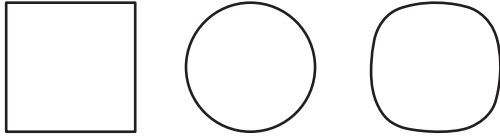

**Description**  
**Descripción**

12mm thick Solid Surface table top. Available in Glacier White color. Able to be combined with all column base collections. Suitable for outdoor use.  
Sobre de Solid Surface de 12 mm. de espesor. Disponible en color Glacier White. Válido para cualquier colección de columnas. Válido para uso en exterior.

**Solid Surface finish**  
**Acabado Solid Surface**



**Certificates**  
**Certificados**

DIN ISO 1183, DIN EN ISO 178, EN ISO 604, DIN ISO 4586 T11,  
DIN ISO 4586 T12, DIN EN 101, DIN ISO 4586 T6, DIN ISO 4586 T7,  
DIN EN ISO 846, DIN 51130:1992-11, DIN ISO 4586 T10,  
DIN ISO 4586 T8, DIN ISO 4586 T16, DIN IEC 61 340-4-1.

**Edge**  
**Perfil**

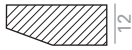

**Intellectual property Propiedad intelectual**

All our collections are protected by international industrial design registries, designs patents, copyrights and intellectual Property laws. Unauthorized use of AW International Property is a criminal offence and can lead to prosecution.  
Todas nuestras colecciones están protegidas por registros de diseño industrial, diseño de patente, copyright y derechos de propiedad intelectual en todo el mundo. El uso no autorizado de los diseños y propiedad intelectual de AW supone un delito que puede ser sometido a acción judicial.











12 mm thick Solid Surface table top.





Sobre de Solid Surface de 12 mm. de espesor.

Edge / Perfil



	 1	 m3	 kg		
600x600	0,05	9	<b>SB3592</b>	394	
700x700	0,06	12	<b>SB3593</b>	452	
800x800	0,08	15	<b>SB3594</b>	576	
900x900	0,1	19	<b>SB3595</b>	581	

	 1	 m3	 kg		
ø600	0,05	8	<b>SB3596</b>	394	
ø700	0,06	10	<b>SB3597</b>	452	
ø800	0,08	12	<b>SB3598</b>	570	
ø900	0,1	15	<b>SB3599</b>	574	

	 1	 m3	 kg		
600x600	0,05	8	<b>SB3614</b>	394	
700x700	0,06	11	<b>SB3615</b>	452	
800x800	0,08	13	<b>SB3616</b>	570	
900x900	0,1	16	<b>SB3617</b>	574	

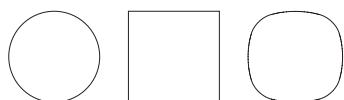



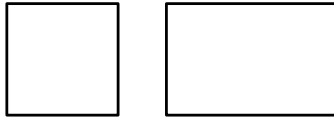

**Description**

Table top made with fiber core and melamine finish available in oak, white or black. Rounded edge to increase its resistance. Available in square and rectangular shape and different sizes.

**Descripción**

Sobre de mesa realizado con nucleo de fibras y acabado melamina disponible en roble, blanco o negro. Canto redondeado para aumentar su resistencia. Disponible en forma cuadrada y rectangular y diferentes medidas.

**Melamine finish**

**Acabado melamina**

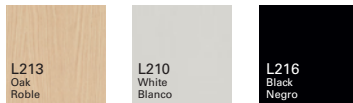

L213  
Oak  
Roble

L210  
White  
Blanco

L216  
Black  
Negro

**Intellectual property Propiedad intelectual**

All our collections are protected by international industrial design registries, designs patents, copyrights and intellectual Property laws. Unauthorized use of AW International Property is a criminal offence and can lead to prosecution.  
Todas nuestras colecciones están protegidas por registros de diseño industrial, diseño de patente, copyright y derechos de propiedad intelectual en todo el mundo. El uso no autorizado de los diseños y propiedad intelectual de AW supone un delito que puede ser sometido a acción judicial.











18 mm thick table top.

Sobre de mesa de 18 mm de espesor.

Edge / Perfil



	 1	 m3	 kg		
600x600	0,05	7,5	<b>SB7630</b>	155	
700x700	0,06	8,5	<b>SB7631</b>	214	
800x800	0,08	10,5	<b>SB7632</b>	221	
900x900	0,1	12,5	<b>SB7633</b>	232	
1000x1000	0,12	15,5	<b>SB7634</b>	294	
1100x1100	0,14	17,6	<b>SB7635</b>	326	
1200x1200	0,17	20,6	<b>SB7636</b>	356	
1300x1300	0,2	23,9	<b>SB7637</b>	391	
1400x1400	0,22	27,9	<b>SB7638</b>	426	

	 1	 m3	 kg		
900x700	0,09	14,5	<b>SB7639</b>	250	
1200x700	0,1	16,5	<b>SB7640</b>	329	





**Description**  
**Descripción**

8 mm. layer Technical Stone square and round table tops. Square top has protective black edge cover. Also available for outdoor use. The total thickness of table top is 8 mm. (3 mm. Technical Stone table top + 5 mm. glass table top).

Tablero de mesa Technical Stone de 8 mm. en sobres redondos, con canto protector de color negro en sobres cuadrados. Válido para su uso en exterior. El espesor total del sobre es de 8 mm. (3 mm. de tablero Technical Stone + 5 mm. de sobre de cristal).

**Technical Stone decorative finish**  
**Acabado Technical Stone**



**Certificates**  
**Certificados**

European Standard:  
UNE EN 13501-1:2

International Standards  
UNE EN ISO 10545-3, UNE EN ISO 10545-4, UNE EN ISO 10545-6,  
UNE ENV 12633, UNE EN ISO 10545-12, UNE EN ISO 10545-9.

**Edge**  
**Perfil**



**Intellectual property Propiedad intelectual**

All our collections are protected by international industrial design registries, designs patents, copyrights and intellectual Property laws. Unauthorized use of AW International Property is a criminal offence and can lead to prosecution.

Todas nuestras colecciones están protegidas por registros de diseño industrial, diseño de patente, copyright y derechos de propiedad intelectual en todo el mundo. El uso no autorizado de los diseños y propiedad intelectual de AW supone un delito que puede ser sometido a acción judicial.











8mm layer Technical Stone table top.

Tablero de mesa Technical Stone de 8mm.

Edge / Perfil



	 1	 m3	 kg		
600x600	0,06	8	<b>SB4535</b>	522	
700x700	0,08	11	<b>SB4536</b>	602	
800x800	0,1	13	<b>SB4537</b>	702	
900x900	0,12	15	<b>SB4538</b>	763	
1000x1000	0,14	17	<b>SB4539</b>	829	

	 1	 m3	 kg		
ø600	0,06	8	<b>SB4540</b>	581	
ø700	0,08	9	<b>SB4541</b>	668	
ø800	0,1	10	<b>SB4542</b>	758	
ø900	0,12	11	<b>SB4543</b>	836	
ø1000	0,14	13	<b>SB4544</b>	912	





**Description**  
**Descripción**

Top 18 Oak 18mm oak top. Suitable for all table base collections. Top 18 Laminate 18mm laminate top that is suitable for high traffic areas. Able to be combined with all central column base collections. Top 18 Lacquered 18mm lacquer top. Suitable for all  
 Top 18 Roble Tablero de roble de 18 mm. Válido para cualquier base de columna central. Top 18 Laminado Tablero laminado de 18 mm preparado para áreas de uso intenso. Válido para cualquier base de columna central. Top 18 Lacado Tablero lacado de 18 mm. Vál

**Wood finish Oak**  
**Acabado madera Roble**



**Wood lacquer finish**  
**Acabado lacas madera**



**Laminated**  
**Laminado**

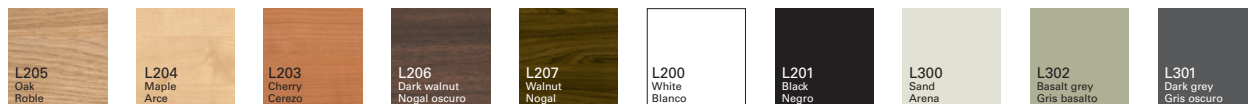

**Ultra-matte finish**  
**Acabado ultramate**



**Edge**  
**Perfil**



**Intellectual property Propiedad intelectual**

All our collections are protected by international industrial design registries, designs patents, copyrights and intellectual Property laws. Unauthorized use of AW International Property is a criminal offence and can lead to prosecution.  
 Todas nuestras colecciones están protegidas por registros de diseño industrial, diseño de patente, copyright y derechos de propiedad intelectual en todo el mundo. El uso no autorizado de los diseños y propiedad intelectual de AW supone un delito que puede ser sometido a acción judicial.







18 mm thick table top available in oak, laminate or lacquered.



Sobre de mesa de 18 mm de espesor disponible en roble, laminado o lacado.



Edge / Perfil



			Ultra-matte Ultramate		Laminate Laminado		Lacquered Lacado		Oak Roble		S600
	1	kg									
600x600	0,05	7	<b>SB3989</b>	211	<b>SB3940</b>	162	<b>SB3950</b>	195	<b>SB3960</b>	200	90
700x700	0,06	8	<b>SB3990</b>	280	<b>SB3941</b>	198	<b>SB3951</b>	237	<b>SB3961</b>	260	96
800x800	0,08	10	<b>SB3991</b>	457	<b>SB3942</b>	296	<b>SB3952</b>	269	<b>SB3962</b>	338	102
900x900	0,1	12	<b>SB3992</b>	475	<b>SB3943</b>	360	<b>SB3953</b>	320	<b>SB3963</b>	441	110
1000x1000	0,12	15	<b>SB3993</b>	481	<b>SB3944</b>	366	<b>SB3954</b>	340	<b>SB3964</b>	484	116
1100x1100	0,14	17	<b>SB3994</b>	589	<b>SB3945</b>	387	<b>SB3955</b>	386	<b>SB3965</b>	510	128
1200x1200	0,17	20	<b>SB3995</b>	594	<b>SB3946</b>	392	<b>SB3956</b>	425	<b>SB3966</b>	529	138
1300x1300	0,2	23	<b>SB3996</b>	684	<b>SB3947</b>	475	<b>SB3957</b>	503	<b>SB3967</b>	686	144
1400x1400	0,22	27	<b>SB3997</b>	862	<b>SB3948</b>	536	<b>SB3958</b>	524	<b>SB3968</b>	713	147

			Ultra-matte Ultramate		Laminate Laminado		Lacquered Lacado		Oak Roble		S600
	1	kg									
1200x700	0,1	16	<b>SB3979</b>	466	<b>SB3475</b>	308	<b>SB4467</b>	329	<b>SB3464</b>	448	122

			Ultra-matte Ultramate		Laminate Laminado		Lacquered Lacado		Oak Roble		S600
	1	kg									
ø600	0,05	8	<b>SB3980</b>	211	<b>SB3477</b>	163	<b>SB4469</b>	195	<b>SB3466</b>	200	90
ø700	0,06	9	<b>SB3981</b>	276	<b>SB3478</b>	197	<b>SB4470</b>	237	<b>SB3467</b>	260	96
ø800	0,08	12	<b>SB3982</b>	457	<b>SB3479</b>	286	<b>SB4471</b>	269	<b>SB3468</b>	338	102
ø900	0,1	14	<b>SB3983</b>	475	<b>SB3480</b>	347	<b>SB4472</b>	320	<b>SB3469</b>	441	110
ø1000	0,12	16	<b>SB3984</b>	481	<b>SB3481</b>	344	<b>SB4473</b>	334	<b>SB3492</b>	484	116
ø1100	0,14	17	<b>SB3985</b>	589	<b>SB3482</b>	387	<b>SB4474</b>	386	<b>SB3493</b>	510	128
ø1200	0,17	19	<b>SB3986</b>	594	<b>SB3483</b>	392	<b>SB4475</b>	425	<b>SB3494</b>	529	138
ø1300	0,2	20	<b>SB3987</b>	676	<b>SB3484</b>	479	<b>SB4476</b>	503	<b>SB3495</b>	685	144
ø1400	0,22	23	<b>SB3988</b>	862	<b>SB3542</b>	541	<b>SB3547</b>	527	<b>SB3515</b>	713	147

			Ultra-matte Ultramate		Laminate Laminado		Lacquered Lacado		Oak Roble		S600
	1	kg									
600x600	0,05	8	<b>SB3970</b>	207	<b>SB3471</b>	164	<b>SB4460</b>	202	<b>SB3460</b>	198	90
700x700	0,06	9	<b>SB3971</b>	284	<b>SB3472</b>	200	<b>SB4461</b>	237	<b>SB3461</b>	260	96
800x800	0,08	10	<b>SB3972</b>	454	<b>SB3473</b>	282	<b>SB4462</b>	276	<b>SB3462</b>	338	102
900x900	0,1	14	<b>SB3973</b>	461	<b>SB3474</b>	342	<b>SB4463</b>	326	<b>SB3463</b>	441	110
1000x1000	0,12	16	<b>SB3974</b>	467	<b>SB3486</b>	343	<b>SB4464</b>	351	<b>SB3489</b>	484	116
1100x1100	0,14	17	<b>SB3975</b>	591	<b>SB3487</b>	390	<b>SB4465</b>	394	<b>SB3490</b>	510	128
1200x1200	0,17	19	<b>SB3976</b>	594	<b>SB3488</b>	394	<b>SB4466</b>	426	<b>SB3491</b>	531	138
1300x1300	0,2	21	<b>SB3977</b>	684	<b>SB3456</b>	476	<b>SB4478</b>	515	<b>SB3497</b>	687	144
1400x1400	0,22	25	<b>SB3978</b>	862	<b>SB3540</b>	542	<b>SB3544</b>	528	<b>SB3512</b>	720	147

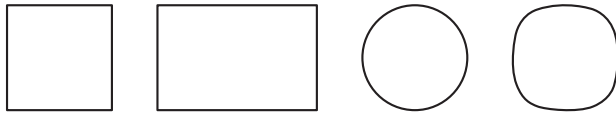

**Description** 23mm. thick two face table top available in a maple veneer. Can be combined with all table base collections.  
**Descripción** Sobres de mesa 23mm. chapados en arce a dos caras. Válidos para cualquier colección de columna central.

**Wood finish Maple**  
**Acabado madera Arce**

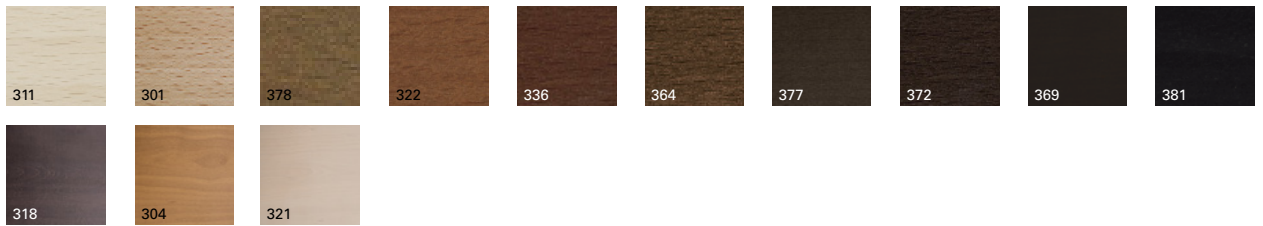

**Wood lacquer finish**  
**Acabado lacas madera**

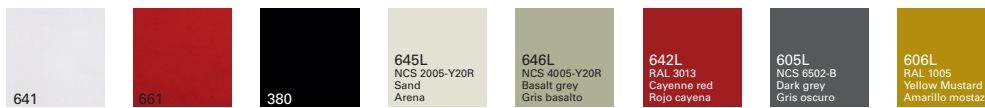

**Ultra-matte finish**  
**Acabado ultramate**



**Linoleum finish**  
**Acabado linóleo**

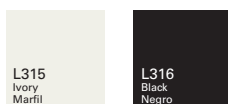

**Edge**  
**Perfil**

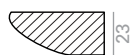

**Intellectual property Propiedad intelectual**

All our collections are protected by international industrial design registries, designs patents, copyrights and intellectual Property laws. Unauthorized use of AW International Property is a criminal offence and can lead to prosecution.  
 Todas nuestras colecciones están protegidas por registros de diseño industrial, diseño de patente, copyright y derechos de propiedad intelectual en todo el mundo. El uso no autorizado de los diseños y propiedad intelectual de AW supone un delito que puede ser sometido a acción judicial.



23 mm thick maple table top.

Sobre de mesa de arce de 23 mm de espesor.

Edge / Perfil



Size	1 m <sup>3</sup>	kg	Ultra-matte Ultramate		Linoleum Linóleo		Lacquered Lacado		Maple Arce		S600
			SB	Value	SB	Value	SB	Value	SB	Value	
500x500	0,04	7	SB1790	226	SB1827	332	SB0990	164	SB0979	154	84
600x600	0,06	8	SB1791	280	SB1828	338	SB0995	173	SB0980	174	92
700x700	0,08	10	SB1792	330	SB1829	397	SB0996	229	SB0981	218	99
800x800	0,1	13	SB1793	373	SB1830	457	SB0997	274	SB0982	267	105
900x900	0,12	16	SB1794	496	SB1831	517	SB0998	327	SB0983	326	113
1000x1000	0,14	19	SB1795	612	SB1832	608	SB0999	324	SB0984	380	119
1100x1100	0,17	23	SB1796	758	SB1833	758	SB1022	399	SB0985	431	126
1200x1200	0,2	27	SB1797	813	SB1834	813	SB1023	433	SB0986	484	134
1300x1300	0,24	31	SB1798	906	SB1835	903	SB1024	474	SB0987	540	141
1400x1400	0,27	36	SB1799	975	SB1836	971	SB1025	489	SB0988	627	150
1500x1500	0,31	41	SB1800	1.055	SB1837	1.055	SB1026	528	SB0989	673	156

Size	1 m <sup>3</sup>	kg	Ultra-matte Ultramate		Linoleum Linóleo		Lacquered Lacado		Maple Arce		S600
			SB	Value	SB	Value	SB	Value	SB	Value	
700x600	0,07	11	SB1775	316	SB1812	387	SB0975	223	SB0970	205	96
800x600	0,08	12	SB1776	344	SB1813	416	SB0976	234	SB0971	239	102
800x700	0,09	14	SB1777	362	SB1814	446	SB0977	255	SB0972	255	110
1200x700	0,12	18	SB1778	475	SB1815	704	SB0978	332	SB0973	343	122

Size	1 m <sup>3</sup>	kg	Ultra-matte Ultramate		Linoleum Linóleo		Lacquered Lacado		Maple Arce		S600
			SB	Value	SB	Value	SB	Value	SB	Value	
ø500	0,04	7	SB1779	223	SB1816	306	SB0914	164	SB0900	154	84
ø600	0,06	8	SB1780	280	SB1817	338	SB0947	194	SB0831	174	92
ø700	0,08	9	SB1781	330	SB1818	399	SB0948	221	SB0832	218	99
ø800	0,1	12	SB1782	373	SB1819	457	SB0949	256	SB0833	267	105
ø900	0,12	15	SB1783	496	SB1820	518	SB0950	295	SB0834	322	113
ø1000	0,14	17	SB1784	612	SB1821	608	SB0951	320	SB0835	381	119
ø1100	0,17	18	SB1785	716	SB1822	713	SB0952	365	SB0909	431	126
ø1200	0,2	21	SB1786	813	SB1823	813	SB0953	407	SB0910	492	134
ø1300	0,24	25	SB1787	906	SB1824	903	SB0954	455	SB0911	539	141
ø1400	0,27	29	SB1788	975	SB1825	971	SB0955	492	SB0912	608	150
ø1500	0,31	32	SB1789	1.055	SB1826	1.055	SB0956	528	SB0913	673	156

Size	1 m <sup>3</sup>	kg	Ultra-matte Ultramate		Linoleum Linóleo		Lacquered Lacado		Maple Arce		S600
			SB	Value	SB	Value	SB	Value	SB	Value	
500x500	0,04	7	SB1764	226	SB1801	275	SB0869	169	SB0901	157	84
600x600	0,06	8	SB1765	280	SB1802	345	SB0870	202	SB0826	179	92
700x700	0,08	11	SB1766	330	SB1803	399	SB0871	234	SB0827	223	99
800x800	0,1	11	SB1767	373	SB1804	457	SB0882	272	SB0828	272	105
900x900	0,12	14	SB1768	496	SB1805	496	SB0883	307	SB0829	330	113
1000x1000	0,14	19	SB1769	621	SB1806	621	SB0884	330	SB0863	384	119
1100x1100	0,17	23	SB1770	721	SB1807	716	SB0885	370	SB0864	443	126
1200x1200	0,2	27	SB1771	816	SB1808	816	SB0886	404	SB0865	483	134
1300x1300	0,24	31	SB1772	909	SB1809	906	SB0887	466	SB0866	538	141
1400x1400	0,27	36	SB1773	980	SB1810	975	SB0888	486	SB0867	625	150
1500x1500	0,31	41	SB1774	1.059	SB1811	1.055	SB0889	526	SB0868	672	156





**Description**  
**Descripción**

Laminate table top, 30 mm in thickness, available in various finishes and matching thermopolymer edge. Suitable for any central column base.  
Sobre de mesa laminado de 30mm de espesor disponible en diferentes acabados y con canto de termopolímero a juego. Valido para cualquier base de columna central.

**Laminated**  
**Laminado**

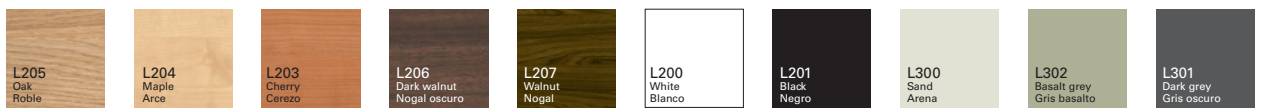

**Ultra-matte finish**  
**Acabado ultramate**

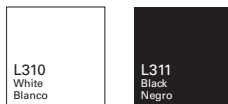

**Edge**  
**Perfil**



**Intellectual property Propiedad intelectual**

All our collections are protected by international industrial design registries, designs patents, copyrights and intellectual Property laws. Unauthorized use of AW International Property is a criminal offence and can lead to prosecution.  
Todas nuestras colecciones están protegidas por registros de diseño industrial, diseño de patente, copyright y derechos de propiedad intelectual en todo el mundo. El uso no autorizado de los diseños y propiedad intelectual de AW supone un delito que puede ser sometido a acción judicial.









30 mm thick laminate table top.



Sobre de mesa laminado de 30 mm de espesor.

Edge / Perfil



	 1 m3 		Ultra-matte Ultramate		Laminate Laminado	
700x600	0,07	9	<b>SB7431</b>	253	<b>SB7355</b>	198
800x600	0,08	10	<b>SB7432</b>	267	<b>SB7356</b>	235
800x700	0,09	11	<b>SB7433</b>	301	<b>SB7357</b>	240
1200x700	0,12	16	<b>SB7434</b>	370	<b>SB7351</b>	293
1500x900	0,19	24	<b>SB7435</b>	507	<b>SB7352</b>	475
1850x900	0,23	29	<b>SB7436</b>	848	<b>SB7353</b>	611
2000x1000	0,28	34	<b>SB7437</b>	867	<b>SB7354</b>	627

	 1 m3 		Ultra-matte Ultramate		Laminate Laminado	
ø600	0,06	9	<b>SB7392</b>	253	<b>SB7341</b>	209
ø700	0	0	<b>SB7393</b>	276	<b>SB7342</b>	198
ø800	0,1	25	<b>SB7394</b>	420	<b>SB7343</b>	293
ø900	0,12	27	<b>SB7395</b>	525	<b>SB7344</b>	362
ø1000	0,14	21	<b>SB7425</b>	581	<b>SB7345</b>	371
ø1100	0,17	24	<b>SB7426</b>	616	<b>SB7346</b>	387
ø1200	0,2	28	<b>SB7427</b>	627	<b>SB7347</b>	402
ø1300	0,24	33	<b>SB7428</b>	809	<b>SB7348</b>	517
ø1400	0,27	38	<b>SB7429</b>	855	<b>SB7349</b>	564
ø1500	0,31	42	<b>SB7430</b>	899	<b>SB7350</b>	588

	 1 m3 		Ultra-matte Ultramate		Laminate Laminado	
600x600	0,06	11	<b>SB7382</b>	236	<b>SB7331</b>	189
700x700	0,08	14	<b>SB7383</b>	257	<b>SB7332</b>	202
800x800	0,1	21	<b>SB7384</b>	406	<b>SB7333</b>	269
900x900	0,12	21	<b>SB7385</b>	501	<b>SB7334</b>	342
1000x1000	0,14	26	<b>SB7386</b>	555	<b>SB7335</b>	348
1100x1100	0,17	30	<b>SB7387</b>	590	<b>SB7336</b>	370
1200x1200	0,2	35	<b>SB7388</b>	599	<b>SB7337</b>	376
1300x1300	0,24	41	<b>SB7389</b>	780	<b>SB7338</b>	488
1400x1400	0,27	47	<b>SB7390</b>	823	<b>SB7339</b>	536
1500x1500	0,31	53	<b>SB7391</b>	867	<b>SB7340</b>	555



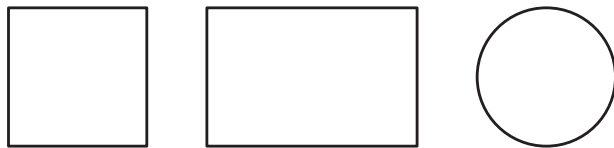

**Description** 40mm. thick maple top available on both sides with solid edges. Can be combined with any central table base collection.  
**Descripción** Sobres de arce de 40mm. con cantos macizos. Válido para cualquier colección de columna central.

**Wood finish Maple**  
**Acabado madera Arce**



**Wood lacquer finish**  
**Acabado lacas madera**



**Laminated**  
**Laminado**

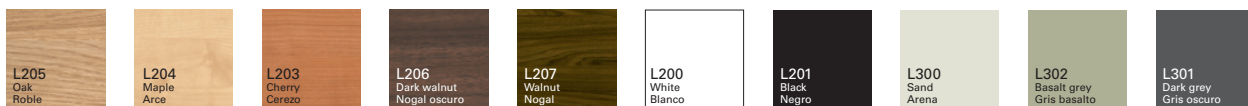

**Ultra-matte finish**  
**Acabado ultramate**



**Edge**  
**Perfil**



**Intellectual property Propiedad intelectual**

All our collections are protected by international industrial design registries, designs patents, copyrights and intellectual Property laws. Unauthorized use of AW International Property is a criminal offence and can lead to prosecution.  
 Todas nuestras colecciones están protegidas por registros de diseño industrial, diseño de patente, copyright y derechos de propiedad intelectual en todo el mundo. El uso no autorizado de los diseños y propiedad intelectual de AW supone un delito que puede ser sometido a acción judicial.



40 mm thick maple table top.

Sobre de mesa de arce de 40 mm de espesor.

Edge / Perfil



□	1 m3 kg		Ultra-matte Ultramate		Laminate Laminado		Lacquered Lacado		Maple Arce		S600
	□	kg	SB		SB		SB		SB		
700x600	0,07	14	SB7565	302	SB7593	239	SB7254	247	SB7365	285	96
800x600	0,08	22	SB7566	345	SB7594	276	SB7255	277	SB7366	326	102
800x700	0,09	23	SB7567	371	SB7595	290	SB7256	293	SB7367	344	102
1200x700	0,12	25	SB7545	534	SB7573	413	SB7250	426	SB7147	488	122
1500x900	0,07	41	SB7546	770	SB7574	584	SB7251	597	SB7148	680	141
1850x900	0,23	46	SB7547	936	SB7575	708	SB7252	730	SB7149	825	167
2000x1000	0,28	58	SB7548	1.098	SB7576	823	SB7253	838	SB7150	960	198

○	1 m3 kg		Ultra-matte Ultramate		Laminate Laminado		Lacquered Lacado		Maple Arce		S600
	○	kg	SB		SB		SB		SB		
ø600	0,04	12	SB7555	278	SB7583	221	SB7240	238	SB7320	270	90
ø700	0,06	15	SB7556	380	SB7584	261	SB7241	276	SB7321	311	96
ø800	0,08	20	SB7557	447	SB7585	320	SB7242	334	SB7322	378	102
ø900	0,1	21	SB7558	494	SB7586	370	SB7243	385	SB7323	436	110
ø1000	0,12	30	SB7559	634	SB7587	489	SB7244	520	SB7324	582	119
ø1100	0,14	27	SB7560	700	SB7588	531	SB7245	568	SB7236	626	129
ø1200	0,17	38	SB7561	868	SB7589	667	SB7246	632	SB7325	722	141
ø1300	0,2	36	SB7562	1.034	SB7590	794	SB7247	743	SB7237	862	152
ø1400	0,24	42	SB7563	1.095	SB7591	826	SB7248	864	SB7238	963	162
ø1500	0,27	48	SB7564	1.255	SB7592	947	SB7249	990	SB7239	1.105	228

□	1 m3 kg		Ultra-matte Ultramate		Laminate Laminado		Lacquered Lacado		Maple Arce		S600
	□	kg	SB		SB		SB		SB		
400x400	0,03	6	SB7540	198	SB7568	166	SB7225	192	SB7138	207	65
600x600	0,04	13	SB7541	268	SB7569	214	SB7226	223	SB7139	255	90
700x700	0,06	17	SB7542	350	SB7570	250	SB7227	261	SB7140	297	96
800x800	0,08	23	SB7543	411	SB7571	301	SB7228	312	SB7141	353	102
900x900	0,1	25	SB7544	480	SB7572	352	SB7229	365	SB7145	412	110
1000x1000	0,12	33	SB7549	612	SB7577	470	SB7230	490	SB7158	546	119
1100x1100	0,14	33	SB7550	648	SB7578	482	SB7231	510	SB7220	564	129
1200x1200	0,17	39	SB7551	762	SB7579	569	SB7232	610	SB7221	668	141
1300x1300	0,2	46	SB7552	929	SB7580	695	SB7233	730	SB7222	816	152
1400x1400	0,24	53	SB7553	1.053	SB7581	783	SB7234	838	SB7223	923	162
1500x1500	0,27	61	SB7554	1.197	SB7582	889	SB7235	962	SB7224	1.049	228

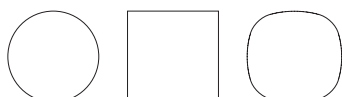

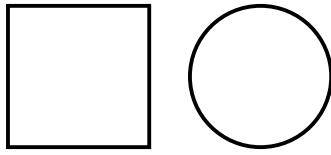

**Description**

20 mm. marble table tops available in 2 different shapes and sizes in sand and light gray finish.

**Descripción**

Sobres de mármol de 20 mm. disponible en 2 formas y medidas diferentes en acabado arena y gris claro.

**Terrazzo finish**

**Acabado terrazzo**



**Intellectual property Propiedad intelectual**

All our collections are protected by international industrial design registries, designs patents, copyrights and intellectual Property laws. Unauthorized use of AW International Property is a criminal offence and can lead to prosecution.  
Todas nuestras colecciones están protegidas por registros de diseño industrial, diseño de patente, copyright y derechos de propiedad intelectual en todo el mundo. El uso no autorizado de los diseños y propiedad intelectual de AW supone un delito que puede ser sometido a acción judicial.











20 mm thick marble table top.

Sobre de mármol de 20 mm de espesor.

Edge / Perfil



	 1	 m3	 kg		
600x600	0,06	11,8	<b>SB7300</b>	619	
700x700	0,08	15,8	<b>SB7301</b>	710	
800x800	0,1	20,5	<b>SB7302</b>	810	
900x900	0,12	25,7	<b>SB7303</b>	998	
1000x1000	0,14	31,6	<b>SB7304</b>	1.115	

	 1	 m3	 kg		
ø600	0,06	11,8	<b>SB7305</b>	697	
ø700	0,08	15,8	<b>SB7306</b>	800	
ø800	0,1	20,5	<b>SB7307</b>	913	
ø900	0,12	25,7	<b>SB7308</b>	1.115	
ø1000	0,14	31,6	<b>SB7309</b>	1.244	





**Andreu World**

**Table programs**

**Programas de mesa**





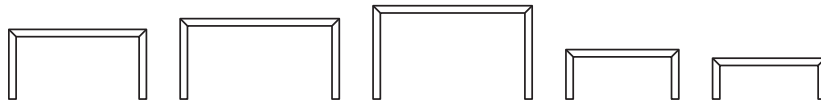

**Description**  
**Descripción**

Closed Table is a collection of tables with balanced proportions, sculptural shape and technological details that offer outstanding design for any environment. Available in walnut or oak veneer, laminate or lacquered, this collection combines design with technology.

Closed Table es un programa de mesas con unas equilibradas proporciones, forma escultural y detalles tecnológicos que ofrecen un diseño excepcional para cualquier entorno. Disponible en chapa de nogal o de roble, laminado o acabado lacado, este programa

**Wood finish Oak**  
**Acabado madera**  
**Roble**



**Wood lacquer finish**  
**Acabado lacas**  
**madera**



**Wood finish Walnut**  
**Acabado madera**  
**Nogal**

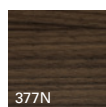

**Laminated**  
**Laminado**



**Power box**  
**Caja de conexiones**



**Certificates**  
**Certificados**

Quality - Resistance  
Calidad - Resistencia





UNE EN 15372

**Intellectual property Propiedad intelectual**

All our collections are protected by international industrial design registries, designs patents, copyrights and intellectual Property laws. Unauthorized use of AW International Property is a criminal offence and can lead to prosecution.

Todas nuestras colecciones están protegidas por registros de diseño industrial, diseño de patente, copyright y derechos de propiedad intelectual en todo el mundo. El uso no autorizado de los diseños y propiedad intelectual de AW supone un delito que puede ser sometido a acción judicial.



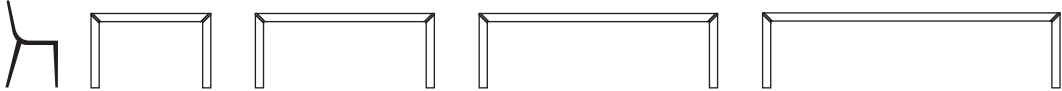

Tables Mesas	Width / Ancho	600	700	900	1.000
					

Length / Largo Height / Altura	750	1.200	1.800	2.400	3.000
					

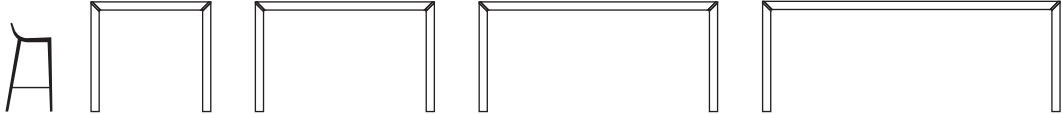
Length / Largo Height / Altura	900	1.200	1.800	2.400	3.000
					

Length / Largo Height / Altura	1.100	1.200	1.800	2.400	3.000
					

Benches Bancos	Length / Largo	960	1.560	2.160	2.760
	Height / Altura	450			
	Depth / Profundo	450			
					

Cushions Cojines	Length / Largo	510	960	1.560	2.160	2.760
	Depth / Profundo	450				
						
		1 seat 1 asiento	2 seat 2 asientos	3 seat 3 asientos	4 seat 4 asientos	5 seat 5 asientos

Occasional tables Mesas auxiliares	Length / Largo	700	
	Width / Ancho	700	
	Height / Altura	500	

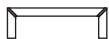
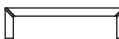
Occasional tables Mesas auxiliares	Length / Largo	700	1.000	1.200
	Width / Ancho	700	1.000	1.200
	Height / Altura	300		

Finishes Acabados	 Oak Roble	 Walnut Nogal	 Lacquer Lacado	 White laminate Blanco laminado	 Black laminate Negro laminado

## 750 Height / 600 Width / Standard Lengths 1200 - 1800 - 2400 - 3000

### 750 Alto / 600 Ancho / Longitudes estándar 1200 - 1800 - 2400 - 3000

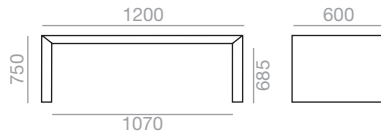

SERIE 600 \*Matte lacquered and premium upcharge  
Incremento por lacado mate y premium | 96 |

Finish Acabado	*Oak Roble	Walnut Nogal	Lacquered Lacado	Laminate Laminado
Reference Referencia	<b>ME6100</b>	<b>ME6148</b>	<b>ME6196</b>	<b>ME6244</b>
Price Precio	1.986	2.055	1.918	2.055
kg	49	49	49	49
<b>2 box 2 bulto</b> m3	0,31	0,31	0,31	0,31

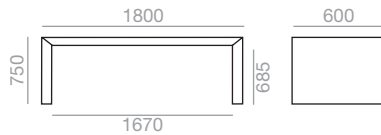

SERIE 600 \*Matte lacquered and premium upcharge  
Incremento por lacado mate y premium | 137 |

Finish Acabado	*Oak Roble	Walnut Nogal	Lacquered Lacado	Laminate Laminado
Reference Referencia	<b>ME6104</b>	<b>ME6152</b>	<b>ME6200</b>	<b>ME6248</b>
Price Precio	2.223	2.296	2.144	2.245
kg	59	59	59	59
<b>2 box 2 bulto</b> m3	0,38	0,38	0,38	0,38

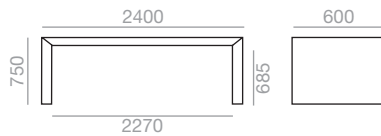

SERIE 600 \*Matte lacquered and premium upcharge  
Incremento por lacado mate y premium | 197 |

Finish Acabado	*Oak Roble	Walnut Nogal	Lacquered Lacado	Laminate Laminado
Reference Referencia	<b>ME6108</b>	<b>ME6156</b>	<b>ME6204</b>	<b>ME6252</b>
Price Precio	2.475	2.540	2.627	2.473
kg	69	70	70	70
<b>2 box 2 bulto</b> m3	0,45	0,45	0,45	0,45

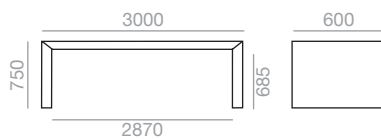

SERIE 600 \*Matte lacquered and premium upcharge  
Incremento por lacado mate y premium | 287 |

Finish Acabado	*Oak Roble	Walnut Nogal	Lacquered Lacado	Laminate Laminado
Reference Referencia	<b>ME6112</b>	<b>ME6160</b>	<b>ME6208</b>	<b>ME6256</b>
Price Precio	2.717	2.801	2.942	2.759
kg	79	79	79	79
<b>2 box 2 bulto</b> m3	0,51	0,51	0,51	0,51

750 Height / 700 Width / Standard Lengths 1200 - 1800 - 2400 - 3000

750 Alto / 700 Ancho / Longitudes estándar 1200 - 1800 - 2400 - 3000

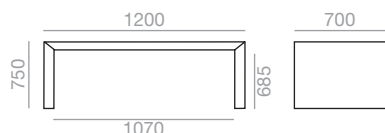

SERIE 600 \*Matte lacquered and premium upcharge  
Incremento por lacado mate y premium | 102 |

Finish Acabado	*Oak Roble	Walnut Nogal	Lacquered Lacado	Laminate Laminado
Reference Referencia	<b>ME6101</b>	<b>ME6149</b>	<b>ME6197</b>	<b>ME6245</b>
Price Precio	2.013	2.115	1.971	2.108
kg	55	55	55	55
<b>2 box 2 bulto</b> m3	0,36	0,36	0,36	0,36

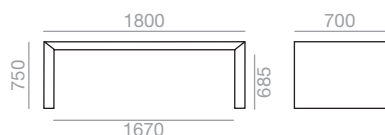

SERIE 600 \*Matte lacquered and premium upcharge  
Incremento por lacado mate y premium | 143 |

Finish Acabado	*Oak Roble	Walnut Nogal	Lacquered Lacado	Laminate Laminado
Reference Referencia	<b>ME6105</b>	<b>ME6153</b>	<b>ME6201</b>	<b>ME6249</b>
Price Precio	2.297	2.372	2.214	2.357
kg	66	66	66	66
<b>2 box 2 bulto</b> m3	0,43	0,43	0,43	0,43

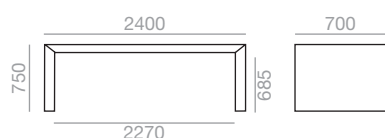

SERIE 600 \*Matte lacquered and premium upcharge  
Incremento por lacado mate y premium | 203 |

Finish Acabado	*Oak Roble	Walnut Nogal	Lacquered Lacado	Laminate Laminado
Reference Referencia	<b>ME6109</b>	<b>ME6157</b>	<b>ME6205</b>	<b>ME6253</b>
Price Precio	2.801	2.900	2.696	2.881
kg	78	78	78	78
<b>2 box 2 bulto</b> m3	0,51	0,51	0,51	0,51

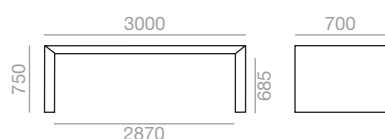

SERIE 600 \*Matte lacquered and premium upcharge  
Incremento por lacado mate y premium | 293 |

Finish Acabado	*Oak Roble	Walnut Nogal	Lacquered Lacado	Laminate Laminado
Reference Referencia	<b>ME6113</b>	<b>ME6161</b>	<b>ME6209</b>	<b>ME6257</b>
Price Precio	3.001	3.108	3.021	3.204
kg	90	90	90	90
<b>2 box 2 bulto</b> m3	0,59	0,59	0,59	0,59

**750 Height / 900 Width / Standard Lengths 1200 - 1800 - 2400 - 3000**  
**750 Alto / 900 Ancho / Longitudes estándar 1200 - 1800 - 2400 - 3000**

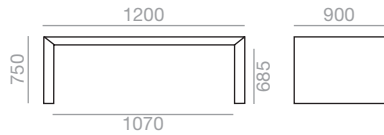

SERIE 600 \*Matte lacquered and premium upcharge  
 Incremento por lacado mate y premium | 114 |

Finish Acabado	*Oak Roble	Walnut Nogal	Lacquered Lacado	Laminate Laminado
Reference Referencia	<b>ME6102</b>	<b>ME6150</b>	<b>ME6198</b>	<b>ME6246</b>
Price Precio	2.336	2.426	2.246	2.463
kg	66	66	66	66
<b>2 box 2 bulto</b> m3	0,45	0,45	0,45	0,45

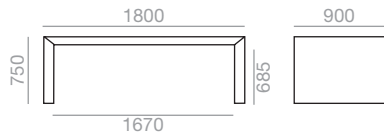

SERIE 600 \*Matte lacquered and premium upcharge  
 Incremento por lacado mate y premium | 155 |

Finish Acabado	*Oak Roble	Walnut Nogal	Lacquered Lacado	Laminate Laminado
Reference Referencia	<b>ME6106</b>	<b>ME6154</b>	<b>ME6202</b>	<b>ME6250</b>
Price Precio	2.565	2.685	2.491	2.680
kg	81	81	81	81
<b>2 box 2 bulto</b> m3	0,54	0,54	0,54	0,54

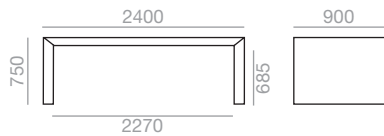

SERIE 600 \*Matte lacquered and premium upcharge  
 Incremento por lacado mate y premium | 215 |

Finish Acabado	*Oak Roble	Walnut Nogal	Lacquered Lacado	Laminate Laminado
Reference Referencia	<b>ME6110</b>	<b>ME6158</b>	<b>ME6206</b>	<b>ME6254</b>
Price Precio	3.098	3.215	2.979	3.253
kg	94	94	94	94
<b>2 box 2 bulto</b> m3	0,64	0,64	0,64	0,64

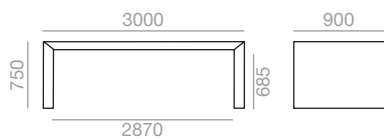

SERIE 600 \*Matte lacquered and premium upcharge  
 Incremento por lacado mate y premium | 305 |

Finish Acabado	*Oak Roble	Walnut Nogal	Lacquered Lacado	Laminate Laminado
Reference Referencia	<b>ME6114</b>	<b>ME6162</b>	<b>ME6210</b>	<b>ME6258</b>
Price Precio	3.469	3.600	3.330	3.621
kg	110	110	110	110
<b>2 box 2 bulto</b> m3	0,73	0,73	0,73	0,73

### 750 Height / 1000 Width / Standard Lengths 1200 - 1800 - 2400 - 3000 750 Alto / 1000 Ancho / Longitudes estándar 1200 - 1800 - 2400 - 3000

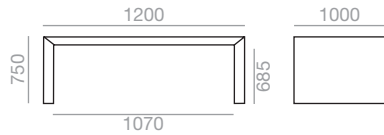

SERIE 600 \*Matte lacquered and premium upcharge  
Incremento por lacado mate y premium | 120 |

Finish Acabado	*Oak Roble	Walnut Nogal	Lacquered Lacado	Laminate Laminado
Reference Referencia	<b>ME6103</b>	<b>ME6151</b>	<b>ME6199</b>	<b>ME6247</b>
Price Precio	2.392	2.485	2.300	2.517
kg	72	72	72	72
<b>2 box 2 bulto</b> m3	0,49	0,49	0,49	0,49

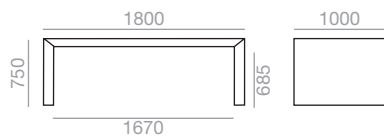

SERIE 600 \*Matte lacquered and premium upcharge  
Incremento por lacado mate y premium | 180 |

Finish Acabado	*Oak Roble	Walnut Nogal	Lacquered Lacado	Laminate Laminado
Reference Referencia	<b>ME6107</b>	<b>ME6155</b>	<b>ME6203</b>	<b>ME6251</b>
Price Precio	2.649	2.750	2.546	2.737
kg	87	87	87	87
<b>2 box 2 bulto</b> m3	0,6	0,6	0,6	0,6

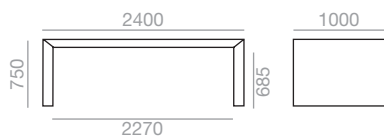

SERIE 600 \*Matte lacquered and premium upcharge  
Incremento por lacado mate y premium | 240 |

Finish Acabado	*Oak Roble	Walnut Nogal	Lacquered Lacado	Laminate Laminado
Reference Referencia	<b>ME6111</b>	<b>ME6159</b>	<b>ME6207</b>	<b>ME6255</b>
Price Precio	3.174	3.296	3.048	3.325
kg	103	103	103	103
<b>2 box 2 bulto</b> m3	0,7	0,7	0,7	0,7

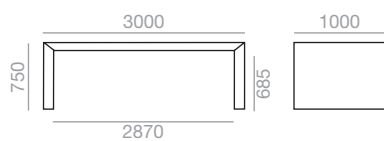

SERIE 600 \*Matte lacquered and premium upcharge  
Incremento por lacado mate y premium | 300 |

Finish Acabado	*Oak Roble	Walnut Nogal	Lacquered Lacado	Laminate Laminado
Reference Referencia	<b>ME6115</b>	<b>ME6163</b>	<b>ME6211</b>	<b>ME6259</b>
Price Precio	3.573	3.709	3.427	3.714
kg	103	119	119	119
<b>2 box 2 bulto</b> m3	0,81	0,81	0,81	0,81

## 900 Height / 600 Width / Standard Lengths 1200 - 1800 - 2400 - 3000

## 900 Alto / 600 Ancho / Longitudes estándar 1200 - 1800 - 2400 - 3000

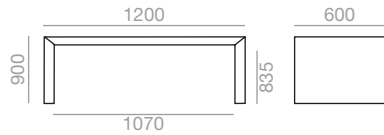

SERIE 600 \*Matte lacquered and premium upcharge  
Incremento por lacado mate y premium | 126 |

Finish Acabado	*Oak Roble	Walnut Nogal	Lacquered Lacado	Laminate Laminado
Reference Referencia	<b>ME6116</b>	<b>ME6164</b>	<b>ME6212</b>	<b>ME6260</b>
Price Precio	2.095	2.167	2.023	2.175
kg	52	52	52	52
<b>2 box 2 bulto</b> m3	0,34	0,34	0,34	0,34

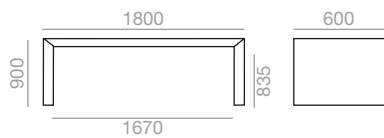

SERIE 600 \*Matte lacquered and premium upcharge  
Incremento por lacado mate y premium | 167 |

Finish Acabado	*Oak Roble	Walnut Nogal	Lacquered Lacado	Laminate Laminado
Reference Referencia	<b>ME6120</b>	<b>ME6168</b>	<b>ME6216</b>	<b>ME6264</b>
Price Precio	2.349	2.374	2.172	2.238
kg	63	63	63	63
<b>2 box 2 bulto</b> m3	0,41	0,41	0,41	0,41

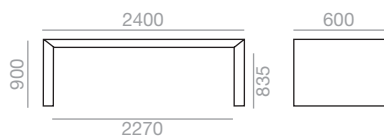

SERIE 600 \*Matte lacquered and premium upcharge  
Incremento por lacado mate y premium | 227 |

Finish Acabado	*Oak Roble	Walnut Nogal	Lacquered Lacado	Laminate Laminado
Reference Referencia	<b>ME6124</b>	<b>ME6172</b>	<b>ME6220</b>	<b>ME6268</b>
Price Precio	2.603	2.671	2.725	2.606
kg	73	73	73	73
<b>2 box 2 bulto</b> m3	0,47	0,47	0,47	0,47

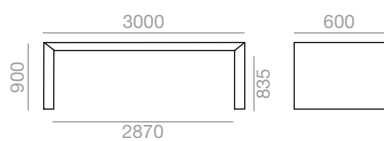

SERIE 600 \*Matte lacquered and premium upcharge  
Incremento por lacado mate y premium | 317 |

Finish Acabado	*Oak Roble	Walnut Nogal	Lacquered Lacado	Laminate Laminado
Reference Referencia	<b>ME6128</b>	<b>ME6176</b>	<b>ME6224</b>	<b>ME6272</b>
Price Precio	2.835	2.912	3.078	2.840
kg	82	82	82	82
<b>2 box 2 bulto</b> m3	0,54	0,54	0,54	0,54

900 Height / 700 Width / Standard Lengths 1200 - 1800 - 2400 - 3000

900 Alto / 700 Ancho / Longitudes estándar 1200 - 1800 - 2400 - 3000

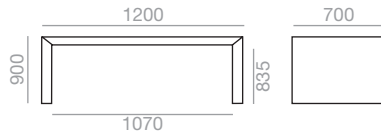

SERIE 600 \*Matte lacquered and premium upcharge  
Incremento por lacado mate y premium | 132 |

Finish Acabado	*Oak Roble	Walnut Nogal	Lacquered Lacado	Laminate Laminado
Reference Referencia	<b>ME6117</b>	<b>ME6165</b>	<b>ME6213</b>	<b>ME6261</b>
Price Precio	2.117	2.223	2.071	2.221
kg	58	58	58	69
<b>2 box 2 bulto</b> m3	0,39	0,39	0,39	0,39

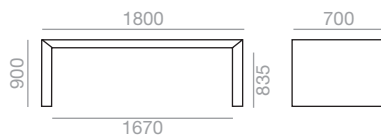

SERIE 600 \*Matte lacquered and premium upcharge  
Incremento por lacado mate y premium | 173 |

Finish Acabado	*Oak Roble	Walnut Nogal	Lacquered Lacado	Laminate Laminado
Reference Referencia	<b>ME6121</b>	<b>ME6169</b>	<b>ME6217</b>	<b>ME6265</b>
Price Precio	2.402	2.638	2.344	2.468
kg	70	70	70	70
<b>2 box 2 bulto</b> m3	0,46	0,46	0,46	0,46

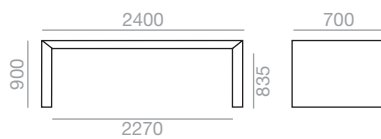

SERIE 600 \*Matte lacquered and premium upcharge  
Incremento por lacado mate y premium | 233 |

Finish Acabado	*Oak Roble	Walnut Nogal	Lacquered Lacado	Laminate Laminado
Reference Referencia	<b>ME6125</b>	<b>ME6173</b>	<b>ME6221</b>	<b>ME6269</b>
Price Precio	2.886	3.020	2.799	2.997
kg	82	82	82	82
<b>2 box 2 bulto</b> m3	0,54	0,54	0,54	0,54

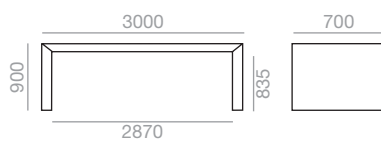

SERIE 600 \*Matte lacquered and premium upcharge  
Incremento por lacado mate y premium | 323 |

Finish Acabado	*Oak Roble	Walnut Nogal	Lacquered Lacado	Laminate Laminado
Reference Referencia	<b>ME6129</b>	<b>ME6177</b>	<b>ME6225</b>	<b>ME6273</b>
Price Precio	3.282	3.402	3.151	3.365
kg	93	93	93	93
<b>2 box 2 bulto</b> m3	0,62	0,62	0,62	0,62



### 900 Height / 900 Width / Standard Lengths 1200 - 1800 - 2400 - 3000 900 Alto / 900 Ancho / Longitudes estándar 1200 - 1800 - 2400 - 3000

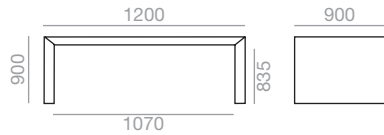

SERIE 600 \*Matte lacquered and premium upcharge  
Incremento por lacado mate y premium | 144 |

Finish Acabado	*Oak Roble	Walnut Nogal	Lacquered Lacado	Laminate Laminado
Reference Referencia	<b>ME6118</b>	<b>ME6166</b>	<b>ME6214</b>	<b>ME6262</b>
Price Precio	2.462	2.559	2.368	2.608
kg	70	70	70	70
<b>2 box 2 bulto</b> m3	0,48	0,48	0,48	0,48

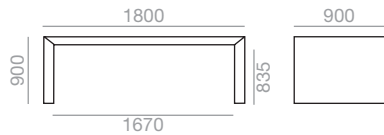

SERIE 600 \*Matte lacquered and premium upcharge  
Incremento por lacado mate y premium | 185 |

Finish Acabado	*Oak Roble	Walnut Nogal	Lacquered Lacado	Laminate Laminado
Reference Referencia	<b>ME6122</b>	<b>ME6170</b>	<b>ME6218</b>	<b>ME6266</b>
Price Precio	2.746	2.849	2.638	2.863
kg	85	85	85	85
<b>2 box 2 bulto</b> m3	0,58	0,58	0,58	0,58

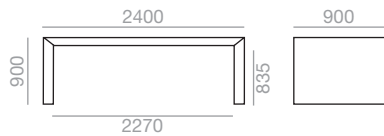

SERIE 600 \*Matte lacquered and premium upcharge  
Incremento por lacado mate y premium | 245 |

Finish Acabado	*Oak Roble	Walnut Nogal	Lacquered Lacado	Laminate Laminado
Reference Referencia	<b>ME6126</b>	<b>ME6174</b>	<b>ME6222</b>	<b>ME6270</b>
Price Precio	3.239	3.362	3.108	3.411
kg	99	99	99	99
<b>2 box 2 bulto</b> m3	0,68	0,68	0,68	0,68

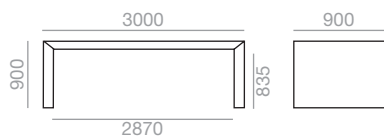

SERIE 600 \*Matte lacquered and premium upcharge  
Incremento por lacado mate y premium | 335 |

Finish Acabado	*Oak Roble	Walnut Nogal	Lacquered Lacado	Laminate Laminado
Reference Referencia	<b>ME6130</b>	<b>ME6178</b>	<b>ME6226</b>	<b>ME6274</b>
Price Precio	3.630	3.770	3.478	3.806
kg	114	114	114	114
<b>2 box 2 bulto</b> m3	0,76	0,76	0,76	0,76

**900 Height / 1000 Width / Standard Lengths 1200 - 1800 - 2400 - 3000**  
**900 Alto / 1000 Ancho / Longitudes estándar 1200 - 1800 - 2400 - 3000**

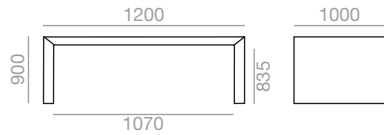

SERIE 600 \*Matte lacquered and premium upcharge  
 Incremento por lacado mate y premium | 150 |

Finish Acabado	*Oak Roble	Walnut Nogal	Lacquered Lacado	Laminate Laminado
Reference Referencia	<b>ME6119</b>	<b>ME6167</b>	<b>ME6215</b>	<b>ME6263</b>
Price Precio	2.521	2.621	2.422	2.664
kg	76	76	76	76
<b>2 box 2 bulto</b> m3	0,53	0,53	0,53	0,53

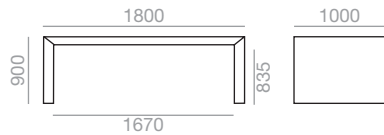

SERIE 600 \*Matte lacquered and premium upcharge  
 Incremento por lacado mate y premium | 191 |

Finish Acabado	*Oak Roble	Walnut Nogal	Lacquered Lacado	Laminate Laminado
Reference Referencia	<b>ME6123</b>	<b>ME6171</b>	<b>ME6219</b>	<b>ME6267</b>
Price Precio	2.815	2.922	2.702	2.937
kg	93	93	93	93
<b>2 box 2 bulto</b> m3	0,64	0,64	0,64	0,64

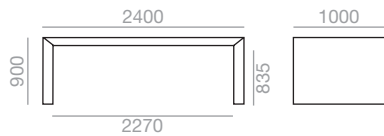

SERIE 600 \*Matte lacquered and premium upcharge  
 Incremento por lacado mate y premium | 251 |

Finish Acabado	*Oak Roble	Walnut Nogal	Lacquered Lacado	Laminate Laminado
Reference Referencia	<b>ME6127</b>	<b>ME6175</b>	<b>ME6223</b>	<b>ME6271</b>
Price Precio	3.321	3.449	3.185	3.494
kg	108	108	108	108
<b>2 box 2 bulto</b> m3	0,74	0,74	0,74	0,74

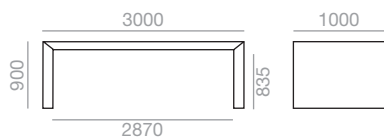

SERIE 600 \*Matte lacquered and premium upcharge  
 Incremento por lacado mate y premium | 341 |

Finish Acabado	*Oak Roble	Walnut Nogal	Lacquered Lacado	Laminate Laminado
Reference Referencia	<b>ME6131</b>	<b>ME6179</b>	<b>ME6227</b>	<b>ME6275</b>
Price Precio	3.731	3.873	3.571	3.892
kg	123	123	123	123
<b>2 box 2 bulto</b> m3	0,85	0,85	0,85	0,85

**1100 Height / 600 Width / Standard Lengths 1200 - 1800 - 2400 - 3000**  
**1100 Alto / 600 Ancho / Longitudes estándar 1200 - 1800 - 2400 - 3000**

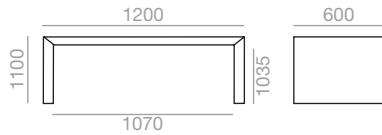

SERIE 600 \*Matte lacquered and premium upcharge  
 Incremento por lacado mate y premium | 156 |

Finish Acabado	*Oak Roble	Walnut Nogal	Lacquered Lacado	Laminate Laminado
Reference Referencia	<b>ME6132</b>	<b>ME6180</b>	<b>ME6228</b>	<b>ME6276</b>
Price Precio	2.296	2.381	2.216	2.427
kg	57	57	57	57
<b>2 box 2 bulto</b> m3	0,37	0,37	0,37	0,37

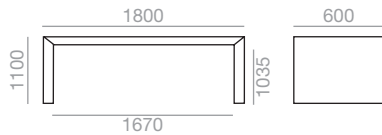

SERIE 600 \*Matte lacquered and premium upcharge  
 Incremento por lacado mate y premium | 197 |

Finish Acabado	*Oak Roble	Walnut Nogal	Lacquered Lacado	Laminate Laminado
Reference Referencia	<b>ME6136</b>	<b>ME6184</b>	<b>ME6232</b>	<b>ME6280</b>
Price Precio	2.456	2.682	2.928	2.462
kg	67	67	67	67
<b>2 box 2 bulto</b> m3	0,44	0,44	0,44	0,44

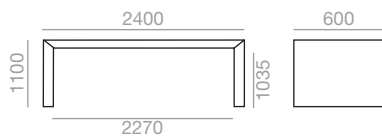

SERIE 600 \*Matte lacquered and premium upcharge  
 Incremento por lacado mate y premium | 257 |

Finish Acabado	*Oak Roble	Walnut Nogal	Lacquered Lacado	Laminate Laminado
Reference Referencia	<b>ME6140</b>	<b>ME6188</b>	<b>ME6236</b>	<b>ME6284</b>
Price Precio	2.681	2.760	3.133	2.691
kg	76	76	76	76
<b>2 box 2 bulto</b> m3	0,51	0,51	0,51	0,51

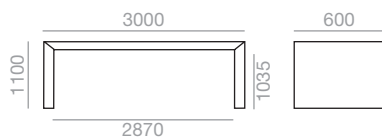

SERIE 600 \*Matte lacquered and premium upcharge  
 Incremento por lacado mate y premium | 347 |

Finish Acabado	*Oak Roble	Walnut Nogal	Lacquered Lacado	Laminate Laminado
Reference Referencia	<b>ME6144</b>	<b>ME6192</b>	<b>ME6240</b>	<b>ME6288</b>
Price Precio	2.944	3.020	3.456	2.942
kg	87	87	87	87
<b>2 box 2 bulto</b> m3	0,57	0,57	0,57	0,57

**1100 Height / 700 Width / Standard Lengths 1200 - 1800 - 2400 - 3000**  
**1100 Alto / 700 Ancho / Longitudes estándar 1200 - 1800 - 2400 - 3000**

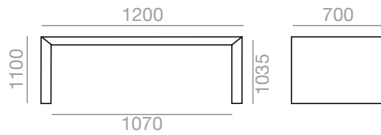

SERIE 600 \*Matte lacquered and premium upcharge  
 Incremento por lacado mate y premium | 162 |

Finish Acabado	*Oak Roble	Walnut Nogal	Lacquered Lacado	Laminate Laminado
Reference Referencia	<b>ME6133</b>	<b>ME6181</b>	<b>ME6229</b>	<b>ME6277</b>
Price Precio	2.316	2.434	2.260	2.466
kg	63	63	63	63
<b>2 box 2 bulto</b> m3	0,37	0,37	0,37	0,37

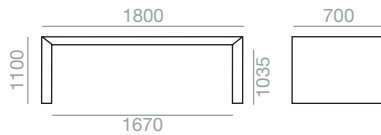

SERIE 600 \*Matte lacquered and premium upcharge  
 Incremento por lacado mate y premium | 203 |

Finish Acabado	*Oak Roble	Walnut Nogal	Lacquered Lacado	Laminate Laminado
Reference Referencia	<b>ME6137</b>	<b>ME6185</b>	<b>ME6233</b>	<b>ME6281</b>
Price Precio	2.576	2.800	2.991	2.799
kg	75	75	75	75
<b>2 box 2 bulto</b> m3	0,44	0,44	0,44	0,44

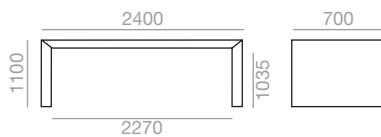

SERIE 600 \*Matte lacquered and premium upcharge  
 Incremento por lacado mate y premium | 263 |

Finish Acabado	*Oak Roble	Walnut Nogal	Lacquered Lacado	Laminate Laminado
Reference Referencia	<b>ME6141</b>	<b>ME6189</b>	<b>ME6237</b>	<b>ME6285</b>
Price Precio	3.059	3.098	3.168	3.105
kg	87	87	87	87
<b>2 box 2 bulto</b> m3	0,51	0,51	0,51	0,51

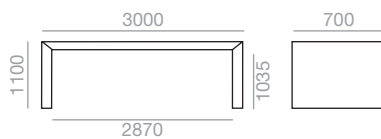

SERIE 600 \*Matte lacquered and premium upcharge  
 Incremento por lacado mate y premium | 353 |

Finish Acabado	*Oak Roble	Walnut Nogal	Lacquered Lacado	Laminate Laminado
Reference Referencia	<b>ME6145</b>	<b>ME6193</b>	<b>ME6241</b>	<b>ME6289</b>
Price Precio	3.420	3.430	3.491	3.432
kg	97	97	97	97
<b>2 box 2 bulto</b> m3	0,57	0,57	0,57	0,57

**1100 Height / 900 Width / Standard Lengths 1200 - 1800 - 2400 - 3000**  
**1100 Alto / 900 Ancho / Longitudes estándar 1200 - 1800 - 2400 - 3000**

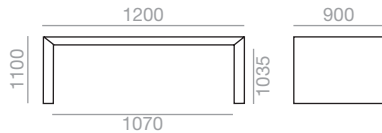

SERIE 600 \*Matte lacquered and premium upcharge  
 Incremento por lacado mate y premium | 174 |

Finish Acabado	*Oak Roble	Walnut Nogal	Lacquered Lacado	Laminate Laminado
Reference Referencia	<b>ME6134</b>	<b>ME6182</b>	<b>ME6230</b>	<b>ME6278</b>
Price Precio	2.678	2.787	2.573	2.881
kg	76	76	76	76
<b>2 box 2 bulto</b> m3	0,53	0,53	0,53	0,53

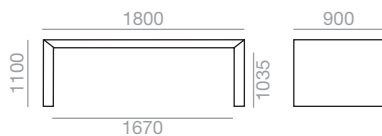

SERIE 600 \*Matte lacquered and premium upcharge  
 Incremento por lacado mate y premium | 215 |

Finish Acabado	*Oak Roble	Walnut Nogal	Lacquered Lacado	Laminate Laminado
Reference Referencia	<b>ME6138</b>	<b>ME6186</b>	<b>ME6234</b>	<b>ME6282</b>
Price Precio	2.930	3.188	3.315	3.198
kg	92	92	92	92
<b>2 box 2 bulto</b> m3	0,63	0,63	0,63	0,63

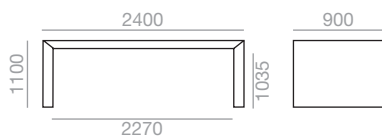

SERIE 600 \*Matte lacquered and premium upcharge  
 Incremento por lacado mate y premium | 275 |

Finish Acabado	*Oak Roble	Walnut Nogal	Lacquered Lacado	Laminate Laminado
Reference Referencia	<b>ME6142</b>	<b>ME6190</b>	<b>ME6238</b>	<b>ME6286</b>
Price Precio	3.430	3.549	3.477	3.545
kg	105	105	105	105
<b>2 box 2 bulto</b> m3	0,72	0,72	0,72	0,72

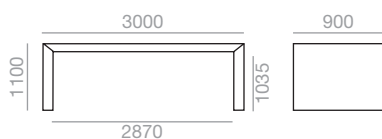

SERIE 600 \*Matte lacquered and premium upcharge  
 Incremento por lacado mate y premium | 365 |

Finish Acabado	*Oak Roble	Walnut Nogal	Lacquered Lacado	Laminate Laminado
Reference Referencia	<b>ME6146</b>	<b>ME6194</b>	<b>ME6242</b>	<b>ME6290</b>
Price Precio	3.773	3.840	3.815	3.844
kg	121	121	121	121
<b>2 box 2 bulto</b> m3	0,82	0,82	0,82	0,82

1100 Height / 1000 Width / Standard Lengths 1200 - 1800 - 2400 - 3000

1100 Alto / 1000 Ancho / Longitudes estándar 1200 - 1800 - 2400 - 3000

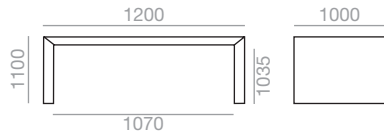

SERIE 600 \*Matte lacquered and premium upcharge  
Incremento por lacado mate y premium | 180 |

Finish Acabado	*Oak Roble	Walnut Nogal	Lacquered Lacado	Laminate Laminado
Reference Referencia	<b>ME6135</b>	<b>ME6183</b>	<b>ME6231</b>	<b>ME6279</b>
Price Precio	2.743	2.857	2.632	2.945
kg	84	84	84	84
<b>2 box 2 bulto</b> m3	0,59	0,59	0,59	0,59

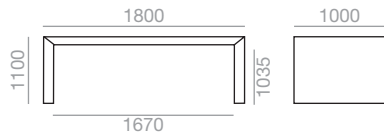

SERIE 600 \*Matte lacquered and premium upcharge  
Incremento por lacado mate y premium | 221 |

Finish Acabado	*Oak Roble	Walnut Nogal	Lacquered Lacado	Laminate Laminado
Reference Referencia	<b>ME6139</b>	<b>ME6187</b>	<b>ME6235</b>	<b>ME6283</b>
Price Precio	2.978	3.247	3.375	3.292
kg	99	99	99	99
<b>2 box 2 bulto</b> m3	0,69	0,69	0,69	0,69

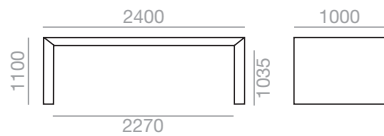

SERIE 600 \*Matte lacquered and premium upcharge  
Incremento por lacado mate y premium | 281 |

Finish Acabado	*Oak Roble	Walnut Nogal	Lacquered Lacado	Laminate Laminado
Reference Referencia	<b>ME6143</b>	<b>ME6191</b>	<b>ME6239</b>	<b>ME6287</b>
Price Precio	3.484	3.807	3.532	3.675
kg	114	114	114	114
<b>2 box 2 bulto</b> m3	0,8	0,8	0,8	0,8

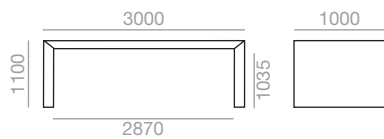

SERIE 600 \*Matte lacquered and premium upcharge  
Incremento por lacado mate y premium | 371 |

Finish Acabado	*Oak Roble	Walnut Nogal	Lacquered Lacado	Laminate Laminado
Reference Referencia	<b>ME6147</b>	<b>ME6195</b>	<b>ME6243</b>	<b>ME6291</b>
Price Precio	3.856	4.234	3.883	3.928
kg	130	130	130	130
<b>2 box 2 bulto</b> m3	0,9	0,9	0,9	0,9

## Occasional tables Mesas auxiliares

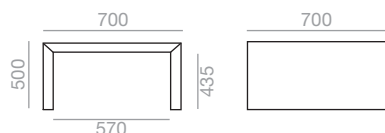

SERIE 600 \*Matte lacquered and premium upcharge  
Incremento por lacado mate y premium | 90 |

Finish Acabado	*Oak Roble	Walnut Nogal	Lacquered Lacado	Laminate Laminado
Reference Referencia	<b>ME6330</b>	<b>ME6335</b>	<b>ME6340</b>	<b>ME6345</b>
Price Precio	1.339	1.409	1.318	1.420
kg	63	63	63	63
<b>1 box 1 bulto</b> m3	0,38	0,38	0,38	0,38

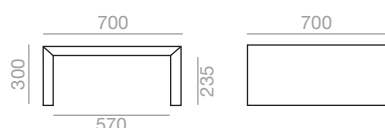

SERIE 600 \*Matte lacquered and premium upcharge  
Incremento por lacado mate y premium | 84 |

Finish Acabado	*Oak Roble	Walnut Nogal	Lacquered Lacado	Laminate Laminado
Reference Referencia	<b>ME6331</b>	<b>ME6336</b>	<b>ME6341</b>	<b>ME6346</b>
Price Precio	1.220	1.282	1.205	1.259
kg	44	44	44	44
<b>1 box 1 bulto</b> m3	0,26	0,26	0,26	0,26

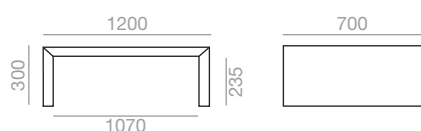

SERIE 600 \*Matte lacquered and premium upcharge  
Incremento por lacado mate y premium | 99 |

Finish Acabado	*Oak Roble	Walnut Nogal	Lacquered Lacado	Laminate Laminado
Reference Referencia	<b>ME6332</b>	<b>ME6337</b>	<b>ME6342</b>	<b>ME6347</b>
Price Precio	1.387	1.444	1.352	1.458
kg	68	68	68	68
<b>1 box 1 bulto</b> m3	0,42	0,42	0,42	0,42

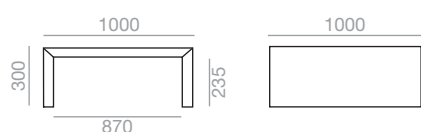

SERIE 600 \*Matte lacquered and premium upcharge  
Incremento por lacado mate y premium | 108 |

Finish Acabado	*Oak Roble	Walnut Nogal	Lacquered Lacado	Laminate Laminado
Reference Referencia	<b>ME6333</b>	<b>ME6338</b>	<b>ME6343</b>	<b>ME6348</b>
Price Precio	1.604	1.713	1.589	1.799
kg	78	78	78	78
<b>1 box 1 bulto</b> m3	0,48	0,48	0,48	0,48

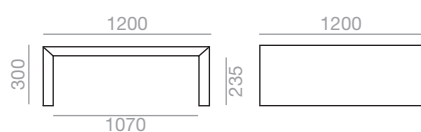

SERIE 600 \*Matte lacquered and premium upcharge  
Incremento por lacado mate y premium | 87 |

Finish Acabado	*Oak Roble	Walnut Nogal	Lacquered Lacado	Laminate Laminado
Reference Referencia	<b>ME6334</b>	<b>ME6339</b>	<b>ME6344</b>	<b>ME6349</b>
Price Precio	1.682	1.772	1.647	1.850
kg	108	108	105	108
<b>1 box 1 bulto</b> m3	0,68	0,68	0,68	0,68

## PS-IN SURFACE

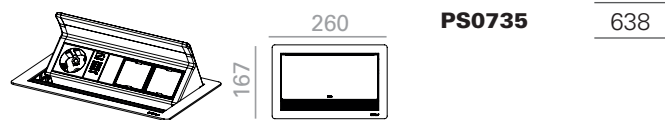

**PS0735** 638

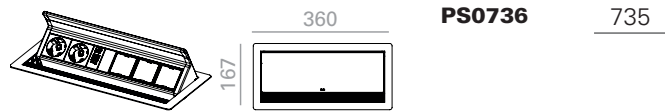

**PS0736** 735



**PS0804** 142

## PS-QI



**PS0714** 243

### Preinstalled (Optional) / Preinstalación (Opcional) IN0006

First installation / Primera instalación 270  
Second and more installations / Segunda y más instalaciones 90

## PS-UNDERTOP

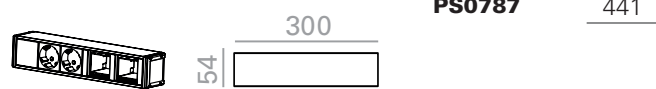

**PS0787** 441

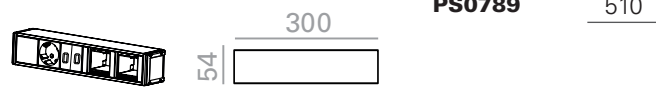

**PS0789** 510

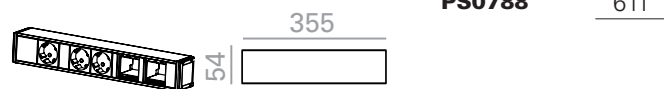

**PS0788** 611

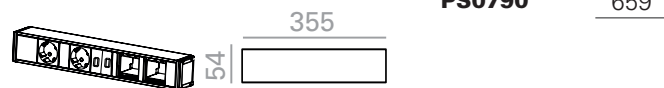

**PS0790** 659

## PS-INTREGATED



**PS0710** 680



**PS0720** 743



**IN-SURFACE POWER BOXES  
CAJAS DE CONEXIONES DENTRO DEL SOBRE**

Aluminum power box mounted in the table top with a folding protective lid. It is served in anodized silver, black or white, for other finishing, contact the Customer Department. There are two power system sizes available and data slots can be customized according to the below diagram.

Caja de conexiones de aluminio integrada dentro de la superficie del sobre con tapa abatible. Se sirve en color anodizado plata, negro o blanco, para otros acabados consultar al Departamento Comercial. Se ofrecen formatos de caja de dos tamaños de caja diferentes y con opciones de conectividad configurable.

**PS0735**

**PS0736**

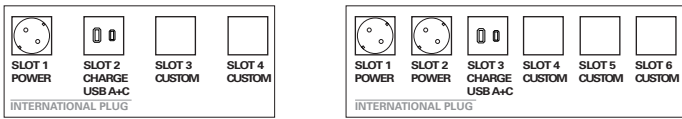

CHOOSE DATA PORT FOR DATA CUSTOM PORT SLOTS

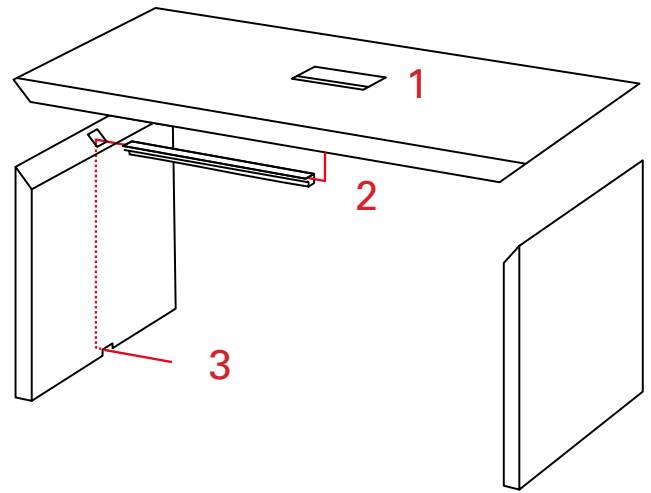
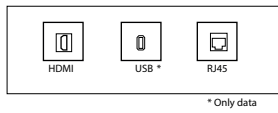

**1 POWER BOXES DISTRIBUTION DISTRIBUCIÓN DE SISTEMAS**

By standard, the position of the system will be in the central of the table, placed horizontally. When there are two system boxes, these will be separated 1/3 between them and placed horizontally. For other options, please contact the Customer Department.

De serie, la disposición del sistema será en el centro de la mesa y en sentido longitudinal. Cuando se disponga de dos sistemas, estos se colocarán con una separación de 1/3 de la longitud total de la mesa, y en sentido longitudinal. Otras opciones consultar con el Departamento Comercial.

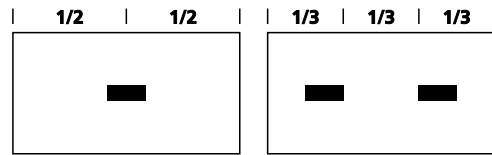

**2 WIRING MANAGEMENT GESTIÓN DEL CABLEADO**

Wire pass through an aluminum grommet keeping it hidden. By default color is silver, for other finishings ask the Customer Department.

El cable se pasa a través de un perfil pasacables de aluminio que lo mantiene oculto. Su color de serie es el plata, para otros acabados consultar al Departamento Comercial.

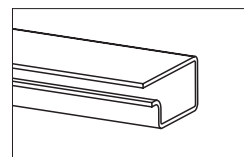

**OPTIONAL PREINSTALLED WIRING  
PREINSTALACIÓN DEL CABLEADO**

**IN0006**

Preinstalled wiring consists in the addition of the necessary mechanisms to integrate power systems in the table, so that wiring is hidden until the way out in the door. Necessary grommet are included and 3m cable (from the power system). For other cable dimensions contact the Customer Department.

La preinstalación consiste en el montaje de los mecanismos necesarios para integrar el sistema de electrificación en la mesa, de modo que el cableado quede oculto hasta su salida por la base. Se incluyen los pasacables necesarios y 3 metros de cable (midiendo desde el sistema de conexiones). Para otras longitudes de cable consultar al Departamento Comercial.

**3 CABLE WAY OUT SALIDA DE CABLEADO**

The cable way out can be performed directly from the power system or through a canal in the base bottom, so that is hidden until it gets to the floor.

La salida del cable se realiza directamente desde el propio sistema como por unas canalizaciones en la parte inferior de la base, de modo que el cable queda oculto hasta llegar al suelo.

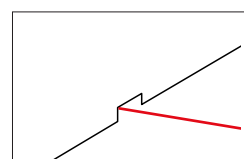

**IN-SURFACE POWER BOXES  
CAJAS DE CONEXIONES DENTRO DEL SOBRE**

It is a data dynamo with 2 amp dual charging USB. Available in two finish: black or white.

Es una dínamo de datos con 2 amp de carga dual USB. Disponible en dos acabados: negro o blanco.

**PS0804**

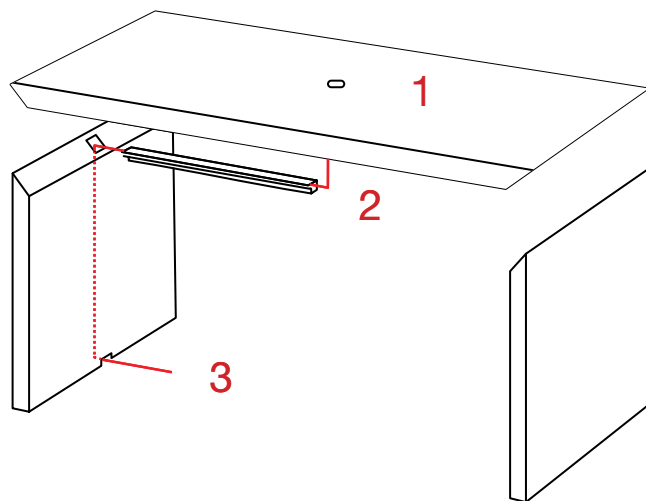
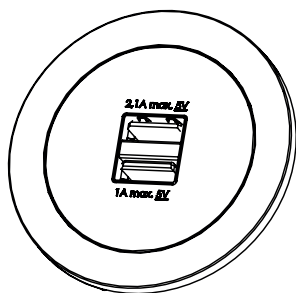

**1 POWER BOXES DISTRIBUTION DISTRIBUCIÓN DE SISTEMAS**

By standard, the position of the system will be in the central of the table, placed horizontally. When there are two system boxes, these will be separated 1/3 between them and placed horizontally. For other options, please contact the Customer Department.

De serie, la disposición del sistema será en el centro de la mesa y en sentido longitudinal. Cuando se disponga de dos sistemas, estos se colocarán con una separación de 1/3 de la longitud total de la mesa, y en sentido longitudinal. Otras opciones consultar con el Departamento Comercial.

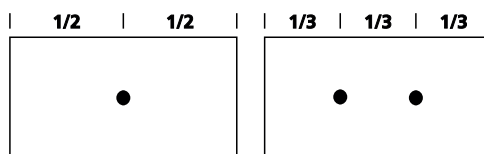

**OPTIONAL PREINSTALLED WIRING  
PREINSTALACIÓN DEL CABLEADO**

**IN0006**

Preinstalled wiring consists in the addition of the necessary mechanisms to integrate power systems in the table, so that wiring is hidden until the way out in the door. Necessary grommet are included and 3m cable (from the power system). For other cable dimensions contact the Customer Department.

La preinstalación consiste en el montaje de los mecanismos necesarios para integrar el sistema de electrificación en la mesa, de modo que el cableado quede oculto hasta su salida por la base. Se incluyen los pasacables necesarios y 3 metros de cable (midiendo desde el sistema de conexiones). Para otras longitudes de cable consultar al Departamento Comercial.

**2 WIRING MANAGEMENT GESTIÓN DEL CABLEADO**

Wire pass through an aluminum grommet keeping it hidden. By default color is silver, for other finishings ask the Customer Department.

El cable se pasa a través de un perfil pasacables de aluminio que lo mantiene oculto. Su color de serie es el plata, para otros acabados consultar al Departamento Comercial.

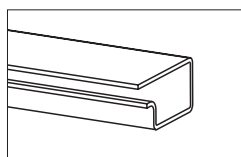

**3 CABLE WAY OUT SALIDA DE CABLEADO**

The cable way out can be performed directly from the power system or through a canal in the base bottom, so that is hidden until it gets to the floor.

La salida del cable se realiza directamente desde el propio sistema como por unas canalizaciones en la parte inferior de la base, de modo que el cable queda oculto hasta llegar al suelo.

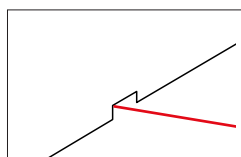

**INTEGRATED POWER BOXES  
CAJAS DE CONEXIONES INTEGRADAS**

The black finish is integrated with the top. Its opening is towards both sides.

El acabado negro está integrado con la parte superior. Su apertura es hacia ambos lados.

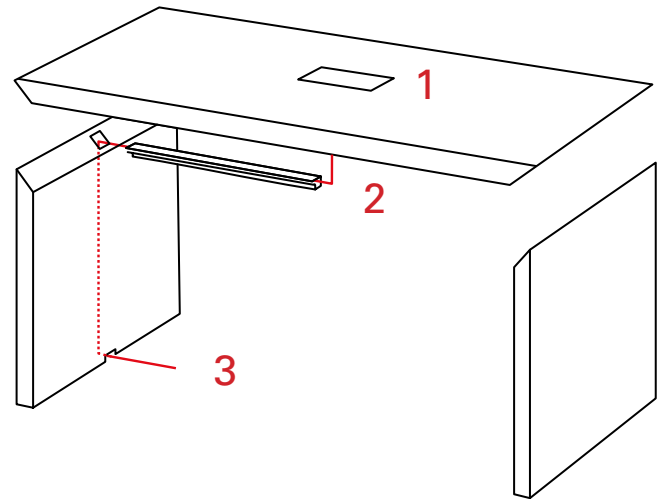
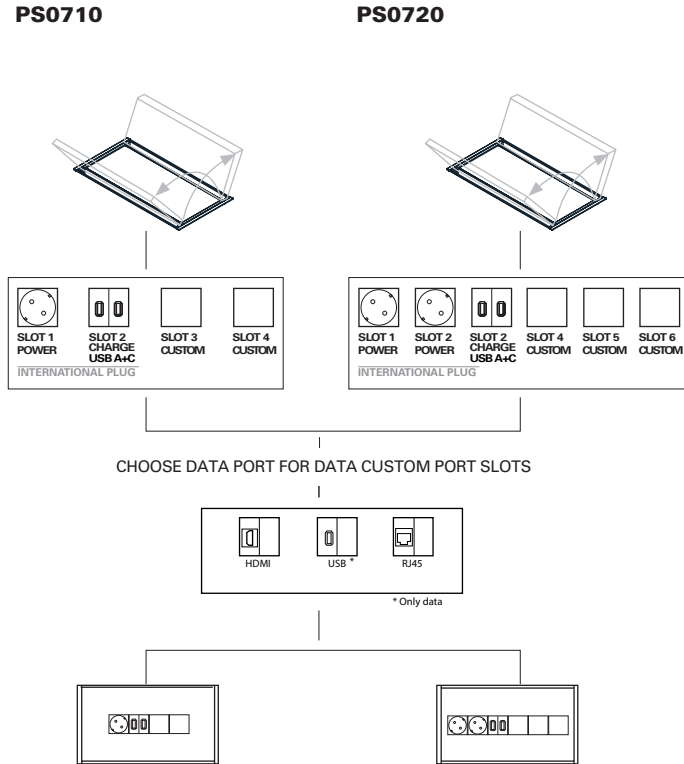

**1 POWER BOXES DISTRIBUTION DISTRIBUCIÓN DE SISTEMAS**

By standard, the position of the system will be in the central of the table, placed horizontally. When there are two system boxes, these will be separated 1/3 between them and placed horizontally. For other options, please contact the Customer Department.

De serie, la disposición del sistema será en el centro de la mesa y en sentido longitudinal. Cuando se disponga de dos sistemas, estos se colocarán con una separación de 1/3 de la longitud total de la mesa, y en sentido longitudinal. Otras opciones consultar con el Departamento Comercial.

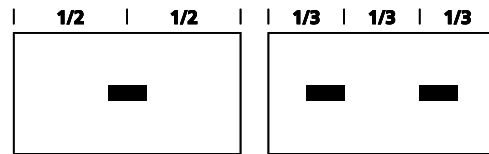

**2 WIRING MANAGEMENT GESTIÓN DEL CABLEADO**

Wire pass through an aluminum grommet keeping it hidden. By default color is silver, for other finishings ask the Customer Department.

El cable se pasa a través de un perfil pasacables de aluminio que lo mantiene oculto. Su color de serie es el plata, para otros acabados consultar al Departamento Comercial.

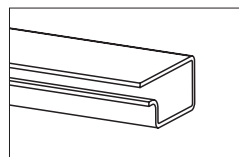

**OPTIONAL PREINSTALLED WIRING  
PREINSTALACIÓN DEL CABLEADO**

**IN0006**

Preinstalled wiring consists in the addition of the necessary mechanisms to integrate power systems in the table, so that wiring is hidden until the way out in the door. Necessary grommet are included and 3m cable (from the power system). For other cable dimensions contact the Customer Department.

La preinstalación consiste en el montaje de los mecanismos necesarios para integrar el sistema de electrificación en la mesa, de modo que el cableado quede oculto hasta su salida por la base. Se incluyen los pasacables necesarios y 3 metros de cable (midiendo desde el sistema de conexiones). Para otras longitudes de cable consultar al Departamento Comercial.

**3 CABLE WAY OUT SALIDA DE CABLEADO**

The cable way out can be performed directly from the power system or through a canal in the base bottom, so that is hidden until it gets to the floor.

La salida del cable se realiza directamente desde el propio sistema como por unas canalizaciones en la parte inferior de la base, de modo que el cable queda oculto hasta llegar al suelo.

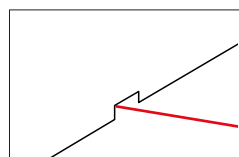

**UNDER-TOP POWER BOXES  
CAJA DE CONEXIONES BAJO EL SOBRE**

Power box mounted under the table top. Available in black or white color (silver or black in USA), for other finishing, contact the Customer Department. There are two power system sizes available and data slots can be customized according to the below diagram.

Regleta de conexiones bajo la superficie del sobre. Se sirve en color negro o blanco (plata o negro en USA). Para otros acabados consultar al departamento comercial. Se ofrecen formatos de caja de dos tamaños de caja diferentes y con opciones de conectividad configurable.

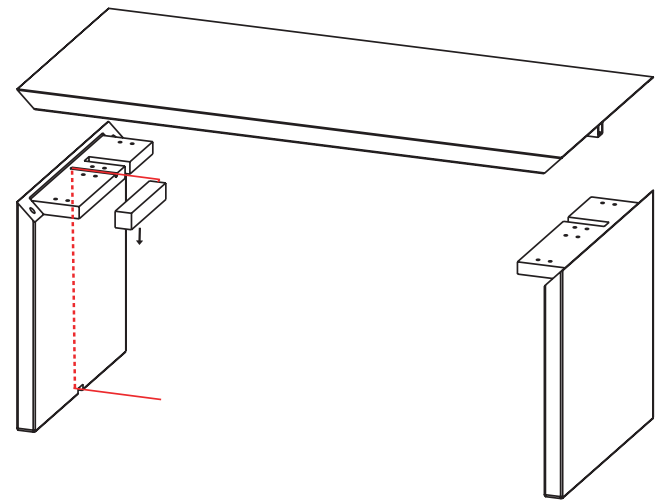

**1 POWER BOXES DISTRIBUTION DISTRIBUCIÓN DE SISTEMAS**

By standard, the position of the system will be in the central of the table, placed horizontally. When there are two system boxes, these will be separated 1/3 between them and placed horizontally. For other options, please contact the Customer Department.

De serie, el sistema se instala a la izquierda de la mesa, orientado hacia la pata opuesta, y el cable bajaría por al misma pata. Para distribuciones especiales consultar al Departamento Comercial.

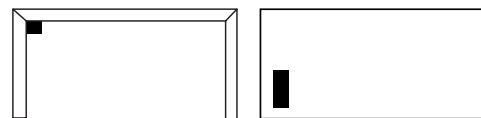

**2 WIRING MANAGEMENT GESTIÓN DEL CABLEADO**

Wire pass through an aluminum grommet keeping it hidden. By default color is silver, for other finishings ask the Customer Department.

El cable se pasa a través de un perfil pasacables de aluminio que lo mantiene oculto. Su color de serie es el plata, para otros acabados consultar al Departamento Comercial.

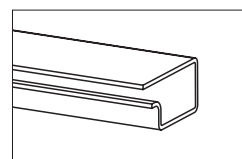

**3 CABLE WAY OUT SALIDA DE CABLEADO**

The cable way out can be performed directly from the power system or through a canal in the base bottom, so that is hidden until it gets to the floor.

La salida del cable se realiza directamente desde el propio sistema como por unas canalizaciones en la parte inferior de la base, de modo que el cable queda oculto hasta llegar al suelo.

**PS0787**

**PS0788**

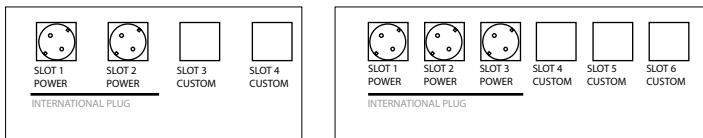

CHOOSE DATA PORT FOR DATA CUSTOM PORT SLOTS

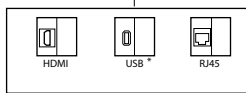

**PS0789**

**PS0790**

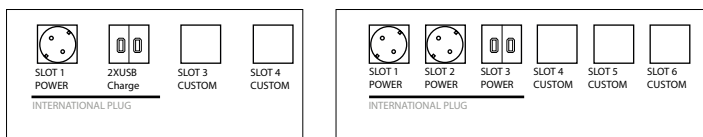

CHOOSE DATA PORT FOR DATA CUSTOM PORT SLOTS

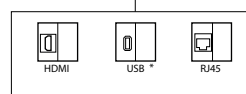

**OPTIONAL PREINSTALLED WIRING  
PREINSTALACIÓN DEL CABLEADO**

**IN0006**

Preinstalled wiring consists in the addition of the necessary mechanisms to integrate power systems in the table, so that wiring is hidden until the way out in the door. Necessary grommet are included and 3m cable (from the power system). For other cable dimensions contact the Customer Department.

La preinstalación consiste en el montaje de los mecanismos necesarios para integrar el sistema de electrificación en la mesa, de modo que el cableado quede oculto hasta su salida por la base. Se incluyen los pasacables necesarios y 3 metros de cable (midiendo desde el sistema de conexiones). Para otras longitudes de cable consultar al Departamento Comercial.

**QI CHARGING POWER BOXES  
CAJAS DE CONEXIONES QI**

The inductive charging station, allows maximum larger contact surface. Available in two finish: black or white.

La estación de carga inductiva permite una superficie de contacto máxima más grande. Disponible en dos acabados: negro o blanco.

**PS0714**

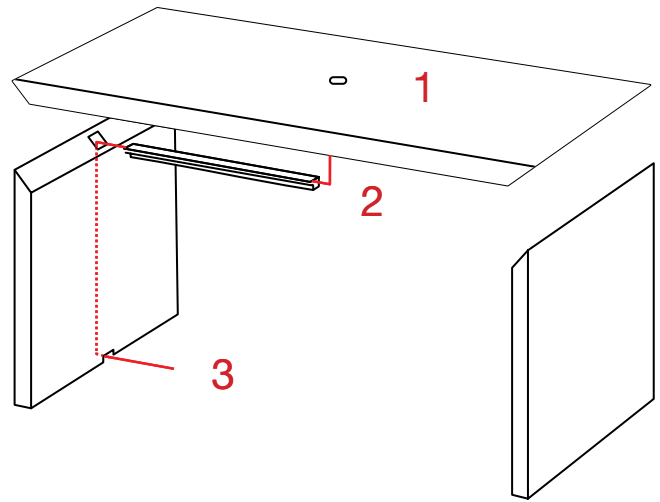
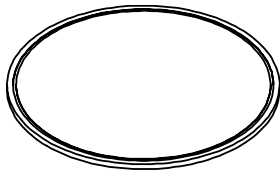

**1 POWER BOXES DISTRIBUTION DISTRIBUCIÓN DE SISTEMAS**

By standard, the position of the system will be in the central of the table, placed horizontally. When there are two system boxes, these will be separated 1/3 between them and placed horizontally. For other options, please contact the Customer Department.

De serie, la disposición del sistema será en el centro de la mesa y en sentido longitudinal. Cuando se disponga de dos sistemas, estos se colocarán con una separación de 1/3 de la longitud total de la mesa, y en sentido longitudinal. Otras opciones consultar con el Departamento Comercial.

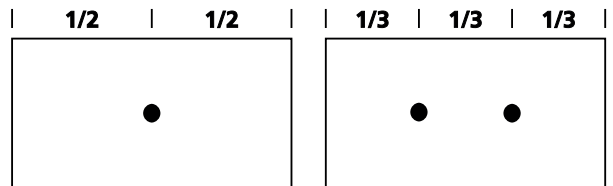

**2 WIRING MANAGEMENT GESTIÓN DEL CABLEADO**

Wire pass through an aluminum grommet keeping it hidden. By default color is silver, for other finishings ask the Customer Department.

El cable se pasa a través de un perfil pasacables de aluminio que lo mantiene oculto. Su color de serie es el plata, para otros acabados consultar al Departamento Comercial.

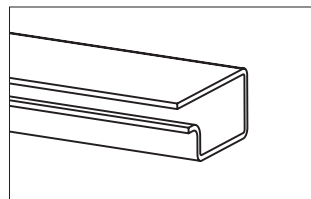

**OPTIONAL PREINSTALLED WIRING  
PREINSTALACIÓN DEL CABLEADO**

**IN0006**

Preinstalled wiring consists in the addition of the necessary mechanisms to integrate power systems in the table, so that wiring is hidden until the way out in the door. Necessary grommet are included and 3m cable (from the power system). For other cable dimensions contact the Customer Department.

La preinstalación consiste en el montaje de los mecanismos necesarios para integrar el sistema de electrificación en la mesa, de modo que el cableado quede oculto hasta su salida por la base. Se incluyen los pasacables necesarios y 3 metros de cable (midiendo desde el sistema de conexiones). Para otras longitudes de cable consultar al Departamento Comercial.

**3 CABLE WAY OUT SALIDA DE CABLEADO**

The cable way out can be performed directly from the power system or through a canal in the base bottom, so that is hidden until it gets to the floor.

La salida del cable se realiza directamente desde el propio sistema como por unas canalizaciones en la parte inferior de la base, de modo que el cable queda oculto hasta llegar al suelo.

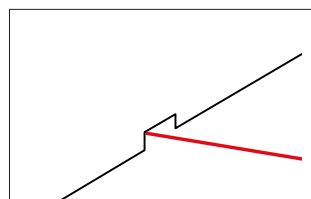









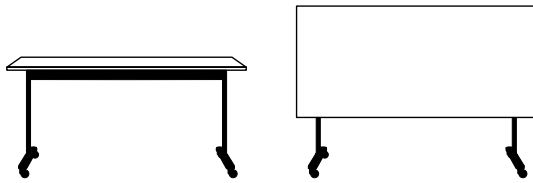

**Description**  
**Descripción**

Table program with aluminum frame and rectangular top available in oak, melamine and TP ultramatte laminate in different sizes. It is offered with two types of structure, C-shaped and T-shaped, in white, black or polished aluminum finish. Flip top version.  
Programa de mesas con estructura de aluminio y sobre rectangular disponible en roble, melamina y laminado ultramatte TP en diferentes medidas. Se ofrece con dos tipos de estructura, en forma de C y en forma de T, en acabado blanco, negro o aluminio pulido.

**Wood finish Oak**  
**Acabado madera**  
**Roble**



**Wood lacquer finish**  
**Acabado lacas madera**

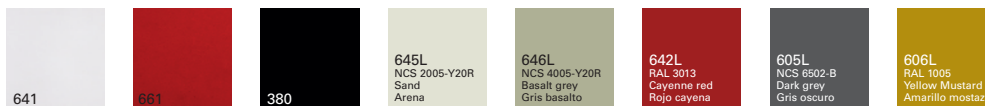

**Aluminum finish**  
**Acabado aluminio**



**Melamine finish**  
**Acabado melamina**



**Ultra-matte finish**  
**Acabado ultramatte**



**Power box**  
**Caja de conexiones**



**Intellectual property Propiedad intelectual**

All our collections are protected by international industrial design registries, designs patents, copyrights and intellectual Property laws. Unauthorized use of AW International Property is a criminal offence and can lead to prosecution.  
Todas nuestras colecciones están protegidas por registros de diseño industrial, diseño de patente, copyright y derechos de propiedad intelectual en todo el mundo. El uso no autorizado de los diseños y propiedad intelectual de AW supone un delito que puede ser sometido a acción judicial.



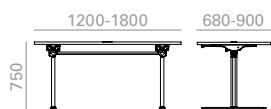

Folding system  
upcharge.  
Incremento por  
sistema abatible.

90

Top measures Medidas sobre	Table top / Sobre							
	Oak Roble		S600	Melamine Melamina		Ultra-matte TP Ultramate TP		
	Ref.	€	€	Ref.	€	Ref.	€	
<b>1200x680</b>	<b>ME2910</b>	1.051	186	<b>ME2925</b>	810	<b>ME2940</b>	1.063	
kg	33'85		33'85		33'85			
<b>2 boxes / bultos</b> m3	0,28		0,28		0,28			
<b>1200x750</b>	<b>ME2911</b>	1.104	198	<b>ME2926</b>	826	<b>ME2941</b>	1.094	
kg	36'44		36'44		36'44			
<b>2 boxes / bultos</b> m3	0,3		0,3		0,3			
<b>1200x900</b>	<b>ME2912</b>	1.149	210	<b>ME2927</b>	848	<b>ME2942</b>	1.365	
kg	40'33		40'33		40'33			
<b>2 boxes / bultos</b> m3	0,35		0,35		0,35			
<b>1500x680</b>	<b>ME2913</b>	1.173	195	<b>ME2928</b>	891	<b>ME2943</b>	1.127	
kg	40'06		40'06		40'06			
<b>2 boxes / bultos</b> m3	0,35		0,35		0,35			
<b>1500x750</b>	<b>ME2914</b>	1.211	207	<b>ME2929</b>	906	<b>ME2944</b>	1.310	
kg	43'3		43'3		43'3			
<b>2 boxes / bultos</b> m3	0,37		0,37		0,37			
<b>1500x900</b>	<b>ME2915</b>	1.317	219	<b>ME2930</b>	932	<b>ME2945</b>	1.426	
kg	48'16		48'16		48'16			
<b>2 boxes / bultos</b> m3	0,43		0,43		0,43			
<b>1800x680</b>	<b>ME2916</b>	1.326	204	<b>ME2931</b>	956	<b>ME2946</b>	1.353	
kg	46'27		46'27		46'27			
<b>2 boxes / bultos</b> m3	0,41		0,41		0,41			
<b>1800x750</b>	<b>ME2917</b>	1.365	216	<b>ME2932</b>	979	<b>ME2947</b>	1.363	
kg	50'16		50'16		50'16			
<b>2 boxes / bultos</b> m3	0,44		0,44		0,44			
<b>1800x900</b>	<b>ME2918</b>	1.423	228	<b>ME2933</b>	1.007	<b>ME2948</b>	1.829	
kg	55'99		55'99		55'99			
<b>2 boxes / bultos</b> m3	0,51		0,51		0,51			

Polished aluminum upcharge Incremento por aluminio pulido
54

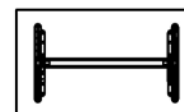

Edge legs

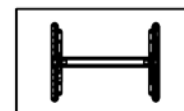

Inset legs

59
----

**Edge legs**

Legs are 152 mm from the edge of the table

Las patas están a 152 mm del borde de la mesa

67
----

**Inset legs**

Legs are 305 mm from the edge of the table

Las patas están a 305 mm del borde de la mesa

58
----

67
----

70
----

66
----

69
----

88
----

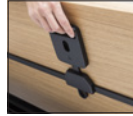
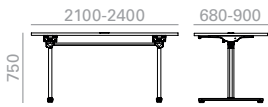

Folding system  
upcharge.  
Incremento por  
sistema abatible.

90

Top measures Medidas sobre	Table top / Sobre							
	Oak Roble		S600	Melamine Melamina		Ultra-matte TP Ultramate TP		
	Ref.	€	€	Ref.	€	Ref.	€	
<b>2100x680</b>	<b>ME2919</b>	1.401	213	<b>ME2934</b>	1.001	<b>ME2949</b>	1.494	
kg	52'48			52'48		52'48		
<b>2 boxes / bultos</b> m3	0,48			0,48		0,48		
<b>2100x750</b>	<b>ME2920</b>	1.441	225	<b>ME2935</b>	1.024	<b>ME2950</b>	1.852	
kg	57'02			57'02		57'02		
<b>2 boxes / bultos</b> m3	0,5			0,5		0,5		
<b>2100x900</b>	<b>ME2921</b>	1.497	237	<b>ME2936</b>	1.059	<b>ME2951</b>	2.079	
kg	63'82			63'82		63'82		
<b>2 boxes / bultos</b> m3	0,59			0,59		0,59		
<b>2400x680</b>	<b>ME2922</b>	1.472	222	<b>ME2937</b>	1.046	<b>ME2952</b>	1.524	
kg	56'7			56'7		56'7		
<b>2 boxes / bultos</b> m3	0,54			0,54		0,54		
<b>2400x750</b>	<b>ME2923</b>	1.494	234	<b>ME2938</b>	1.072	<b>ME2953</b>	1.881	
kg	61'88			61'88		61'88		
<b>2 boxes / bultos</b> m3	0,57			0,57		0,57		
<b>2400x900</b>	<b>ME2924</b>	1.553	246	<b>ME2939</b>	1.108	<b>ME2954</b>	2.108	
kg	69'66			69'66		69'66		
<b>2 boxes / bultos</b> m3	0,68			0,68		0,68		

Polished aluminum upcharge Incremento por aluminio pulido
74

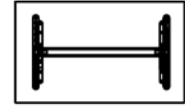

Edge legs

Edge legs

Legs are 152 mm from the edge of the table  
Las patas están a 152 mm del borde de la mesa

91
----

100
-----

76
----

93
----

101
-----



Folding system  
upcharge.  
Incremento por  
sistema abatible.

90

Top measures Medidas sobre	Table top / Sobre							
	Oak Roble		S600	Melamine Melamina		Ultra-matte TP Ultramate TP		
	Ref.	€	€	Ref.	€	Ref.	€	
<b>1200x450</b>	<b>ME3720</b>	979	168	<b>ME3735</b>	798	<b>ME3750</b>	996	
kg	28'66		28'66		28'66			
<b>2 boxes / bultos</b> m3	0,28		0,28		0,28			
<b>1200x600</b>	<b>ME3721</b>	1.035	183	<b>ME3736</b>	823	<b>ME3751</b>	1.094	
kg	32'55		32'55		32'55			
<b>2 boxes / bultos</b> m3	0,28		0,28		0,28			
<b>1200x750</b>	<b>ME3722</b>	1.095	198	<b>ME3737</b>	853	<b>ME3752</b>	1.133	
kg	36'44		36'44		36'44			
<b>2 boxes / bultos</b> m3	0,3		0,3		0,3			
<b>1500x450</b>	<b>ME3723</b>	1.087	177	<b>ME3738</b>	874	<b>ME3753</b>	1.148	
kg	33'58		33'58		33'58			
<b>2 boxes / bultos</b> m3	0,35		0,35		0,35			
<b>1500x600</b>	<b>ME3724</b>	1.156	192	<b>ME3739</b>	902	<b>ME3754</b>	1.157	
kg	38'44		38'44		38'44			
<b>2 boxes / bultos</b> m3	0,35		0,35		0,35			
<b>1500x750</b>	<b>ME3725</b>	1.200	207	<b>ME3740</b>	938	<b>ME3755</b>	1.301	
kg	43'3		43'3		43'3			
<b>2 boxes / bultos</b> m3	0,37		0,37		0,37			
<b>1800x450</b>	<b>ME3726</b>	1.220	186	<b>ME3741</b>	901	<b>ME3756</b>	1.176	
kg	38'5		38'5		38'5			
<b>2 boxes / bultos</b> m3	0,41		0,41		0,41			
<b>1800x600</b>	<b>ME3727</b>	1.250	201	<b>ME3742</b>	932	<b>ME3757</b>	1.336	
kg	44'33		44'33		44'33			
<b>2 boxes / bultos</b> m3	0,41		0,41		0,41			
<b>1800x750</b>	<b>ME3728</b>	1.355	216	<b>ME3743</b>	967	<b>ME3758</b>	1.353	
kg	50'16		50'16		50'16			
<b>2 boxes / bultos</b> m3	0,44		0,44		0,44			

Polished aluminum upcharge Incremento por aluminio pulido
53

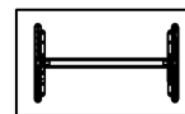

Edge legs

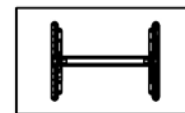

Inset legs

56
----

### Edge legs

Legs are 152 mm from the edge of the table

Las patas están a 152 mm del borde de la mesa

59
----

### Inset legs

Legs are 305 mm from the edge of the table

Las patas están a 305 mm del borde de la mesa

58
----

60
----

67
----

63
----

68
----

69
----

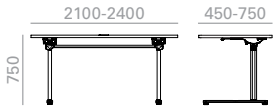

Folding system  
upcharge.  
Incremento por  
sistema abatible.

90

Top measures Medidas sobre	Table top / Sobre							
	Oak Roble		S600	Melamine Melamina		Ultra-matte TP Ultramate TP		
	Ref.	€	€	Ref.	€	Ref.	€	
<b>2100x450</b>	<b>ME3729</b>	1.264	195	<b>ME3744</b>	941	<b>ME3759</b>	1.467	
kg	43'41			43'41		43'41		
<b>2 boxes / bultos</b> m3	0,48			0,48		0,48		
<b>2100x600</b>	<b>ME3730</b>	1.323	210	<b>ME3745</b>	974	<b>ME3760</b>	1.478	
kg	50'22			50'22		50'22		
<b>2 boxes / bultos</b> m3	0,48			0,48		0,48		
<b>2100x750</b>	<b>ME3731</b>	1.304	225	<b>ME3746</b>	1.015	<b>ME3761</b>	1.843	
kg	57'02			57'02		57'02		
<b>2 boxes / bultos</b> m3	0,5			0,5		0,5		
<b>2400x450</b>	<b>ME3732</b>	1.350	204	<b>ME3747</b>	952	<b>ME3762</b>	1.497	
kg	46'33			46'33		46'33		
<b>2 boxes / bultos</b> m3	0,54			0,54		0,54		
<b>2400x600</b>	<b>ME3733</b>	1.400	219	<b>ME3748</b>	1.017	<b>ME3763</b>	1.507	
kg	54'1			54'1		54'1		
<b>2 boxes / bultos</b> m3	0,54			0,54		0,54		
<b>2400x750</b>	<b>ME3734</b>	1.487	234	<b>ME3749</b>	1.063	<b>ME3764</b>	1.870	
kg	61'88			61'88		61'88		
<b>2 boxes / bultos</b> m3	0,57			0,57		0,57		

**Polished  
aluminum  
upcharge  
Incremento por  
aluminio pulido**

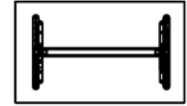

Edge legs

**Edge legs**

Legs are 152 mm from the edge of the table  
Las patas están a 152 mm del borde de la mesa

75

76

91

75

78

93

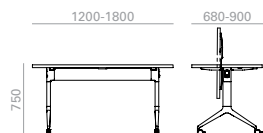

Folding system  
upcharge.  
Incremento por  
sistema abatible.

90

Top measures Medidas sobre	Table top / Sobre							
	Oak Roble		S600	Melamine Melamina		Ultra-matte TP Ultramate TP		
	Ref.	€	€	Ref.	€	Ref.	€	
1200x680	ME3810	936	186	ME3811	726	ME3812	946	
kg	33'85		33'85		33'85			
1 box / bulto  m3	0,28		0,28		0,28			
1200x750	ME3813	983	198	ME3814	741	ME3815	973	
kg	36'44		36'44		36'44			
1 box / bulto  m3	0,3		0,3		0,3			
1200x900	ME3816	1.020	210	ME3817	762	ME3818	1.208	
kg	40'33		40'33		40'33			
1 box / bulto  m3	0,35		0,35		0,35			
1500x680	ME3819	1.041	195	ME3820	798	ME3821	1.001	
kg	40'06		40'06		40'06			
1 box / bulto  m3	0,35		0,35		0,35			
1500x750	ME3822	1.075	207	ME3823	810	ME3824	1.161	
kg	43'3		43'3		43'3			
1 box / bulto  m3	0,37		0,37		0,37			
1500x900	ME3825	1.166	219	ME3826	834	ME3827	1.261	
kg	48'16		48'16		48'16			
1 box / bulto  m3	0,43		0,43		0,43			
1800x680	ME3828	1.175	204	ME3829	854	ME3830	1.198	
kg	46'27		46'27		46'27			
1 box / bulto  m3	0,41		0,41		0,41			
1800x750	ME3831	1.208	216	ME3832	872	ME3833	1.208	
kg	50'16		50'16		50'16			
1 box / bulto  m3	0,44		0,44		0,44			
1800x900	ME3834	1.259	228	ME3835	897	ME3836	1.613	
kg	55'99		55'99		55'99			
1 box / bulto  m3	0,51		0,51		0,51			

Polished aluminum upcharge Incremento por aluminio pulido
54

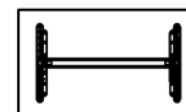

Edge legs

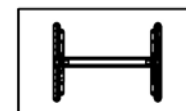

Inset legs

59
----

### Edge legs

Legs are 152 mm from the edge of the table

Las patas están a 152 mm del borde de la mesa

### Inset legs

Legs are 305 mm from the edge of the table

Las patas están a 305 mm del borde de la mesa

68
----

59
----

68
----

71
----

66
----

69
----

89
----

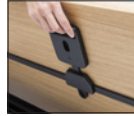
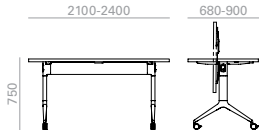

Folding system  
upcharge.  
Incremento por  
sistema abatible.

90

Top measures Medidas sobre	Table top / Sobre							
	Oak Roble		S600	Melamine Melamina		Ultra-matte TP Ultramate TP		
	Ref.	€	€	Ref.	€	Ref.	€	
<b>2100x680</b>	<b>ME3837</b>	1.238	213	<b>ME3838</b>	893	<b>ME3839</b>	1.320	
kg	52'48			52'48		52'48		
<b>1 box / bulto</b> m3	0,48			0,48		0,48		
<b>2100x750</b>	<b>ME3840</b>	1.274	225	<b>ME3841</b>	914	<b>ME3842</b>	1.632	
kg	57'02			57'02		57'02		
<b>1 box / bulto</b> m3	0,5			0,5		0,5		
<b>2100x900</b>	<b>ME3843</b>	1.323	237	<b>ME3844</b>	944	<b>ME3845</b>	1.828	
kg	63'82			63'82		63'82		
<b>1 box / bulto</b> m3	0,59			0,59		0,59		
<b>2400x680</b>	<b>ME3846</b>	1.303	237	<b>ME3847</b>	931	<b>ME3848</b>	1.345	
kg	56'71			56'71		56'71		
<b>1 box / bulto</b> m3	0,54			0,54		0,54		
<b>2400x750</b>	<b>ME3849</b>	1.320	234	<b>ME3850</b>	956	<b>ME3851</b>	1.656	
kg	61'88			61'88		61'88		
<b>1 box / bulto</b> m3	0,57			0,57		0,57		
<b>2400x900</b>	<b>ME3852</b>	1.372	246	<b>ME3853</b>	986	<b>ME3854</b>	1.854	
kg	69'66			69'66		69'66		
<b>1 box / bulto</b> m3	0,68			0,68		0,68		

Polished aluminum upcharge Incremento por aluminio pulido
74



Edge legs

**Edge legs**

Legs are 152 mm from the edge of the table  
Las patas están a 152 mm del borde de la mesa

92
----

101
-----

77
----

93
----

101
-----

Maximum table heights  
Alturas máximas de mesa

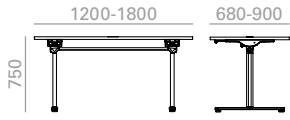
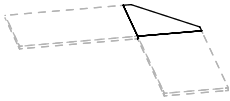

Table top / Sobre		
Oak Roble	Melamine Melamina	Ultra-matteTP UltramateTP
750	750	750





Top measures / Modesty measures Medidas sobre / medidas Modesty		Table top / Sobre		
Edge base	Inset base	Oak Roble	Melamine Melamina	Ultra-matte TP Ultramate TP
		€	€	€
1200 / 920 x 350	1200 / 620 x 350	230	145	264
1500 / 1220 x 350	1500 / 920 x 350	258	159	315
1800 - 2100 - 2400 / 1520 x 350	1800 / 1220 x 350	285	172	365



Top measures Medidas sobre	Table top / Sobre					
	Oak Roble		Melamine Melamina		Ultra-matte TP Ultramate TP	
	Ref.	€	Ref.	€	Ref.	€
450x450	SB3835	315	SB3840	244	SB3845	317
kg	6'37		5'37		5'37	
1 box / bulto  m3	0,03		0,03		0,03	
600x600	SB3836	371	SB3841	278	SB3846	373
kg	8'79		8'79		8'79	
1 box / bulto  m3	0,05		0,05		0,05	
680x680	SB3837	400	SB3842	291	SB3847	427
kg	10'15		10'15		10'15	
1 box / bulto  m3	0,06		0,06		0,06	
750x750	SB3838	444	SB3843	378	SB3848	497
kg	13'2		13'2		13'2	
1 box / bulto  m3	0,07		0,07		0,07	
900x900	SB3839	522	SB3844	458	SB3849	667
kg	18'59		18'59		18'59	
1 box / bulto  m3	0,1		0,1		0,1	

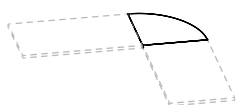

Top measures Medidas sobre	Table top / Sobre					
	Oak Roble		Melamine Melamina		Ultra-matteTP UltramateTP	
	Ref.	€	Ref.	€	Ref.	€
450x450	SB3850	315	SB3855	254	SB3860	332
kg	4'37		4'37		4'37	
1 box / bulto  m3	0,03		0,03		0,03	
600x600	SB3851	371	SB3856	290	SB3861	390
kg	7'79		7'79		7'79	
1 box / bulto  m3	0,05		0,05		0,05	
680x680	SB3852	400	SB3857	303	SB3862	427
kg	1151		10'15		10'15	
1 box / bulto  m3	0,06		0,06		0,06	
750x750	SB3853	444	SB3858	378	SB3863	487
kg	12'2		12'2		12'2	
1 box / bulto  m3	0,07		0,07		0,07	
900x900	SB3854	522	SB3859	458	SB3864	667
kg	17'59		17'59		17'59	
1 box / bulto  m3	0,1		0,1		0,1	

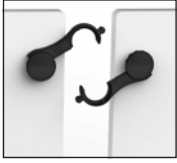

Incremento por sistema de unión  
Linking device upcharge

54

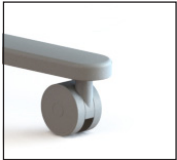

Casters upcharge  
Incremento por ruedas

108



Especial leg with wire management  
access.  
Pata especial con apertura para electri-  
ficación.

23



Viga especial con apertura para electri-  
ficación. Largo 1200 mm.

44

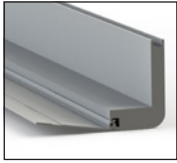

Especial beam with wire management access. Length 1500 mm.

---

53

---

Viga especial con apertura para electrificación. Largo 1500 mm.

---



Especial beam with wire management access. Length 1800-2400 mm.

---

57

---

Viga especial con apertura para electrificación. Largo 1800-2400 mm.

---

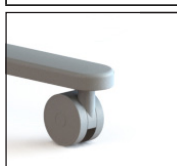
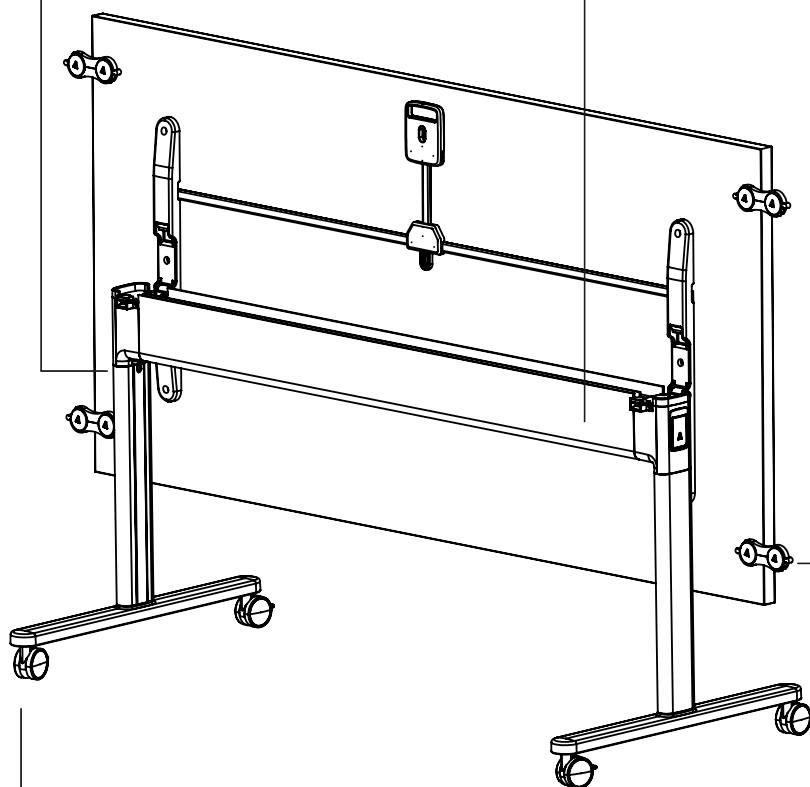
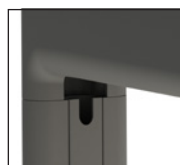

**PS-IN SURFACE /  
PS-UNDERTOP**

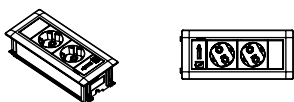

**PS0764** 231

**PS-IN SURFACE**



**PS0804** 142



**PS0806** 142

**PS-QI**



**PS0714** 243

**Preinstalled (Optional) / Preinstalación (Opcional)  
IN0006**

First installation / Primera instalación 270  
Second and more installations / Segunda y más instalaciones 90

**IN-SURFACE/UNDERTOP POWER BOXES  
CAJAS DE CONEXIONES DENTRO/BAJO DEL SOBRE**

Aluminum power box finished in black.

Caja de conexiones de aluminio en acabado negro.

**PS0764**

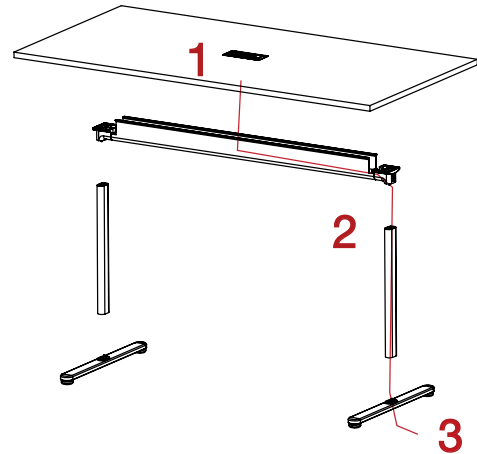
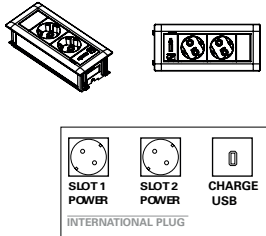

**1 POWER BOXES DISTRIBUTION DISTRIBUCIÓN DE SISTEMAS**

By standard, the position of the system will be in the central of the table, placed horizontally. When there are two system boxes, these will be separated 1/3 between them and placed horizontally. For other options, please contact the Customer Department.

De serie, la disposición del sistema será en el centro de la mesa y en sentido longitudinal. Cuando se disponga de dos sistemas, estos se colocarán con una separación de 1/3 de la longitud total de la mesa, y en sentido longitudinal. Otras opciones consultar con el Departamento Comercial.

**2 WIRING MANAGEMENT GESTIÓN DEL CABLEADO**

Wire pass through an aluminum grommet keeping it hidden. By default color is silver, for other finishings ask the Customer Department.

El cable se pasa a través de un perfil pasacables de aluminio que lo mantiene oculto. Su color de serie es el plata, para otros acabados consultar al Departamento Comercial.

**3 CABLEWAY OUT SALIDA DE CABLEADO**

The cable way out can be performed directly from the power system or through a canal in the base bottom, so that is hidden until it gets to the floor.

La salida del cable se realiza directamente desde el propio sistema como por unas canalizaciones en la parte inferior de la base, de modo que el cable queda oculto hasta llegar al suelo.

**OPTIONAL PREINSTALLED WIRING  
PREINSTALACIÓN DEL CABLEADO**

**IN0006**

Preinstalled wiring consists in the addition of the necessary mechanisms to integrate power systems in the table, so that wiring is hidden until the way out in the floor. Necessary grommet are included and 3m cable (from the power system). For other cable dimensions contact the Customer Department.

La preinstalación consiste en el montaje de los mecanismos necesarios para integrar el sistema de electrificación en la mesa, de modo que el cableado quede oculto hasta su salida por la base. Se incluyen los pasacables necesarios y 3 metros de cable (midiendo desde el sistema de conexiones). Para otras longitudes de cable consultar al Departamento Comercial.



## IN-SURFACE POWER BOXES CAJAS DE CONEXIONES DENTRO DEL SOBRE

It is a data dynamo with 2 amp dual charging USB. Available in two finishes: black or white.

Es una dínamo de datos con 2 amp de carga dual USB. Disponible en dos acabados: negro o blanco.

**PS0804**

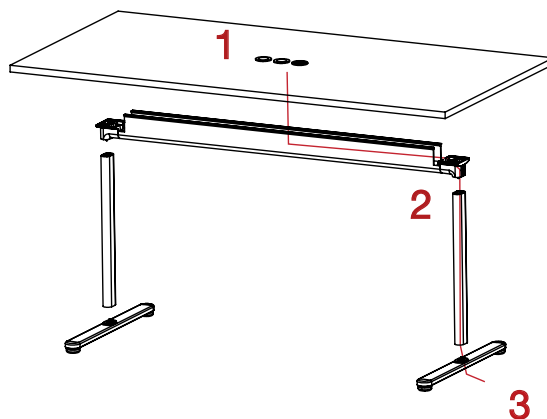
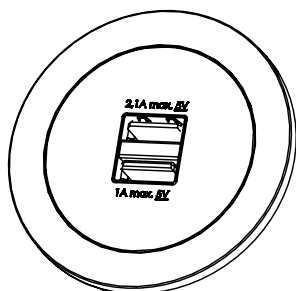

### 1 POWER BOXES DISTRIBUTION DISTRIBUCIÓN DE SISTEMAS

By standard, the position of the system will be in the central of the table, placed horizontally. When there are two system boxes, these will be separated 1/3 between them and placed horizontally. For other options, please contact the Customer Department.

De serie, la disposición del sistema será en el centro de la mesa y en sentido longitudinal. Cuando se disponga de dos sistemas, estos se colocarán con una separación de 1/3 de la longitud total de la mesa, y en sentido longitudinal. Otras opciones consultar con el Departamento Comercial.

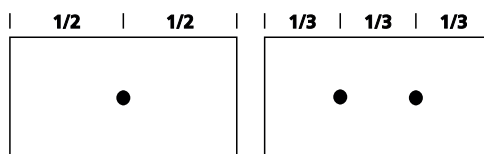

## OPTIONAL PREINSTALLED WIRING PREINSTALACIÓN DEL CABLEADO

**IN0006**

Preinstalled wiring consists in the addition of the necessary mechanisms to integrate power systems in the table, so that wiring is hidden until the way out in the floor. Necessary grommet are included and 3m cable (from the power system). For other cable dimensions contact the Customer Department.

La preinstalación consiste en el montaje de los mecanismos necesarios para integrar el sistema de electrificación en la mesa, de modo que el cableado quede oculto hasta su salida por la base. Se incluyen los pasacables necesarios y 3 metros de cable (midiendo desde el sistema de conexiones). Para otras medidas de cable consultar al Departamento Comercial. Puede preinstalarse el cableado en las mesas Extra con patas de aluminio, Delta o cuadradas de 100x100. En las patas de madera la salida del cable se sitúa en la parte central de la mesa.

The distribution of electricity is entirely configurable; the exit for the cables can be placed inside any leg (A, B, C or D). Please specify the Customer Departmente which leg is to have the cables with reference to the view of the table in the diagram b

La distribución de la electrificación es totalmente configurable; la salida de cables puede situarse en la pata que se desee (A, B, C o D). Especificar al Departamento Comercial en que pata de la mesa desea que se sitúe el cable (ver dibujo).

### 2 WIRING MANAGEMENT GESTIÓN DEL CABLEADO

Wire pass through an aluminum grommet keeping it hidden. By default color is silver, for other finishings ask the Customer Department.

El cable se pasa a través de un perfil pasacables de aluminio que lo mantiene oculto. Su color de serie es el plata, para otros acabados consultar al Departamento Comercial.

### 3 CABLEWAY OUT SALIDA DE CABLEADO

The cable way out can be performed directly from the power system or through a canal in the base bottom, so that is hidden until it gets to the floor.

La salida del cable se realiza directamente desde el propio sistema como por unas canalizaciones en la parte inferior de la base, de modo que el cable queda oculto hasta llegar al suelo.

**QI CHARGING POWER BOXES  
CAJAS DE CONEXIONES QI**

The inductive charging station, allows maximum larger contact surface. Available in two finish: black or white.

La estación de carga inductiva permite una superficie de contacto máxima más grande. Disponible en dos acabados: negro o blanco.

**PS0714**

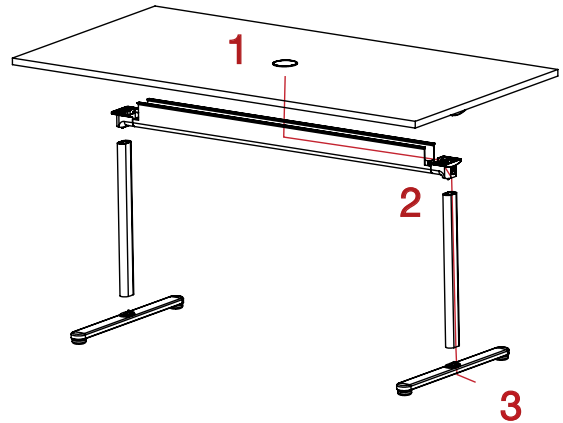
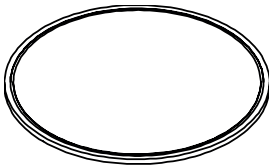

**1 POWER BOXES DISTRIBUTION DISTRIBUCIÓN DE SISTEMAS**

By standard, the position of the system will be in the central of the table, placed horizontally. When there are two system boxes, these will be separated 1/3 between them and placed horizontally. For other options, please contact the Customer Department.

En mesas con una sola base el sistema eléctrico iría instalado descentrado respecto a la base. En mesas con más de una base, por defecto la posición del sistema irá en el centro de la mesa y en sentido longitudinal. Si se solicita más de un sistema eléctrico, comunicar la posición deseada al Departamento Comercial.

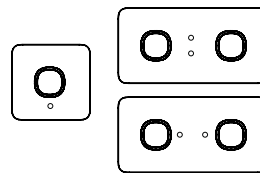

**2 WIRING MANAGEMENT GESTIÓN DEL CABLEADO**

Wire pass through an aluminum grommet keeping it hidden. By default color is silver, for other finishings ask the Customer Department.

El cable se pasa a través de un perfil pasacables de aluminio que lo mantiene oculto. Su color de serie es el plata, para otros acabados consultar al Departamento Comercial.

**OPTIONAL PREINSTALLED WIRING  
PREINSTALACIÓN DEL CABLEADO**

**IN0006**

Preinstalled wiring consists in the addition of the necessary mechanisms to integrate power systems in the table, so that wiring is hidden until the way out in the floor. Necessary grommet are included and 3m cable (from the power system). For other cable dimensions contact the Customer Department.

La preinstalación consiste en el montaje de los mecanismos necesarios para integrar el sistema de electrificación en la mesa, de modo que el cableado quede oculto hasta su salida por la base. Se incluyen los pasacables necesarios y 3 metros de cable (midiéndolo desde el sistema de conexiones). Por cada base por al que se desee bajar el cable se solicita un IN0006 al Departamento Comercial.

**3 CABLE WAY OUT SALIDA DE CABLEADO**

The cable way out can be performed directly from the power system or through a canal in the base bottom, so that is hidden until it gets to the floor.

La salida del cable se realiza directamente desde el propio sistema como por unas canalizaciones en la parte inferior de la base, de modo que el cable queda oculto hasta llegar al suelo.





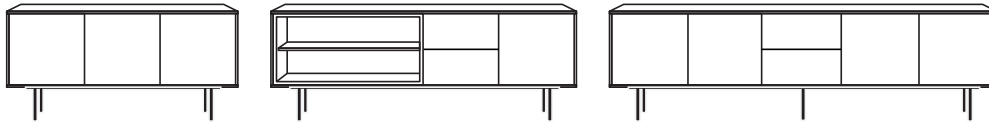

**Description**  
**Descripción**

Wooden sideboards available in different sizes and finishes. Base with steel legs and black finish, with the option of polished chrome finish. This collection, in addition to the door and drawer modules, includes an open module with shelf in smoked glass finish.  
Aparadores de madera disponibles en diferentes medidas y acabados. Base de patas de acero y acabado negro, con opción de acabado cromo brillo. Esta colección, además de los módulos de puertas y cajones, incluye un módulo diáfano con balda en acabado cristal fumé.

**Wood finish Oak**  
**Acabado madera**  
**Roble**



**Wood lacquer finish**  
**Acabado lacas madera**



**Wood finish Walnut**  
**Acabado madera**  
**Nogal**

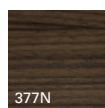

**Technical Stone 8 finish**  
**Acabado Technical**  
**Stone 8**

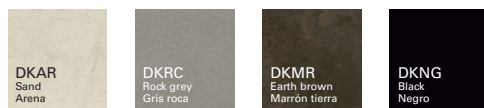

**Glass finish**  
**Acabado de cristal**



**M1 marble finish**  
**Acabado de mármol**  
**M1**

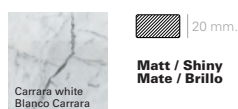

**M3 marble finish**  
**Acabado de mármol**  
**M3**

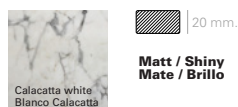

**Intellectual property Propiedad intelectual**

All our collections are protected by international industrial design registries, designs patents, copyrights and intellectual Property laws. Unauthorized use of AW International Property is a criminal offence and can lead to prosecution.  
Todas nuestras colecciones están protegidas por registros de diseño industrial, diseño de patente, copyright y derechos de propiedad intelectual en todo el mundo. El uso no autorizado de los diseños y propiedad intelectual de AW supone un delito que puede ser sometido a acción judicial.



CONFIGURATION DIAGRAM  
CONFIGURACIÓN DIAGRAMA

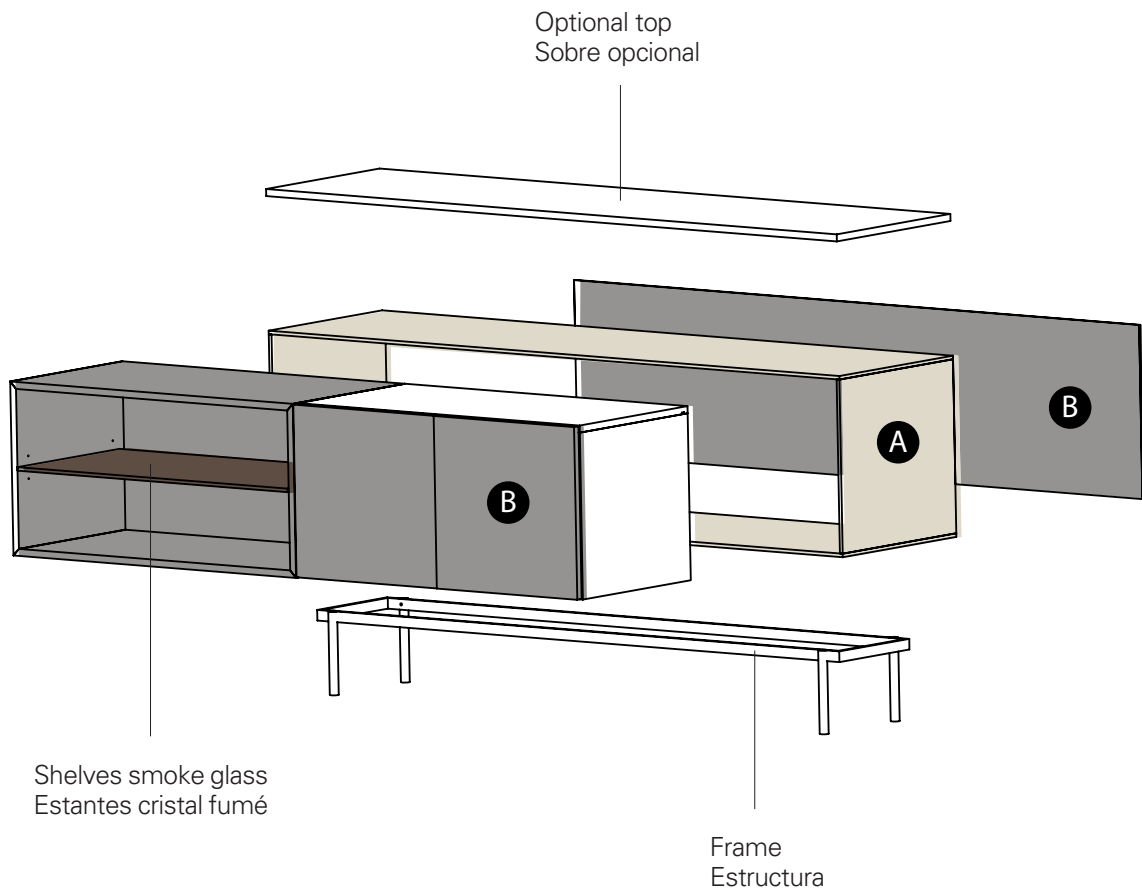



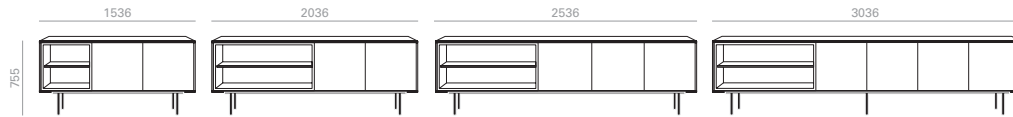





- A** Exterior material / Material exterior
- B** Front and back material / Material frontal y posterior



Top measures Medidas sobre	Exterior material Material exterior			Front and back material / Material frontal y posterior							
				Oak Roble		Walnut Nogal		Lacquered Lacado			
	€	Ref.	€	Ref.	€	Ref.	€	Ref.			
1536x530x755	Oak Roble	S600	108	AP04800	3.342	AP04801	3.571	AP04802	2.846		
	<b>kg</b>			148'9		148'9		148'9			
	<b>3 boxes / bultos</b>	<b>m3</b>		1,09		1,09		1,09			
2036x530x755	Oak Roble	S600	168	AP04836	3.916	AP04837	4.147	AP04838	3.147		
	<b>kg</b>			166'5		166'5		166'5			
	<b>5 boxes / bultos</b>	<b>m3</b>		1,25		1,25		1,25			
2536x530x755	Oak Roble	S600	228	AP04872	4.300	AP04873	4.523	AP04874	3.523		
	<b>kg</b>			181'7		181'7		181'7			
	<b>5 boxes / bultos</b>	<b>m3</b>		1,57		1,57		1,57			
3036x530x755	Oak Roble	S600	288	AP04908	5.138	AP04909	5.409	AP04910	4.336		
	<b>kg</b>			208'9		208'9		208'9			
	<b>6 boxes / bultos</b>	<b>m3</b>		1,82		1,82		1,82			
1536x530x755	Walnut Nogal			AP04803	3.383	AP04804	3.615	AP04805	2.882		
	<b>kg</b>			148'9		148'9		148'9			
	<b>3 boxes / bultos</b>	<b>m3</b>		1,09		1,09		1,09			
2036x530x755	Walnut Nogal			AP04839	4.003	AP04840	4.237	AP04841	3.231		
	<b>kg</b>			166'5		166'5		166'5			
	<b>5 boxes / bultos</b>	<b>m3</b>		1,25		1,25		1,25			
2536x530x755	Walnut Nogal			AP04875	4.584	AP04876	4.836	AP04877	3.793		
	<b>kg</b>			181'7		181'7		181'7			
	<b>5 boxes / bultos</b>	<b>m3</b>		1,57		1,57		1,57			
3036x530x755	Walnut Nogal			AP04911	5.430	AP04912	5.733	AP04913	4.614		
	<b>kg</b>			208'9		208'9		208'9			
	<b>6 boxes / bultos</b>	<b>m3</b>		1,82		1,82		1,82			
1536x530x755	Lacquered Lacado			AP04806	3.211	AP04807	3.423	AP04808	2.718		
	<b>kg</b>			148'9		148'9		148'9			
	<b>3 boxes / bultos</b>	<b>m3</b>		1,09		1,09		1,09			
2036x530x755	Lacquered Lacado			AP04842	3.550	AP04843	3.743	AP04844	2.799		
	<b>kg</b>			166'5		166'5		166'5			
	<b>5 boxes / bultos</b>	<b>m3</b>		1,25		1,25		1,25			
2536x530x755	Lacquered Lacado			AP04878	4.038	AP04879	4.235	AP04880	3.275		
	<b>kg</b>			181'7		181'7		181'7			
	<b>5 boxes / bultos</b>	<b>m3</b>		1,57		1,57		1,57			
3036x530x755	Lacquered Lacado			AP04914	4.853	AP04915	5.100	AP04916	4.066		
	<b>kg</b>			208'9		208'9		208'9			
	<b>6 boxes / bultos</b>	<b>m3</b>		1,82		1,82		1,82			



- Polished Chrome upcharge  
1536x530x755  
Incremento cromo brillo | 165 |
- Polished Chrome upcharge  
2036x530x755  
Incremento cromo brillo | 276 |
- Polished Chrome upcharge  
2536x530x755  
Incremento cromo brillo | 387 |
- Polished Chrome upcharge  
3036x530x755  
Incremento cromo brillo | 525 |

Optional table tops /Sobres opcionales				
Top measures Medidas Sobres	Technical Stone 8	Low Iron Glass Cristal óptico	Marble M1 Mármol M1	Marble M3 Mármol M3
	€	€	€	€
<b>1520x530x766</b>	844	750	668	1.322
 kg	49.5	56.9	69.5	69.5
 m3	0.51	0.51	0.51	0.51
<b>2020x530x766</b>	1.035	842	889	1.622
 kg	67.5	69.4	76	76
 m3	0.59	0.59	0.59	0.59
<b>2520x530x766</b>	1.240	995	1.110	2.027
 kg	74.8	74.6	98.4	98.4
 m3	0.72	0.72	0.72	0.72
<b>3020x530x766</b>	1.397	1.133	1.363	2.369
 kg	81.2	89.7	106.3	106.3
 m3	0.91	0.91	0.91	0.91

\*\*\*Marble shiny  
upcharge  
Incremento por  
mármol brillo

| 30 |



CONFIGURATION DIAGRAM  
CONFIGURACIÓN DIAGRAMA

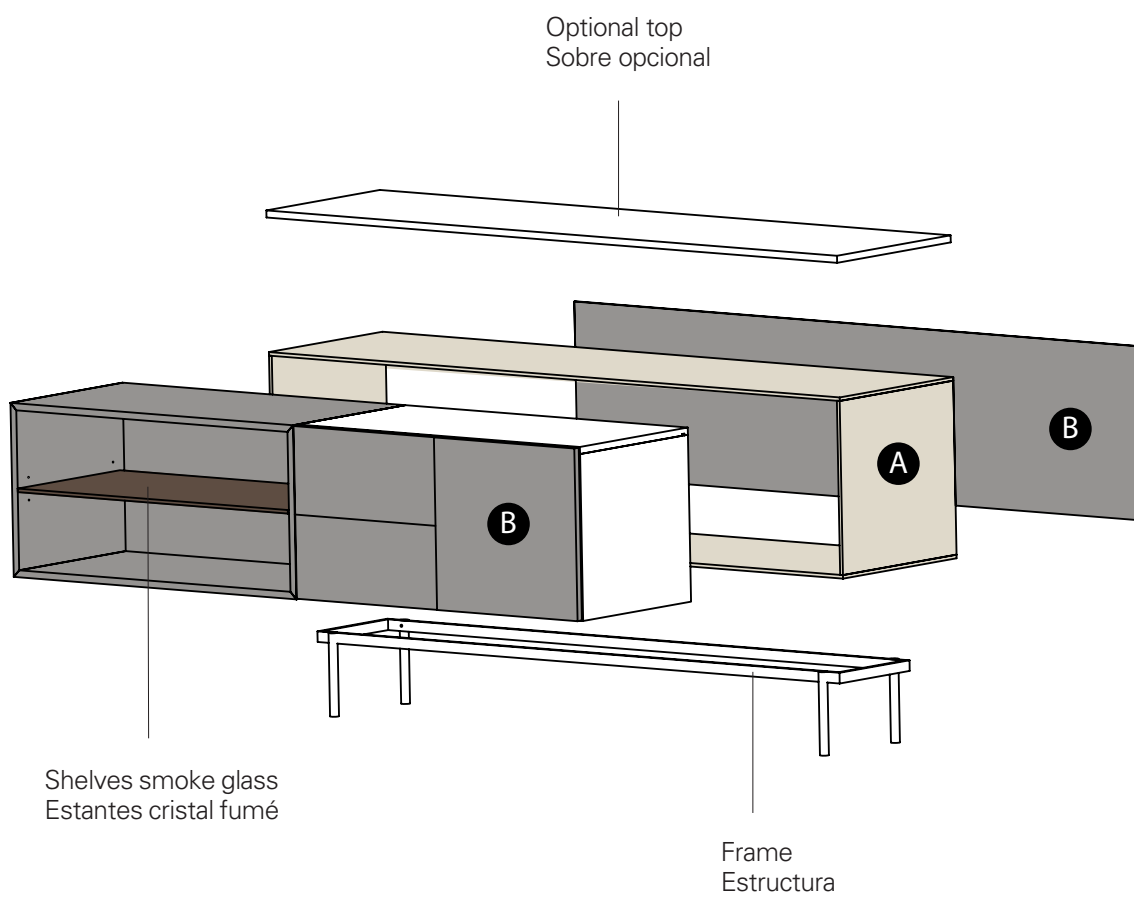

- A** Exterior material / Material exterior
- B** Front and back material / Material frontal y posterior

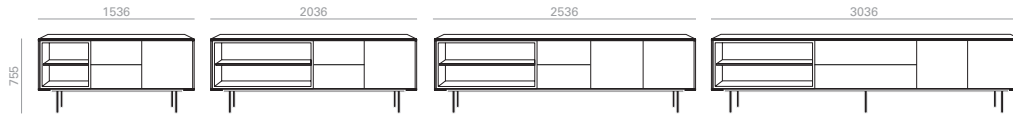

Top measures Medidas sobre	Exterior material Material exterior			Front and back material / Material frontal y posterior					
				Oak Roble		Walnut Nogal		Lacquered Lacado	
	€	Ref.	€	Ref.	€	Ref.	€	Ref.	
1536x530x755	Oak Roble	S600	108	AP04809	4.329	AP04810	4.557	AP04811	3.831
	kg				148'9		148'9		148'9
	<b>3 boxes / bultos</b>	m3			1,09		1,09		1,09
2036x530x755	Oak Roble	S600	168	AP04845	4.904	AP04846	5.131	AP04847	4.134
	kg				166'5		166'5		166'5
	<b>5 boxes / bultos</b>	m3			1,25		1,25		1,25
2536x530x755	Oak Roble	S600	228	AP04881	5.286	AP04882	5.508	AP04883	4.510
	kg				181'7		181'7		181'7
	<b>5 boxes / bultos</b>	m3			1,57		1,57		1,57
3036x530x755	Oak Roble	S600	288	AP04917	6.247	AP04918	6.520	AP04919	5.444
	kg				208'9		208'9		208'9
	<b>6 boxes / bultos</b>	m3			1,82		1,82		1,82
1536x530x755	Walnut Nogal			AP04812	4.367	AP04813	4.599	AP04814	3.866
	kg				148'9		148'9		148'9
	<b>3 boxes / bultos</b>	m3			1,09		1,09		1,09
2036x530x755	Walnut Nogal			AP04848	4.986	AP04849	5.223	AP04850	4.216
	kg				166'5		166'5		166'5
	<b>5 boxes / bultos</b>	m3			1,25		1,25		1,25
2536x530x755	Walnut Nogal			AP04884	5.571	AP04885	5.820	AP04886	4.780
	kg				181'7		181'7		181'7
	<b>5 boxes / bultos</b>	m3			1,57		1,57		1,57
3036x530x755	Walnut Nogal			AP04920	6.538	AP04921	6.841	AP04922	5.721
	kg				208'9		208'9		208'9
	<b>6 boxes / bultos</b>	m3			1,82		1,82		1,82
1536x530x755	Lacquered Lacado			AP04815	4.193	AP04816	4.408	AP04817	3.702
	kg				148'9		148'9		148'9
	<b>3 boxes / bultos</b>	m3			1,09		1,09		1,09
2036x530x755	Lacquered Lacado			AP04851	4.536	AP04852	4.728	AP04853	3.787
	kg				166'5		166'5		166'5
	<b>5 boxes / bultos</b>	m3			1,25		1,25		1,25
2536x530x755	Lacquered Lacado			AP04887	5.025	AP04888	5.221	AP04889	4.263
	kg				181'7		181'7		181'7
	<b>5 boxes / bultos</b>	m3			1,57		1,57		1,57
3036x530x755	Lacquered Lacado			AP04923	5.962	AP04924	6.208	AP04925	5.175
	kg				208'9		208'9		208'9
	<b>6 boxes / bultos</b>	m3			1,82		1,82		1,82



Polished Chrome upcharge  
1536x530x755  
Incremento cromo brillo

| 165 |

Polished Chrome upcharge  
2036x530x755  
Incremento cromo brillo









| 276 |

Polished Chrome upcharge  
2536x530x755  
Incremento cromo brillo

| 387 |

Polished Chrome upcharge  
3036x530x755  
Incremento cromo brillo

| 525 |

Optional table tops /Sobres opcionales				
Top measures Medidas Sobres	Technical Stone 8	Low Iron Glass Cristal óptico	Marble M1 Mármol M1	Marble M3 Mármol M3
	€	€	€	€
<b>1520x530x766</b>	844	750	668	1.322
 kg	49.5	56.9	69.5	69.5
 m3	0.51	0.51	0.51	0.51
<b>2020x530x766</b>	1.035	842	889	1.622
 kg	67.5	69.4	76	76
 m3	0.59	0.59	0.59	0.59
<b>2520x530x766</b>	1.240	995	1.110	2.027
 kg	74.8	74.6	98.4	98.4
 m3	0.72	0.72	0.72	0.72
<b>3020x530x766</b>	1.397	1.133	1.363	2.369
 kg	81.2	89.7	106.3	106.3
 m3	0.91	0.91	0.91	0.91

\*\*\*Marble shiny  
upcharge  
Incremento por  
mármol brillo

CONFIGURATION DIAGRAM  
CONFIGURACIÓN DIAGRAMA

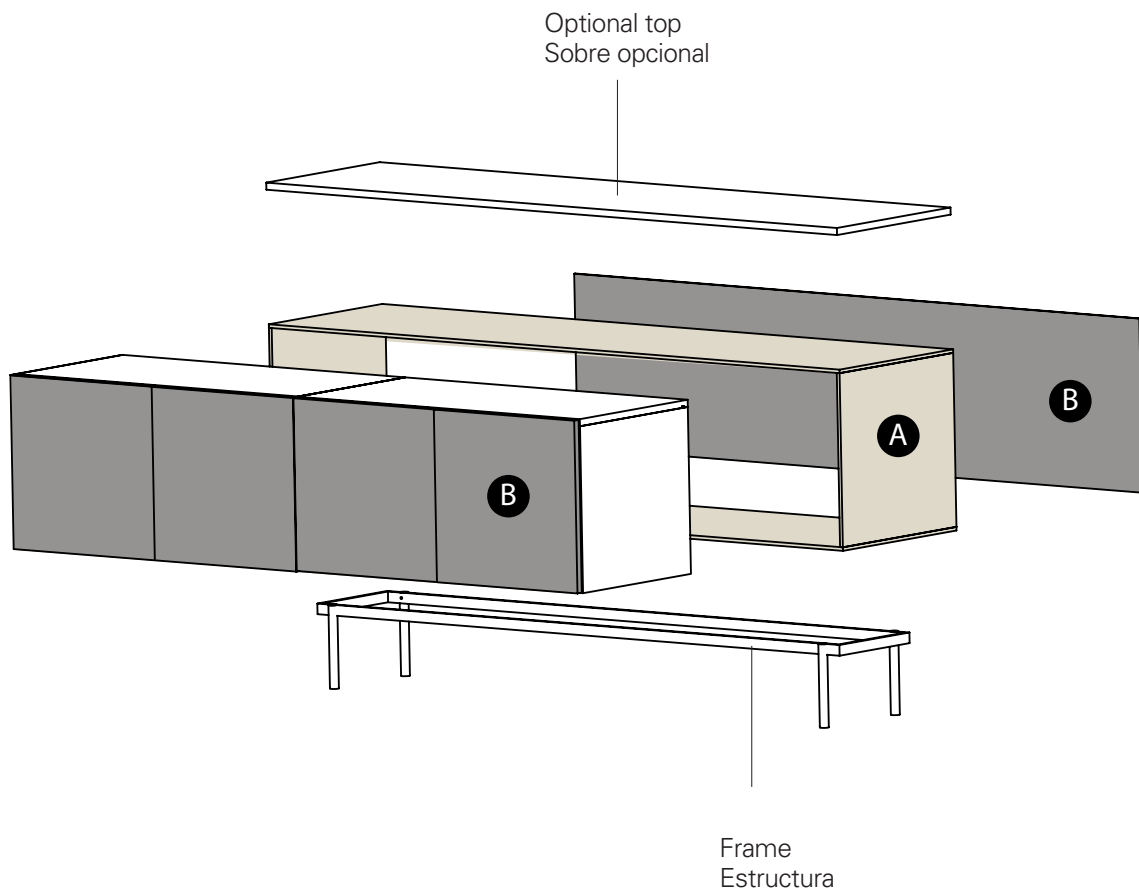









- A** Exterior material / Material exterior
- B** Front and back material / Material frontal y posterior



Top measures Medidas sobre	Exterior material Material exterior			Front and back material / Material frontal y posterior							
				Oak Roble		Walnut Nogal		Lacquered Lacado			
	€	Ref.	€	Ref.	€	Ref.	€	Ref.			
1536x530x755	Oak Roble	S600	168	AP04818	2.612	AP04819	2.770	AP04820	2.532		
	kg			148'9		148'9		148'9			
	2 boxes / bultos			1,09		1,09		1,09			
2036x530x755	Oak Roble	S600	168	AP04854	3.544	AP04855	3.749	AP04856	3.440		
	kg			166'5		166'5		166'5			
	4 boxes / bultos			1,25		1,25		1,25			
2536x530x755	Oak Roble	S600	288	AP04890	3.929	AP04891	4.148	AP04892	3.816		
	kg			181'7		181'7		181'7			
	4 boxes / bultos			1,57		1,57		1,57			
3036x530x755	Oak Roble	S600	348	AP04926	4.765	AP04927	5.036	AP04928	4.628		
	kg			208'9		208'9		208'9			
	5 boxes / bultos			1,82		1,82		1,82			
1536x530x755	Walnut Nogal			AP04821	2.649	AP04822	2.812	AP04823	2.570		
	kg			148'9		148'9		148'9			
	2 boxes / bultos			1,09		1,09		1,09			
2036x530x755	Walnut Nogal			AP04857	3.628	AP04858	3.843	AP04859	3.522		
	kg			166'5		166'5		166'5			
	4 boxes / bultos			1,25		1,25		1,25			
2536x530x755	Walnut Nogal			AP04893	4.212	AP04894	4.463	AP04895	4.085		
	kg			181'7		181'7		181'7			
	4 boxes / bultos			1,57		1,57		1,57			
3036x530x755	Walnut Nogal			AP04929	5.057	AP04930	5.360	AP04931	4.905		
	kg			208'9		208'9		208'9			
	5 boxes / bultos			1,82		1,82		1,82			
1536x530x755	Lacquered Lacado			AP04824	2.478	AP04825	2.622	AP04826	2.405		
	kg			148'9		148'9		148'9			
	2 boxes / bultos			1,09		1,09		1,09			
2036x530x755	Lacquered Lacado			AP04860	3.177	AP04861	3.346	AP04862	3.091		
	kg			166'5		166'5		166'5			
	4 boxes / bultos			1,25		1,25		1,25			
2536x530x755	Lacquered Lacado			AP04896	3.666	AP04897	3.862	AP04898	3.569		
	kg			181'7		181'7		181'7			
	4 boxes / bultos			1,57		1,57		1,57			
3036x530x755	Lacquered Lacado			AP04932	4.391	AP04933	4.637	AP04934	4.269		
	kg			208'9		208'9		208'9			
	5 boxes / bultos			1,82		1,82		1,82			



- Polished Chrome upcharge  
1536x530x755  
Incremento cromo brillo | 165 |
- Polished Chrome upcharge  
2036x530x755  
Incremento cromo brillo | 276 |
- Polished Chrome upcharge  
2536x530x755  
Incremento cromo brillo | 387 |
- Polished Chrome upcharge  
3036x530x755  
Incremento cromo brillo | 525 |

Optional table tops /Sobres opcionales				
Top measures Medidas Sobres	Technical Stone 8	Low Iron Glass Cristal óptico	Marble M1 Mármol M1	Marble M3 Mármol M3
	€	€	€	€
<b>1520x530x766</b>	844	750	668	1.322
 kg	49.5	56.9	69.5	69.5
 m3	0.51	0.51	0.51	0.51
<b>2020x530x766</b>	1.035	842	889	1.622
 kg	67.5	69.4	76	76
 m3	0.59	0.59	0.59	0.59
<b>2520x530x766</b>	1.240	995	1.110	2.027
 kg	74.8	74.6	98.4	98.4
 m3	0.72	0.72	0.72	0.72
<b>3020x530x766</b>	1.397	1.133	1.363	2.369
 kg	81.2	89.7	106.3	106.3
 m3	0.91	0.91	0.91	0.91

\*\*\*Marble shiny  
upcharge  
Incremento por  
mármol brillo

CONFIGURATION DIAGRAM  
CONFIGURACIÓN DIAGRAMA

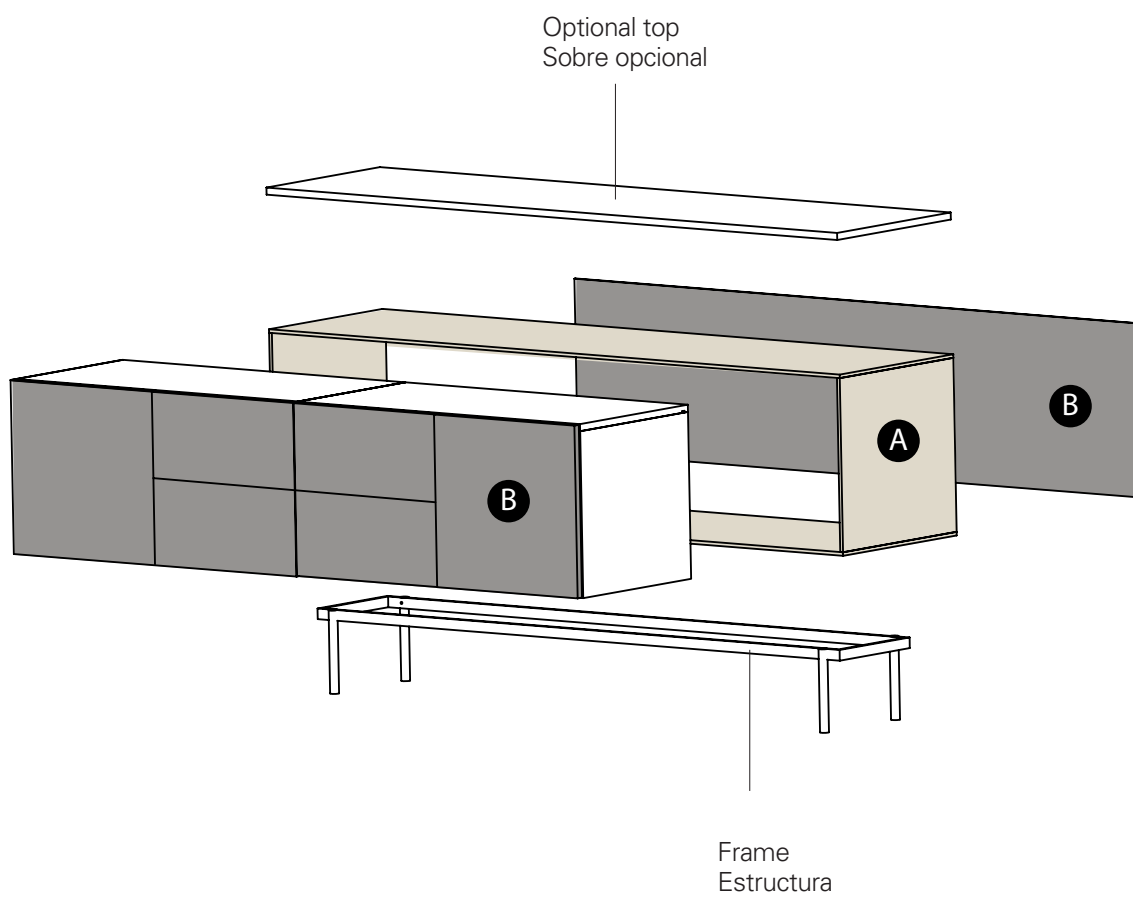

- A** Exterior material / Material exterior
- B** Front and back material / Material frontal y posterior

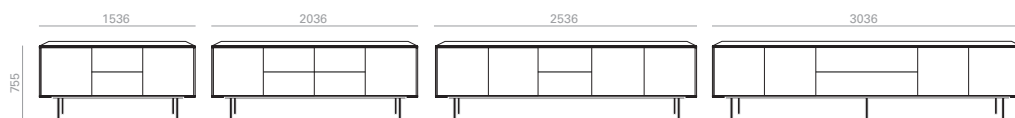

Top measures Medidas sobre	Exterior material Material exterior			Front and back material / Material frontal y posterior					
				Oak Roble		Walnut Nogal		Lacquered Lacado	
	€	Ref.	€	Ref.	€	Ref.	€	Ref.	
1536x530x755	Oak Roble	S600	108	AP04827	3.628	AP04828	3.788	AP04829	3.550
	kg			148'9		148'9		148'9	
	2 boxes / bultos	m3		1,09		1,09		1,09	
2036x530x755	Oak Roble	S600	168	AP04863	5.316	AP04864	5.521	AP04865	5.213
	kg			166'5		166'5		166'5	
	4 boxes / bultos	m3		1,25		1,25		1,25	
2536x530x755	Oak Roble	S600	288	AP04899	6.155	AP04900	6.403	AP04901	5.976
	kg			181'7		181'7		181'7	
	4 boxes / bultos	m3		1,57		1,57		1,57	
3036x530x755	Oak Roble	S600	348	AP04935	6.253	AP04936	6.530	AP04937	6.120
	kg			208'9		208'9		208'9	
	5 boxes / bultos	m3		1,82		1,82		1,82	
1536x530x755	Walnut Nogal			AP04830	3.669	AP04831	3.831	AP04832	3.588
	kg			148'9		148'9		148'9	
	2 boxes / bultos	m3		1,09		1,09		1,09	
2036x530x755	Walnut Nogal			AP04866	5.402	AP04867	5.615	AP04868	5.292
	kg			166'5		166'5		166'5	
	4 boxes / bultos	m3		1,25		1,25		1,25	
2536x530x755	Walnut Nogal			AP04902	6.257	AP04903	6.514	AP04904	6.070
	kg			181'7		181'7		181'7	
	4 boxes / bultos	m3		1,57		1,57		1,57	
3036x530x755	Walnut Nogal			AP04938	6.547	AP04939	6.848	AP04940	6.396
	kg			208'9		208'9		208'9	
	5 boxes / bultos	m3		1,82		1,82		1,82	
1536x530x755	Lacquered Lacado			AP04833	3.497	AP04834	3.643	AP04835	3.423
	kg			148'9		148'9		148'9	
	2 boxes / bultos	m3		1,09		1,09		1,09	
2036x530x755	Lacquered Lacado			AP04869	4.949	AP04870	5.119	AP04871	4.863
	kg			166'5		166'5		166'5	
	4 boxes / bultos	m3		1,25		1,25		1,25	
2536x530x755	Lacquered Lacado			AP04905	5.741	AP04906	5.947	AP04907	5.584
	kg			181'7		181'7		181'7	
	4 boxes / bultos	m3		1,57		1,57		1,57	
3036x530x755	Lacquered Lacado			AP04941	5.974	AP04942	6.215	AP04943	5.849
	kg			208'9		208'9		208'9	
	5 boxes / bultos	m3		1,82		1,82		1,82	



Polished Chrome upcharge  
1536x530x755  
Incremento cromo brillo

| 165 |

Polished Chrome upcharge  
2036x530x755  
Incremento cromo brillo

| 276 |









Polished Chrome upcharge  
2536x530x755  
Incremento cromo brillo

| 387 |

Polished Chrome upcharge  
3036x530x755  
Incremento cromo brillo

| 525 |



Optional table tops /Sobres opcionales				
Top measures Medidas Sobres	Technical Stone 8	Low Iron Glass Cristal óptico	Marble M1 Mármol M1	Marble M3 Mármol M3
	€	€	€	€
<b>1520x530x766</b>	844	750	668	1.322
 kg	49.5	56.9	69.5	69.5
 m3	0.51	0.51	0.51	0.51
<b>2020x530x766</b>	1.035	842	889	1.622
 kg	67.5	69.4	76	76
 m3	0.59	0.59	0.59	0.59
<b>2520x530x766</b>	1.240	995	1.110	2.027
 kg	74.8	74.6	98.4	98.4
 m3	0.72	0.72	0.72	0.72
<b>3020x530x766</b>	1.397	1.133	1.363	2.369
 kg	81.2	89.7	106.3	106.3
 m3	0.91	0.91	0.91	0.91

\*\*\*Marble shiny  
upcharge  
Incremento por  
mármol brillo

| 30 |

Maximum table heights  
 Alturas máximas de mesa

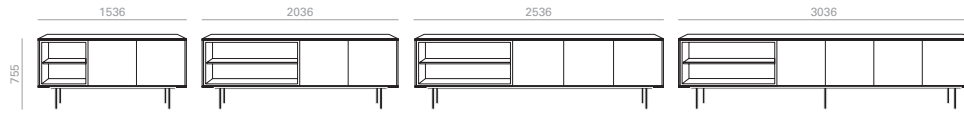

Front and back material		
Oak Roble	Walnut Nogal	Lacquered Lacado
766	766	766



**Description**  
**Descripción**

Table program available with different types of bases and table tops. Bases of 4 aluminum legs, with square or delta shape, available in anodized brown, anodized silver, matte white and matte black, or 4 oak legs, with square form and available in 2 size

Programa de mesas disponible con diferentes tipos de bases y sobres de mesa. Bases de 4 patas de aluminio, con forma cuadrada o delta, disponibles en acabado anodizado marrón, anodizado plata, blanco mate y negro mate, o de 4 patas de madera maciza de roble

**Wood finish Oak**  
**Acabado madera Roble**



**Wood lacquer finish**  
**Acabado lacas madera**



**Laminated**  
**Laminado**

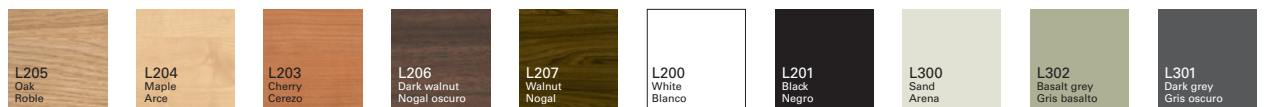

**Compacto HPL finish**  
**Acabado Compacto HPL**

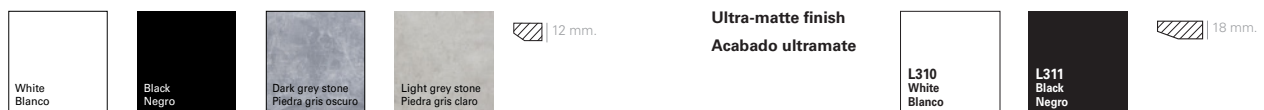

**Linoleum finish**  
**Acabado linóleo**



**M1 marble finish**  
**Acabado de mármol M1**

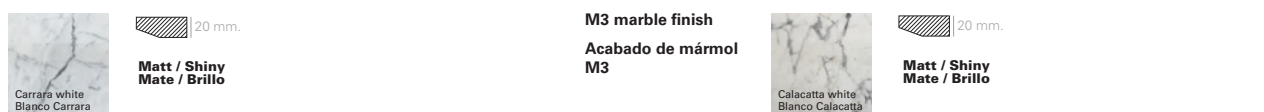

**Aluminum finish**  
**Acabado aluminio**



**Glass finish**  
**Acabado de cristal**

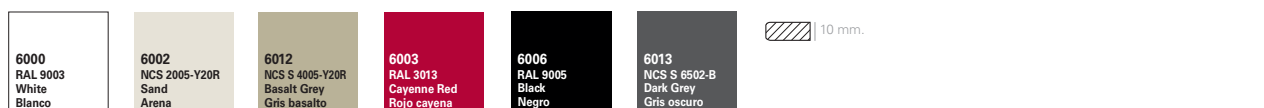

**Legs**  
**Patatas**

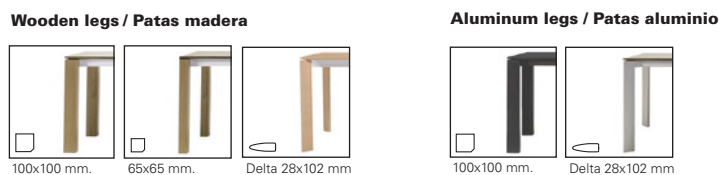

**Certificates**  
**Certificados**

Quality - Resistance  
Calidad - Resistencia

UNE EN 15372

**Intellectual property Propiedad intelectual**

All our collections are protected by international industrial design registries, designs patents, copyrights and intellectual Property laws. Unauthorized use of AW International Property is a criminal offence and can lead to prosecution.

Todas nuestras colecciones están protegidas por registros de diseño industrial, diseño de patente, copyright y derechos de propiedad intelectual todo el mundo. El uso no autorizado de los diseños y propiedad intelectual de AW supone un delito que puede ser sometido a acción judicial.



1400 x 900

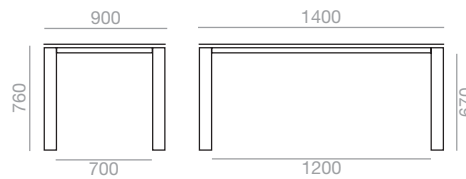

\*\*\*Marble shiny upcharge  
Incremento por mármol brillo

30



\*Matte lacquered and premium upcharge  
\*Incremento por lacado mate y premium

195

Legs Patas	Table top / Sobre									
	*Oak Roble		Lacquered Lacado		Low Iron Glass Cristal óptico		Technical Stone Technical Stone		Compacto HPL Compacto HPL	
	Ref.	€	Ref.	€	Ref.	€	Ref.	€	Ref.	€
Oak 100 x 100 Roble 100 x 100	ME8000	2.241	ME8005	2.202	ME8015	3.450	ME8020	2.538	ME8025	2.263
kg	52		52		68		53		54	
2 boxes / bultos  m3	0.39		0.39		1.04		1.04		0.39	
Oak 65 x 65 Roble 65 x 65	ME8001	2.221	ME8006	2.112	ME8016	2.970	ME8021	2.244	ME8026	2.187
kg	52		52		68		53		54	
2 boxes / bultos  m3	0.32		0.32		1.01		1.01		0.32	
Aluminum 100 x 100 Aluminio 100 x 100	ME8002	2.074	ME8007	2.069	ME8017	2.886	ME8022	2.221	ME8027	2.144
kg	52		52		68		53		54	
2 boxes / bultos  m3	0.39		0.39		1.04		1.04		0.39	
Delta Aluminum Aluminio Delta	ME8003	1.938	ME8008	1.931	ME8018	2.794	ME8023	3.122	ME8028	2.007
kg	48		48		68		49		50	
2 boxes / bultos  m3	0.32		0.32		0.96		0.96		0.32	
Delta Oak Roble Delta	ME9500	2.242	ME9501	2.235	ME9503	3.121	ME9504	2.411	ME9505	2.315
kg	49		49		66		50		51	
2 boxes / bultos  m3	0.26		0.26		0.96		0.96		0.26	

Legs Patas	Table top / Sobre									
	Laminate Laminado		***M3 Marble Mármol M3		***M1 Marble Mármol M1		Ultra-matte Ultramate		Linoleum Linóleo	
	Ref.	€	Ref.	€	Ref.	€	Ref.	€	Ref.	€
Oak 100 x 100 Roble 100 x 100	ME8030	2.416	ME8830	4.881	ME8905	4.078	ME7670	2.375	ME7729	2.464
kg	52		102		102		49		49	
2 boxes / bultos  m3	0.39		1.84		1.76		0.39		0.39	
Oak 65 x 65 Roble 65 x 65	ME8031	2.356	ME8831	4.539	ME8906	3.261	ME7671	2.218	ME7730	2.386
kg	52		102		102		49		49	
2 boxes / bultos  m3	0.32		1.81		1.76		0.32		0.32	
Aluminum 100 x 100 Aluminio 100 x 100	ME8032	2.342	ME8832	4.553	ME8907	3.050	ME7672	2.424	ME7731	2.439
kg	52		102		102		49		49	
2 boxes / bultos  m3	0.39		1.84		1.76		0.39		0.39	
Delta Aluminum Aluminio Delta	ME8033	2.187	ME8833	5.622	ME8908	4.301	ME7673	2.301	ME7732	2.315
kg	48		102		102		49		49	
2 boxes / bultos  m3	0.32		1.76		0.96		0.32		0.32	
Delta Oak Roble Delta	ME9506	2.505	ME9507	4.592	ME9508	3.064	ME9509	2.605	ME9510	2.623
kg	49		75		75		49		48.5	
2 boxes / bultos  m3	0.26		1.76		1.76		0.26		0.26	

1600 x 900

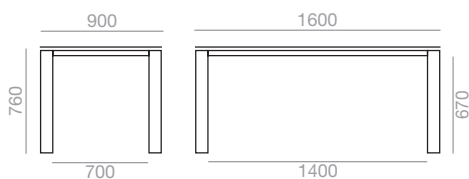

SERIE 600

\*\*\*Marble shiny upcharge  
Incremento por mármol brillo

30

\*Matte lacquered and premium upcharge

\*Incremento por lacado mate y premium

209

Legs Patas	Table top / Sobre									
	*Oak Roble		Lacquered Lacado		Low Iron Glass Cristal óptico		Technical Stone Technical Stone		Compacto HPL Compacto HPL	
	Ref.	€	Ref.	€	Ref.	€	Ref.	€	Ref.	€
Oak 100 x 100 Roble 100 x 100	ME8035	2.386	ME8040	2.291	ME8050	3.595	ME8055	2.572	ME8060	2.374
kg	56		56		74		57		58	
2 boxes / bultos  m3	0.43		0.43		2.06		2.06		0.43	
Oak 65 x 65 Roble 65 x 65	ME8036	2.302	ME8041	2.203	ME8051	3.083	ME8056	2.464	ME8061	2.301
kg	56		56		74		57		58	
2 boxes / bultos  m3	0.36		0.36		2.03		2.03		0.36	
Aluminum 100 x 100 Aluminio 100 x 100	ME8037	2.190	ME8042	2.159	ME8052	2.996	ME8057	2.439	ME8062	2.257
kg	56		56		74		57		58	
2 boxes / bultos  m3	0.43		0.43		2.06		2.06		0.43	
Delta Aluminum Aluminio Delta	ME8038	2.054	ME8043	2.023	ME8053	2.923	ME8058	3.248	ME8063	2.119
kg	52		52		70		53		54	
2 boxes / bultos  m3	0.36		0.36		1.98		1.98		0.36	
Delta Oak Roble Delta	ME9511	2.354	ME9512	2.325	ME9514	3.235	ME9515	2.645	ME9516	2.424
kg	53		53		73		54		56	
2 boxes / bultos  m3	0.26		0.3		2.74		1.98		0.3	

Legs Patas	Table top / Sobre									
	Laminate Laminado		***M3 Marble Mármol M3		***M1 Marble Mármol M1		Ultra-matte Ultramate		Linoleum Linóleo	
	Ref.	€	Ref.	€	Ref.	€	Ref.	€	Ref.	€
Oak 100 x 100 Roble 100 x 100	ME8065	2.567	ME8834	5.093	ME8909	3.891	ME7674	2.432	ME7733	2.666
kg	56		113		113		53		53	
2 boxes / bultos  m3	0.43		2.06		2.06		0.43		0.43	
Oak 65 x 65 Roble 65 x 65	ME8066	2.491	ME8835	4.964	ME8910	3.632	ME7675	2.338	ME7734	2.566
kg	56		113		113		53		53	
2 boxes / bultos  m3	0.36		2.03		2.06		0.36		0.36	
Aluminum 100 x 100 Aluminio 100 x 100	ME8067	2.450	ME8836	4.978	ME8911	3.248	ME7676	2.578	ME7735	2.598
kg	56		113		113		53		53	
2 boxes / bultos  m3	0.43		2.06		2.06		0.43		0.43	
Delta Aluminum Aluminio Delta	ME8068	2.319	ME8837	5.944	ME8912	4.460	ME7677	2.460	ME7736	2.479
kg	52		113		113		53		53	
2 boxes / bultos  m3	0.29		1.98		1.98		0.36		0.36	
Delta Oak Roble Delta	ME9517	2.638	ME9518	5.003	ME9519	3.397	ME9520	2.764	ME9521	2.785
kg	53		86		86		53		53	
2 boxes / bultos  m3	0.3		1.98		1.98		0.3		0.3	

1800 x 900

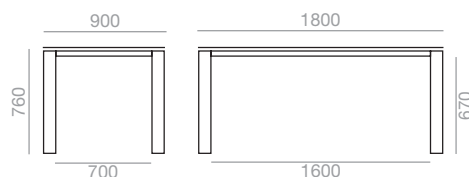

\*\*\*Marble shiny upcharge  
Incremento por mármol brillo

30

SERIE 600

\*Matte lacquered and premium upcharge

\*Incremento por lacado mate y premium

225

Legs Patas	Table top / Sobre									
	*Oak Roble		Lacquered Lacado		Low Iron Glass Cristal óptico		Technical Stone Technical Stone		Compacto HPL Compacto HPL	
	Ref.	€	Ref.	€	Ref.	€	Ref.	€	Ref.	€
Oak 100 x 100 Roble 100 x 100	ME8070	2.556	ME8075	2.436	ME8085	3.864	ME8090	2.827	ME8095	2.589
kg	59		59		80		61		62	
2 boxes / bultos  m3	0.48		0.48		1.11		1.11		0.48	
Oak 65 x 65 Roble 65 x 65	ME8071	2.349	ME8076	2.308	ME8086	3.419	ME8091	2.711	ME8096	2.413
kg	59		59		80		61		62	
2 boxes / bultos  m3	0.4		0.4		1.09		1.09		0.4	
Aluminum 100 x 100 Aluminio 100 x 100	ME8072	2.303	ME8077	2.264	ME8087	3.135	ME8092	2.695	ME8097	2.374
kg	59		59		80		61		62	
2 boxes / bultos  m3	0.48		0.48		1.11		1.11		0.48	
Delta Aluminum Aluminio Delta	ME8073	2.169	ME8078	2.133	ME8088	3.251	ME8093	3.354	ME8098	2.244
kg	55		55		76		57		58	
2 boxes / bultos  m3	0.4		0.4		1.03		1.03		0.4	
Delta Oak Roble Delta	ME9522	2.463	ME9523	2.429	ME9525	3.375	ME9526	2.892	ME9527	2.536
kg	57		57		79		58		60	
2 boxes / bultos  m3	0.33		0.33		1.03		1.03		0.33	

Legs Patas	Table top / Sobre									
	Laminate Laminado		***M3 Marble Mármol M3		***M1 Marble Mármol M1		Ultra-matte Ultramate		Linoleum Linóleo	
	Ref.	€	Ref.	€	Ref.	€	Ref.	€	Ref.	€
Oak 100 x 100 Roble 100 x 100	ME8100	2.707	ME8838	5.519	ME8913	3.922	ME7678	2.639	ME7737	2.891
kg	59		124		124		57		57	
2 boxes / bultos  m3	0.48		2.28		2.28		0.48		0.48	
Oak 65 x 65 Roble 65 x 65	ME8101	2.653	ME8839	5.389	ME8914	3.701	ME7679	2.660	ME7738	2.761
kg	59		124		124		57		57	
2 boxes / bultos  m3	0.4		2.25		2.25		0.4		0.4	
Aluminum 100 x 100 Aluminio 100 x 100	ME8102	2.631	ME8840	5.403	ME8915	3.451	ME7680	2.780	ME7739	2.804
kg	59		124		124		57		57	
2 boxes / bultos  m3	0.48		2.28		2.28		0.48		0.48	
Delta Aluminum Aluminio Delta	ME8103	2.498	ME8841	6.465	ME8916	4.611	ME7681	2.722	ME7740	2.742
kg	55		124		124		57		57	
2 boxes / bultos  m3	0.4		2.2		2.2		0.4		0.4	
Delta Oak Roble Delta	ME9528	2.818	ME9529	5.416	ME9530	3.301	ME9531	3.035	ME9532	3.054
kg	57		97		97		57		57	
2 boxes / bultos  m3	0.33		2.2		2.2		0.33		0.33	

2000 x 1000

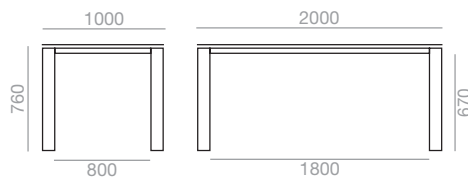

\*\*\*Marble shiny upcharge  
Incremento por mármol brillo

30



\*Matte lacquered and premium upcharge

\*Incremento por lacado mate y premium

240

Legs Patas	Table top / Sobre									
	*Oak Roble		Lacquered Lacado		Low Iron Glass Cristal óptico		Technical Stone Technical Stone		Compacto HPL Compacto HPL	
	Ref.	€	Ref.	€	Ref.	€	Ref.	€	Ref.	€
Oak 100 x 100 Roble 100 x 100	ME8105	2.642	ME8110	2.505	ME8120	4.032	ME8125	3.014	ME8130	2.668
kg	66		66		92		68		70	
2 boxes / bultos m3	0.56		0.56		1.32		1.32		0.56	
Oak 65 x 65 Roble 65 x 65	ME8106	2.553	ME8111	2.381	ME8121	3.522	ME8126	2.849	ME8131	2.596
kg	66		66		92		68		70	
2 boxes / bultos m3	0.48		0.48		1.29		1.29		0.48	
Aluminum 100 x 100 Aluminio 100 x 100	ME8107	2.494	ME8112	2.336	ME8122	3.397	ME8127	2.878	ME8132	2.553
kg	66		66		92		68		70	
2 boxes / bultos m3	0.56		0.56		1.32		1.32		0.56	
Delta Aluminum Aluminio Delta	ME8108	2.357	ME8113	2.203	ME8123	3.505	ME8128	3.591	ME8133	2.416
kg	62		62		88		64		66	
2 boxes / bultos m3	0.48		0.48		1.24		1.24		0.48	
Delta Oak Roble Delta	ME9533	2.656	ME9534	2.502	ME9536	3.961	ME9537	3.086	ME9538	2.715
kg	65		65		92		67		69	
2 boxes / bultos m3	0.44		0.44		1.24		1.4		0.4	

Legs Patas	Table top / Sobre									
	Laminate Laminado		***M3 Marble Mármol M3		***M1 Marble Mármol M1		Ultra-matte Ultramate		Linoleum Linóleo	
	Ref.	€	Ref.	€	Ref.	€	Ref.	€	Ref.	€
Oak 100 x 100 Roble 100 x 100	ME8135	2.841	ME8842	6.257	ME8917	4.271	ME7682	2.788	ME7741	3.064
kg	66		146		146		65		65	
2 boxes / bultos m3	0.56		2.72		2.72		0.56		0.56	
Oak 65 x 65 Roble 65 x 65	ME8136	2.769	ME8843	6.127	ME8918	3.831	ME7683	2.696	ME7742	2.933
kg	66		146		146		65		65	
2 boxes / bultos m3	0.48		2.69		2.69		0.48		0.48	
Aluminum 100 x 100 Aluminio 100 x 100	ME8137	2.764	ME8844	6.141	ME8919	3.580	ME7684	3.045	ME7743	2.949
kg	66		146		146		65		65	
2 boxes / bultos m3	0.56		2.72		2.72		0.56		0.56	
Delta Aluminum Aluminio Delta	ME8138	2.632	ME8845	7.372	ME8920	4.999	ME7685	2.919	ME7744	2.819
kg	62		146		146		65		65	
2 boxes / bultos m3	0.48		2.64		2.64		0.48		0.48	
Delta Oak Roble Delta	ME9539	2.952	ME9540	6.136	ME9541	3.559	ME9542	3.221	ME9543	3.120
kg	65		119		119		65		65	
2 boxes / bultos m3	0.4		2.64		2.64		0.4		0.44	

2200 x 1000

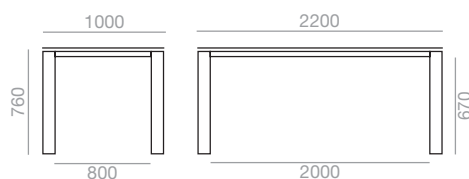

\*\*\*Marble shiny upcharge  
Incremento por mármol brillo

30

SERIE 600

\*Matte lacquered and premium upcharge

\*Incremento por lacado mate y premium

257

Legs Patas	Table top / Sobre									
	*Oak Roble		Lacquered Lacado		Low Iron Glass Cristal óptico		Technical Stone Technical Stone		Compacto HPL Compacto HPL	
	Ref.	€	Ref.	€	Ref.	€	Ref.	€	Ref.	€
Oak 100 x 100 Roble 100 x 100	ME8140	2.855	ME8145	2.666	ME8155	4.228	ME8160	3.143	ME8165	2.891
kg	70		70		98		72		74	
2 boxes / bultos m3	0.61		0.61		1.43		1.43		0.61	
Oak 65 x 65 Roble 65 x 65	ME8141	2.656	ME8146	2.524	ME8156	3.777	ME8161	3.041	ME8166	2.726
kg	70		70		98		72		74	
2 boxes / bultos m3	0.53		0.53		1.41		1.41		0.53	
Aluminum 100 x 100 Aluminio 100 x 100	ME8142	2.561	ME8147	2.488	ME8157	3.588	ME8162	3.016	ME8167	2.702
kg	70		70		98		72		74	
2 boxes / bultos m3	0.61		0.61		1.43		1.43		0.61	
Delta Aluminum Aluminio Delta	ME8143	2.428	ME8148	2.357	ME8158	3.584	ME8163	3.777	ME8168	2.570
kg	66		66		94		68		70	
2 boxes / bultos m3	0.53		0.53		1.35		1.35		0.53	
Delta Oak Roble Delta	ME9544	2.717	ME9545	2.654	ME9547	3.856	ME9548	3.211	ME9549	2.869
kg	69		69		99		71		73	
2 boxes / bultos m3	0.44		0.44		1.35		1.35		0.44	

Legs Patas	Table top / Sobre									
	Laminate Laminado		***M3 Marble Mármol M3		***M1 Marble Mármol M1		Ultra-matte Ultramate		Linoleum Linóleo	
	Ref.	€	Ref.	€	Ref.	€	Ref.	€	Ref.	€
Oak 100 x 100 Roble 100 x 100	ME8170	3.073	ME8846	6.906	ME8921	5.343	ME7686	2.998	ME7745	3.302
kg	70		157		157		69		69	
2 boxes / bultos m3	0.61		2.96		2.96		0.61		0.61	
Oak 65 x 65 Roble 65 x 65	ME8171	2.998	ME8847	6.776	ME8922	4.329	ME7687	2.905	ME7760	3.171
kg	70		157		157		69		69	
2 boxes / bultos m3	0.53		2.93		2.93		0.53		0.53	
Aluminum 100 x 100 Aluminio 100 x 100	ME8172	3.003	ME8848	6.791	ME8923	4.344	ME7688	3.051	ME7761	3.157
kg	70		157		157		69		69	
2 boxes / bultos m3	0.61		2.96		2.96		0.61		0.61	
Delta Aluminum Aluminio Delta	ME8173	2.871	ME8849	8.169	ME8924	5.471	ME7689	3.120	ME7762	3.022
kg	66		157		157		69		69	
2 boxes / bultos m3	0.53		2.88		2.88		0.53		0.53	
Delta Oak Roble Delta	ME9550	3.194	ME9551	6.768	ME9552	4.123	ME9553	3.419	ME9554	3.320
kg	69		131		131		69		69	
2 boxes / bultos m3	0.44		2.88		2.88		0.44		0.44	



2400 x 1000

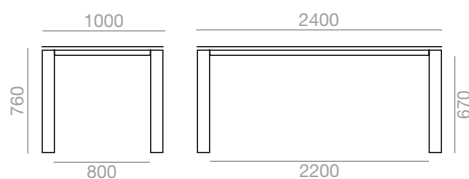

\*\*\*Marble shiny upcharge  
Incremento por mármol brillo

30

SERIE 600

\*Matte lacquered and premium upcharge

\*Incremento por lacado mate y premium

264

Legs Patas	Table top / Sobre									
	*Oak Roble		Lacquered Lacado		Low Iron Glass Cristal óptico		Technical Stone Technical Stone		Compacto HPL Compacto HPL	
	Ref.	€	Ref.	€	Ref.	€	Ref.	€	Ref.	€
Oak 100 x 100 Roble 100 x 100	ME8175	2.934	ME8179	2.736	ME8187	4.201	ME8191	3.162	ME8195	3.033
kg	74		74		104		76		79	
2 boxes / bultos  m3	0.66		0.58		1.54		1.54		0.58	
Aluminum 100 x 100 Aluminio 100 x 100	ME8176	2.684	ME8180	2.571	ME8188	3.737	ME8192	3.037	ME8196	2.711
kg	74		74		104		76		79	
2 boxes / bultos  m3	0.66		1.47		1.54		1.54		0.66	
Delta Aluminum Aluminio Delta	ME8177	2.549	ME8181	2.436	ME8189	3.564	ME8193	3.800	ME8197	2.938
kg	70		70		100		72		75	
2 boxes / bultos  m3	0.66		1.47		1.47		1.47		0.58	
Delta Oak Roble Delta	ME9555	2.842	ME9556	2.730	ME9558	3.977	ME9559	3.235	ME9560	3.259
kg	73		73		107		78		80	
2 boxes / bultos  m3	0.48		0.48		1.47		1.47		0.48	

Legs Patas	Table top / Sobre									
	Laminate Laminado		***M3 Marble Mármol M3		***M1 Marble Mármol M1		Ultra-matte Ultramate		Linoleum Linóleo	
	Ref.	€	Ref.	€	Ref.	€	Ref.	€	Ref.	€
Oak 100 x 100 Roble 100 x 100	ME8199	3.162	ME8850	7.871	ME8925	5.239	ME7690	3.253	ME7763	3.540
kg	74		169		169		78		78	
2 boxes / bultos  m3	0.66		3.2		3.2		0.66		0.66	
Aluminum 100 x 100 Aluminio 100 x 100	ME8200	3.047	ME8851	7.756	ME8926	4.544	ME7691	3.104	ME7764	3.168
kg	74		169		169		78		78	
2 boxes / bultos  m3	0.58		3.2		3.2		0.58		0.58	
Delta Aluminum Aluminio Delta	ME8201	2.915	ME8852	7.758	ME8927	5.745	ME7692	3.267	ME7765	3.166
kg	70		169		169		78		78	
2 boxes / bultos  m3	0.66		3.12		3.12		0.66		0.66	
Delta Oak Roble Delta	ME9561	3.243	ME9562	7.707	ME9563	4.485	ME9564	3.581	ME9565	3.483
kg	73		143		143		73		73	
2 boxes / bultos  m3	0.48		3.12		3.12		0.48		0.48	

2400 x 1200

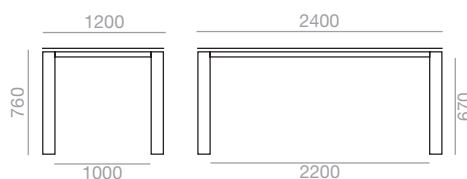

\*\*\*Marble shiny upcharge  
Incremento por mármol brillo

30

SERIE 600

\*Matte lacquered and premium upcharge

\*Incremento por lacado mate y premium

273

Legs Patas	Table top / Sobre							
	*Oak Roble		Lacquered Lacado		Low Iron Glass Cristal óptico		Compacto HPL Compacto HPL	
	Ref.	€	Ref.	€	Ref.	€	Ref.	€
Oak 100 x 100 Roble 100 x 100	ME8203	3.000	ME8207	2.834	ME8215	4.715	ME8219	3.168
kg	81.5		82		118		87	
2 boxes / bultos  m3	0.76		0.76		1.79		0.76	
Aluminum 100 x 100 Aluminio 100 x 100	ME8204	2.823	ME8208	2.702	ME8216	3.945	ME8220	2.936
kg	82		82		118		87	
2 boxes / bultos  m3	0.76		0.76		1.79		0.76	
Delta Aluminum Aluminio Delta	ME8205	2.688	ME8209	2.564	ME8217	3.960	ME8221	2.800
kg	78		78		114		83	
2 boxes / bultos  m3	0.68		0.68		1.71		0.68	
Delta Oak Roble Delta	ME9566	2.989	ME9567	2.863	ME9569	4.185	ME9570	3.093
kg	82		82		122		88	
2 boxes / bultos  m3	0.68		0.48		1.71		0.56	

Legs Patas	Table top / Sobre									
	Laminate Laminado		***M3 Marble Mármol M3		***M1 Marble Mármol M1		Ultra-matte Ultramate		Linoleum Linóleo	
	Ref.	€	Ref.	€	Ref.	€	Ref.	€	Ref.	€
Oak 100 x 100 Roble 100 x 100	ME8223	3.281	ME8853	7.973	ME8928	5.406	ME7693	3.353	ME7766	3.653
kg	82		196		196		82		82	
2 boxes / bultos  m3	0.76		3.72		3.72		0.76		0.76	
Aluminum 100 x 100 Aluminio 100 x 100	ME8224	3.136	ME8854	7.857	ME8929	4.901	ME7694	3.234	ME7767	3.282
kg	82		196		196		82		82	
2 boxes / bultos  m3	0.76		3.72		3.72		0.76		0.76	
Delta Aluminum Aluminio Delta	ME8225	3.005	ME8855	7.723	ME8930	4.762	ME7695	3.359	ME7768	3.259
kg	78		196		196		82		82	
2 boxes / bultos  m3	0.68		3.64		3.64		0.68		0.68	
Delta Oak Roble Delta	ME9571	3.361	ME9572	7.807	ME9573	4.616	ME9574	3.693	ME9575	3.595
kg	82		172		172		82		82	
2 boxes / bultos  m3	3.64		4.05		3.64		0.56		0.56	

2600 x 1000

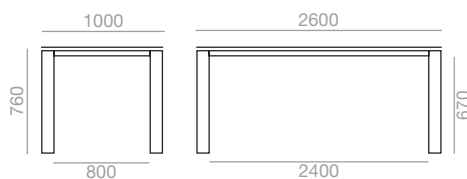

\*\*\*Marble shiny upcharge  
Incremento por mármol brillo

30

SERIE 600

\*Matte lacquered and premium upcharge

\*Incremento por lacado mate y premium

270

Legs Patas	Table top / Sobre									
	*Oak Roble		Lacquered Lacado		Low Iron Glass Cristal óptico		Technical Stone Technical Stone		Compacto HPL Compacto HPL	
	Ref.	€	Ref.	€	Ref.	€	Ref.	€	Ref.	€
Oak 100 x 100 Roble 100 x 100	ME8227	2.967	ME8231	2.832	ME8239	4.546	ME8243	3.222	ME8247	3.117
kg	78		78		111		81		83	
2 boxes / bultos  m3	0.7		0.7		3.44		0.7		0.7	
Aluminum 100 x 100 Aluminio 100 x 100	ME8228	2.806	ME8232	2.711	ME8240	4.061	ME8244	3.113	ME8248	3.000
kg	78		78		111		81		83	
2 boxes / bultos  m3	0.7		0.7		3.44		0.7		0.7	
Delta Aluminum Aluminio Delta	ME8229	2.671	ME8233	2.577	ME8241	3.906	ME8245	3.898	ME8249	2.862
kg	74		74		107		77		79	
2 boxes / bultos  m3	0.62		0.62		3.36		0.62		0.62	
Delta Oak Roble Delta	ME9576	2.971	ME9577	2.880	ME9579	4.296	ME9580	3.307	ME9581	3.162
kg	77		77		114		80		83	
2 boxes / bultos  m3	0.61		0.61		3.36		3.77		0.52	

Legs Patas	Table top / Sobre									
	Laminate Laminado		***M3 Marble Mármol M3		***M1 Marble Mármol M1		Ultra-matte Ultramate		Linoleum Linóleo	
	Ref.	€	Ref.	€	Ref.	€	Ref.	€	Ref.	€
Oak 100 x 100 Roble 100 x 100	ME8251	3.476	ME8856	8.854	ME8931	5.276	ME7696	3.542	ME7769	3.874
kg	78		181		181		82		82	
2 boxes / bultos  m3	0.7		3.44		3.44		0.7		0.7	
Aluminum 100 x 100 Aluminio 100 x 100	ME8252	3.363	ME8857	8.739	ME8932	4.781	ME7697	3.140	ME7770	3.474
kg	78		181		181		82		82	
2 boxes / bultos  m3	0.7		3.44		3.44		0.7		0.7	
Delta Aluminum Aluminio Delta	ME8253	3.231	ME8858	8.605	ME8933	4.641	ME7698	3.531	ME7771	3.563
kg	74		181		181		82		82	
2 boxes / bultos  m3	0.62		3.36		3.36		0.62		0.62	
Delta Oak Roble Delta	ME9582	3.561	ME9583	8.669	ME9584	4.509	ME9585	3.842	ME9586	3.873
kg	77		155		155		77		77	
2 boxes / bultos  m3	0.52		3.36		3.36		0.52		0.52	

2600 x 1200

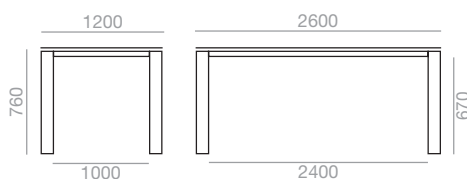

\*\*\*Marble shiny upcharge  
Incremento por mármol brillo

30

SERIE 600

\*Matte lacquered and premium upcharge

\*Incremento por lacado mate y premium

291

Legs Patas	Table top / Sobre							
	*Oak Roble		Lacquered Lacado		Low Iron Glass Cristal óptico		Compacto HPL Compacto HPL	
	Ref.	€	Ref.	€	Ref.	€	Ref.	€
Oak 100 x 100 Roble 100 x 100	ME8255	3.157	ME8259	2.953	ME8267	4.827	ME8271	3.288
kg	87		87		126		92	
2 boxes / bultos  m3	0.81		0.81		4		0.81	
Aluminum 100 x 100 Aluminio 100 x 100	ME8256	2.944	ME8260	2.834	ME8268	4.296	ME8272	3.081
kg	87		87		126		92	
2 boxes / bultos  m3	0.81		0.81		4		0.81	
Delta Aluminum Aluminio Delta	ME8257	2.808	ME8261	2.696	ME8269	4.153	ME8273	2.943
kg	83		83		122		88	
2 boxes / bultos  m3	0.74		0.74		3.92		0.74	
Delta Oak Roble Delta	ME9587	3.108	ME9588	2.999	ME9590	4.541	ME9591	3.235
kg	87		87		130		88	
2 boxes / bultos  m3	0.61		0.61		3.92		0.61	

Legs Patas	Table top / Sobre									
	Laminate Laminado		***M3 Marble Mármol M3		***M1 Marble Mármol M1		Ultra-matte Ultramate		Linoleum Linóleo	
	Ref.	€	Ref.	€	Ref.	€	Ref.	€	Ref.	€
Oak 100 x 100 Roble 100 x 100	ME8275	3.582	ME8859	9.244	ME8934	6.201	ME7699	3.655	ME7772	4.002
kg	87		210		210		93		93	
2 boxes / bultos  m3	0.81		4		4		0.81		0.81	
Aluminum 100 x 100 Aluminio 100 x 100	ME8276	3.468	ME8860	9.129	ME8935	4.939	ME7700	3.244	ME7773	3.746
kg	87		210		210		93		93	
2 boxes / bultos  m3	0.81		4		4		0.81		0.81	
Delta Aluminum Aluminio Delta	ME8277	3.337	ME8861	8.996	ME8936	5.023	ME7701	3.634	ME7774	3.667
kg	83		210		210		93		93	
1 box / bulto  m3	0.74		3.92		3.92		0.6		0.6	
Delta Oak Roble Delta	ME9592	3.660	ME9593	9.050	ME9594	5.075	ME9595	3.946	ME9596	3.976
kg	93		186		186		93		93	
1 box / bulto  m3	0.6		3.92		3.92		0.6		0.6	

2800 x 1000

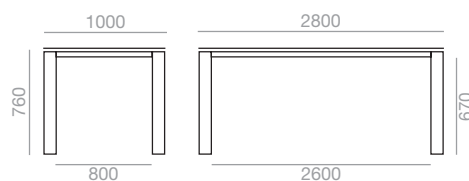

\*\*\*Marble shiny upcharge  
Incremento por mármol brillo

30

SERIE 600

\*Matte lacquered and premium upcharge

\*Incremento por lacado mate y premium

276

Legs Patas	Table top / Sobre									
	*Oak Roble		Lacquered Lacado		Low Iron Glass Cristal óptico		Technical Stone Technical Stone		Compacto HPL Compacto HPL	
	Ref.	€	Ref.	€	Ref.	€	Ref.	€	Ref.	€
Oak 100 x 100 Roble 100 x 100	ME8279	3.231	ME8283	3.001	ME8291	4.736	ME8295	3.283	ME8299	3.281
kg	82		82		117		85		87	
2 boxes / bultos m3	0.75		0.75		3.68		3.68		0.75	
Aluminum 100 x 100 Aluminio 100 x 100	ME8280	2.999	ME8284	2.868	ME8292	4.261	ME8296	3.170	ME8300	3.169
kg	82		82		117		85		87	
2 boxes / bultos m3	0.75		0.75		3.68		3.68		0.75	
Delta Aluminum Aluminio Delta	ME8281	2.862	ME8285	2.731	ME8293	4.101	ME8297	3.976	ME8301	3.035
kg	78		78		113		81		83	
2 boxes / bultos m3	0.67		0.67		3.6		3.6		0.67	
Delta Oak Roble Delta	ME9597	3.159	ME9598	3.029	ME9600	4.324	ME9601	3.365	ME9602	3.333
kg	82		82		121		85		87	
2 boxes / bultos m3	0.61		0.56		3.6		3.6		0.56	

Legs Patas	Table top / Sobre									
	Laminate Laminado		***M3 Marble Mármol M3		***M1 Marble Mármol M1		Ultra-matte Ultramate		Linoleum Linóleo	
	Ref.	€	Ref.	€	Ref.	€	Ref.	€	Ref.	€
Oak 100 x 100 Roble 100 x 100	ME8303	3.568	ME8862	9.268	ME8937	5.532	ME7702	3.484	ME7775	4.020
kg	82		193		193		85		85	
2 boxes / bultos m3	0.75		3.68		3.68		0.75		0.75	
Aluminum 100 x 100 Aluminio 100 x 100	ME8304	3.454	ME8863	9.153	ME8938	5.019	ME7703	3.231	ME7776	3.802
kg	82		193		193		85		85	
2 boxes / bultos m3	0.75		3.68		3.68		0.75		0.75	
Delta Aluminum Aluminio Delta	ME8305	3.321	ME8864	9.018	ME8939	6.067	ME7704	3.621	ME7777	3.654
kg	78		193		193		85		85	
1 box / bulto m3	0.54		3.6		3.6		0.54		0.54	
Delta Oak Roble Delta	ME9603	3.649	ME9604	9.072	ME9605	4.723	ME9606	3.930	ME9607	3.966
kg	82		155		155		82		82	
1 box / bulto m3	0.54		3.6		3.6		0.54		0.54	

2800 X 1200

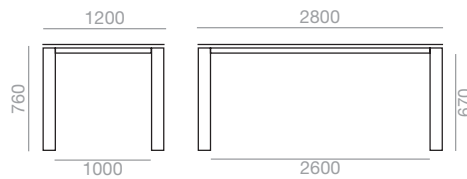

\*\*\*Marble shiny upcharge  
Incremento por mármol brillo

30

SERIE 600

\*Matte lacquered and premium upcharge

\*Incremento por lacado mate y premium

305

Legs Patas	Table top / Sobre							
	*Oak Roble		Lacquered Lacado		Low Iron Glass Cristal óptico		Compacto HPL Compacto HPL	
	Ref.	€	Ref.	€	Ref.	€	Ref.	€
Oak 100 x 100 Roble 100 x 100	ME8307	3.390	ME8311	3.155	ME8319	5.210	ME8323	3.377
kg	91		91		134		97	
2 boxes / bultos  m3	0.87		0.87		4.28		0.87	
Aluminum 100 x 100 Aluminio 100 x 100	ME8308	3.104	ME8312	2.974	ME8320	4.514	ME8324	3.265
kg	91		91		134		97	
2 boxes / bultos  m3	0.87		0.87		4.28		0.87	
Delta Aluminum Aluminio Delta	ME8309	3.023	ME8313	2.837	ME8321	4.518	ME8325	3.133
kg	87		87		130		93	
2 boxes / bultos  m3	0.79		0.79		4.2		0.79	
Delta Oak Roble Delta	ME9608	3.318	ME9609	3.131	ME9611	4.610	ME9612	3.426
kg	92		92		139		99	
2 boxes / bultos  m3	0.56		0.56		4.2		0.66	

Legs Patas	Table top / Sobre									
	Laminate Laminado		***M3 Marble Mármol M3		***M1 Marble Mármol M1		Ultra-matte Ultramate		Linoleum Linóleo	
	Ref.	€	Ref.	€	Ref.	€	Ref.	€	Ref.	€
Oak 100 x 100 Roble 100 x 100	ME8327	3.673	ME8865	9.384	ME8940	5.975	ME7705	3.590	ME7778	4.111
kg	91		224		224		93		93	
2 boxes / bultos  m3	0.87		4.28		4.28		0.87		0.87	
Aluminum 100 x 100 Aluminio 100 x 100	ME8328	3.561	ME8866	9.268	ME8941	5.430	ME7706	3.334	ME7779	3.889
kg	91		224		224		93		93	
2 boxes / bultos  m3	0.87		4.28		4.28		0.87		0.87	
Delta Aluminum Aluminio Delta	ME8329	3.428	ME8867	9.300	ME8942	5.293	ME7707	3.729	ME7780	3.757
kg	87		224		224		93		93	
2 boxes / bultos  m3	0.79		4.2		4.2		0.79		0.79	
Delta Oak Roble Delta	ME9613	3.752	ME9614	9.183	ME9615	5.096	ME9616	4.037	ME9617	4.068
kg	93		200		200		93		93	
2 boxes / bultos  m3	0.66		4.2		4.2		0.66		0.66	

3000 x 1000

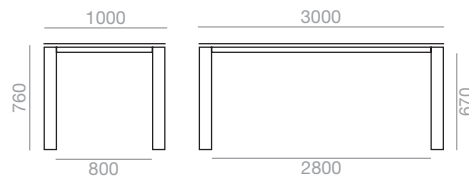

\*\*\*Marble shiny upcharge  
Incremento por mármol brillo

30

SERIE 600

\*Matte lacquered and premium upcharge

\*Incremento por lacado mate y premium

284

Legs Patas	Table top / Sobre									
	*Oak Roble		Lacquered Lacado		Low Iron Glass Cristal óptico		Technical Stone Technical Stone		Compacto HPL Compacto HPL	
	Ref.	€	Ref.	€	Ref.	€	Ref.	€	Ref.	€
Oak 100 x 100 Roble 100 x 100	ME8331	3.343	ME8335	3.118	ME8343	4.879	ME8347	3.520	ME8351	3.397
kg	86		86		124		89		91	
2 boxes / bultos  m3	0.79		0.79		3.92		0.79		0.79	
Aluminum 100 x 100 Aluminio 100 x 100	ME8332	3.104	ME8336	2.983	ME8344	4.513	ME8348	3.244	ME8352	3.278
kg	86		86		124		89		91	
2 boxes / bultos  m3	0.79		0.79		3.92		0.79		0.79	
Delta Aluminum Aluminio Delta	ME8333	2.967	ME8337	2.845	ME8345	4.440	ME8349	4.071	ME8353	3.140
kg	82		82		120		85		87	
2 boxes / bultos  m3	0.72		0.72		3.84		0.72		0.72	
Delta Oak Roble Delta	ME9618	3.258	ME9619	3.142	ME9621	4.625	ME9622	3.438	ME9623	3.454
kg	86		86		128		89		92	
2 boxes / bultos  m3	0.59		0.59		3.84		4.29		0.59	

Legs Patas	Table top / Sobre					
	Laminate Laminado		Ultra-matte Ultramate		Linoleum Linóleo	
	Ref.	€	Ref.	€	Ref.	€
Oak 100 x 100 Roble 100 x 100	ME8355	3.659	ME7708	3.850	ME7781	4.243
kg	86		93		93	
2 boxes / bultos  m3	0.79		0.79		0.79	
Aluminum 100 x 100 Aluminio 100 x 100	ME8356	3.544	ME7709	3.484	ME7782	4.058
kg	86		93		93	
2 boxes / bultos  m3	0.79		0.79		0.79	
Delta Aluminum Aluminio Delta	ME8357	3.413	ME7710	3.710	ME7783	3.850
kg	82		93		93	
2 boxes / bultos  m3	0.72		0.72		0.72	
Delta Oak Roble Delta	ME9624	3.733	ME9625	4.021	ME9626	4.056
kg	92		92		92	
2 boxes / bultos  m3	0.59		0.59		0.59	

3000 x 1200

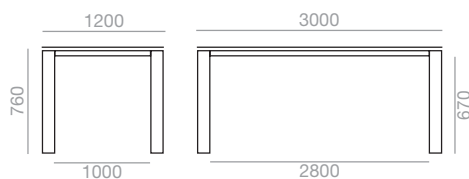

SERIE 600

\*\*\*Marble shiny upcharge  
Incremento por mármol brillo

30

\*Matte lacquered and premium upcharge

\*Incremento por lacado mate y premium

321

Legs Patas	Table top / Sobre							
	*Oak Roble		Lacquered Lacado		Low Iron Glass Cristal óptico		Compacto HPL Compacto HPL	
	Ref.	€	Ref.	€	Ref.	€	Ref.	€
Oak 100 x 100 Roble 100 x 100	ME8359	3.527	ME8363	3.247	ME8371	5.487	ME8375	3.499
kg	95		95		141		102	
2 boxes / bultos  m3	0.92		0.92		4.56		0.92	
Aluminum 100 x 100 Aluminio 100 x 100	ME8360	3.249	ME8364	3.129	ME8372	4.757	ME8376	3.379
kg	95		95		141		102	
2 boxes / bultos  m3	0.92		0.92		4.56		0.92	
Delta Aluminum Aluminio Delta	ME8361	3.113	ME8365	2.993	ME8373	4.911	ME8377	3.245
kg	91		91		137		98	
2 boxes / bultos  m3	0.85		0.85		4.48		0.85	
Delta Oak Roble Delta	ME9627	3.410	ME9628	3.800	ME9630	5.168	ME9631	3.560
kg	97		97		147		104	
2 boxes / bultos  m3	0.7		3.3		4.48		0.7	

Legs Patas	Table top / Sobre					
	Laminate Laminado		Ultra-matte Ultramate		Linoleum Linóleo	
	Ref.	€	Ref.	€	Ref.	€
Oak 100 x 100 Roble 100 x 100	ME8379	3.772	ME7711	3.916	ME7784	4.476
kg	95		97		97	
2 boxes / bultos  m3	0.92		0.92		0.92	
Aluminum 100 x 100 Aluminio 100 x 100	ME8380	3.605	ME7712	3.522	ME7785	4.183
kg	95		97		97	
2 boxes / bultos  m3	0.92		0.92		0.92	
Delta Aluminum Aluminio Delta	ME8381	3.468	ME7713	3.818	ME7870	3.846
kg	91		97		97	
2 boxes / bultos  m3	0.85		0.85		0.85	
Delta Oak Roble Delta	ME9632	3.789	ME9633	4.248	ME9634	4.160
kg	97		97		97	
2 boxes / bultos  m3	0.7		0.7		0.74	



3200 x 1200

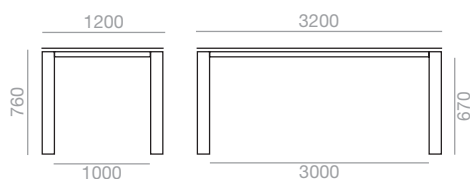

\*\*\*Marble shiny upcharge  
Incremento por mármol brillo | 30 |

SERIE 600

\*Matte lacquered and premium upcharge  
\*Incremento por lacado mate y premium | 336 |

Legs Patas	Table top / Sobre					
	*Oak Roble		Lacquered Lacado		Compacto HPL Compacto HPL	
	Ref.	€	Ref.	€	Ref.	€
Oak 100 x 100 Roble 100 x 100	ME8383	3.893	ME8387	3.365	ME8399	3.613
kg	100		100		107	
2 boxes / bultos m3	0.98		0.98		0.98	
Aluminum 100 x 100 Aluminio 100 x 100	ME8384	3.667	ME8388	3.246	ME8400	3.490
kg	100		100		107	
2 boxes / bultos m3	0.98		0.98		0.98	
Delta Aluminum Aluminio Delta	ME8385	3.531	ME8389	3.110	ME8401	3.357
kg	96		96		103	
2 boxes / bultos m3	0.9		0.9		0.9	
Delta Oak Roble Delta	ME9635	3.821	ME9636	3.507	ME9637	3.659
kg	102		102		109	
2 boxes / bultos m3	0.74		0.74		0.79	

3400 x 1200

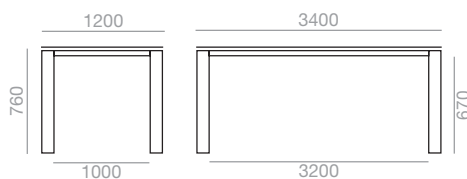

\*\*\*Marble shiny upcharge  
Incremento por mármol brillo | 30 |

SERIE 600

\*Matte lacquered and premium upcharge  
\*Incremento por lacado mate y premium | 356 |

Legs Patas	Table top / Sobre					
	*Oak Roble		Lacquered Lacado		Compacto HPL Compacto HPL	
	Ref.	€	Ref.	€	Ref.	€
Oak 100 x 100 Roble 100 x 100	ME8407	4.083	ME8411	3.460	ME8423	3.788
kg	104		104		112	
2 boxes / bultos  m3	1.03		1.03		1.03	
Aluminum 100 x 100 Aluminio 100 x 100	ME8408	3.791	ME8412	3.319	ME8424	3.571
kg	104		104		112	
2 boxes / bultos  m3	1.03		1.03		1.03	
Delta Aluminum Aluminio Delta	ME8409	3.655	ME8413	3.183	ME8425	3.435
kg	100		100		108	
2 boxes / bultos  m3	0.96		0.96		0.96	
Delta Oak Roble Delta	ME9638	3.947	ME9639	3.741	ME9640	3.728
kg	107		107		115	
2 boxes / bultos  m3	0.79		0.79		0.39	

1400 x 1400

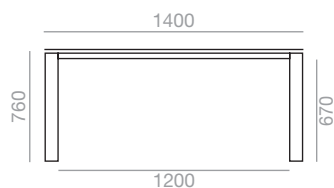

\*\*\*Marble shiny upcharge  
Incremento por mármol brillo | 30 |

SERIE 600

\*Matte lacquered and premium upcharge  
\*Incremento por lacado mate y premium | 336 |

Legs Patas	Table top / Sobre							
	*Oak Roble		Lacquered Lacado		Low Iron Glass Cristal óptico		Compacto HPL Compacto HPL	
	Ref.	€	Ref.	€	Ref.	€	Ref.	€
Oak 100 x 100 Roble 100 x 100	<b>ME8872</b>	2.591	<b>ME8878</b>	2.477	<b>ME8890</b>	3.857	<b>ME8896</b>	2.631
kg	66		66		91		70	
2 boxes / bultos  m3	0.55		0.55		1.28		0.55	
Aluminum 100 x 100 Aluminio 100 x 100	<b>ME8873</b>	2.409	<b>ME8879</b>	2.296	<b>ME8891</b>	3.340	<b>ME8897</b>	2.421
kg	66		66		91		70	
2 boxes / bultos  m3	0.55		0.55		1.28		0.55	
Delta Aluminum Aluminio Delta	<b>ME8874</b>	2.305	<b>ME8880</b>	2.191	<b>ME8892</b>	3.441	<b>ME8898</b>	2.307
kg	66		66		91		70	
1 box / bulto  m3	0.39		0.39		1.2		0.39	
Delta Oak Roble Delta	<b>ME9641</b>	2.525	<b>ME9642</b>	2.787	<b>ME9644</b>	3.803	<b>ME9645</b>	2.528
kg	65		65		92		69	
2 boxes / bultos  m3	0.39		0.39		1.2		0.39	

Legs Patas	Table top / Sobre									
	Laminate Laminado		***M3 Marble Mármol M3		***M1 Marble Mármol M1		Ultra-matte Ultramate		Linoleum Linóleo	
	Ref.	€	Ref.	€	Ref.	€	Ref.	€	Ref.	€
Oak 100 x 100 Roble 100 x 100	<b>ME8902</b>	2.734	<b>ME8868</b>	6.257	<b>ME8943</b>	4.271	<b>ME7714</b>	2.841	<b>ME7871</b>	3.113
kg	66		142		142		65		65	
2 boxes / bultos  m3	0.55		2.64		2.64		0.55		0.55	
Aluminum 100 x 100 Aluminio 100 x 100	<b>ME8903</b>	2.515	<b>ME8870</b>	6.141	<b>ME8945</b>	3.580	<b>ME7715</b>	2.673	<b>ME7872</b>	2.596
kg	66		142		142		65		65	
2 boxes / bultos  m3	0.55		2.64		2.64		0.55		0.55	
Delta Aluminum Aluminio Delta	<b>ME8904</b>	2.409	<b>ME8871</b>	6.007	<b>ME8946</b>	3.451	<b>ME7716</b>	3.493	<b>ME7873</b>	2.776
kg	66		142		142		65		65	
1 box / bulto  m3	0.39		2.56		2.56		0.39		0.39	
Delta Oak Roble Delta	<b>ME9646</b>	2.630	<b>ME9647</b>	6.136	<b>ME9648</b>	3.828	<b>ME9649</b>	3.146	<b>ME9650</b>	3.091
kg	65		119		119		65		65	
1 box / bulto  m3	0.39		2.56		2.56		0.39		0.39	

High Table  
1400 x 900

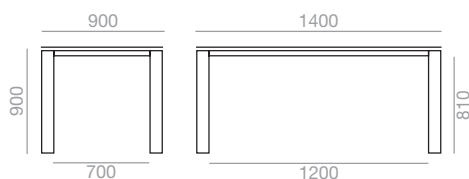

\*\*\*Marble shiny upcharge  
Incremento por mármol brillo

30

SERIE  
600

\*Matte lacquered and premium upcharge

\*Incremento por lacado mate y premium

230

Legs Patas	Table top / Sobre									
	*Oak Roble		Lacquered Lacado		Low Iron Glass Cristal óptico		Technical Stone Technical Stone		Compacto HPL Compacto HPL	
	Ref.	€	Ref.	€	Ref.	€	Ref.	€	Ref.	€
Aluminum 100 x 100 Aluminio 100 x 100	ME01000	2.349	ME01001	2.315	ME01003	2.892	ME01004	2.374	ME01005	2.440
kg	52		52		70		54		53	
2 boxes / bultos  m3	0.38		0.38		0.9		1.84		0.38	

Legs Patas	Table top / Sobre									
	Laminate Laminado		***M3 Marble Mármol M3		***M1 Marble Mármol M1		Ultra-matte Ultramate		Linoleum Linóleo	
	Ref.	€	Ref.	€	Ref.	€	Ref.	€	Ref.	€
Aluminum 100 x 100 Aluminio 100 x 100	ME01006	2.474	ME01007	6.102	ME01009	3.582	ME01010	2.760	ME01011	2.764
kg	52		79		79		52		52	
2 boxes / bultos  m3	0.34		1.84		1.84		0.36		0.32	

High Table  
1600 x 900

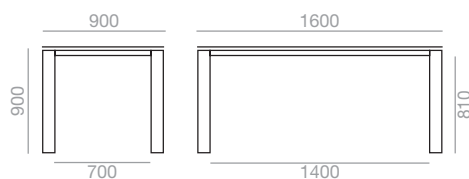

\*\*\*Marble shiny upcharge  
Incremento por mármol brillo | 30 |

SERIE  
600

\*Matte lacquered and premium upcharge  
\*Incremento por lacado mate y premium | 246 |

Legs Patatas	Table top / Sobre									
	*Oak Roble		Lacquered Lacado		Low Iron Glass Cristal óptico		Technical Stone Technical Stone		Compacto HPL Compacto HPL	
	Ref.	€	Ref.	€	Ref.	€	Ref.	€	Ref.	€
Aluminum 100 x 100 Aluminio 100 x 100	ME01012	2.518	ME01013	2.421	ME01015	3.000	ME01016	2.493	ME01017	2.608
kg	56.5		56.5		74		59		58	
2 boxes / bultos m3	0.39		0.39		2.06		2.06		0.39	

Legs Patatas	Table top / Sobre									
	Laminate Laminado		***M3 Marble Mármol M3		***M1 Marble Mármol M1		Ultra-matte Ultramate		Linoleum Linóleo	
	Ref.	€	Ref.	€	Ref.	€	Ref.	€	Ref.	€
Aluminum 100 x 100 Aluminio 100 x 100	ME01018	2.658	ME01019	6.503	ME01021	3.802	ME01022	3.093	ME01023	3.046
kg	57		90		90		58		58	
2 boxes / bultos m3	0.39		2.06		2.06		0.39		0.39	

High Table  
1800 x 900

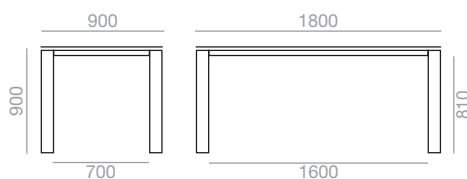

\*\*\*Marble shiny upcharge  
Incremento por mármol brillo | 30 |

SERIE  
600

\*Matte lacquered and premium upcharge  
\*Incremento por lacado mate y premium | 264 |

Legs Patas	Table top / Sobre									
	*Oak Roble		Lacquered Lacado		Low Iron Glass Cristal óptico		Technical Stone Technical Stone		Compacto HPL Compacto HPL	
	Ref.	€	Ref.	€	Ref.	€	Ref.	€	Ref.	€
Aluminum 100 x 100 Aluminio 100 x 100	ME01024	2.614	ME01025	2.502	ME01027	3.349	ME01028	2.599	ME01029	2.723
kg	61		61		83		63		62	
2 boxes / bultos  m3	0.42		0.42		1.13		2.29		0.42	

Legs Patas	Table top / Sobre									
	Laminate Laminado		***M3 Marble Mármol M3		***M1 Marble Mármol M1		Ultra-matte Ultramate		Linoleum Linóleo	
	Ref.	€	Ref.	€	Ref.	€	Ref.	€	Ref.	€
Aluminum 100 x 100 Aluminio 100 x 100	ME01030	2.751	ME01031	7.049	ME01033	3.916	ME01034	3.208	ME01035	3.232
kg	61		100		100		61		61	
2 boxes / bultos  m3	0.42		2.29		2.29		0.42		0.42	

High Table  
2000 x 1000

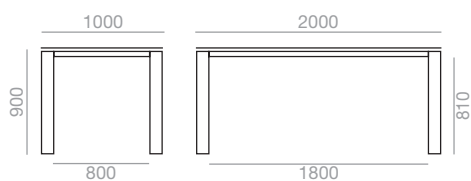

\*\*\*Marble shiny upcharge  
Incremento por mármol brillo | 30 |

SERIE  
600

\*Matte lacquered and premium upcharge  
\*Incremento por lacado mate y premium | 282 |

Legs Patas	Table top / Sobre									
	*Oak Roble		Lacquered Lacado		Low Iron Glass Cristal óptico		Technical Stone Technical Stone		Compacto HPL Compacto HPL	
	Ref.	€	Ref.	€	Ref.	€	Ref.	€	Ref.	€
Aluminum 100 x 100 Aluminio 100 x 100	ME01036	2.796	ME01037	2.583	ME01039	3.493	ME01040	2.901	ME01041	2.812
kg	69		69		97		71		70	
2 boxes / bultos m3	0.5		0.5		3.08		2.73		0.5	

Legs Patas	Table top / Sobre									
	Laminate Laminado		***M3 Marble Mármol M3		***M1 Marble Mármol M1		Ultra-matte Ultramate		Linoleum Linóleo	
	Ref.	€	Ref.	€	Ref.	€	Ref.	€	Ref.	€
Aluminum 100 x 100 Aluminio 100 x 100	ME01042	2.884	ME01043	9.975	ME01045	4.237	ME01046	3.396	ME01047	3.422
kg	69		124		124		69		69	
2 boxes / bultos m3	0.5		2.73		2.73		0.5		0.5	

High Table  
2200 x 1000

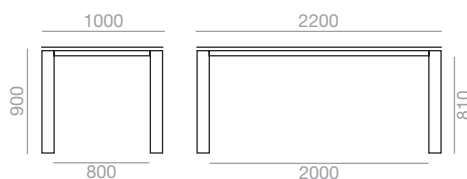

\*\*\*Marble shiny upcharge  
Incremento por mármol brillo

30

SERIE  
600

\*Matte lacquered and premium upcharge

\*Incremento por lacado mate y premium

302

Legs Patas	Table top / Sobre									
	*Oak Roble		Lacquered Lacado		Low Iron Glass Cristal óptico		Technical Stone Technical Stone		Compacto HPL Compacto HPL	
	Ref.	€	Ref.	€	Ref.	€	Ref.	€	Ref.	€
Aluminum 100 x 100 Aluminio 100 x 100	ME01048	2.945	ME01049	2.768	ME01051	3.675	ME01052	3.054	ME01053	3.094
kg	72.5		72.5		103		75		74	
2 boxes / bultos  m3	0.53		0.53		1.45		2.97		0.53	

Legs Patas	Table top / Sobre									
	Laminate Laminado		***M3 Marble Mármol M3		***M1 Marble Mármol M1		Ultra-matte Ultramate		Linoleum Linóleo	
	Ref.	€	Ref.	€	Ref.	€	Ref.	€	Ref.	€
Aluminum 100 x 100 Aluminio 100 x 100	ME01054	3.083	ME01055	10.317	ME01057	4.708	ME01058	3.656	ME01059	3.559
kg	73		135		135		73		73	
2 boxes / bultos  m3	3.34		2.97		2.97		0.53		0.57	



High Table  
2400 x 1000

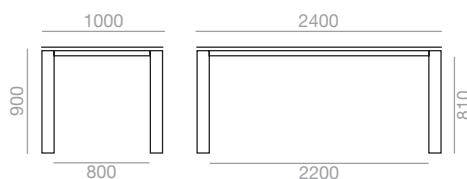

\*\*\*Marble shiny upcharge  
Incremento por mármol brillo | 30 |

SERIE  
600

\*Matte lacquered and premium upcharge  
\*Incremento por lacado mate y premium | 311 |

Legs Patas	Table top / Sobre									
	*Oak Roble		Lacquered Lacado		Low Iron Glass Cristal óptico		Technical Stone Technical Stone		Compacto HPL Compacto HPL	
	Ref.	€	Ref.	€	Ref.	€	Ref.	€	Ref.	€
Aluminum 100 x 100 Aluminio 100 x 100	ME01060	3.031	ME01061	2.848	ME01063	3.743	ME01064	3.074	ME01065	3.274
kg	77		77		110		79		78	
2 boxes / bultos  m3	0.57		0.57		1.42		3.21		0.57	

Legs Patas	Table top / Sobre									
	Laminate Laminado		***M3 Marble Mármol M3		***M1 Marble Mármol M1		Ultra-matte Ultramate		Linoleum Linóleo	
	Ref.	€	Ref.	€	Ref.	€	Ref.	€	Ref.	€
Aluminum 100 x 100 Aluminio 100 x 100	ME01066	3.153	ME01067	10.522	ME01069	5.072	ME01070	3.770	ME01071	3.654
kg	77		148		148		77		77	
2 boxes / bultos  m3	0.57		3.21		3.21		0.57		0.57	

High Table  
2400 x 1200

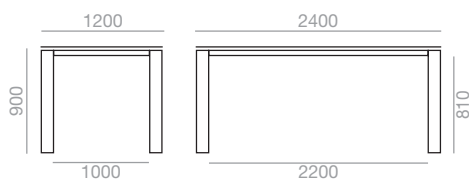

\*\*\*Marble shiny upcharge  
Incremento por mármol brillo | 30 |

SERIE  
600

\*Matte lacquered and premium upcharge  
\*Incremento por lacado mate y premium | 321 |

Legs Patatas	Table top / Sobre							
	*Oak Roble		Lacquered Lacado		Low Iron Glass Cristal óptico		Compacto HPL Compacto HPL	
	Ref.	€	Ref.	€	Ref.	€	Ref.	€
Aluminum 100 x 100 Aluminio 100 x 100	ME01072	3.197	ME01073	2.959	ME01075	4.094	ME01076	3.424
kg	85		85		125		92	
2 boxes / bultos  m3	0.66		0.66		1.8		0.66	

Legs Patatas	Table top / Sobre									
	Laminate Laminado		***M3 Marble Mármol M3		***M1 Marble Mármol M1		Ultra-matte Ultramate		Linoleum Linóleo	
	Ref.	€	Ref.	€	Ref.	€	Ref.	€	Ref.	€
Aluminum 100 x 100 Aluminio 100 x 100	ME01077	3.277	ME01078	10.613	ME01080	5.452	ME01081	3.894	ME01082	3.765
kg	85		175		175		85		85	
2 boxes / bultos  m3	0.66		3.73		3.73		0.66		0.66	

**High Table**  
**2600 x 1000**

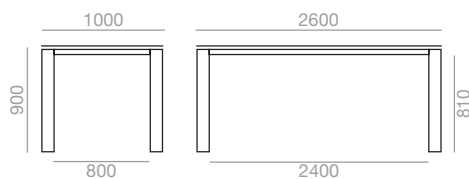

\*\*\*Marble shiny upcharge  
Incremento por mármol brillo

30

SERIE  
600

\*Matte lacquered and premium upcharge

\*Incremento por lacado mate y premium

317

Legs Patas	Table top / Sobre									
	*Oak Roble		Lacquered Lacado		Low Iron Glass Cristal óptico		Technical Stone Technical Stone		Compacto HPL Compacto HPL	
	Ref.	€	Ref.	€	Ref.	€	Ref.	€	Ref.	€
Aluminum 100 x 100 Aluminio 100 x 100	<b>ME01083</b>	3.163	<b>ME01084</b>	2.966	<b>ME01086</b>	3.993	<b>ME01087</b>	3.363	<b>ME01088</b>	3.431
kg	81		81		117		83		82	
2 boxes / bultos  m3	0.61		0.61		3.44		3.44		0.61	

Legs Patas	Table top / Sobre									
	Laminate Laminado		***M3 Marble Mármol M3		***M1 Marble Mármol M1		Ultra-matte Ultramate		Linoleum Linóleo	
	Ref.	€	Ref.	€	Ref.	€	Ref.	€	Ref.	€
Aluminum 100 x 100 Aluminio 100 x 100	<b>ME01089</b>	3.410	<b>ME01090</b>	10.689	<b>ME01092</b>	4.694	<b>ME01093</b>	4.070	<b>ME01094</b>	4.038
kg	81		160		160		81		81	
2 boxes / bultos  m3	0.61		3.45		3.45		0.61		0.61	

High Table  
2600 x 1200

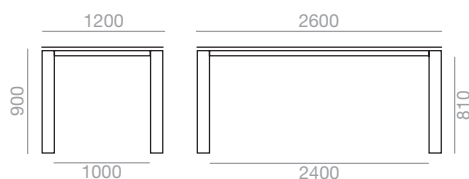

\*\*\*Marble shiny upcharge  
Incremento por mármol brillo | 30 |

SERIE  
600

\*Matte lacquered and premium upcharge  
\*Incremento por lacado mate y premium | 342 |

Legs Patatas	Table top / Sobre							
	*Oak Roble		Lacquered Lacado		Low Iron Glass Cristal óptico		Compacto HPL Compacto HPL	
	Ref.	€	Ref.	€	Ref.	€	Ref.	€
Aluminum 100 x 100 Aluminio 100 x 100	ME01095	3.339	ME01096	3.110	ME01098	4.328	ME01099	3.609
kg	90		90		135		92	
2 boxes / bultos  m3	0.7		0.7		3.45		0.7	

Legs Patatas	Table top / Sobre									
	Laminate Laminado		***M3 Marble Mármol M3		***M1 Marble Mármol M1		Ultra-matte Ultramate		Linoleum Linóleo	
	Ref.	€	Ref.	€	Ref.	€	Ref.	€	Ref.	€
Aluminum 100 x 100 Aluminio 100 x 100	ME01100	3.534	ME01101	10.762	ME01103	5.029	ME01104	4.193	ME01105	4.167
kg	90		190		190		90		90	
2 boxes / bultos  m3	0.7		4		4		0.7		0.7	

High Table  
2800 x 1000

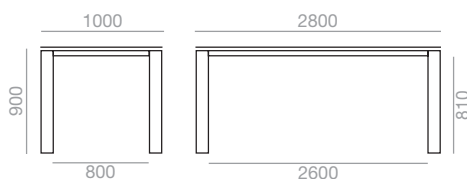

\*\*\*Marble shiny upcharge  
Incremento por mármol brillo

30

SERIE 600

\*Matte lacquered and premium upcharge

\*Incremento por lacado mate y premium

324

Legs Patas	Table top / Sobre									
	*Oak Roble		Lacquered Lacado		Low Iron Glass Cristal óptico		Technical Stone Technical Stone		Compacto HPL Compacto HPL	
	Ref.	€	Ref.	€	Ref.	€	Ref.	€	Ref.	€
Aluminum 100 x 100 Aluminio 100 x 100	ME01106	3.413	ME01107	3.163	ME01109	4.300	ME01110	3.431	ME01111	3.639
kg	97		97		125		99		98	
2 boxes / bultos  m3	0.65		0.69		4		0.65		0.65	

Legs Patas	Table top / Sobre									
	Laminate Laminado		***M3 Marble Mármol M3		***M1 Marble Mármol M1		Ultra-matte Ultramate		Linoleum Linóleo	
	Ref.	€	Ref.	€	Ref.	€	Ref.	€	Ref.	€
Aluminum 100 x 100 Aluminio 100 x 100	ME01112	3.519	ME01113	10.784	ME01115	5.551	ME01116	4.176	ME01117	4.149
kg	97		192		192		97		97	
2 boxes / bultos  m3	0.65		3.68		3.68		0.65		0.65	

High Table  
2800 x 1200

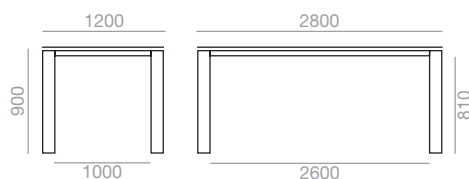

\*\*\*Marble shiny upcharge  
Incremento por mármol brillo | 30 |

SERIE  
600

\*Matte lacquered and premium upcharge  
\*Incremento por lacado mate y premium | 359 |

Legs Patatas	Table top / Sobre							
	*Oak Roble		Lacquered Lacado		Low Iron Glass Cristal óptico		Compacto HPL Compacto HPL	
	Ref.	€	Ref.	€	Ref.	€	Ref.	€
Aluminum 100 x 100 Aluminio 100 x 100	ME01118	3.605	ME01119	3.312	ME01121	4.633	ME01122	3.801
kg	95		95		142		96	
2 boxes / bultos  m3	0.75		0.75		4.29		0.75	

Legs Patatas	Table top / Sobre									
	Laminate Laminado		***M3 Marble Mármol M3		***M1 Marble Mármol M1		Ultra-matte Ultramate		Linoleum Linóleo	
	Ref.	€	Ref.	€	Ref.	€	Ref.	€	Ref.	€
Aluminum 100 x 100 Aluminio 100 x 100	ME01123	3.647	ME01124	10.874	ME01126	6.048	ME01127	4.306	ME01128	4.281
kg	95		205		205		95		95	
2 boxes / bultos  m3	0.75		4.29		4.29		0.75		0.75	

High Table  
3000 x 1000

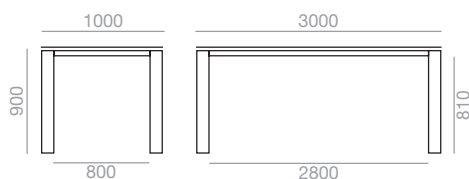

SERIE  
600

\*\*\*Marble shiny  
upcharge  
Incremento por  
mármol brillo

30

\*Matte lacquered  
and premium  
upcharge

\*Incremento por  
lacado mate y  
premium

335

Legs Patas	Table top / Sobre									
	*Oak Roble		Lacquered Lacado		Low Iron Glass Cristal óptico		Technical Stone Technical Stone		Compacto HPL Compacto HPL	
	Ref.	€	Ref.	€	Ref.	€	Ref.	€	Ref.	€
Aluminum 100 x 100 Aluminio 100 x 100	ME01129	3.563	ME01130	3.361	ME01132	4.467	ME01133	3.522	ME01134	3.571
kg	90		90		131		92		91	
2 boxes / bultos  m3	0.69		0.69		3.93		0.69		0.69	

Legs Patas	Table top / Sobre					
	Laminate Laminado		Ultra-matte Ultramate		Linoleum Linóleo	
	Ref.	€	Ref.	€	Ref.	€
Aluminum 100 x 100 Aluminio 100 x 100	ME01135	3.626	ME01136	4.284	ME01137	4.380
kg	90		90		90	
2 boxes / bultos  m3	0.69		0.69		0.69	

High Table  
3000 x 1200

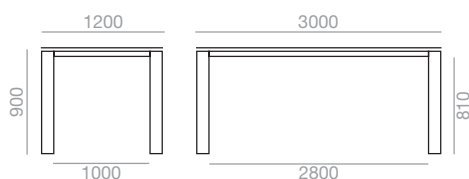

SERIE  
600

\*\*\*Marble shiny upcharge  
Incremento por mármol brillo | 30 |

\*Matte lacquered and premium upcharge  
\*Incremento por lacado mate y premium | 377 |

Legs Patatas	Table top / Sobre							
	*Oak Roble		Lacquered Lacado		Low Iron Glass Cristal óptico		Compacto HPL Compacto HPL	
	Ref.	€	Ref.	€	Ref.	€	Ref.	€
Aluminum 100 x 100 Aluminio 100 x 100	ME01138	3.765	ME01139	3.513	ME01141	5.075	ME01142	3.648
kg	97		97		150		98	
2 boxes / bultos  m3	0.79		0.79		4.57		0.79	

Legs Patatas	Table top / Sobre					
	Laminate Laminado		Ultra-matte Ultramate		Linoleum Linóleo	
	Ref.	€	Ref.	€	Ref.	€
Aluminum 100 x 100 Aluminio 100 x 100	ME01143	3.695	ME01144	4.355	ME01145	4.455
kg	97		97		97	
2 boxes / bultos  m3	0.79		0.79		0.79	



High Table  
3200 x 1200

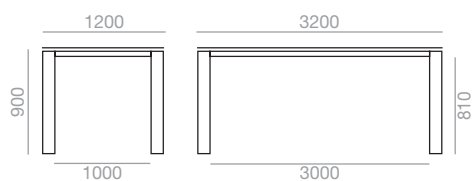

\*\*\*Marble shiny upcharge  
Incremento por mármol brillo | 30 |

SERIE  
600

\*Matte lacquered and premium upcharge  
\*Incremento por lacado mate y premium | 395 |

Legs Patas	Table top / Sobre					
	*Oak Roble		Lacquered Lacado		Compacto HPL Compacto HPL	
	Ref.	€	Ref.	€	Ref.	€
Aluminum 100 x 100 Aluminio 100 x 100	ME01146	4.319	ME01147	3.978	ME01148	4.375
kg	105		105		106	
2 boxes / bultos  m3	0.84		0.84		0.84	

High Table  
3400 x 1200

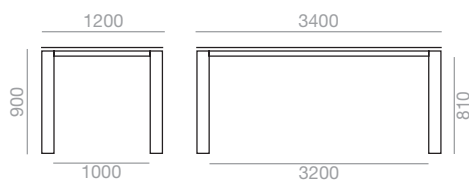

\*\*\*Marble shiny upcharge  
Incremento por mármol brillo | 30 |

SERIE  
600

\*Matte lacquered and premium upcharge  
\*Incremento por lacado mate y premium | 419 |

Legs Patas	Table top / Sobre					
	*Oak Roble		Lacquered Lacado		Compacto HPL Compacto HPL	
	Ref.	€	Ref.	€	Ref.	€
Aluminum 100 x 100 Aluminio 100 x 100	ME01149	4.695	ME01150	4.118	ME01151	4.603
kg	110		110		111	
2 boxes / bultos  m3	0.88		0.88		0.88	

**High Table**  
**1400 x 1400**



\*\*\*Marble shiny upcharge  
Incremento por mármol brillo | 30 |

SERIE  
600

\*Matte lacquered and premium upcharge  
\*Incremento por lacado mate y premium | 395 |

Legs Patatas	Table top / Sobre							
	*Oak Roble		Lacquered Lacado		Low Iron Glass Cristal óptico		Compacto HPL Compacto HPL	
	Ref.	€	Ref.	€	Ref.	€	Ref.	€
Aluminum 100 x 100 Aluminio 100 x 100	ME01152	2.661	ME01153	2.435	ME01155	3.421	ME01156	2.679
kg	68		68		96		69	
2 boxes / bultos  m3	0.48		0.48		1.3		0.48	

Legs Patatas	Table top / Sobre									
	Laminate Laminado		***M3 Marble Mármol M3		***M1 Marble Mármol M1		Ultra-matte Ultramate		Linoleum Linóleo	
	Ref.	€	Ref.	€	Ref.	€	Ref.	€	Ref.	€
Aluminum 100 x 100 Aluminio 100 x 100	ME01157	2.696	ME01158	6.440	ME01160	4.153	ME01161	3.170	ME01162	3.064
kg	68		124		124		68		68	
2 boxes / bultos  m3	0.48		2.65		2.65		0.48		0.48	

High Table  
1400 x 900

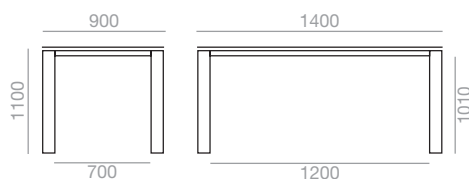

\*\*\*Marble shiny upcharge  
Incremento por mármol brillo

30

SERIE  
600

\*Matte lacquered and premium upcharge

\*Incremento por lacado mate y premium

230

Legs Patas	Table top / Sobre									
	*Oak Roble		Lacquered Lacado		Low Iron Glass Cristal óptico		Technical Stone Technical Stone		Compacto HPL Compacto HPL	
	Ref.	€	Ref.	€	Ref.	€	Ref.	€	Ref.	€
Aluminum 100 x 100 Aluminio 100 x 100	ME01163	2.441	ME01164	2.410	ME01166	2.941	ME01167	2.470	ME01168	2.538
kg	54		54		72		56		55	
2 boxes / bultos m3	0.37		0.37		0.94		0.37		0.37	

Legs Patas	Table top / Sobre									
	Laminate Laminado		***M3 Marble Mármol M3		***M1 Marble Mármol M1		Ultra-matte Ultramate		Linoleum Linóleo	
	Ref.	€	Ref.	€	Ref.	€	Ref.	€	Ref.	€
Aluminum 100 x 100 Aluminio 100 x 100	ME01169	2.574	ME01170	6.344	ME01172	3.728	ME01173	2.870	ME01174	2.875
kg	54		81		81		54		54	
2 boxes / bultos m3	0.37		1.87		1.87		0.37		0.37	

High Table  
1600 x 900

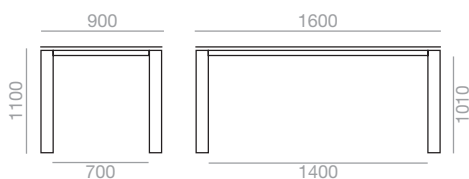

\*\*\*Marble shiny upcharge  
Incremento por mármol brillo | 30 |

SERIE  
600

\*Matte lacquered and premium upcharge  
\*Incremento por lacado mate y premium | 246 |

Legs Patas	Table top / Sobre									
	*Oak Roble		Lacquered Lacado		Low Iron Glass Cristal óptico		Technical Stone Technical Stone		Compacto HPL Compacto HPL	
	Ref.	€	Ref.	€	Ref.	€	Ref.	€	Ref.	€
Aluminum 100 x 100 Aluminio 100 x 100	ME01175	2.620	ME01176	2.518	ME01178	3.071	ME01179	2.543	ME01180	2.712
kg	58.5		58.5		76		61		60	
2 boxes / bultos m3	0.41		0.41		1.04		2.09		0.41	

Legs Patas	Table top / Sobre									
	Laminate Laminado		***M3 Marble Mármol M3		***M1 Marble Mármol M1		Ultra-matte Ultramate		Linoleum Linóleo	
	Ref.	€	Ref.	€	Ref.	€	Ref.	€	Ref.	€
Aluminum 100 x 100 Aluminio 100 x 100	ME01181	2.765	ME01182	6.765	ME01184	3.953	ME01185	3.275	ME01186	3.223
kg	60		92		92		59		59	
2 boxes / bultos m3	0.41		2.09		2.09		0.41		0.41	

High Table  
1800 x 900

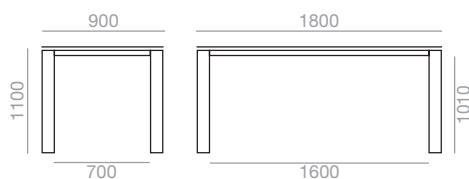

\*\*\*Marble shiny upcharge  
Incremento por mármol brillo | 30 |

SERIE 600

\*Matte lacquered and premium upcharge  
\*Incremento por lacado mate y premium | 264 |

Legs Patas	Table top / Sobre									
	*Oak Roble		Lacquered Lacado		Low Iron Glass Cristal óptico		Technical Stone Technical Stone		Compacto HPL Compacto HPL	
	Ref.	€	Ref.	€	Ref.	€	Ref.	€	Ref.	€
Aluminum 100 x 100 Aluminio 100 x 100	ME01187	2.722	ME01188	2.607	ME01190	3.468	ME01191	2.708	ME01192	2.840
kg	63		63		85		65		64	
2 boxes / bultos m3	0.44		0.44		1.14		2.31		0.44	

Legs Patas	Table top / Sobre									
	Laminate Laminado		***M3 Marble Mármol M3		***M1 Marble Mármol M1		Ultra-matte Ultramate		Linoleum Linóleo	
	Ref.	€	Ref.	€	Ref.	€	Ref.	€	Ref.	€
Aluminum 100 x 100 Aluminio 100 x 100	ME01193	2.867	ME01194	7.342	ME01196	4.079	ME01197	3.341	ME01198	3.366
kg	64		102		102		63		63	
2 boxes / bultos m3	0.44		2.31		2.31		0.44		0.44	

High Table  
2000 x 1000

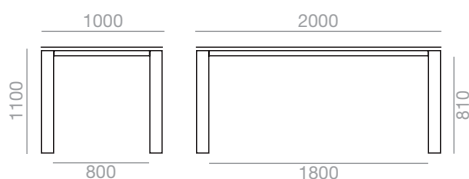

SERIE  
600

\*\*\*Marble shiny  
upcharge  
Incremento por  
mármol brillo

30

\*Matte lacquered  
and premium  
upcharge

\*Incremento por  
lacado mate y  
premium

282

Legs Patas	Table top / Sobre									
	*Oak Roble		Lacquered Lacado		Low Iron Glass Cristal óptico		Technical Stone Technical Stone		Compacto HPL Compacto HPL	
	Ref.	€	Ref.	€	Ref.	€	Ref.	€	Ref.	€
Aluminum 100 x 100 Aluminio 100 x 100	ME01199	2.917	ME01200	2.692	ME01202	3.569	ME01203	3.018	ME01204	2.928
kg	71		71		99		73		72	
2 boxes / bultos  m3	0.51		0.51		1.35		2.75		0.51	

Legs Patas	Table top / Sobre									
	Laminate Laminado		***M3 Marble Mármol M3		***M1 Marble Mármol M1		Ultra-matte Ultramate		Linoleum Linóleo	
	Ref.	€	Ref.	€	Ref.	€	Ref.	€	Ref.	€
Aluminum 100 x 100 Aluminio 100 x 100	ME01205	3.003	ME01206	10.391	ME01208	4.417	ME01209	3.472	ME01210	3.564
kg	71		126		126		71		71	
2 boxes / bultos  m3	0.51		2.75		2.75		0.51		0.51	

High Table  
2200 x 1000

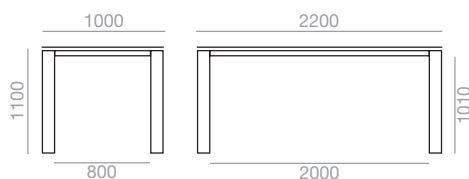

\*\*\*Marble shiny upcharge  
Incremento por mármol brillo | 30 |

SERIE  
600

\*Matte lacquered and premium upcharge  
\*Incremento por lacado mate y premium | 302 |

Legs Patas	Table top / Sobre									
	*Oak Roble		Lacquered Lacado		Low Iron Glass Cristal óptico		Technical Stone Technical Stone		Compacto HPL Compacto HPL	
	Ref.	€	Ref.	€	Ref.	€	Ref.	€	Ref.	€
Aluminum 100 x 100 Aluminio 100 x 100	ME01211	3.068	ME01212	2.882	ME01214	3.830	ME01215	3.180	ME01216	3.225
kg	74.5		74.5		105		77		76	
2 boxes / bultos  m3	0.55		0.55		1.46		2.99		0.55	

Legs Patas	Table top / Sobre									
	Laminate Laminado		***M3 Marble Mármol M3		***M1 Marble Mármol M1		Ultra-matte Ultramate		Linoleum Linóleo	
	Ref.	€	Ref.	€	Ref.	€	Ref.	€	Ref.	€
Aluminum 100 x 100 Aluminio 100 x 100	ME01217	3.212	ME01218	10.748	ME01220	4.903	ME01221	3.738	ME01222	3.706
kg	75		137		137		75		75	
2 boxes / bultos  m3	0.5		2.99		2.99		0.55		0.55	



High Table  
2400 x 1000

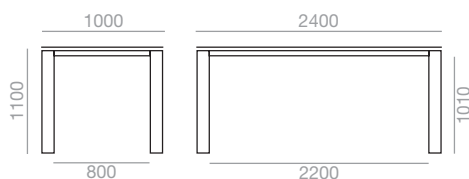

\*\*\*Marble shiny upcharge  
Incremento por mármol brillo

30

SERIE  
600

\*Matte lacquered and premium upcharge

\*Incremento por lacado mate y premium

311

Legs Patas	Table top / Sobre									
	*Oak Roble		Lacquered Lacado		Low Iron Glass Cristal óptico		Technical Stone Technical Stone		Compacto HPL Compacto HPL	
	Ref.	€	Ref.	€	Ref.	€	Ref.	€	Ref.	€
Aluminum 100 x 100 Aluminio 100 x 100	ME01223	3.160	ME01224	2.966	ME01226	3.811	ME01227	3.200	ME01228	3.410
kg	79		79		112		81		80	
2 boxes / bultos  m3	0.59		0.59		1.58		3.23		0.59	

Legs Patas	Table top / Sobre									
	Laminate Laminado		***M3 Marble Mármol M3		***M1 Marble Mármol M1		Ultra-matte Ultramate		Linoleum Linóleo	
	Ref.	€	Ref.	€	Ref.	€	Ref.	€	Ref.	€
Aluminum 100 x 100 Aluminio 100 x 100	ME01229	3.285	ME01230	10.961	ME01232	5.282	ME01233	3.928	ME01234	3.803
kg	79		150		150		79		79	
2 boxes / bultos  m3	0.59		3.23		3.23		0.59		0.59	

High Table  
2400 x 1200

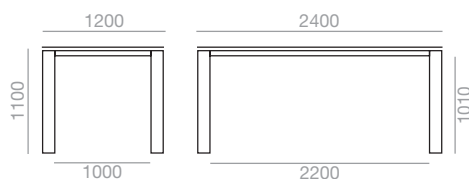

\*\*\*Marble shiny upcharge  
Incremento por mármol brillo

30

SERIE  
600

\*Matte lacquered and premium upcharge

\*Incremento por lacado mate y premium

321

Legs Patas	Table top / Sobre							
	*Oak Roble		Lacquered Lacado		Low Iron Glass Cristal óptico		Compacto HPL Compacto HPL	
	Ref.	€	Ref.	€	Ref.	€	Ref.	€
Aluminum 100 x 100 Aluminio 100 x 100	ME01235	3.332	ME01236	3.082	ME01238	4.083	ME01239	3.566
kg	87		87		127		89	
2 boxes / bultos  m3	0.68		0.68		3.75		0.68	

Legs Patas	Table top / Sobre									
	Laminate Laminado		***M3 Marble Mármol M3		***M1 Marble Mármol M1		Ultra-matte Ultramate		Linoleum Linóleo	
	Ref.	€	Ref.	€	Ref.	€	Ref.	€	Ref.	€
Aluminum 100 x 100 Aluminio 100 x 100	ME01240	3.413	ME01241	11.056	ME01243	5.676	ME01244	4.056	ME01245	3.922
kg	87		177		177		87		87	
2 boxes / bultos  m3	0.68		3.75		3.75		0.68		0.68	

High Table  
2600 x 1000

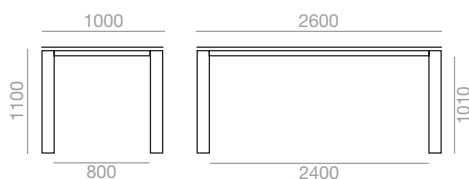

SERIE  
600

\*\*\*Marble shiny  
upcharge  
Incremento por  
mármol brillo

30

\*Matte lacquered  
and premium  
upcharge

\*Incremento por  
lacado mate y  
premium

317

Legs Patas	Table top / Sobre									
	*Oak Roble		Lacquered Lacado		Low Iron Glass Cristal óptico		Technical Stone Technical Stone		Compacto HPL Compacto HPL	
	Ref.	€	Ref.	€	Ref.	€	Ref.	€	Ref.	€
Aluminum 100 x 100 Aluminio 100 x 100	ME01246	3.295	ME01247	3.091	ME01249	4.089	ME01250	3.405	ME01251	3.574
kg	83		83		119		85		84	
2 boxes / bultos  m3	0.63		0.63		3.47		3.47		0.63	

Legs Patas	Table top / Sobre									
	Laminate Laminado		***M3 Marble Mármol M3		***M1 Marble Mármol M1		Ultra-matte Ultramate		Linoleum Linóleo	
	Ref.	€	Ref.	€	Ref.	€	Ref.	€	Ref.	€
Aluminum 100 x 100 Aluminio 100 x 100	ME01252	3.555	ME01253	11.132	ME01255	4.891	ME01256	4.239	ME01257	4.126
kg	83		162		162		83		83	
2 boxes / bultos  m3	0.63		3.47		3.47		0.63		0.63	

High Table  
2600 x 1200

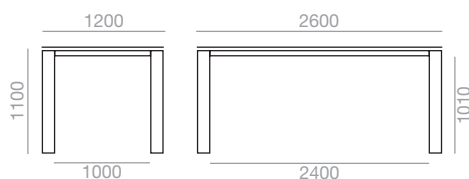

\*\*\*Marble shiny upcharge  
Incremento por mármol brillo | 30 |

SERIE  
600

\*Matte lacquered and premium upcharge  
\*Incremento por lacado mate y premium | 342 |

Legs Patas	Table top / Sobre							
	*Oak Roble		Lacquered Lacado		Low Iron Glass Cristal óptico		Compacto HPL Compacto HPL	
	Ref.	€	Ref.	€	Ref.	€	Ref.	€
Aluminum 100 x 100 Aluminio 100 x 100	ME01258	3.480	ME01259	3.239	ME01261	4.417	ME01262	3.760
kg	92		92		137		93	
2 boxes / bultos  m3	0.72		0.72		4.03		0.72	

Legs Patas	Table top / Sobre									
	Laminate Laminado		***M3 Marble Mármol M3		***M1 Marble Mármol M1		Ultra-matte Ultramate		Linoleum Linóleo	
	Ref.	€	Ref.	€	Ref.	€	Ref.	€	Ref.	€
Aluminum 100 x 100 Aluminio 100 x 100	ME01263	3.682	ME01264	11.213	ME01266	5.238	ME01267	4.368	ME01268	4.259
kg	92		192		192		92		92	
2 boxes / bultos  m3	0.72		4.03		4.03		0.72		0.72	

High Table  
2800 x 1000

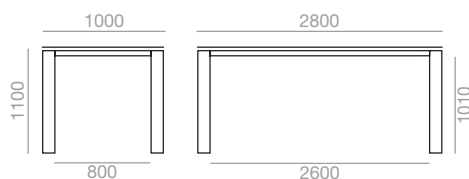

\*\*\*Marble shiny upcharge  
Incremento por mármol brillo | 30 |

SERIE  
600

\*Matte lacquered and premium upcharge  
\*Incremento por lacado mate y premium | 324 |

Legs Patas	Table top / Sobre									
	*Oak Roble		Lacquered Lacado		Low Iron Glass Cristal óptico		Technical Stone Technical Stone		Compacto HPL Compacto HPL	
	Ref.	€	Ref.	€	Ref.	€	Ref.	€	Ref.	€
Aluminum 100 x 100 Aluminio 100 x 100	ME01269	3.558	ME01270	3.295	ME01272	4.356	ME01273	3.476	ME01274	3.789
kg	99		99		127		101		100	
2 boxes / bultos m3	0.67		0.67		3.71		3.71		0.67	

Legs Patas	Table top / Sobre									
	Laminate Laminado		***M3 Marble Mármol M3		***M1 Marble Mármol M1		Ultra-matte Ultramate		Linoleum Linóleo	
	Ref.	€	Ref.	€	Ref.	€	Ref.	€	Ref.	€
Aluminum 100 x 100 Aluminio 100 x 100	ME01275	3.665	ME01276	11.235	ME01278	5.783	ME01279	4.350	ME01280	4.240
kg	99		194		194		99		99	
2 boxes / bultos m3	0.67		3.71		3.71		0.67		0.67	

High Table  
2800 x 1200

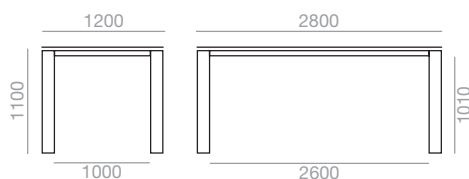

\*\*\*Marble shiny upcharge  
Incremento por mármol brillo | 30 |

SERIE  
600

\*Matte lacquered and premium upcharge  
\*Incremento por lacado mate y premium | 359 |

Legs Patas	Table top / Sobre							
	*Oak Roble		Lacquered Lacado		Low Iron Glass Cristal óptico		Compacto HPL Compacto HPL	
	Ref.	€	Ref.	€	Ref.	€	Ref.	€
Aluminum 100 x 100 Aluminio 100 x 100	ME01281	3.757	ME01282	3.450	ME01284	4.801	ME01285	3.958
kg	97		97		144		99	
2 boxes / bultos  m3	0.76		0.76		4.31		0.76	

Legs Patas	Table top / Sobre									
	Laminate Laminado		***M3 Marble Mármol M3		***M1 Marble Mármol M1		Ultra-matte Ultramate		Linoleum Linóleo	
	Ref.	€	Ref.	€	Ref.	€	Ref.	€	Ref.	€
Aluminum 100 x 100 Aluminio 100 x 100	ME01286	3.797	ME01287	11.327	ME01289	6.303	ME01290	4.481	ME01291	4.376
kg	97		207		207		97		97	
2 boxes / bultos  m3	0.76		4.31		4.31		0.76		0.76	

**High Table**  
**3000 x 1000**

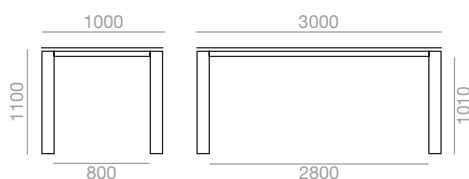

SERIE  
600

\*\*\*Marble shiny upcharge  
Incremento por mármol brillo

30

\*Matte lacquered and premium upcharge

\*Incremento por lacado mate y premium

335

Legs Patas	Table top / Sobre									
	*Oak Roble		Lacquered Lacado		Low Iron Glass Cristal óptico		Technical Stone Technical Stone		Compacto HPL Compacto HPL	
	Ref.	€	Ref.	€	Ref.	€	Ref.	€	Ref.	€
Aluminum 100 x 100 Aluminio 100 x 100	ME01292	3.710	ME01293	3.434	ME01295	4.655	ME01296	3.668	ME01297	3.720
kg	92		92		133		94		93	
2 boxes / bultos  m3	0.7		0.76		3.92		3.92		0.7	

Legs Patas	Table top / Sobre					
	Laminate Laminado		Ultra-matte Ultramate		Linoleum Linóleo	
	Ref.	€	Ref.	€	Ref.	€
Aluminum 100 x 100 Aluminio 100 x 100	ME01298	3.777	ME01299	4.464	ME01300	4.438
kg	92		92		92	
2 boxes / bultos  m3	0.7		0.7		0.7	

High Table  
3000 x 1200

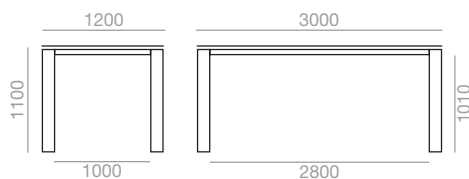

SERIE  
600

\*\*\*Marble shiny upcharge  
Incremento por mármol brillo | 30 |

\*Matte lacquered and premium upcharge  
\*Incremento por lacado mate y premium | 377 |

Legs Patas	Table top / Sobre							
	*Oak Roble		Lacquered Lacado		Low Iron Glass Cristal óptico		Compacto HPL Compacto HPL	
	Ref.	€	Ref.	€	Ref.	€	Ref.	€
Aluminum 100 x 100 Aluminio 100 x 100	ME01301	3.917	ME01302	3.588	ME01304	5.103	ME01305	3.802
kg	99		99		152		101	
2 boxes / bultos  m3	0.81		0.81		4.59		0.81	

Legs Patas	Table top / Sobre					
	Laminate Laminado		Ultra-matte Ultramate		Linoleum Linóleo	
	Ref.	€	Ref.	€	Ref.	€
Aluminum 100 x 100 Aluminio 100 x 100	ME01306	3.850	ME01307	4.536	ME01308	4.514
kg	99		99		99	
2 boxes / bultos  m3	0.81		0.81		0.81	



**High Table**  
**3200 x 1200**

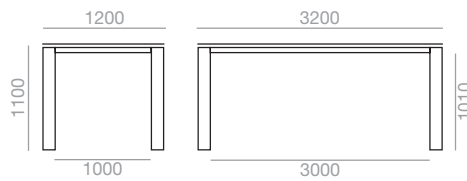

\*\*\*Marble shiny upcharge  
Incremento por mármol brillo | 30 |

SERIE 600

\*Matte lacquered and premium upcharge  
\*Incremento por lacado mate y premium | 395 |

Legs Patas	Table top / Sobre					
	*Oak Roble		Lacquered Lacado		Compacto HPL Compacto HPL	
	Ref.	€	Ref.	€	Ref.	€
Aluminum 100 x 100 Aluminio 100 x 100	ME01309	4.498	ME01310	4.144	ME01311	4.556
kg	107		107		108	
2 boxes / bultos  m3	0.86		0.86		0.86	

**High Table**  
**3400 x 1200**

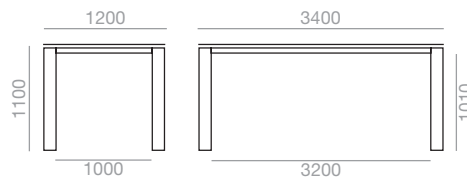

\*\*\*Marble shiny upcharge  
Incremento por mármol brillo | 30 |

SERIE 600

\*Matte lacquered and premium upcharge  
\*Incremento por lacado mate y premium | 419 |

Legs Patas	Table top / Sobre					
	*Oak Roble		Lacquered Lacado		Compacto HPL Compacto HPL	
	Ref.	€	Ref.	€	Ref.	€
Aluminum 100 x 100 Aluminio 100 x 100	ME01312	4.891	ME01313	4.290	ME01314	4.794
kg	112		112		113	
2 boxes / bultos  m3	0.9		0.9		0.9	

High Table  
1400 x 1400

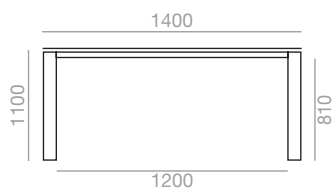

\*\*\*Marble shiny upcharge  
Incremento por mármol brillo | 30 |

SERIE 600

\*Matte lacquered and premium upcharge  
\*Incremento por lacado mate y premium | 395 |

Legs Patatas	Table top / Sobre							
	*Oak Roble		Lacquered Lacado		Low Iron Glass Cristal óptico		Compacto HPL Compacto HPL	
	Ref.	€	Ref.	€	Ref.	€	Ref.	€
Aluminum 100 x 100 Aluminio 100 x 100	ME01315	2.721	ME01316	2.490	ME01318	3.468	ME01319	2.792
kg	70		70		98		71	
2 boxes / bultos  m3	0.5		0.5		1.31		0.5	

Legs Patatas	Table top / Sobre									
	Laminate Laminado		***M3 Marble Mármol M3		***M1 Marble Mármol M1		Ultra-matte Ultramate		Linoleum Linóleo	
	Ref.	€	Ref.	€	Ref.	€	Ref.	€	Ref.	€
Aluminum 100 x 100 Aluminio 100 x 100	ME01320	2.808	ME01321	6.706	ME01323	4.326	ME01324	3.302	ME01325	3.192
kg	70		126		126		70		70	
2 boxes / bultos  m3	0.5		3		3		0.5		0.5	

## Maximum table heights Alturas máximas de mesa

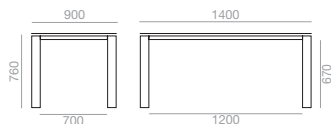

Table top / Sobre			
*Oak Roble	Lacquered Lacado	Low Iron Glass Cristal óptico	Compacto HPL Compacto HPL
758	758	750	752

Table top / Sobre				
Laminate Laminado	***M3 Marble Mármol M3	***M1 Marble Mármol M1	Ultra-matte Ultramate	Linoleum Linóleo
758	760	760	758	758

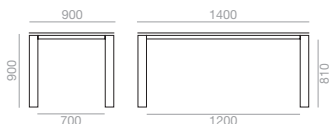

Table top / Sobre			
*Oak Roble	Lacquered Lacado	Low Iron Glass Cristal óptico	Compacto HPL Compacto HPL
898	898	890	892

Table top / Sobre				
Laminate Laminado	***M3 Marble Mármol M3	***M1 Marble Mármol M1	Ultra-matte Ultramate	Linoleum Linóleo
898	900	900	898	898

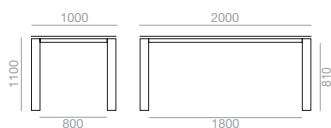
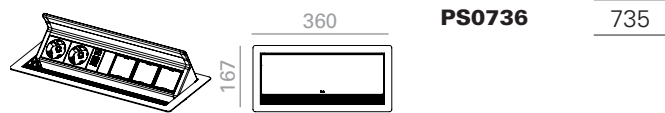
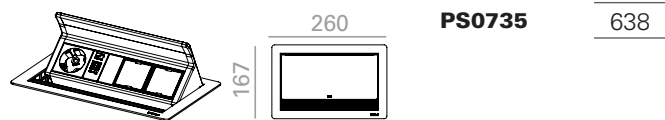

Table top / Sobre			
*Oak Roble	Lacquered Lacado	Low Iron Glass Cristal óptico	Compacto HPL Compacto HPL
1098	1098	1090	1092

Table top / Sobre				
Laminate Laminado	***M3 Marble Mármol M3	***M1 Marble Mármol M1	Ultra-matte Ultramate	Linoleum Linóleo
1098	1100	1100	1098	1098

**PS-IN SURFACE**



**PS-QI**



**PS-INTREGATED**

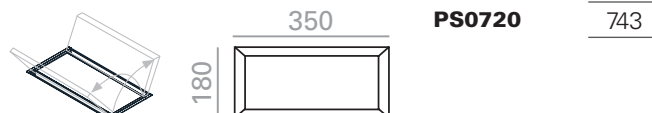
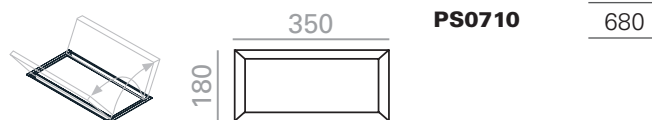

**Preinstalled (Optional) / Preinstalación (Opcional)  
IN0006**

First installation / Primera instalación	<u>270</u>
Second and more installations / Segunda y más instalaciones	<u>90</u>

**IN-SURFACE POWER BOXES  
CAJAS DE CONEXIONES DENTRO DEL SOBRE**

Aluminum power box mounted in the table top with a folding protective lid. It is served in anodized silver, black or white, for other finishing, contact the Customer Department. There are two power system sizes available and data slots can be customized according to the below diagram.

Caja de conexiones de aluminio integrada dentro de la superficie del sobre con tapa abatible. Se sirve en color anodizado plata, negro o blanco, para otros acabados consultar al Departamento Comercial. Se ofrecen dos tamaños de caja diferentes y con conectividad configurable, acorde al siguiente esquema:

**PS0735**

**PS0736**

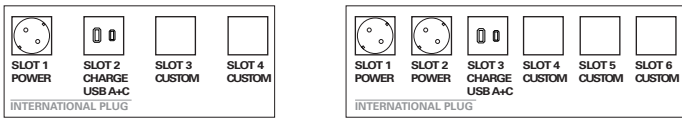
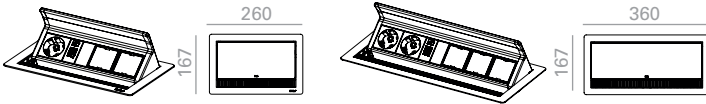

CHOOSE DATA PORT FOR DATA CUSTOM PORT SLOTS

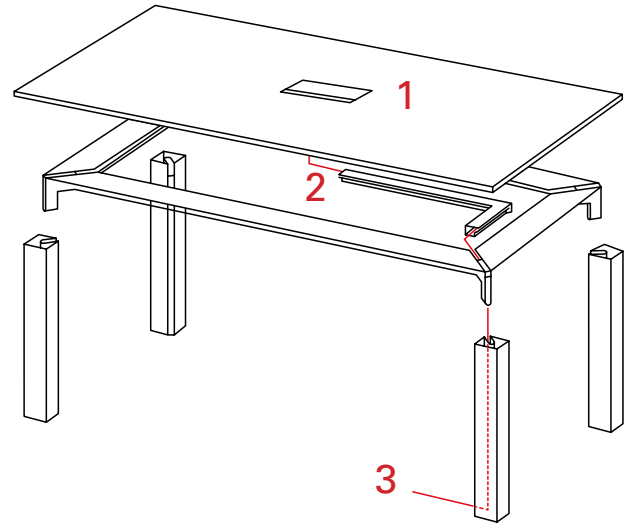
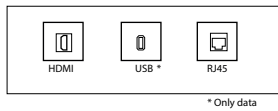

**1 POWER BOXES DISTRIBUTION DISTRIBUCIÓN DE SISTEMAS**

By standard, the position of the system will be in the central of the table, placed horizontally. When there are two system boxes, these will be separated 1/3 between them and placed horizontally. For other options, please contact the Customer Department.

De serie, la disposición del sistema será en el centro de la mesa y en sentido longitudinal. Cuando se disponga de dos sistemas, estos se colocarán con una separación de 1/3 de la longitud total de la mesa, y en sentido longitudinal. Otras opciones consultar con el Departamento Comercial.

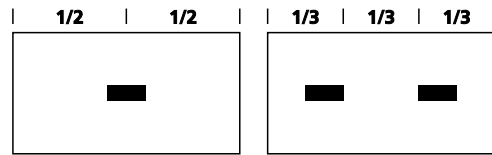

**OPTIONAL PREINSTALLED WIRING  
PREINSTALACIÓN DEL CABLEADO**

**IN0006**

Preinstalled wiring consists in the addition of the necessary mechanisms to integrate power systems in the table, so that wiring is hidden until the way out in the floor. Necessary grommet are included and 3m cable (from the power system). For other cable dimensions contact the Customer Department. Preinstalled wiring is available for aluminum legs, Delta and 100x100 square legs. In wooden legs cable way out is placed in center of the table.

La preinstalación consiste en el montaje de los mecanismos necesarios para integrar el sistema de electrificación en la mesa, de modo que el cableado quede oculto hasta su salida por la base. Se incluyen los pasacables necesarios y 3 metros de cable (midiéndolo desde el sistema de conexiones). Para otras medidas de cable consultar al Departamento Comercial. Puede preinstalarse el cableado en las mesas Extra con patas de aluminio, Delta o cuadradas de 100x100. En las patas de madera la salida del cable se situa en la parte central de la mesa.

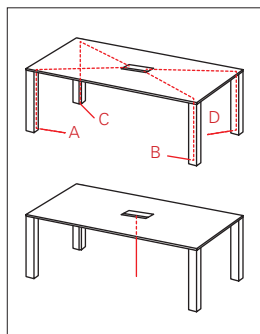

The distribution of electricity is entirely configurable; the exit for the cables can be placed inside any leg (A, B, C or D). Please specify the Customer Departmente which leg is to have the cables with reference to the view of the table in the diagram b

La distribución de la electrificación es totalmente configurable; la salida de cables puede situarse en la pata que se desee (A, B, C o D). Especificar al Departamento Comercial en que pata de la mesa desea que se sitúe el cable (ver dibujo).

**2 WIRING MANAGEMENT GESTIÓN DEL CABLEADO**

Wire pass through an aluminum grommet keeping it hidden. By default color is silver, for other finishings ask the Customer Department.

El cable se pasa a través de un perfil pasacables de aluminio que lo mantiene oculto. Su color de serie es el plata, para otros acabados consultar al Departamento Comercial.

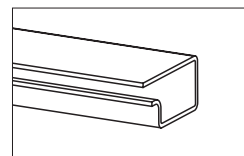

**3 CABLE WAY OUT SALIDA DE CABLEADO**

The cable way out can be performed directly from the power system or thru a canal in the base bottom, so that is hidden until it gets to the floor.

La salida del cable se realiza directamente desde el propio sistema como por unas canalizaciones en la parte inferior de la base, de modo que el cable queda oculto hasta llegar al suelo.

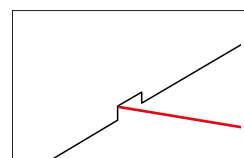

**INTEGRATED POWER BOXES  
CAJAS DE CONEXIONES INTEGRADAS**

The black finish is integrated with the top. Its opening is towards both sides.

El acabado negro está integrado con la parte superior. Su apertura es hacia ambos lados.

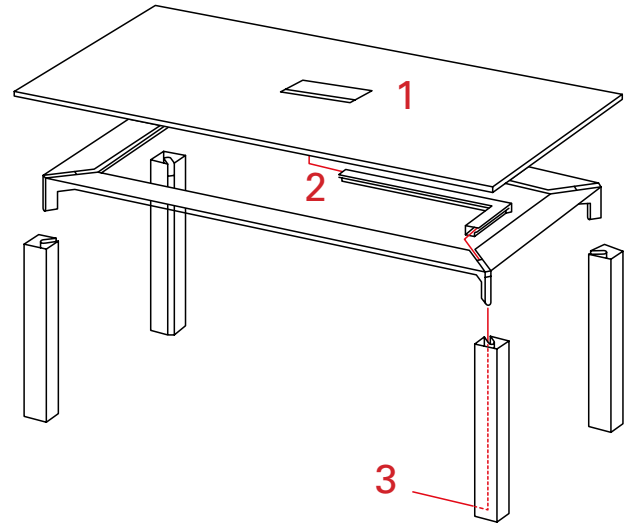

**1 POWER BOXES DISTRIBUTION DISTRIBUCIÓN DE SISTEMAS**

By standard, the position of the system will be in the central of the table, placed horizontally. When there are two system boxes, these will be separated 1/3 between them and placed horizontally. For other options, please contact the Customer Department.

De serie, la disposición del sistema será en el centro de la mesa y en sentido longitudinal. Cuando se disponga de dos sistemas, estos se colocarán con una separación de 1/3 de la longitud total de la mesa, y en sentido longitudinal. Otras opciones consultar con el Departamento Comercial.

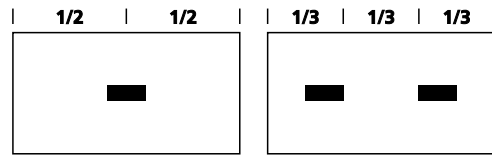

**2 WIRING MANAGEMENT GESTIÓN DEL CABLEADO**

Wire pass through an aluminum grommet keeping it hidden. By default color is silver, for other finishings ask the Customer Department.

El cable se pasa a través de un perfil pasacables de aluminio que lo mantiene oculto. Su color de serie es el plata, para otros acabados consultar al Departamento Comercial.

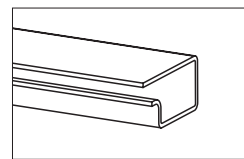

**3 CABLE WAY OUT SALIDA DE CABLEADO**

The cable way out can be performed directly from the power system or thru a canal in the base bottom, so that is hidden until it gets to the floor.

La salida del cable se realiza directamente desde el propio sistema como por unas canalizaciones en la parte inferior de la base, de modo que el cable queda oculto hasta llegar al suelo.

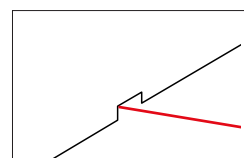

**PS0710**

**PS0720**

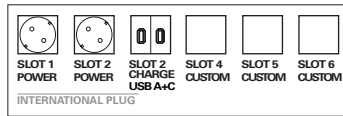
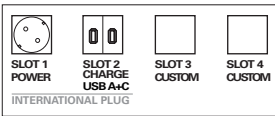
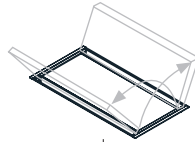
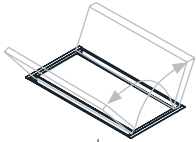

CHOOSE DATA PORT FOR DATA CUSTOM PORT SLOTS

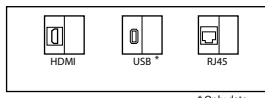

**OPTIONAL PREINSTALLED WIRING  
PREINSTALACIÓN DEL CABLEADO**

**IN0006**

Preinstalled wiring consists in the addition of the necessary mechanisms to integrate power systems in the table, so that wiring is hidden until the way out in the floor. Necessary grommet are included and 3m cable (from the power system). For other cable dimensions contact the Customer Department. Preinstalled wiring is available for aluminum legs, Delta and 100x100 square legs. In wooden legs cable way out is placed in center of the table.

La preinstalación consiste en el montaje de los mecanismos necesarios para integrar el sistema de electrificación en la mesa, de modo que el cableado quede oculto hasta su salida por la base. Se incluyen los pasacables necesarios y 3 metros de cable (midiendo desde el sistema de conexiones). Para otras medidas de cable consultar al Departamento Comercial. Puede preinstalarse el cableado en las mesas Extra con patas de aluminio, Delta o cuadradas de 100x100. En las patas de madera la salida del cable se situa en la parte central de la mesa.

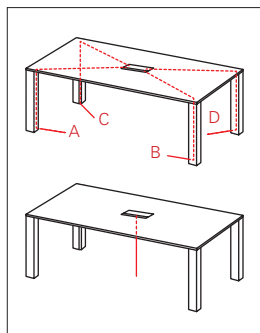

The distribution of electricity is entirely configurable; the exit for the cables can be placed inside any leg (A, B, C or D). Please specify the Customer Departmente which leg is to have the cables with reference to the view of the table in the diagram b

La distribución de la electrificación es totalmente configurable; la salida de cables puede situarse en la pata que se desee (A, B, C o D). Especificar al Departamento Comercial en que pata de la mesa desea que se sitúe el cable (ver dibujo).

**IN-SURFACE POWER BOXES  
CAJAS DE CONEXIONES DENTRO DEL SOBRE**

It is a data dynamo with 2 amp dual charging USB. Available in two finishes: black or white.

Es una dínamo de datos con 2 amp de carga dual USB. Disponible en dos acabados: negro o blanco.

**PS0804**

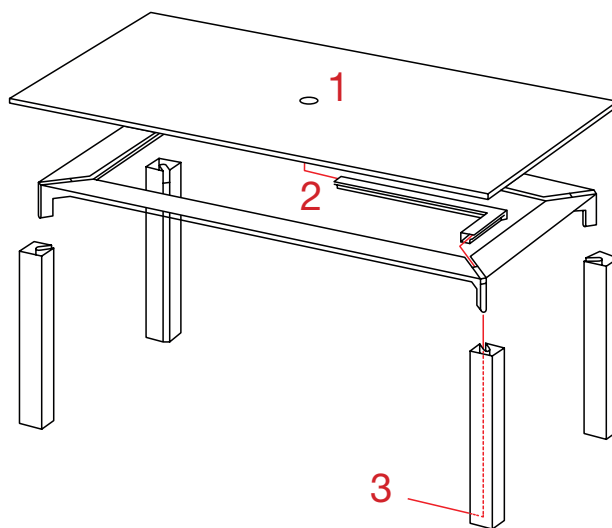
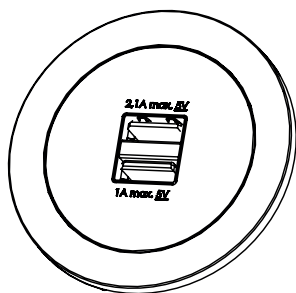

**1 POWER BOXES DISTRIBUTION DISTRIBUCIÓN DE SISTEMAS**

By standard, the position of the system will be in the central of the table, placed horizontally. When there are two system boxes, these will be separated 1/3 between them and placed horizontally. For other options, please contact the Customer Department.

De serie, la disposición del sistema será en el centro de la mesa y en sentido longitudinal. Cuando se disponga de dos sistemas, estos se colocarán con una separación de 1/3 de la longitud total de la mesa, y en sentido longitudinal. Otras opciones consultar con el Departamento Comercial.

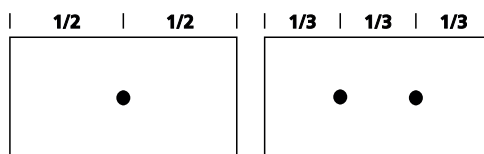

**OPTIONAL PREINSTALLED WIRING  
PREINSTALACIÓN DEL CABLEADO**

**IN0006**

Preinstalled wiring consists in the addition of the necessary mechanisms to integrate power systems in the table, so that wiring is hidden until the way out in the floor. Necessary grommet are included and 3m cable (from the power system). For other cable dimensions contact the Customer Department. Preinstalled wiring is available for aluminum legs, Delta and 100x100 square legs. In wooden legs cable way out is placed in center of the table.

La preinstalación consiste en el montaje de los mecanismos necesarios para integrar el sistema de electrificación en la mesa, de modo que el cableado quede oculto hasta su salida por la base. Se incluyen los pasacables necesarios y 3 metros de cable (midiendo desde el sistema de conexiones). Para otras medidas de cable consultar al Departamento Comercial. Puede preinstalarse el cableado en las mesas Extra con patas de aluminio, Delta o cuadradas de 100x100. En las patas de madera la salida del cable se situa en la parte central de la mesa.

The distribution of electricity is entirely configurable; the exit for the cables can be placed inside any leg (A, B, C or D). Please specify the Customer Departmente which leg is to have the cables with reference to the view of the table in the diagram b

La distribución de la electrificación es totalmente configurable; la salida de cables puede situarse en la pata que se desee (A, B, C o D). Especificar al Departamento Comercial en que pata de la mesa desea que se sitúe el cable (ver dibujo).

**2 WIRING MANAGEMENT GESTIÓN DEL CABLEADO**

Wire pass through an aluminum grommet keeping it hidden. By default color is silver, for other finishings ask the Customer Department.

El cable se pasa a través de un perfil pasacables de aluminio que lo mantiene oculto. Su color de serie es el plata, para otros acabados consultar al Departamento Comercial.

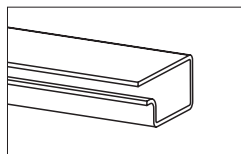

**3 CABLE WAY OUT SALIDA DE CABLEADO**

The cable way out can be performed directly from the power system or thru a canal in the base bottom, so that is hidden until it gets to the floor.

La salida del cable se realiza directamente desde el propio sistema como por unas canalizaciones en la parte inferior de la base, de modo que el cable queda oculto hasta llegar al suelo.

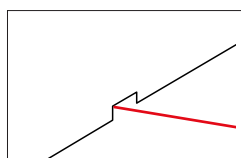







**Description**  
**Descripción**

Table program available with different types of bases and table tops. Bases of 4 aluminum legs, with square, round or delta shape, available in anodized brown, anodized silver, matte white and matte black or 4 oak legs.

Programa de mesas disponible con diferentes tipos de bases y sobretes de mesa. Bases de 4 patas de aluminio, con forma cuadrada, redonda o delta, disponibles en acabado anodizado marrón, anodizado plata, blanco mate y negro mate o de 4 patas de madera maciza de roble.

**Wood finish Oak**  
**Acabado madera**  
**Roble**



**Wood lacquer finish**  
**Acabado laca**  
**madera**

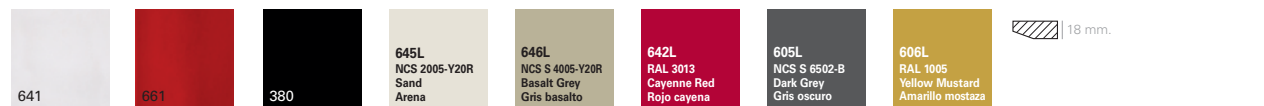

**Laminated**  
**Laminado**

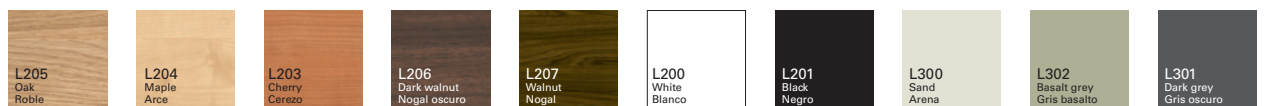

**Compacto HPL finish**  
**Acabado Compacto**  
**HPL**

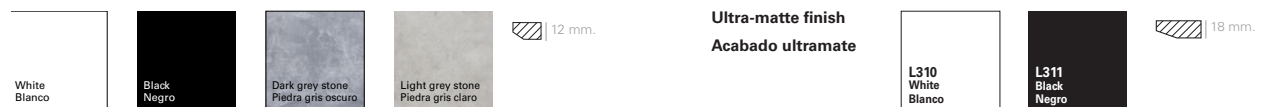

**Linoleum finish**  
**Acabado linóleo**



**M1 marble finish**  
**Acabado de mármol**  
**M1**



**M3 marble finish**  
**Acabado de mármol**  
**M3**

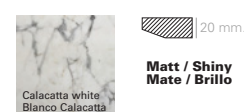

**Aluminum finish**  
**Acabado aluminio**



**Glass finish**  
**Acabado de cristal**

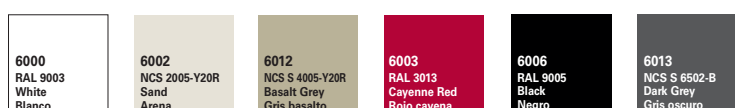

**Power box**  
**Caja de conexiones**



**Certificates**  
**Certificados**

Quality - Resistance  
Calidad - Resistencia

UNE EN 15372

**Intellectual property Propiedad intelectual**

All our collections are protected by international industrial design registries, designs patents, copyrights and intellectual Property laws. Unauthorized use of AW International Property is a criminal offence and can lead to prosecution.  
Todas nuestras colecciones están protegidas por registros de diseño industrial, diseño de patente, copyright y derechos de propiedad intelectual en todo el mundo. El uso no autorizado de los diseños y propiedad intelectual de AW supone un delito que puede ser sometido a acción judicial.



## ME01330

3000 x 1500

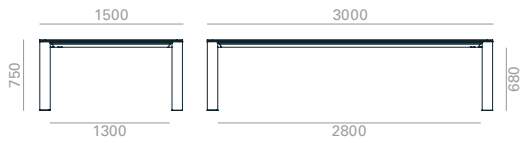

Legs Patas	Table top / Sobre				
	*Oak Roble	Lacquered Lacado	Low Iron Glass Cristal óptico	Technical Stone 8	Compacto HPL
	€	€	€	€	€
Aluminum 100 x 100 Aluminio 100 x 100	4.111	3.348	5.223	5.409	3.795
kg	133	133	133	133	133
2 boxes / bultos  m3	1.29	1.29	1.29	1.29	1.29

Legs Patas	Table top / Sobre				
	Laminate Laminado	Ultra-matte Ultramate	Linoleum Linóleo	***M1 Marble Mármol M1	***M3 Marble Mármol M3
	€	€	€	€	€
Aluminum 100 x 100 Aluminio 100 x 100	3.728	4.595	4.845	7.038	9.878
kg	133	133	133	133	133
2 boxes / bultos  m3	1.29	1.29	1.29	1.29	1.29

SERIE 600		360				Epoxy finish upcharge Incremento acabado epoxi		24				Oak legs upcharge Incremento patas de roble		473		***Marble shiny upcharge Incremento por mármol brillo		30	
--------------	--	-----	--	--	--	---	--	----	--	--	--	--	--	-----	--	---	--	----	--

ME01331

3000 x 1500

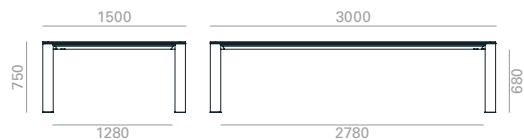

Legs Patas	Table top / Sobre				
	*Oak Roble	Lacquered Lacado	Low Iron Glass Cristal óptico	Technical Stone 8	Compacto HPL
Aluminum Ø110 Aluminio Ø110	€ 3.957	€ 3.194	€ 5.315	€ 5.422	€ 3.643
kg	133	133	133	133	133
2 boxes / bultos  m3	1.29	1.29	1.29	1.29	1.29

Legs Patas	Table top / Sobre				
	Laminate Laminado	Ultra-matte Ultramate	Linoleum Linóleo	***M1 Marble Mármol M1	***M3 Marble Mármol M3
Aluminum Ø110 Aluminio Ø110	€ 3.574	€ 4.443	€ 4.692	€ 7.068	€ 9.909
kg	133	133	133	133	133
2 boxes / bultos  m3	1.29	1.29	1.29	1.29	1.29

SERIE 600		360				Epoxy finish upcharge Incremento acabado epoxi		21				Oak legs upcharge Incremento patas de roble		491		***Marble shiny upcharge Incremento por mármol brillo		30	
--------------	--	-----	--	--	--	---	--	----	--	--	--	--	--	-----	--	---	--	----	--

ME01332

3000 x 1500

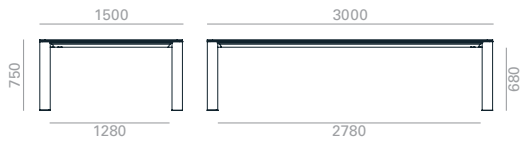

Legs Patas	Table top / Sobre				
	*Oak Roble	Lacquered Lacado	Low Iron Glass Cristal óptico	Technical Stone 8	Compacto HPL
	€	€	€	€	€
Delta aluminum 100 x 100 Aluminio delta 100 x 100	3.951	3.188	5.308	5.414	3.635
kg	133	133	133	133	133
2 boxes / bultos  m3	1.29	1.29	1.29	1.29	1.29

Legs Patas	Table top / Sobre				
	Laminate Laminado	Ultra-matte Ultramate	Linoleum Linóleo	***M1 Marble Mármol M1	***M3 Marble Mármol M3
	€	€	€	€	€
Delta aluminum 100 x 100 Aluminio delta 100 x 100	3.568	4.435	4.685	7.062	9.902
kg	133	133	133	133	133
2 boxes / bultos  m3	1.29	1.29	1.29	1.29	1.29

SERIE 600		360				Epoxy finish upcharge Incremento acabado epoxi		20				Oak legs upcharge Incremento patas de roble		462		***Marble shiny upcharge Incremento por mármol brillo		30	
--------------	--	-----	--	--	--	---	--	----	--	--	--	--	--	-----	--	---	--	----	--

## ME01333

### 3500 x 1500

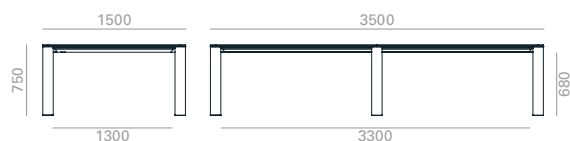

Legs Patas	Table top / Sobre				
	*Oak Roble	Lacquered Lacado	Low Iron Glass Cristal óptico	Technical Stone 8	Compacto HPL
Aluminum 100 x 100 Aluminio 100 x 100	5.378	4.509	7.014	7.228	5.011
kg	162	162	162	162	162
2 boxes / bultos  m3	1.54	1.54	1.54	1.54	1.54

Legs Patas	Table top / Sobre				
	Laminate Laminado	Ultra-matte Ultramate	Linoleum Linóleo	***M1 Marble Mármol M1	***M3 Marble Mármol M3
Aluminum 100 x 100 Aluminio 100 x 100	4.934	5.949	6.217	9.174	12.488
kg	162	162	162	162	162
2 boxes / bultos  m3	1.54	1.54	1.54	1.54	1.54

SERIE 600		420				Epoxy finish upcharge Incremento acabado epoxi		33				Oak legs upcharge Incremento patas de roble		674		***Marble shiny upcharge Incremento por mármol brillo		30	
--------------	--	-----	--	--	--	---	--	----	--	--	--	--	--	-----	--	---	--	----	--

ME01334

3500 x 1500

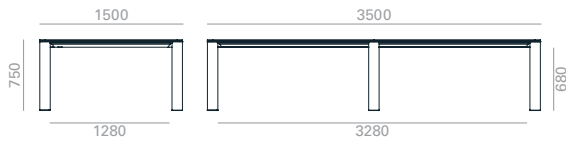

Legs Patas	Table top / Sobre				
	*Oak Roble	Lacquered Lacado	Low Iron Glass Cristal óptico	Technical Stone 8	Compacto HPL
	€	€	€	€	€
Aluminum Ø110 Aluminio Ø110	5.149	4.280	7.071	7.163	4.783
kg	162	162	162	162	162
2 boxes / bultos  m3	1.54	1.54	1.54	1.54	1.54

Legs Patas	Table top / Sobre				
	Laminate Laminado	Ultra-matte Ultramate	Linoleum Linóleo	***M1 Marble Mármol M1	***M3 Marble Mármol M3
	€	€	€	€	€
Aluminum Ø110 Aluminio Ø110	4.705	5.720	5.988	9.126	12.440
kg	162	162	162	162	162
2 boxes / bultos  m3	1.54	1.54	1.54	1.54	1.54

SERIE 600		420				27				716		30	

\*Matte lacquered and premium upcharge  
 \*Incremento por lacado mate y premium  
 Epoxy finish upcharge  
 Incremento acabado epoxi  
 Oak legs upcharge  
 Incremento patas de roble  
 \*\*\*Marble shiny upcharge  
 Incremento por mármol brillo

ME01335

3500 x 1500



Legs Patas	Table top / Sobre				
	*Oak Roble	Lacquered Lacado	Low Iron Glass Cristal óptico	Technical Stone 8	Compacto HPL
	€	€	€	€	€
Delta aluminum 100 x 100 Aluminio delta 100 x 100	5.138	4.269	7.058	7.152	4.771
kg	162	162	162	162	162
2 boxes / bultos  m3	1.54	1.54	1.54	1.54	1.54

Legs Patas	Table top / Sobre				
	Laminate Laminado	Ultra-matte Ultramate	Linoleum Linóleo	***M1 Marble Mármol M1	***M3 Marble Mármol M3
	€	€	€	€	€
Delta aluminum 100 x 100 Aluminio delta 100 x 100	4.694	5.709	5.977	9.115	12.429
kg	162	162	162	162	162
2 boxes / bultos  m3	1.54	1.54	1.54	1.54	1.54

SERIE 600		420				27				666		30	

\*Matte lacquered and premium upcharge  
 \*Incremento por lacado mate y premium  
 Epoxy finish upcharge  
 Incremento acabado epoxi  
 Oak legs upcharge  
 Incremento patas de roble  
 \*\*\*Marble shiny upcharge  
 Incremento por mármol brillo

## ME01336

4000 x 1500

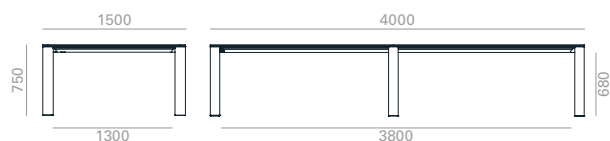

Legs Patas	Table top / Sobre				
	*Oak Roble	Lacquered Lacado	Low Iron Glass Cristal óptico	Technical Stone 8	Compacto HPL
	€	€	€	€	€
Aluminum 100 x 100 Aluminio 100 x 100	5.832	4.865	7.592	7.802	5.411
kg	182	182	182	182	182
2 boxes / bultos  m3	1.75	1.75	1.75	1.75	1.75

Legs Patas	Table top / Sobre				
	Laminate Laminado	Ultra-matte Ultramate	Linoleum Linóleo	***M1 Marble Mármol M1	***M3 Marble Mármol M3
	€	€	€	€	€
Aluminum 100 x 100 Aluminio 100 x 100	5.325	6.480	6.772	10.018	13.805
kg	182	182	182	182	182
2 boxes / bultos  m3	1.75	1.75	1.75	1.75	1.75

SERIE 600		480				Epoxy finish upcharge Incremento acabado epoxi		33				Oak legs upcharge Incremento patas de roble		674		***Marble shiny upcharge Incremento por mármol brillo		30	
--------------	--	-----	--	--	--	---	--	----	--	--	--	--	--	-----	--	---	--	----	--



## ME01337

4000 x 1500

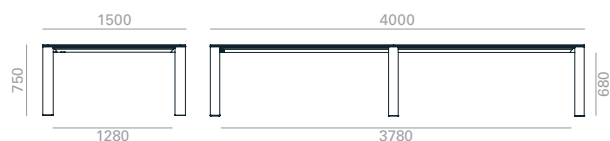

Legs Patas	Table top / Sobre				
	*Oak Roble	Lacquered Lacado	Low Iron Glass Cristal óptico	Technical Stone 8	Compacto HPL
	€	€	€	€	€
Aluminum Ø110 Aluminio Ø110	5.603	4.637	7.689	7.737	5.029
kg	182	182	182	182	182
2 boxes / bultos  m3	1.75	1.75	1.75	1.75	1.75

Legs Patas	Table top / Sobre				
	Laminate Laminado	Ultra-matte Ultramate	Linoleum Linóleo	***M1 Marble Mármol M1	***M3 Marble Mármol M3
	€	€	€	€	€
Aluminum Ø110 Aluminio Ø110	5.095	6.251	6.543	9.971	13.758
kg	182	182	182	182	182
2 boxes / bultos  m3	1.75	1.75	1.75	1.75	1.75

SERIE 600		480				27				716		30	

\*Matte lacquered and premium upcharge  
\*Incremento por lacado mate y premium

Epoxy finish upcharge  
Incremento acabado epoxi

Oak legs upcharge  
Incremento patas de roble

\*\*\*Marble shiny upcharge  
Incremento por mármol brillo

## ME01338

### 4000 x 1500



Legs Patas	Table top / Sobre				
	*Oak Roble	Lacquered Lacado	Low Iron Glass Cristal óptico	Technical Stone 8	Compacto HPL
	€	€	€	€	€
Delta aluminum 100 x 100 Aluminio delta 100 x 100	5.592	4.625	7.678	7.726	5.171
kg	182	182	182	182	182
2 boxes / bultos  m3	1.75	1.75	1.75	1.75	1.75

Legs Patas	Table top / Sobre				
	Laminate Laminado	Ultra-matte Ultramate	Linoleum Linóleo	***M1 Marble Mármol M1	***M3 Marble Mármol M3
	€	€	€	€	€
Delta aluminum 100 x 100 Aluminio delta 100 x 100	5.085	6.240	6.532	9.960	13.748
kg	182	182	182	182	182
2 boxes / bultos  m3	1.75	1.75	1.75	1.75	1.75

SERIE 600		480				27				666		30	

\*Matte lacquered and premium upcharge  
\*Incremento por lacado mate y premium

Epoxy finish upcharge  
Incremento acabado epoxi

Oak legs upcharge  
Incremento patas de roble

\*\*\*Marble shiny upcharge  
Incremento por mármol brillo

## ME01339

4500 x 1500

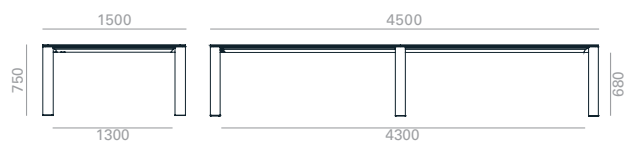

Legs Patas	Table top / Sobre				
	*Oak Roble	Lacquered Lacado	Low Iron Glass Cristal óptico	Technical Stone 8	Compacto HPL
Aluminum 100 x 100 Aluminio 100 x 100	€ 6.289	€ 5.215	€ 8.122	€ 8.326	€ 5.815
kg	202	202	202	202	202
2 boxes / bultos  m3	1.96	1.96	1.96	1.96	1.96

Legs Patas	Table top / Sobre				
	Laminate Laminado	Ultra-matte Ultramate	Linoleum Linóleo	***M1 Marble Mármol M1	***M3 Marble Mármol M3
Aluminum 100 x 100 Aluminio 100 x 100	€ 5.720	€ 7.022	€ 7.332	€ 10.802	€ 15.063
kg	202	202	202	202	202
2 boxes / bultos  m3	1.96	1.96	1.96	1.96	1.96

SERIE 600		540				Epoxy finish upcharge Incremento acabado epoxi		33				Oak legs upcharge Incremento patas de roble		674		***Marble shiny upcharge Incremento por mármol brillo		30	
--------------	--	-----	--	--	--	---	--	----	--	--	--	--	--	-----	--	---	--	----	--

## ME01340

4500 x 1500

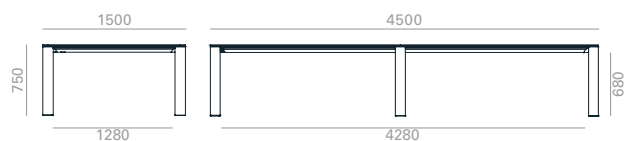

Legs Patas	Table top / Sobre				
	*Oak Roble	Lacquered Lacado	Low Iron Glass Cristal óptico	Technical Stone 8	Compacto HPL
	€	€	€	€	€
Aluminum Ø110 Aluminio Ø110	6.060	4.986	8.260	8.269	5.586
kg	202	202	202	202	202
1 box / bulto  m3	1.96	1.96	1.96	1.96	1.96

Legs Patas	Table top / Sobre				
	Laminate Laminado	Ultra-matte Ultramate	Linoleum Linóleo	***M1 Marble Mármol M1	***M3 Marble Mármol M3
	€	€	€	€	€
Aluminum Ø110 Aluminio Ø110	5.491	6.792	7.103	10.755	15.015
kg	202	202	202	202	202
1 box / bulto  m3	1.96	1.96	1.96	1.96	1.96

SERIE 600	*Matte lacquered and premium upcharge *Incremento por lacado mate y premium	540		Epoxy finish upcharge Incremento acabado epoxi	27		Oak legs upcharge Incremento patas de roble	716	***Marble shiny upcharge Incremento por mármol brillo	30
--------------	--	-----	--	---	----	--	--	-----	---	----

## ME01341

4500 x 1500



Legs Patas	Table top / Sobre				
	*Oak Roble	Lacquered Lacado	Low Iron Glass Cristal óptico	Technical Stone 8	Compacto HPL
	€	€	€	€	€
Delta aluminum 100 x 100 Aluminio delta 100 x 100	6.049	4.975	8.248	8.258	5.575
kg	202	202	202	202	202
1 box / bulto  m3	1.96	1.96	1.96	1.96	1.96

Legs Patas	Table top / Sobre				
	Laminate Laminado	Ultra-matte Ultramate	Linoleum Linóleo	***M1 Marble Mármol M1	***M3 Marble Mármol M3
	€	€	€	€	€
Delta aluminum 100 x 100 Aluminio delta 100 x 100	5.480	6.782	7.092	10.745	15.005
kg	202	202	202	202	202
1 box / bulto  m3	1.96	1.96	1.96	1.96	1.96

SERIE 600		540			Epoxy finish upcharge Incremento acabado epoxi		27			Oak legs upcharge Incremento patas de roble		666		***Marble shiny upcharge Incremento por mármol brillo		30	
--------------	--	-----	--	--	---	--	----	--	--	--	--	-----	--	---	--	----	--

## ME01342

### 5000 x 1500



Legs Patas	Table top / Sobre				
	*Oak Roble	Lacquered Lacado	Low Iron Glass Cristal óptico	Technical Stone 8	Compacto HPL
	€	€	€	€	€
Aluminum 100 x 100 Aluminio 100 x 100	6.737	5.557	8.714	8.915	6.212
kg	222	222	222	222	222
1 box / bulto  m3	2.16	2.16	2.16	2.16	2.16

Legs Patas	Table top / Sobre				
	Laminate Laminado	Ultra-matte Ultramate	Linoleum Linóleo	***M1 Marble Mármol M1	***M3 Marble Mármol M3
	€	€	€	€	€
Aluminum 100 x 100 Aluminio 100 x 100	6.106	7.555	7.883	11.662	16.395
kg	222	222	222	222	222
1 box / bulto  m3	2.16	2.16	2.16	2.16	2.16

SERIE 600		600				Epoxy finish upcharge Incremento acabado epoxi		33				Oak legs upcharge Incremento patas de roble		674		***Marble shiny upcharge Incremento por mármol brillo		30	
--------------	--	-----	--	--	--	---	--	----	--	--	--	--	--	-----	--	---	--	----	--

ME01343

5000 x 1500

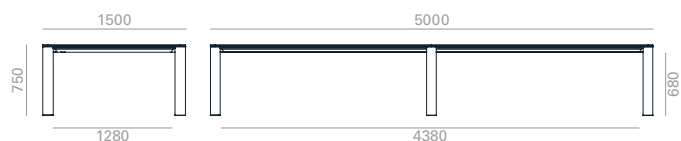

Legs Patas	Table top / Sobre				
	*Oak Roble	Lacquered Lacado	Low Iron Glass Cristal óptico	Technical Stone 8	Compacto HPL
Aluminum Ø110 Aluminio Ø110	6.508	5.328	8.894	8.905	5.983
kg	222	222	222	222	222
1 box / bulto m3	2.16	2.16	2.16	2.16	2.16

Legs Patas	Table top / Sobre				
	Laminate Laminado	Ultra-matte Ultramate	Linoleum Linóleo	***M1 Marble Mármol M1	***M3 Marble Mármol M3
Aluminum Ø110 Aluminio Ø110	5.877	7.326	7.654	11.614	16.348
kg	222	222	222	222	222
1 box / bulto m3	2.16	2.16	2.16	2.16	2.16

SERIE 600		600				Epoxy finish upcharge Incremento acabado epoxi		27				Oak legs upcharge Incremento patas de roble		716		***Marble shiny upcharge Incremento por mármol brillo		30	
--------------	--	-----	--	--	--	---	--	----	--	--	--	--	--	-----	--	---	--	----	--

## ME01344

### 5000 x 1500



Legs Patas	Table top / Sobre				
	*Oak Roble	Lacquered Lacado	Low Iron Glass Cristal óptico	Technical Stone 8	Compacto HPL
	€	€	€	€	€
Delta aluminum 100 x 100 Aluminio delta 100 x 100	6.497	5.317	8.883	8.894	5.972
kg	222	222	222	222	222
1 box / bulto  m3	2.16	2.16	2.16	2.16	2.16

Legs Patas	Table top / Sobre				
	Laminate Laminado	Ultra-matte Ultramate	Linoleum Linóleo	***M1 Marble Mármol M1	***M3 Marble Mármol M3
	€	€	€	€	€
Delta aluminum 100 x 100 Aluminio delta 100 x 100	5.866	7.315	7.643	11.603	16.337
kg	222	222	222	222	222
1 box / bulto  m3	2.16	2.16	2.16	2.16	2.16

SERIE 600		600				Epoxy finish upcharge Incremento acabado epoxi		27				Oak legs upcharge Incremento patas de roble		666		***Marble shiny upcharge Incremento por mármol brillo		30	
--------------	--	-----	--	--	--	---	--	----	--	--	--	--	--	-----	--	---	--	----	--



## ME01345

5500 x 1500



Legs Patas	Table top / Sobre				
	*Oak Roble	Lacquered Lacado	Low Iron Glass Cristal óptico	Technical Stone 8	Compacto HPL
Aluminum 100 x 100 Aluminio 100 x 100	7.175	5.883	9.131	9.494	6.598
kg	242	242	242	242	242
1 box / bulto  m3	2.37	2.37	2.37	2.37	2.37

Legs Patas	Table top / Sobre				
	Laminate Laminado	Ultra-matte Ultramate	Linoleum Linóleo	***M1 Marble Mármol M1	***M3 Marble Mármol M3
Aluminum 100 x 100 Aluminio 100 x 100	6.483	8.072	8.425	12.498	17.706
kg	242	242	242	242	242
1 box / bulto  m3	2.37	2.37	2.37	2.37	2.37

SERIE 600	600	 *Matte lacquered and premium upcharge *Incremento por lacado mate y premium	 Epoxy finish upcharge Incremento acabado epoxi	33	 Oak legs upcharge Incremento patas de roble	674	 ***Marble shiny upcharge Incremento por mármol brillo	30
--------------	-----	--	---	----	--	-----	--	----

ME01346

5500 x 1500



Legs Patas	Table top / Sobre				
	*Oak Roble	Lacquered Lacado	Low Iron Glass Cristal óptico	Technical Stone 8	Compacto HPL
	€	€	€	€	€
Aluminum Ø110 Aluminio Ø110	6.946	5.654	9.517	9.429	6.369
kg	242	242	242	242	242
1 box / bulto  m3	2.37	2.37	2.37	2.37	2.37

Legs Patas	Table top / Sobre				
	Laminate Laminado	Ultra-matte Ultramate	Linoleum Linóleo	***M1 Marble Mármol M1	***M3 Marble Mármol M3
	€	€	€	€	€
Aluminum Ø110 Aluminio Ø110	6.254	7.843	8.195	12.452	17.658
kg	242	242	242	242	242
1 box / bulto  m3	2.37	2.37	2.37	2.37	2.37

SERIE 600		600				Epoxy finish upcharge Incremento acabado epoxi		27				Oak legs upcharge Incremento patas de roble		716		***Marble shiny upcharge Incremento por mármol brillo		30	
--------------	--	-----	--	--	--	---	--	----	--	--	--	--	--	-----	--	---	--	----	--

ME01347

5500 x 1500

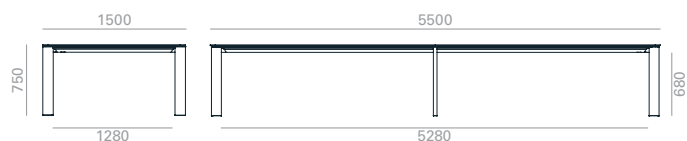

Legs Patas	Table top / Sobre				
	*Oak Roble	Lacquered Lacado	Low Iron Glass Cristal óptico	Technical Stone 8	Compacto HPL
	€	€	€	€	€
Delta aluminum 100 x 100 Aluminio delta 100 x 100	6.935	5.643	9.506	9.418	6.358
kg	242	242	242	242	242
1 box / bulto  m3	2.37	2.37	2.37	2.37	2.37

Legs Patas	Table top / Sobre				
	Laminate Laminado	Ultra-matte Ultramate	Linoleum Linóleo	***M1 Marble Mármol M1	***M3 Marble Mármol M3
	€	€	€	€	€
Delta aluminum 100 x 100 Aluminio delta 100 x 100	6.243	7.832	8.185	12.442	17.648
kg	242	242	242	242	242
1 box / bulto  m3	2.37	2.37	2.37	2.37	2.37

SERIE 600		600				Epoxy finish upcharge Incremento acabado epoxi		27				Oak legs upcharge Incremento patas de roble		666		***Marble shiny upcharge Incremento por mármol brillo		30	
--------------	--	-----	--	--	--	---	--	----	--	--	--	--	--	-----	--	---	--	----	--

## ME01348

### 6000 x 1500



Legs Patas	Table top / Sobre				
	*Oak Roble	Lacquered Lacado	Low Iron Glass Cristal óptico	Technical Stone 8	Compacto HPL
	€	€	€	€	€
Aluminum 100 x 100 Aluminio 100 x 100	7.625	6.211	9.934	10.126	6.994
kg	275	275	275	275	275
1 box / bulto  m3	2.59	2.59	2.59	2.59	2.59

Legs Patas	Table top / Sobre				
	Laminate Laminado	Ultra-matte Ultramate	Linoleum Linóleo	***M1 Marble Mármol M1	***M3 Marble Mármol M3
	€	€	€	€	€
Aluminum 100 x 100 Aluminio 100 x 100	6.869	8.606	8.975	13.402	19.083
kg	275	275	275	275	275
1 box / bulto  m3	2.59	2.59	2.59	2.59	2.59

SERIE 600		720				33				674		30	

\*Matte lacquered and premium upcharge  
\*Incremento por lacado mate y premium

Epoxy finish upcharge  
Incremento acabado epoxi

Oak legs upcharge  
Incremento patas de roble

\*\*\*Marble shiny upcharge  
Incremento por mármol brillo

## ME01349

### 6000 x 1500



Legs Patas	Table top / Sobre				
	*Oak Roble	Lacquered Lacado	Low Iron Glass Cristal óptico	Technical Stone 8	Compacto HPL
Aluminum Ø110 Aluminio Ø110	7.395	5.982	10.194	10.062	6.765
kg	275	275	275	275	275
1 box / bulto  m3	2.59	2.59	2.59	2.59	2.59

Legs Patas	Table top / Sobre				
	Laminate Laminado	Ultra-matte Ultramate	Linoleum Linóleo	***M1 Marble Mármol M1	***M3 Marble Mármol M3
Aluminum Ø110 Aluminio Ø110	6.640	8.377	8.746	13.355	19.035
kg	275	275	275	275	275
1 box / bulto  m3	2.59	2.59	2.59	2.59	2.59

SERIE 600	*Matte lacquered and premium upcharge *Incremento por lacado mate y premium	720		Epoxy finish upcharge Incremento acabado epoxi	27		Oak legs upcharge Incremento patas de roble	716	***Marble shiny upcharge Incremento por mármol brillo	30
--------------	--	-----	--	---	----	--	--	-----	---	----

## ME01350

6000 x 1500



Legs Patas	Table top / Sobre				
	*Oak Roble	Lacquered Lacado	Low Iron Glass Cristal óptico	Technical Stone 8	Compacto HPL
	€	€	€	€	€
Delta aluminum 100 x 100 Aluminio delta 100 x 100	7.383	5.971	10.183	10.051	6.754
kg	275	275	275	275	275
1 box / bulto  m3	2.59	2.59	2.59	2.59	2.59

Legs Patas	Table top / Sobre				
	Laminate Laminado	Ultra-matte Ultramate	Linoleum Linóleo	***M1 Marble Mármol M1	***M3 Marble Mármol M3
	€	€	€	€	€
Delta aluminum 100 x 100 Aluminio delta 100 x 100	6.629	8.366	8.735	13.345	19.025
kg	275	275	275	275	275
1 box / bulto  m3	2.59	2.59	2.59	2.59	2.59

SERIE 600		720			Epoxy finish upcharge Incremento acabado epoxi		27			Oak legs upcharge Incremento patas de roble		666		***Marble shiny upcharge Incremento por mármol brillo		30	
--------------	--	-----	--	--	---	--	----	--	--	--	--	-----	--	---	--	----	--

## Maximum table heights Alturas máximas de mesa

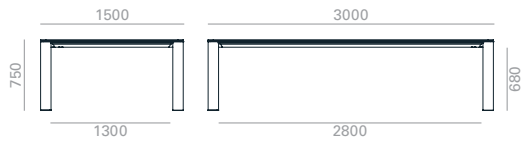
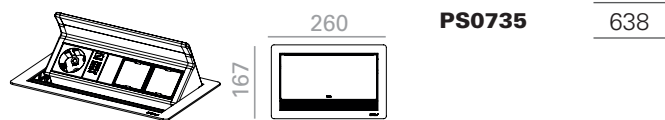

Table top / Sobre				
*Oak Roble	Lacquered Lacado	Low Iron Glass Cristal óptico	Technical Stone 8	Compacto HPL
748	748	748	748	748

Table top / Sobre				
Laminate Laminado	Ultra-matte Ultramate	Linoleum Linóleo	***M1 Marble Mármol M1	***M3 Marble Mármol M3
748	748	748	748	748

## PS-IN SURFACE



**PS0735** 638

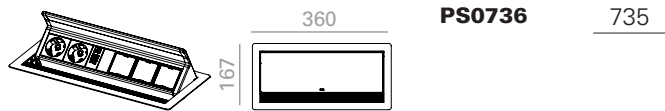

**PS0736** 735



**PS0804** 142

## PS-QI



**PS0714** 243

## PS-INTREGATED

### TOPTECH

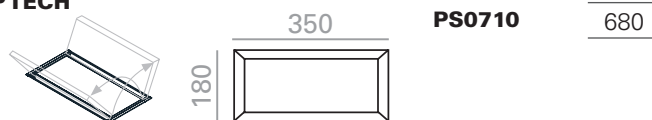

**PS0710** 680



**PS0720** 743

### Preinstalled (Optional) / Preinstalación (Opcional) IN0006

First installation / Primera instalación 270

Second and more installations / Segunda y más instalaciones 90



**IN-SURFACE POWER BOXES  
CAJAS DE CONEXIONES DENTRO DEL SOBRE**

Aluminum power box mounted in the table top with a folding protective lid. It is served in anodized silver, black or white, for other finishing, contact the Customer Department. There are two power system sizes available and data slots can be customized according to the below diagram.

Caja de conexiones de aluminio integrada dentro de la superficie del sobre con tapa abatible. Se sirve en color anodizado plata, negro o blanco, para otros acabados consultar al Departamento Comercial. Se ofrecen dos tamaños de caja diferentes y con conectividad configurable, acorde al siguiente esquema:

**PS0735**



**PS0736**

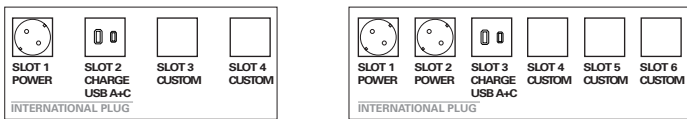

CHOOSE DATA PORT FOR DATA CUSTOM PORT SLOTS

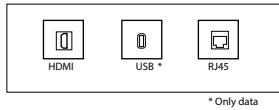

\* Only data

**OPTIONAL PREINSTALLED WIRING  
PREINSTALACIÓN DEL CABLEADO**

**IN0006**

Preinstalled wiring consists in the addition of the necessary mechanisms to integrate power systems in the table, so that wiring is hidden until the way out in the floor. Necessary grommet are included and 3m cable (from the power system). For other cable dimensions contact the Customer Department. Preinstalled wiring is available for aluminum legs, Delta and 100x100 square legs. In wooden legs cable way out is placed in center of the table.

La preinstalación consiste en el montaje de los mecanismos necesarios para integrar el sistema de electrificación en la mesa, de modo que el cableado quede oculto hasta su salida por la base. Se incluyen los pasacables necesarios y 3 metros de cable (midiéndolo desde el sistema de conexiones). Para otras medidas de cable consultar al Departamento Comercial. Puede preinstalarse el cableado en las mesas Extra con patas de aluminio, Delta o cuadradas de 100x100. En las patas de madera la salida del cable se situa en la parte central de la mesa.

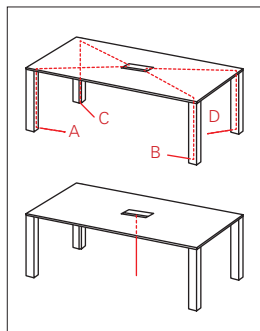

The distribution of electricity is entirely configurable; the exit for the cables can be placed inside any leg (A, B, C or D). Please specify the Customer Departmente which leg is to have the cables with reference to the view of the table in the diagram b

La distribución de la electrificación es totalmente configurable; la salida de cables puede situarse en la pata que se desee (A, B, C o D). Especificar al Departamento Comercial en que pata de la mesa desea que se sitúe el cable (ver dibujo).

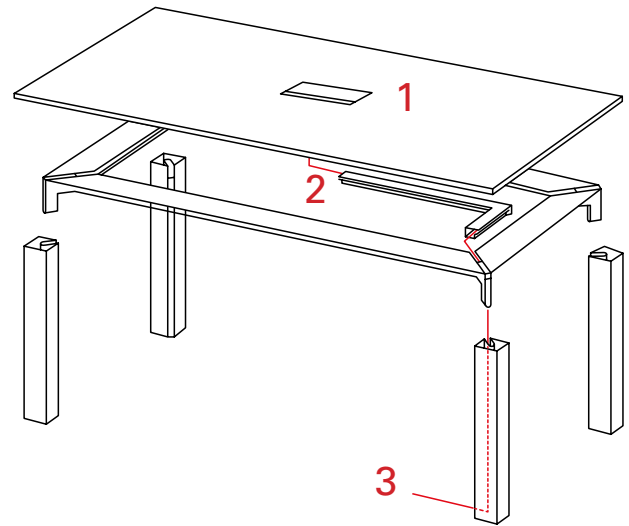

**1 POWER BOXES DISTRIBUTION DISTRIBUCIÓN DE SISTEMAS**

By standard, the position of the system will be in the central of the table, placed horizontally. When there are two system boxes, these will be separated 1/3 between them and placed horizontally. For other options, please contact the Customer Department.

De serie, la disposición del sistema será en el centro de la mesa y en sentido longitudinal. Cuando se disponga de dos sistemas, estos se colocarán con una separación de 1/3 de la longitud total de la mesa, y en sentido longitudinal. Otras opciones consultar con el Departamento Comercial.

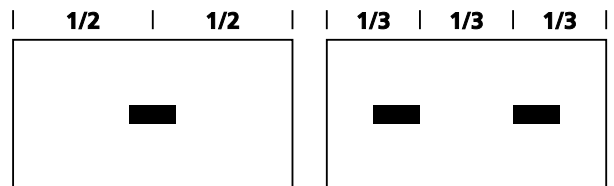

**2 WIRING MANAGEMENT GESTIÓN DEL CABLEADO**

Wire pass through an aluminum grommet keeping it hidden. By default color is silver, for other finishings ask the Customer Department.

El cable se pasa a través de un perfil pasacables de aluminio que lo mantiene oculto. Su color de serie es el plata, para otros acabados consultar al Departamento Comercial.

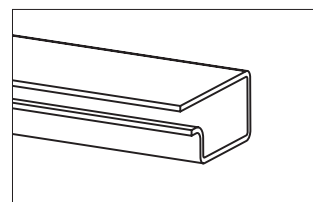

**3 CABLE WAY OUT SALIDA DE CABLEADO**

The cable way out can be performed directly from the power system or thru a canal in the base bottom, so that is hidden until it gets to the floor.

La salida del cable se realiza directamente desde el propio sistema como por unas canalizaciones en la parte inferior de la base, de modo que el cable queda oculto hasta llegar al suelo.

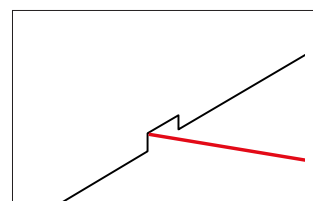

## INTEGRATED POWER BOXES CAJAS DE CONEXIONES INTEGRADAS

The black finish is integrated with the top. Its opening is towards both sides.

El acabado negro está integrado con la parte superior. Su apertura es hacia ambos lados.

PS0710

PS0720

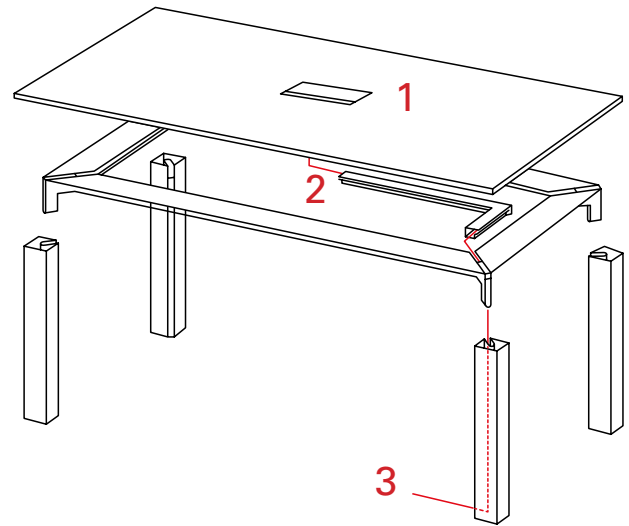
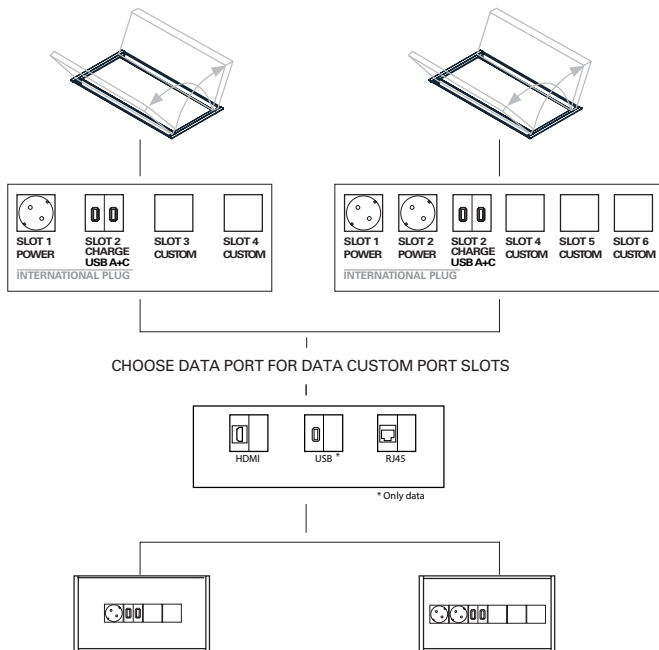

### 1 POWER BOXES DISTRIBUTION DISTRIBUCIÓN DE SISTEMAS

By standard, the position of the system will be in the central of the table, placed horizontally. When there are two system boxes, these will be separated 1/3 between them and placed horizontally. For other options, please contact the Customer Department.

De serie, la disposición del sistema será en el centro de la mesa y en sentido longitudinal. Cuando se disponga de dos sistemas, estos se colocarán con una separación de 1/3 de la longitud total de la mesa, y en sentido longitudinal. Otras opciones consultar con el Departamento Comercial.

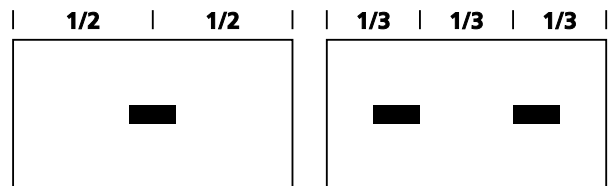

### 2 WIRING MANAGEMENT GESTIÓN DEL CABLEADO

Wire pass through an aluminum grommet keeping it hidden. By default color is silver, for other finishings ask the Customer Department.

El cable se pasa a través de un perfil pasacables de aluminio que lo mantiene oculto. Su color de serie es el plata, para otros acabados consultar al Departamento Comercial.

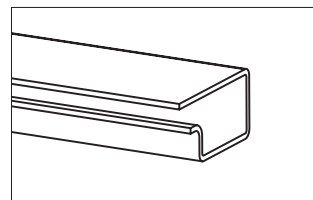

### 3 CABLE WAY OUT SALIDA DE CABLEADO

The cable way out can be performed directly from the power system or thru a canal in the base bottom, so that is hidden until it gets to the floor.

La salida del cable se realiza directamente desde el propio sistema como por unas canalizaciones en la parte inferior de la base, de modo que el cable queda oculto hasta llegar al suelo.

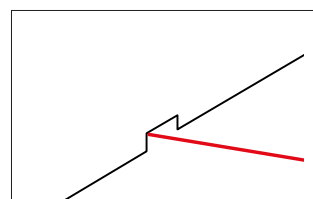

## OPTIONAL PREINSTALLED WIRING PREINSTALACIÓN DEL CABLEADO

IN0006

Preinstalled wiring consists in the addition of the necessary mechanisms to integrate power systems in the table, so that wiring is hidden until the way out in the floor. Necessary grommet are included and 3m cable (from the power system). For other cable dimensions contact the Customer Department. Preinstalled wiring is available for aluminum legs, Delta and 100x100 square legs. In wooden legs cable way out is placed in center of the table.

La preinstalación consiste en el montaje de los mecanismos necesarios para integrar el sistema de electrificación en la mesa, de modo que el cableado quede oculto hasta su salida por la base. Se incluyen los pasacables necesarios y 3 metros de cable (midiendo desde el sistema de conexiones). Para otras medidas de cable consultar al Departamento Comercial. Puede preinstalarse el cableado en las mesas Extra con patas de aluminio, Delta o cuadradas de 100x100. En las patas de madera la salida del cable se situa en la parte central de la mesa.

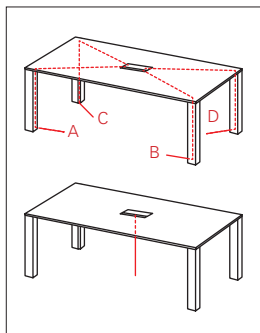

The distribution of electricity is entirely configurable; the exit for the cables can be placed inside any leg (A, B, C or D). Please specify the Customer Departmente which leg is to have the cables with reference to the view of the table in the diagram b

La distribución de la electrificación es totalmente configurable; la salida de cables puede situarse en la pata que se desee (A, B, C o D). Especificar al Departamento Comercial en que pata de la mesa desea que se sitúe el cable (ver dibujo).

## IN-SURFACE POWER BOXES CAJAS DE CONEXIONES DENTRO DEL SOBRE

It is a data dynamo with 2 amp dual charging USB. Available in two finishes: black or white.

Es una dínamo de datos con 2 amp de carga dual USB. Disponible en dos acabados: negro o blanco.

PS0804

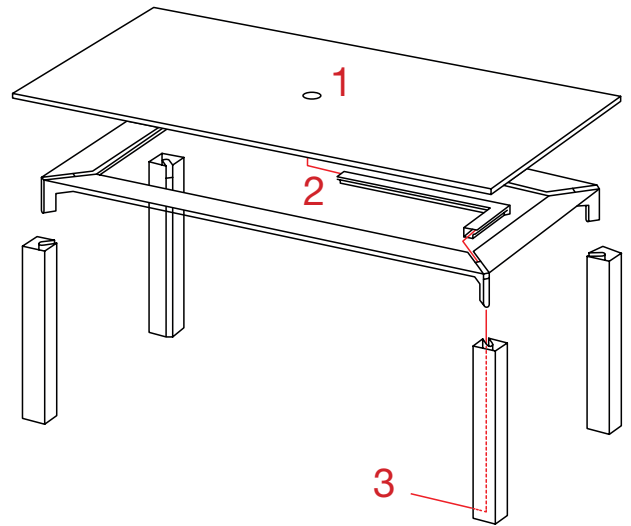
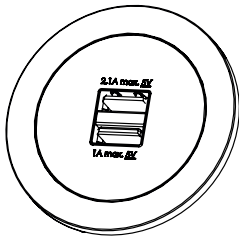

### 1 POWER BOXES DISTRIBUTION DISTRIBUCIÓN DE SISTEMAS

By standard, the position of the system will be in the central of the table, placed horizontally. When there are two system boxes, these will be separated 1/3 between them and placed horizontally. For other options, please contact the Customer Department.

De serie, la disposición del sistema será en el centro de la mesa y en sentido longitudinal. Cuando se disponga de dos sistemas, estos se colocarán con una separación de 1/3 de la longitud total de la mesa, y en sentido longitudinal. Otras opciones consultar con el Departamento Comercial.

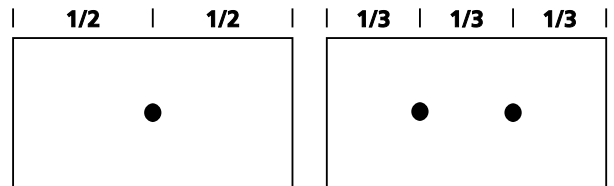

### 2 WIRING MANAGEMENT GESTIÓN DEL CABLEADO

Wire pass through an aluminum grommet keeping it hidden. By default color is silver, for other finishings ask the Customer Department.

El cable se pasa a través de un perfil pasacables de aluminio que lo mantiene oculto. Su color de serie es el plata, para otros acabados consultar al Departamento Comercial.

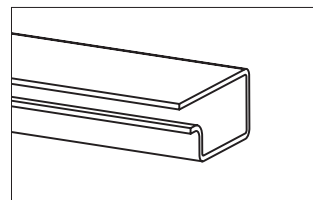

## OPTIONAL PREINSTALLED WIRING PREINSTALACIÓN DEL CABLEADO

IN0006

Preinstalled wiring consists in the addition of the necessary mechanisms to integrate power systems in the table, so that wiring is hidden until the way out in the floor. Necessary grommet are included and 3m cable (from the power system). For other cable dimensions contact the Customer Department. Preinstalled wiring is available for aluminum legs, Delta and 100x100 square legs. In wooden legs cable way out is placed in center of the table.

La preinstalación consiste en el montaje de los mecanismos necesarios para integrar el sistema de electrificación en la mesa, de modo que el cableado quede oculto hasta su salida por la base. Se incluyen los pasacables necesarios y 3 metros de cable (midiendo desde el sistema de conexiones). Para otras medidas de cable consultar al Departamento Comercial. Puede preinstalarse el cableado en las mesas Extra con patas de aluminio, Delta o cuadradas de 100x100. En las patas de madera la salida del cable se situa en la parte central de la mesa.

The distribution of electricity is entirely configurable; the exit for the cables can be placed inside any leg (A, B, C or D). Please specify the Customer Departmente which leg is to have the cables with reference to the view of the table in the diagram b

La distribución de la electrificación es totalmente configurable; la salida de cables puede situarse en la pata que se desee (A, B, C o D). Especificar al Departamento Comercial en que pata de la mesa desea que se sitúe el cable (ver dibujo).

### 3 CABLE WAY OUT SALIDA DE CABLEADO

The cable way out can be performed directly from the power system or thru a canal in the base bottom, so that is hidden until it gets to the floor.

La salida del cable se realiza directamente desde el propio sistema como por unas canalizaciones en la parte inferior de la base, de modo que el cable queda oculto hasta llegar al suelo.

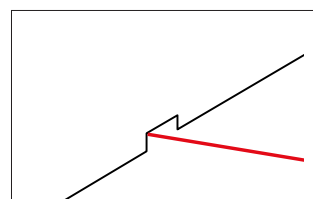

**QI CHARGING POWER BOXES**  
**CAJAS DE CONEXIONES QI**

The inductive charging station, allows maximum larger contact surface. Available in two finish: black or white.

La estación de carga inductiva permite una superficie de contacto máxima más grande. Disponible en dos acabados: negro o blanco.

PS0714

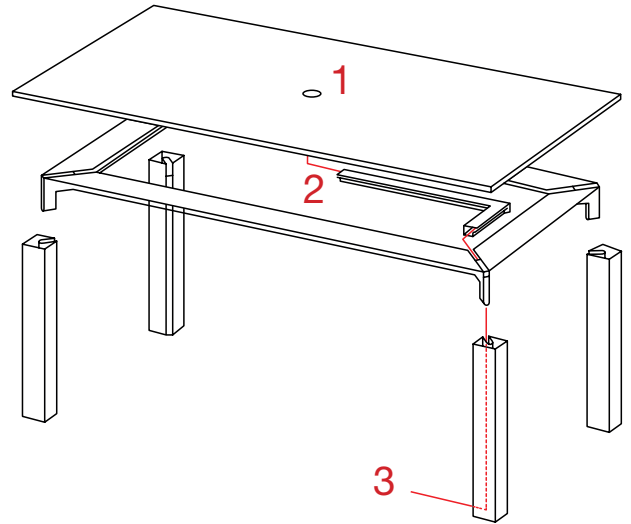
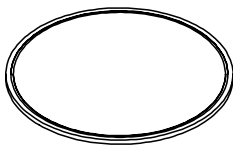

**1 POWER BOXES DISTRIBUTION DISTRIBUCIÓN DE SISTEMAS**

By standard, the position of the system will be in the central of the table, placed horizontally. When there are two system boxes, these will be separated 1/3 between them and placed horizontally. For other options, please contact the Customer Department.

De serie, la disposición del sistema será en el centro de la mesa y en sentido longitudinal. Cuando se disponga de dos sistemas, estos se colocarán con una separación de 1/3 de la longitud total de la mesa, y en sentido longitudinal. Otras opciones consultar con el Departamento Comercial.

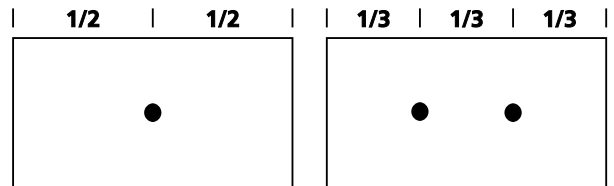

**2 WIRING MANAGEMENT GESTIÓN DEL CABLEADO**

Wire pass through an aluminum grommet keeping it hidden. By default color is silver, for other finishings ask the Customer Department.

El cable se pasa a través de un perfil pasacables de aluminio que lo mantiene oculto. Su color de serie es el plata, para otros acabados consultar al Departamento Comercial.

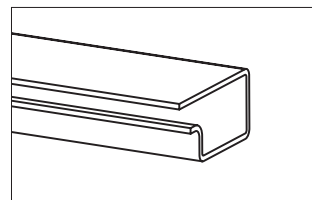

**OPTIONAL PREINSTALLED WIRING**  
**PREINSTALACIÓN DEL CABLEADO**

IN0006

Preinstalled wiring consists in the addition of the necessary mechanisms to integrate power systems in the table, so that wiring is hidden until the way out in the floor. Necessary grommet are included and 3m cable (from the power system). For other cable dimensions contact the Customer Department.

La preinstalación consiste en el montaje de los mecanismos necesarios para integrar el sistema de electrificación en la mesa, de modo que el cableado quede oculto hasta su salida por la base. Se incluyen los pasacables necesarios y 3 metros de cable (midiendo desde el sistema de conexiones). Para otras longitudes de cable consultar al Departamento Comercial.

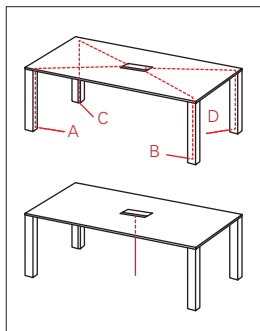

The distribution of electricity is entirely configurable; the exit for the cables can be placed inside any leg (A, B, C or D). Please specify the Customer Departmente which leg is to have the cables with reference to the view of the table in the diagram b

La distribución de la electrificación es totalmente configurable; la salida de cables puede situarse en la pata que se desee (A, B, C o D). Especificar al Departamento Comercial en que pata de la mesa desea que se sitúe el cable (ver dibujo).

**3 CABLE WAY OUT SALIDA DE CABLEADO**

The cable way out can be performed directly from the power system or thru a canal in the base bottom, so that is hidden until it gets to the floor.

La salida del cable se realiza directamente desde el propio sistema como por unas canalizaciones en la parte inferior de la base, de modo que el cable queda oculto hasta llegar al suelo.







**Description**  
**Descripción**

Table program available with central base in ash wood. Round table tops available in different sizes and finished in oak, lacquered, laminate, ultramate, linoleum or Compacto HPL. Available in 2 heights.

Programa de mesas disponible con bases centrales en madera de fresno. Sobres de mesa redondos disponibles en diferentes medidas y acabado roble, lacado, laminado, ultramate, linóleo o Compacto HPL. Disponible en 2 alturas.

**Wood finish Ash**  
**Acabado madera**  
**Fresno**



**Wood lacquer finish**  
**Acabado lacas madera**

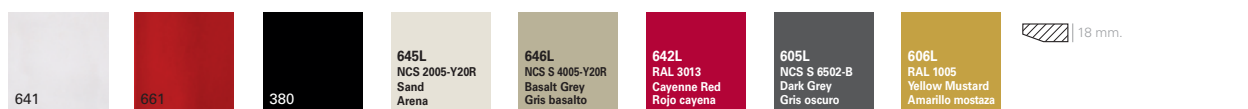

**Laminated**  
**Laminado**

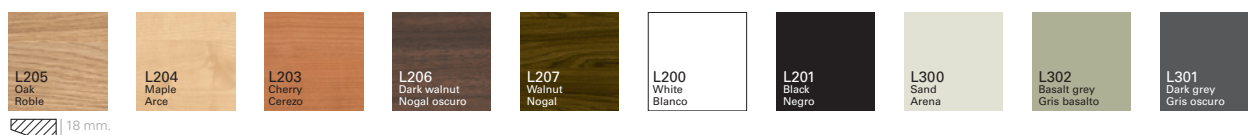

**Wood finish Oak**  
**Acabado madera**  
**Roble**



**Compacto HPL finish**  
**Acabado Compacto**  
**HPL**

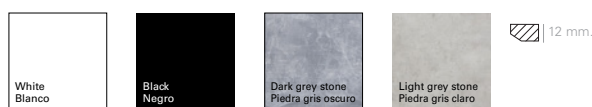

**Ultra-matte finish**  
**Acabado ultramate**



**Linoleum finish**  
**Acabado linóleo**



**Intellectual property Propiedad intelectual**

All our collections are protected by international industrial design registries, designs patents, copyrights and intellectual Property laws. Unauthorized use of AW International Property is a criminal offence and can lead to prosecution.  
Todas nuestras colecciones están protegidas por registros de diseño industrial, diseño de patente, copyright y derechos de propiedad intelectual en todo el mundo. El uso no autorizado de los diseños y propiedad intelectual de AW supone un delito que puede ser sometido a acción judicial.



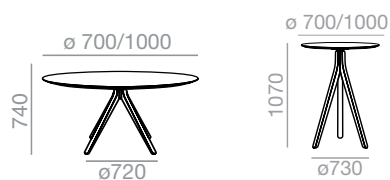

SERIE 600  
\*Matte lacquered and premium upcharge  
\*Incremento por lacado mate y premium

Table height / Altura de mesa 740												
Top measures Medidas sobre	Table top / Sobre											
	Oak Roble		Lacquered Lacado		Laminate Laminado		Ultra-matte Ultramate		Linoleum Linóleo		Compacto HPL Compacto HPL	
	Ref.	€	Ref.	€	Ref.	€	Ref.	€	Ref.	€	Ref.	€
ø700	ME2800	785	ME2804	742	ME2808	714	ME2812	803	ME2816	846	ME2820	721
kg	31'1		31'1		31'1		31'1		31'1		31'1	
2 boxes / bultos m3	0,45		0,45		0,45		0,45		0'45		0'45	
ø800	ME2801	879	ME2805	776	ME2809	807	ME2813	985	ME2817	1.014	ME2821	755
kg	32'7		32'7		32'7		32'7		32'7		32'7	
2 boxes / bultos m3	0,47		0,47		0,47		0,47		0'47		0'47	
ø900	ME2802	995	ME2806	825	ME2810	868	ME2814	1.033	ME2818	1.104	ME2822	806
kg	34'3		34'3		34'3		34'3		34'3		34'3	
2 boxes / bultos m3	0,49		0,49		0,49		0,49		0'49		0'49	
ø1000	ME2803	1.046	ME2807	853	ME2811	884	ME2815	1.036	ME2819	1.136	ME2823	857
kg	35'6		35'6		35'6		35'6		35'6		35'6	
2 boxes / bultos m3	0,52		0,52		0,52		0,52		0'52		0'52	

Table height / Altura de mesa 1070												
Top measures Medidas sobre	Table top / Sobre											
	Oak Roble		Lacquered Lacado		Laminate Laminado		Ultra-matte Ultramate		Linoleum Linóleo		Compacto HPL Compacto HPL	
	Ref.	€	Ref.	€	Ref.	€	Ref.	€	Ref.	€	Ref.	€
ø700	ME2824	853	ME2828	814	ME2832	781	ME2836	872	ME2840	938	ME2844	789
kg	34'9		34'9		34'9		34'9		34'9		34'9	
2 boxes / bultos m3	0,6		0,6		0,6		0,6		0'6		0'6	
ø800	ME2825	947	ME2829	844	ME2833	876	ME2837	1.051	ME2841	1.092	ME2845	822
kg	36'1		36'1		36'1		36'1		36'1		36'1	
2 boxes / bultos m3	0,63		0,63		0,63		0,63		0'63		0'63	
ø900	ME2826	1.063	ME2830	895	ME2834	945	ME2838	1.100	ME2842	1.197	ME2846	877
kg	37'6		37'6		37'6		37'6		37'6		37'6	
2 boxes / bultos m3	0,65		0,65		0,65		0,65		0'65		0'65	
ø1000	ME2827	1.115	ME2831	919	ME2835	945	ME2839	1.105	ME2843	1.202	ME2847	922
kg	38'8		38'8		38'8		38'8		38'8		38'8	
2 boxes / bultos m3	0,68		0,68		0,68		0,68		0'68		0'68	



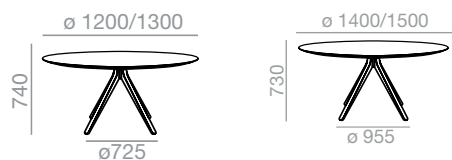

SERIE 600  
 \*Matte lacquered and premium upcharge  
 \*Incremento por lacado mate y premium

Table height / Altura de mesa 740												
Top measures Medidas sobre	Table top / Sobre											
	Oak Roble		Lacquered Lacado		Laminate Laminado		Ultra-matte Ultramate		Linoleum Linóleo		Compacto HPL Compacto HPL	
	Ref.	€	Ref.	€	Ref.	€	Ref.	€	Ref.	€	Ref.	€
ø1200	ME2848	1.322	ME2850	1.182	ME2852	1.163	ME2854	1.415	ME2856	1.376	ME2858	1.155
kg	40'1		40'1		40'1		40'1		40'1		40'1	
2 boxes / bultos  m3	0,78		0,78		0,78		0,78		0'78		0'78	

ø1300	ME2849	1.491	ME2851	1.261	ME2853	1.219	ME2855	1.487	ME2857	1.443	ME2859	1.178
kg	41'5		41'5		41'5		41'5		41'5		41'5	
2 boxes / bultos  m3	0,82		0,82		0,82		0,82		0'82		0'82	

Table height / Altura de mesa 730												
Top measures Medidas sobre	Table top / Sobre											
	Oak Roble		Lacquered Lacado		Laminate Laminado		Ultra-matte Ultramate		Linoleum Linóleo		Compacto HPL Compacto HPL	
	Ref.	€	Ref.	€	Ref.	€	Ref.	€	Ref.	€	Ref.	€
ø1400	ME2860	1.633	ME2862	1.399	ME2864	1.404	ME2866	1.832	ME2868	1.682	ME2870	1.385
kg	43'7		43'7		43'7		43'7		43'7		43'7	
2 boxes / bultos  m3	1,33		1,33		1,33		1,33		1'33		1'33	

ø1500	ME2861	2.030	ME2863	1.569	ME2865	1.799	ME2867	2.226	ME2869	1.965	ME2871	1.682
kg	45'2		45'2		45'2		45'2		45'2		45'2	
2 boxes / bultos  m3	1,38		1,38		1,38		1,38		1'38		1'38	

Maximum table heights  
Alturas máximas de mesa

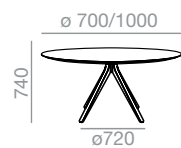

Table top					
Oak Roble	Lacquered Lacado	Laminate Laminado	Ultra-matte Ultramate	Linoleum Linóleo	Compacto HPL Compacto HPL
735	735	735	735	735	729



Table top					
Oak Roble	Lacquered Lacado	Laminate Laminado	Ultra-matte Ultramate	Linoleum Linóleo	Compacto HPL Compacto HPL
1080	1080	1080	1080	1080	1074

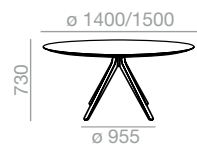

Table top					
Oak Roble	Lacquered Lacado	Laminate Laminado	Ultra-matte Ultramate	Linoleum Linóleo	Compacto HPL Compacto HPL
735	735	735	735	735	729



**Description**  
**Descripción**

Collection of tables with solid ash wood legs and oak tops, available in different sizes and coffee table and dining room versions. The cafeteria version is offered with a round top, available in 4 sizes and a 3-foot base. The dining room version is offered with a round top, available in 3 sizes, or a rectangular top, available in 4 sizes, and a 4-leg base.

Colección de mesas con base de pies de madera maciza de fresno y sobre de roble, disponible en diferentes tamaños y versiones de mesa cafetería y comedor. La versión cafetería se ofrece con sobre redondo, disponible en 4 medidas y base de 3 pies. La versión comedor se ofrece con sobre redondo, disponible en 3 medidas, o rectangular, disponible en 4 medidas, y base de 4 pies.

**Wood finish Oak**  
**Acabado madera**  
**Roble**



**Wood finish Ash**  
**Acabado madera**  
**Fresno**



**Wood lacquer finish**  
**Acabado lacas**  
**madera**



**Certificates**  
**Certificados**

**Fireproof polyurethane foam**  
**Espuma de poliuretano ignifuga**

UNE EN 1021:2006  
BS 5852 part 2 crib 5  
UNI 9175 Classe 1 IM  
BKZ 5.2  
California TB 117:2013  
California TB 133\*

**Quality - Resistance**  
**Calidad - Resistencia**

UNE EN 16139:2013

\*Contact our Customer Department  
\*Consultar con nuestro Departamento Comercial

**Intellectual property Propiedad intelectual**

All our collections are protected by international industrial design registries, designs patents, copyrights and intellectual Property laws. Unauthorized use of AW International Property is a criminal offence and can lead to prosecution. Todas nuestras colecciones están protegidas por registros de diseño industrial, diseño de patente, copyright y derechos de propiedad intelectual en todo el mundo. El uso no autorizado de los diseños y propiedad intelectual de AW supone un delito que puede ser sometido a acción judicial.

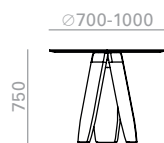

SERIE 600 \*Matte lacquered and premium upcharge \*Incremento por lacado mate y premium | 219 |

Top / Sobre	Top measures / Medidas sobre							
	Ø700		Ø800		Ø900		Ø1000	
	Ref.	€	Ref.	€	Ref.	€	Ref.	€
Oak / Roble	ME6544	860	ME6545	934	ME6546	1.036	ME6547	1.066
kg	31'1		32'7		34'3		35'6	
1 box / bulto m3	0,11		0,13		0,16		0,21	

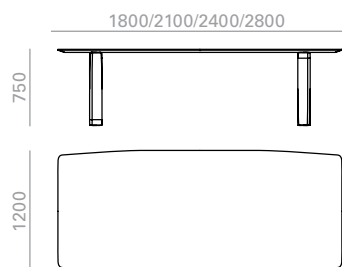

SERIE 600 \*Matte lacquered and premium upcharge \*Incremento por lacado mate y premium | 474 |

Top / Sobre	Top measures / Medidas sobre							
	1800x1200		2100x1200		2400x1200		2800x1200	
	Ref.	€	Ref.	€	Ref.	€	Ref.	€
Oak / Roble	ME6540	2.543	ME6541	2.719	ME6542	2.767	ME6543	3.254
kg	73		80		91'6		92	
1 box / bulto m3	0,25		0,26		0,28		0,3	

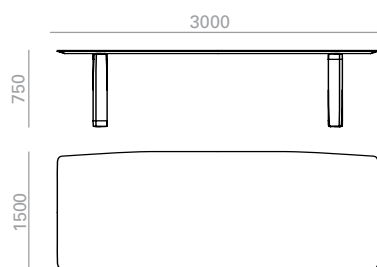

SERIE 600 \*Matte lacquered and premium upcharge \*Incremento por lacado mate y premium | 486 |

Top / Sobre	Top measures / Medidas sobre	
	3000x1500	
	Ref.	€
Oak / Roble	ME6555	4.037
kg	96'05	
1 box / bulto m3	1,45	

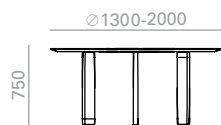

SERIE  
600

\*Matte lacquered and premium upcharge  
\*Incremento por lacado mate y premium

| 510 |

Top / Sobre	Top measures / Medidas sobre									
	Ø1300		Ø1400		Ø1500		Ø1800		Ø2000	
	Ref.	€	Ref.	€	Ref.	€	Ref.	€	Ref.	€
Oak / Roble	ME6548	1.657	ME6549	1.811	ME6550	2.229	ME6553	3.381	ME6554	4.309
kg	40'1		43'54		49'75		96'05		96'05	
1 box / bulto  m3	0,23		0,3		0,32		1,45		1'45	



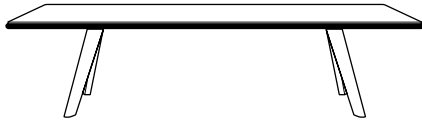

**Description**

Dining and conference table with structure and base with aluminum legs available in various finishes. Option of structure and legs in oak finish.

**Descripción**

Mesa de comedor y conferencia con estructura y base con pies de aluminio disponible en diferentes acabados. Opción de estructura y patas en acabado roble.

**Wood finish Oak**

**Acabado madera**  
**Roble**



**Wood lacquer finish**

**Acabado laca madera**



**Laminated**

**Laminado**



**Ultra-matte finish**

**Acabado ultramate**



**Linoleum finish**

**Acabado linóleo**

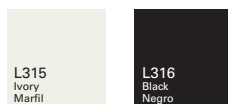

**Glass finish**

**Acabado de cristal**



**Technical Stone 8 finish**

**Acabado Technical Stone 8**

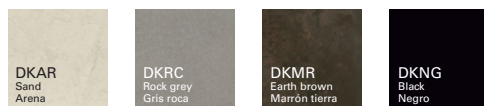

**M1 marble finish**

**Acabado de mármol M1**



**M3 marble finish**

**Acabado de mármol M3**

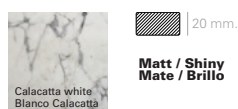

**Aluminum finish**

**Acabado aluminio**



**Intellectual property Propiedad intelectual**

All our collections are protected by international industrial design registries, designs patents, copyrights and intellectual Property laws. Unauthorized use of AW International Property is a criminal offence and can lead to prosecution.  
Todas nuestras colecciones están protegidas por registros de diseño industrial, diseño de patente, copyright y derechos de propiedad intelectual en todo el mundo. El uso no autorizado de los diseños y propiedad intelectual de AW supone un delito que puede ser sometido a acción judicial.



ME2702

2000 x 1000



	Table top / Sobre				
	Oak Roble	Lacquered Lacado	Laminate TP Laminado TP	Ultra-matte TP Ultramate TP	Linoleum Linóleo
	€	€	€	€	€
	4.090	3.568	3.874	4.077	4.226
kg	57.1	57.1	57.1	57.1	57.1
1 box / bulto  m3	0.33	0.33	0.33	0.33	0.33

	Table top / Sobre			
	Low Iron Glass Cristal óptico	Technical Stone 8	***M1 Marble Mármol M1	***M3 Marble Mármol M3
	€	€	€	€
	4.090	5.516	5.906	7.252
kg	57.1	57.1	57.1	57.1
1 box / bulto  m3	0.33	0.33	0.33	0.33

\*\*\*Marble  
shiny upcharge  
Incremento  
por mármol  
brillo

| 30 |



ME2700

2200 x 1000



	Table top / Sobre				
	*Oak Roble	Lacquered Lacado	Laminate TP Laminado TP	Ultra-matte TP Ultramate TP	Linoleum Linóleo
	€	€	€	€	€
	4.181	3.655	3.955	4.158	4.468
kg	64.18	64.18	64.18	64.18	64.18
1 box / bulto  m3	0.38	0.38	0.38	0.38	0.38

	Table top / Sobre			
	Low Iron Glass Cristal óptico	Technical Stone 8	***M1 Marble Mármol M1	***M3 Marble Mármol M3
	€	€	€	€
	4.181	5.729	6.174	7.642
kg	64.18	64.18	64.18	64.18
1 box / bulto  m3	0.38	0.38	0.38	0.38

\*\*\*Marble  
shiny upcharge  
Incremento  
por mármol  
brillo

| 30 |

ME2701

2400 x 1200



	Table top / Sobre				
	*Oak Roble	Lacquered Lacado	Laminate TP Laminado TP	Ultra-matte TP Ultramate TP	Linoleum Linóleo
	€	€	€	€	€
	4.416	3.871	4.152	4.355	4.732
kg	66.52	66.52	66.52	66.52	66.52
1 box / bulto  m3	0.57	0.57	0.57	0.57	0.57

	Table top / Sobre			
	Low Iron Glass Cristal óptico	Technical Stone 8	***M1 Marble Mármol M1	***M3 Marble Mármol M3
	€	€	€	€
	4.416	6.400	6.842	8.774
kg	66.52	66.52	66.52	66.52
1 box / bulto  m3	0.57	0.57	0.57	0.57

\*\*\*Marble  
shiny upcharge  
Incremento  
por mármol  
brillo

| 30 |

ME2703

2800 x 1200



Legs	Table top / Sobre				
	Oak Roble	Lacquered Lacado	Laminate TP Laminado TP	Ultra-matte TP Ultramate TP	Linoleum Linóleo
	€	€	€	€	€
	4.968	4.177	4.655	5.019	5.139
kg	73.19	73.19	73.19	73.19	73.19
1 box / bulto  m3	0.61	0.61	0.61	0.61	0.61

	Table top / Sobre			
	Low Iron Glass Cristal óptico	Technical Stone 8	***M1 Marble Mármol M1	***M3 Marble Mármol M3
	€	€	€	€
	4.968	6.974	7.423	9.677
kg	73.19	73.19	73.19	73.19
1 box / bulto  m3	0.61	0.61	0.61	0.61

\*\*\*Marble shiny upcharge  
Incremento por mármol brillo

| 30 |

ME2704

3000 x 1500

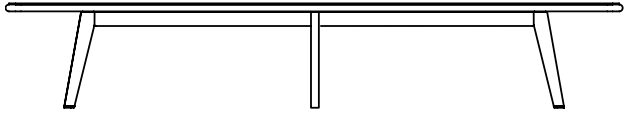

	Table top / Sobre				
	Oak Roble	Lacquered Lacado	Laminate TP Laminado TP	Ultra-matte TP Ultramate TP	Linoleum Linóleo
	€	€	€	€	€
	5.239	4.487	4.858	5.223	5.558
kg	86.3	86.3	86.3	86.3	86.3
1 box / bulto  m3	0.7	0.7	0.7	0.7	0.7

	Table top / Sobre			
	Low Iron Glass Cristal óptico	Technical Stone 8	***M1 Marble Mármol M1	***M3 Marble Mármol M3
	€	€	€	€
	5.239	7.987	8.335	11.348
kg	86.3	86.3	86.3	86.3
1 box / bulto  m3	0.7	0.7	0.7	0.7

\*\*\*Marble  
shiny upcharge  
Incremento  
por mármol  
brillo

| 30 |

ME2705

3500 x 1500

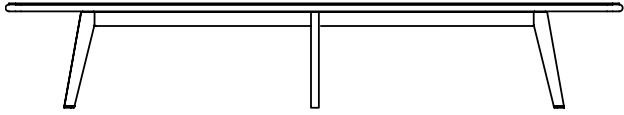

Legs Patas	Table top / Sobre				
	*Oak Roble	Lacquered Lacado	Laminate TP Laminado TP	Ultra-matte TP Ultramate TP	Linoleum Linóleo
	€	€	€	€	€
	6.813	5.610	6.694	7.419	6.697
kg	123.8	123.8	123.8	123.8	123.8
1 box / bulto  m3	0.8	0.8	0.8	0.8	0.8

Legs Patas	Table top / Sobre			
	Low Iron Glass Cristal óptico	Technical Stone 8	***M1 Marble Mármol M1	***M3 Marble Mármol M3
	€	€	€	€
	6.813	10.226	10.519	14.042
kg	123.8	123.8	123.8	123.8
1 box / bulto  m3	0.8	0.8	0.8	0.8

ME2706

4000 x 1500

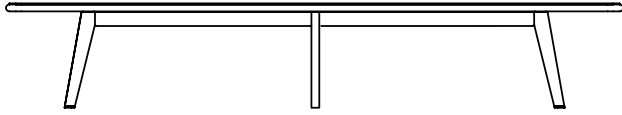

	Table top / Sobre				
	*Oak Roble	Lacquered Lacado	Laminate TP Laminado TP	Ultra-matte TP Ultramate TP	Linoleum Linóleo
	€	€	€	€	€
	7.216	5.887	6.919	7.648	7.103
kg	134.2	134.2	134.2	134.2	134.2
1 box / bulto  m3	0.86	0.86	0.86	0.86	0.86

	Table top / Sobre			
	Low Iron Glass Cristal óptico	Technical Stone 8	***M1 Marble Mármol M1	***M3 Marble Mármol M3
	€	€	€	€
	7.216	10.984	11.258	15.274
kg	134.2	134.2	134.2	134.2
1 box / bulto  m3	0.86	0.86	0.86	0.86

\*\*\*Marble  
shiny upcharge  
Incremento  
por mármol  
brillo

| 30 |

ME2707

4500 x 1500

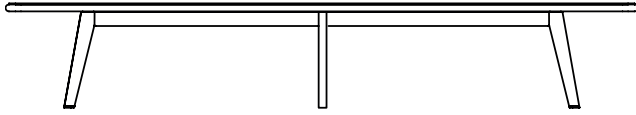

	Table top / Sobre				
	*Oak Roble	Lacquered Lacado	Laminate TP Laminado TP	Ultra-matte TP Ultramate TP	Linoleum Linóleo
	€	€	€	€	€
	7.765	6.326	7.297	8.023	7.668
kg	144.5	144.5	144.5	144.5	144.5
1 box / bulto  m3	0.92	0.92	0.92	0.92	0.92

	Table top / Sobre			
	Low Iron Glass Cristal óptico	Technical Stone 8	***M1 Marble Mármol M1	***M3 Marble Mármol M3
	€	€	€	€
	7.765	11.887	12.152	16.681
kg	144.5	144.5	144.5	144.5
1 box / bulto  m3	0.92	0.92	0.92	0.92

\*\*\*Marble  
shiny upcharge  
Incremento  
por mármol  
brillo

| 30 |

ME2708

5000 x 1500

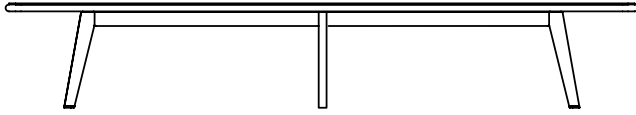

	Table top / Sobre				
	Oak Roble	Lacquered Lacado	Laminate TP Laminado TP	Ultra-matte TP Ultramate TP	Linoleum Linóleo
	€	€	€	€	€
	8.219	6.852	7.535	8.265	8.097
kg	154.9	154.9	154.9	154.9	154.9
1 box / bulto  m3	0.97	0.97	0.97	0.97	0.97

	Table top / Sobre			
	Low Iron Glass Cristal óptico	Technical Stone 8	***M1 Marble Mármol M1	***M3 Marble Mármol M3
	€	€	€	€
	8.219	12.694	12.926	17.945
kg	154.9	154.9	154.9	154.9
1 box / bulto  m3	0.97	0.97	0.97	0.97

\*\*\*Marble  
shiny upcharge  
Incremento  
por mármol  
brillo

| 30 |



ME2709

5500 x 1500

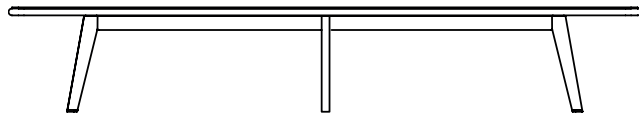

	Table top / Sobre				
	Oak Roble	Lacquered Lacado	Laminate TP Laminado TP	Ultra-matte TP Ultramate TP	Linoleum Linóleo
	€	€	€	€	€
	8.503	6.916	7.771	8.500	8.510
kg	171.3	171.3	171.3	171.3	171.3
1 box / bulto  m3	1.03	1.03	1.03	1.03	1.03

	Table top / Sobre			
	Low Iron Glass Cristal óptico	Technical Stone 8	***M1 Marble Mármol M1	***M3 Marble Mármol M3
	€	€	€	€
	8.503	13.458	13.694	19.226
kg	171.3	171.3	171.3	171.3
1 box / bulto  m3	1.03	1.03	1.03	1.03

\*\*\*Marble  
shiny upcharge  
Incremento  
por mármol  
brillo

| 30 |



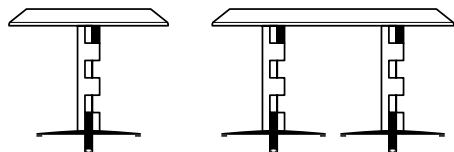

**Description**

Table with 4-blade aluminum base in black finish and solid oak column. Table top available in several sizes with oak, lacquered or linoleum finish.

**Descripción**

Mesa con base de 4 aspas de aluminio en acabado negro y columna de madera maciza de roble. Sobre de mesa disponible en diferentes medidas y acabado roble, lacado o linóleo.

**Wood finish Oak**

**Acabado madera  
Roble**



**Linoleum finish**

**Acabado linóleo**

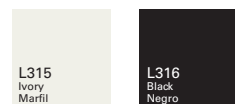

**Aluminum finish**

**Acabado aluminio**

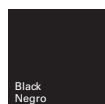

**Intellectual property Propiedad intelectual**

All our collections are protected by international industrial design registries, designs patents, copyrights and intellectual Property laws. Unauthorized use of AW International Property is a criminal offence and can lead to prosecution.

Todas nuestras colecciones están protegidas por registros de diseño industrial, diseño de patente, copyright y derechos de propiedad intelectual en todo el mundo. El uso no autorizado de los diseños y propiedad intelectual de AW supone un delito que puede ser sometido a acción judicial.



**ME2650**

600 x 600 / ø600

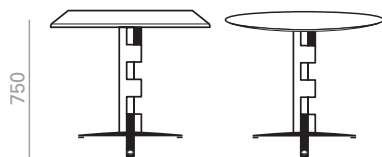

	Table top / Sobre	
	Oak Roble	Linoleum Linóleo
	€	€
	676	1.003
	kg	13.02
1 box / bulto  m3	0.28	0.28

**ME2651**

700 x 700 / ø700

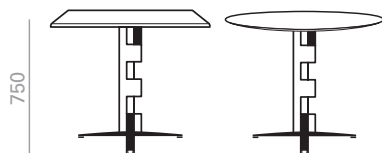

	Table top / Sobre	
	Oak Roble	Linoleum Linóleo
	€	€
	761	1.098
	kg	14.15
1 box / bulto  m3	0.28	0.28

# Andreu World

## ME2652

800 x 800 / ø800

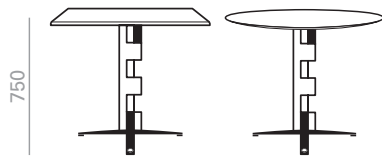

	Table top / Sobre	
	Oak Roble	Linoleum Linóleo
	€	€
	874	1.235
	kg	15.41
1 box / bulto  m3	0.29	0.29

## ME2653

900 x 900 / ø900

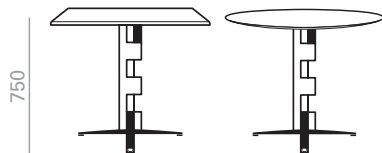

	Table top / Sobre	
	Oak Roble	Linoleum Linóleo
	€	€
	1.106	1.539
	kg	14.08
1 box / bulto  m3	0.28	0.28

**ME2654**

ø1000

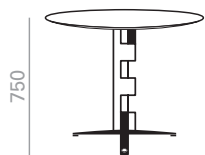

		Table top / Sobre	
		*Oak Roble	Linoleum Linóleo
		€	€
		1.106	1.539
	kg	15.48	15.48
	1 box / bulto  m3	0.28	0.28

**ME2655**

1200 x 600

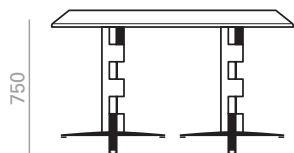
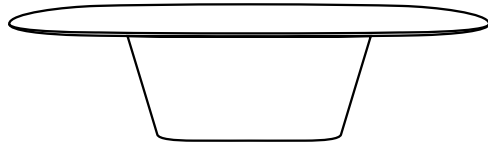

		Table top / Sobre	
		*Oak Roble	Linoleum Linóleo
		€	€
		1.416	2.027
	kg	17.69	17.69
	1 box / bulto  m3	0.48	0.48



**Description** Tables with bases in Pure Eco thermo-polymer (100% recycled) available in several colors. Table tops in several shapes and sizes available in various finishes. Option of base and top in cement finish available in several colors.

**Descripción**

Mesas con bases de termopolímero Pure Eco (100% reciclado) disponible en diferentes colores. Sobres de tablero de diferentes formas y medidas disponible en diferentes acabados. Opción de base y sobre en acabado cemento disponible en diferentes colores.

**Wood finish Oak**  
**Acabado madera Roble**



**Wood lacquer finish**  
**Acabado lacas madera**

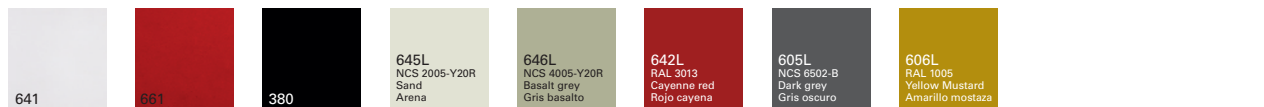

**Laminated**  
**Laminado**

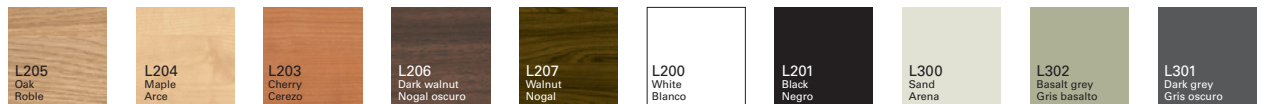

**Ultra-matte finish**  
**Acabado ultramate**



**Linoleum finish**  
**Acabado linóleo**

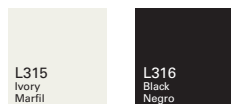

**Technical Stone 8 finish**  
**Acabado Technical Stone 8**

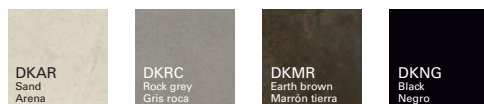

**Glass finish**  
**Acabado de cristal**



**Technical Stone 8 finish**  
**Acabado Technical Stone 8**

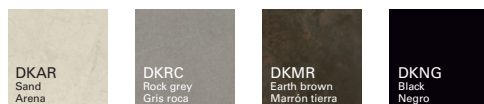

**M1 marble finish**  
**Acabado de mármol M1**

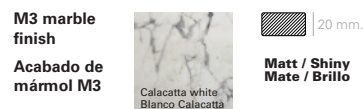
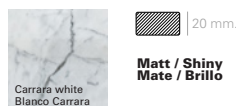

**Pure Eco Thermo-polymer finish**  
**Acabado de Termo-polímero Pure Eco**



**Cement finish**  
**Acabado cemento**



**Intellectual property Propiedad intelectual**

All our collections are protected by international industrial design registries, designs patents, copyrights and intellectual Property laws. Unauthorized use of AW International Property is a criminal offence and can lead to prosecution.  
Todas nuestras colecciones están protegidas por registros de diseño industrial, diseño de patente, copyright y derechos de propiedad intelectual todo el mundo. El uso no autorizado de los diseños y propiedad intelectual de AW supone un delito que puede ser sometido a acción judicial.



ME3131

2400 x 1200

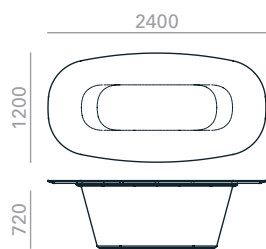

Top shape

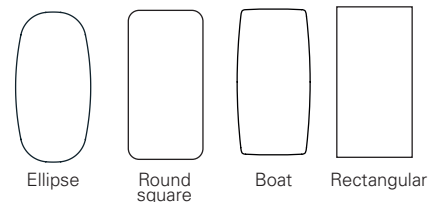

	Table top / Sobre					
	*Oak Roble	Lacquered Lacado	Laminate Laminado	LaminateTP LaminadoTP	Ultra-matte Ultramate	Ultra-matteTP UltramateTP
	€	€	€	€	€	€
	2.252	1.744	2.069	2.071	2.113	2.245
kg	149	149	149	149	149	149
1 box / bulto  m3	0.88	0.88	0.88	0.88	0.88	0.88

	Table top / Sobre					Top & Base
	Linoleum Linóleo	Technical Stone 8	Low Iron Glass Cristal óptico	***M1 Marble Mármol M1	***M3 Marble Mármol M3	Cement Cemento
	€	€	€	€	€	€
	2.918	4.152	3.974	6.006	7.935	2.942
kg	149	149	149	149	149	149
1 box / bulto  m3	0.88	0.88	0.88	0.88	0.88	0.88

SERIE 600	*Matte lacquered and premium upcharge	228	***Marble shiny upcharge	30
	*Incremento por lacado mate y premium		Incremento por mármol brillo	



ME3132

2600 x 1500

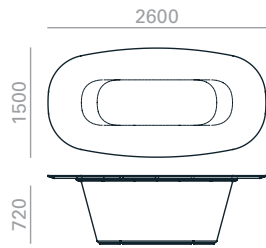

Top shape



Ellipse



Round square



Boat

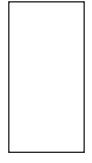

Rectangular

	Table top / Sobre					
	*Oak Roble	Lacquered Lacado	Laminate Laminado	LaminateTP LaminadoTP	Ultra-matte Ultramate	Ultra-matteTP UltramateTP
	€	€	€	€	€	€
	2.989	2.102	2.637	2.632	2.805	2.810
kg						
1 box / bulto  m3						

	Table top / Sobre					Top & Base
	Linoleum Linóleo	Technical Stone 8	Low Iron Glass Cristal óptico	***M1 Marble Mármol M1	***M3 Marble Mármol M3	Cement Cemento
	€	€	€	€	€	€
	3.545	4.806	4.735	7.013	9.626	3.506
kg						
1 box / bulto  m3						

SERIE 600	*Matte lacquered and premium upcharge	309	***Marble shiny upcharge	Incremento por mármol brillo	30
	*Incremento por lacado mate y premium				

ME3133

2800 x 1500

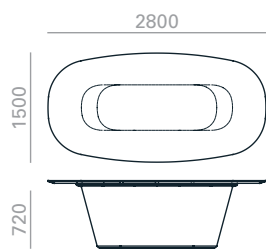

Top shape

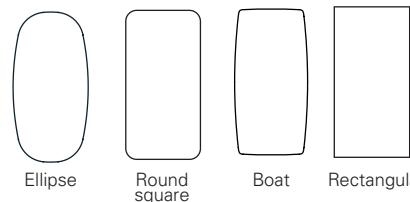

	Table top / Sobre					
	*Oak Roble	Lacquered Lacado	Laminate Laminado	LaminateTP LaminadoTP	Ultra-matte Ultramate	Ultra-matteTP UltramateTP
	€	€	€	€	€	€
	3.031	2.137	2.660	2.673	2.827	2.829
kg						
1 box / bulto  m3						

	Table top / Sobre					Top & Base
	Linoleum Linóleo	Technical Stone 8	Low Iron Glass Cristal óptico	***M1 Marble Mármol M1	***M3 Marble Mármol M3	Cement Cemento
	€	€	€	€	€	€
	3.637	5.045	4.900	7.365	10.174	3.610
kg						
1 box / bulto  m3						

SERIE 600

\*Matte lacquered and premium upcharge  
\*Incremento por lacado mate y premium

336

\*\*\*Marble shiny upcharge  
Incremento por mármol brillo

30

ME3134

3000 x 1500

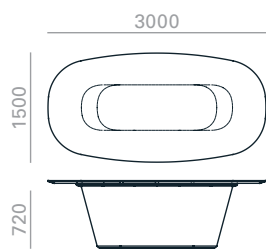

Top shape

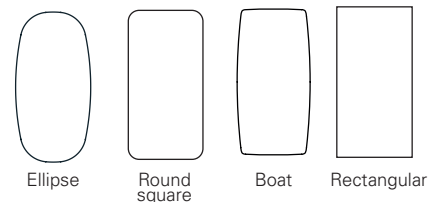

	Table top / Sobre					
	*Oak Roble	Lacquered Lacado	Laminate Laminado	LaminateTP LaminadoTP	Ultra-matte Ultramate	Ultra-matteTP UltramateTP
	€	€	€	€	€	€
	3.073	2.184	2.682	2.718	2.852	2.874
kg						
1 box / bulto  m3						

	Table top / Sobre					Top & Base
	Linoleum Linóleo	Technical Stone 8	Low Iron Glass Cristal óptico	***M1 Marble Mármol M1	***M3 Marble Mármol M3	Cement Cemento
	€	€	€	€	€	€
	3.765	5.203	5.024	7.887	10.900	3.710
kg						
1 box / bulto  m3						

SERIE  
600

\*Matte  
lacquered  
and premium  
upcharge  
\*Incremento  
por lacado  
mate y  
premium

| 360 |

\*\*\*Marble  
shiny upcharge  
Incremento  
por mármol  
brillo

| 30 |

Maximum table heights  
Alturas máximas de mesa

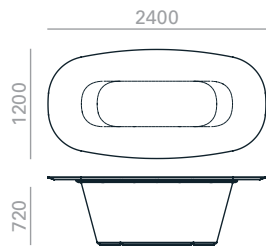
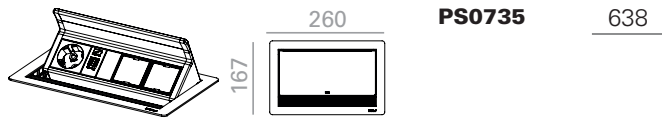

Table top / Sobre				
*Oak Roble	Lacquered Lacado	Laminate Laminado	LaminateTP LaminadoTP	Ultra-matte Ultramate
750	750	750	750	750

Table top / Sobre				
Ultra-matteTP UltramateTP	Linoleum Linóleo	Technical Stone 8	Low Iron Glass Cristal óptico	***M1 Marble Mármol M1
750	750	750	750	750

**PS-IN SURFACE**



**PS0735** 638

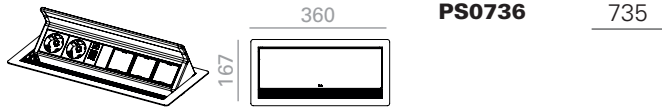

**PS0736** 735



**PS0804** 142

**PS-QI**



**PS0714** 243

**Preinstalled (Optional) / Preinstalación (Opcional) IN0006**

First installation / Primera instalación 270  
 Second and more installations / Segunda y más instalaciones 90

**PS-UNDERTOP**



**PS0787** 441



**PS0789** 510

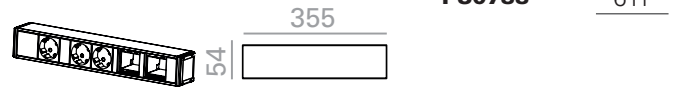

**PS0788** 611



**PS0790** 659

**PS-INTREGATED**

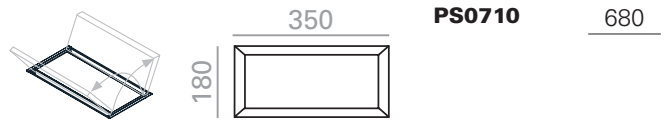

**PS0710** 680

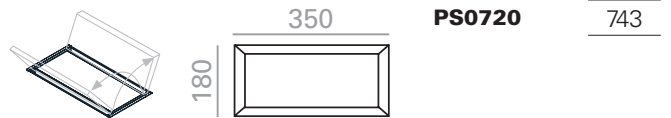

**PS0720** 743



**PS0795** 453



**PS0796** 468

**IN-SURFACE POWER BOXES  
CAJAS DE CONEXIONES DENTRO DEL SOBRE**

Aluminum power box mounted in the table top with a folding protective lid. It is served in anodized silver, black or white, for other finishing, contact the Customer Department. There are two power system sizes available and data slots can be customized according to the below diagram. For lifting base versions contact the Customer Department.

Caja de conexiones de aluminio integrada dentro de la superficie del sobre con tapa abatible, disponible para cualquier modelo de mesa Reverse. Se sirve en color anodizado plata, negro o blanco, para otros acabados consultar al Departamento Comercial. Para versiones de bases elevables consultar al Departamento Comercial. Se ofrecen dos tamaños de caja diferentes y con conectividad configurable, acorde al siguiente esquema:

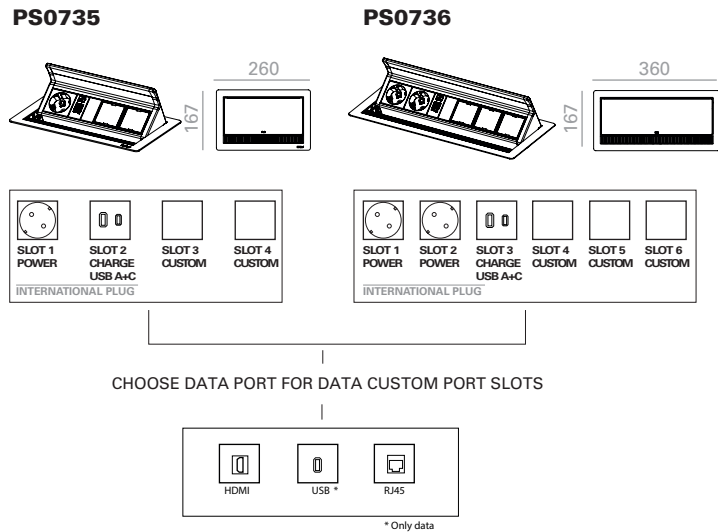

**OPTIONAL PREINSTALLED WIRING  
PREINSTALACIÓN DEL CABLEADO**

**IN0006**

Preinstalled wiring consists in the addition of the necessary mechanisms to integrate power systems in the table, so that wiring is hidden until the way out in the floor. Necessary grommet are included and 3m cable (from the power system). For other cable dimensions contact the Customer Department. Tables with only one base are exempt of this charge, for the rest of tables ask the Customer Department.

La preinstalación consiste en el montaje de los mecanismos necesarios para integrar el sistema de electrificación en la mesa, de modo que el cableado quede oculto hasta su salida por la base. Se incluyen los pasacables necesarios y 3 metros de cable (midiendo desde el sistema de conexiones). Las mesas de una sola base quedan exentas de este cargo, para el resto consultar al Departamento Comercial.

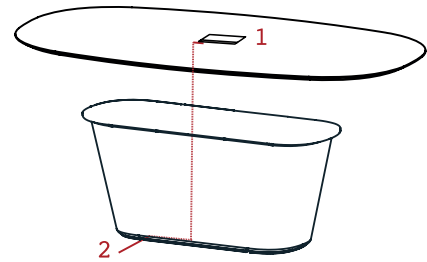

**1 POWER BOXES DISTRIBUTION DISTRIBUCIÓN DE SISTEMAS**

In tables with only one Reverse base power box can't be centered with the base. In tables with more than one base, by default power box is placed in the center of the table and in lengthwise direction. If more than one power box is installed, inform the Customer Department about the desired position.

En mesas con una sola base el sistema eléctrico iría instalado descentrado respecto a la base. En mesas con más de una base, por defecto la posición del sistema irá en el centro de la mesa y en sentido longitudinal. Si se solicita más de un sistema eléctrico, comunicar la posición deseada al Departamento Comercial.

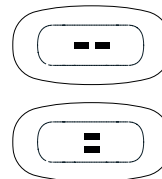

**2 WIRING MANAGEMENT GESTIÓN DEL CABLEADO**

Wire pass through an aluminum grommet keeping it hidden. By default color is silver, for other finishings ask the Customer Department.

El cable se pasa a través de un perfil pasacables de aluminio que lo mantiene oculto. Su color de serie es el plata, para otros acabados consultar al Departamento Comercial.

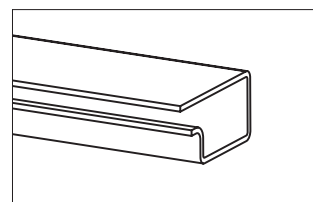

**3 CABLE WAY OUT SALIDA DE CABLEADO**

The cable way out can be performed directly from the power system or thru a canal in the base bottom, so that is hidden until it gets to the floor.

La salida del cable se realiza directamente desde el propio sistema como por unas canalizaciones en la parte inferior de la base, de modo que el cable queda oculto hasta llegar al suelo.

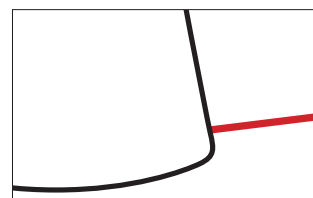

**IN-SURFACE POWER BOXES  
CAJAS DE CONEXIONES DENTRO DEL SOBRE**

It is a data dynamo with 2 amp dual charging USB. Available in two finishes: black or white. For lifting base versions contact the Customer Department.

Es una dínamo de datos con 2 amp de carga dual USB. Disponible en dos acabados: negro o blanco. Para versiones de bases elevables consultar al Departamento Comercial.

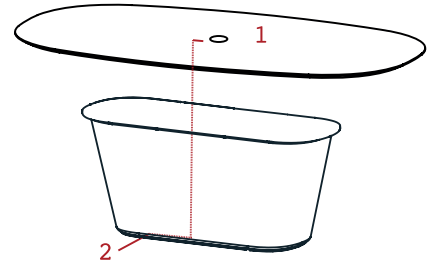

PS0804

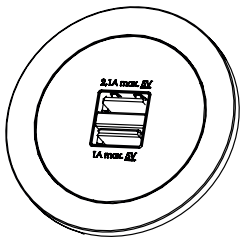

**1 POWER BOXES DISTRIBUTION DISTRIBUCIÓN DE SISTEMAS**

In tables with only one Reverse base power box can't be centered with the base. In tables with more than one base, by default power box is placed in the center of the table and in lengthwise direction. If more than one power box is installed, inform the Customer Department about the desired position.

En mesas con más de una base, por defecto la posición del sistema irá en el centro de la mesa y en sentido longitudinal. Si se solicita más de un sistema eléctrico, comunicar la posición deseada al Departamento Comercial.

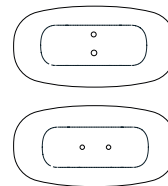

**2 WIRING MANAGEMENT GESTIÓN DEL CABLEADO**

Wire pass through an aluminum grommet keeping it hidden. By default color is silver, for other finishings ask the Customer Department.

El cable se pasa a través de un perfil pasacables de aluminio que lo mantiene oculto. Su color de serie es el plata, para otros acabados consultar al Departamento Comercial.

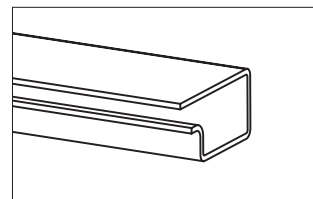

**OPTIONAL PREINSTALLED WIRING  
PREINSTALACIÓN DEL CABLEADO**

IN0006

Preinstalled wiring consists in the addition of the necessary mechanisms to integrate power systems in the table, so that wiring is hidden until the way out in the floor. Necessary grommet are included and 3m cable (from the power system). For other cable dimensions contact the Sales Department. For each wire Reverse base, you must ask for one IN0006 to the Customer Department.

La preinstalación consiste en el montaje de los mecanismos necesarios para integrar el sistema de electrificación en la mesa, de modo que el cableado quede oculto hasta su salida por la base. Se incluyen los pasacables necesarios y 3 metros de cable (midiendo desde el sistema de conexiones). Por cada base por al que se desee bajar el cable se solicita un IN0006 al Departamento Comercial.

**3 CABLE WAY OUT SALIDA DE CABLEADO**

The cable way out can be performed directly from the power system or thru a canal in the base bottom, so that is hidden until it gets to the floor.

La salida del cable se realiza directamente desde el propio sistema como por unas canalizaciones en la parte inferior de la base, de modo que el cable queda oculto hasta llegar al suelo.

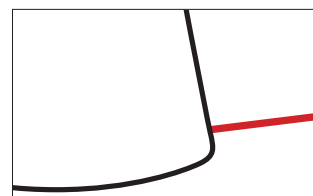

**QI CHARGING POWER BOXES  
CAJAS DE CONEXIONES QI**

The inductive charging station, allows maximum larger contact surface. Available in two finish: black or white. For lifting base versions contact the Customer Department.

La estación de carga inductiva permite una superficie de contacto máxima más grande. Disponible en dos acabados: negro o blanco. Para versiones de bases elevables consultar al Departamento Comercial.

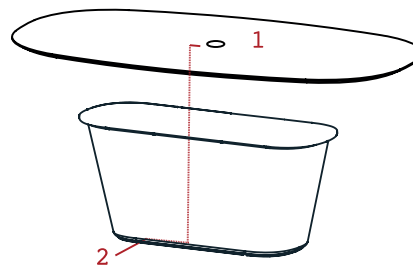

PS0714

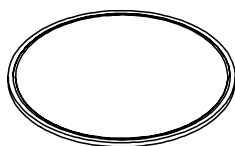

**1 POWER BOXES DISTRIBUTION DISTRIBUCIÓN DE SISTEMAS**

In tables with only one Reverse base power box can't be centered with the base. In tables with more than one base, by default power box is placed in the center of the table and in lengthwise direction. If more than one power box is installed, inform the Customer Department about the desired position.

En mesas con una sola base el sistema eléctrico iría instalado descentrado respecto a la base. En mesas con más de una base, por defecto la posición del sistema irá en el centro de la mesa y en sentido longitudinal. Si se solicita más de un sistema eléctrico, comunicar la posición deseada al Departamento Comercial.

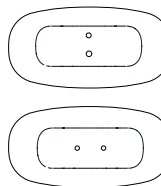

**OPTIONAL PREINSTALLED WIRING  
PREINSTALACIÓN DEL CABLEADO**

IN0006

Preinstalled wiring consists in the addition of the necessary mechanisms to integrate power systems in the table, so that wiring is hidden until the way out in the floor. Necessary grommet are included and 3m cable (from the power system). For other cable dimensions contact the Sales Department. For each wire Reverse base, you must ask for one IN0006 to the Customer Department.

La preinstalación consiste en el montaje de los mecanismos necesarios para integrar el sistema de electrificación en la mesa, de modo que el cableado quede oculto hasta su salida por la base. Se incluyen los pasacables necesarios y 3 metros de cable (midiendo desde el sistema de conexiones). Por cada base por al que se desee bajar el cable se solicita un IN0006 al Departamento Comercial.

**2 WIRING MANAGEMENT GESTIÓN DEL CABLEADO**

Wire pass through an aluminum grommet keeping it hidden. By default color is silver, for other finishings ask the Customer Department.

El cable se pasa a través de un perfil pasacables de aluminio que lo mantiene oculto. Su color de serie es el plata, para otros acabados consultar al Departamento Comercial.

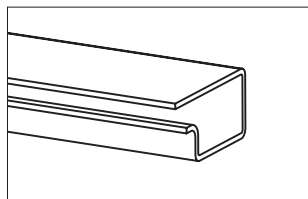

**3 CABLE WAY OUT SALIDA DE CABLEADO**

The cable way out can be performed directly from the power system or thru a canal in the base bottom, so that is hidden until it gets to the floor.

La salida del cable se realiza directamente desde el propio sistema como por unas canalizaciones en la parte inferior de la base, de modo que el cable queda oculto hasta llegar al suelo.

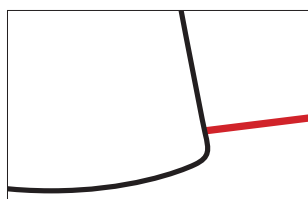



**INTEGRATED POWER BOXES  
CAJAS DE CONEXIONES INTEGRADAS**

The black finish is integrated with the top. Its opening is towards both sides. For lifting base versions contact the Customer Department.

El acabado negro está integrado con la parte superior. Su apertura es hacia ambos lados. Para versiones de bases elevables consultar al Departamento Comercial.

**PS0710**

**PS0720**

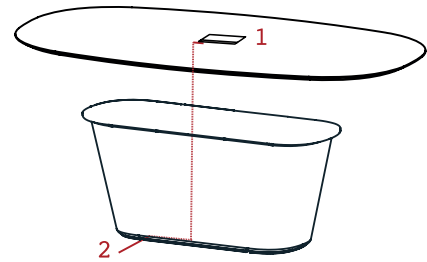
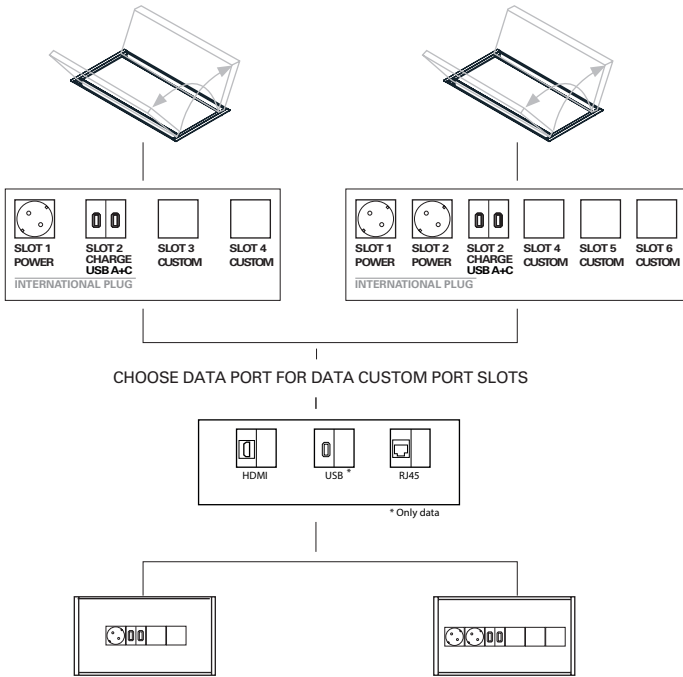

**1 POWER BOXES DISTRIBUTION DISTRIBUCIÓN DE SISTEMAS**

In tables with only one Reverse base power box can't be centered with the base. In tables with more than one base, by default power box is placed in the center of the table and in lengthwise direction. If more than one power box is installed, inform the Customer Department about the desired position.

En mesas con una sola base el sistema eléctrico iría instalado descentrado respecto a la base. En mesas con más de una base, por defecto la posición del sistema irá en el centro de la mesa y en sentido longitudinal. Si se solicita más de un sistema eléctrico, comunicar la posición deseada al Departamento Comercial.

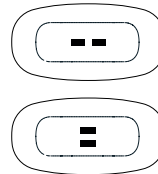

**2 WIRING MANAGEMENT GESTIÓN DEL CABLEADO**

Wire pass through an aluminum grommet keeping it hidden. By default color is silver, for other finishings ask the Customer Department.

El cable se pasa a través de un perfil pasacables de aluminio que lo mantiene oculto. Su color de serie es el plata, para otros acabados consultar al Departamento Comercial.

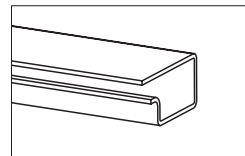

**OPTIONAL PREINSTALLED WIRING  
PREINSTALACIÓN DEL CABLEADO**

**IN0006**

Preinstalled wiring consists in the addition of the necessary mechanisms to integrate power systems in the table, so that wiring is hidden until the way out in the floor. Necessary grommet are included and 3m cable (from the power system). For other cable dimensions contact the Sales Department. For each wire Reverse base, you must ask for one IN0006 to the Customer Department.

La preinstalación consiste en el montaje de los mecanismos necesarios para integrar el sistema de electrificación en la mesa, de modo que el cableado quede oculto hasta su salida por la base. Se incluyen los pasacables necesarios y 3 metros de cable (midiendo desde el sistema de conexiones). Por cada base por al que se desee bajar el cable se solicita un IN0006 al Departamento Comercial.

**3 CABLE WAY OUT SALIDA DE CABLEADO**

The cable way out can be performed directly from the power system or thru a canal in the base bottom, so that is hidden until it gets to the floor.

La salida del cable se realiza directamente desde el propio sistema como por unas canalizaciones en la parte inferior de la base, de modo que el cable queda oculto hasta llegar al suelo.

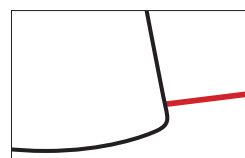

**UNDER-TOP POWER BOXES  
CAJA DE CONEXIONES BAJO EL SOBRE**

Power box mounted under the table top. Available in black or white color (silver or black in USA), for other finishing, contact the Customer Department. There are two power system sizes available and data slots can be customized according to the below diagram. For lifting base versions contact the Customer Department.

Regleta de conexiones bajo la superficie del sobre. Se sirve en color negro o blanco (plata o negro en USA. Para otros acabados consultar al departamento comercial. Se ofrecen formatos de caja de dos tamaños de caja diferentes y con opciones de conectividad configurable. Para versiones de bases elevables consultar al Departamento Comercial.

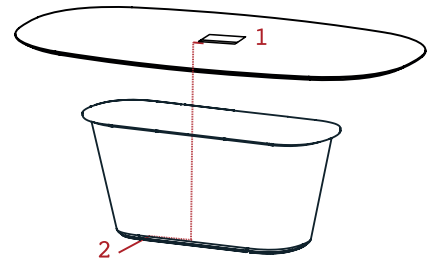

**PS0787**

**PS0788**

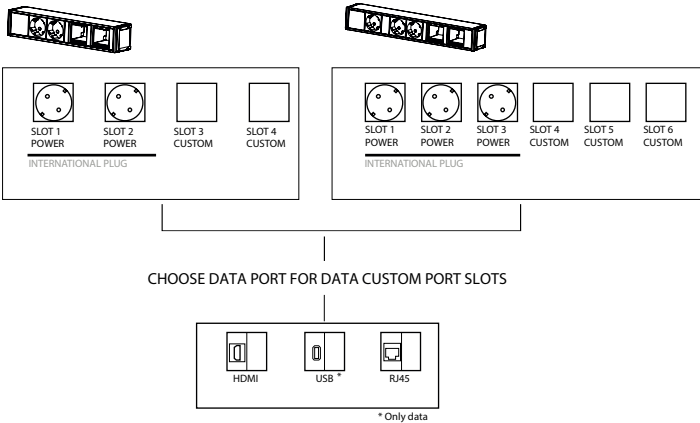

**PS0789**

**PS0790**

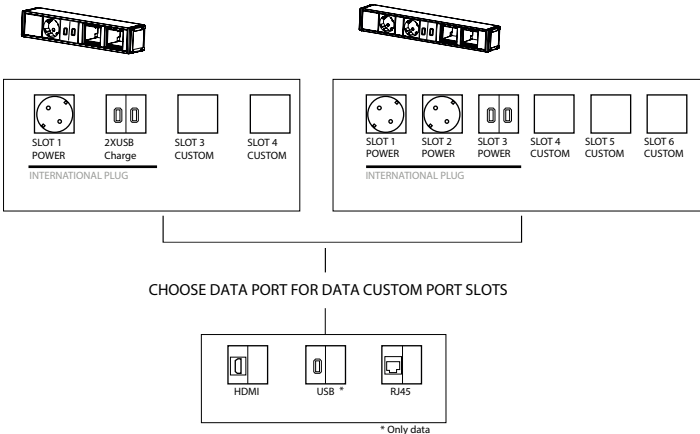

**1 POWER BOXES DISTRIBUTION DISTRIBUCIÓN DE SISTEMAS**

In tables with only one Reverse base power box can't be centered with the base. In tables with more than one base, by default power box is placed in the center of the table and in lengthwise direction. If more than one power box is installed, inform the Customer Department about the desired position.

En mesas con una sola base el sistema eléctrico iría instalado descentrado respecto a la base. En mesas con más de una base, por defecto la posición del sistema irá en el centro de la mesa y en sentido longitudinal. Si se solicita más de un sistema eléctrico, comunicar la posición deseada al Departamento Comercial.

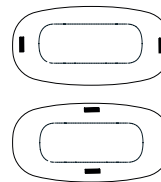

**2 WIRING MANAGEMENT GESTIÓN DEL CABLEADO**

Wire pass through an aluminum grommet keeping it hidden. By default color is silver, for other finishings ask the Customer Department.

El cable se pasa a través de un perfil pasacables de aluminio que lo mantiene oculto. Su color de serie es el plata, para otros acabados consultar al Departamento Comercial.

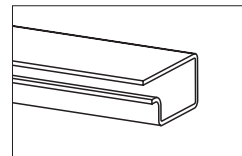

**OPTIONAL PREINSTALLED WIRING  
PREINSTALACIÓN DEL CABLEADO**

**IN0006**

Preinstalled wiring consists in the addition of the necessary mechanisms to integrate power systems in the table, so that wiring is hidden until the way out in the floor. Necessary grommet are included and 3m cable (from the power system). For other cable dimensions contact the Sales Department. For each wire Reverse base, you must ask for one IN0006 to the Customer Department.

La preinstalación consiste en el montaje de los mecanismos necesarios para integrar el sistema de electrificación en la mesa, de modo que el cableado quede oculto hasta su salida por la base. Se incluyen los pasacables necesarios y 3 metros de cable (midiendo desde el sistema de conexiones). Por cada base por al que se desee bajar el cable se solicita un IN0006 al Departamento Comercial.

**3 CABLE WAY OUT SALIDA DE CABLEADO**

The cable way out can be performed directly from the power system or thru a canal in the base bottom, so that is hidden until it gets to the floor.

La salida del cable se realiza directamente desde el propio sistema como por unas canalizaciones en la parte inferior de la base, de modo que el cable queda oculto hasta llegar al suelo.

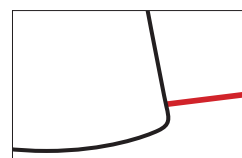

**IN-SURFACE SOCKET POWERS  
TORRES DE CONEXIONES DENTRO DEL SOBRE**

Socket tower mounted in the table top. The hidden system manually rises with a slight push. For lifting base versions contact the Customer Department. Available in silver, white or black color, for for other finishing, contact the Customer Department.

Torre de conexiones integrada dentro de la supercie del sobre. El sistema eléctrico oculto se alza manualmente al pulsarlo. Para versiones de bases elevables consultar al Departamento Comercial. Disponible en color plata, blanco o negro, para otros acabados consultar al Departamento Comercial.

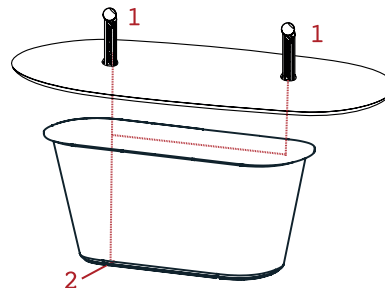

**PS0795**

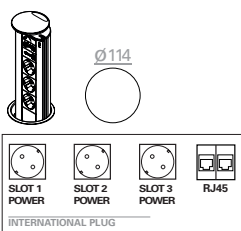

**PS0796**

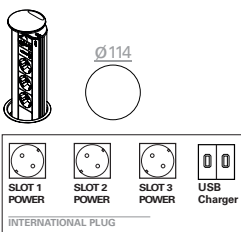

**OPTIONAL PREINSTALLED WIRING  
PREINSTALACIÓN DEL CABLEADO**

**IN0006**

Preinstalled wiring consists in the addition of the necessary mechanisms to integrate power systems in the table, so that wiring is hidden until the way out in the floor. Necessary grommet are included and 3m cable (from the power system). For other cable dimensions contact the Sales Department. For each wire Reverse base, you must ask for une IN0006 to the Customer Department.

La preinstalación consiste en el montaje de los mecanismos necesarios para integrar el sistema de electrificación en la mesa, de modo que el cableado quede oculto hasta su salida por la base. Se incluyen los pasacables necesarios y 3 metros de cable (midiéndolo desde el sistema de conexiones). Por cada base por al que se desee bajar el cable se solicita un IN0006 al Departamento Comercial.

**1 POWER BOXES DISTRIBUTION DISTRIBUCIÓN DE SISTEMAS**

In tables with only one Reverse base power box can't be centered with the base. In tables with more than one base, by default power box is placed in the center of the table and in lengthwise direction. If more than one power box is installed, inform the Customer Department about the desired position.

En mesas con más de una base, por defecto la posición del sistema irá en el centro de la mesa y en sentido longitudinal. Si se solicita más de un sistema eléctrico, comunicar la posición deseada al Departamento Comercial.

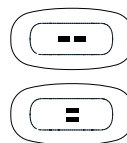

**2 WIRING MANAGEMENT GESTIÓN DEL CABLEADO**

Wire pass through an aluminum grommet keeping it hidden. By default color is silver, for other finishings ask the Customer Department.

El cable se pasa a través de un perfil pasacables de aluminio que lo mantiene oculto. Su color de serie es el plata, para otros acabados consultar al Departamento Comercial.

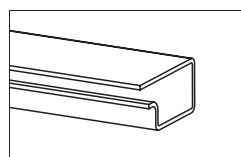

**3 CABLE WAY OUT SALIDA DE CABLEADO**

The cable way out can be performed directly from the power system or thru a canal in the base bottom, so that is hidden until it gets to the floor.

La salida del cable se realiza directamente desde el propio sistema como por unas canalizaciones en la parte inferior de la base, de modo que el cable queda oculto hasta llegar al suelo.

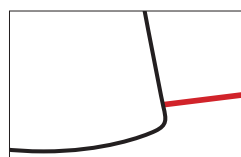









**Description** Table program available with different types of bases and table tops. Base of aluminum legs available in polished aluminum, anodized, white or black. Tops of different shapes and sizes, available in oak finish, lacquered, laminate, HPL, and glass. Available in 2 profile types, according to references. Connection box available.

**Descripción** Programa de mesas disponible con diferentes acabados de bases y sobres de mesa. Bases de patas de aluminio disponibles en acabado aluminio pulido, anodizado, blanco o negro. Sobres de tablero de diferentes medidas en acabado roble, lacado, laminado, laminado TP y cristal. Disponible 2 tipos de perfil, según referencias. Disponible caja de conexiones.

Programa de mesas disponible con diferentes acabados de bases y sobres de mesa. Bases de patas de aluminio disponibles en acabado aluminio pulido, anodizado, blanco o negro. Sobres de tablero de diferentes medidas en acabado roble, lacado, laminado, laminado TP y cristal. Disponible 2 tipos de perfil, según referencias. Disponible caja de conexiones.

<b>Wood finish Oak</b> <b>Acabado madera</b> <b>Roble</b>											
<b>Wood lacquer finish</b> <b>Acabado lacas madera</b>											
<b>Laminated</b> <b>Laminado</b>											
<b>Laminated TP</b> <b>Laminado TP</b>											
		Laminate table top with matching thermo-polymer edge. Sobre de mesa laminado con canto de termopolímero a juego.									
<b>Ultra-matte finish</b> <b>Acabado ultramate</b>				<b>Linoleum finish</b> <b>Acabado linóleo</b>							
<b>Glass finish</b> <b>Acabado de cristal</b>											
<b>M1 marble finish</b> <b>Acabado de mármol</b> <b>M1</b>			<b>Matt / Shiny</b> <b>Mate / Brillo</b>								
<b>M3 marble finish</b> <b>Acabado de mármol</b> <b>M3</b>			<b>Matt / Shiny</b> <b>Mate / Brillo</b>								
<b>Aluminum finish</b> <b>Acabado aluminio</b>											
<b>Power box</b> <b>Caja de conexiones</b>											

### Intellectual property Propiedad intelectual

All our collections are protected by international industrial design registries, designs patents, copyrights and intellectual Property laws. Unauthorized use of AW International Property is a criminal offence and can lead to prosecution.  
Todas nuestras colecciones están protegidas por registros de diseño industrial, diseño de patente, copyright y derechos de propiedad intelectual todo el mundo. El uso no autorizado de los diseños y propiedad intelectual de AW supone un delito que puede ser sometido a acción judicial.



2000 x 1200 x 745

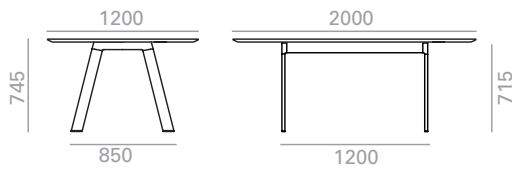

\*Matte lacquered and premium upcharge  
\*Incremento por lacado mate y premium

177

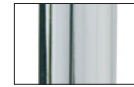

\*\*Polished chrome frame up charge  
\*\*Incremento por estructura en cromo brillo

165

\*\*\*Marble shiny upcharge  
Incremento por mármol brillo

30

Legs Patas	Table top / Sobre															
	*Oak Roble		Lacquered Lacado		Laminate Laminado		LaminateTP LaminadoTP		Low Iron Glass Cristal óptico		Linoleum Linóleo		Ultra-matte Ultramate		Ultra-matteTP UltramateTP	
Top Edge Perfil																
White/Black Blanco/Negro	ME 9000	2.782	ME 9003	2.192	ME 9006	2.961	ME 9009	2.840	ME 9012	3.027	ME 9367	3.334	ME 9370	3.350	ME 9373	3.221
kg	79		79		79		79		115		79		79		79	
1 box/ bulto	0.71 m3		0.71 m3		0.71 m3		0.71 m3		1.45 m3		0.71 m3		0.71 m3		0.71 m3	
Anodized Anodizado	ME 9001	2.761	ME 9004	2.170	ME 9007	2.938	ME 9010	2.816	ME 9013	3.005	ME 9368	3.356	ME 9371	3.375	ME 9374	3.244
kg	79		79		79		79		115		79		79		79	
1 box/ bulto	0.71 m3		0.71 m3		0.71 m3		0.71 m3		1.45 m3		0.71 m3		0.71 m3		0.71 m3	
**Polished Pulido	ME 9002	2.976	ME 9005	2.387	ME 9008	3.154	ME 9011	3.035	ME 9014	3.222	ME 9369	3.546	ME 9372	3.563	ME 9375	3.439
kg	79		79		79		79		115		79		79		79	
1 box/ bulto	0.71 m3		0.71 m3		0.71 m3		0.71 m3		1.45 m3		0.71 m3		0.71 m3		0.71 m3	
Oak Roble	ME 95845	3.114	ME 95846	2.507	ME 95847	3.300	ME 95848	3.173	ME 95849	3.364	ME 95850	3.511	ME 95851	3.531	ME 95852	3.429
kg	81		81		81		81		81		81		81		81	
1 box/ bulto	0.76 m3		0.76 m3		0.76 m3		0.76 m3		1.62 m3		0.76 m3		0.76 m3		0.76 m3	

Legs Patas	Table top / Sobre											
	Oak Roble		Lacquered Lacado		LaminateTP LaminadoTP		Ultra-matteTP UltramateTP		***M1 Marble Mármol M1		***M3 Marble Mármol M3	
Top Edge Perfil												
White/Black	ME 9015	2.580	ME 9018	2.192	ME 9021	2.004	ME 9376	2.192	ME 96265	5.193	ME 96267	8.131
kg	77		79		77		79		203		203	
2 boxes/ bultos	0.71 m3		0.71 m3		0.71 m3		0.71 m3		3.72 m3		3.72 m3	
Anodized	ME 9016	2.557	ME 9019	2.170	ME 9022	1.983	ME 9377	2.211	ME 96268	5.168	ME 96270	8.090
kg	77		79		77		79		203		203	
2 boxes/ bultos	0.71 m3		0.71 m3		0.71 m3		0.71 m3		3.72 m3		3.72 m3	
**Polished	ME 9017	2.771	ME 9020	2.387	ME 9023	2.197	ME 9378	2.405	ME 96271	5.337	ME 96273	8.354
kg	77		79		77		79		203		203	
2 boxes/ bultos	0.71 m3		0.71 m3		0.71 m3		0.71 m3		3.72 m3		3.72 m3	
Oak	ME 95853	2.901	ME 95854	2.507	ME 95855	2.314	ME 95856	2.391	ME 96274	5.470	ME 96276	8.563
kg	81		81		81		81		203		203	
2 boxes/ bultos	0.76 m3		0.76 m3		0.76 m3		0.76 m3		3.72 m3		3.72 m3	



2400 x 1200 x 745

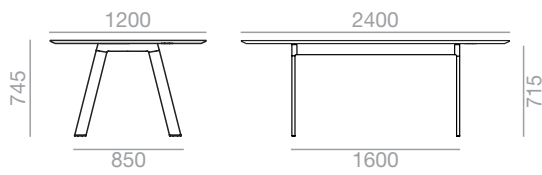

\*Matte lacquered and premium upcharge  
\*\*Incremento por lacado mate y premium

195

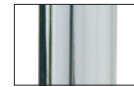

\*\*Polished chrome frame up charge  
\*\*Incremento por estructura en cromo brillo

165

\*\*\*Marble shiny upcharge  
Incremento por mármol brillo

30

Legs Patas	Table top / Sobre															
	Oak Roble		Lacquered Lacado		Laminate Laminado		LaminateTP LaminadoTP		Low Iron Glass Cristal óptico		Linoleum Linóleo		Ultra-matte Ultramate		Ultra-matteTP UltramateTP	
Top Edge Perfil																
White/Black	ME 9024	3.025	ME 9027	2.441	ME 9030	3.110	ME 9033	3.002	ME 9036	3.439	ME 9379	3.473	ME 9382	3.499	ME 9385	3.376
kg	93		93		93		93		136		94		94		94	
1 box/ bulto	0.84 m3		0.84 m3		0.84 m3		0.84 m3		1.71 m3		0.84 m3		0.84 m3		0.84 m3	
Anodized	ME 9025	2.995	ME 9028	2.408	ME 9031	3.078	ME 9034	2.970	ME 9037	3.407	ME 9380	3.506	ME 9383	3.527	ME 9386	3.411
kg	93		93		93		93		136		94		94		94	
1 box/ bulto	0.84 m3		0.84 m3		0.84 m3		0.84 m3		1.71 m3		0.84 m3		0.84 m3		0.84 m3	
**Polished	ME 9026	3.229	ME 9029	2.644	ME 9032	3.315	ME 9035	3.206	ME 9038	3.642	ME 9381	3.706	ME 9384	3.757	ME 9387	3.613
kg	93		93		93		93		136		94		94		94	
1 box/ bulto	0.84 m3		0.84 m3		0.84 m3		0.84 m3		1.71 m3		0.84 m3		0.84 m3		0.84 m3	
Oak	ME 95857	3.363	ME 95858	2.761	ME 95859	3.452	ME 95860	3.338	ME 95861	3.787	ME 95862	3.651	ME 95863	3.673	ME 95864	3.593
kg	94		94		94		94		94		94		94		94	
1 box/ bulto	0.84 m3		0.84 m3		0.84 m3		0.84 m3		1.71 m3		0.84 m3		0.84 m3		0.84 m3	

Legs Patas	Table top / Sobre											
	Oak Roble		Lacquered Lacado		LaminateTP LaminadoTP		Ultra-matteTP UltramateTP		***M1 Marble Mármol M1		***M3 Marble Mármol M3	
Top Edge Perfil												
White/Black	ME 9039	2.910	ME 9042	2.441	ME 9045	2.133	ME 9388	2.427	ME 96277	5.436	ME 96279	8.637
kg	90		93		90		94		235		235	
2 boxes/ bultos	0.84 m3		0.84 m3		0.84 m3		0.84 m3		3.87 m3		3.87 m3	
Anodized	ME 9040	2.877	ME 9043	2.408	ME 9046	2.101	ME 9389	2.454	ME 96280	5.411	ME 96282	8.599
kg	90		93		90		94		235		235	
2 boxes/ bultos	0.84 m3		0.84 m3		0.84 m3		0.84 m3		3.87 m3		3.87 m3	
**Polished	ME 9041	3.114	ME 9044	2.644	ME 9047	2.388	ME 9390	2.709	ME 96283	5.586	ME 96285	8.877
kg	90		93		90		94		235		235	
2 boxes/ bultos	0.84 m3		0.84 m3		0.84 m3		0.84 m3		3.87 m3		3.87 m3	
Oak	ME 95865	3.240	ME 95866	2.761	ME 95867	2.443	ME 95868	2.622	ME 96286	5.728	ME 96288	9.101
kg	94		94		94		94		235		235	
2 boxes/ bultos	0.84 m3		0.84 m3		0.84 m3		0.84 m3		3.87 m3		3.87 m3	

2800x 1200 x 745

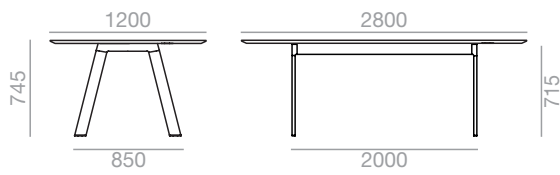

\*Matte lacquered and premium upcharge  
\*Incremento por lacado mate y premium

213



\*\*Polished chrome frame up charge  
\*\*Incremento por estructura en cromo brillo

165

\*\*\*Marble shiny upcharge  
Incremento por mármol brillo

30

Legs Patas	Table top / Sobre															
	Oak Roble		Lacquered Lacado		Laminate Laminado		LaminateTP LaminadoTP		Low Iron Glass Cristal óptico		Linoleum Linóleo		Ultra-matte Ultramate		Ultra-matteTP UltramateTP	
Top Edge Perfil																
White/Black Blanco/Negro	ME 9048	3.683	ME 9051	2.691	ME 9054	3.897	ME 9057	3.687	ME 9060	3.856	ME 9391	4.422	ME 9394	4.430	ME 9397	4.160
kg	106		106		106		106		156		108		108		108	
1 box/ bulto	0.98 m3		0.98 m3		0.98 m3		0.98 m3		4.2 m3		0.98 m3		0.98 m3		0.98 m3	
Anodized Anodizado	ME 9049	3.642	ME 9052	2.649	ME 9055	3.856	ME 9058	3.647	ME 9061	3.816	ME 9392	4.459	ME 9395	4.472	ME 9398	4.203
kg	106		106		106		106		156		108		108		108	
1 box/ bulto	0.98 m3		0.98 m3		0.98 m3		0.98 m3		4.2 m3		0.98 m3		0.98 m3		0.98 m3	
**Polished Pulido	ME 9050	3.897	ME 9053	2.904	ME 9056	4.111	ME 9059	3.900	ME 9062	4.069	ME 9393	4.672	ME 9396	4.684	ME 9399	4.418
kg	106		106		106		106		156		108		108		108	
1 box/ bulto	0.98 m3		0.98 m3		0.98 m3		0.98 m3		4.2 m3		0.98 m3		0.98 m3		0.98 m3	
Oak Roble	ME 95869	4.040	ME 95870	3.016	ME 95871	4.261	ME 95872	4.046	ME 95873	4.219	ME 95874	4.583	ME 95875	4.587	ME 95876	4.373
kg	108		108		108		108		108		108		108		108	
1 box/ bulto	0.98 m3		0.98 m3		0.98 m3		0.98 m3		4.2 m3		0.98 m3		0.98 m3		0.98 m3	

Legs Patas	Table top / Sobre											
	Oak Roble		Lacquered Lacado		LaminateTP LaminadoTP		Ultra-matteTP UltramateTP		***M1 Marble Mármol M1		***M3 Marble Mármol M3	
Top Edge Perfil												
White/Black Blanco/Negro	ME 9063	3.252	ME 9066	2.691	ME 9069	2.464	ME 9400	2.899	ME 96289	5.958	ME 96291	9.694
kg	103		106		103		108		268		268	
Anodized Anodizado	ME 9064	3.210	ME 9067	2.649	ME 9070	2.424	ME 9401	2.755	ME 96292	5.932	ME 96294	9.650
kg	103		106		103		108		268		268	
2 boxes/ bultos	0.98 m3		0.98 m3		0.98 m3		0.98 m3		4.59 m3		4.59 m3	
**Polished Pulido	ME 9065	3.466	ME 9068	2.904	ME 9071	2.677	ME 9402	2.968	ME 96295	6.125	ME 96297	9.964
kg	103		106		103		108		268		268	
2 boxes/ bultos	0.98 m3		0.98 m3		0.98 m3		0.98 m3		4.59 m3		4.59 m3	
Oak Roble	ME 95877	3.597	ME 95878	3.016	ME 95879	2.785	ME 95880	2.901	ME 96298	6.278	ME 96300	10.216
kg	108		108		108		108		268		268	
2 boxes/ bultos	0.98 m3		0.98 m3		0.98 m3		0.98 m3		4.59 m3		4.59 m3	

3000 x 1500 x 745

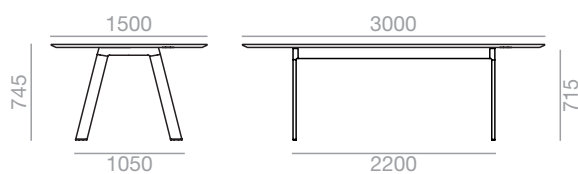

\*Matte lacquered and premium upcharge  
\*Incremento por lacado mate y premium

306



\*\*Polished chrome frame up charge  
\*\*Incremento por estructura en cromo brillo

165

\*\*\*Marble shiny upcharge  
Incremento por mármol brillo

30

Legs Patas	Table top / Sobre															
	Oak Roble		Lacquered Lacado		Laminate Laminado		LaminateTP LaminadoTP		Low Iron Glass Cristal óptico		Linoleum Linóleo		Ultra-matte Ultramate		Ultra-matteTP UltramateTP	
Top Edge Perfil																
White/Black Blanco/Negro	ME 9072	4.083	ME 9075	3.114	ME 9078	4.085	ME 9081	3.901	ME 9084	4.635	ME 9403	4.467	ME 9406	4.615	ME 9409	4.402
kg	133		133		133		133		200		138		138		138	
1 box/ bulto	1.29 m3		1.29 m3		1.29 m3		1.29 m3		1.29 m3		1.29 m3		1.29 m3		1.29 m3	
Anodized Anodizado	ME 9073	4.036	ME 9076	3.064	ME 9079	4.037	ME 9082	3.855	ME 9085	4.586	ME 9404	4.511	ME 9407	4.659	ME 9410	4.451
kg	133		133		133		133		200		138		138		138	
1 box/ bulto	1.29 m3		1.29 m3		1.29 m3		1.29 m3		1.29 m3		1.29 m3		1.29 m3		1.29 m3	
**Polished Pulido	ME 9074	4.356	ME 9077	3.388	ME 9080	4.357	ME 9083	4.175	ME 9086	4.907	ME 9405	4.783	ME 9408	4.968	ME 9411	4.723
kg	133		133		133		133		200		138		138		138	
1 box/ bulto	1.29 m3		1.29 m3		1.29 m3		1.29 m3		1.29 m3		1.29 m3		1.29 m3		1.29 m3	
Oak Roble	ME 95881	4.452	ME 95882	3.452	ME 95883	4.454	ME 95884	4.265	ME 95885	5.407	ME 95886	4.625	ME 95887	4.772	ME 95888	4.615
kg	138		138		138		138		138		138		138		138	
1 box/ bulto	1.29 m3		1.29 m3		1.29 m3		1.29 m3		5.44 m3		1.29 m3		1.29 m3		1.29 m3	

Legs Patas	Table top / Sobre											
	Oak Roble		Lacquered Lacado		LaminateTP LaminadoTP		Ultra-matteTP UltramateTP		***M1 Marble Mármol M1		***M3 Marble Mármol M3	
Top Edge Perfil												
White/Black Blanco/Negro	ME 9087	3.834	ME 9090	3.114	ME 9093	2.609	ME 9412	3.005	ME 96301	7.282	ME 96303	12.287
kg	128		133		128		138		341		341	
2 boxes/ bultos	1.29 m3		1.29 m3		1.29 m3		1.29 m3		5.89 m3		5.89 m3	
Anodized Anodizado	ME 9088	3.787	ME 9091	3.064	ME 9094	2.561	ME 9413	3.051	ME 96304	7.249	ME 96306	12.227
kg	128		133		128		138		341		341	
2 boxes/ bultos	1.29 m3		1.29 m3		1.29 m3		1.29 m3		5.89 m3		5.89 m3	
**Polished Pulido	ME 9089	4.108	ME 9092	3.388	ME 9095	2.882	ME 9414	3.321	ME 96307	7.484	ME 96309	12.625
kg	128		133		128		138		341		341	
2 boxes/ bultos	1.29 m3		1.29 m3		1.29 m3		1.29 m3		5.89 m3		5.89 m3	
Oak Roble	ME 95889	4.195	ME 95890	3.452	ME 95891	2.936	ME 95892	3.192	ME 96310	7.671	ME 96312	12.943
kg	138		138		138		138		341		341	
2 boxes/ bultos	1.29 m3		1.29 m3		1.29 m3		1.29 m3		5.89 m3		5.89 m3	

3500 x 1500 x 745

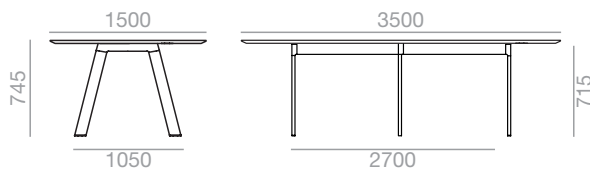

\*Matte lacquered and premium upcharge  
\*Incremento por lacado mate y premium

357



\*\*Polished chrome frame up charge  
\*\*Incremento por estructura en cromo brillo

165

\*\*\*Marble shiny upcharge  
Incremento por mármol brillo

30

Legs Patas	Table top / Sobre															
	Oak Roble		Lacquered Lacado		Laminate Laminado		LaminateTP LaminadoTP		Low Iron Glass Cristal óptico		Linoleum Linóleo		Ultra-matte Ultramate		Ultra-matteTP UltramateTP	
Top Edge Perfil																
White/Black Blanco/Negro	ME 9096	5.876	ME 9099	4.151	ME 9102	5.452	ME 9105	5.227	ME 9108	5.897	ME 9415	6.158	ME 9418	6.679	ME 9421	5.913
kg	162		162		162		162		240		169		169		169	
2 boxes/ bultos	1.54 m3		1.54 m3		1.54 m3		1.54 m3		3.12 m3		1.54 m3		1.54 m3		1.54 m3	
Anodized Anodizado	ME 9097	5.825	ME 9100	4.100	ME 9103	5.401	ME 9106	5.175	ME 9109	5.844	ME 9416	6.208	ME 9419	6.730	ME 9422	5.964
kg	162		162		162		162		240		169		169		169	
2 boxes/ bultos	1.54 m3		1.54 m3		1.54 m3		1.54 m3		3.12 m3		1.54 m3		1.54 m3		1.54 m3	
**Polished Pulido	ME 9098	6.242	ME 9101	4.516	ME 9104	5.818	ME 9107	5.593	ME 9110	6.261	ME 9417	6.569	ME 9420	7.089	ME 9423	6.328
kg	162		162		162		162		240		169		169		169	
2 boxes/ bultos	1.54 m3		1.54 m3		1.54 m3		1.54 m3		3.12 m3		1.54 m3		1.54 m3		1.54 m3	
Oak Roble	ME 95893	6.427	ME 95894	4.645	ME 95895	5.989	ME 95896	5.752	ME 95897	6.444	ME 95898	6.409	ME 95899	6.918	ME 95900	6.221
kg	169		169		169		169		169		169		169		169	
2 boxes/ bultos	1.54 m3		1.54 m3		1.54 m3		1.54 m3		3.12 m3		1.54 m3		1.54 m3		1.54 m3	

Legs Patas	Table top / Sobre											
	Oak Roble		Lacquered Lacado		LaminateTP LaminadoTP		Ultra-matteTP UltramateTP		***M1 Marble Mármol M1		***M3 Marble Mármol M3	
Top Edge Perfil												
White/Black Blanco/Negro	ME 9111	5.024	ME 9114	4.151	ME 9117	3.611	ME 9424	4.139	ME 96313	8.408	ME 96315	14.245
kg	156		162		156		169		432		432	
3 boxes/ bultos	1.54 m3		1.54 m3		1.54 m3		1.54 m3		7.14 m3		7.14 m3	
Anodized Anodizado	ME 9112	4.972	ME 9115	4.100	ME 9118	3.560	ME 9425	4.192	ME 96316	8.371	ME 96318	14.180
kg	156		162		156		169		432		432	
3 boxes/ bultos	1.54 m3		1.54 m3		1.54 m3		1.54 m3		7.14 m3		7.14 m3	
**Polished Pulido	ME 9113	5.390	ME 9116	4.516	ME 9119	3.975	ME 9426	4.553	ME 96319	8.644	ME 96321	14.642
kg	156		162		156		169		432		432	
3 boxes/ bultos	1.54 m3		1.54 m3		1.54 m3		1.54 m3		7.14 m3		7.14 m3	
Oak Roble	ME 95901	5.543	ME 95902	4.645	ME 95903	4.094	ME 95904	4.424	ME 96322	8.860	ME 96324	15.009
kg	169		169		169		169		432		432	
3 boxes/ bultos	1.54 m3		1.54 m3		1.54 m3		1.54 m3		7.14 m3		7.14 m3	

4000 x 1500 x 745

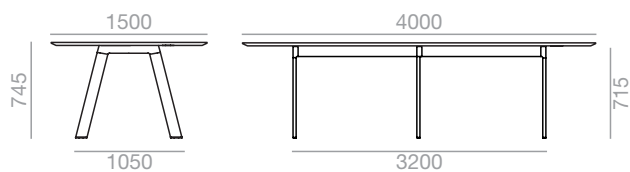

\*Matte lacquered and premium upcharge  
\*Incremento por lacado mate y premium

408



\*\*Polished chrome frame up charge  
\*\*Incremento por estructura en cromo brillo

165

\*\*\*Marble shiny upcharge  
Incremento por mármol brillo

30

Legs Patas	Table top / Sobre															
	*Oak Roble		Lacquered Lacado		Laminate Laminado		LaminateTP LaminadoTP		Low Iron Glass Cristal óptico		Linoleum Linóleo		Ultra-matte Ultramate		Ultra-matteTP UltramateTP	
Top Edge Perfil																
White/Black Blanco/Negro	ME 9120	6.540	ME 9123	4.805	ME 9126	6.195	ME 9129	5.885	ME 9132	7.158	ME 9427	6.996	ME 9430	7.592	ME 9433	6.659
kg	182		182		182		182		271		191		191		191	
2 boxes/ bultos	1.75 m3		1.75 m3		1.75 m3		1.75 m3		3.52 m3		1.75 m3		1.75 m3		1.75 m3	
Anodized Anodizado	ME 9121	6.477	ME 9124	4.744	ME 9127	6.135	ME 9130	5.821	ME 9133	7.097	ME 9428	7.059	ME 9431	7.653	ME 9434	6.721
kg	182		182		182		182		271		191		191		191	
2 boxes/ bultos	1.75 m3		1.75 m3		1.75 m3		1.75 m3		3.52 m3		1.75 m3		1.75 m3		1.75 m3	
**Polished Pulido	ME 9122	6.918	ME 9125	5.184	ME 9128	6.575	ME 9131	6.263	ME 9134	7.536	ME 9429	7.431	ME 9432	8.031	ME 9435	7.101
kg	182		182		182		182		271		191		191		191	
2 boxes/ bultos	1.75 m3		1.75 m3		1.75 m3		1.75 m3		3.52 m3		1.75 m3		1.75 m3		1.75 m3	
Oak Roble	ME 95905	7.105	ME 95906	5.319	ME 95907	6.755	ME 95908	6.437	ME 95909	7.744	ME 95910	7.230	ME 95911	7.811	ME 95912	6.966
kg	191		191		191		191		191		191		191		191	
2 boxes/ bultos	1.75 m3		1.75 m3		1.75 m3		1.75 m3		3.52 m3		1.75 m3		1.75 m3		1.75 m3	

Legs Patas	Table top / Sobre											
	*Oak Roble		Lacquered Lacado		LaminateTP LaminadoTP		Ultra-matteTP UltramateTP		***M1 Marble Mármol M1		***M3 Marble Mármol M3	
Top Edge Perfil												
White/Black Blanco/Negro	ME 9135	5.894	ME 9138	4.805	ME 9141	3.952	ME 9436	4.550	ME 96325	9.813	ME 96327	16.484
kg	176		182		176		191		481		481	
3 boxes/ bultos	1.75 m3		1.75 m3		1.75 m3		1.75 m3		7.98 m3		7.98 m3	
Anodized Anodizado	ME 9136	5.830	ME 9139	4.744	ME 9142	3.891	ME 9437	4.611	ME 96328	9.767	ME 96330	16.405
kg	176		182		176		191		481		481	
3 boxes/ bultos	1.75 m3		1.75 m3		1.75 m3		1.75 m3		7.98 m3		7.98 m3	
**Polished Pulido	ME 9137	6.270	ME 9140	5.184	ME 9143	4.330	ME 9438	4.988	ME 96331	10.085	ME 96333	16.940
kg	176		182		176		191		481		481	
3 boxes/ bultos	1.75 m3		1.75 m3		1.75 m3		1.75 m3		7.98 m3		7.98 m3	
Oak Roble	ME 95913	6.438	ME 95914	5.319	ME 95915	4.439	ME 95916	4.821	ME 96334	10.336	ME 96336	17.367
kg	191		191		191		191		481		481	
3 boxes/ bultos	1.75 m3		1.75 m3		1.75 m3		1.75 m3		7.98 m3		7.98 m3	

4500 x 1500 x 745

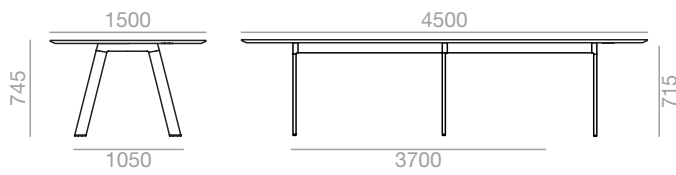

\*Matte lacquered and premium upcharge  
 \*Incremento por lacado mate y premium

459



\*\*Polished chrome frame up charge  
 \*\*Incremento por estructura en cromo brillo

165

\*\*\*Marble shiny upcharge  
 Incremento por mármol brillo

30

Legs Patas	Table top / Sobre															
	*Oak Roble		Lacquered Lacado		Laminate Laminado		LaminateTP LaminadoTP		Low Iron Glass Cristal óptico		Linoleum Linóleo		Ultra-matte Ultramate		Ultra-matteTP UltramateTP	
Top Edge Perfil																
White/Black Blanco/Negro	ME 9144	6.995	ME 9147	5.228	ME 9150	6.915	ME 9153	6.544	ME 9156	7.876	ME 9439	7.698	ME 9442	8.293	ME 9445	7.364
kg	202		202		202		202		302		213		213		213	
2 boxes/ bultos	1.96 m3		1.96 m3		1.96 m3		1.96 m3		3.92 m3		1.96 m3		1.96 m3		1.96 m3	
Anodized Anodizado	ME 9145	6.919	ME 9148	5.151	ME 9151	6.839	ME 9154	6.467	ME 9157	7.800	ME 9440	7.775	ME 9443	8.372	ME 9446	7.440
kg	202		202		202		202		302		213		213		213	
2 boxes/ bultos	1.96 m3		1.96 m3		0.47 m3		1.96 m3		3.92 m3		1.96 m3		1.96 m3		1.96 m3	
**Polished Pulido	ME 9146	7.384	ME 9149	5.616	ME 9152	7.305	ME 9155	6.934	ME 9158	8.265	ME 9441	8.158	ME 9444	8.757	ME 9447	7.829
kg	202		202		202		202		302		213		213		213	
2 boxes/ bultos	1.96 m3		1.96 m3		1.96 m3		1.96 m3		3.92 m3		1.96 m3		1.96 m3		1.96 m3	
Oak Roble	ME 95917	7.575	ME 95918	5.752	ME 95919	7.494	ME 95920	7.109	ME 95921	8.483	ME 95922	7.919	ME 95923	8.499	ME 95924	7.675
kg	213		213		213		213		213		213		213		213	
2 boxes/ bultos	1.96 m3		1.96 m3		1.96 m3		1.96 m3		3.92 m3		1.96 m3		1.96 m3		1.96 m3	

Legs Patas	Table top / Sobre											
	*Oak Roble		Lacquered Lacado		LaminateTP LaminadoTP		Ultra-matteTP UltramateTP		***M1 Marble Mármol M1		***M3 Marble Mármol M3	
Top Edge Perfil												
White/Black Blanco/Negro	ME 9159	6.479	ME 9162	5.228	ME 9165	4.294	ME 9448	4.959	ME 96337	10.362	ME 96339	17.867
kg	195		202		195		213		531		531	
3 boxes/ bultos	1.96 m3		1.96 m3		1.96 m3		1.96 m3		8.92 m3		8.92 m3	
Anodized Anodizado	ME 9160	6.404	ME 9163	5.151	ME 9166	4.218	ME 9449	5.033	ME 96340	10.314	ME 96342	17.787
kg	195		202		195		213		531		531	
3 boxes/ bultos	1.96 m3		1.96 m3		1.96 m3		1.96 m3		8.92 m3		8.92 m3	
**Polished Pulido	ME 9161	6.868	ME 9164	5.616	ME 9167	4.681	ME 9450	5.418	ME 96343	10.651	ME 96345	18.363
kg	195		202		195		213		531		531	
3 boxes/ bultos	1.96 m3		1.96 m3		1.96 m3		1.96 m3		8.92 m3		8.92 m3	
Oak Roble	ME 95925	7.045	ME 95926	5.752	ME 95927	4.790	ME 95928	5.225	ME 96346	10.918	ME 96348	18.827
kg	213		213		213		213		531		531	
3 boxes/ bultos	1.96 m3		1.96 m3		1.96 m3		1.96 m3		8.92 m3		8.92 m3	

## 5000 x 1500 x 745

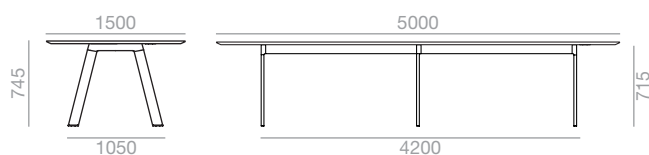

\*Matte lacquered and premium upcharge  
 \*Incremento por lacado mate y premium

510



\*\*Polished chrome frame up charge  
 \*\*Incremento por estructura en cromo brillo

165

\*\*\*Marble shiny upcharge  
 Incremento por mármol brillo

30

Legs Patas	Table top / Sobre															
	*Oak Roble		Lacquered Lacado		Laminate Laminado		LaminateTP LaminadoTP		Low Iron Glass Cristal óptico		Linoleum Linóleo		Ultra-matte Ultramate		Ultra-matteTP UltramateTP	
Top Edge Perfil																
White/Black Blanco/Negro	ME 9168	7.450	ME 9171	5.654	ME 9174	7.636	ME 9177	7.206	ME 9180	8.601	ME 9451	8.408	ME 9454	9.002	ME 9457	8.129
kg	222		222		222		222		333		235		235		235	
2 boxes/ bultos	2.16 m3		2.16 m3		2.16 m3		2.16 m3		9.18 m3		2.16 m3		2.16 m3		2.16 m3	
Anodized Anodizado	ME 9169	7.366	ME 9172	5.568	ME 9175	7.550	ME 9178	7.122	ME 9181	8.514	ME 9452	8.495	ME 9455	9.090	ME 9458	8.215
kg	222		222		222		222		333		235		235		235	
2 boxes/ bultos	2.16 m3		2.16 m3		2.16 m3		2.16 m3		9.18 m3		2.16 m3		2.16 m3		2.16 m3	
**Polished Pulido	ME 9170	7.853	ME 9173	6.058	ME 9176	8.039	ME 9179	7.611	ME 9182	9.004	ME 9453	8.892	ME 9456	9.488	ME 9459	8.621
kg	222		222		222		222		333		235		235		235	
2 boxes/ bultos	2.16 m3		2.16 m3		2.16 m3		2.16 m3		9.18 m3		2.16 m3		2.16 m3		2.16 m3	
Oak Roble	ME 95929	8.045	ME 95930	6.192	ME 95931	8.236	ME 95932	7.791	ME 95933	9.229	ME 95934	8.621	ME 95935	9.201	ME 95936	8.436
kg	235		235		235		235		235		235		235		235	
2 boxes/ bultos	2.16 m3		2.16 m3		2.16 m3		2.16 m3		9.18 m3		2.16 m3		2.16 m3		2.16 m3	

Legs Patas	Table top / Sobre											
	*Oak Roble		Lacquered Lacado		LaminateTP LaminadoTP		Ultra-matteTP UltramateTP		***M1 Marble Mármol M1		***M3 Marble Mármol M3	
Top Edge Perfil												
White/Black Blanco/Negro	ME 9183	7.065	ME 9186	5.654	ME 9189	4.638	ME 9460	5.387	ME 96349	10.948	ME 96351	19.286
kg	214		222		214		235		581		581	
3 boxes/ bultos	2.16 m3		2.16 m3		2.16 m3		2.16 m3		9.78 m3		9.78 m3	
Anodized Anodizado	ME 9184	6.982	ME 9187	5.568	ME 9190	4.556	ME 9461	5.473	ME 96352	10.896	ME 96354	19.197
kg	214		222		214		235		581		581	
3 boxes/ bultos	2.16 m3		2.16 m3		2.16 m3		2.16 m3		9.78 m3		9.78 m3	
**Polished Pulido	ME 9185	7.471	ME 9188	6.058	ME 9191	5.043	ME 9462	5.869	ME 96355	11.251	ME 96357	19.822
kg	214		222		214		235		581		581	
3 boxes/ bultos	2.16 m3		2.16 m3		2.16 m3		2.16 m3		9.78 m3		9.78 m3	
Oak Roble	ME 95937	7.647	ME 95938	6.192	ME 95939	5.153	ME 95940	5.650	ME 96358	11.534	ME 96360	20.319
kg	235		235		235		235		581		581	
3 boxes/ bultos	2.16 m3		2.16 m3		2.16 m3		2.16 m3		9.78 m3		10.73 m3	

5500 x 1500 x 745

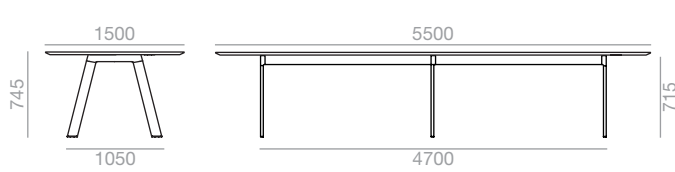

\*Matte lacquered and premium upcharge  
\*Incremento por lacado mate y premium

561



\*\*Polished chrome frame up charge  
\*\*Incremento por estructura en cromo brillo

165

\*\*\*Marble shiny upcharge  
Incremento por mármol brillo

30

Legs Patas	Table top / Sobre															
	*Oak Roble		Lacquered Lacado		Laminate Laminado		LaminateTP LaminadoTP		Low Iron Glass Cristal óptico		Linoleum Linóleo		Ultra-matte Ultramate		Ultra-matteTP UltramateTP	
Top Edge Perfil																
White/Black Blanco/Negro	ME 9192	7.952	ME 9195	6.068	ME 9198	7.872	ME 9201	7.476	ME 9204	9.313	ME 9463	8.634	ME 9466	9.234	ME 9469	8.447
kg	242		242		242		242		364		257		257		257	
2 boxes/ bultos	2.37 m3		2.37 m3		2.37 m3		2.37 m3		10.03 m3		2.37 m3		2.37 m3		2.37 m3	
Anodized Anodizado	ME 9193	7.855	ME 9196	5.973	ME 9199	7.775	ME 9202	7.380	ME 9205	9.217	ME 9464	8.732	ME 9467	9.329	ME 9470	8.544
kg	242		242		242		242		364		257		257		257	
2 boxes/ bultos	2.37 m3		2.37 m3		2.37 m3		2.37 m3		10.03 m3		2.37 m3		2.37 m3		2.37 m3	
**Polished Pulido	ME 9194	8.368	ME 9197	6.486	ME 9200	8.289	ME 9203	7.893	ME 9206	9.730	ME 9465	9.143	ME 9468	9.742	ME 9471	8.959
kg	242		242		242		242		364		257		257		257	
2 boxes/ bultos	2.37 m3		2.37 m3		2.37 m3		2.37 m3		10.03 m3		2.37 m3		2.37 m3		2.37 m3	
Oak Roble	ME 95941	8.563	ME 95942	6.620	ME 95943	8.483	ME 95944	8.077	ME 95945	9.963	ME 95946	8.842	ME 95947	9.434	ME 95948	8.757
kg	257		257		257		257		257		257		257		257	
2 boxes/ bultos	2.4 m3		2.4 m3		2.4 m3		2.4 m3		10.03 m3		2.4 m3		2.4 m3		2.4 m3	

Legs Patas	Table top / Sobre											
	*Oak Roble		Lacquered Lacado		LaminateTP LaminadoTP		Ultra-matteTP UltramateTP		***M1 Marble Mármol M1		***M3 Marble Mármol M3	
Top Edge Perfil												
White/Black Blanco/Negro	ME 9207	7.647	ME 9210	6.068	ME 9213	4.972	ME 9472	5.777	ME 96361	11.642	ME 96363	20.814
kg	233		242		233		257		631		631	
3 boxes/ bultos	2.37 m3		2.37 m3		2.37 m3		2.37 m3		10.73 m3		10.73 m3	
Anodized Anodizado	ME 9208	7.551	ME 9211	5.973	ME 9214	4.876	ME 9473	5.869	ME 96364	11.587	ME 96366	20.717
kg	233		242		233		257		631		631	
3 boxes/ bultos	2.37 m3		2.37 m3		2.37 m3		2.37 m3		10.73 m3		10.73 m3	
**Polished Pulido	ME 9209	8.065	ME 9212	6.486	ME 9215	5.391	ME 9474	6.285	ME 96367	11.964	ME 96369	21.391
kg	233		242		233		257		631		631	
3 boxes/ bultos	2.37 m3		2.37 m3		2.37 m3		2.37 m3		10.73 m3		10.73 m3	
Oak Roble	ME 95949	8.248	ME 95950	6.620	ME 95951	5.496	ME 95952	6.032	ME 96370	12.265	ME 96372	21.931
kg	257		257		257		257		631		631	
3 boxes/ bultos	2.4 m3		2.4 m3		2.4 m3		2.4 m3		10.73 m3		10.73 m3	



∅1200 x 745

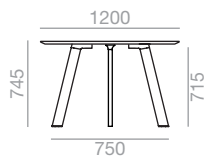

\*Matte lacquered and premium upcharge  
\*\*Incremento por lacado mate y premium

138



\*\*Polished chrome frame up charge  
\*\*Incremento por estructura en cromo brillo

165

\*\*\*Marble shiny upcharge  
Incremento por mármol brillo

30

Legs Patas	Table top / Sobre															
	*Oak Roble		Lacquered Lacado		Laminate Laminado		LaminateTP LaminadoTP		Low Iron Glass Cristal óptico		Linoleum Linóleo		Ultra-matte Ultramate		Ultra-matteTP UltramateTP	
Top Edge Perfil																
White/Black Blanco/Negro	ME 9288	1.798	ME 9291	1.451	ME 9294	1.804	ME 9297	1.832	ME 9300	2.075	ME 9475	1.991	ME 9478	1.928	ME 9481	2.029
kg	40		40		40		40		57		36		36		36	
1 box/ bulto	0.44 m3		0.44 m3		0.44 m3		0.44 m3		0.92 m3		0.44 m3		0.44 m3		0.44 m3	
Anodized Anodizado	ME 9289	1.745	ME 9292	1.397	ME 9295	1.752	ME 9298	1.779	ME 9301	2.022	ME 9476	2.039	ME 9479	1.984	ME 9482	2.083
kg	40		40		40		40		57		36		36		36	
1 box/ bulto	0.44 m3		0.44 m3		0.44 m3		0.44 m3		0.92 m3		0.44 m3		0.44 m3		0.44 m3	
**Polished Pulido	ME 9290	1.876	ME 9293	1.513	ME 9296	1.867	ME 9299	1.895	ME 9302	2.137	ME 9477	2.108	ME 9480	2.044	ME 9483	2.145
kg	40		40		40		40		57		36		36		36	
1 box/ bulto	0.44 m3		0.44 m3		0.44 m3		0.44 m3		0.92 m3		0.44 m3		0.44 m3		0.44 m3	
Oak Roble	ME 95953	2.097	ME 95954	1.742	ME 95955	2.108	ME 95956	2.136	ME 95957	2.387	ME 95958	2.307	ME 95959	2.129	ME 95960	2.288
kg	36		36		36		36		36		36		36		36	
1 box/ bulto	0.44 m3		0.44 m3		0.44 m3		0.44 m3		0.92 m3		0.44 m3		0.44 m3		0.44 m3	

Legs Patas	Table top / Sobre											
	*Oak Roble		Lacquered Lacado		LaminateTP LaminadoTP		Ultra-matteTP UltramateTP		***M1 Marble Mármol M1		***M3 Marble Mármol M3	
Top Edge Perfil												
White/Black Blanco/Negro	ME 9303	1.653	ME 9306	1.451	ME 9309	1.314	ME 9484	1.420	ME 96373	4.324	ME 96375	7.417
kg	39		40		39		36		114		114	
2 boxes/ bultos	0.44 m3		0.44 m3		0.44 m3		0.44 m3		2.74 m3		2.74 m3	
Anodized Anodizado	ME 9304	1.599	ME 9307	1.397	ME 9310	1.260	ME 9485	1.473	ME 96376	4.304	ME 96378	7.385
kg	39		40		39		36		114		114	
2 boxes/ bultos	0.44 m3		0.44 m3		0.44 m3		0.44 m3		2.74 m3		2.74 m3	
**Polished Pulido	ME 9305	1.715	ME 9308	1.513	ME 9311	1.378	ME 9486	1.535	ME 96379	4.444	ME 96381	7.624
kg	39		40		39		36		114		114	
2 boxes/ bultos	0.44 m3		0.44 m3		0.44 m3		0.44 m3		2.74 m3		2.74 m3	
Oak Roble	ME 95961	1.948	ME 95962	1.742	ME 95963	1.601	ME 95964	1.630	ME 96382	4.555	ME 96384	7.816
kg	36		36		36		36		114		114	
2 boxes/ bultos	0.44 m3		0.44 m3		0.44 m3		0.44 m3		2.74 m3		2.74 m3	

∅1400 x 745

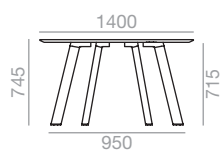

\*Matte lacquered and premium upcharge  
\*Incremento por lacado mate y premium

156



\*\*Polished chrome frame up charge  
\*\*Incremento por estructura en cromo brillo

165

\*\*\*Marble shiny upcharge  
Incremento por mármol brillo

30

Legs Patas	Table top / Sobre															
	*Oak Roble		Lacquered Lacado		Laminate Laminado		LaminateTP LaminadoTP		Low Iron Glass Cristal óptico		Linoleum Linóleo		Ultra-matte Ultramate		Ultra-matteTP UltramateTP	
Top Edge Perfil																
White/Black Blanco/Negro	ME 9312	2.235	ME 9315	1.662	ME 9318	2.196	ME 9321	2.194	ME 9324	2.507	ME 9487	2.356	ME 9490	2.504	ME 9493	2.443
kg	50		50		50		50		72		47		47		47	
1 box/ bulto	0.58 m3		0.58 m3		0.58 m3		0.58 m3		1.2 m3		0.58 m3		0.58 m3		0.58 m3	
Anodized Anodizado	ME 9313	2.183	ME 9316	1.609	ME 9319	2.144	ME 9322	2.141	ME 9325	2.452	ME 9488	2.411	ME 9491	2.558	ME 9494	2.496
kg	50		50		50		50		72		47		47		47	
1 box/ bulto	0.58 m3		0.58 m3		0.58 m3		0.58 m3		1.2 m3		0.58 m3		0.58 m3		0.58 m3	
**Polished Pulido	ME 9314	2.301	ME 9317	1.724	ME 9320	2.259	ME 9323	2.258	ME 9326	2.570	ME 9489	2.472	ME 9492	2.618	ME 9495	2.558
kg	50		50		50		50		72		47		47		47	
1 box/ bulto	0.58 m3		0.58 m3		0.58 m3		0.58 m3		1.2 m3		0.58 m3		0.58 m3		0.58 m3	
Oak Roble	ME 95965	2.552	ME 95966	1.955	ME 95967	2.509	ME 95968	2.507	ME 95969	2.831	ME 95970	2.668	ME 95971	2.694	ME 95972	2.694
kg	46		46		46		46		46		46		46		46	
1 box/ bulto	0.58 m3		0.58 m3		0.58 m3		0.58 m3		1.2 m3		0.58 m3		0.58 m3		0.58 m3	

Legs Patas	Table top / Sobre											
	*Oak Roble		Lacquered Lacado		LaminateTP LaminadoTP		Ultra-matteTP UltramateTP		***M1 Marble Mármol M1		***M3 Marble Mármol M3	
Top Edge Perfil												
White/Black Blanco/Negro	ME 9327	1.952	ME 9330	1.662	ME 9333	1.621	ME 9496	1.754	ME 96385	4.324	ME 96387	7.417
kg	48		50		48		47		142		142	
2 boxes/ bultos	0.58 m3		0.58 m3		0.58 m3		0.58 m3		2.99 m3		2.99 m3	
Anodized Anodizado	ME 9328	1.899	ME 9331	1.609	ME 9334	1.570	ME 9497	1.805	ME 96388	4.304	ME 96390	7.385
kg	48		50		48		47		142		142	
2 boxes/ bultos	0.58 m3		0.58 m3		0.58 m3		0.58 m3		2.99 m3		2.99 m3	
**Polished Pulido	ME 9329	2.015	ME 9332	1.724	ME 9335	1.684	ME 9498	1.868	ME 96391	4.444	ME 96393	7.624
kg	48		50		48		47		142		142	
2 boxes/ bultos	0.58 m3		0.58 m3		0.58 m3		0.58 m3		2.99 m3		2.99 m3	
Oak Roble	ME 95973	2.257	ME 95974	1.955	ME 95975	1.916	ME 95976	1.955	ME 96394	4.555	ME 96396	7.816
kg	46		46		46		46		142		142	
2 boxes/ bultos	0.58 m3		0.58 m3		0.58 m3		0.58 m3		2.99 m3		2.99 m3	

High Table  
1400 x 800 x 900

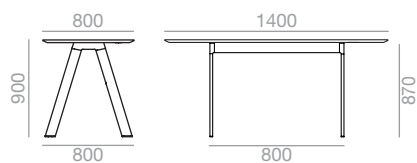

\*Matte lacquered and premium upcharge  
\*Incremento por lacado mate y premium

141

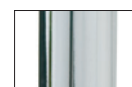

\*\*Polished chrome frame up charge  
\*\*Incremento por estructura en cromo brillo

165

\*\*\*Marble shiny upcharge  
Incremento por mármol brillo

30

Legs Patas	Table top / Sobre															
	*Oak Roble		Lacquered Lacado		Laminate Laminado		LaminateTP LaminadoTP		Low Iron Glass Cristal óptico		Linoleum Linóleo		Ultra-matte Ultramate		Ultra-matteTP UltramateTP	
Top Edge Perfil																
	Ref.	€	Ref.	€	Ref.	€	Ref.	€	Ref.	€	Ref.	€	Ref.	€	Ref.	€
White/Black Blanco/Negro	ME 94981	2.535	ME 94984	2.043	ME 94987	2.534	ME 94990	2.536	ME 94993	2.707	ME 94996	3.090	ME 94999	3.089	ME 95002	3.061
kg	46		46		46		46		46		46		46		46	
1 box/ bulto	0.38 m3		0.38 m3		0.38 m3		0.38 m3		0.75 m3		0.38 m3		0.38 m3		0.38 m3	
Anodized Anodizado	ME 94982	2.516	ME 94985	2.021	ME 94988	2.513	ME 94991	2.513	ME 94994	2.682	ME 94997	3.067	ME 95000	3.063	ME 95003	3.039
kg	46		46		46		46		46		46		46		46	
1 box/ bulto	0.38 m3		0.38 m3		0.38 m3		0.38 m3		0.75 m3		0.38 m3		0.38 m3		0.38 m3	
**Polished Pulido	ME 94983	2.722	ME 94986	2.229	ME 94989	2.720	ME 94992	2.722	ME 94995	2.886	ME 94998	3.277	ME 95001	3.273	ME 95004	3.247
kg	46		46		46		46		46		46		46		46	
1 box/ bulto	0.38 m3		0.38 m3		0.38 m3		0.38 m3		0.75 m3		0.38 m3		0.38 m3		0.38 m3	
Oak Roble	ME 95977	2.974	ME 95978	2.454	ME 95979	2.972	ME 95980	2.976	ME 95981	3.155	ME 95982	3.562	ME 95983	3.560	ME 95984	3.531
kg	48		48		48		48		48		48		48		48	
1 box/ bulto	0.38 m3		0.38 m3		0.38 m3		0.38 m3		0.38 m3		0.38 m3		0.38 m3		0.38 m3	

Legs Patas	Table top / Sobre							
	*Oak Roble		Lacquered Lacado		LaminateTP LaminadoTP		Ultra-matteTP UltramateTP	
Top Edge Perfil								
	Ref.	€	Ref.	€	Ref.	€	Ref.	€
White/Black Blanco/Negro	ME 95005	2.360	ME 95008	2.043	ME 95011	1.817	ME 95014	2.076
kg	46		46		46		46	
1 box/ bulto	0.38 m3		0.38 m3		0.38 m3		0.38 m3	
Anodized Anodizado	ME 95006	2.336	ME 95009	2.021	ME 95012	1.792	ME 95015	2.052
kg	46		46		46		46	
1 box/ bulto	0.38 m3		0.38 m3		0.38 m3		0.38 m3	
**Polished Pulido	ME 95007	2.544	ME 95010	2.229	ME 95013	2.001	ME 95016	2.261
kg	46		46		46		46	
1 box/ bulto	0.38 m3		0.38 m3		0.38 m3		0.38 m3	
Oak Roble	ME 95985	2.789	ME 95986	2.454	ME 95987	2.216	ME 95988	2.487
kg	48		48		48		48	
1 box/ bulto	0.38 m3		0.38 m3		0.38 m3		0.38 m3	

High Table  
1400 x 900 x 900

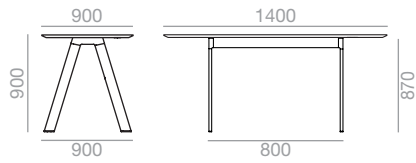

\*Matte lacquered and premium upcharge  
\*Incremento por lacado mate y premium

147

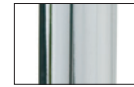

\*\*Polished chrome frame up charge  
\*\*Incremento por estructura en cromo brillo

165

\*\*\*Marble shiny upcharge  
Incremento por mármol brillo

30

Legs Patas	Table top / Sobre															
	*Oak Roble		Lacquered Lacado		Laminate Laminado		LaminateTP LaminadoTP		Low Iron Glass Cristal óptico		Linoleum Linóleo		Ultra-matte Ultramate		Ultra-matteTP UltramateTP	
Top Edge Perfil																
White/Black Blanco/Negro	ME 95017	2.537	ME 95020	2.048	ME 95023	2.536	ME 95026	2.552	ME 95029	2.734	ME 95032	3.101	ME 95035	3.099	ME 95038	3.075
kg	49		49		49		49		49		49		49		49	
1 box/ bulto	0.42 m3		0.42 m3		0.42 m3		0.42 m3		0.83 m3		0.42 m3		0.42 m3		0.42 m3	
Anodized Anodizado	ME 95018	2.520	ME 95021	2.024	ME 95024	2.515	ME 95027	2.527	ME 95030	2.710	ME 95033	3.081	ME 95036	3.077	ME 95039	3.050
kg	49		49		49		49		49		49		49		49	
1 box/ bulto	0.42 m3		0.42 m3		0.42 m3		0.42 m3		0.83 m3		0.42 m3		0.42 m3		0.42 m3	
**Polished Pulido	ME 95019	2.724	ME 95022	2.232	ME 95025	2.721	ME 95028	2.736	ME 95031	2.914	ME 95034	3.288	ME 95037	3.285	ME 95040	3.258
kg	49		49		49		49		49		49		49		49	
1 box/ bulto	0.42 m3		0.42 m3		0.42 m3		0.42 m3		0.83 m3		0.42 m3		0.42 m3		0.42 m3	
Oak Roble	ME 95989	2.976	ME 95990	2.460	ME 95991	2.974	ME 95992	2.992	ME 95993	3.186	ME 95994	3.574	ME 95995	3.572	ME 95996	3.543
kg	51		51		51		51		51		51		51		51	
1 box/ bulto	0.42 m3		0.42 m3		0.42 m3		0.42 m3		0.83 m3		0.42 m3		0.42 m3		0.42 m3	

Legs Patas	Table top / Sobre							
	*Oak Roble		Lacquered Lacado		LaminateTP LaminadoTP		Ultra-matteTP UltramateTP	
Top Edge Perfil								
White/Black Blanco/Negro	ME 95041	2.373	ME 95044	2.048	ME 95047	1.824	ME 95050	2.088
kg	49		49		49		49	
1 box/ bulto	0.42 m3		0.42 m3		0.42 m3		0.42 m3	
Anodized Anodizado	ME 95042	2.352	ME 95045	2.024	ME 95048	1.801	ME 95051	2.064
kg	49		49		49		49	
1 box/ bulto	0.42 m3		0.42 m3		0.42 m3		0.42 m3	
**Polished Pulido	ME 95043	2.559	ME 95046	2.232	ME 95049	2.007	ME 95052	2.274
kg	49		49		49		49	
1 box/ bulto	0.42 m3		0.42 m3		0.42 m3		0.42 m3	
Oak Roble	ME 95997	2.804	ME 95998	2.460	ME 95999	2.221	ME 96000	2.503
kg	51		51		51		51	
1 box/ bulto	0.42 m3		0.42 m3		0.42 m3		0.42 m3	

High Table  
1400 x 1000 x 900

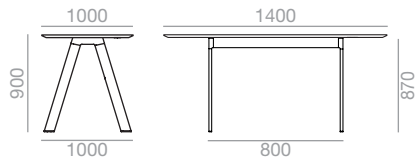

\*Matte lacquered and premium upcharge  
\*Incremento por lacado mate y premium

153

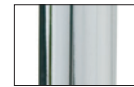

\*\*Polished chrome frame up charge  
\*\*Incremento por estructura en cromo brillo

165

\*\*\*Marble shiny upcharge  
Incremento por mármol brillo

30

Legs Patas	Table top / Sobre															
	*Oak Roble		Lacquered Lacado		Laminate Laminado		LaminateTP LaminadoTP		Low Iron Glass Cristal óptico		Linoleum Linóleo		Ultra-matte Ultramate		Ultra-matteTP UltramateTP	
Top Edge Perfil																
White/Black Blanco/Negro	ME 95053	2.538	ME 95056	2.062	ME 95059	2.537	ME 95062	2.564	ME 95065	2.764	ME 95068	3.115	ME 95071	3.113	ME 95074	3.086
kg	52		52		52		52		52		52		52		52	
1 box/ bulto	0.46 m3		0.46 m3		0.46 m3		0.46 m3		0.9 m3		0.46 m3		0.46 m3		0.46 m3	
Anodized Anodizado	ME 95054	2.522	ME 95057	2.038	ME 95060	2.517	ME 95063	2.541	ME 95066	2.741	ME 95069	3.092	ME 95072	3.089	ME 95075	3.061
kg	52		52		52		52		52		52		52		52	
1 box/ bulto	0.46 m3		0.46 m3		0.46 m3		0.46 m3		0.9 m3		0.46 m3		0.46 m3		0.46 m3	
**Polished Pulido	ME 95055	2.727	ME 95058	2.247	ME 95061	2.723	ME 95064	2.751	ME 95067	2.941	ME 95070	3.301	ME 95073	3.298	ME 95076	3.270
kg	52		52		52		52		52		52		52		52	
1 box/ bulto	0.46 m3		0.46 m3		0.46 m3		0.46 m3		0.9 m3		0.46 m3		0.46 m3		0.46 m3	
Oak Roble	ME 96001	2.978	ME 96002	2.474	ME 96003	2.976	ME 96004	3.005	ME 96005	3.216	ME 96006	3.586	ME 96007	3.583	ME 96008	3.556
kg	54		54		54		54		54		54		54		54	
1 box/ bulto	0.46 m3		0.46 m3		0.46 m3		0.46 m3		0.9 m3		0.46 m3		0.46 m3		0.46 m3	

Legs Patas	Table top / Sobre							
	*Oak Roble		Lacquered Lacado		LaminateTP LaminadoTP		Ultra-matteTP UltramateTP	
Top Edge Perfil								
White/Black Blanco/Negro	ME 95077	2.389	ME 95080	2.062	ME 95083	1.831	ME 95086	2.099
kg	52		52		52		52	
1 box/ bulto	0.46 m3		0.46 m3		0.46 m3		0.46 m3	
Anodized Anodizado	ME 95078	2.364	ME 95081	2.038	ME 95084	1.806	ME 95087	2.077
kg	52		52		52		52	
1 box/ bulto	0.46 m3		0.46 m3		0.46 m3		0.46 m3	
**Polished Pulido	ME 95079	2.572	ME 95082	2.247	ME 95085	2.016	ME 95088	2.284
kg	52		52		52		52	
1 box/ bulto	0.46 m3		0.46 m3		0.46 m3		0.46 m3	
Oak Roble	ME 96009	2.817	ME 96010	2.474	ME 96011	2.229	ME 96012	2.515
kg	54		54		54		54	
1 box/ bulto	0.46 m3		0.46 m3		0.46 m3		0.46 m3	

High Table  
1800 x 800 x 900

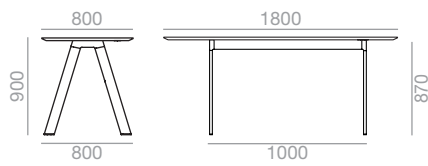

\*Matte lacquered and premium upcharge  
\*Incremento por lacado mate y premium

159

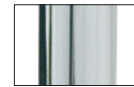

\*\*Polished chrome frame up charge  
\*\*Incremento por estructura en cromo brillo

165

\*\*\*Marble shiny upcharge  
Incremento por mármol brillo

30

Legs Patas	Table top / Sobre															
	*Oak Roble		Lacquered Lacado		Laminate Laminado		LaminateTP LaminadoTP		Low Iron Glass Cristal óptico		Linoleum Linóleo		Ultra-matte Ultramate		Ultra-matteTP UltramateTP	
Top Edge Perfil																
White/Black Blanco/Negro	ME 95089	2.646	ME 95092	2.072	ME 95095	2.534	ME 95098	2.641	ME 95101	2.777	ME 95104	3.115	ME 95107	3.167	ME 95110	3.138
kg	57		57		57		57		57		57		57		57	
1 box/ bulto	0.48 m3		0.48 m3		0.48 m3		0.48 m3		0.94 m3		0.48 m3		0.48 m3		0.48 m3	
Anodized Anodizado	ME 95090	2.627	ME 95093	2.048	ME 95096	2.513	ME 95099	2.617	ME 95102	2.753	ME 95105	3.092	ME 95108	3.142	ME 95111	2.873
kg	57		57		57		57		57		57		57		57	
1 box/ bulto	0.48 m3		0.48 m3		0.48 m3		0.48 m3		0.94 m3		0.48 m3		0.48 m3		0.48 m3	
**Polished Pulido	ME 95091	2.833	ME 95094	2.258	ME 95097	2.720	ME 95100	2.827	ME 95103	2.953	ME 95106	3.301	ME 95109	3.350	ME 95112	3.326
kg	57		57		57		57		57		57		57		57	
1 box/ bulto	0.48 m3		0.48 m3		0.48 m3		0.48 m3		0.94 m3		0.48 m3		0.48 m3		0.48 m3	
Oak Roble	ME 96013	3.092	ME 96014	2.483	ME 96015	2.972	ME 96016	3.085	ME 96017	3.228	ME 96018	3.586	ME 96019	3.642	ME 96020	3.613
kg	59		59		59		59		59		59		59		59	
1 box/ bulto	0.48 m3		0.48 m3		0.48 m3		0.48 m3		1.4 m3		0.48 m3		0.48 m3		0.48 m3	

Legs Patas	Table top / Sobre							
	*Oak Roble		Lacquered Lacado		LaminateTP LaminadoTP		Ultra-matteTP UltramateTP	
Top Edge Perfil								
White/Black Blanco/Negro	ME 95113	2.395	ME 95116	2.072	ME 95119	1.844	ME 95122	2.130
kg	57		57		57		57	
1 box/ bulto	0.48 m3		0.48 m3		0.48 m3		0.48 m3	
Anodized Anodizado	ME 95114	2.372	ME 95117	2.048	ME 95120	1.821	ME 95123	2.107
kg	57		57		57		57	
1 box/ bulto	0.48 m3		0.48 m3		0.48 m3		0.48 m3	
**Polished Pulido	ME 95115	2.582	ME 95118	2.258	ME 95121	2.032	ME 95124	2.314
kg	57		57		57		57	
1 box/ bulto	0.48 m3		0.48 m3		0.48 m3		0.48 m3	
Oak Roble	ME 96021	2.827	ME 96022	2.483	ME 96023	2.246	ME 96024	2.547
kg	59		59		59		59	
1 box/ bulto	0.48 m3		0.48 m3		0.48 m3		0.48 m3	

High Table  
1800 x 900 x 900

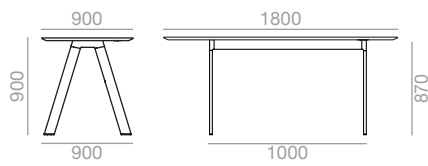

\*Matte lacquered and premium upcharge  
\*Incremento por lacado mate y premium

165

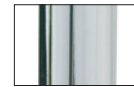

\*\*Polished chrome frame up charge  
\*\*Incremento por estructura en cromo brillo

165

\*\*\*Marble shiny upcharge  
Incremento por mármol brillo

30

Legs Patas	Table top / Sobre															
	*Oak Roble		Lacquered Lacado		Laminate Laminado		LaminateTP LaminadoTP		Low Iron Glass Cristal óptico		Linoleum Linóleo		Ultra-matte Ultramate		Ultra-matteTP UltramateTP	
Top Edge Perfil																
White/Black Blanco/Negro	ME 95125	2.648	ME 95128	2.077	ME 95131	2.804	ME 95134	2.655	ME 95137	2.804	ME 95140	3.127	ME 95143	3.178	ME 95146	3.151
kg	62		62		62		62		62		62		62		62	
1 box/ bulto	0.53 m3		0.53 m3		0.53 m3		0.53 m3		1.03 m3		0.53 m3		0.53 m3		0.53 m3	
Anodized Anodizado	ME 95126	2.631	ME 95129	2.052	ME 95132	2.782	ME 95135	2.633	ME 95138	2.781	ME 95141	3.104	ME 95144	3.154	ME 95147	3.129
kg	62		62		62		62		62		62		62		62	
1 box/ bulto	0.53 m3		0.53 m3		0.53 m3		0.53 m3		1.03 m3		0.53 m3		0.53 m3		0.53 m3	
**Polished Pulido	ME 95127	2.837	ME 95130	2.261	ME 95133	2.989	ME 95136	2.841	ME 95139	2.982	ME 95142	3.314	ME 95145	3.363	ME 95148	3.118
kg	62		62		62		62		62		62		62		62	
1 box/ bulto	0.53 m3		0.53 m3		0.53 m3		0.53 m3		1.03 m3		0.53 m3		0.53 m3		0.53 m3	
Oak Roble	ME 96025	3.093	ME 96026	2.489	ME 96027	3.258	ME 96028	3.100	ME 96029	3.259	ME 96030	3.601	ME 96031	3.654	ME 96032	3.624
kg	64		64		64		64		64		64		64		64	
1 box/ bulto	0.53 m3		0.53 m3		0.53 m3		0.53 m3		1.03 m3		0.53 m3		0.53 m3		0.53 m3	

Legs Patas	Table top / Sobre							
	*Oak Roble		Lacquered Lacado		LaminateTP LaminadoTP		Ultra-matteTP UltramateTP	
Top Edge Perfil								
White/Black Blanco/Negro	ME 95149	2.411	ME 95152	2.077	ME 95155	1.853	ME 95158	2.141
kg	62		62		62		62	
1 box/ bulto	0.53 m3		0.53 m3		0.53 m3		0.53 m3	
Anodized Anodizado	ME 95150	2.387	ME 95153	2.052	ME 95156	1.830	ME 95159	2.118
kg	62		62		62		62	
1 box/ bulto	0.53 m3		0.53 m3		0.53 m3		0.53 m3	
**Polished Pulido	ME 95151	2.595	ME 95154	2.261	ME 95157	2.037	ME 95160	2.326
kg	62		62		62		62	
1 box/ bulto	0.53 m3		0.53 m3		0.53 m3		0.53 m3	
Oak Roble	ME 96033	2.841	ME 96034	2.489	ME 96035	2.251	ME 96036	2.558
kg	64		64		64		64	
1 box/ bulto	0.53 m3		0.53 m3		0.53 m3		0.53 m3	

High Table  
1800 x 1000 x 900

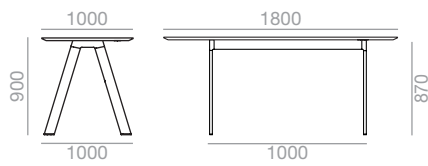

\*Matte lacquered and premium upcharge  
\*Incremento por lacado mate y premium

171

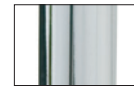

\*\*Polished chrome frame up charge  
\*\*Incremento por estructura en cromo brillo

165

\*\*\*Marble shiny upcharge  
Incremento por mármol brillo

30

Legs Patas	Table top / Sobre															
	*Oak Roble		Lacquered Lacado		Laminate Laminado		LaminateTP LaminadoTP		Low Iron Glass Cristal óptico		Linoleum Linóleo		Ultra-matte Ultramate		Ultra-matteTP UltramateTP	
Top Edge Perfil																
	Ref.	€	Ref.	€	Ref.	€	Ref.	€	Ref.	€	Ref.	€	Ref.	€	Ref.	€
White/Black Blanco/Negro	ME 95161	2.649	ME 95164	2.090	ME 95167	2.806	ME 95170	2.670	ME 95173	2.834	ME 95176	3.138	ME 95179	3.192	ME 95182	3.164
kg	66		66		66		66		66		66		66		66	
1 box/ bulto	0.58 m3		0.58 m3		0.58 m3		0.58 m3		1.13 m3		0.58 m3		0.58 m3		0.58 m3	
Anodized Anodizado	ME 95162	2.632	ME 95165	2.068	ME 95168	2.785	ME 95171	2.646	ME 95174	2.809	ME 95177	3.115	ME 95180	3.167	ME 95183	3.140
kg	66		66		66		66		66		66		66		66	
1 box/ bulto	0.58 m3		0.58 m3		0.58 m3		0.58 m3		1.13 m3		0.58 m3		0.58 m3		0.58 m3	
**Polished Pulido	ME 95163	2.839	ME 95166	2.277	ME 95169	2.992	ME 95172	2.855	ME 95175	3.011	ME 95178	3.323	ME 95181	3.375	ME 95184	3.349
kg	66		66		66		66		66		66		66		66	
1 box/ bulto	0.58 m3		0.58 m3		0.58 m3		0.58 m3		1.13 m3		0.58 m3		0.58 m3		0.58 m3	
Oak Roble	ME 96037	3.096	ME 96038	2.504	ME 96039	3.262	ME 96040	3.117	ME 96041	3.290	ME 96042	3.613	ME 96043	3.667	ME 96044	3.637
kg	66		66		66		66		66		66		66		169	
1 box/ bulto	0.58 m3		0.58 m3		0.58 m3		0.58 m3		1.13 m3		0.58 m3		0.58 m3		0.58 m3	

Legs Patas	Table top / Sobre							
	*Oak Roble		Lacquered Lacado		LaminateTP LaminadoTP		Ultra-matteTP UltramateTP	
Top Edge Perfil								
	Ref.	€	Ref.	€	Ref.	€	Ref.	€
White/Black Blanco/Negro	ME 95185	2.425	ME 95188	2.090	ME 95191	1.859	ME 95194	2.153
kg	66		66		66		66	
1 box/ bulto	0.58 m3		0.58 m3		0.58 m3		0.58 m3	
Anodized Anodizado	ME 95186	2.400	ME 95189	2.068	ME 95192	1.836	ME 95195	2.130
kg	66		66		66		66	
1 box/ bulto	0.58 m3		0.58 m3		0.58 m3		0.58 m3	
**Polished Pulido	ME 95187	2.610	ME 95190	2.277	ME 95193	2.044	ME 95196	2.339
kg	66		66		66		66	
1 box/ bulto	0.58 m3		0.58 m3		0.58 m3		0.58 m3	
Oak Roble	ME 96045	2.857	ME 96046	2.504	ME 96047	2.260	ME 96048	2.570
kg	66		66		66		66	
1 box/ bulto	0.58 m3		0.58 m3		0.58 m3		0.58 m3	



High Table  
2400 x 800 x 900

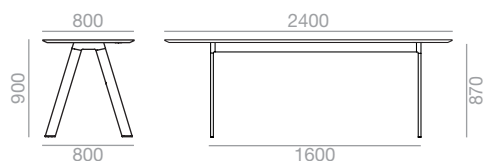

\*Matte lacquered and premium upcharge  
\*Incremento por lacado mate y premium

177



\*\*Polished chrome frame up charge  
\*\*Incremento por estructura en cromo brillo

165

\*\*\*Marble shiny upcharge  
Incremento por mármol brillo

30

Legs Patas	Table top / Sobre															
	*Oak Roble		Lacquered Lacado		Laminate Laminado		LaminateTP LaminadoTP		Low Iron Glass Cristal óptico		Linoleum Linóleo		Ultra-matte Ultramate		Ultra-matteTP UltramateTP	
Top Edge Perfil																
	Ref.	€	Ref.	€	Ref.	€	Ref.	€	Ref.	€	Ref.	€	Ref.	€	Ref.	€
White/Black Blanco/Negro	ME 95197	2.876	ME 95200	2.277	ME 95203	2.943	ME 95206	2.783	ME 95209	3.418	ME 95212	3.292	ME 95215	3.457	ME 95218	3.427
kg	74		74		74		74		74		74		74		74	
1 box/ bulto	0.63 m3		0.63 m3		0.63 m3		0.63 m3		1.22 m3		0.63 m3		0.63 m3		0.63 m3	
Anodized Anodizado	ME 95198	2.849	ME 95201	2.244	ME 95204	2.916	ME 95207	2.753	ME 95210	3.383	ME 95213	3.259	ME 95216	3.426	ME 95219	3.395
kg	74		74		74		74		74		74		74		74	
1 box/ bulto	0.63 m3		0.63 m3		0.63 m3		0.63 m3		1.22 m3		0.63 m3		0.63 m3		0.63 m3	
**Polished Pulido	ME 95199	3.073	ME 95202	2.471	ME 95205	3.140	ME 95208	2.979	ME 95211	3.627	ME 95214	3.487	ME 95217	3.653	ME 95220	3.622
kg	74		74		74		74		74		74		74		74	
1 box/ bulto	0.63 m3		0.63 m3		0.63 m3		0.63 m3		1.22 m3		0.63 m3		0.63 m3		0.63 m3	
Oak Roble	ME 96049	3.334	ME 96050	2.697	ME 96051	3.406	ME 96052	3.237	ME 96053	3.650	ME 96054	3.776	ME 96055	3.949	ME 96056	3.916
kg	76		76		76		76		76		76		76		76	
1 box/ bulto	0.63 m3		0.63 m3		0.63 m3		0.63 m3		1.22 m3		0.63 m3		0.63 m3		0.63 m3	

Legs Patas	Table top / Sobre							
	*Oak Roble		Lacquered Lacado		LaminateTP LaminadoTP		Ultra-matteTP UltramateTP	
Top Edge Perfil								
	Ref.	€	Ref.	€	Ref.	€	Ref.	€
White/Black Blanco/Negro	ME 95221	2.742	ME 95224	2.277	ME 95227	2.008	ME 95230	2.461
kg	74		74		74		74	
1 box/ bulto	0.63 m3		0.63 m3		0.63 m3		0.63 m3	
Anodized Anodizado	ME 95222	2.709	ME 95225	2.244	ME 95228	1.983	ME 95231	2.428
kg	74		74		74		74	
1 box/ bulto	0.63 m3		0.63 m3		0.63 m3		0.63 m3	
**Polished Pulido	ME 95223	2.937	ME 95226	2.471	ME 95229	2.254	ME 95232	2.702
kg	74		74		74		74	
1 box/ bulto	0.63 m3		0.63 m3		0.63 m3		0.63 m3	
Oak Roble	ME 96057	3.195	ME 96058	2.697	ME 96059	2.417	ME 96060	2.893
kg	76		76		76		76	
1 box/ bulto	0.63 m3		0.63 m3		0.63 m3		0.63 m3	

High Table  
2400 x 900 x 900

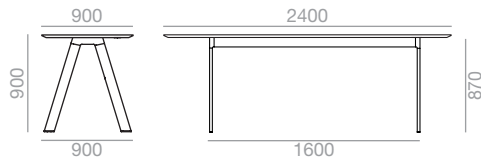

\*Matte lacquered and premium upcharge  
\*Incremento por lacado mate y premium

183



\*\*Polished chrome frame up charge  
\*\*Incremento por estructura en cromo brillo

165

\*\*\*Marble shiny upcharge  
Incremento por mármol brillo

30

Legs Patas	Table top / Sobre															
	*Oak Roble		Lacquered Lacado		Laminate Laminado		LaminateTP LaminadoTP		Low Iron Glass Cristal óptico		Linoleum Linóleo		Ultra-matte Ultramate		Ultra-matteTP UltramateTP	
Top Edge Perfil																
White/Black Blanco/Negro	ME 95233	2.877	ME 95236	2.292	ME 95239	2.946	ME 95242	2.804	ME 95245	3.758	ME 95248	3.304	ME 95251	3.470	ME 95254	3.440
kg	80		80		80		80		80		80		80		80	
1 box/ bulto	0.69 m3		0.69 m3		0.69 m3		0.69 m3		1.34 m3		0.69 m3		0.69 m3		0.69 m3	
Anodized Anodizado	ME 95234	2.850	ME 95237	2.260	ME 95240	2.918	ME 95243	2.771	ME 95246	3.810	ME 95249	3.271	ME 95252	3.439	ME 95255	3.407
kg	80		80		80		80		80		80		80		80	
1 box/ bulto	0.69 m3		0.69 m3		0.69 m3		0.69 m3		1.34 m3		0.69 m3		0.69 m3		0.69 m3	
**Polished Pulido	ME 95235	3.076	ME 95238	2.486	ME 95241	3.142	ME 95244	2.999	ME 95247	3.987	ME 95250	3.500	ME 95253	3.666	ME 95256	3.634
kg	80		80		80		80		80		80		80		80	
1 box/ bulto	0.69 m3		0.69 m3		0.69 m3		0.69 m3		1.34 m3		0.69 m3		0.69 m3		0.69 m3	
Oak Roble	ME 96061	3.338	ME 96062	2.719	ME 96063	3.407	ME 96064	3.258	ME 96065	3.682	ME 96066	3.787	ME 96067	3.961	ME 96068	3.931
kg	213		82		82		82		82		82		82		82	
1 box/ bulto	0.69 m3		0.69 m3		0.69 m3		0.69 m3		1.34 m3		0.69 m3		0.69 m3		0.69 m3	

Legs Patas	Table top / Sobre							
	*Oak Roble		Lacquered Lacado		LaminateTP LaminadoTP		Ultra-matteTP UltramateTP	
Top Edge Perfil								
White/Black Blanco/Negro	ME 95257	2.757	ME 95260	2.292	ME 95263	2.018	ME 95266	2.473
kg	80		80		80		80	
1 box/ bulto	0.69 m3		0.69 m3		0.69 m3		0.69 m3	
Anodized Anodizado	ME 95258	2.724	ME 95261	2.260	ME 95264	1.990	ME 95267	2.441
kg	80		80		80		80	
1 box/ bulto	0.69 m3		0.69 m3		0.69 m3		0.69 m3	
**Polished Pulido	ME 95259	2.951	ME 95262	2.486	ME 95265	2.261	ME 95268	2.715
kg	80		80		80		80	
1 box/ bulto	0.69 m3		0.69 m3		0.69 m3		0.69 m3	
Oak Roble	ME 96069	3.208	ME 96070	2.719	ME 96071	2.427	ME 96072	2.905
kg	82		82		82		82	
1 box/ bulto	0.69 m3		0.69 m3		0.69 m3		0.69 m3	

High Table  
2400 x 1000 x 900

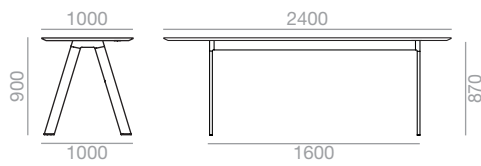

\*Matte lacquered and premium upcharge  
\*Incremento por lacado mate y premium

189

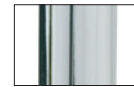

\*\*Polished chrome frame up charge  
\*\*Incremento por estructura en cromo brillo

165

\*\*\*Marble shiny upcharge  
Incremento por mármol brillo

30

Legs Patas	Table top / Sobre															
	*Oak Roble		Lacquered Lacado		Laminate Laminado		LaminateTP LaminadoTP		Low Iron Glass Cristal óptico		Linoleum Linóleo		Ultra-matte Ultramate		Ultra-matteTP UltramateTP	
Top Edge Perfil																
White/Black Blanco/Negro	ME 95269	2.880	ME 95272	2.308	ME 95275	2.948	ME 95278	2.823	ME 95281	3.231	ME 95284	3.317	ME 95287	3.483	ME 95290	3.452
kg	86		86		86		86		86		86		86		86	
1 box/ bulto	0.76 m3		0.76 m3		0.76 m3		0.76 m3		1.47 m3		0.76 m3		0.76 m3		0.76 m3	
Anodized Anodizado	ME 95270	2.854	ME 95273	2.277	ME 95276	2.919	ME 95279	2.792	ME 95282	3.200	ME 95285	3.284	ME 95288	3.450	ME 95291	3.419
kg	86		86		86		86		86		86		86		86	
1 box/ bulto	0.76 m3		0.76 m3		0.76 m3		0.76 m3		1.47 m3		0.76 m3		0.76 m3		0.76 m3	
**Polished Pulido	ME 95271	3.078	ME 95274	2.503	ME 95277	3.145	ME 95280	3.016	ME 95283	3.426	ME 95286	3.510	ME 95289	3.677	ME 95292	3.647
kg	86		86		86		86		86		86		86		86	
1 box/ bulto	0.76 m3		0.76 m3		0.76 m3		0.76 m3		1.47 m3		0.76 m3		0.76 m3		0.76 m3	
Oak Roble	ME 96073	3.339	ME 96074	2.733	ME 96075	3.411	ME 96076	3.280	ME 96077	3.710	ME 96078	3.802	ME 96079	3.974	ME 96080	3.944
kg	88		88		88		88		88		88		88		88	
1 box/ bulto	0.76 m3		0.76 m3		0.76 m3		0.76 m3		1.47 m3		0.76 m3		0.76 m3		0.76 m3	

Legs Patas	Table top / Sobre							
	*Oak Roble		Lacquered Lacado		LaminateTP LaminadoTP		Ultra-matteTP UltramateTP	
Top Edge Perfil								
White/Black Blanco/Negro	ME 95293	2.764	ME 95296	2.308	ME 95299	2.024	ME 95302	2.483
kg	86		86		86		86	
1 box/ bulto	0.76 m3		0.76 m3		0.76 m3		0.76 m3	
Anodized Anodizado	ME 95294	2.731	ME 95297	2.277	ME 95300	1.998	ME 95303	2.451
kg	86		86		86		86	
1 box/ bulto	0.76 m3		0.76 m3		0.76 m3		0.76 m3	
**Polished Pulido	ME 95295	2.960	ME 95298	2.503	ME 95301	2.268	ME 95304	2.726
kg	86		86		86		86	
1 box/ bulto	0.76 m3		0.76 m3		0.76 m3		0.76 m3	
Oak Roble	ME 96081	3.216	ME 96082	2.733	ME 96083	2.435	ME 96084	2.922
kg	88		88		88		88	
1 box/ bulto	0.76 m3		0.76 m3		0.76 m3		0.76 m3	

High Table  
3000 x 800 x 900

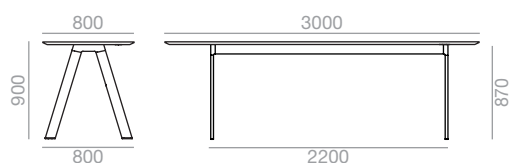

\*Matte lacquered and premium upcharge  
\*Incremento por lacado mate y premium

195



\*\*Polished chrome frame up charge  
\*\*Incremento por estructura en cromo brillo

165

\*\*\*Marble shiny upcharge  
Incremento por mármol brillo

30

Legs Patas	Table top / Sobre															
	*Oak Roble		Lacquered Lacado		Laminate Laminado		LaminateTP LaminadoTP		Low Iron Glass Cristal óptico		Linoleum Linóleo		Ultra-matte Ultramate		Ultra-matteTP UltramateTP	
Top Edge Perfil																
White/Black Blanco/Negro	ME 95305	3.492	ME 95308	2.535	ME 95311	3.674	ME 95314	3.453	ME 95317	3.618	ME 95320	4.260	ME 95323	4.208	ME 95326	4.178
kg	92		92		92		92		92		92		92		92	
1 box/ bulto	0.78 m3		0.78 m3		0.78 m3		0.78 m3		3.2 m3		0.78 m3		0.78 m3		0.78 m3	
Anodized Anodizado	ME 95306	3.452	ME 95309	2.494	ME 95312	3.641	ME 95315	3.413	ME 95318	3.577	ME 95321	4.219	ME 95324	4.169	ME 95327	4.138
kg	92		92		92		92		92		92		92		92	
1 box/ bulto	0.78 m3		0.78 m3		0.78 m3		0.78 m3		3.2 m3		0.78 m3		0.78 m3		0.78 m3	
**Polished Pulido	ME 95307	3.696	ME 95310	2.738	ME 95313	3.883	ME 95316	3.657	ME 95319	3.821	ME 95322	4.464	ME 95325	4.414	ME 95328	4.383
kg	92		92		92		92		92		92		92		92	
1 box/ bulto	0.78 m3		0.78 m3		0.78 m3		0.78 m3		3.2 m3		0.78 m3		0.78 m3		0.78 m3	
Oak Roble	ME 96085	3.986	ME 96086	2.972	ME 96087	4.179	ME 96088	3.946	ME 96089	4.117	ME 96090	4.797	ME 96091	4.745	ME 96092	4.710
kg	94		94		94		94		94		94		94		94	
1 box/ bulto	0.78 m3		0.78 m3		0.78 m3		0.78 m3		3.2 m3		0.78 m3		0.78 m3		0.78 m3	

Legs Patas	Table top / Sobre							
	*Oak Roble		Lacquered Lacado		LaminateTP LaminadoTP		Ultra-matteTP UltramateTP	
Top Edge Perfil								
White/Black Blanco/Negro	ME 95329	3.038	ME 95332	2.535	ME 95335	2.327	ME 95338	2.564
kg	92		92		92		92	
1 box/ bulto	0.78 m3		0.78 m3		0.78 m3		0.78 m3	
Anodized Anodizado	ME 95330	3.000	ME 95333	2.494	ME 95336	2.287	ME 95339	2.526
kg	92		92		92		92	
1 box/ bulto	0.78 m3		0.78 m3		0.78 m3		0.78 m3	
**Polished Pulido	ME 95331	3.237	ME 95334	2.738	ME 95337	2.533	ME 95340	2.764
kg	92		92		92		92	
1 box/ bulto	0.78 m3		0.78 m3		0.78 m3		0.78 m3	
Oak Roble	ME 96093	3.506	ME 96094	2.972	ME 96095	2.755	ME 96096	3.005
kg	94		94		94		94	
1 box/ bulto	0.78 m3		0.78 m3		0.78 m3		0.78 m3	

High Table  
3000 x 900 x 900

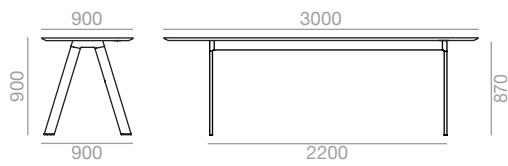

\*Matte lacquered and premium upcharge  
\*\*Incremento por lacado mate y premium

201

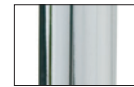

\*\*Polished chrome frame up charge  
\*\*Incremento por estructura en cromo brillo

165

\*\*\*Marble shiny upcharge  
Incremento por mármol brillo

30

Legs Patas	Table top / Sobre															
	*Oak Roble		Lacquered Lacado		Laminate Laminado		LaminateTP LaminadoTP		Low Iron Glass Cristal óptico		Linoleum Linóleo		Ultra-matte Ultramate		Ultra-matteTP UltramateTP	
Top Edge Perfil																
White/Black Blanco/Negro	ME 95341	3.498	ME 95344	2.554	ME 95347	3.679	ME 95350	3.472	ME 95353	3.648	ME 95356	4.271	ME 95359	4.221	ME 95362	4.191
kg	99		99		99		99		99		99		99		99	
1 box/ bulto	0.86 m3		0.86 m3		0.86 m3		0.86 m3		3.52 m3		0.86 m3		0.86 m3		0.86 m3	
Anodized Anodizado	ME 95342	3.455	ME 95345	2.513	ME 95348	3.643	ME 95351	3.430	ME 95354	3.607	ME 95357	4.231	ME 95360	4.179	ME 95363	4.149
kg	99		99		99		99		99		99		99		99	
1 box/ bulto	0.86 m3		0.86 m3		0.86 m3		0.86 m3		3.52 m3		0.86 m3		0.86 m3		0.86 m3	
**Polished Pulido	ME 95343	3.702	ME 95346	2.757	ME 95349	3.887	ME 95352	3.677	ME 95355	3.851	ME 95358	4.476	ME 95361	4.426	ME 95364	4.393
kg	99		99		99		99		99		99		99		99	
1 box/ bulto	0.86 m3		0.86 m3		0.86 m3		0.86 m3		3.52 m3		0.86 m3		0.86 m3		0.86 m3	
Oak Roble	ME 96097	3.989	ME 96098	2.993	ME 96099	4.184	ME 96100	3.966	ME 96101	4.148	ME 96102	4.809	ME 96103	4.756	ME 96104	4.723
kg	101		101		101		101		101		101		101		101	
1 box/ bulto	0.86 m3		0.86 m3		0.86 m3		0.86 m3		3.52 m3		0.86 m3		0.86 m3		0.86 m3	

Legs Patas	Table top / Sobre							
	*Oak Roble		Lacquered Lacado		LaminateTP LaminadoTP		Ultra-matteTP UltramateTP	
Top Edge Perfil								
White/Black Blanco/Negro	ME 95365	3.057	ME 95368	2.554	ME 95371	2.334	ME 95374	2.577
kg	99		99		99		99	
1 box/ bulto	0.86 m3		0.86 m3		0.86 m3		0.86 m3	
Anodized Anodizado	ME 95366	3.020	ME 95369	2.513	ME 95372	2.294	ME 95375	2.538
kg	99		99		99		99	
1 box/ bulto	0.86 m3		0.86 m3		0.86 m3		0.86 m3	
**Polished Pulido	ME 95367	3.256	ME 95370	2.757	ME 95373	2.538	ME 95376	2.777
kg	99		99		99		99	
1 box/ bulto	0.86 m3		0.86 m3		0.86 m3		0.86 m3	
Oak Roble	ME 96105	3.527	ME 96106	2.993	ME 96107	2.763	ME 96108	3.016
kg	101		101		101		101	
1 box/ bulto	0.86 m3		0.86 m3		0.86 m3		0.86 m3	

High Table  
3000 x 1000 x 900

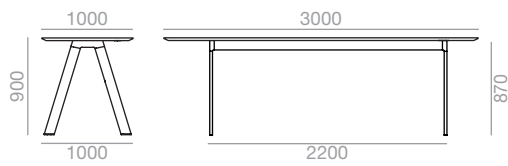

\*Matte lacquered and premium upcharge  
\*\*Incremento por lacado mate y premium

207

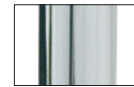

\*\*Polished chrome frame up charge  
\*\*Incremento por estructura en cromo brillo

165

\*\*\*Marble shiny upcharge  
Incremento por mármol brillo

30

Legs Patas	Table top / Sobre															
	*Oak Roble		Lacquered Lacado		Laminate Laminado		LaminateTP LaminadoTP		Low Iron Glass Cristal óptico		Linoleum Linóleo		Ultra-matte Ultramate		Ultra-matteTP UltramateTP	
Top Edge Perfil																
White/Black Blanco/Negro	ME 95377	3.501	ME 95380	2.572	ME 95383	3.683	ME 95386	3.490	ME 95389	3.674	ME 95392	4.283	ME 95395	4.232	ME 95398	4.203
kg	106		106		106		106		106		106		106		106	
1 box/ bulto	0.94 m3		0.94 m3		0.94 m3		0.94 m3		3.84 m3		0.94 m3		0.94 m3		0.94 m3	
Anodized Anodizado	ME 95378	3.460	ME 95381	2.533	ME 95384	3.648	ME 95387	3.451	ME 95390	3.635	ME 95393	4.244	ME 95396	4.192	ME 95399	4.161
kg	106		106		106		106		106		106		106		106	
1 box/ bulto	0.94 m3		0.94 m3		0.94 m3		0.94 m3		3.84 m3		0.94 m3		0.94 m3		0.94 m3	
**Polished Pulido	ME 95379	3.705	ME 95382	2.778	ME 95385	3.889	ME 95388	3.696	ME 95391	3.879	ME 95394	4.488	ME 95397	4.436	ME 95400	4.405
kg	106		106		106		106		106		106		106		106	
1 box/ bulto	1.24 m3		0.94 m3		0.94 m3		0.94 m3		3.84 m3		0.94 m3		0.94 m3		0.94 m3	
Oak Roble	ME 96109	3.994	ME 96110	3.012	ME 96111	4.188	ME 96112	3.985	ME 96113	4.179	ME 96114	4.825	ME 96115	4.768	ME 96116	4.734
kg	108		108		108		108		108		108		108		108	
1 box/ bulto	0.94 m3		0.94 m3		0.94 m3		0.94 m3		3.84 m3		0.94 m3		0.94 m3		0.94 m3	

Legs Patas	Table top / Sobre							
	*Oak Roble		Lacquered Lacado		LaminateTP LaminadoTP		Ultra-matteTP UltramateTP	
Top Edge Perfil								
White/Black Blanco/Negro	ME 95401	3.076	ME 95404	2.572	ME 95407	2.342	ME 95410	2.589
kg	106		106		106		106	
1 box/ bulto	0.94 m3		0.94 m3		0.94 m3		0.94 m3	
Anodized Anodizado	ME 95402	3.038	ME 95405	2.533	ME 95408	2.303	ME 95411	2.552
kg	106		106		106		106	
1 box/ bulto	0.94 m3		0.94 m3		0.94 m3		0.94 m3	
**Polished Pulido	ME 95403	3.277	ME 95406	2.778	ME 95409	2.547	ME 95412	2.788
kg	106		106		106		106	
1 box/ bulto	0.94 m3		0.94 m3		0.94 m3		0.94 m3	
Oak Roble	ME 96117	3.545	ME 96118	3.012	ME 96119	2.769	ME 96120	3.033
kg	108		108		108		108	
1 box/ bulto	0.94 m3		0.94 m3		0.94 m3		0.94 m3	

High Table  
1400 x 800 x 1100

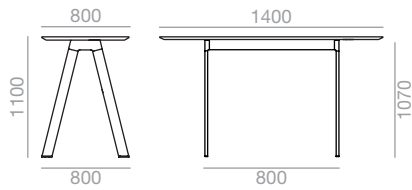

\*Matte lacquered and premium upcharge  
\*Incremento por lacado mate y premium

141

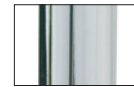

\*\*Polished chrome frame up charge  
\*\*Incremento por estructura en cromo brillo

165

\*\*\*Marble shiny upcharge  
Incremento por mármol brillo

30

Legs Patas	Table top / Sobre															
	*Oak Roble		Lacquered Lacado		Laminate Laminado		LaminateTP LaminadoTP		Low Iron Glass Cristal óptico		Linoleum Linóleo		Ultra-matte Ultramate		Ultra-matteTP UltramateTP	
Top Edge Perfil																
White/Black Blanco/Negro	ME 95413	2.563	ME 95416	2.074	ME 95419	2.562	ME 95422	2.565	ME 95425	2.734	ME 95428	3.120	ME 95431	3.118	ME 95434	3.090
kg	46		46		46		46		46		46		46		46	
1 box/ bulto	0.38 m3		0.38 m3		0.38 m3		0.38 m3		0.75 m3		0.38 m3		0.38 m3		0.38 m3	
Anodized Anodizado	ME 95414	2.543	ME 95417	2.046	ME 95420	2.538	ME 95423	2.539	ME 95426	2.709	ME 95429	3.094	ME 95432	3.092	ME 95435	3.063
kg	46		46		46		46		46		46		46		46	
1 box/ bulto	0.38 m3		0.38 m3		0.38 m3		0.38 m3		0.75 m3		0.38 m3		0.38 m3		0.38 m3	
**Polished Pulido	ME 95415	2.756	ME 95418	2.263	ME 95421	2.753	ME 95424	2.756	ME 95427	2.918	ME 95430	3.308	ME 95433	3.306	ME 95436	3.281
kg	46		46		46		46		46		46		46		46	
1 box/ bulto	0.38 m3		0.38 m3		0.38 m3		0.38 m3		0.75 m3		0.38 m3		0.38 m3		0.38 m3	
Oak Roble	ME 96121	3.059	ME 96122	2.538	ME 96123	3.057	ME 96124	3.060	ME 96125	3.240	ME 96126	3.647	ME 96127	3.643	ME 96128	3.614
kg	48		48		48		48		48		48		48		48	
1 box/ bulto	0.38 m3		0.38 m3		0.38 m3		0.38 m3		0.75 m3		0.38 m3		0.38 m3		0.38 m3	

Legs Patas	Table top / Sobre							
	*Oak Roble		Lacquered Lacado		LaminateTP LaminadoTP		Ultra-matteTP UltramateTP	
Top Edge Perfil								
White/Black Blanco/Negro	ME 95437	2.389	ME 95440	2.074	ME 95443	1.844	ME 95446	2.107
kg	46		46		46		46	
1 box/ bulto	0.38 m3		0.38 m3		0.38 m3		0.38 m3	
Anodized Anodizado	ME 95438	2.363	ME 95441	2.046	ME 95444	1.819	ME 95447	2.080
kg	46		46		46		46	
1 box/ bulto	0.38 m3		0.38 m3		0.38 m3		0.38 m3	
**Polished Pulido	ME 95439	2.578	ME 95442	2.263	ME 95445	2.035	ME 95448	2.294
kg	46		46		46		46	
1 box/ bulto	0.38 m3		0.38 m3		0.38 m3		0.38 m3	
Oak Roble	ME 96129	2.874	ME 96130	2.538	ME 96131	2.301	ME 96132	2.574
kg	48		48		48		48	
1 box/ bulto	0.38 m3		0.38 m3		0.38 m3		0.38 m3	

High Table  
1400 x 900 x 1100

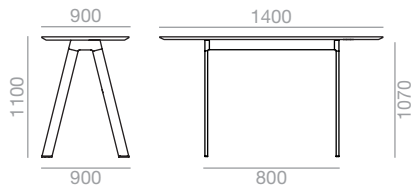

\*Matte lacquered and premium upcharge  
\*Incremento por lacado mate y premium

147

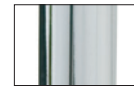

\*\*Polished chrome frame up charge  
\*\*Incremento por estructura en cromo brillo

165

\*\*\*Marble shiny upcharge  
Incremento por mármol brillo

30

Legs Patas	Table top / Sobre															
	*Oak Roble		Lacquered Lacado		Laminate Laminado		LaminateTP LaminadoTP		Low Iron Glass Cristal óptico		Linoleum Linóleo		Ultra-matte Ultramate		Ultra-matteTP UltramateTP	
Top Edge Perfil																
White/Black Blanco/Negro	ME 95449	2.565	ME 95452	2.077	ME 95455	2.564	ME 95458	2.580	ME 95461	2.764	ME 95464	3.133	ME 95467	3.131	ME 95470	3.101
kg	49		49		49		49		49		49		49		49	
1 box/ bulto	0.42 m3		0.42 m3		0.42 m3		0.42 m3		0.83 m3		0.42 m3		0.42 m3		0.42 m3	
Anodized Anodizado	ME 95450	2.544	ME 95453	2.051	ME 95456	2.541	ME 95459	2.554	ME 95462	2.738	ME 95465	3.105	ME 95468	3.104	ME 95471	3.077
kg	49		49		49		49		49		49		49		49	
1 box/ bulto	0.42 m3		0.42 m3		0.42 m3		0.42 m3		0.83 m3		0.42 m3		0.42 m3		0.42 m3	
**Polished Pulido	ME 95451	2.758	ME 95454	2.266	ME 95457	2.755	ME 95460	2.769	ME 95463	2.948	ME 95466	3.321	ME 95469	3.319	ME 95472	3.292
kg	49		49		49		49		49		49		49		49	
1 box/ bulto	0.42 m3		0.42 m3		0.42 m3		0.42 m3		0.83 m3		0.42 m3		0.42 m3		0.42 m3	
Oak Roble	ME 96133	3.060	ME 96134	2.543	ME 96135	3.059	ME 96136	3.076	ME 96137	3.270	ME 96138	3.657	ME 96139	3.655	ME 96140	3.626
kg	51		51		51		51		51		51		51		51	
1 box/ bulto	0.42 m3		0.42 m3		0.42 m3		0.42 m3		0.83 m3		0.42 m3		0.42 m3		0.42 m3	

Legs Patas	Table top / Sobre							
	*Oak Roble		Lacquered Lacado		LaminateTP LaminadoTP		Ultra-matteTP UltramateTP	
Top Edge Perfil								
White/Black Blanco/Negro	ME 95473	2.403	ME 95476	2.077	ME 95479	1.853	ME 95482	2.116
kg	49		49		49		49	
1 box/ bulto	0.42 m3		0.42 m3		0.42 m3		0.42 m3	
Anodized Anodizado	ME 95474	2.375	ME 95477	2.051	ME 95480	1.826	ME 95483	2.090
kg	49		49		49		49	
1 box/ bulto	0.42 m3		0.42 m3		0.42 m3		0.42 m3	
**Polished Pulido	ME 95475	2.594	ME 95478	2.266	ME 95481	2.040	ME 95484	2.307
kg	49		49		49		49	
1 box/ bulto	0.42 m3		0.42 m3		0.42 m3		0.42 m3	
Oak Roble	ME 96141	2.889	ME 96142	2.543	ME 96143	2.307	ME 96144	2.586
kg	51		51		51		51	
1 box/ bulto	0.42 m3		0.42 m3		0.42 m3		0.42 m3	



High Table  
1400 x 1000 x 1100

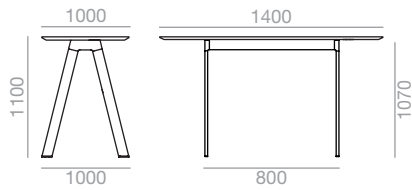

\*Matte lacquered and premium upcharge  
\*Incremento por lacado mate y premium

153



\*\*Polished chrome frame up charge  
\*\*Incremento por estructura en cromo brillo

165

\*\*\*Marble shiny upcharge  
Incremento por mármol brillo

30

Legs Patas	Table top / Sobre															
	*Oak Roble		Lacquered Lacado		Laminate Laminado		LaminateTP LaminadoTP		Low Iron Glass Cristal óptico		Linoleum Linóleo		Ultra-matte Ultramate		Ultra-matteTP UltramateTP	
Top Edge Perfil																
White/Black Blanco/Negro	ME 95485	2.569	ME 95488	2.090	ME 95491	2.567	ME 95494	2.595	ME 95497	2.793	ME 95500	3.143	ME 95503	3.142	ME 95506	3.115
kg	52		52		52		52		52		52		52		52	
1 box/ bulto	0.46 m3		0.46 m3		0.46 m3		0.46 m3		0.9 m3		0.46 m3		0.46 m3		0.46 m3	
Anodized Anodizado	ME 95486	2.548	ME 95489	2.064	ME 95492	2.543	ME 95495	2.569	ME 95498	2.766	ME 95501	3.118	ME 95504	3.115	ME 95507	3.089
kg	52		52		52		52		52		52		52		52	
1 box/ bulto	0.46 m3		0.46 m3		0.46 m3		0.46 m3		0.9 m3		0.46 m3		0.46 m3		0.46 m3	
**Polished Pulido	ME 95487	2.761	ME 95490	2.281	ME 95493	2.757	ME 95496	2.783	ME 95499	2.975	ME 95502	3.334	ME 95505	3.332	ME 95508	3.304
kg	52		52		52		52		52		52		52		52	
1 box/ bulto	0.46 m3		0.46 m3		0.46 m3		0.46 m3		0.9 m3		0.46 m3		0.46 m3		0.46 m3	
Oak Roble	ME 96145	3.062	ME 96146	2.558	ME 96147	3.062	ME 96148	3.092	ME 96149	3.301	ME 96150	3.672	ME 96151	3.669	ME 96152	3.642
kg	54		54		54		54		54		108		54		54	
1 box/ bulto	0.46 m3		0.46 m3		0.46 m3		0.46 m3		0.9 m3		0.46 m3		0.46 m3		0.46 m3	

Legs Patas	Table top / Sobre							
	*Oak Roble		Lacquered Lacado		LaminateTP LaminadoTP		Ultra-matteTP UltramateTP	
Top Edge Perfil								
White/Black Blanco/Negro	ME 95509	2.416	ME 95512	2.090	ME 95515	1.859	ME 95518	2.129
kg	52		52		52		52	
1 box/ bulto	0.46 m3		0.46 m3		0.46 m3		0.46 m3	
Anodized Anodizado	ME 95510	2.391	ME 95513	2.064	ME 95516	1.833	ME 95519	2.103
kg	52		52		52		52	
1 box/ bulto	0.46 m3		0.46 m3		0.46 m3		0.46 m3	
**Polished Pulido	ME 95511	2.608	ME 95514	2.281	ME 95517	2.049	ME 95520	2.319
kg	52		52		52		52	
1 box/ bulto	0.46 m3		0.46 m3		0.46 m3		0.46 m3	
Oak Roble	ME 96153	2.901	ME 96154	2.558	ME 96155	2.314	ME 96156	2.598
kg	54		54		54		54	
1 box/ bulto	0.46 m3		0.46 m3		0.46 m3		0.46 m3	

High Table  
1800 x 800 x 1100

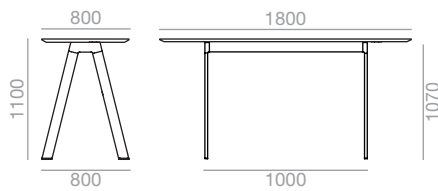

\*Matte lacquered and premium upcharge  
\*Incremento por lacado mate y premium

159



\*\*Polished chrome frame up charge  
\*\*Incremento por estructura en cromo brillo

165

\*\*\*Marble shiny upcharge  
Incremento por mármol brillo

30

Legs Patas	Table top / Sobre															
	*Oak Roble		Lacquered Lacado		Laminate Laminado		LaminateTP LaminadoTP		Low Iron Glass Cristal óptico		Linoleum Linóleo		Ultra-matte Ultramate		Ultra-matteTP UltramateTP	
Top Edge Perfil																
	Ref.	€	Ref.	€	Ref.	€	Ref.	€	Ref.	€	Ref.	€	Ref.	€	Ref.	€
White/Black Blanco/Negro	ME 95521	2.674	ME 95524	2.101	ME 95527	2.562	ME 95530	2.671	ME 95533	2.804	ME 95536	3.143	ME 95539	3.195	ME 95542	3.168
kg	57		57		57		57		57		57		57		57	
1 box/ bulto	0.48 m3		0.48 m3		0.48 m3		0.48 m3		0.94 m3		0.48 m3		0.48 m3		0.48 m3	
Anodized Anodizado	ME 95522	2.654	ME 95525	2.075	ME 95528	2.538	ME 95531	2.645	ME 95534	2.779	ME 95537	3.118	ME 95540	3.169	ME 95543	2.898
kg	57		57		57		57		57		57		57		57	
1 box/ bulto	0.48 m3		0.48 m3		0.48 m3		0.48 m3		0.94 m3		0.48 m3		0.48 m3		0.48 m3	
**Polished Pulido	ME 95523	2.868	ME 95526	2.291	ME 95529	2.753	ME 95532	2.860	ME 95535	2.987	ME 95538	3.334	ME 95541	3.384	ME 95544	3.359
kg	57		57		57		57		57		57		57		57	
1 box/ bulto	0.48 m3		0.48 m3		0.48 m3		0.48 m3		0.94 m3		0.48 m3		0.48 m3		0.48 m3	
Oak Roble	ME 96157	3.175	ME 96158	2.570	ME 96159	3.057	ME 96160	3.171	ME 96161	3.314	ME 96162	3.672	ME 96163	3.727	ME 96164	3.697
kg	59		59		59		59		59		59		59		59	
1 box/ bulto	0.48 m3		0.48 m3		0.48 m3		0.48 m3		0.94 m3		0.48 m3		0.48 m3		0.48 m3	

Legs Patas	Table top / Sobre							
	*Oak Roble		Lacquered Lacado		LaminateTP LaminadoTP		Ultra-matteTP UltramateTP	
Top Edge Perfil								
	Ref.	€	Ref.	€	Ref.	€	Ref.	€
White/Black Blanco/Negro	ME 95545	2.425	ME 95548	2.101	ME 95551	1.874	ME 95554	2.158
kg	57		57		57		57	
1 box/ bulto	0.48 m3		0.48 m3		0.48 m3		0.48 m3	
Anodized Anodizado	ME 95546	2.398	ME 95549	2.075	ME 95552	1.848	ME 95555	2.133
kg	57		57		57		57	
1 box/ bulto	0.48 m3		0.48 m3		0.48 m3		0.48 m3	
**Polished Pulido	ME 95547	2.614	ME 95550	2.291	ME 95553	2.063	ME 95556	2.349
kg	57		57		57		57	
1 box/ bulto	0.48 m3		0.48 m3		0.48 m3		0.48 m3	
Oak Roble	ME 96165	2.911	ME 96166	2.570	ME 96167	2.330	ME 96168	2.631
kg	59		59		59		59	
1 box/ bulto	0.48 m3		0.48 m3		0.48 m3		0.48 m3	

High Table  
1800 x 900 x 1100

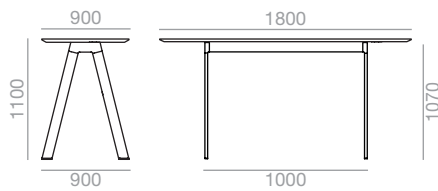

\*Matte lacquered and premium upcharge  
\*Incremento por lacado mate y premium

165



\*\*Polished chrome frame up charge  
\*\*Incremento por estructura en cromo brillo

165

\*\*\*Marble shiny upcharge  
Incremento por mármol brillo

30

Legs Patas	Table top / Sobre															
	*Oak Roble		Lacquered Lacado		Laminate Laminado		LaminateTP LaminadoTP		Low Iron Glass Cristal óptico		Linoleum Linóleo		Ultra-matte Ultramate		Ultra-matteTP UltramateTP	
Top Edge Perfil																
White/Black Blanco/Negro	ME 95557	2.677	ME 95560	2.107	ME 95563	2.833	ME 95566	2.684	ME 95569	2.834	ME 95572	3.155	ME 95575	3.207	ME 95578	3.179
kg	62		62		62		62		62		62		62		62	
1 box/ bulto	0.53 m3		0.53 m3		0.53 m3		0.53 m3		1.03 m3		0.53 m3		0.53 m3		0.53 m3	
Anodized Anodizado	ME 95558	2.655	ME 95561	2.080	ME 95564	2.809	ME 95567	2.658	ME 95570	2.807	ME 95573	3.131	ME 95576	3.181	ME 95579	3.154
kg	62		62		62		62		62		62		62		62	
1 box/ bulto	0.53 m3		0.53 m3		0.53 m3		0.53 m3		1.03 m3		0.53 m3		0.53 m3		0.53 m3	
**Polished Pulido	ME 95559	2.870	ME 95562	2.294	ME 95565	3.023	ME 95568	2.874	ME 95571	3.015	ME 95574	3.344	ME 95577	3.397	ME 95580	3.151
kg	62		62		62		62		62		62		62		62	
1 box/ bulto	0.53 m3		0.53 m3		0.53 m3		0.53 m3		1.03 m3		0.53 m3		0.53 m3		0.53 m3	
Oak Roble	ME 96169	3.177	ME 96170	2.574	ME 96171	3.343	ME 96172	3.186	ME 96173	3.343	ME 96174	3.685	ME 96175	3.739	ME 96176	3.709
kg	64		64		64		64		64		64		64		64	
1 box/ bulto	0.53 m3		0.53 m3		0.53 m3		0.53 m3		1.03 m3		0.53 m3		0.53 m3		0.53 m3	

Legs Patas	Table top / Sobre							
	*Oak Roble		Lacquered Lacado		LaminateTP LaminadoTP		Ultra-matteTP UltramateTP	
Top Edge Perfil								
White/Black Blanco/Negro	ME 95581	2.439	ME 95584	2.107	ME 95587	1.880	ME 95590	2.170
kg	62		62		62		62	
1 box/ bulto	0.53 m3		0.53 m3		0.53 m3		0.53 m3	
Anodized Anodizado	ME 95582	2.413	ME 95585	2.080	ME 95588	1.855	ME 95591	2.145
kg	62		62		62		62	
1 box/ bulto	0.53 m3		0.53 m3		0.53 m3		0.53 m3	
**Polished Pulido	ME 95583	2.630	ME 95586	2.294	ME 95589	2.072	ME 95592	2.360
kg	62		62		62		62	
1 box/ bulto	0.53 m3		0.53 m3		0.53 m3		0.53 m3	
Oak Roble	ME 96177	2.925	ME 96178	2.574	ME 96179	2.336	ME 96180	2.642
kg	64		64		64		64	
1 box/ bulto	0.53 m3		0.53 m3		0.53 m3		0.53 m3	

High Table  
1800 x 1000 x 1100

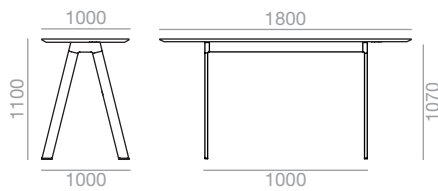

\*Matte lacquered and premium upcharge  
\*Incremento por lacado mate y premium

171



\*\*Polished chrome frame up charge  
\*\*Incremento por estructura en cromo brillo

165

\*\*\*Marble shiny upcharge  
Incremento por mármol brillo

30

Legs Patas	Table top / Sobre															
	*Oak Roble		Lacquered Lacado		Laminate Laminado		LaminateTP LaminadoTP		Low Iron Glass Cristal óptico		Linoleum Linóleo		Ultra-matte Ultramate		Ultra-matteTP UltramateTP	
Top Edge Perfil																
White/Black Blanco/Negro	ME 95593	2.678	ME 95596	2.119	ME 95599	2.837	ME 95602	2.697	ME 95605	2.862	ME 95608	3.168	ME 95611	3.220	ME 95614	3.193
kg	66		66		66		66		66		66		66		66	
1 box/ bulto	0.58 m3		0.58 m3		0.58 m3		0.58 m3		1.13 m3		0.58 m3		0.58 m3		0.58 m3	
Anodized Anodizado	ME 95594	2.658	ME 95597	2.094	ME 95600	2.812	ME 95603	2.673	ME 95606	2.838	ME 95609	3.142	ME 95612	3.194	ME 95615	3.167
kg	66		66		66		66		66		66		66		66	
1 box/ bulto	0.58 m3		0.58 m3		0.58 m3		0.58 m3		1.13 m3		0.58 m3		0.58 m3		0.58 m3	
**Polished Pulido	ME 95595	2.871	ME 95598	2.310	ME 95601	3.025	ME 95604	2.889	ME 95607	3.045	ME 95610	3.358	ME 95613	3.410	ME 95616	3.381
kg	66		66		66		66		66		66		66		66	
1 box/ bulto	0.58 m3		0.58 m3		0.58 m3		0.58 m3		1.13 m3		0.58 m3		0.58 m3		0.58 m3	
Oak Roble	ME 96181	3.179	ME 96182	2.589	ME 96183	3.345	ME 96184	3.200	ME 96185	3.375	ME 96186	3.697	ME 96187	3.750	ME 96188	3.724
kg	68		68		68		68		68		68		68		68	
1 box/ bulto	0.58 m3		0.58 m3		0.58 m3		0.58 m3		1.13 m3		0.58 m3		0.58 m3		0.58 m3	

Legs Patas	Table top / Sobre							
	*Oak Roble		Lacquered Lacado		LaminateTP LaminadoTP		Ultra-matteTP UltramateTP	
Top Edge Perfil								
White/Black Blanco/Negro	ME 95617	2.451	ME 95620	2.119	ME 95623	1.889	ME 95626	2.183
kg	66		66		66		66	
1 box/ bulto	0.58 m3		0.58 m3		0.58 m3		0.58 m3	
Anodized Anodizado	ME 95618	2.427	ME 95621	2.094	ME 95624	1.863	ME 95627	2.155
kg	66		66		66		66	
1 box/ bulto	0.58 m3		0.58 m3		0.58 m3		0.58 m3	
**Polished Pulido	ME 95619	2.644	ME 95622	2.310	ME 95625	2.078	ME 95628	2.372
kg	66		66		66		66	
1 box/ bulto	0.58 m3		0.58 m3		0.58 m3		0.58 m3	
Oak Roble	ME 96189	2.941	ME 96190	2.589	ME 96191	2.343	ME 96192	2.654
kg	68		68		68		68	
1 box/ bulto	0.58 m3		0.58 m3		0.58 m3		0.58 m3	

High Table  
2400 x 800 x 1100

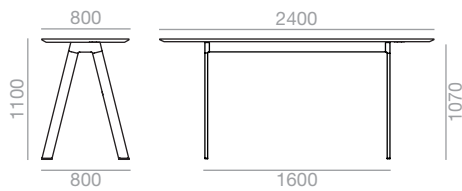

\*Matte lacquered and premium upcharge  
\*Incremento por lacado mate y premium

177



\*\*Polished chrome frame up charge  
\*\*Incremento por estructura en cromo brillo

165

\*\*\*Marble shiny upcharge  
Incremento por mármol brillo

30

Legs Patas	Table top / Sobre															
	*Oak Roble		Lacquered Lacado		Laminate Laminado		LaminateTP LaminadoTP		Low Iron Glass Cristal óptico		Linoleum Linóleo		Ultra-matte Ultramate		Ultra-matteTP UltramateTP	
Top Edge Perfil																
White/Black Blanco/Negro	ME 95629	2.904	ME 95632	2.305	ME 95635	2.971	ME 95638	2.814	ME 95641	3.204	ME 95644	3.320	ME 95647	3.487	ME 95650	3.455
kg	74		74		74		74		74		74		74		74	
1 box/ bulto	0.63 m3		0.63 m3		0.63 m3		0.63 m3		1.22 m3		0.63 m3		0.63 m3		0.63 m3	
Anodized Anodizado	ME 95630	2.875	ME 95633	2.271	ME 95636	2.943	ME 95639	2.779	ME 95642	3.169	ME 95645	3.287	ME 95648	3.452	ME 95651	3.423
kg	74		74		74		74		74		74		74		74	
1 box/ bulto	0.63 m3		0.63 m3		0.63 m3		0.63 m3		1.22 m3		0.63 m3		0.63 m3		0.63 m3	
**Polished Pulido	ME 95631	3.106	ME 95634	2.504	ME 95637	3.173	ME 95640	3.012	ME 95643	3.402	ME 95646	3.522	ME 95649	3.687	ME 95652	3.656
kg	74		74		74		74		74		74		74		74	
1 box/ bulto	0.63 m3		0.63 m3		0.63 m3		0.63 m3		1.22 m3		0.63 m3		0.63 m3		0.63 m3	
Oak Roble	ME 96193	3.419	ME 96194	2.783	ME 96195	3.489	ME 96196	3.323	ME 96197	3.733	ME 96198	3.858	ME 96199	4.033	ME 96200	4.003
kg	76		76		76		76		76		76		76		76	
1 box/ bulto	0.63 m3		0.63 m3		0.63 m3		0.63 m3		1.22 m3		0.63 m3		0.63 m3		0.63 m3	

Legs Patas	Table top / Sobre							
	*Oak Roble		Lacquered Lacado		LaminateTP LaminadoTP		Ultra-matteTP UltramateTP	
Top Edge Perfil								
White/Black Blanco/Negro	ME 95653	2.770	ME 95656	2.305	ME 95659	2.038	ME 95662	2.488
kg	74		74		74		74	
1 box/ bulto	0.63 m3		0.63 m3		0.63 m3		0.63 m3	
Anodized Anodizado	ME 95654	2.736	ME 95657	2.271	ME 95660	2.008	ME 95663	2.454
kg	74		74		74		74	
1 box/ bulto	0.63 m3		0.63 m3		0.63 m3		0.63 m3	
**Polished Pulido	ME 95655	2.971	ME 95658	2.504	ME 95661	2.288	ME 95664	2.734
kg	74		74		74		74	
1 box/ bulto	0.63 m3		0.63 m3		0.63 m3		0.63 m3	
Oak Roble	ME 96201	3.280	ME 96202	2.783	ME 96203	2.503	ME 96204	2.978
kg	76		76		76		76	
1 box/ bulto	0.63 m3		0.63 m3		0.63 m3		0.63 m3	

High Table  
2400 x 900 x 1100

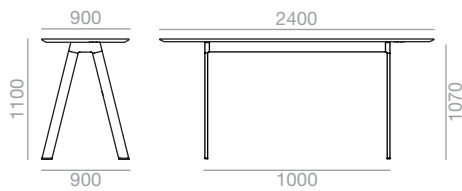

\*Matte lacquered and premium upcharge  
\*Incremento por lacado mate y premium

183



\*\*Polished chrome frame up charge  
\*\*Incremento por estructura en cromo brillo

165

\*\*\*Marble shiny upcharge  
Incremento por mármol brillo

30

Legs Patas	Table top / Sobre															
	*Oak Roble		Lacquered Lacado		Laminate Laminado		LaminateTP LaminadoTP		Low Iron Glass Cristal óptico		Linoleum Linóleo		Ultra-matte Ultramate		Ultra-matteTP UltramateTP	
Top Edge Perfil																
White/Black Blanco/Negro	ME 95665	2.908	ME 95668	2.320	ME 95671	2.974	ME 95674	2.833	ME 95677	3.231	ME 95680	3.333	ME 95683	3.500	ME 95686	3.468
kg	80		80		80		80		80		80		80		80	
1 box/ bulto	0.69 m3		0.69 m3		0.69 m3		0.69 m3		1.34 m3		0.69 m3		0.69 m3		0.69 m3	
Anodized Anodizado	ME 95666	2.877	ME 95669	2.287	ME 95672	2.944	ME 95675	2.798	ME 95678	3.197	ME 95681	3.300	ME 95684	3.465	ME 95687	3.435
kg	80		80		80		80		80		80		80		80	
1 box/ bulto	0.69 m3		0.69 m3		0.69 m3		0.69 m3		1.34 m3		0.69 m3		0.69 m3		0.69 m3	
**Polished Pulido	ME 95667	3.110	ME 95670	2.521	ME 95673	3.175	ME 95676	3.033	ME 95679	3.430	ME 95682	3.532	ME 95685	3.698	ME 95688	3.668
kg	80		80		80		80		80		80		80		80	
1 box/ bulto	0.69 m3		0.69 m3		0.69 m3		0.69 m3		1.34 m3		0.69 m3		0.69 m3		0.69 m3	
Oak Roble	ME 96205	3.423	ME 96206	2.802	ME 96207	3.490	ME 96208	3.342	ME 96209	3.765	ME 96210	3.872	ME 96211	4.046	ME 96212	4.016
kg	82		82		82		82		213		82		82		82	
1 box/ bulto	0.69 m3		0.69 m3		0.69 m3		0.69 m3		1.34 m3		0.69 m3		0.69 m3		0.69 m3	

Legs Patas	Table top / Sobre							
	*Oak Roble		Lacquered Lacado		LaminateTP LaminadoTP		Ultra-matteTP UltramateTP	
Top Edge Perfil								
White/Black Blanco/Negro	ME 95689	2.785	ME 95692	2.320	ME 95695	2.046	ME 95698	2.502
kg	80		80		80		80	
1 box/ bulto	0.69 m3		0.69 m3		0.69 m3		0.69 m3	
Anodized Anodizado	ME 95690	2.751	ME 95693	2.287	ME 95696	2.016	ME 95699	2.466
kg	80		80		80		80	
1 box/ bulto	0.69 m3		0.69 m3		0.69 m3		0.69 m3	
**Polished Pulido	ME 95691	2.984	ME 95694	2.521	ME 95697	2.294	ME 95700	2.748
kg	80		80		80		80	
1 box/ bulto	0.69 m3		0.69 m3		0.69 m3		0.69 m3	
Oak Roble	ME 96213	3.292	ME 96214	2.802	ME 96215	2.510	ME 96216	2.993
kg	82		82		82		82	
1 box/ bulto	0.69 m3		0.69 m3		0.69 m3		0.69 m3	

High Table  
2400 x 1000 x 1100

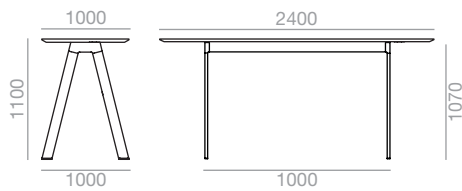

\*Matte lacquered and premium upcharge  
\*Incremento por lacado mate y premium

189



\*\*Polished chrome frame up charge  
\*\*Incremento por estructura en cromo brillo

165

\*\*\*Marble shiny upcharge  
Incremento por mármol brillo

30

Legs Patas	Table top / Sobre															
	*Oak Roble		Lacquered Lacado		Laminate Laminado		LaminateTP LaminadoTP		Low Iron Glass Cristal óptico		Linoleum Linóleo		Ultra-matte Ultramate		Ultra-matteTP UltramateTP	
Top Edge Perfil																
White/Black Blanco/Negro	ME 95701	2.910	ME 95704	2.338	ME 95707	2.976	ME 95710	2.853	ME 95713	3.260	ME 95716	3.344	ME 95719	3.510	ME 95722	3.481
kg	86		86		86		86		86		86		86		86	
1 box/ bulto	0.76 m3		0.76 m3		0.76 m3		0.76 m3		1.35 m3		0.76 m3		0.76 m3		0.76 m3	
Anodized Anodizado	ME 95702	2.880	ME 95705	2.303	ME 95708	2.948	ME 95711	2.816	ME 95714	3.474	ME 95717	3.312	ME 95720	3.476	ME 95723	3.446
kg	86		86		86		86		86		86		86		86	
1 box/ bulto	0.76 m3		0.76 m3		0.76 m3		0.76 m3		1.35 m3		0.76 m3		0.76 m3		0.76 m3	
**Polished Pulido	ME 95703	3.113	ME 95706	2.536	ME 95709	3.178	ME 95712	3.051	ME 95715	3.460	ME 95718	3.544	ME 95721	3.710	ME 95724	3.680
kg	86		86		86		86		86		86		86		86	
1 box/ bulto	0.76 m3		0.76 m3		0.76 m3		0.76 m3		1.35 m3		0.76 m3		0.76 m3		0.76 m3	
Oak Roble	ME 96217	3.424	ME 96218	2.817	ME 96219	3.495	ME 96220	3.363	ME 96221	3.795	ME 96222	3.885	ME 96223	4.061	ME 96224	4.027
kg	88		88		88		88		88		88		88		88	
1 box/ bulto	0.76 m3		0.76 m3		0.76 m3		0.76 m3		1.47 m3		0.76 m3		0.76 m3		0.76 m3	

Legs Patas	Table top / Sobre							
	*Oak Roble		Lacquered Lacado		LaminateTP LaminadoTP		Ultra-matteTP UltramateTP	
Top Edge Perfil								
White/Black Blanco/Negro	ME 95725	2.793	ME 95728	2.338	ME 95731	2.052	ME 95734	2.513
kg	86		86		86		86	
1 box/ bulto	0.76 m3		0.76 m3		0.76 m3		0.76 m3	
Anodized Anodizado	ME 95726	2.758	ME 95729	2.303	ME 95732	2.023	ME 95735	2.478
kg	86		86		86		86	
1 box/ bulto	0.76 m3		0.76 m3		0.76 m3		0.76 m3	
**Polished Pulido	ME 95727	2.993	ME 95730	2.536	ME 95733	2.303	ME 95736	2.760
kg	86		86		86		86	
1 box/ bulto	0.76 m3		0.76 m3		0.76 m3		0.76 m3	
Oak Roble	ME 96225	3.301	ME 96226	2.817	ME 96227	2.520	ME 96228	3.005
kg	88		88		88		88	
1 box/ bulto	0.76 m3		0.76 m3		0.76 m3		0.76 m3	

High Table  
3000 x 800 x 1100

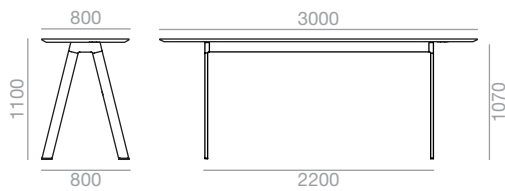

\*Matte lacquered and premium upcharge

\*Incremento por lacado mate y premium

195



\*\*Polished chrome frame up charge

\*\*Incremento por estructura en cromo brillo

165

\*\*\*Marble shiny upcharge  
Incremento por mármol brillo

30

Legs Patas	Table top / Sobre															
	*Oak Roble		Lacquered Lacado		Laminate Laminado		LaminateTP LaminadoTP		Low Iron Glass Cristal óptico		Linoleum Linóleo		Ultra-matte Ultramate		Ultra-matteTP UltramateTP	
Top Edge Perfil																
	Ref.	€	Ref.	€	Ref.	€	Ref.	€	Ref.	€	Ref.	€	Ref.	€	Ref.	€
White/Black Blanco/Negro	ME 95737	3.522	ME 95740	2.563	ME 95743	3.704	ME 95746	3.483	ME 95749	3.648	ME 95752	4.290	ME 95755	4.238	ME 95758	4.207
kg	92		92		92		92		92		92		92		92	
1 box/ bulto	0.78 m3		0.78 m3		0.78 m3		0.78 m3		3.2 m3		0.78 m3		0.78 m3		0.78 m3	
Anodized Anodizado	ME 95738	3.479	ME 95741	2.521	ME 95744	3.667	ME 95747	3.440	ME 95750	3.605	ME 95753	4.246	ME 95756	4.194	ME 95759	4.162
kg	92		92		92		92		92		92		92		92	
1 box/ bulto	0.78 m3		0.78 m3		0.78 m3		0.78 m3		3.2 m3		0.78 m3		0.78 m3		0.78 m3	
**Polished Pulido	ME 95739	3.730	ME 95742	2.771	ME 95745	3.915	ME 95748	3.693	ME 95751	3.856	ME 95754	4.499	ME 95757	4.447	ME 95760	4.417
kg	92		92		92		92		92		92		92		92	
1 box/ bulto	0.78 m3		0.78 m3		0.78 m3		0.78 m3		3.2 m3		0.78 m3		0.78 m3		0.78 m3	
Oak Roble	ME 96229	4.071	ME 96230	3.059	ME 96231	4.264	ME 96232	4.029	ME 96233	4.204	ME 96234	4.880	ME 96235	4.829	ME 96236	4.795
kg	94		94		94		94		94		94		94		94	
1 box/ bulto	0.78 m3		0.78 m3		0.78 m3		0.78 m3		3.2 m3		0.78 m3		0.78 m3		0.78 m3	

Legs Patas	Table top / Sobre							
	*Oak Roble		Lacquered Lacado		LaminateTP LaminadoTP		Ultra-matteTP UltramateTP	
Top Edge Perfil								
	Ref.	€	Ref.	€	Ref.	€	Ref.	€
White/Black Blanco/Negro	ME 95761	3.067	ME 95764	2.563	ME 95767	2.357	ME 95770	2.595
kg	92		92		92		92	
1 box/ bulto	0.78 m3		0.78 m3		0.78 m3		0.78 m3	
Anodized Anodizado	ME 95762	3.026	ME 95765	2.521	ME 95768	2.314	ME 95771	2.554
kg	92		92		92		92	
1 box/ bulto	0.78 m3		0.78 m3		0.78 m3		0.78 m3	
**Polished Pulido	ME 95763	3.270	ME 95766	2.771	ME 95769	2.565	ME 95772	2.798
kg	92		92		92		92	
1 box/ bulto	0.78 m3		0.78 m3		0.78 m3		0.78 m3	
Oak Roble	ME 96237	3.590	ME 96238	3.059	ME 96239	2.839	ME 96240	3.089
kg	94		94		94		101	
1 box/ bulto	0.78 m3		0.78 m3		0.78 m3		0.78 m3	



High Table  
3000 x 900 x 1100

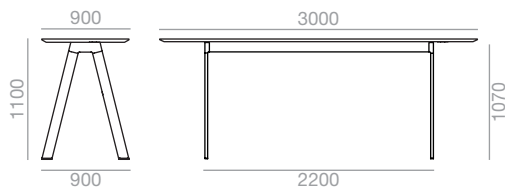

\*Matte lacquered and premium upcharge  
\*Incremento por lacado mate y premium

201

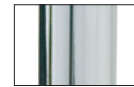

\*\*Polished chrome frame up charge  
\*\*Incremento por estructura en cromo brillo

165

\*\*\*Marble shiny upcharge  
Incremento por mármol brillo

30

Legs Patas	Table top / Sobre															
	*Oak Roble		Lacquered Lacado		Laminate Laminado		LaminateTP LaminadoTP		Low Iron Glass Cristal óptico		Linoleum Linóleo		Ultra-matte Ultramate		Ultra-matteTP UltramateTP	
Top Edge Perfil																
White/Black Blanco/Negro	ME 95773	3.526	ME 95776	2.583	ME 95779	3.708	ME 95782	3.501	ME 95785	3.674	ME 95788	4.302	ME 95791	4.251	ME 95794	4.219
kg	99		99		99		99		99		99		99		99	
1 box/ bulto	0.86 m3		0.86 m3		0.86 m3		0.86 m3		3.52 m3		0.86 m3		0.86 m3		0.86 m3	
Anodized Anodizado	ME 95774	3.483	ME 95777	2.538	ME 95780	3.670	ME 95783	3.459	ME 95786	3.633	ME 95789	4.259	ME 95792	4.207	ME 95795	4.175
kg	99		99		99		99		99		99		99		99	
1 box/ bulto	0.86 m3		0.86 m3		0.86 m3		0.86 m3		3.52 m3		0.86 m3		0.86 m3		0.86 m3	
**Polished Pulido	ME 95775	3.733	ME 95778	2.792	ME 95781	3.918	ME 95784	3.710	ME 95787	3.885	ME 95790	4.510	ME 95793	4.459	ME 95796	4.428
kg	99		99		99		99		99		99		99		99	
1 box/ bulto	0.86 m3		0.86 m3		0.86 m3		0.86 m3		3.52 m3		0.86 m3		0.86 m3		0.86 m3	
Oak Roble	ME 96241	4.075	ME 96242	3.077	ME 96243	4.267	ME 96244	4.050	ME 96245	4.232	ME 96246	4.896	ME 96247	4.841	ME 96248	4.806
kg	101		101		101		101		101		101		101		101	
1 box/ bulto	0.86 m3		0.86 m3		0.86 m3		0.86 m3		3.52 m3		0.86 m3		0.86 m3		0.86 m3	

Legs Patas	Table top / Sobre							
	*Oak Roble		Lacquered Lacado		LaminateTP LaminadoTP		Ultra-matteTP UltramateTP	
Top Edge Perfil								
White/Black Blanco/Negro	ME 95797	3.086	ME 95800	2.583	ME 95803	2.364	ME 95806	2.605
kg	99		99		99		99	
1 box/ bulto	0.86 m3		0.86 m3		0.86 m3		0.86 m3	
Anodized Anodizado	ME 95798	3.045	ME 95801	2.538	ME 95804	2.320	ME 95807	2.565
kg	99		99		99		99	
1 box/ bulto	0.86 m3		0.86 m3		0.86 m3		0.86 m3	
**Polished Pulido	ME 95799	3.289	ME 95802	2.792	ME 95805	2.572	ME 95808	2.809
kg	99		99		99		99	
1 box/ bulto	0.86 m3		0.86 m3		0.86 m3		0.86 m3	
Oak Roble	ME 96249	3.611	ME 96250	3.077	ME 96251	2.848	ME 96252	3.104
kg	101		101		101		101	
1 box/ bulto	0.86 m3		0.86 m3		0.86 m3		0.86 m3	

High Table  
3000 x 1000 x 1100

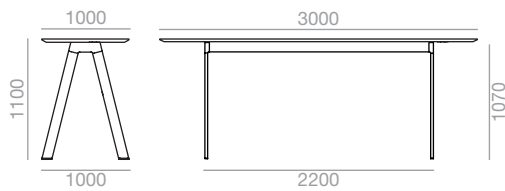

\*Matte lacquered and premium upcharge  
\*Incremento por lacado mate y premium

207



\*\*Polished chrome frame up charge  
\*\*Incremento por estructura en cromo brillo

165

\*\*\*Marble shiny upcharge  
Incremento por mármol brillo

30

Legs Patas	Table top / Sobre															
	*Oak Roble		Lacquered Lacado		Laminate Laminado		LaminateTP LaminadoTP		Low Iron Glass Cristal óptico		Linoleum Linóleo		Ultra-matte Ultramate		Ultra-matteTP UltramateTP	
Top Edge Perfil																
White/Black Blanco/Negro	ME 95809	3.529	ME 95812	2.600	ME 95815	3.710	ME 95818	3.522	ME 95821	3.704	ME 95824	4.313	ME 95827	4.261	ME 95830	4.231
kg	106		106		106		106		106		106		106		106	
1 box/ bulto	0.94 m3		0.94 m3		0.94 m3		0.94 m3		3.84 m3		0.94 m3		0.94 m3		0.94 m3	
Anodized Anodizado	ME 95810	3.487	ME 95813	2.558	ME 95816	3.672	ME 95819	3.479	ME 95822	3.660	ME 95825	4.269	ME 95828	4.219	ME 95831	4.188
kg	106		106		106		106		106		106		106		106	
1 box/ bulto	0.94 m3		0.94 m3		0.94 m3		0.94 m3		3.84 m3		0.94 m3		0.94 m3		0.94 m3	
**Polished Pulido	ME 95811	3.740	ME 95814	2.809	ME 95817	3.924	ME 95820	3.730	ME 95823	3.913	ME 95826	4.523	ME 95829	4.472	ME 95832	4.439
kg	106		106		106		106		106		106		106		106	
1 box/ bulto	0.94 m3		0.94 m3		0.94 m3		0.94 m3		3.84 m3		0.94 m3		0.94 m3		0.94 m3	
Oak Roble	ME 96253	4.080	ME 96254	3.315	ME 96255	4.271	ME 96256	4.071	ME 96257	4.264	ME 96258	4.909	ME 96259	4.852	ME 96260	4.820
kg	108		108		108		108		108		108		108		108	
1 box/ bulto	0.94 m3		0.94 m3		0.94 m3		0.94 m3		3.84 m3		0.94 m3		0.94 m3		0.94 m3	

Legs Patas	Table top / Sobre							
	*Oak Roble		Lacquered Lacado		LaminateTP LaminadoTP		Ultra-matteTP UltramateTP	
Top Edge Perfil								
White/Black Blanco/Negro	ME 95833	3.105	ME 95836	2.600	ME 95839	2.370	ME 95842	2.617
kg	106		106		106		106	
1 box/ bulto	0.94 m3		0.94 m3		0.94 m3		0.94 m3	
Anodized Anodizado	ME 95834	3.063	ME 95837	2.558	ME 95840	2.327	ME 95843	2.577
kg	106		106		106		106	
1 box/ bulto	0.94 m3		0.94 m3		0.94 m3		0.94 m3	
**Polished Pulido	ME 95835	3.307	ME 95838	2.809	ME 95841	2.580	ME 95844	2.821
kg	106		106		106		106	
1 box/ bulto	0.94 m3		0.94 m3		0.94 m3		0.94 m3	
Oak Roble	ME 96261	3.632	ME 96262	3.097	ME 96263	2.856	ME 96264	3.238
kg	108		108		108		108	
1 box/ bulto	0.94 m3		0.94 m3		0.94 m3		0.94 m3	

Maximum table heights  
Alturas máximas de mesa

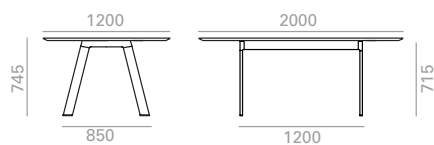

Table top / Sobre					
*Oak Roble	Lacquered Lacado	Laminate Laminado	LaminateTP LaminadoTP	Low Iron Glass Cristal óptico	Linoleum Linóleo
746	746	746	746	751	746

Table top / Sobre					
Oak Roble	Lacquered Lacado	LaminateTP LaminadoTP	Ultra-matteTP UltramateTP	***M1 Marble Mármol M1	***M3 Marble Mármol M3
746	746	746	746	748	748

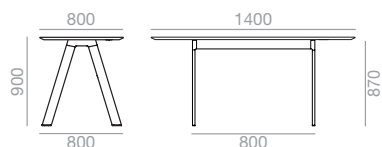

Table top / Sobre					
*Oak Roble	Lacquered Lacado	Laminate Laminado	LaminateTP LaminadoTP	Low Iron Glass Cristal óptico	Linoleum Linóleo
894	894	894	894	899	894

Table top / Sobre					
*Oak Roble	Lacquered Lacado	Laminate Laminado	LaminateTP LaminadoTP	Low Iron Glass Cristal óptico	Linoleum Linóleo
894	894	894	894	899	894

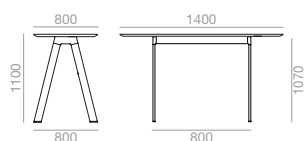
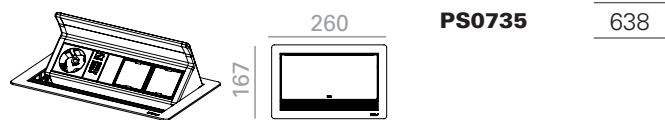

Table top / Sobre					
*Oak Roble	Lacquered Lacado	Laminate Laminado	LaminateTP LaminadoTP	Low Iron Glass Cristal óptico	Linoleum Linóleo
1094	1094	1094	1094	1099	1094

Table top / Sobre					
*Oak Roble	Lacquered Lacado	Laminate Laminado	LaminateTP LaminadoTP	Low Iron Glass Cristal óptico	Linoleum Linóleo
1094	1094	1094	1094	1099	1094

PS-IN SURFACE



**PS0735** 638

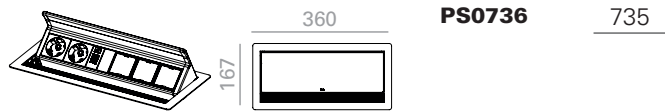

**PS0736** 735



**PS0804** 142

PS-QI



**PS0714** 243

PS-INTREGATED

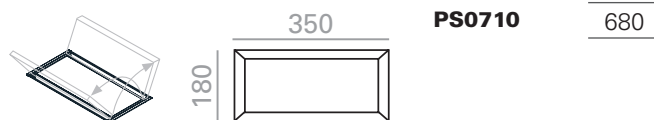

**PS0710** 680



**PS0720** 743

**Preinstalled (Optional) / Preinstalación (Opcional)**  
**IN0006**

First installation / Primera instalación 270

Second and more installations / Segunda y más instalaciones 90

**IN-SURFACE POWER BOXES  
CAJAS DE CONEXIONES DENTRO DEL SOBRE**

Aluminum power box mounted in the table top with a folding protective lid. It is served in anodized silver, black or white, for other finishing, contact the Customer Department. There are two power system sizes available and data slots can be customized according to the below diagram.

Caja de conexiones de aluminio integrada dentro de la superficie del sobre con tapa abatible. Se sirve en color anodizado plata, negro o blanco, para otros acabados consultar al Departamento Comercial. Se ofrecen dos tamaños de caja diferentes y con conectividad configurable, acorde al siguiente esquema:

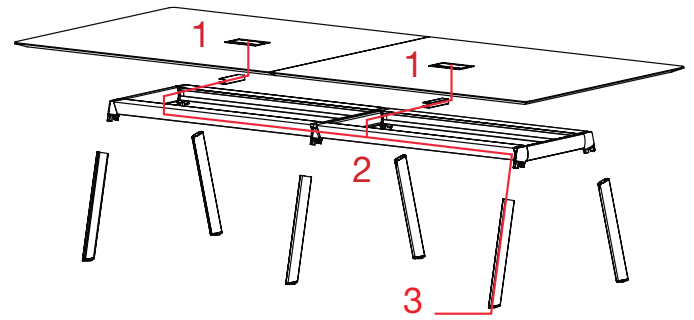

**PS0735**

**PS0736**

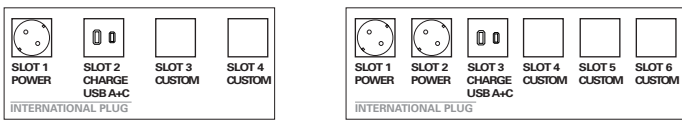

CHOOSE DATA PORT FOR DATA CUSTOM PORT SLOTS

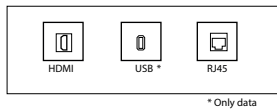

**1 POWER BOXES DISTRIBUTION DISTRIBUCIÓN DE SISTEMAS**

By standard, the position of the system will be in the central of the table, placed horizontally. When there are two system boxes, these will be separated 1/3 between them and placed horizontally. For other options, please contact the Customer Department.

De serie, la disposición del sistema será en el centro de la mesa y en sentido longitudinal. Cuando se disponga de dos sistemas, estos se colocarán con una separación de 1/3 de la longitud total de la mesa, y en sentido longitudinal. Otras opciones consultar con el Departamento Comercial.

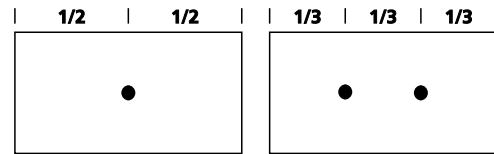

**OPTIONAL PREINSTALLED WIRING  
PREINSTALACIÓN DEL CABLEADO**

**IN0006**

Preinstalled wiring consists in the addition of the necessary mechanisms to integrate power systems in the table, so that wiring is hidden until the way out in the floor. Necessary grommet are included and 3m cable (from the power system). For other cable dimensions contact the Customer Department.

La preinstalación consiste en el montaje de los mecanismos necesarios para integrar el sistema de electrificación en la mesa, de modo que el cableado quede oculto hasta su salida por la base. Se incluyen los pasacables necesarios y 3 metros de cable (midiendo desde el sistema de conexiones). Para otras medidas de cable consultar al Departamento Comercial.

**2 WIRING MANAGEMENT GESTIÓN DEL CABLEADO**

Wire pass through an aluminum grommet keeping it hidden. By default color is silver, for other finishings ask the Customer Department.

El cable se pasa a través de un perfil pasacables de aluminio que lo mantiene oculto. Su color de serie es el plata, para otros acabados consultar al Departamento Comercial.

**3 CABLE WAY OUT SALIDA DE CABLEADO**

The cable exits directly the power system or through an aluminum frame so that it remains hidden until it reaches the floor.

La salida del cable se realiza directamente desde el propio sistema de conexiones o a través de un perfil de aluminio en la parte inferior de la base, de modo que el cable queda oculto hasta llegar al suelo.

**INTEGRATED POWER BOXES  
CAJAS DE CONEXIONES INTEGRADAS**

The black finish is integrated with the top. Its opening is towards both sides.

El acabado negro está integrado con la parte superior. Su apertura es hacia ambos lados.

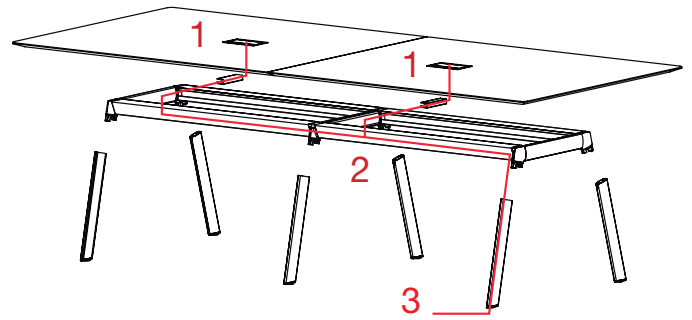

**1 POWER BOXES DISTRIBUTION DISTRIBUCIÓN DE SISTEMAS**

By standard, the position of the system will be in the central of the table, placed horizontally. When there are two system boxes, these will be separated 1/3 between them and placed horizontally. For other options, please contact the Customer Department.

De serie, la disposición del sistema será en el centro de la mesa y en sentido longitudinal. Cuando se disponga de dos sistemas, estos se colocarán con una separación de 1/3 de la longitud total de la mesa, y en sentido longitudinal. Otras opciones consultar con el Departamento Comercial.

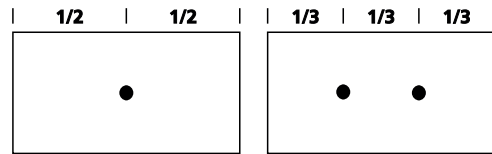

**2 WIRING MANAGEMENT GESTIÓN DEL CABLEADO**

Wire pass through an aluminum grommet keeping it hidden. By default color is silver, for other finishings ask the Customer Department.

El cable se pasa a través de un perfil pasacables de aluminio que lo mantiene oculto. Su color de serie es el plata, para otros acabados consultar al Departamento Comercial.

**3 CABLE WAY OUT SALIDA DE CABLEADO**

The cable exits directly the power system or through an aluminum frame so that it remains hidden until it reaches the floor.

La salida del cable se realiza directamente desde el propio sistema de conexiones o a través de un perfil de aluminio en la parte inferior de la base, de modo que el cable queda oculto hasta llegar al suelo.

**PS0710**

**PS0720**

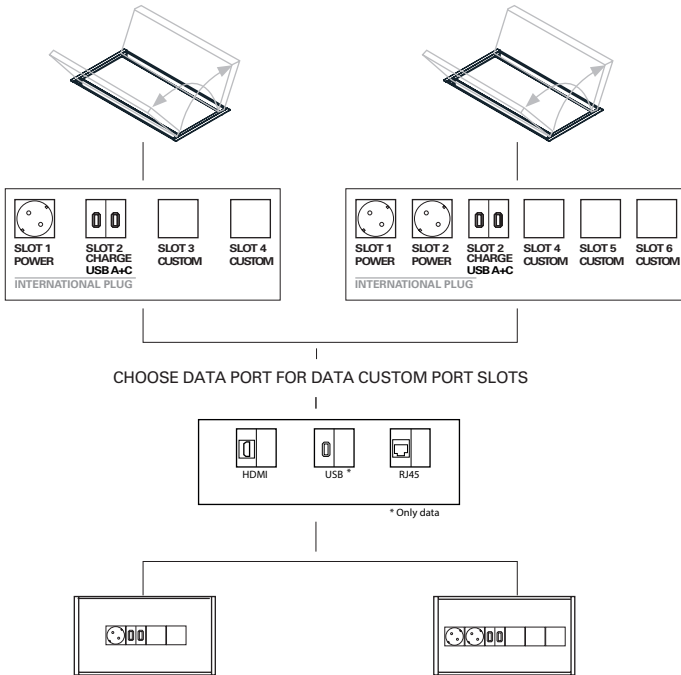

**OPTIONAL PREINSTALLED WIRING  
PREINSTALACIÓN DEL CABLEADO**

**IN0006**

Preinstalled wiring consists in the addition of the necessary mechanisms to integrate power systems in the table, so that wiring is hidden until the way out in the door. Necessary grommet are included and 3m cable (from the power system). For other cable dimensions contact the Customer Department.

La preinstalación consiste en el montaje de los mecanismos necesarios para integrar el sistema de electrificación en la mesa, de modo que el cableado quede oculto hasta su salida por la base. Se incluyen los pasacables necesarios y 3 metros de cable (midiendo desde el sistema de conexiones). Para otras longitudes de cable consultar al Departamento Comercial.

**IN-SURFACE POWER BOXES  
CAJAS DE CONEXIONES DENTRO DEL SOBRE**

It is a data dynamo with 2 amp dual charging USB. Available in two finishes: black or white.

Es una dínamo de datos con 2 amp de carga dual USB. Disponible en dos acabados: negro o blanco.

**PS0804**

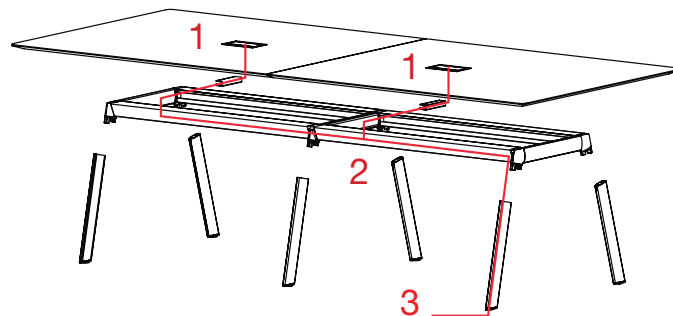
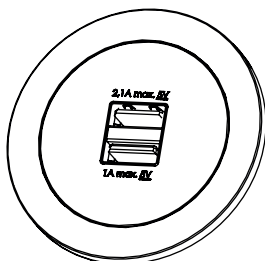

**1 POWER BOXES DISTRIBUTION DISTRIBUCIÓN DE SISTEMAS**

By standard, the position of the system will be in the central of the table, placed horizontally. When there are two system boxes, these will be separated 1/3 between them and placed horizontally. For other options, please contact the Customer Department.

De serie, la disposición del sistema será en el centro de la mesa y en sentido longitudinal. Cuando se disponga de dos sistemas, estos se colocarán con una separación de 1/3 de la longitud total de la mesa, y en sentido longitudinal. Otras opciones consultar con el Departamento Comercial.

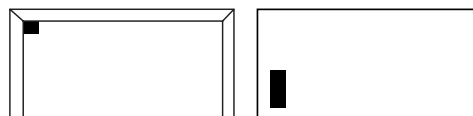

**2 WIRING MANAGEMENT GESTIÓN DEL CABLEADO**

Wire pass through an aluminum grommet keeping it hidden. By default color is silver, for other finishings ask the Customer Department.

El cable se pasa a través de un perfil pasacables de aluminio que lo mantiene oculto. Su color de serie es el plata, para otros acabados consultar al Departamento Comercial.

**3 CABLE WAY OUT SALIDA DE CABLEADO**

The cable exits directly the power system or through an aluminum frame so that it remains hidden until it reaches the floor.

La salida del cable se realiza directamente desde el propio sistema de conexiones o a través de un perfil de aluminio en la parte inferior de la base, de modo que el cable queda oculto hasta llegar al suelo.

**OPTIONAL PREINSTALLED WIRING  
PREINSTALACIÓN DEL CABLEADO**

**IN0006**

Preinstalled wiring consists in the addition of the necessary mechanisms to integrate power systems in the table, so that wiring is hidden until the way out in the door. Necessary grommet are included and 3m cable (from the power system). For other cable dimensions contact the Customer Department.

La preinstalación consiste en el montaje de los mecanismos necesarios para integrar el sistema de electrificación en la mesa, de modo que el cableado quede oculto hasta su salida por la base. Se incluyen los pasacables necesarios y 3 metros de cable (midiendo desde el sistema de conexiones). Para otras longitudes de cable consultar al Departamento Comercial.





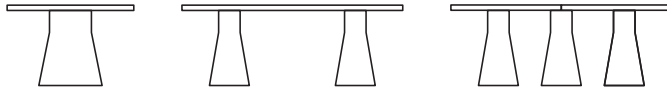

**Description**  
**Descripción**

Table program available with different types of bases and table tops. Pure Eco thermo-polymer (100% recycled) available in several colors and gloss lacquer option. Table tops in several shapes and sizes available in various finishes.

Programa de mesas disponible con diferentes tipos de bases y sobres de mesa. Bases de termopolimero Pure Eco (100% reciclado) disponible en diferentes colores y opción de laca brillo. Sobres de tablero de diferentes formas y medidas disponible en diferentes acabados.

**Wood finish Oak**  
**Acabado madera Roble**

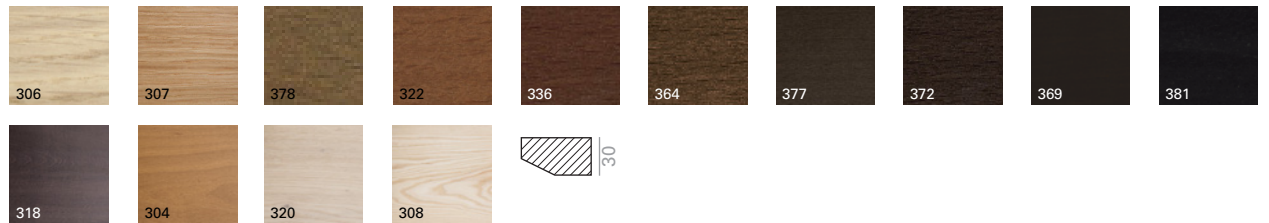

**Wood lacquer finish**  
**Acabado laca madera**



**Laminated**  
**Laminado**



**Laminated TP**  
**Laminado TP**

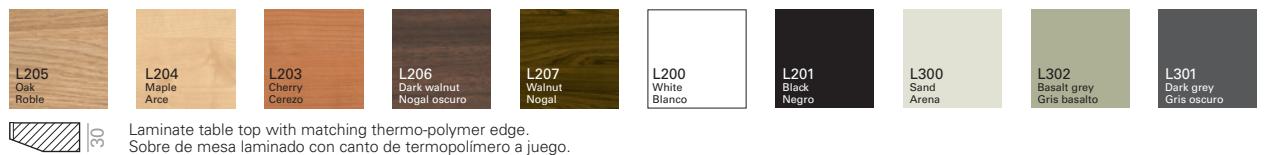

**Linoleum finish**  
**Acabado linóleo**

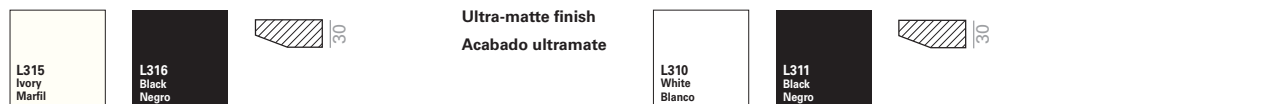

**Glass finish**  
**Acabado de cristal**

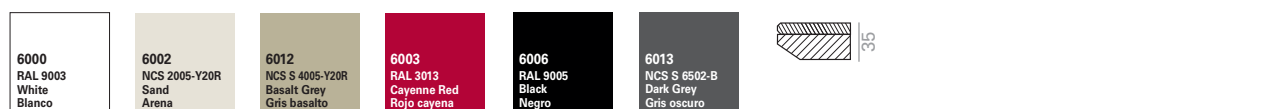

**Technical Stone 8 finish**  
**Acabado Technical Stone 8**



**M1 marble finish**  
**Acabado de mármol M1**



**M3 marble finish**  
**Acabado de mármol M3**

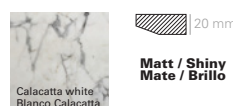

**Pure Eco Thermo-polymer finish**  
**Acabado de Termopolimero Pure Eco**

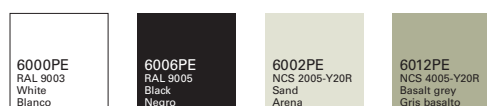

**Power box**  
**Caja de conexiones**



**Cement finish**  
**Acabado cemento**



**Certificates**  
**Certificados**

Quality - Resistance  
Calidad - Resistencia

UNE EN 15372

**Intellectual property Propiedad intelectual**

All our collections are protected by international industrial design registries, designs patents, copyrights and intellectual Property laws. Unauthorized use of AW International Property is a criminal offence and can lead to prosecution.  
Todas nuestras colecciones están protegidas por registros de diseño industrial, diseño de patente, copyright y derechos de propiedad intelectual todo el mundo. El uso no autorizado de los diseños y propiedad intelectual de AW supone un delito que puede ser sometido a acción judicial.



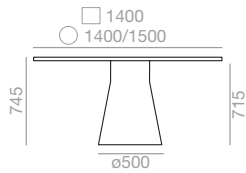

Access panel for wiring up charge.  
Incremento por panel de acceso para cableado.

| 330 |

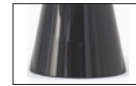

Incremento por base laca brillo

Upcharge for bright lacquered finish bases. | 323 |



Height adjustable glides up charge  
Incremento por tacos reguladores

| 57 |

Amount of sand: 50 kg.  
Cantidad de arena 50 kg.

Table height / Altura de mesa 745													
Top measures Medidas sobre	Table top / Sobre											Top & Base	
	Oak Roble		s600	Lacquered Lacado		Low Iron Glass Cristal óptico		***Marble M1 Mármol M1		***Marble M3 Mármol M3		Cement Cemento	
	Ref.	€	€	Ref.	€	Ref.	€	Ref.	€	Ref.	€	Ref.	€
<b>1400x1400</b>	<b>ME5237</b>	1.286	156	<b>ME5238</b>	1.321	<b>ME5249</b>	2.022	<b>ME5940</b>	3.480	<b>ME5942</b>	6.313	<b>ME5690</b>	2.190
kg	127			127		81		213		213		133	
<b>2 boxes/ bultos</b> m3	0,68			0,68		1,32		2,96		2'96		0'68	
<b>ø1400</b>	<b>ME5241</b>	1.294	156	<b>ME5242</b>	1.330	<b>ME5254</b>	2.142	<b>ME5943</b>	3.959	<b>ME5945</b>	6.792	<b>ME5695</b>	2.204
kg	118			118		65		186		186		122	
<b>2 boxes/ bultos</b> m3	0,68			0,68		1,32		2,96		2'96		0'68	
<b>ø1500</b>	<b>ME5243</b>	1.301	162	<b>ME5244</b>	1.377	<b>ME5255</b>	2.237	<b>ME5946</b>	4.154	<b>ME5948</b>	6.989	<b>ME5696</b>	2.318
kg	123			123		74		201		201		128	
<b>2 boxes/ bultos</b> m3	0,73			0,73		1,45		3,29		3'29		0'73	
<b>ellipse/ elipse 1400x1400</b>	<b>ME5245</b>	1.294	156	<b>ME5246</b>	1.328	<b>ME5261</b>	2.221	<b>ME5949</b>	3.959	<b>ME5951</b>	6.792	<b>ME5702</b>	2.204
kg	126			126		65		213		213		132	
<b>2 boxes/ bultos</b> m3	0,68			0,68		1,32		2,96		2'96		0'68	

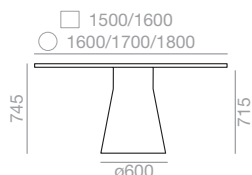

Height adjustable  
glides up charger  
Incremento por tacos  
reguladores

| 57 |



Incremento por base  
laca brillo

Upcharge for bright  
lacquered finish bases.

| 323 |

Amount of sand: 75 kg.  
Cantidad de arena 75 kg.

Table height / Altura de mesa 745													
Top measures Medidas sobre	Table top / Sobre											Top & Base	
	Oak Roble		s600	Lacquered Lacado		Low Iron Glass Cristal óptico		***Marble M1 Mármol M1		***Marble M3 Mármol M3		Cement Cemento	
	Ref.	€	€	Ref.	€	Ref.	€	Ref.	€	Ref.	€	Ref.	€
1500x1500	ME5239	1.291	162	ME5240	1.367	ME5250	2.247	ME5952	3.640	ME5954	6.474	ME5691	2.306
kg	134			134		92		281		281		140	
2 boxes/ bultos  m3	0,84			0,84		1,56		2,96		2'96		0'84	
1600x1600	ME5060	1.524	171	ME5075	1.536	ME5251	2.377					ME5692	2.493
kg	141			141		103						148	
2 boxes/ bultos  m3	0,9			0,9		1,7						0'9	
ø1600	ME5065	1.564	171	ME5080	1.529	ME5256	2.562					ME5697	2.493
kg	128			128		83						134	
2 boxes/ bultos  m3	0,9			0,9		1,7						0'9	
ø1700	ME5066	1.653	192	ME5081	1.582	ME5257	2.696					ME5698	2.631
kg	134			134		93						141	
2 boxes/ bultos  m3	0,96			0,96		1,85						0'96	
ø1800	ME5067	1.743	216	ME5082	1.658	ME5258	2.935					ME5699	2.778
kg	140			140		103						148	
2 boxes/ bultos  m3	1,02			1,02		2						1'02	
ellipse/ elipse 1500x1500	ME5247	1.301	162	ME5248	1.376	ME5262	2.407	ME5955	4.154	ME5957	6.989	ME5703	2.318
kg	133			133		74		281		281		139	
2 boxes/ bultos  m3	0,84			0,84		1,56		2,96		2'96		0'84	
ellipse/ elipse 1600x1600	ME5070	1.564	171	ME5085	1.529	ME5263	2.586					ME5704	2.493
kg	133			133		83						139	
2 boxes/ bultos  m3	0,57			0,9		1,7						0'9	

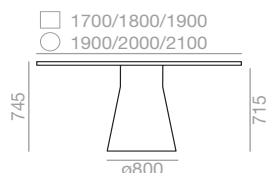

Height adjustable  
glides up charger  
Incremento por tacos  
reguladores

| 57 |



Incremento por base  
laca brillo  
Upcharge for bright  
lacquered finish bases.

| 323 |

Amount of sand: 75 kg.  
Cantidad de arena 75 kg.

Table height / Altura de mesa 745									
Top measures Medidas sobre	Table top / Sobre							Top & Base	
	Oak Roble		s600	Lacquered Lacado		Low Iron Glass Cristal óptico		Cement Cemento	
	Ref.	€	€	Ref.	€	Ref.	€	Ref.	€
<b>1700x1700</b>	<b>ME5400</b>	1.735	192	<b>ME5401</b>	1.735	<b>ME5402</b>	2.547	<b>ME5403</b>	3.116
kg	217			217		246		217	
<b>2 boxes/ bultos</b> m3	1,23			1,23		2,12		1'23	
<b>1800x1800</b>	<b>ME5404</b>	1.804	216	<b>ME5405</b>	1.785	<b>ME5406</b>	2.655	<b>ME5407</b>	3.252
kg	225			225		256		225	
<b>2 boxes/ bultos</b> m3	1,3			1,3		2,28		1'3	
<b>1900x1900</b>	<b>ME5408</b>	1.913	242	<b>ME5409</b>	1.834	<b>ME5410</b>	2.971	<b>ME5411</b>	3.393
kg	234			234		269		234	
<b>2 boxes/ bultos</b> m3	1,36			1,36		2,44		1'36	
<b>ø1900</b>	<b>ME5412</b>	2.316	269	<b>ME5413</b>	1.794	<b>ME5414</b>	3.025	<b>ME5415</b>	3.393
kg	216			216		243		216	
<b>2 boxes/ bultos</b> m3	1,36			1,36		2,44		1'36	
<b>ø2000</b>	<b>ME5416</b>	2.530	298	<b>ME5417</b>	1.869	<b>ME5418</b>	3.180	<b>ME5419</b>	3.637
kg	223			223		253		223	
<b>2 boxes/ bultos</b> m3	1,43			1,43		2,62		1'43	
<b>ø2100</b>	<b>ME5420</b>	2.629	192	<b>ME5421</b>	1.892	<b>ME5422</b>	3.359	<b>ME5423</b>	3.805
kg	231			231		263		231	
<b>2 boxes/ bultos</b> m3	1,5			1,5		2,62		1'5	
<b>ellipse/ elipse 1700x1700</b>	<b>ME5424</b>	1.774	216	<b>ME5425</b>	1.728	<b>ME5426</b>	2.720	<b>ME5427</b>	3.116
kg	217			217		246		217	
<b>2 boxes/ bultos</b> m3	1,23			1,23		2,12		1'23	
<b>ellipse/ elipse 1800x1800</b>	<b>ME5428</b>	1.844	242	<b>ME5429</b>	1.783	<b>ME5430</b>	2.932	<b>ME5431</b>	3.252
kg	225			225		256		225	
<b>2 boxes/ bultos</b> m3	0,74			1,3		2,28		1'3	
<b>ellipse/ elipse 1900x1900</b>	<b>ME5432</b>	2.316	269	<b>ME5433</b>	1.834	<b>ME5434</b>	3.025	<b>ME5435</b>	3.389
kg	234			234		269		234	
<b>2 boxes/ bultos</b> m3	1,36			1,36		2,44		1'36	

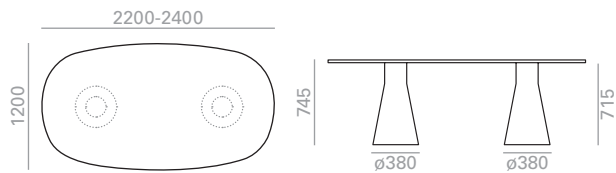

Height adjustable glides up charget  
Incremento por tacos reguladores

| 84 |

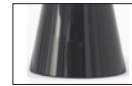

Incremento por base laca brillo  
Upcharge for bright lacquered finish bases.

| 544 |

Amount of sand: 50 kg. (2x25 kg.)  
Cantidad de arena 50 kg. (2x25 kg.)

Table height / Altura de mesa 745																
Top measures Medidas sobre	Table top / Sobre														Top & Base	
	Oak Roble		s600	Lacquered Lacado		Laminate Laminado		Laminate TP Laminado TP		Top Technical Stone 8		Low Iron Glass Cristal óptico		Cement Cemento		
	Ref.	€	€	Ref.	€	Ref.	€	Ref.	€	Ref.	€	Ref.	€	Ref.	€	
2200X1200	ME5010	1.928	177	ME5015	1.512	ME5158	2.271	ME5185	2.491	ME5223	3.493	ME5268	2.559	ME5709	2.840	
kg	126		126		126		126		126		89		128			
2 boxes/ bultos  m3	0,84		0,84		0,84		0,84		3'69		3'69		0'84			

2400X1200	ME5011	1.949	195	ME5016	1.536	ME5159	2.292	ME5186	2.530	ME5224	3.682	ME5269	2.635	ME5710	2.945
kg	131		131		131		131		131		96		133		
2 boxes/ bultos  m3	0,88		0,88		0,88		0,88		3'97		3'97		0'88		

Table height / Altura de mesa 745						
Top measures Medidas sobre	Table top / Sobre					
	Linoleum Linóleo		Ultra-matte Ultramate		Ultra-matte TP Ultramate TP	
	Ref.	€	Ref.	€	Ref.	€
2200X1200	ME5790	2.456	ME5804	2.656	ME5818	2.725
kg	127		127		127	
2 boxes/ bultos  m3	0,84		0,84		0,84	

2400X1200	ME5791	2.477	ME5805	2.671	ME5819	2.762
kg	132		132		132	
2 boxes/ bultos  m3	0,88		0,88		0,88	

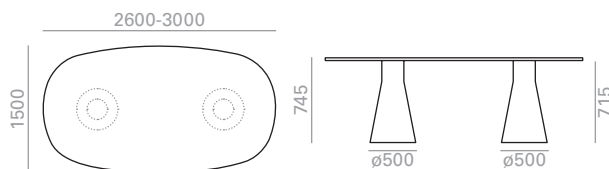

Incremento por base laca brillo  
Upcharge for bright lacquered finish bases. | 646 |



Height adjustable glides up charget  
Incremento por tacos reguladores | 114 |



Acces panel for wiring up charge.  
Incremento por panel de acceso para cableado. | 330 |

Table height / Altura de mesa 745															
Top measures Medidas sobre	Table top / Sobre													Top & Base	
	Oak Roble		s600	Lacquered Lacado		Laminate Laminado		Laminate TP Laminado TP		*Top Technical Stone 8		Low Iron Glass Cristal óptico		Cement Cemento	
	Ref.	€	€	Ref.	€	Ref.	€	Ref.	€	Ref.	€	Ref.	€	Ref.	€
<b>2600X1500</b>	<b>ME5012</b>	2.938	264	<b>ME5017</b>	2.236	<b>ME5160</b>	3.444	<b>ME5187</b>	3.675	<b>ME5225</b>	4.683	<b>ME5270</b>	3.450	<b>ME5711</b>	3.819
<b>kg</b>	151		151		151		151		151		126		155		
<b>2 boxes/ bultos</b> <b>m3</b>	1,32		1,32		1,32		1,32		5'34		5'34		1'32		

<b>2800X1500</b>	<b>ME5013</b>	2.976	285	<b>ME5018</b>	2.295	<b>ME5161</b>	3.466	<b>ME5188</b>	3.709	<b>ME5226</b>	4.862	<b>ME5271</b>	3.566	<b>ME5712</b>	3.853
<b>kg</b>	157		157		157		157		157		135		161		
<b>2 boxes/ bultos</b> <b>m3</b>	1,37		1,37		1,37		1,37		5'68		5'68		1'37		

<b>3000X1500</b>	<b>ME5014</b>	3.028	306	<b>ME5019</b>	2.367	<b>ME5162</b>	3.496	<b>ME5189</b>	3.752	<b>ME5227</b>	5.169	<b>ME5272</b>	3.686	<b>ME5713</b>	4.079
<b>kg</b>	162		162		162		162		162		144		168		
<b>2 boxes/ bultos</b> <b>m3</b>	1,43		1,43		1,43		1,43		6'02		6'02		1'43		

Amount of sand: 100 kg. (2x50 kg.)  
Cantidad de arena 100 kg. (2x50 kg.)

Table height / Altura de mesa 745											
Top measures Medidas sobre	Table top / Sobre										
	Linoleum Linóleo		Ultra-matte Ultramate		Ultra-matte TP Ultramate TP		***Marble M1 Mármol M1		***Marble M3 Mármol M3		
	Ref.	€	Ref.	€	Ref.	€	Ref.	€	Ref.	€	
<b>2600X1500</b>	<b>ME5792</b>	3.675	<b>ME5806</b>	3.971	<b>ME5820</b>	4.020	<b>ME5964</b>	4.492	<b>ME5966</b>	9.220	
<b>kg</b>	167		167		167		405		405		
<b>2 boxes/ bultos</b> <b>m3</b>	1,32		1,32		1,32		4,64		4'64		
<b>2800X1500</b>	<b>ME5793</b>	3.697	<b>ME5807</b>	3.990	<b>ME5821</b>	4.047	<b>ME5967</b>	4.956	<b>ME5969</b>	10.510	
<b>kg</b>	175		175		175		423		423		
<b>2 boxes/ bultos</b> <b>m3</b>	1,37		1,37		1,37		4,87		4'87		
<b>3000X1500</b>	<b>ME5794</b>	3.726	<b>ME5808</b>	4.023	<b>ME5822</b>	4.092	<b>ME5970</b>	5.933	<b>ME5972</b>	13.733	
<b>kg</b>	184		184		184		467		467		
<b>2 boxes/ bultos</b> <b>m3</b>	1,43		1,43		1,43		6,11		6'11		

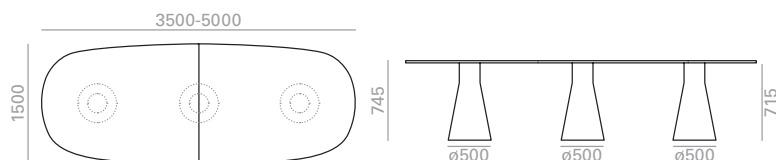





- 

 Incremento por base laca brillo  
 Upcharge for bright lacquered finish bases. | 969 |
- 





 Height adjustable glides up charget  
 Incremento por tacos reguladores | 171 |
- 

 Acces panel for wiring up charge.  
 Incremento por panel de acceso para cableado. | 330 |

Table height / Altura de mesa 745															
Top measures Medidas sobre	Table top / Sobre												Top & Base		
	Oak Roble		s600	Lacquered Lacado		Laminate Laminado		Laminate TP Laminado TP		*Top Technical Stone 8		Low Iron Glass Cristal óptico		Cement Cemento	
	Ref.	€	€	Ref.	€	Ref.	€	Ref.	€	Ref.	€	Ref.	€	Ref.	€
<b>3500x1500</b>	<b>ME5020</b>	4.649	357	<b>ME5029</b>	3.164	<b>ME5163</b>	6.097	<b>ME5190</b>	6.416	<b>ME5228</b>	7.441	<b>ME5273</b>	4.887	<b>ME5714</b>	5.075
<b>kg</b>	345		345		345		345		345		174		363		
<b>3 boxes/ bultos</b>  <b>m3</b>	2,18		2,18		2,18		2,18		7'41		3'45		2'18		
<b>4000x1500</b>	<b>ME5021</b>	4.752	408	<b>ME5030</b>	3.319	<b>ME5164</b>	6.119	<b>ME5191</b>	6.489	<b>ME5229</b>	7.966	<b>ME5274</b>	5.102	<b>ME5715</b>	5.528
<b>kg</b>	360		360		360		360		360		196		379		
<b>3 boxes/ bultos</b>  <b>m3</b>	2,31		2,31		2,31		2,31		8'65		3'41		2'31		
<b>4500x1500</b>	<b>ME5022</b>	4.949	459	<b>ME5031</b>	3.565	<b>ME5165</b>	6.200	<b>ME5192</b>	6.597	<b>ME5230</b>	8.555	<b>ME5275</b>	5.403	<b>ME5716</b>	5.848
<b>kg</b>	374		374		371		371		371		218		395		
<b>3 boxes/ bultos</b>  <b>m3</b>	2,45		2,45		2,45		2,45		9'01		3'67		2'45		
<b>5000x1500</b>	<b>ME5023</b>	5.083	510	<b>ME5032</b>	3.751	<b>ME5166</b>	6.243	<b>ME5193</b>	6.702	<b>ME5231</b>	9.126	<b>ME5276</b>	5.694	<b>ME5717</b>	6.394
<b>kg</b>	389		389		389		389		389		240		412		
<b>3 boxes/ bultos</b>  <b>m3</b>	2,58		2,58		2,58		2,58		10'35		10'35		2'58		

Amount of sand: 150 kg. (3x15 kg.) Cantidad de arena 150 kg. (3x15 kg.)

\*Maximum width 1440 mm Ancho máximo 1440 mm

Table height / Altura de mesa 745										
Top measures Medidas sobre	Table top / Sobre									
	Linoleum Linóleo		Ultra-matte Ultramate		Ultra-matte TP Ultramate TP		***Marble M1 Mármol M1		***Marble M3 Mármol M3	
	Ref.	€	Ref.	€	Ref.	€	Ref.	€	Ref.	€
<b>3500x1500</b>	<b>ME5795</b>	6.596	<b>ME5809</b>	7.191	<b>ME5823</b>	7.134	<b>ME5973</b>	6.993	<b>ME5975</b>	16.180
<b>kg</b>	348		348		348		564		564	
<b>3 boxes/ bultos</b>  <b>m3</b>	2,18		2,18		2,18		7,26		7'26	
<b>4000x1500</b>	<b>ME5796</b>	6.630	<b>ME5810</b>	7.220	<b>ME5824</b>	7.208	<b>ME5976</b>	7.886	<b>ME5978</b>	18.458
<b>kg</b>	364		364		364		611		611	
<b>3 boxes/ bultos</b>  <b>m3</b>	2,31		2,31		2,31		8,32		8'32	
<b>4500x1500</b>	<b>ME5797</b>	6.699	<b>ME5811</b>	7.288	<b>ME5825</b>	7.312	<b>ME5979</b>	8.376	<b>ME5981</b>	20.334
<b>kg</b>	381		381		381		658		658	
<b>3 boxes/ bultos</b>  <b>m3</b>	2,45		2,45		2,45		9,19		9'19	
<b>5000x1500</b>	<b>ME5798</b>	6.751	<b>ME5812</b>	7.346	<b>ME5826</b>	7.415	<b>ME5982</b>	8.893	<b>ME5984</b>	22.239
<b>kg</b>	398		398		398		735		735	
<b>3 boxes/ bultos</b>  <b>m3</b>	2,58		2,58		2,58		9,98		9'98	

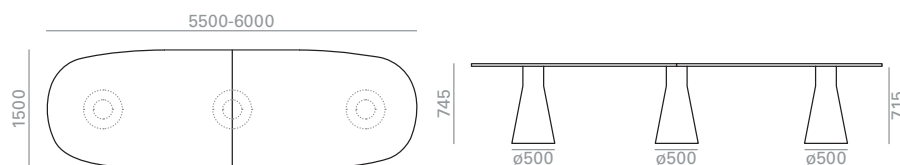

Incremento por base laca brillo  
Upcharge for bright lacquered finish bases. | 969 |



Acces panel for wiring up charge.  
Incremento por panel de acceso para cableado. | 330 |



Height adjustable glides up charget  
Incremento por tacos reguladores | 171 |

Amount of sand: 150 kg. (3x15 kg.)  
Cantidad de arena 150 kg. (3x15 kg.)

Table height / Altura de mesa 745																
Top measures Medidas sobre	Table top / Sobre														Top & Base	
	Oak Roble		s600	Lacquered Lacado		Laminate Laminado		LaminateTP LaminadoTP		*Top Technical Stone 8		Low Iron Glass Cristal óptico		Cement Cemento		
	Ref.	€	€	Ref.	€	Ref.	€	Ref.	€	Ref.	€	Ref.	€	Ref.	€	
<b>5500x1500</b>	<b>ME5024</b>	6.319	561	<b>ME5033</b>	4.073	<b>ME5167</b>	6.339	<b>ME5194</b>	6.833	<b>ME5232</b>	9.873	<b>ME5277</b>	6.124	<b>ME5718</b>	6.609	
<b>kg</b>	407		407		408		408		439		266		428			
<b>3 boxes/ bultos</b> <b>m3</b>	2,72		2,72		2,72		2,72		11'2		11'2		2'72			

<b>6000x1500</b>	<b>ME5025</b>	6.446	612	<b>ME5034</b>	4.300	<b>ME5168</b>	8.451	<b>ME5195</b>	8.949	<b>ME5233</b>	10.227	<b>ME5278</b>	6.641	<b>ME5719</b>	6.950
<b>kg</b>	422		422		422		422		422		287		444		
<b>3 boxes/ bultos</b> <b>m3</b>	2,86		2,86		2,86		2,86		12'05		12'05		2'86		

\*Maximum width 1440 mm Ancho máximo 1440 mm

Table height / Altura de mesa 745										
Top measures Medidas sobre	Table top / Sobre									
	Linoleum Linóleo		Ultra-matte Ultramate		Ultra-matteTP UltramateTP		***Marble M1 Mármol M1		***Marble M3 Mármol M3	
	Ref.	€	Ref.	€	Ref.	€	Ref.	€	Ref.	€
<b>5500x1500</b>	<b>ME5799</b>	6.830	<b>ME5813</b>	9.275	<b>ME5827</b>	9.193	<b>ME5985</b>	9.543	<b>ME5987</b>	24.347
<b>kg</b>	415		415		415		782		782	
<b>3 boxes/ bultos</b> <b>m3</b>	2,72		2,72		2,72		10,97		10'97	

<b>6000x1500</b>	<b>ME5800</b>	9.242	<b>ME5814</b>	10.125	<b>ME5828</b>	10.058	<b>ME5988</b>	9.815	<b>ME5990</b>	26.526
<b>kg</b>	431		431		431		879		879	
<b>3 boxes/ bultos</b> <b>m3</b>	2,86		2,86		2,86		11,78		11'78	



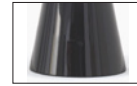
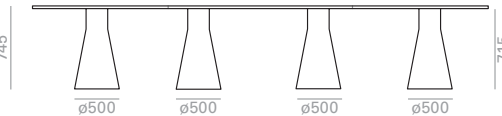
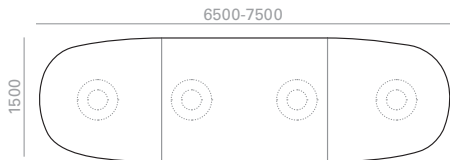

Incremento por base laca brillo  
Upcharge for bright lacquered finish bases. | 1.292 |



Height adjustable glides up charget  
Incremento por tacos reguladores | 228 |

Amount of sand: 200 kg. (4x50 kg.)  
Cantidad de arena 200 kg. (4x50 kg.)

Table height / Altura de mesa 745																
Top measures Medidas sobre	Table top / Sobre														Top & Base	
	Oak Roble		s600	Lacquered Lacado		Laminate Laminado		LaminateTP Laminado TP		*Top Technical Stone 8		Low Iron Glass Cristal óptico		Cement Cemento		
	Ref.	€	€	Ref.	€	Ref.	€	Ref.	€	Ref.	€	Ref.	€	Ref.	€	
<b>6500x1500</b>	<b>ME5026</b>	7.099	663	<b>ME5035</b>	5.000	<b>ME5169</b>	9.024	<b>ME5196</b>	9.542	<b>ME5234</b>	12.230	<b>ME5279</b>	7.472	<b>ME5720</b>	8.049	
<b>kg</b>	515		515		515		515		515		313		543			
<b>4 boxes/ bultos</b>	3,01		3,01		3,01		3,01		13'21		13'21		3'01			

<b>7000x1500</b>	<b>ME5027</b>	7.231	714	<b>ME5036</b>	5.183	<b>ME5170</b>	9.099	<b>ME5197</b>	9.629	<b>ME5235</b>	12.770	<b>ME5280</b>	7.732	<b>ME5721</b>	8.372
<b>kg</b>	529		529		529		529		529		335		560		
<b>4 boxes/ bultos</b>	3,15		3,15		3,15		3,15		14'07		14'07		3'15		

<b>7500x1500</b>	<b>ME5028</b>	7.360	765	<b>ME5037</b>	5.363	<b>ME5171</b>	9.151	<b>ME5198</b>	9.747	<b>ME5236</b>	13.337	<b>ME5281</b>	8.107	<b>ME5722</b>	8.688
<b>kg</b>	544		544		544		544		544		357		576		
<b>4 boxes/ bultos</b>	3,29		3,29		3,29		3,29		14'94		14'94		3'29		

\*Maximum width 1440 mm Ancho máximo 1440 mm

Table height / Altura de mesa 745										
Top measures Medidas sobre	Table top / Sobre									
	Linoleum Linóleo		Ultra-matte Ultramate		Ultra-matteTP UltramateTP		***Marble M1 Mármol M1		***Marble M3 Mármol M3	
	Ref.	€	Ref.	€	Ref.	€	Ref.	€	Ref.	€
<b>6500x1500</b>	<b>ME5801</b>	9.786	<b>ME5815</b>	10.674	<b>ME5829</b>	10.628	<b>ME5991</b>	11.569	<b>ME5993</b>	29.069
<b>kg</b>	525		525		525		936		936	
<b>4 boxes/ bultos</b>	3,01		3,01		3,01		13,69		13'69	

<b>7000x1500</b>	<b>ME5802</b>	9.854	<b>ME5816</b>	10.740	<b>ME5830</b>	10.714	<b>ME5994</b>	12.074	<b>ME5996</b>	30.991
<b>kg</b>	542		542		542		983		983	
<b>4 boxes/ bultos</b>	3,15		3,15		3,15		14,05		14'05	

<b>7500x1500</b>	<b>ME5803</b>	9.904	<b>ME5817</b>	10.788	<b>ME5831</b>	10.824	<b>ME5997</b>	12.590	<b>ME5999</b>	32.863
<b>kg</b>	558		558		558		1075		1075	
<b>4 boxes/ bultos</b>	3,29		3,29		3,29		14,94		14'94	

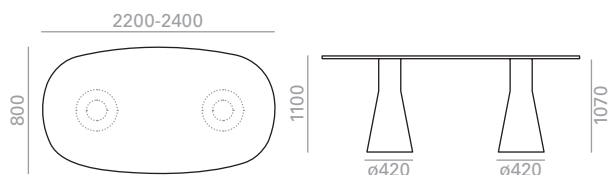

Incremento por base laca brillo  
Upcharge for bright lacquered finish bases. | 716 |



Height adjustable glides up charger  
Incremento por tacos reguladores | 84 |

Amount of sand: 50 kg. (2x25 kg.)  
Cantidad de arena 50 kg. (2x25 kg.)

Table height / Altura de mesa 1100																
Top measures Medidas sobre	Table top / Sobre														Top & Base	
	Oak Roble		s600	Lacquered Lacado		Laminate Laminado		Laminate TP Laminado TP		Top Technical Stone 8		Low Iron Glass Cristal óptico		Cement Cemento		
	Ref.	€	€	Ref.	€	Ref.	€	Ref.	€	Ref.	€	Ref.	€	Ref.	€	
2200x800	ME9750	1.923	143	ME9752	1.549	ME9754	2.338	ME9756	2.521	ME9758	3.437	ME9760	2.430	ME9762	2.964	
kg	102		102		102		102		102		118		102			
2 boxes/ bultos m3	0,81		0,81		0,81		0,81		2'86		1'18		0'81			
2400x800	ME9751	1.947	165	ME9753	1.572	ME9755	2.358	ME9757	2.556	ME9759	3.582	ME9761	2.498	ME9763	3.067	
kg	105		105		105		105		105		124		105			
2 boxes/ bultos m3	0,84		0,84		0,84		0,84		2'86		1'24		0'84			

Table height / Altura de mesa 1100						
Top measures Medidas sobre	Table top / Sobre					
	Linoleum Linóleo		Ultra-matte Ultramate		Ultra-matte TP Ultramate TP	
	Ref.	€	Ref.	€	Ref.	€
2200x800	ME9764	2.604	ME9766	2.801	ME9768	2.871
kg	102		102		102	
2 boxes/ bultos m3	0,81		0,81		0,81	
2400x800	ME9765	2.624	ME9767	2.821	ME9769	2.910
kg	105		105		105	
2 boxes/ bultos m3	0,84		0,84		0,84	

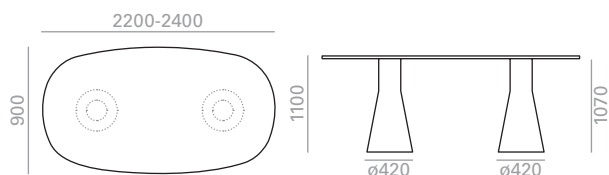

Incremento por base  
laca brillo  
Upcharge for bright  
lacquered finish bases. | 716 |



Height adjustable  
glides up charget  
Incremento por tacos  
reguladores | 84 |

Amount of sand: 50 kg. (2x25 kg.)  
Cantidad de arena 50 kg. (2x25 kg.)

Table height / Altura de mesa 1100															
Top measures Medidas sobre	Table top / Sobre													Top & Base	
	Oak Roble		s600	Lacquered Lacado		Laminate Laminado		Laminate TP Laminado TP		Top Technical Stone 8		Low Iron Glass Cristal óptico		Cement Cemento	
	Ref.	€	€	Ref.	€	Ref.	€	Ref.	€	Ref.	€	Ref.	€	Ref.	€
<b>2200x900</b>	<b>ME9770</b>	1.927	153	<b>ME9772</b>	1.557	<b>ME9774</b>	2.347	<b>ME9776</b>	2.524	<b>ME9778</b>	3.465	<b>ME9780</b>	2.510	<b>ME9782</b>	2.970
kg	107		107		107		107		107		126		107		
<b>2 boxes/ bultos</b> m3	1,52		1,52		1,52		1,52		4'12		3'62		1'52		
<b>2400x900</b>	<b>ME9771</b>	1.950	175	<b>ME9773</b>	1.580	<b>ME9775</b>	2.363	<b>ME9777</b>	2.563	<b>ME9779</b>	3.609	<b>ME9781</b>	2.529	<b>ME9783</b>	3.075
kg	111		111		111		111		111		132		111		
<b>2 boxes/ bultos</b> m3	1,56		1,56		1,56		1,56		4'36		3'82		1'56		

Table height / Altura de mesa 1100						
Top measures Medidas sobre	Table top / Sobre					
	Linoleum Linóleo		Ultra-matte Ultramate		Ultra-matte TP Ultramate TP	
	Ref.	€	Ref.	€	Ref.	€
<b>2200x900</b>	<b>ME9784</b>	2.611	<b>ME9786</b>	2.809	<b>ME9788</b>	2.874
kg	107		107		107	
<b>2 boxes/ bultos</b> m3	1,52		1,52		1,52	
<b>2400x900</b>	<b>ME9785</b>	2.628	<b>ME9787</b>	2.825	<b>ME9789</b>	2.913
kg	111		111		111	
<b>2 boxes/ bultos</b> m3	1,56		1,56		1,56	

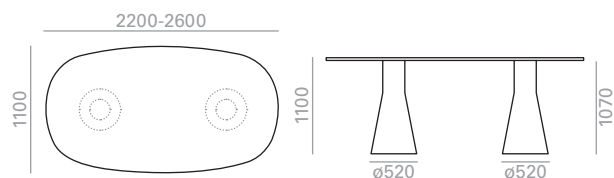

Amount of sand: 100 kg. (2x50 kg.)  
Cantidad de arena 100 kg. (2x50 kg.)

Table height / Altura de mesa 1100															
Top measures Medidas sobre	Table top / Sobre												Top & Base		
	Oak Roble		s600	Lacquered Lacado		Laminate Laminado		LaminateTP LaminadoTP		Top Technical Stone 8		Low Iron Glass Cristal óptico		Cement Cemento	
	Ref.	€	€	Ref.	€	Ref.	€	Ref.	€	Ref.	€	Ref.	€	Ref.	€
2200X1100	ME9790	2.077	173	ME9793	1.708	ME9796	2.492	ME9799	2.675	ME9802	3.688	ME9805	2.805	ME9808	3.318
kg	127		127		127		127		127		127		127		
2 boxes/ bultos  m3	1,34		1,34		1,34		1,34		3'98		1'77		1'34		
2400X1100	ME9791	2.101	195	ME9794	1.729	ME9797	2.513	ME9800	2.709	ME9803	3.833	ME9806	2.881	ME9809	3.422
kg	132		132		132		132		132		157		132		
2 boxes/ bultos  m3	1,38		1,38		1,38		1,38		4'21		1'85		1'38		
2600X1100	ME9792	2.839	205	ME9795	2.115	ME9798	3.415	ME9801	3.585	ME9804	4.293	ME9807	3.063	ME9810	3.855
kg	137		137		137		137		137		165		137		
2 boxes/ bultos  m3	1,42		1,42		1,42		1,42		4'47		4'51		1'42		

Table height / Altura de mesa 1100						
Top measures Medidas sobre	Table top / Sobre					
	Linoleum Linóleo		Ultra-matte Ultramate		Ultra-matteTP UltramateTP	
	Ref.	€	Ref.	€	Ref.	€
2200X1100	ME9811	2.759	ME9814	2.955	ME9817	3.025
kg	127		127		127	
2 boxes/ bultos  m3	1,34		1,34		1,34	
2400X1100	ME9812	2.779	ME9815	2.977	ME9818	3.063
kg	132		132		132	
2 boxes/ bultos  m3	1,38		1,38		1,38	
2600X1100	ME9813	3.770	ME9816	4.061	ME9819	4.113
kg	137		137		137	
2 boxes/ bultos  m3	1,42		1,42		1,42	

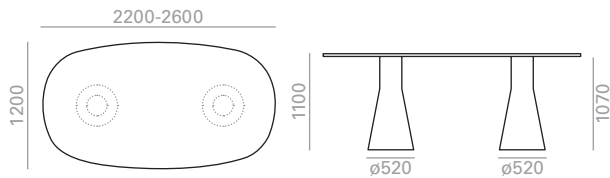

Incremento por base  
laca brillo  
Upcharge for bright  
lacquered finish bases.

774



Height adjustable  
glides up charget  
Incremento por tacos  
reguladores

114

Amount of sand: 100 kg. (2x50 kg.)  
Cantidad de arena 100 kg. (2x50 kg.)

Table height / Altura de mesa 1100															
Top measures Medidas sobre	Table top / Sobre												Top & Base		
	Oak Roble		s600	Lacquered Lacado		Laminate Laminado		LaminateTP LaminadoTP		Top Technical Stone 8		Low Iron Glass Cristal óptico		Cement Cemento	
	Ref.	€	€	Ref.	€	Ref.	€	Ref.	€	Ref.	€	Ref.	€	Ref.	€
2200X1200	ME9820	2.080	183	ME9823	1.719	ME9826	2.497	ME9829	2.678	ME9832	3.717	ME9835	2.648	ME9838	3.329
kg	132			132		132		132		132		132		132	
2 boxes/ bultos  m3	1,38			1,38		1,38		1,38		4'22		1'87		1'38	
2400X1200	ME9821	2.105	205	ME9824	1.743	ME9827	2.516	ME9830	2.713	ME9833	3.971	ME9836	2.965	ME9839	3.435
kg	138			138		138		138		138		165		138	
2 boxes/ bultos  m3	1,42			1,42		1,42		1,42		4'5		1'96		1'42	
2600X1200	ME9822	2.843	215	ME9825	2.127	ME9828	3.419	ME9831	3.588	ME9834	4.320	ME9837	3.087	ME9840	3.920
kg	144			144		144		144		144		173		144	
2 boxes/ bultos  m3	1,47			1,47		1,47		1,47		4'78		2'04		1'47	

Table height / Altura de mesa 1100						
Top measures Medidas sobre	Table top / Sobre					
	Linoleum Linóleo		Ultra-matte Ultramate		Ultra-matteTP UltramateTP	
	Ref.	€	Ref.	€	Ref.	€
2200X1200	ME9841	2.763	ME9844	2.959	ME9847	3.028
kg	132		132		132	
2 boxes/ bultos  m3	1,38		1,38		1,38	
2400X1200	ME9842	2.784	ME9845	2.980	ME9848	3.067
kg	138		138		138	
2 boxes/ bultos  m3	1,42		1,42		1,42	
2600X1200	ME9843	3.778	ME9846	4.070	ME9849	4.116
kg	144		144		144	
2 boxes/ bultos  m3	1,47		1,47		1,47	

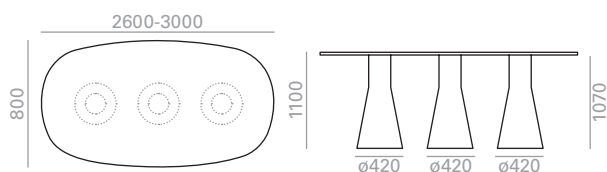

Incremento por base laca brillo  
Upcharge for bright lacquered finish bases. | 1.074 |



Height adjustable glides up charget  
Incremento por tacos reguladores | 126 |

Amount of sand: 75 kg. (3x25 kg.)  
Cantidad de arena 75 kg. (3x25 kg.)

Table height / Altura de mesa 1100															
Top measures Medidas sobre	Table top / Sobre													Top & Base	
	Oak Roble		s600	Lacquered Lacado		Laminate Laminado		Laminate TP Laminado TP		Top Technical Stone 8		Low Iron Glass Cristal óptico		Cement Cemento	
	Ref.	€	€	Ref.	€	Ref.	€	Ref.	€	Ref.	€	Ref.	€	Ref.	€
2600x800	ME9850	2.967	175	ME9853	2.246	ME9856	3.552	ME9859	3.722	ME9862	4.270	ME9865	3.161	ME9868	4.632
kg	109		109		109		109		109		109		109		
2 boxes/ bultos m3	1,56		1,56		1,56		1,56		3'94		3'94		1'56		
2800x800	ME9851	2.990	185	ME9854	2.276	ME9857	3.573	ME9860	3.749	ME9863	4.381	ME9866	3.259	ME9869	4.663
kg	113		113		113		113		113		134		113		
2 boxes/ bultos m3	1,59		1,59		1,59		1,59		4'14		4'14		1'59		
3000x800	ME9852	3.015	195	ME9855	2.319	ME9858	3.603	ME9861	3.792	ME9864	4.282	ME9867	3.209	ME9870	4.891
kg	117		117		117		117		117		139		117		
2 boxes/ bultos m3	1,62		1,62		1,62		1,62		4'34		4'34		1'62		

Table height / Altura de mesa 1100						
Top measures Medidas sobre	Table top / Sobre					
	Linoleum Linóleo		Ultra-matte Ultramate		Ultra-matte TP Ultramate TP	
	Ref.	€	Ref.	€	Ref.	€
2600x800	ME9871	3.900	ME9874	4.193	ME9877	4.238
kg	109		109		109	
2 boxes/ bultos m3	1,56		1,56		1,56	
2800x800	ME9872	3.920	ME9875	4.212	ME9878	4.270
kg	113		113		113	
2 boxes/ bultos m3	1,59		1,59		1,59	
3000x800	ME9873	3.947	ME9876	4.238	ME9879	4.311
kg	117		117		117	
2 boxes/ bultos m3	1,62		1,62		1,62	

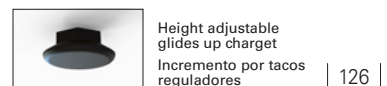
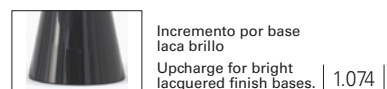
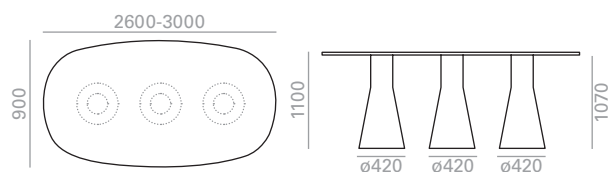

Amount of sand: 75 kg. (3x25 kg.)  
Cantidad de arena 75 kg. (3x25 kg.)

Table height / Altura de mesa 1100															
Top measures Medidas sobre	Table top / Sobre													Top & Base	
	Oak Roble		s600	Lacquered Lacado		Laminate Laminado		Laminate TP Laminado TP		Top Technical Stone 8		Low Iron Glass Cristal óptico		Cement Cemento	
	Ref.	€	€	Ref.	€	Ref.	€	Ref.	€	Ref.	€	Ref.	€	Ref.	€
<b>2600x900</b>	<b>ME9880</b>	2.977	185	<b>ME9883</b>	2.255	<b>ME9886</b>	3.555	<b>ME9889</b>	3.725	<b>ME9892</b>	4.293	<b>ME9895</b>	3.184	<b>ME9898</b>	4.698
<b>kg</b>	115		115		115		115		115		115		115		
<b>2 boxes/ bultos</b> <b>m3</b>	1,61		1,61		1,61		1,61		4'22		4'22		1'61		
<b>2800x900</b>	<b>ME9881</b>	2.999	195	<b>ME9884</b>	2.300	<b>ME9887</b>	3.581	<b>ME9890</b>	3.757	<b>ME9893</b>	4.154	<b>ME9896</b>	3.282	<b>ME9899</b>	4.731
<b>kg</b>	119		119		119		119		119		143		119		
<b>2 boxes/ bultos</b> <b>m3</b>	1,64		1,64		1,64		1,64		4'44		4'44		1'64		
<b>3000x900</b>	<b>ME9882</b>	3.021	205	<b>ME9885</b>	2.344	<b>ME9888</b>	3.606	<b>ME9891</b>	3.800	<b>ME9894</b>	4.419	<b>ME9897</b>	3.269	<b>ME9900</b>	4.958
<b>kg</b>	124		124		124		124		124		149		124		
<b>2 boxes/ bultos</b> <b>m3</b>	1,33		1,33		1,33		1,33		4'66		4'66		1'33		

Table height / Altura de mesa 1100						
Top measures Medidas sobre	Table top / Sobre					
	Linoleum Linóleo		Ultra-matte Ultramate		Ultra-matte TP Ultramate TP	
	Ref.	€	Ref.	€	Ref.	€
<b>2600x900</b>	<b>ME9901</b>	3.903	<b>ME9904</b>	4.198	<b>ME9907</b>	4.242
<b>kg</b>	115		115		115	
<b>2 boxes/ bultos</b> <b>m3</b>	1,26		1,26		1,26	
<b>2800x900</b>	<b>ME9902</b>	3.924	<b>ME9905</b>	4.221	<b>ME9908</b>	4.274
<b>kg</b>	119		119		119	
<b>2 boxes/ bultos</b> <b>m3</b>	1,29		1,29		1,29	
<b>3000x900</b>	<b>ME9903</b>	3.953	<b>ME9906</b>	4.246	<b>ME9909</b>	4.319
<b>kg</b>	124		124		124	
<b>2 boxes/ bultos</b> <b>m3</b>	1,33		1,33		1,33	

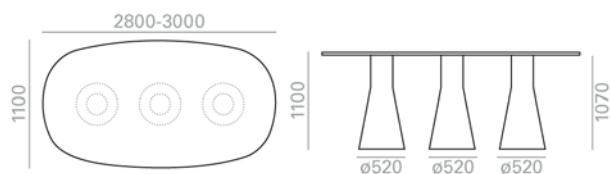

Incremento por base laca brillo  
Upcharge for bright lacquered finish bases. | 1.161 |



Height adjustable glides up charger  
Incremento por tacos reguladores | 171 |

Amount of sand: 150 kg. (3x15 kg.)  
Cantidad de arena 150 kg. (3x15 kg.)

Table height / Altura de mesa 1100															
Top measures Medidas sobre	Table top / Sobre													Top & Base	
	Oak Roble		s600	Lacquered Lacado		Laminate Laminado		LaminateTP LaminadoTP		Top Technical Stone 8		Low Iron Glass Cristal óptico		Cement Cemento	
	Ref.	€	€	Ref.	€	Ref.	€	Ref.	€	Ref.	€	Ref.	€	Ref.	€
2800X1100	ME9910	3.161	215	ME9912	2.424	ME9914	3.742	ME9916	3.924	ME9918	4.636	ME9920	3.688	ME9922	5.001
kg	143		143		143		143		143		172		143		
2 boxes/ bultos  m3	2,21		2,21		2,21		2,21		5'51		5'51		2'21		
3000X1100	ME9911	3.247	225	ME9913	2.618	ME9915	3.834	ME9917	4.028	ME9919	4.911	ME9921	3.673	ME9923	5.336
kg	148		148		148		148		148		179		148		
2 boxes/ bultos  m3	2,25		2,25		2,25		2,25		5'64		5'64		2'25		

Table height / Altura de mesa 1100						
Top measures Medidas sobre	Table top / Sobre					
	Linoleum Linóleo		Ultra-matte Ultramate		Ultra-matteTP UltramateTP	
	Ref.	€	Ref.	€	Ref.	€
2800X1100	ME9924	4.090	ME9926	4.443	ME9928	4.452
kg	143		143		143	
2 boxes/ bultos  m3	2,21		2,21		2,21	
3000X1100	ME9925	4.181	ME9927	4.474	ME9929	4.543
kg	148		148		148	
2 boxes/ bultos  m3	2,25		2,25		2,25	



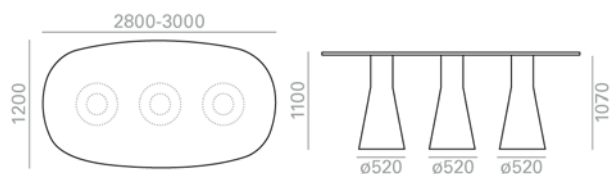

Amount of sand: 150 kg. (3x15 kg.)  
 Cantidad de arena 150 kg. (3x15 kg.)

Table height / Altura de mesa 1100																
Top measures Medidas sobre	Table top / Sobre														Top & Base	
	Oak Roble		s600	Lacquered Lacado		Laminate Laminado		LaminateTP LaminadoTP		Top Technical Stone 8		Low Iron Glass Cristal óptico		Cement Cemento		
	Ref.	€	€	Ref.	€	Ref.	€	Ref.	€	Ref.	€	Ref.	€	Ref.	€	
2800x1200	ME9930	3.168	225	ME9932	2.455	ME9934	3.749	ME9936	3.932	ME9938	4.722	ME9940	3.773	ME9942	5.063	
kg	149		149		149		149		149		181		149			
2 boxes/ bultos  m3	2,27		2,27		2,27		2,27		5'81		5'81		2'27			
3000x1200	ME9931	3.256	235	ME9933	2.651	ME9935	3.842	ME9937	4.035	ME9939	4.970	ME9941	3.732	ME9943	5.346	
kg	155		155		155		155		155		189		155			
2 boxes/ bultos  m3	2,32		2,32		2,32		2,32		6'09		6'09		2'32			

Table height / Altura de mesa 1100						
Top measures Medidas sobre	Table top / Sobre					
	Linoleum Linóleo		Ultra-matte Ultramate		Ultra-matteTP UltramateTP	
	Ref.	€	Ref.	€	Ref.	€
2800x1200	ME9944	4.093	ME9946	4.452	ME9948	4.459
kg	149		149		149	
2 boxes/ bultos  m3	2,27		2,27		2,27	
3000x1200	ME9945	4.185	ME9947	4.477	ME9949	4.551
kg	155		155		155	
2 boxes/ bultos  m3	2,32		2,32		2,32	

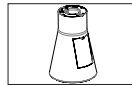
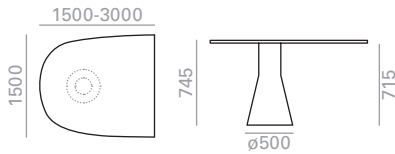

Acces panel for wiring up charge.  
Incremento por panel de acceso para cableado.

| 330 |

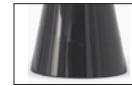

Incremento por base laca brillo  
Upcharge for bright lacquered finish bases.

| 323 |



Height adjustable glides up charge  
Incremento por tacos reguladores

| 57 |

Table height / Altura de mesa 745															
Top measures Medidas sobre	Table top / Sobre													Top & Base	
	Oak Roble		s600	Lacquered Lacado		Laminate Laminado		Laminate TP Laminado TP		*Top Technical Stone 8		Low Iron Glass Cristal óptico		Cement Cemento	
	Ref.	€	€	Ref.	€	Ref.	€	Ref.	€	Ref.	€	Ref.	€	Ref.	€
<b>1500x1500</b>	<b>ME7890</b>	1.236	162	<b>ME7894</b>	1.307	<b>ME7898</b>	2.289	<b>ME7902</b>	2.180	<b>ME7910</b>	3.065	<b>ME7906</b>	2.289	<b>ME7914</b>	2.162
<b>kg</b>	110		110		110		110		110		133		110		
<b>2 boxes/ bultos</b> <b>m3</b>	0,73		0,73		0,73		0,73		3'18		2'19		0'73		
<b>2000x1500</b>	<b>ME7891</b>	2.223	215	<b>ME7895</b>	1.565	<b>ME7899</b>	2.878	<b>ME7903</b>	2.895	<b>ME7911</b>	3.644	<b>ME7907</b>	2.645	<b>ME7915</b>	2.944
<b>kg</b>	129		129		129		129		129		159		129		
<b>2 boxes/ bultos</b> <b>m3</b>	0,86		0,86		0,86		0,86		4'03		1'41		0'86		
<b>2500x1500</b>	<b>ME7892</b>	2.694	264	<b>ME7896</b>	1.612	<b>ME7900</b>	2.952	<b>ME7904</b>	3.117	<b>ME7912</b>	4.098	<b>ME7908</b>	2.931	<b>ME7916</b>	3.296
<b>kg</b>	147		147		147		147		147		182		147		
<b>2 boxes/ bultos</b> <b>m3</b>	1,14		1		1		1		4'88		4'88		1		
<b>3000x1500</b>	<b>ME7893</b>	2.741	306	<b>ME7897</b>	1.754	<b>ME7901</b>	2.999	<b>ME7905</b>	3.191	<b>ME7913</b>	4.430	<b>ME7909</b>	3.273	<b>ME7917</b>	3.380
<b>kg</b>	164		164		164		164		164		207		164		
<b>2 boxes/ bultos</b> <b>m3</b>	1,14		1,14		1,14		1,14		5'73		5'73		1'14		

\*Maximum width 1440 mm Ancho máximo 1440 mm

Amount of sand: 50 kg. (2x25 kg.)  
Cantidad de arena 50 kg. (2x25 kg.)

Table height / Altura de mesa 745						
Top measures Medidas sobre	Table top / Sobre					
	Linoleum Linóleo		Ultra-matte Ultramate		Ultra-matte TP Ultramate TP	
	Ref.	€	Ref.	€	Ref.	€
<b>1500x1500</b>	<b>ME7918</b>	2.448	<b>ME7922</b>	2.601	<b>ME7926</b>	2.766
<b>kg</b>	110		110		110	
<b>2 boxes/ bultos</b> <b>m3</b>	0,86		0,73		0,73	
<b>2000x1500</b>	<b>ME7919</b>	2.860	<b>ME7923</b>	3.387	<b>ME7927</b>	3.179
<b>kg</b>	129		129		129	
<b>2 boxes/ bultos</b> <b>m3</b>	0,86		0,86		0,86	
<b>2500x1500</b>	<b>ME7920</b>	3.125	<b>ME7924</b>	3.400	<b>ME7928</b>	3.444
<b>kg</b>	147		147		147	
<b>2 boxes/ bultos</b> <b>m3</b>	1,04		1,04		1,04	
<b>3000x1500</b>	<b>ME7921</b>	3.172	<b>ME7925</b>	3.444	<b>ME7929</b>	3.514
<b>kg</b>	164		164		164	
<b>2 boxes/ bultos</b> <b>m3</b>	1,14		1,14		1,14	

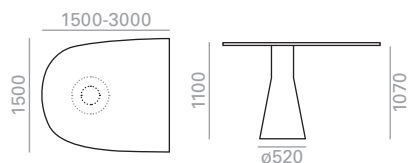

Incremento por base laca brillo  
Upcharge for bright lacquered finish bases. | 387 |



Height adjustable glides up charget  
Incremento por tacos reguladores | 57 |

Table height / Altura de mesa 1100															
Top measures Medidas sobre	Table top / Sobre													Top & Base	
	Oak Roble		s600	Lacquered Lacado		Laminate Laminado		Laminate TP Laminado TP		*Top Technical Stone 8		Low Iron Glass Cristal óptico		Cement Cemento	
	Ref.	€	€	Ref.	€	Ref.	€	Ref.	€	Ref.	€	Ref.	€	Ref.	€
<b>1500x1500</b>	<b>ME7930</b>	1.314	162	<b>ME7934</b>	1.387	<b>ME7938</b>	2.198	<b>ME7942</b>	2.366	<b>ME7950</b>	3.155	<b>ME7946</b>	2.323	<b>ME7954</b>	2.235
<b>kg</b>	121		121		121		121		121		143		121		
<b>2 boxes/ bultos</b> <b>m3</b>	0,87		0,87		0,87		0,87		3'32		1'3		0'87		
<b>2000x1500</b>	<b>ME7931</b>	2.305	215	<b>ME7935</b>	1.641	<b>ME7939</b>	2.955	<b>ME7943</b>	2.977	<b>ME7951</b>	3.735	<b>ME7947</b>	2.860	<b>ME7955</b>	3.130
<b>kg</b>	140		140		140		140		140		169		140		
<b>2 boxes/ bultos</b> <b>m3</b>	1,01		1,01		1,01		1,01		4'17		1'55		1'01		
<b>2500x1500</b>	<b>ME7932</b>	2.770	264	<b>ME7936</b>	1.691	<b>ME7940</b>	3.028	<b>ME7944</b>	3.198	<b>ME7952</b>	4.184	<b>ME7948</b>	3.079	<b>ME7956</b>	3.422
<b>kg</b>	157		157		157		157		157		192		157		
<b>2 boxes/ bultos</b> <b>m3</b>	1,15		1,15		1,15		1,15		5'02		5'02		1'15		
<b>3000x1500</b>	<b>ME7933</b>	2.817	306	<b>ME7937</b>	1.834	<b>ME7941</b>	3.079	<b>ME7945</b>	3.272	<b>ME7953</b>	4.604	<b>ME7949</b>	3.463	<b>ME7957</b>	3.571
<b>kg</b>	174		174		174		174		174		217		174		
<b>2 boxes/ bultos</b> <b>m3</b>	1,28		1,28		1,28		1,28		5'87		5'87		1'28		

\*Maximum width 1440 mm Ancho máximo 1440 mm

Amount of sand: 50 kg. (2x25 kg.)  
Cantidad de arena 50 kg. (2x25 kg.)

Table height / Altura de mesa 1100						
Top measures Medidas sobre	Table top / Sobre					
	Linoleum Linóleo		Ultra-matte Ultramate		Ultra-matte TP Ultramate TP	
	Ref.	€	Ref.	€	Ref.	€
<b>1500x1500</b>	<b>ME7958</b>	2.521	<b>ME7962</b>	2.678	<b>ME7966</b>	2.839
<b>kg</b>	121		121		121	
<b>2 boxes/ bultos</b> <b>m3</b>	0,87		0,87		0,87	
<b>2000x1500</b>	<b>ME7959</b>	2.933	<b>ME7963</b>	3.461	<b>ME7967</b>	3.253
<b>kg</b>	140		140		140	
<b>2 boxes/ bultos</b> <b>m3</b>	1,01		1,01		1,01	
<b>2500x1500</b>	<b>ME7960</b>	3.198	<b>ME7964</b>	3.474	<b>ME7968</b>	3.518
<b>kg</b>	157		157		157	
<b>2 boxes/ bultos</b> <b>m3</b>	1,15		1,15		1,15	
<b>3000x1500</b>	<b>ME7961</b>	3.245	<b>ME7965</b>	3.521	<b>ME7969</b>	3.588
<b>kg</b>	174		174		174	
<b>2 boxes/ bultos</b> <b>m3</b>	1,28		1,28		1,28	

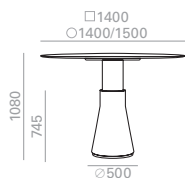

Incremento por base  
laca brillo  
Upcharge for bright  
lacquered finish bases. | 323 |

Amount of sand: 50 kg.  
Cantidad de arena 50 kg.

Table height / Altura de mesa 745									
Top measures Medidas sobre	Table top / Sobre						Top & Base		
	Oak Roble		s600	Lacquered Lacado		Low Iron Glass Cristal óptico		Cement Cemento	
	Ref.	€	€	Ref.	€	Ref.	€	Ref.	€
<b>1400X1400</b>	<b>ME4950</b>	3.462	156	<b>ME4951</b>	3.770	<b>ME4952</b>	4.618	<b>ME4953</b>	4.557
kg	125			125		125		125	
<b>2 boxes/ bultos</b> m3	0,59			0,59		0,59		0'59	
<b>ø1400</b>	<b>ME4954</b>	3.742	156	<b>ME4955</b>	3.778	<b>ME4956</b>	4.765	<b>ME4957</b>	4.570
kg	125			125		125		125	
<b>2 boxes/ bultos</b> m3	0,59			0,59		0,59		0'59	
<b>ø1500</b>	<b>ME4958</b>	3.745	156	<b>ME4959</b>	3.822	<b>ME4960</b>	4.842	<b>ME4961</b>	4.677
kg	127			127		127		127	
<b>2 boxes/ bultos</b> m3	0,62			0,62		0,62		0'62	
<b>ellipse/ elipse 1400X1400</b>	<b>ME4962</b>	3.742	156	<b>ME4963</b>	3.778	<b>ME4964</b>	4.826	<b>ME4965</b>	4.570
kg	125			125		125		125	
<b>2 boxes/ bultos</b> m3	0,59			0,59		0,59		0'59	

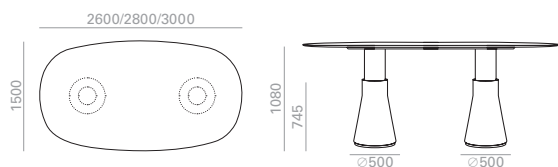

Incremento por base laca brillo  
Upcharge for bright lacquered finish bases. | 646 |

Amount of sand: 100 kg. (2x50kg.)  
Cantidad de arena 100 kg. (2x50kg.)

Table height / Altura de mesa 745																
Top measures Medidas sobre	Table top / Sobre														Top & Base	
	Oak Roble		s600	Lacquered Lacado		Laminate Laminado		Laminate TP Laminado Tp		*Top Technical Stone 8		Low Iron Glass Cristal óptico		Cement Cemento		
	Ref.	€	€	Ref.	€	Ref.	€	Ref.	€	Ref.	€	Ref.	€	Ref.	€	
<b>2600x1500</b>	<b>ME4966</b>	7.753	264	<b>ME4967</b>	7.081	<b>ME4968</b>	8.319	<b>ME4969</b>	8.546	<b>ME4970</b>	9.909	<b>ME4971</b>	8.603	<b>ME4972</b>	8.577	
<b>kg</b>	157		151		151		151		151		151		151			
<b>2 boxes/ bultos</b> <b>m3</b>	1		1		1		1		1		1		1			
<b>2800x1500</b>	<b>ME4973</b>	7.788	285	<b>ME4974</b>	7.140	<b>ME4975</b>	8.340	<b>ME4976</b>	8.577	<b>ME4977</b>	10.099	<b>ME4978</b>	8.723	<b>ME4979</b>	8.608	
<b>kg</b>	157		157		157		157		157		157		157			
<b>2 boxes/ bultos</b> <b>m3</b>	1,04		1,04		1,04		1,04		1'04		1'04		1'04			
<b>3000x1500</b>	<b>ME4980</b>	7.839	360	<b>ME4981</b>	7.205	<b>ME4982</b>	8.373	<b>ME4983</b>	8.624	<b>ME4984</b>	10.421	<b>ME4985</b>	8.852	<b>ME4986</b>	8.825	
<b>kg</b>	162		162		162		162		162		162		162			
<b>2 boxes/ bultos</b> <b>m3</b>	1,09		1,09		1,09		1,09		1'09		1'09		1'09			

\*Maximum width 1440 mm Ancho máximo 1440 mm

Table height / Altura de mesa 745						
Top measures Medidas sobre	Table top / Sobre					
	Linoleum Linóleo		Ultra-matte Ultramate		Ultra-matte TP Ultramate TP	
	Ref.	€	Ref.	€	Ref.	€
<b>2600x1500</b>	<b>ME4987</b>	8.445	<b>ME4988</b>	8.720	<b>ME4989</b>	8.769
<b>kg</b>	151		151		151	
<b>2 boxes/ bultos</b> <b>m3</b>	1		1		1	
<b>2800x1500</b>	<b>ME4990</b>	8.461	<b>ME4991</b>	8.739	<b>ME4992</b>	8.794
<b>kg</b>	157		157		157	
<b>2 boxes/ bultos</b> <b>m3</b>	1,04		1,04		1,04	
<b>3000x1500</b>	<b>ME4993</b>	8.489	<b>ME4994</b>	8.771	<b>ME4995</b>	8.836
<b>kg</b>	162		162		162	
<b>2 boxes/ bultos</b> <b>m3</b>	1,09		1,09		1,09	

## Maximum table heights Alturas máximas de mesa

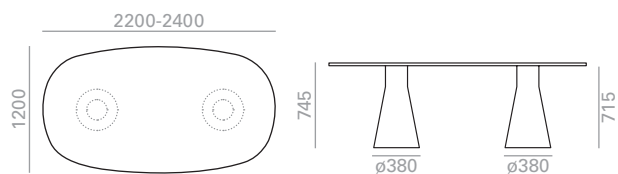

Table top				
Oak Roble	Lacquered Lacado	Laminate Laminado	Laminate TP Laminado TP	Top Technical Stone 8
744	744	744	744	764

Table top				
Low Iron Glass Cristal óptico	Cement Cemento	Linoleum Linóleo	Ultra-matte Ultramate	Ultra-matte TP Ultramate TP
761		744	744	744

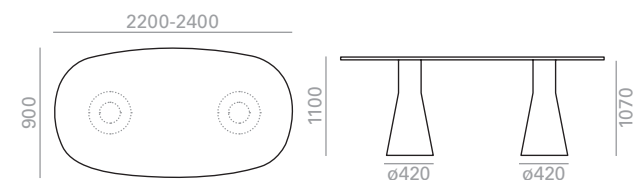
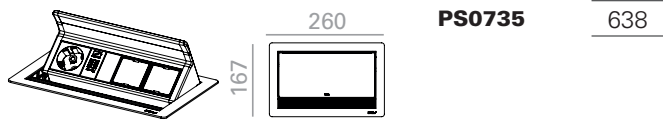

Table top				
Oak Roble	Lacquered Lacado	Laminate Laminado	Laminate TP Laminado TP	Top Technical Stone 8
1112	1112	1112	1112	1132

Table top				
Low Iron Glass Cristal óptico	Cement Cemento	Linoleum Linóleo	Ultra-matte Ultramate	Ultra-matte TP Ultramate TP
761		744	744	744

**PS-IN SURFACE**



**PS0735** 638

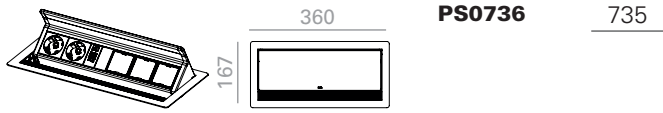

**PS0736** 735



**PS0804** 142

**PS-QI**



**PS0714** 243

**Preinstalled (Optional) / Preinstalación (Opcional) IN0006**

First installation / Primera instalación 270  
 Second and more installations / Segunda y más instalaciones 90

**PS-UNDERTOP**

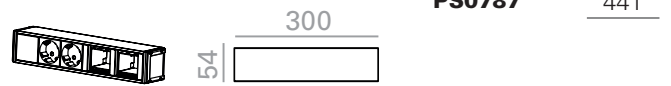

**PS0787** 441



**PS0789** 510

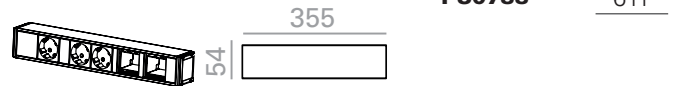

**PS0788** 611

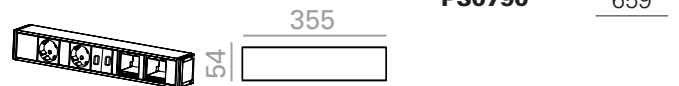

**PS0790** 659

**PS-INTREGATED**

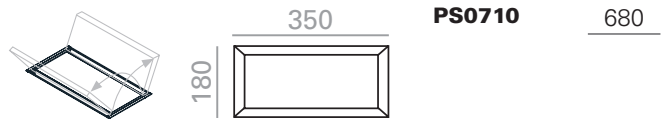

**PS0710** 680

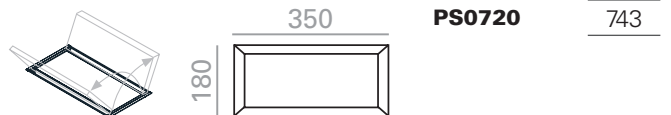

**PS0720** 743



**PS0795** 453



**PS0796** 468

**IN-SURFACE POWER BOXES  
CAJAS DE CONEXIONES DENTRO DEL SOBRE**

Aluminum power box mounted in the table top with a folding protective lid. Available for any Reverse model. It is served in anodized silver, for other finishing, contact the Customer Department. There are two power system sizes available and data slots can be customized according to the below diagram.

Caja de conexiones de aluminio integrada dentro de la superficie del sobre con tapa abatible, disponible para cualquier modelo de mesa Reverse. Se sirve en color anodizado plata, para otros acabados consultar al Departamento Comercial. Se ofrecen dos tamaños de caja diferentes y con conectividad configurable, acorde al siguiente esquema:

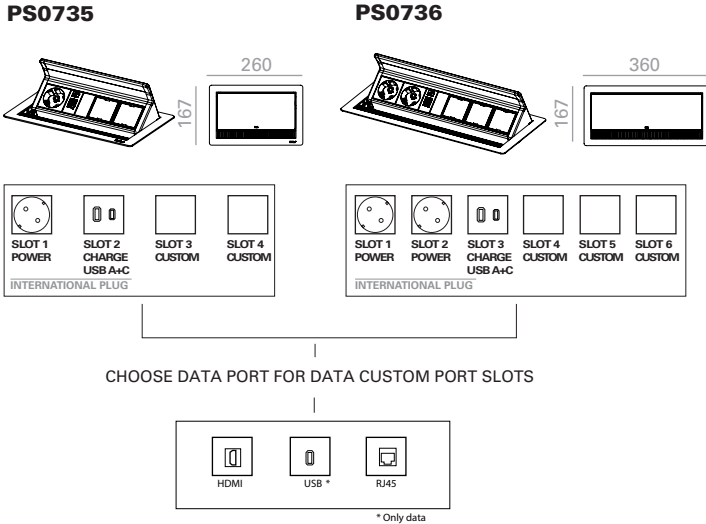

**OPTIONAL PREINSTALLED WIRING  
PREINSTALACIÓN DEL CABLEADO**

**IN0006**

Preinstalled wiring consists in the addition of the necessary mechanisms to integrate power systems in the table, so that wiring is hidden until the way out in the floor. Necessary grommet are included and 3m cable (from the power system). For other cable dimensions contact the Customer Department. Tables with only one base are exempt of this charge, for the rest of tables ask the Customer Department.

La preinstalación consiste en el montaje de los mecanismos necesarios para integrar el sistema de electrificación en la mesa, de modo que el cableado quede oculto hasta su salida por la base. Se incluyen los pasacables necesarios y 3 metros de cable (midiendo desde el sistema de conexiones). Las mesas de una sola base quedan exentas de este cargo, para el resto consultar al Departamento Comercial.

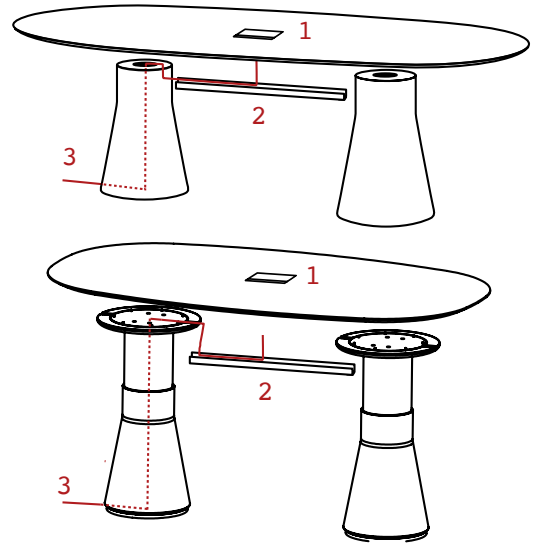

**1 POWER BOXES DISTRIBUTION DISTRIBUCIÓN DE SISTEMAS**

In tables with only one Reverse base power box can't be centered with the base. In tables with more than one base, by default power box is placed in the center of the table and in lengthwise direction. If more than one power box is installed, inform the Customer Department about the desired position.

En mesas con una sola base el sistema eléctrico iría instalado descentrado respecto a la base. En mesas con más de una base, por defecto la posición del sistema irá en el centro de la mesa y en sentido longitudinal. Si se solicita más de un sistema eléctrico, comunicar la posición deseada al Departamento Comercial.

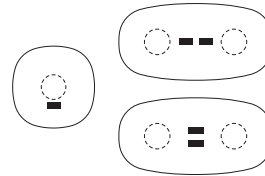

**2 WIRING MANAGEMENT GESTIÓN DEL CABLEADO**

Wire pass through an aluminum grommet keeping it hidden. By default color is silver, for other finishings ask the Customer Department.

El cable se pasa a través de un perfil pasacables de aluminio que lo mantiene oculto. Su color de serie es el plata, para otros acabados consultar al Departamento Comercial.

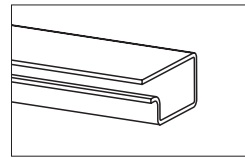

**3 CABLE WAY OUT SALIDA DE CABLEADO**

The cable way out can be performed directly from the power system or thru a canal in the base bottom, so that is hidden until it gets to the floor.

La salida del cable se realiza directamente desde el propio sistema como por unas canalizaciones en la parte inferior de la base, de modo que el cable queda oculto hasta llegar al suelo.

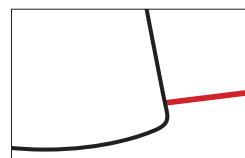



**IN-SURFACE POWER BOXES  
CAJAS DE CONEXIONES DENTRO DEL SOBRE**

It is a data dynamo with 2 amp dual charging USB. Available in two finishes: black or white. For lifting base versions contact the Customer Department.

Es una dínamo de datos con 2 amp de carga dual USB. Disponible en dos acabados: negro o blanco. Para versiones de bases elevables consultar al Departamento Comercial.

PS0804

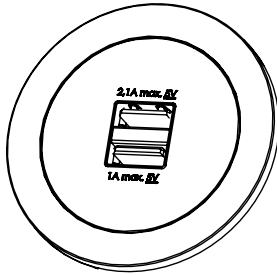

**OPTIONAL PREINSTALLED WIRING  
PREINSTALACIÓN DEL CABLEADO**

IN0006

Preinstalled wiring consists in the addition of the necessary mechanisms to integrate power systems in the table, so that wiring is hidden until the way out in the floor. Necessary grommet are included and 3m cable (from the power system). For other cable dimensions contact the Sales Department. For each wire Reverse base, you must ask for une IN0006 to the Customer Department.

La preinstalación consiste en el montaje de los mecanismos necesarios para integrar el sistema de electrificación en la mesa, de modo que el cableado quede oculto hasta su salida por la base. Se incluyen los pasacables necesarios y 3 metros de cable (midiendo desde el sistema de conexiones). Por cada base por al que se desee bajar el cable se solicita un IN0006 al Departamento Comercial.

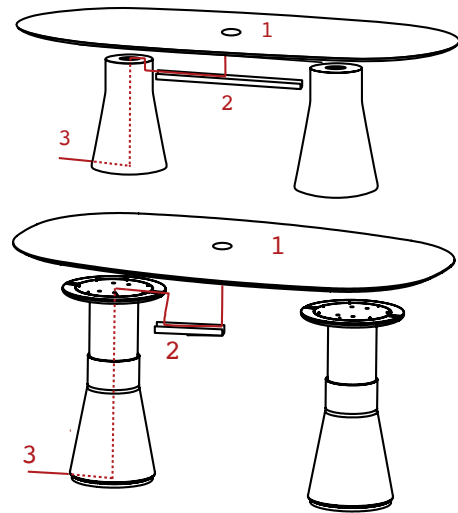

**1 POWER BOXES DISTRIBUTION DISTRIBUCIÓN DE SISTEMAS**

In tables with only one Reverse base power box can't be centered with the base. In tables with more than one base, by default power box is placed in the center of the table and in lengthwise direction. If more than one power box is installed, inform the Customer Department about the desired position.

En mesas con más de una base, por defecto la posición del sistema irá en el centro de la mesa y en sentido longitudinal. Si se solicita más de un sistema eléctrico, comunicar la posición deseada al Departamento Comercial.

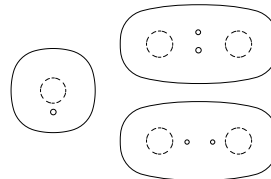

**2 WIRING MANAGEMENT GESTIÓN DEL CABLEADO**

Wire pass through an aluminum grommet keeping it hidden. By default color is silver, for other finishings ask the Customer Department.

El cable se pasa a través de un perfil pasacables de aluminio que lo mantiene oculto. Su color de serie es el plata, para otros acabados consultar al Departamento Comercial.

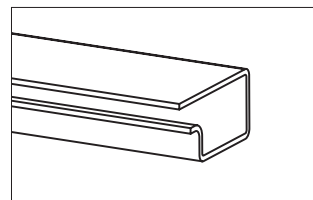

**3 CABLE WAY OUT SALIDA DE CABLEADO**

The cable way out can be performed directly from the power system or thru a canal in the base bottom, so that is hidden until it gets to the floor.

La salida del cable se realiza directamente desde el propio sistema como por unas canalizaciones en la parte inferior de la base, de modo que el cable queda oculto hasta llegar al suelo.

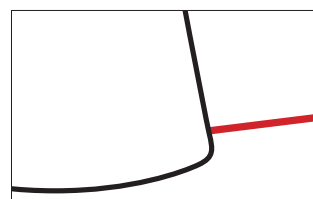

**QI CHARGING POWER BOXES  
CAJAS DE CONEXIONES QI**

The inductive charging station, allows maximum larger contact surface. Available in two finish: black or white. For lifting base versions contact the Customer Department.

La estación de carga inductiva permite una superficie de contacto máxima más grande. Disponible en dos acabados: negro o blanco. Para versiones de bases elevables consultar al Departamento Comercial.

PS0714

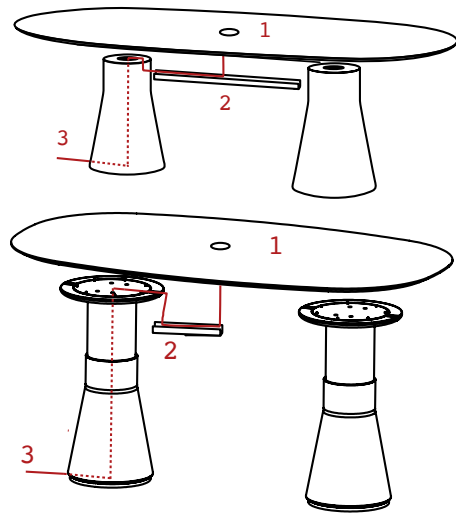
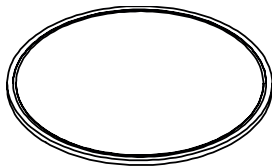

**1 POWER BOXES DISTRIBUTION DISTRIBUCIÓN DE SISTEMAS**

In tables with only one Reverse base power box can't be centered with the base. In tables with more than one base, by default power box is placed in the center of the table and in lengthwise direction. If more than one power box is installed, inform the Customer Department about the desired position.

En mesas con una sola base el sistema eléctrico iría instalado descentrado respecto a la base. En mesas con más de una base, por defecto la posición del sistema irá en el centro de la mesa y en sentido longitudinal. Si se solicita más de un sistema eléctrico, comunicar la posición deseada al Departamento Comercial.

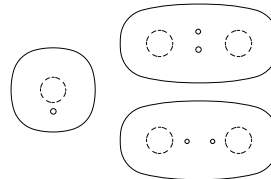

**2 WIRING MANAGEMENT GESTIÓN DEL CABLEADO**

Wire pass through an aluminum grommet keeping it hidden. By default color is silver, for other finishings ask the Customer Department.

El cable se pasa a través de un perfil pasacables de aluminio que lo mantiene oculto. Su color de serie es el plata, para otros acabados consultar al Departamento Comercial.

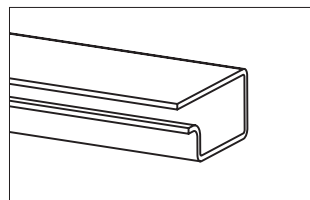

**OPTIONAL PREINSTALLED WIRING  
PREINSTALACIÓN DEL CABLEADO**

IN0006

Preinstalled wiring consists in the addition of the necessary mechanisms to integrate power systems in the table, so that wiring is hidden until the way out in the floor. Necessary grommet are included and 3m cable (from the power system). For other cable dimensions contact the Sales Department. For each wire Reverse base, you must ask for one IN0006 to the Customer Department.

La preinstalación consiste en el montaje de los mecanismos necesarios para integrar el sistema de electrificación en la mesa, de modo que el cableado quede oculto hasta su salida por la base. Se incluyen los pasacables necesarios y 3 metros de cable (midiendo desde el sistema de conexiones). Por cada base por al que se desee bajar el cable se solicita un IN0006 al Departamento Comercial.

**3 CABLE WAY OUT SALIDA DE CABLEADO**

The cable way out can be performed directly from the power system or thru a canal in the base bottom, so that is hidden until it gets to the floor.

La salida del cable se realiza directamente desde el propio sistema como por unas canalizaciones en la parte inferior de la base, de modo que el cable queda oculto hasta llegar al suelo.

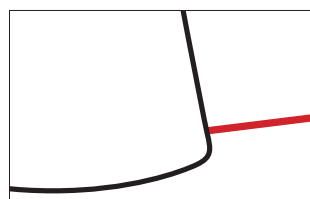

**INTEGRATED POWER BOXES  
CAJAS DE CONEXIONES INTEGRADAS**

The black finish is integrated with the top. Its opening is towards both sides. For lifting base versions contact the Customer Department.

El acabado negro está integrado con la parte superior. Su apertura es hacia ambos lados. Para versiones de bases elevables consultar al Departamento Comercial.

**PS0710**

**PS0720**

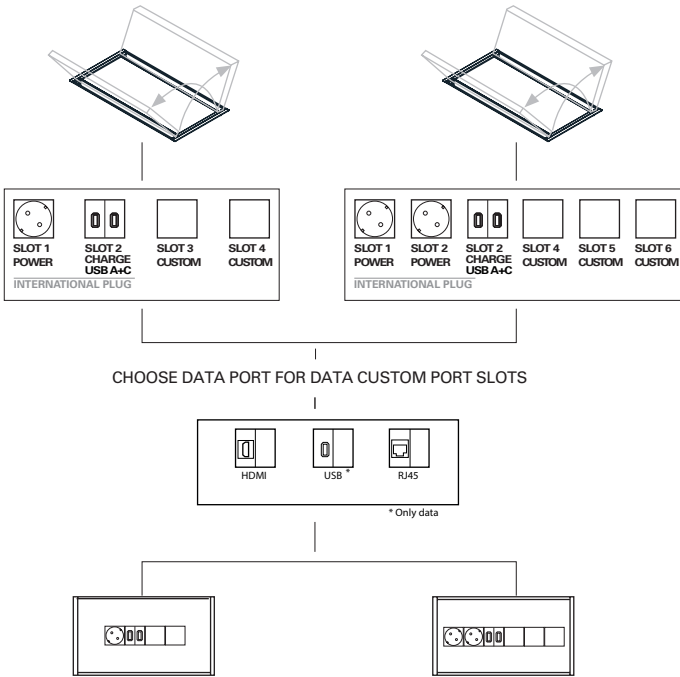

**OPTIONAL PREINSTALLED WIRING  
PREINSTALACIÓN DEL CABLEADO**

**IN0006**

Preinstalled wiring consists in the addition of the necessary mechanisms to integrate power systems in the table, so that wiring is hidden until the way out in the floor. Necessary grommet are included and 3m cable (from the power system). For other cable dimensions contact the Sales Department. For each wire Reverse base, you must ask for one IN0006 to the Customer Department.

La preinstalación consiste en el montaje de los mecanismos necesarios para integrar el sistema de electrificación en la mesa, de modo que el cableado quede oculto hasta su salida por la base. Se incluyen los pasacables necesarios y 3 metros de cable (midiendo desde el sistema de conexiones). Por cada base por al que se desee bajar el cable se solicita un IN0006 al Departamento Comercial.

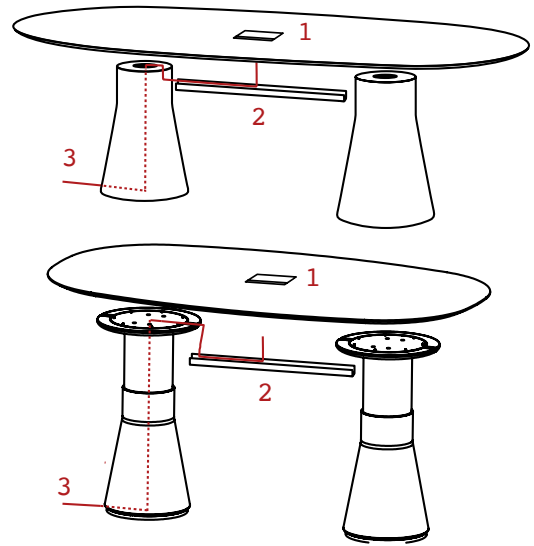

**1 POWER BOXES DISTRIBUTION DISTRIBUCIÓN DE SISTEMAS**

In tables with only one Reverse base power box can't be centered with the base. In tables with more than one base, by default power box is placed in the center of the table and in lengthwise direction. If more than one power box is installed, inform the Customer Department about the desired position.

En mesas con una sola base el sistema eléctrico iría instalado descentrado respecto a la base. En mesas con más de una base, por defecto la posición del sistema irá en el centro de la mesa y en sentido longitudinal. Si se solicita más de un sistema eléctrico, comunicar la posición deseada al Departamento Comercial.

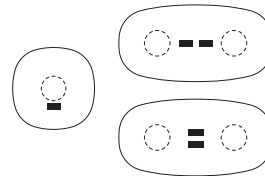

**2 WIRING MANAGEMENT GESTIÓN DEL CABLEADO**

Wire pass through an aluminum grommet keeping it hidden. By default color is silver, for other finishings ask the Customer Department.

El cable se pasa a través de un perfil pasacables de aluminio que lo mantiene oculto. Su color de serie es el plata, para otros acabados consultar al Departamento Comercial.

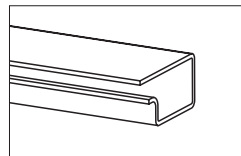

**3 CABLE WAY OUT SALIDA DE CABLEADO**

The cable way out can be performed directly from the power system or thru a canal in the base bottom, so that is hidden until it gets to the floor.

La salida del cable se realiza directamente desde el propio sistema como por unas canalizaciones en la parte inferior de la base, de modo que el cable queda oculto hasta llegar al suelo.

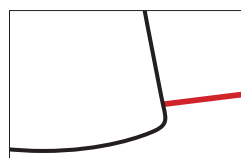

**UNDER-TOP POWER BOXES  
CAJA DE CONEXIONES BAJO EL SOBRE**

Power box mounted under the table top. Available in black or white color (silver or black in USA), for other finishing, contact the Customer Department. There are two power system sizes available and data slots can be customized according to the below diagram. For lifting base versions contact the Customer Department.

Regleta de conexiones bajo la superficie del sobre. Se sirve en color negro o blanco (plata o negro en USA. Para otros acabados consultar al departamento comercial. Se ofrecen formatos de caja de dos tamaños de caja diferentes y con opciones de conectividad configurable. Para versiones de bases elevables consultar al Departamento Comercial.

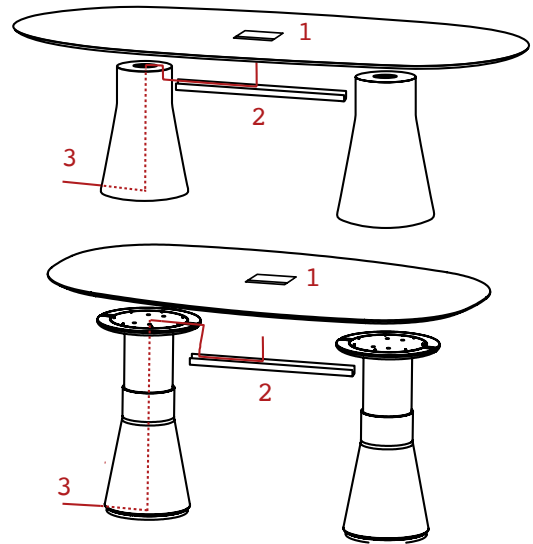

**1 POWER BOXES DISTRIBUTION DISTRIBUCIÓN DE SISTEMAS**

In tables with only one Reverse base power box can't be centered with the base. In tables with more than one base, by default power box is placed in the center of the table and in lengthwise direction. If more than one power box is installed, inform the Customer Department about the desired position.

En mesas con una sola base el sistema eléctrico iría instalado descentrado respecto a la base. En mesas con más de una base, por defecto la posición del sistema irá en el centro de la mesa y en sentido longitudinal. Si se solicita más de un sistema eléctrico, comunicar la posición deseada al Departamento Comercial.

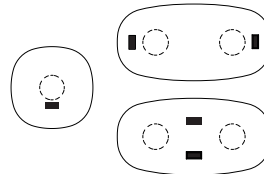

**2 WIRING MANAGEMENT GESTIÓN DEL CABLEADO**

Wire pass through an aluminum grommet keeping it hidden. By default color is silver, for other finishings ask the Customer Department.

El cable se pasa a través de un perfil pasacables de aluminio que lo mantiene oculto. Su color de serie es el plata, para otros acabados consultar al Departamento Comercial.

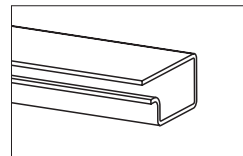

**3 CABLE WAY OUT SALIDA DE CABLEADO**

The cable way out can be performed directly from the power system or thru a canal in the base bottom, so that is hidden until it gets to the floor.

La salida del cable se realiza directamente desde el propio sistema como por unas canalizaciones en la parte inferior de la base, de modo que el cable queda oculto hasta llegar al suelo.

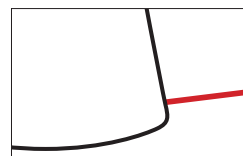

**PS0787**

**PS0788**

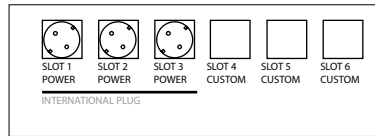
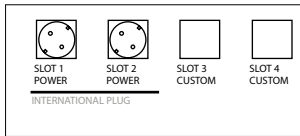

CHOOSE DATA PORT FOR DATA CUSTOM PORT SLOTS

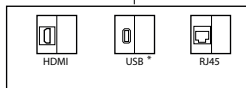

\* Only data

**PS0789**

**PS0790**

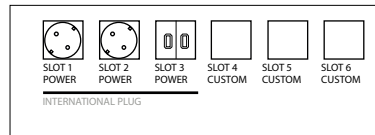
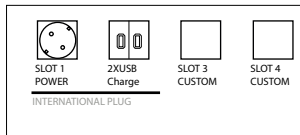

CHOOSE DATA PORT FOR DATA CUSTOM PORT SLOTS

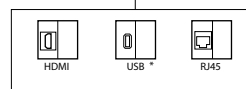

\* Only data

**OPTIONAL PREINSTALLED WIRING  
PREINSTALACIÓN DEL CABLEADO**

**IN0006**

Preinstalled wiring consists in the addition of the necessary mechanisms to integrate power systems in the table, so that wiring is hidden until the way out in the floor. Necessary grommet are included and 3m cable (from the power system). For other cable dimensions contact the Sales Department. For each wire Reverse base, you must ask for one IN0006 to the Customer Department.

La preinstalación consiste en el montaje de los mecanismos necesarios para integrar el sistema de electrificación en la mesa, de modo que el cableado quede oculto hasta su salida por la base. Se incluyen los pasacables necesarios y 3 metros de cable (midiendo desde el sistema de conexiones). Por cada base por la que se desee bajar el cable se solicita un IN0006 al Departamento Comercial.

**IN-SURFACE SOCKET POWERS  
TORRES DE CONEXIONES DENTRO DEL SOBRE**

Socket tower mounted in the table top. The hidden system manually rises with a slight push. Valid for Reverse tables with bases Reverse 38, 50 and 60. For lifting base versions contact the Customer Department. Available in silver, white or black color, for for other finishing, contact the Customer Department.

Torre de conexiones integrada dentro de la supercie del sobre. El sistema eléctrico oculto se alza manualmente al pulsarlo. Disponible mesas Reverse con bases Reverse 38, 50 y 60. Para versiones de bases elevables consultar al Departamento Comercial. Disponible en color plata, blanco o negro, para otros acabados consultar al Departamento Comercial.

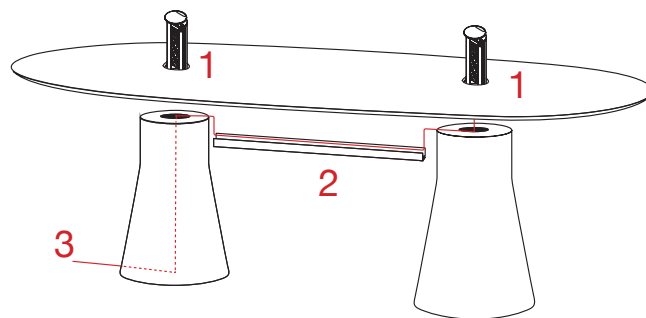

**PS0795**

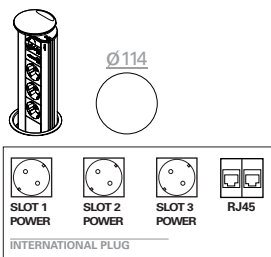

**PS0796**

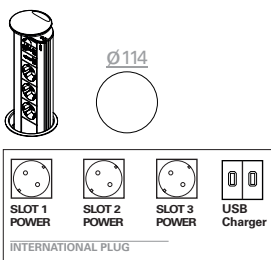

**1 POWER BOXES DISTRIBUTION DISTRIBUCIÓN DE SISTEMAS**

In tables with only one Reverse base power box can't be centered with the base. In tables with more than one base, by default power box is placed in the center of the table and in lengthwise direction. If more than one power box is installed, inform the Customer Department about the desired position.

En mesas con más de una base, por defecto la posición del sistema irá en el centro de la mesa y en sentido longitudinal. Si se solicita más de un sistema eléctrico, comunicar la posición deseada al Departamento Comercial.



**2 WIRING MANAGEMENT GESTIÓN DEL CABLEADO**

Wire pass through an aluminum grommet keeping it hidden. By default color is silver, for other finishings ask the Customer Department.

El cable se pasa a través de un perfil pasacables de aluminio que lo mantiene oculto. Su color de serie es el plata, para otros acabados consultar al Departamento Comercial.

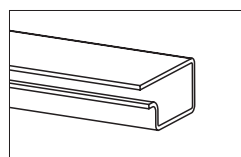

**OPTIONAL PREINSTALLED WIRING  
PREINSTALACIÓN DEL CABLEADO**

**IN0006**

Preinstalled wiring consists in the addition of the necessary mechanisms to integrate power systems in the table, so that wiring is hidden until the way out in the floor. Necessary grommet are included and 3m cable (from the power system). For other cable dimensions contact the Sales Department. For each wire Reverse base, you must ask for one IN0006 to the Customer Department.

La preinstalación consiste en el montaje de los mecanismos necesarios para integrar el sistema de electrificación en la mesa, de modo que el cableado quede oculto hasta su salida por la base. Se incluyen los pasacables necesarios y 3 metros de cable (midiéndolo desde el sistema de conexiones). Por cada base por al que se desee bajar el cable se solicita un IN0006 al Departamento Comercial.

**3 CABLE WAY OUT SALIDA DE CABLEADO**

The cable way out can be performed directly from the power system or thru a canal in the base bottom, so that is hidden until it gets to the floor.

La salida del cable se realiza directamente desde el propio sistema como por unas canalizaciones en la parte inferior de la base, de modo que el cable queda oculto hasta llegar al suelo.

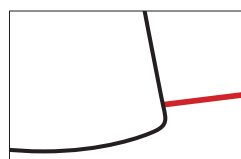









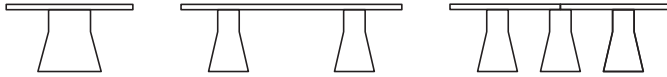

**Description**  
**Descripción**

Table program available with different types of bases and table tops. Pure Eco thermo-polymer (100% recycled) available in several colors and gloss lacquer option. Table tops in several shapes and sizes available in various finishes.

Programa de mesas disponible con diferentes tipos de bases y sobres de mesa. Bases de termopolimero Pure Eco (100% reciclado) disponible en diferentes colores y opción de laca brillo. Sobres de tablero de diferentes formas y medidas disponible en diferentes acabados.

**Wood finish Oak**  
**Acabado madera Roble**

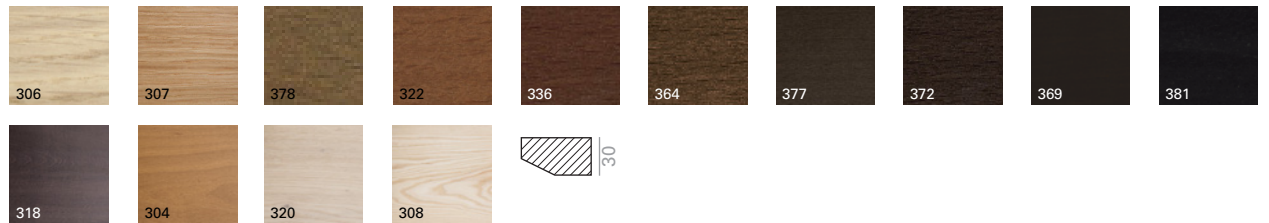

**Wood lacquer finish**  
**Acabado laca madera**



**Laminated**  
**Laminado**



**Laminated TP**  
**Laminado TP**



**Linoleum finish**  
**Acabado linóleo**

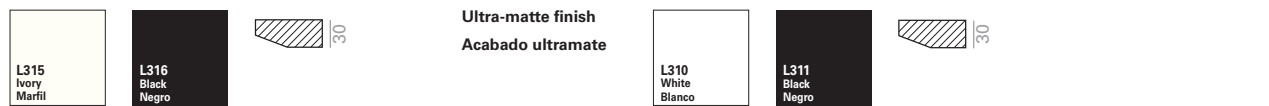

**Glass finish**  
**Acabado de cristal**

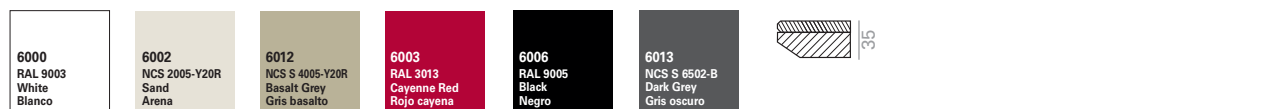

**Technical Stone 8 finish**  
**Acabado Technical Stone 8**



**M1 marble finish**  
**Acabado de mármol M1**



**M3 marble finish**  
**Acabado de mármol M3**



**Pure Eco Thermo-polymer finish**  
**Acabado de Termopolimero Pure Eco**



**Power box**  
**Caja de conexiones**



**Cement finish**  
**Acabado cemento**



**Certificates**  
**Certificados**

Quality - Resistance  
Calidad - Resistencia

UNE EN 15372

**Intellectual property Propiedad intelectual**

All our collections are protected by international industrial design registries, designs patents, copyrights and intellectual Property laws. Unauthorized use of AW International Property is a criminal offence and can lead to prosecution.  
Todas nuestras colecciones están protegidas por registros de diseño industrial, diseño de patente, copyright y derechos de propiedad intelectual todo el mundo. El uso no autorizado de los diseños y propiedad intelectual de AW supone un delito que puede ser sometido a acción judicial.



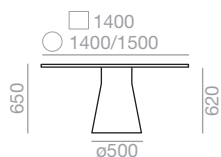

Height adjustable glides up charged  
Incremento por tacos reguladores

| 57 |



Incremento por base laca brillo  
Upcharge for bright lacquered finish bases.

| 323 |

Amount of sand: 50 kg.  
Cantidad de arena 50 kg.

Table height / Altura de mesa 650									
Top measures Medidas sobre	Table top / Sobre							Top & Base	
	Oak Roble		s600	Lacquered Lacado		Low Iron Glass Cristal óptico		Cement Cemento	
	Ref.	€	€	Ref.	€	Ref.	€	Ref.	€
<b>1400x1400</b>	<b>ME5500</b>	1.243	156	<b>ME5507</b>	1.280	<b>ME5514</b>	2.010	<b>ME5723</b>	2.107
<b>kg</b>	52		52		81		133		
<b>2 boxes/ bultos</b> <b>m3</b>	0,55		0,55		1,39		0'55		
<b>ø1400</b>	<b>ME5521</b>	1.253	156	<b>ME5528</b>	1.290	<b>ME5535</b>	2.148	<b>ME5730</b>	2.401
<b>kg</b>	42		43		43		122		
<b>2 boxes/ bultos</b> <b>m3</b>	0,55		0,55		1,39		0'73		
<b>ø1500</b>	<b>ME5522</b>	1.260	162	<b>ME5529</b>	1.337	<b>ME5536</b>	2.243	<b>ME5731</b>	2.538
<b>kg</b>	47		48		74		128		
<b>2 boxes/ bultos</b> <b>m3</b>	0,59		0,59		1,54		0'78		
<b>ellipse/ elipse 1400x1400</b>	<b>ME5542</b>	1.253	156	<b>ME5549</b>	1.290	<b>ME5556</b>	2.187	<b>ME5737</b>	2.401
<b>kg</b>	42		43		65		132		
<b>2 boxes/ bultos</b> <b>m3</b>	0,55		0,55		1,39		0'73		

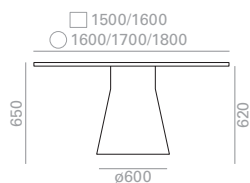

Height adjustable  
glides up charge  
Incremento por tacos  
reguladores



Incremento por base  
laca brillo  
Upcharge for bright  
lacquered finish bases.

| 57 |

| 401 |

Amount of sand: 75 kg.  
Cantidad de arena 75 kg.

Table height / Altura de mesa 650									
Top measures Medidas sobre	Table top / Sobre							Top & Base	
	Oak Roble		s600	Lacquered Lacado		Low Iron Glass Cristal óptico		Cement Cemento	
	Ref.	€	€	Ref.	€	Ref.	€	Ref.	€
<b>1500x1500</b>	<b>ME5501</b>	1.250	162	<b>ME5508</b>	1.327	<b>ME5515</b>	2.074	<b>ME5724</b>	2.221
kg	58			58		92		140	
<b>2 boxes/ bultos</b> m3	0,59			0,59		1,54		0'59	
<b>1600x1600</b>	<b>ME5502</b>	1.426	171	<b>ME5509</b>	1.463	<b>ME5516</b>	2.386	<b>ME5725</b>	2.401
kg	65			65		103		148	
<b>2 boxes/ bultos</b> m3	0,73			0,73		1,78		0'73	
<b>ø1600</b>	<b>ME5523</b>	1.465	171	<b>ME5530</b>	1.456	<b>ME5537</b>	2.574	<b>ME5732</b>	2.682
kg	53			53		83		134	
<b>2 boxes/ bultos</b> m3	0,73			0,73		1,78		0'84	
<b>ø1700</b>	<b>ME5524</b>	1.540	192	<b>ME5531</b>	1.507	<b>ME5538</b>	2.708	<b>ME5733</b>	2.828
kg	59			59		93		141	
<b>2 boxes/ bultos</b> m3	0,78			0,78		4,3		0'9	
<b>ø1800</b>	<b>ME5525</b>	1.667	216	<b>ME5532</b>	1.559	<b>ME5539</b>	2.951	<b>ME5734</b>	3.138
kg	65			65		103		148	
<b>2 boxes/ bultos</b> m3	0,84			0,84		4,71		0'96	
<b>ellipse/ elipse 1500x1500</b>	<b>ME5543</b>	1.260	162	<b>ME5550</b>	1.337	<b>ME5557</b>	2.286	<b>ME5738</b>	2.538
kg	47			48		74		139	
<b>2 boxes/ bultos</b> m3	0,59			0,59		1,54		0'78	
<b>ellipse/ elipse 1600x1600</b>	<b>ME5544</b>	1.465	171	<b>ME5551</b>	1.456	<b>ME5558</b>	2.573	<b>ME5739</b>	2.682
kg	53			53		83		139	
<b>2 boxes/ bultos</b> m3	0,73			0,73		1,78		0'84	

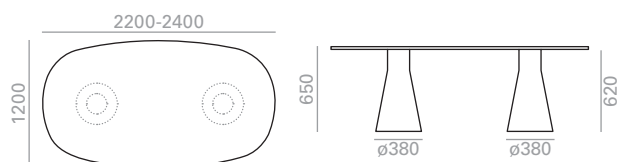

Height adjustable glides up charget  
Incremento por tacos reguladores

| 84 |



Incremento por base laca brillo  
Upcharge for bright lacquered finish bases.

| 544 |

Amount of sand: 50 kg. (2x25 kg.)  
Cantidad de arena 50 kg. (2x25 kg.)

Table height / Altura de mesa 650																
Top measures Medidas sobre	Table top / Sobre														Top & Base	
	Oak Roble		s600	Lacquered Lacado		Laminate Laminado		Laminate TP Laminado TP		Top Technical Stone 8		Low Iron Glass Cristal óptico		Cement Cemento		
	Ref.	€	€	Ref.	€	Ref.	€	Ref.	€	Ref.	€	Ref.	€	Ref.	€	
2200x1200	ME5563	1.768	177	ME5565	1.413	ME5567	2.182	ME5569	2.384	ME5571	3.742	ME5573	2.577	ME5744	3.651	
kg	58		59		59		59		87		89		128			
1 box/ bulto  m3	0,7		0,7		0,7		0,7		0'7		4		1'24			
2400x1200	ME5564	1.792	195	ME5566	1.439	ME5568	2.203	ME5570	2.415	ME5572	3.941	ME5574	2.651	ME5745	3.771	
kg	62		63		63		63		94		96		133			
1 box/ bulto  m3	0,73		0,73		0,73		0,73		0'73		4'3		1'29			

Table height / Altura de mesa 650						
Top measures Medidas sobre	Table top / Sobre					
	Linoleum Linóleo		Ultra-matte Ultramate		Ultra-matte TP Ultramate TP	
	Ref.	€	Ref.	€	Ref.	€
2200x1200	ME5900	2.390	ME5914	2.586	ME5928	2.655
kg	127		127		127	
1 box/ bulto  m3	0,73		0,73		0,73	
2400x1200	ME5901	2.407	ME5915	2.606	ME5929	2.694
kg	132		132		132	
1 box/ bulto  m3	0,77		0,77		0,77	

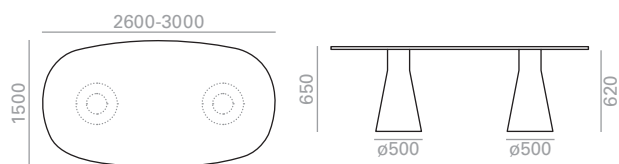

Height adjustable  
glides up charget  
Incremento por tacos  
reguladores

| 114 |



Incremento por base  
laca brillo  
Upcharge for bright  
lacquered finish bases.

| 646 |

Amount of sand: Cantidad de arena

Table height / Altura de mesa 650																
Top measures Medidas sobre	Table top / Sobre														Top & Base	
	Oak Roble		s600	Lacquered Lacado		Laminate Laminado		Laminate TP Laminado TP		*Top Technical Stone 8		Low Iron Glass Cristal óptico		Cement Cemento		
	Ref.	€	€	Ref.	€	Ref.	€	Ref.	€	Ref.	€	Ref.	€	Ref.	€	
2600x1500	ME5575	2.713	264	ME5578	2.046	ME5581	3.319	ME5584	3.525	ME5587	4.870	ME5590	3.471	ME5746	3.903	
kg	80		81		81		81		123		126		155			
1 box/ bulto  m3	1,24		1,24		1,24		1,24		1'24		5'81		1'34			

2800x1500	ME5576	2.737	285	ME5579	2.091	ME5582	3.341	ME5585	3.564	ME5588	5.114	ME5591	3.689	ME5747	4.867
kg	85		86		86		86		131		135		161		
1 box/ bulto  m3	1,29		1,29		1,29		1,29		1'29		6'17		1'89		

3000x1500	ME5577	2.762	306	ME5580	2.133	ME5583	3.365	ME5586	3.610	ME5589	5.355	ME5592	3.674	ME5748	5.311
kg	183'5		91		91		91		140		144		168		
1 box/ bulto  m3	1,34		1,34		1,34		1,34		1'34		6'53		2'01		

\*Maximum width 1440 mm Ancho máximo 1440 mm

Table height / Altura de mesa 650						
Top measures Medidas sobre	Table top / Sobre					
	Linoleum Linóleo		Ultra-matte Ultramate		Ultra-matte TP Ultramate TP	
	Ref.	€	Ref.	€	Ref.	€
2600x1500	ME5902	3.610	ME5916	3.906	ME5930	3.952
kg	167		167		167	
1 box/ bulto  m3	0,93		0,93		0,93	

2800x1500	ME5903	3.700	ME5917	3.926	ME5931	3.983
kg	175		175		175	
1 box/ bulto  m3	0,97		0,97		0,97	

3000x1500	ME5904	3.659	ME5918	3.953	ME5932	4.028
kg	184		184		184	
1 box/ bulto  m3	1,02		1,02		1,02	

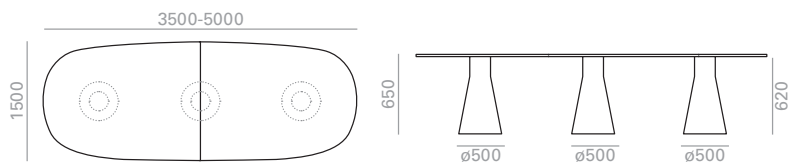

Incremento por base laca brillo  
Upcharge for bright lacquered finish bases.

969



Height adjustable glides up charget  
Incremento por tacos reguladores

171

Table height / Altura de mesa 650																
Top measures Medidas sobre	Table top / Sobre														Top & Base	
	Oak Roble		s600	Lacquered Lacado		Laminate Laminado		Laminate TP Laminado TP		*Top Technical Stone 8		Low Iron Glass Cristal óptico		Cement Cemento		
	Ref.	€	€	Ref.	€	Ref.	€	Ref.	€	Ref.	€	Ref.	€	Ref.	€	
<b>3500x1500</b>	<b>ME5593</b>	4.401	357	<b>ME5595</b>	2.897	<b>ME5597</b>	5.874	<b>ME5599</b>	6.174	<b>ME5601</b>	7.261	<b>ME5603</b>	4.698	<b>ME5749</b>	5.631	
<b>kg</b>	112		112		112		112		169		174		363			
<b>3 boxes/ bultos</b> <b>m3</b>	1,89		1,89		1,89		1,89		1'89		8'38		2'13			
<b>4000x1500</b>	<b>ME5594</b>	4.449	408	<b>ME5596</b>	2.993	<b>ME5598</b>	5.916	<b>ME5600</b>	6.250	<b>ME5602</b>	7.771	<b>ME5604</b>	5.382	<b>ME5750</b>	5.939	
<b>kg</b>	125		126		126		126		190		196		379			
<b>3 boxes/ bultos</b> <b>m3</b>	2,01		2,01		2,01		2,01		2'01		9'28		2'25			
<b>4500x1500</b>	<b>ME5605</b>	4.552	459	<b>ME5607</b>	3.154	<b>ME5609</b>	5.985	<b>ME5611</b>	6.354	<b>ME5613</b>	8.360	<b>ME5615</b>	5.493	<b>ME5751</b>	6.382	
<b>kg</b>	138		139		139		139		212		218		395			
<b>3 boxes/ bultos</b> <b>m3</b>	2,13		2,13		2,13		2,13		2'13		10'18		2'41			
<b>5000x1500</b>	<b>ME5606</b>	4.623	510	<b>ME5608</b>	3.274	<b>ME5610</b>	6.043	<b>ME5612</b>	6.445	<b>ME5614</b>	9.084	<b>ME5616</b>	5.900	<b>ME5752</b>	6.721	
<b>kg</b>	151		152		152		152		233		240		412			
<b>3 boxes/ bultos</b> <b>m3</b>	2,25		2,25		2,25		2,25		2'25		11'08		2'51			

\*Maximum width 1440 mm Ancho máximo 1440 mm

Amount of sand:  
Cantidad de arena

Table height / Altura de mesa 650						
Top measures Medidas sobre	Table top / Sobre					
	Linoleum Linóleo		Ultra-matte Ultramate		Ultra-matte TP Ultramate TP	
	Ref.	€	Ref.	€	Ref.	€
<b>3500x1500</b>	<b>ME5905</b>	6.500	<b>ME5919</b>	7.094	<b>ME5933</b>	7.038
<b>kg</b>	348		348		348	
<b>3 boxes/ bultos</b> <b>m3</b>	1,89		1,89		1,89	
<b>4000x1500</b>	<b>ME5906</b>	6.533	<b>ME5920</b>	7.124	<b>ME5934</b>	7.110
<b>kg</b>	364		364		364	
<b>3 boxes/ bultos</b> <b>m3</b>	2,01		2,01		2,01	
<b>4500x1500</b>	<b>ME5907</b>	6.600	<b>ME5921</b>	7.190	<b>ME5935</b>	7.215
<b>kg</b>	381		381		381	
<b>3 boxes/ bultos</b> <b>m3</b>	2,13		2,13		2,13	
<b>5000x1500</b>	<b>ME5908</b>	6.656	<b>ME5922</b>	7.249	<b>ME5936</b>	7.315
<b>kg</b>	398		398		398	
<b>3 boxes/ bultos</b> <b>m3</b>	2,25		2,25		2,25	

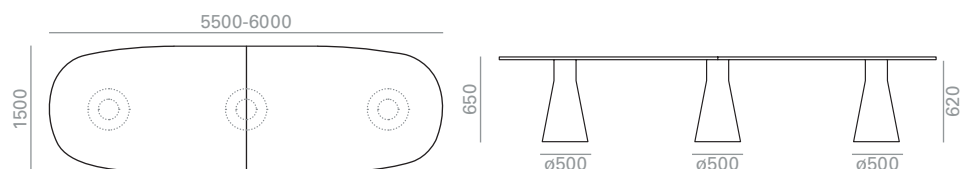

Incremento por base laca brillo  
Upcharge for bright lacquered finish bases. | 969 |



Height adjustable glides up charget  
Incremento por tacos reguladores | 171 |

Table height / Altura de mesa 650															
Top measures Medidas sobre	Table top / Sobre													Top & Base	
	Oak Roble		s600	Lacquered Lacado		Laminate Laminado		Laminate TP Laminado TP		*Top Technical Stone 8		Low Iron Glass Cristal óptico		Cement Cemento	
	Ref.	€	€	Ref.	€	Ref.	€	Ref.	€	Ref.	€	Ref.	€	Ref.	€
5500x1500	ME5617	5.799	561	ME5619	3.575	ME5621	6.128	ME5623	6.563	ME5625	9.631	ME5627	6.349	ME5753	7.754
kg	168		169		169		169		258		266		428		
3 boxes/ bultos m3	2,41		2,41		2,41		2,41		2'41		12'45		2'41		
6000x1500	ME5618	5.873	612	ME5620	3.696	ME5622	8.174	ME5624	8.625	ME5626	10.359	ME5628	7.053	ME5754	8.022
kg	181		183		183		183		280		287		444		
3 boxes/ bultos m3	2,51		2,51		2,51		2,51		2'51		13'39		2'51		

\*Maximum width 1440 mm Ancho máximo 1440 mm  
Amount of sand: Cantidad de arena

Table height / Altura de mesa 650						
Top measures Medidas sobre	Table top / Sobre					
	Linoleum Linóleo		Ultra-matte Ultramate		Ultra-matte TP Ultramate TP	
	Ref.	€	Ref.	€	Ref.	€
5500x1500	ME5909	6.734	ME5923	7.991	ME5937	7.442
kg	415		415		415	
3 boxes/ bultos m3	2,41		2,41		2,41	
6000x1500	ME5910	9.147	ME5924	10.036	ME5938	9.967
kg	431		431		431	
3 boxes/ bultos m3	2,51		2,51		2,51	

## Maximum table heights Alturas máximas de mesa

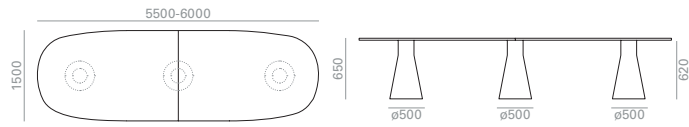
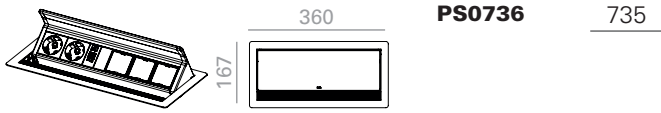
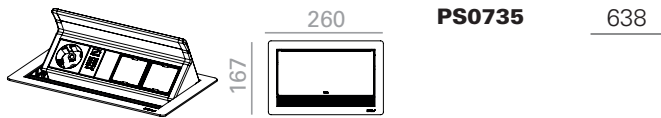

Table top				
Oak Roble	Lacquered Lacado	Laminate Laminado	LaminateTP LaminadoTP	*Top Technical Stone 8
650	650	650	650	670

Table top				
Low Iron Glass Cristal óptico	Cement Cemento	Linoleum Linóleo	Ultra-matte Ultramate	Ultra-matteTP UltramateTP
667		650	650	650



## PS-IN SURFACE



## PS-QI



## Preinstalled (Optional) / Preinstalación (Opcional) IN0006

First installation / Primera instalación	270
Second and more installations / Segunda y más instalaciones	90

## PS-UNDERTOP

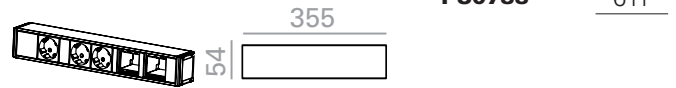
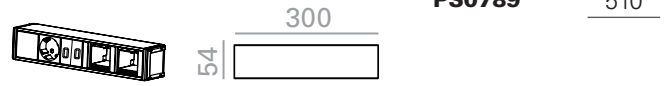

## PS-INTREGATED

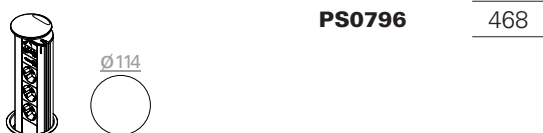
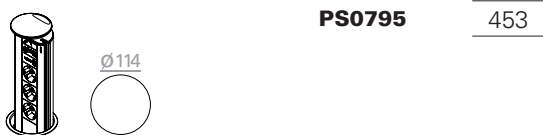
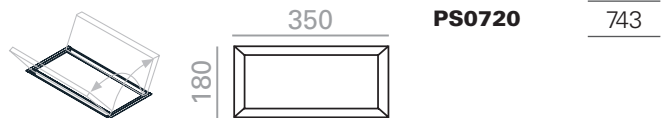
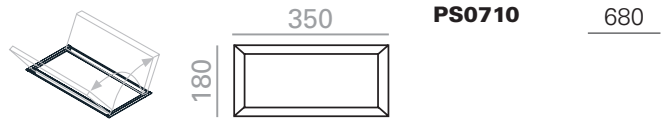

**IN-SURFACE POWER BOXES  
CAJAS DE CONEXIONES DENTRO DEL SOBRE**

Aluminum power box mounted in the table top with a folding protective lid. It is served in anodized silver, black or white, for other finishing, contact the Customer Department. There are two power system sizes available and data slots can be customized according to the below diagram. For lifting base versions contact the Customer Department.

Caja de conexiones de aluminio integrada dentro de la superficie del sobre con tapa abatible, disponible para cualquier modelo de mesa Reverse. Para versiones de bases elevables consultar al Departamento Comercial. Se sirve en color anodizado plata, negro o blanco, para otros acabados consultar al Departamento Comercial. Se ofrecen dos tamaños de caja diferentes y con conectividad configurable, acorde al siguiente esquema:

**PS0735**



**PS0736**

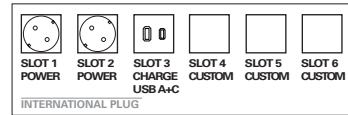
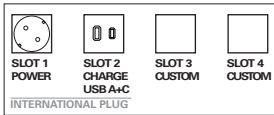

CHOOSE DATA PORT FOR DATA CUSTOM PORT SLOTS

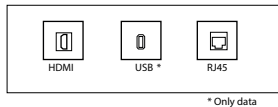

**OPTIONAL PREINSTALLED WIRING  
PREINSTALACIÓN DEL CABLEADO**

**IN0006**

Preinstalled wiring consists in the addition of the necessary mechanisms to integrate power systems in the table, so that wiring is hidden until the way out in the floor. Necessary grommet are included and 3m cable (from the power system). For other cable dimensions contact the Customer Department. Tables with only one base are exempt of this charge, for the rest of tables ask the Customer Department.

La preinstalación consiste en el montaje de los mecanismos necesarios para integrar el sistema de electrificación en la mesa, de modo que el cableado quede oculto hasta su salida por la base. Se incluyen los pasacables necesarios y 3 metros de cable (midiendo desde el sistema de conexiones). Las mesas de una sola base quedan exentas de este cargo, para el resto consultar al Departamento Comercial.

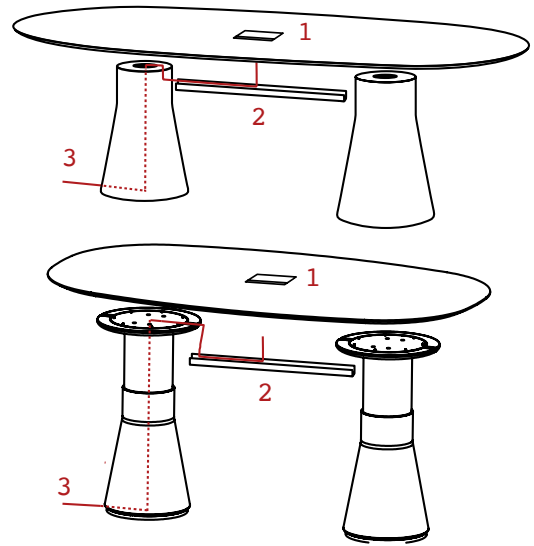

**1 POWER BOXES DISTRIBUTION DISTRIBUCIÓN DE SISTEMAS**

In tables with only one Reverse base power box can't be centered with the base. In tables with more than one base, by default power box is placed in the center of the table and in lengthwise direction. If more than one power box is installed, inform the Customer Department about the desired position.

En mesas con una sola base el sistema eléctrico iría instalado descentrado respecto a la base. En mesas con más de una base, por defecto la posición del sistema irá en el centro de la mesa y en sentido longitudinal. Si se solicita más de un sistema eléctrico, comunicar la posición deseada al Departamento Comercial.

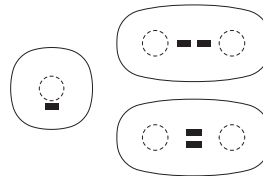

**2 WIRING MANAGEMENT GESTIÓN DEL CABLEADO**

Wire pass through an aluminum grommet keeping it hidden. By default color is silver, for other finishings ask the Customer Department.

El cable se pasa a través de un perfil pasacables de aluminio que lo mantiene oculto. Su color de serie es el plata, para otros acabados consultar al Departamento Comercial.

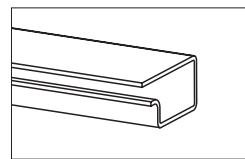

**3 CABLE WAY OUT SALIDA DE CABLEADO**

The cable way out can be performed directly from the power system or thru a canal in the base bottom, so that is hidden until it gets to the floor.

La salida del cable se realiza directamente desde el propio sistema como por unas canalizaciones en la parte inferior de la base, de modo que el cable queda oculto hasta llegar al suelo.

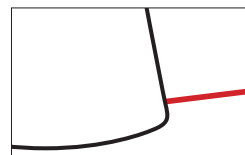

**IN-SURFACE POWER BOXES  
CAJAS DE CONEXIONES DENTRO DEL SOBRE**

It is a data dynamo with 2 amp dual charging USB. Available in two finishes: black or white. For lifting base versions contact the Customer Department.

Es una dínamo de datos con 2 amp de carga dual USB. Disponible en dos acabados: negro o blanco. Para versiones de bases elevables consultar al Departamento Comercial.

**PS0804**

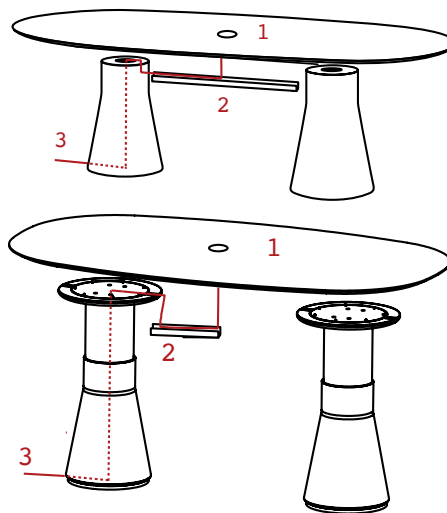
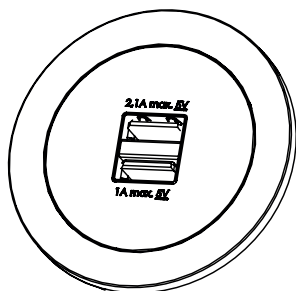

**1 POWER BOXES DISTRIBUTION DISTRIBUCIÓN DE SISTEMAS**

In tables with only one Reverse base power box can't be centered with the base. In tables with more than one base, by default power box is placed in the center of the table and in lengthwise direction. If more than one power box is installed, inform the Customer Department about the desired position.

En mesas con más de una base, por defecto la posición del sistema irá en el centro de la mesa y en sentido longitudinal. Si se solicita más de un sistema eléctrico, comunicar la posición deseada al Departamento Comercial.

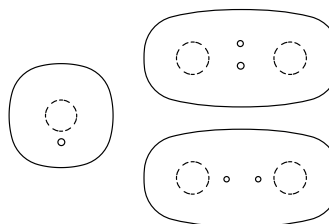

**OPTIONAL PREINSTALLED WIRING  
PREINSTALACIÓN DEL CABLEADO**

**IN0006**

Preinstalled wiring consists in the addition of the necessary mechanisms to integrate power systems in the table, so that wiring is hidden until the way out in the floor. Necessary grommet are included and 3m cable (from the power system). For other cable dimensions contact the Sales Department. For each wire Reverse base, you must ask for one IN0006 to the Customer Department.

La preinstalación consiste en el montaje de los mecanismos necesarios para integrar el sistema de electrificación en la mesa, de modo que el cableado quede oculto hasta su salida por la base. Se incluyen los pasacables necesarios y 3 metros de cable (midiéndolo desde el sistema de conexiones). Por cada base por al que se desee bajar el cable se solicita un IN0006 al Departamento Comercial.

**2 WIRING MANAGEMENT GESTIÓN DEL CABLEADO**

Wire pass through an aluminum grommet keeping it hidden. By default color is silver, for other finishings ask the Customer Department.

El cable se pasa a través de un perfil pasacables de aluminio que lo mantiene oculto. Su color de serie es el plata, para otros acabados consultar al Departamento Comercial.

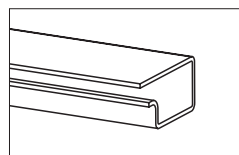

**3 CABLE WAY OUT SALIDA DE CABLEADO**

The cable way out can be performed directly from the power system or thru a canal in the base bottom, so that is hidden until it gets to the floor.

La salida del cable se realiza directamente desde el propio sistema como por unas canalizaciones en la parte inferior de la base, de modo que el cable queda oculto hasta llegar al suelo.

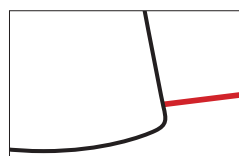

**QI CHARGING POWER BOXES  
CAJAS DE CONEXIONES QI**

The inductive charging station, allows maximum larger contact surface. Available in two finish: black or white. For lifting base versions contact the Customer Department.

La estación de carga inductiva permite una superficie de contacto máxima más grande. Disponible en dos acabados: negro o blanco. Para versiones de bases elevables consultar al Departamento Comercial.

PS0714

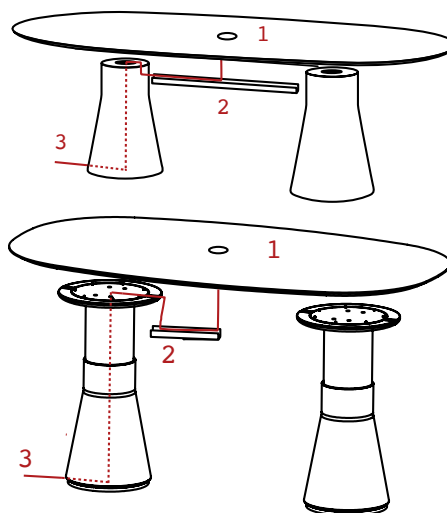
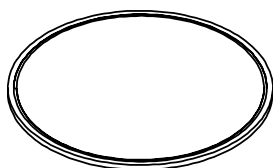

**1 POWER BOXES DISTRIBUTION DISTRIBUCIÓN DE SISTEMAS**

In tables with only one Reverse base power box can't be centered with the base. In tables with more than one base, by default power box is placed in the center of the table and in lengthwise direction. If more than one power box is installed, inform the Customer Department about the desired position.

En mesas con una sola base el sistema eléctrico iría instalado descentrado respecto a la base. En mesas con más de una base, por defecto la posición del sistema irá en el centro de la mesa y en sentido longitudinal. Si se solicita más de un sistema eléctrico, comunicar la posición deseada al Departamento Comercial.

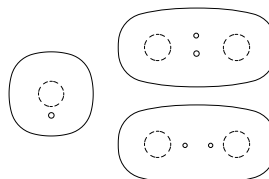

**2 WIRING MANAGEMENT GESTIÓN DEL CABLEADO**

Wire pass through an aluminum grommet keeping it hidden. By default color is silver, for other finishings ask the Customer Department.

El cable se pasa a través de un perfil pasacables de aluminio que lo mantiene oculto. Su color de serie es el plata, para otros acabados consultar al Departamento Comercial.

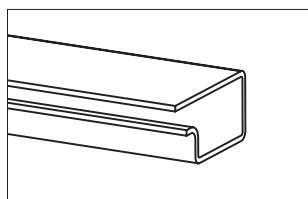

**OPTIONAL PREINSTALLED WIRING  
PREINSTALACIÓN DEL CABLEADO**

IN0006

Preinstalled wiring consists in the addition of the necessary mechanisms to integrate power systems in the table, so that wiring is hidden until the way out in the floor. Necessary grommet are included and 3m cable (from the power system). For other cable dimensions contact the Sales Department. For each wire Reverse base, you must ask for one IN0006 to the Customer Department.

La preinstalación consiste en el montaje de los mecanismos necesarios para integrar el sistema de electrificación en la mesa, de modo que el cableado quede oculto hasta su salida por la base. Se incluyen los pasacables necesarios y 3 metros de cable (midiendo desde el sistema de conexiones). Por cada base por al que se desee bajar el cable se solicita un IN0006 al Departamento Comercial.

**3 CABLE WAY OUT SALIDA DE CABLEADO**

The cable way out can be performed directly from the power system or thru a canal in the base bottom, so that is hidden until it gets to the floor.

La salida del cable se realiza directamente desde el propio sistema como por unas canalizaciones en la parte inferior de la base, de modo que el cable queda oculto hasta llegar al suelo.

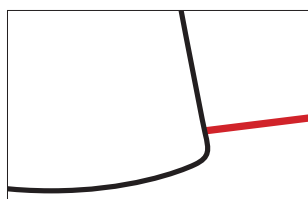

**INTEGRATED POWER BOXES  
CAJAS DE CONEXIONES INTEGRADAS**

The black finish is integrated with the top. Its opening is towards both sides. For lifting base versions contact the Customer Department.

El acabado negro está integrado con la parte superior. Su apertura es hacia ambos lados. Para versiones de bases elevables consultar al Departamento Comercial.

**PS0710**

**PS0720**

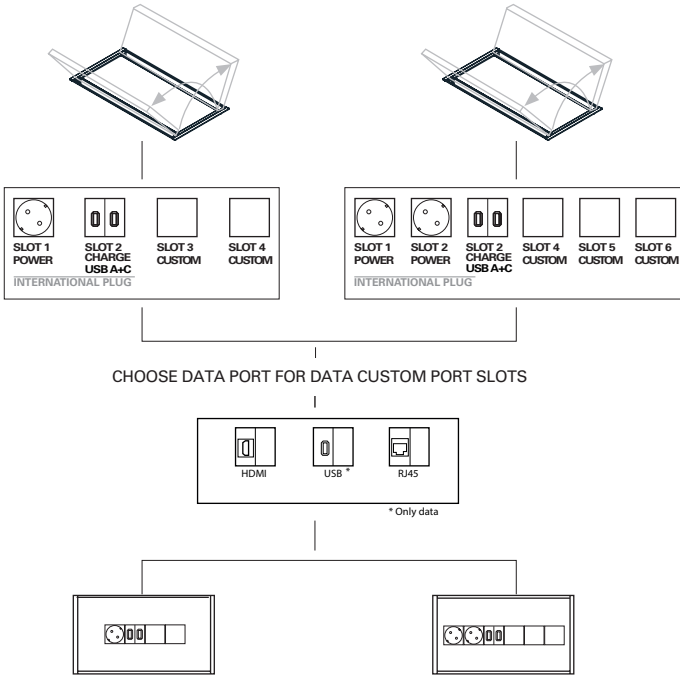

CHOOSE DATA PORT FOR DATA CUSTOM PORT SLOTS

\* Only data

**OPTIONAL PREINSTALLED WIRING  
PREINSTALACIÓN DEL CABLEADO**

**IN0006**

Preinstalled wiring consists in the addition of the necessary mechanisms to integrate power systems in the table, so that wiring is hidden until the way out in the floor. Necessary grommet are included and 3m cable (from the power system). For other cable dimensions contact the Sales Department. For each wire Reverse base, you must ask for one IN0006 to the Customer Department.

La preinstalación consiste en el montaje de los mecanismos necesarios para integrar el sistema de electrificación en la mesa, de modo que el cableado quede oculto hasta su salida por la base. Se incluyen los pasacables necesarios y 3 metros de cable (midiendo desde el sistema de conexiones). Por cada base por al que se desee bajar el cable se solicita un IN0006 al Departamento Comercial.

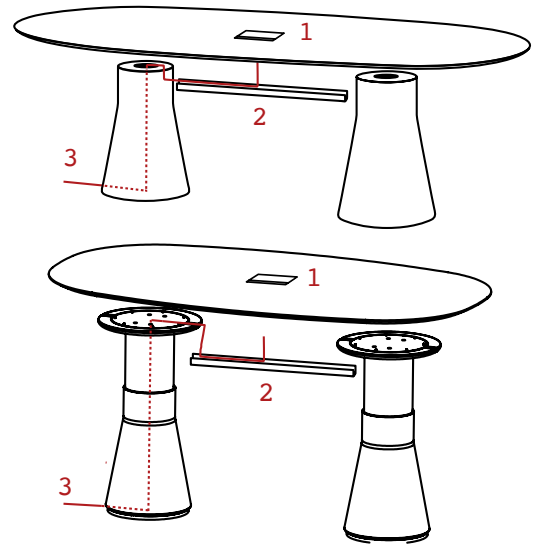

**1 POWER BOXES DISTRIBUTION DISTRIBUCIÓN DE SISTEMAS**

In tables with only one Reverse base power box can't be centered with the base. In tables with more than one base, by default power box is placed in the center of the table and in lengthwise direction. If more than one power box is installed, inform the Customer Department about the desired position.

En mesas con una sola base el sistema eléctrico iría instalado descentrado respecto a la base. En mesas con más de una base, por defecto la posición del sistema irá en el centro de la mesa y en sentido longitudinal. Si se solicita más de un sistema eléctrico, comunicar la posición deseada al Departamento Comercial.

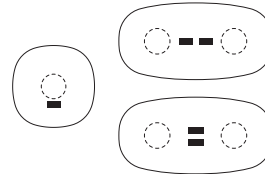

**2 WIRING MANAGEMENT GESTIÓN DEL CABLEADO**

Wire pass through an aluminum grommet keeping it hidden. By default color is silver, for other finishings ask the Customer Department.

El cable se pasa a través de un perfil pasacables de aluminio que lo mantiene oculto. Su color de serie es el plata, para otros acabados consultar al Departamento Comercial.

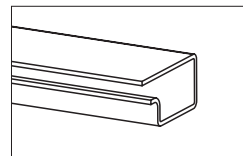

**3 CABLE WAY OUT SALIDA DE CABLEADO**

The cable way out can be performed directly from the power system or thru a canal in the base bottom, so that is hidden until it gets to the floor.

La salida del cable se realiza directamente desde el propio sistema como por unas canalizaciones en la parte inferior de la base, de modo que el cable queda oculto hasta llegar al suelo.

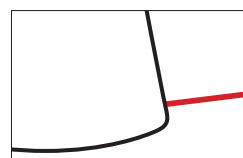

**UNDER-TOP POWER BOXES  
CAJA DE CONEXIONES BAJO EL SOBRE**

Power box mounted under the table top. Available in black or white color (silver or black in USA), for other finishing, contact the Customer Department. There are two power system sizes available and data slots can be customized according to the below diagram.

Regleta de conexiones bajo la superficie del sobre. Se sirve en color negro o blanco (plata o negro en USA. Para otros acabados consultar al departamento comercial. Se ofrecen formatos de caja de dos tamaños de caja diferentes y con opciones de conectividad configurable. Para versiones de bases elevables consultar al Departamento Comercial.

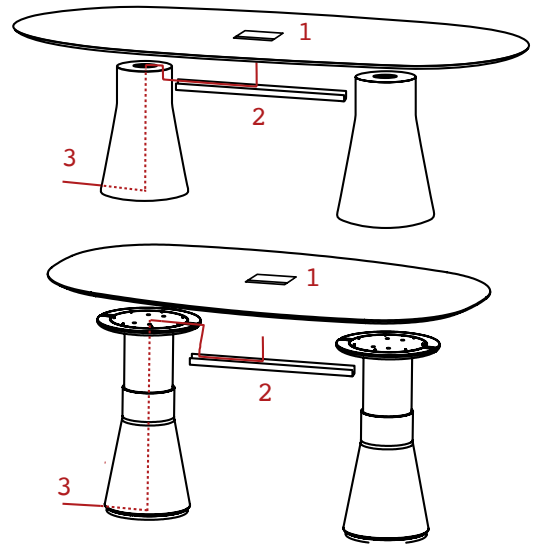

**1 POWER BOXES DISTRIBUTION DISTRIBUCIÓN DE SISTEMAS**

In tables with only one Reverse base power box can't be centered with the base. In tables with more than one base, by default power box is placed in the center of the table and in lengthwise direction. If more than one power box is installed, inform the Customer Department about the desired position.

En mesas con una sola base el sistema eléctrico iría instalado descentrado respecto a la base. En mesas con más de una base, por defecto la posición del sistema irá en el centro de la mesa y en sentido longitudinal. Si se solicita más de un sistema eléctrico, comunicar la posición deseada al Departamento Comercial.

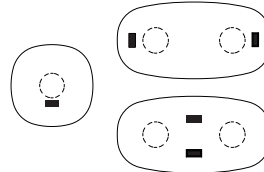

**2 WIRING MANAGEMENT GESTIÓN DEL CABLEADO**

Wire pass through an aluminum grommet keeping it hidden. By default color is silver, for other finishings ask the Customer Department.

El cable se pasa a través de un perfil pasacables de aluminio que lo mantiene oculto. Su color de serie es el plata, para otros acabados consultar al Departamento Comercial.

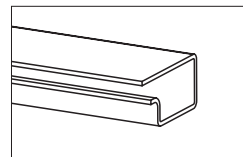

**3 CABLE WAY OUT SALIDA DE CABLEADO**

The cable way out can be performed directly from the power system or thru a canal in the base bottom, so that is hidden until it gets to the floor.

La salida del cable se realiza directamente desde el propio sistema como por unas canalizaciones en la parte inferior de la base, de modo que el cable queda oculto hasta llegar al suelo.

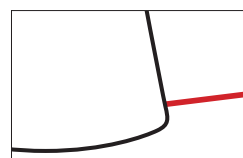

**PS0787**

**PS0788**

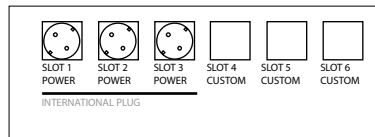
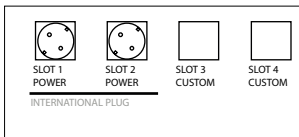
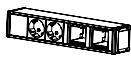

CHOOSE DATA PORT FOR DATA CUSTOM PORT SLOTS

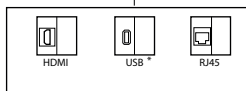

\* Only data

**PS0789**

**PS0790**

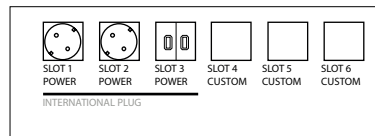
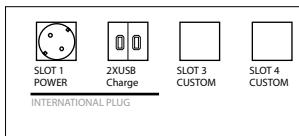

CHOOSE DATA PORT FOR DATA CUSTOM PORT SLOTS

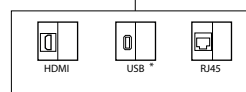

\* Only data

**OPTIONAL PREINSTALLED WIRING  
PREINSTALACIÓN DEL CABLEADO**

**IN0006**

Preinstalled wiring consists in the addition of the necessary mechanisms to integrate power systems in the table, so that wiring is hidden until the way out in the floor. Necessary grommet are included and 3m cable (from the power system). For other cable dimensions contact the Sales Department. For each wire Reverse base, you must ask for one IN0006 to the Customer Department.

La preinstalación consiste en el montaje de los mecanismos necesarios para integrar el sistema de electrificación en la mesa, de modo que el cableado quede oculto hasta su salida por la base. Se incluyen los pasacables necesarios y 3 metros de cable (midiendo desde el sistema de conexiones). Por cada base por al que se desee bajar el cable se solicita un IN0006 al Departamento Comercial.

**IN-SURFACE SOCKET POWERS  
TORRES DE CONEXIONES DENTRO DEL SOBRE**

Socket tower mounted in the table top. The hidden system manually rises with a slight push. Valid for Reverse tables with bases Reverse 38, 50 and 60. For lifting base versions contact the Customer Department. Available in silver, white or black color, for for other finishing, contact the Customer Department.

Torre de conexiones integrada dentro de la superficie del sobre. El sistema eléctrico oculto se alza manualmente al pulsarlo. Disponible mesas Reverse con bases Reverse 38, 50 y 60. Para versiones de bases elevables consultar al Departamento Comercial. Disponible en color plata, blanco o negro, para otros acabados consultar al Departamento Comercial.

**PS0795**

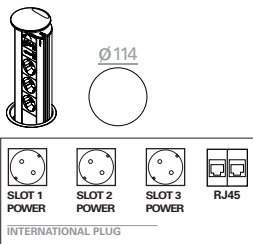

**PS0796**

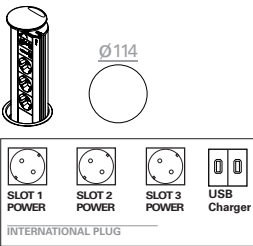

**OPTIONAL PREINSTALLED WIRING  
PREINSTALACIÓN DEL CABLEADO**

**IN0006**

Preinstalled wiring consists in the addition of the necessary mechanisms to integrate power systems in the table, so that wiring is hidden until the way out in the floor. Necessary grommet are included and 3m cable (from the power system). For other cable dimensions contact the Sales Department. For each wire Reverse base, you must ask for une IN0006 to the Customer Department.

La preinstalación consiste en el montaje de los mecanismos necesarios para integrar el sistema de electrificación en la mesa, de modo que el cableado quede oculto hasta su salida por la base. Se incluyen los pasacables necesarios y 3 metros de cable (midiendo desde el sistema de conexiones). Por cada base por al que se desee bajar el cable se solicita un IN0006 al Departamento Comercial.

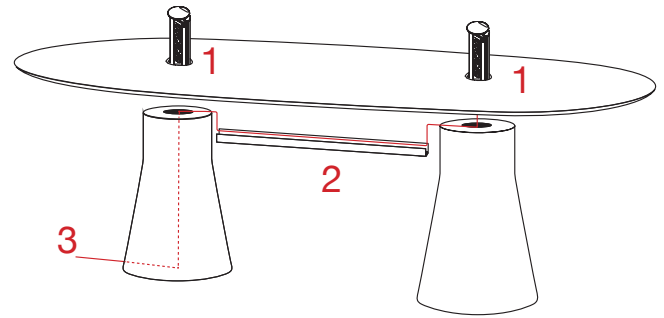

**1 POWER BOXES DISTRIBUTION DISTRIBUCIÓN DE SISTEMAS**

In tables with only one Reverse base power box can't be centered with the base. In tables with more than one base, by default power box is placed in the center of the table and in lengthwise direction. If more than one power box is installed, inform the Customer Department about the desired position.

En mesas con más de una base, por defecto la posición del sistema irá en el centro de la mesa y en sentido longitudinal. Si se solicita más de un sistema eléctrico, comunicar la posición deseada al Departamento Comercial.



**2 WIRING MANAGEMENT GESTIÓN DEL CABLEADO**

Wire pass through an aluminum grommet keeping it hidden. By default color is silver, for other finishings ask the Customer Department.

El cable se pasa a través de un perfil pasacables de aluminio que lo mantiene oculto. Su color de serie es el plata, para otros acabados consultar al Departamento Comercial.

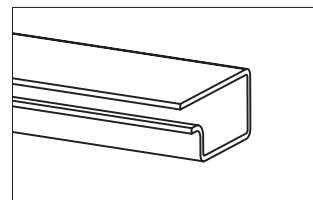

**3 CABLE WAY OUT SALIDA DE CABLEADO**

The cable way out can be performed directly from the power system or thru a canal in the base bottom, so that is hidden until it gets to the floor.

La salida del cable se realiza directamente desde el propio sistema como por unas canalizaciones en la parte inferior de la base, de modo que el cable queda oculto hasta llegar al suelo.

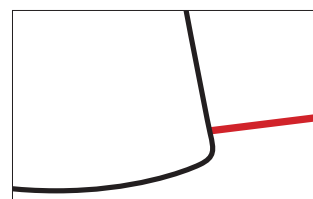











**Description**  
**Descripción**

Table program with central base and top in ash, available swivel centre top in marble, lacquered wood or Technical Stone 8. Round tops only version, in 3 sizes. Connection box available. \*If the top is electrified, the swivel centre top will be fixed.

Programa de mesas disponible con bases centrales y sobros de madera de fresno con opción de plato giratorio central en diferentes acabados, mármol, madera lacada o Technical Stone 8 Stone. Sobre sólo redondo, en tres medidas. Disponible caja de conexiones

**Wood finish Ash**  
**Acabado madera Fresno**



**Wood lacquer finish**  
**Acabado lacas madera**



**Technical Stone 8 finish**  
**Acabado Technical Stone 8**

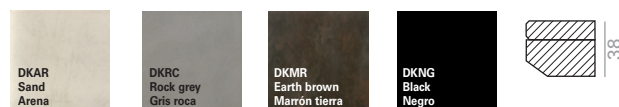

**M2 marble finish**  
**Acabado de mármol M2**

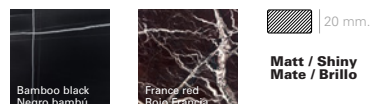

**M1 marble finish**  
**Acabado de mármol M1**

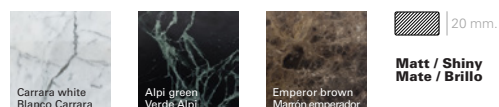

**M3 marble finish**  
**Acabado de mármol M3**

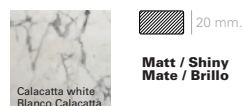

**Intellectual property Propiedad intelectual**

All our collections are protected by international industrial design registries, designs patents, copyrights and intellectual Property laws. Unauthorized use of AW International Property is a criminal offence and can lead to prosecution. Todas nuestras colecciones están protegidas por registros de diseño industrial, diseño de patente, copyright y derechos de propiedad intelectual en todo el mundo. El uso no autorizado de los diseños y propiedad intelectual de AW supone un delito que puede ser sometido a acción judicial.



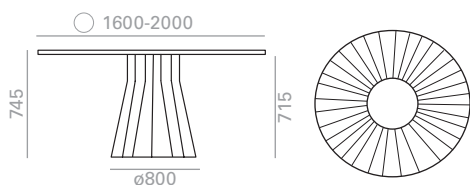

\*\*\*Marble shiny upcharge  
Incremento por mármol brillo

| 30 |

\*If the top is electrified, the center will be fixed.  
Si el sobre está electrificado, el centro será fijo.

Table top/ Sobre										
Top measures Medidas sobre	Ash/ Fresno *Centre Top/ Centro sobre									
	Lacquered Lacado		Top Technical Stone 8		***Marble M3 Mármol M3		***Marble M2 Mármol M2		***Marble M1 Mármol M1	
	Ref.	€	Ref.	€	Ref.	€	Ref.	€	Ref.	€
ø1600	ME9951	5.932	ME9952	6.418	ME9953	7.425	ME9954	6.717	ME9955	6.468
kg	140		140		140		140		140	
3 boxes/ bultos  m3	1,32		1,32		1,32		1,32		1'32	
ø1800	ME9957	6.244	ME9958	6.722	ME9959	7.849	ME9960	7.141	ME9961	6.894
kg	150		150		150		150		150	
3 boxes/ bultos  m3	1,44		1,44		1,44		1,44		1'44	
ø2000	ME9963	6.681	ME9964	7.159	ME9965	8.301	ME9966	7.576	ME9967	7.329
kg	160		160		160		160		160	
3 boxes/ bultos  m3	1,58		1,58		1,58		1,58		1'58	

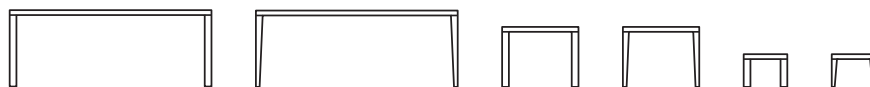

**Description**  
**Descripción**

Collection of table tops made of maple veneer and solid beech legs available in three heights. Can be combined with any model from our Top SP 40 collection.

Sistema de sobres de mesa chapados en arce con cantos macizos y estructura de patas de madera maciza de haya en tres alturas. Permite diferentes combinaciones. Combinables con sobres de mesa de la colección Top SP 40.

**Wood finish Beech**  
**Acabado madera Haya**



**Wood lacquer finish**  
**Acabado lacas madera**



**Laminated**  
**Laminado**

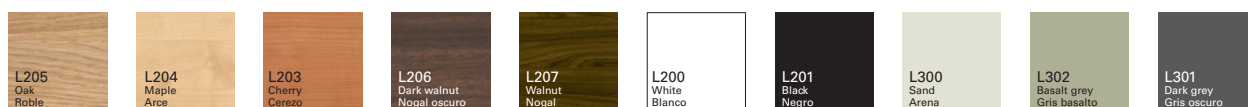

**Ultra-matte finish**  
**Acabado ultramate**



**Legs**  
**Patatas**



Set (4 units) of 300 mm, 550 mm or 700 mm high. Aluminum fitting to join legs with top included.

Juego (4 unidades) de 300 mm, 550 mm o 700 mm altura. Incluye herraje de aluminio para unir pies con sobre.

**Intellectual property Propiedad intelectual**

All our collections are protected by international industrial design registries, designs patents, copyrights and intellectual Property laws. Unauthorized use of AW International Property is a criminal offence and can lead to prosecution.  
Todas nuestras colecciones están protegidas por registros de diseño industrial, diseño de patente, copyright y derechos de propiedad intelectual en todo el mundo. El uso no autorizado de los diseños y propiedad intelectual de AW supone un delito que puede ser sometido a acción judicial.











40 mm thick maple table top.





Sobre de mesa de arce de 40 mm de espesor.

Edge / Perfil



	 1		Ultra-matte Ultramate		Laminate Laminado		Lacquered Lacado		Maple Arce		S600
	 m3	 kg	SB7540	198	SB7568	166	SB7225	192	SB7138	207	
400x400	0,03	6	SB7540	198	SB7568	166	SB7225	192	SB7138	207	65
600x600	0,04	13	SB7541	268	SB7569	214	SB7226	223	SB7139	255	90
700x700	0,06	17	SB7542	350	SB7570	250	SB7227	261	SB7140	297	96
800x800	0,08	23	SB7543	411	SB7571	301	SB7228	312	SB7141	353	102
900x900	0,1	25	SB7544	480	SB7572	352	SB7229	365	SB7145	412	110
1000x1000	0,12	33	SB7549	612	SB7577	470	SB7230	490	SB7158	546	119
1100x1100	0,14	33	SB7550	648	SB7578	482	SB7231	510	SB7220	564	129
1200x1200	0,17	39	SB7551	762	SB7579	569	SB7232	610	SB7221	668	141
1300x1300	0,2	46	SB7552	929	SB7580	695	SB7233	730	SB7222	816	152
1400x1400	0,24	53	SB7553	1.053	SB7581	783	SB7234	838	SB7223	923	162
1500x1500	0,27	61	SB7554	1.197	SB7582	889	SB7235	962	SB7224	1.049	228

	 1		Ultra-matte Ultramate		Laminate Laminado		Lacquered Lacado		Maple Arce		S600
	 m3	 kg	SB7555	278	SB7583	221	SB7240	238	SB7320	270	
ø600	0,04	12	SB7555	278	SB7583	221	SB7240	238	SB7320	270	90
ø700	0,06	15	SB7556	380	SB7584	261	SB7241	276	SB7321	311	96
ø800	0,08	20	SB7557	447	SB7585	320	SB7242	334	SB7322	378	102
ø900	0,1	21	SB7558	494	SB7586	370	SB7243	385	SB7323	436	110
ø1000	0,12	30	SB7559	634	SB7587	489	SB7244	520	SB7324	582	119
ø1100	0,14	27	SB7560	700	SB7588	531	SB7245	568	SB7236	626	129
ø1200	0,17	38	SB7561	868	SB7589	667	SB7246	632	SB7325	722	141
ø1300	0,2	36	SB7562	1.034	SB7590	794	SB7247	743	SB7237	862	152
ø1400	0,24	42	SB7563	1.095	SB7591	826	SB7248	864	SB7238	963	162
ø1500	0,27	48	SB7564	1.255	SB7592	947	SB7249	990	SB7239	1.105	228

	 1		Ultra-matte Ultramate		Laminate Laminado		Lacquered Lacado		Maple Arce		S600
	 m3	 kg	SB7565	302	SB7593	239	SB7254	247	SB7365	285	
700x600	0,07	14	SB7565	302	SB7593	239	SB7254	247	SB7365	285	96
800x600	0,08	22	SB7566	345	SB7594	276	SB7255	277	SB7366	326	102
800x700	0,09	23	SB7567	371	SB7595	290	SB7256	293	SB7367	344	102
1200x700	0,12	25	SB7545	534	SB7573	413	SB7250	426	SB7147	488	122
1500x900	0,07	41	SB7546	770	SB7574	584	SB7251	597	SB7148	680	141
1850x900	0,23	46	SB7547	936	SB7575	708	SB7252	730	SB7149	825	167
2000x1000	0,28	58	SB7548	1.098	SB7576	823	SB7253	838	SB7150	960	198

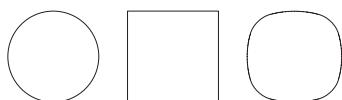

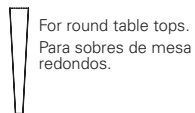

For round table tops.  
Para sobres de mesa  
redondos.



For square or rectangular  
table tops.  
Para sobres de mesas  
rectangulares o cuadrados.

	1 m3 kg		Lacquered Lacado		Beech Haya		S600
300	0,01	3	<b>BM7176</b>	336	<b>BM7164</b>	318	42
550	0,02	4	<b>BM7177</b>	387	<b>BM7163</b>	366	45
700	0,03	6	<b>BM7178</b>	476	<b>BM7162</b>	446	51

	1 m3 kg		Lacquered Lacado		Beech Haya		S600
300	0,01	3	<b>BM7179</b>	340	<b>BM7167</b>	323	42
550	0,02	4	<b>BM7180</b>	366	<b>BM7166</b>	345	45
700	0,03	6	<b>BM7181</b>	439	<b>BM7165</b>	416	51

	1 m3 kg		Lacquered Lacado		Beech Haya		S600
300	0,01	3	<b>BM7182</b>	324	<b>BM7217</b>	303	42
550	0,02	4	<b>BM7183</b>	368	<b>BM7216</b>	343	45
700	0,03	6	<b>BM7184</b>	425	<b>BM7215</b>	396	51





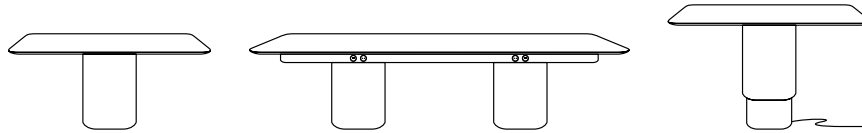

**Description**  
**Descripción**

Table program available with different types of bases and table tops. Pure Eco thermo-polymer (100% recycled) bases available in several colors and gloss lacquer option. Table tops in several shapes and sizes available in various finishes.

Programa de mesas disponible con diferentes tipos de bases y sobres de mesa. Bases de termopolimero Pure Eco (100% reciclado) disponible en diferentes colores y opción de laca brillo.

**Wood finish Oak**  
**Acabado madera**  
**Roble**



**Wood lacquer finish**  
**Acabado lacas madera**



**Laminated**  
**Laminado**



**Laminated TP**  
**Laminado TP**

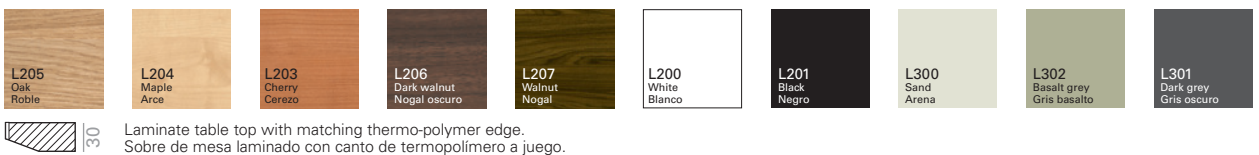

**Technical Stone 8 finish**  
**Acabado Technical**  
**Stone 8**

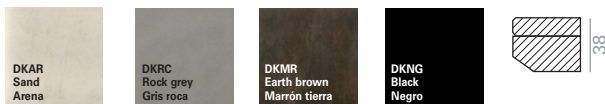

**Glass finish**  
**Acabado de cristal**



**Ultra-matte finish**  
**Acabado ultramate**

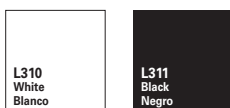

**Linoleum finish**  
**Acabado linóleo**

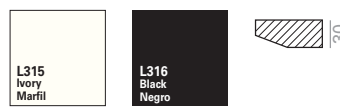

**M1 marble finish**  
**Acabado de mármol**  
**M1**

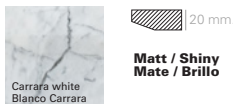

**M3 marble finish**  
**Acabado de mármol**  
**M3**



**Cement finish**  
**Acabado cemento**



**Pure Eco Thermo-polymer finish**  
**Acabado de Termopolimero Pure Eco**



**Intellectual property Propiedad intelectual**

All our collections are protected by international industrial design registries, designs patents, copyrights and intellectual Property laws. Unauthorized use of AW International Property is a criminal offence and can lead to prosecution. Todas nuestras colecciones están protegidas por registros de diseño industrial, diseño de patente, copyright y derechos de propiedad intelectual todo el mundo. El uso no autorizado de los diseños y propiedad intelectual de AW supone un delito que puede ser sometido a acción judicial.



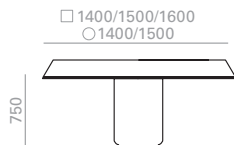

Height adjustable  
glides up charge  
Incremento por tacos  
reguladores

| 57 |

\*\*\*Marble shiny  
upcharge  
Incremento por  
mármol brillo

| 30 |

Column height / Altura columna															
Top measures Medidas sobre	Table top / Sobre												Top & Base		
	Oak Roble		s600	Lacquered Lacado		Laminate Laminado		Laminate TP Laminado Tp		Top Technical Stone 8		Low Iron Glass Cristal óptico		Cement Cemento	
	Ref.	€	€	Ref.	€	Ref.	€	Ref.	€	Ref.	€	Ref.	€	Ref.	€
<b>1400x1400</b>	<b>ME03000</b>	1.344	156	<b>ME03001</b>	1.381	<b>ME03002</b>	1.901	<b>ME03003</b>	2.886	<b>ME03004</b>	3.277	<b>ME03005</b>	2.263	<b>ME03006</b>	2.181
kg	127		127		127		127		81		81		133		
<b>2 boxes/ bultos</b> m3	0,79		0,79		0,79		0,79		3'29		1'43		0'79		
<b>1500x1500</b>	<b>ME03007</b>	1.349	162	<b>ME03008</b>	1.426	<b>ME03009</b>	1.908	<b>ME03010</b>	2.409	<b>ME03011</b>	3.334	<b>ME03012</b>	2.333	<b>ME03013</b>	2.292
kg	134		134		134		134		92		92		140		
<b>2 boxes/ bultos</b> m3	0,84		0,84		0,84		0,84		3'29		1'56		0'84		
<b>1600x1600</b>	<b>ME03014</b>	1.549	171	<b>ME03015</b>	1.559							<b>ME03019</b>	2.626	<b>ME03020</b>	2.475
kg	141		141								103		148		
<b>2 boxes/ bultos</b> m3	0,9		0,9								1'56		0'9		
<b>ø1400</b>	<b>ME03021</b>	1.353	156	<b>ME03022</b>	1.390	<b>ME03023</b>	1.901	<b>ME03024</b>	2.405	<b>ME03025</b>	3.724	<b>ME03026</b>	2.391	<b>ME03027</b>	2.191
kg	118		118		118		118		65		65		122		
<b>2 boxes/ bultos</b> m3	0,79		0,79		0,79		0,79		2'96		1'43		0'79		
<b>ø1500</b>	<b>ME03028</b>	1.358	162	<b>ME03029</b>	1.437	<b>ME03030</b>	1.901	<b>ME03031</b>	2.409	<b>ME03032</b>	3.780	<b>ME03033</b>	2.497	<b>ME03034</b>	2.303
kg	123		123		123		123		74		74		128		
<b>2 boxes/ bultos</b> m3	0,84		0,84		0,84		0,84		3'29		1'56		0'84		

Amount of sand: 60 kg /  
Cantidad de arena 60 kg

Column height / Altura columna										
Top measures Medidas sobre	Table top / Sobre									
	Linoleum Linoleo		Ultra-matte Ultramate		Ultra-matte TP Ultramate Tp		***Marble M1 Mármol M1		***Marble M3 Mármol M3	
	Ref.	€	Ref.	€	Ref.	€	Ref.	€	Ref.	€
<b>1400x1400</b>	<b>ME03035</b>	2.125	<b>ME03036</b>	2.266	<b>ME03037</b>	2.266	<b>ME03038</b>	3.466	<b>ME03040</b>	6.291
kg	127		127		127		207		207	
<b>2 boxes/ bultos</b> m3	0,79		0,79		0,79		2,96		2'96	
<b>1500x1500</b>	<b>ME03041</b>	2.185	<b>ME03042</b>	2.283	<b>ME03043</b>	2.284	<b>ME03044</b>	3.626	<b>ME03046</b>	6.452
kg	134		134		134		214		214	
<b>2 boxes/ bultos</b> m3	0,84		0,84		0,84		3,29		3'29	
<b>1600x1600</b>							<b>ME03050</b>	4.027	<b>ME03052</b>	7.699
kg							221		221	
<b>2 boxes/ bultos</b> m3							3,64		3'64	
<b>ø1400</b>	<b>ME03053</b>	2.125	<b>ME03054</b>	2.266	<b>ME03055</b>	2.266	<b>ME03056</b>	3.944	<b>ME03058</b>	6.768
kg	118		118		118		198		198	
<b>2 boxes/ bultos</b> m3	0,79		0,79		0,79		2,96		2'96	
<b>ø1500</b>	<b>ME03059</b>	2.185	<b>ME03060</b>	2.283	<b>ME03061</b>	2.284	<b>ME03062</b>	4.139	<b>ME03064</b>	6.963
kg	123		123		123		203		203	
<b>2 boxes/ bultos</b> m3	0,84		0,84		0,84		3,29		3'29	

PSTOP-TECH									
Top measures Medidas sobre									
	Up charge for TOP-TECH Power Box. Incremento por sistema eléctrico TOP-TECH.	Up charge for double USB charge. Installation included. Incremento por doble USB de carga. Instalación incluida.	Up charge for power socket. Installation included. Incremento por toma de alimentación. Instalación incluida.	Incremento por base laca brillo.	Acces panel for wiring up charge. Incremento por panel de acceso para cableado.	Oak base up charge Incremento por base de roble			
	€	€	€	€	€	€			
<b>1400x1400</b>	720	142	142	345	330	765			
<b>1500x1500</b>	726	142	142	345	330	765			
<b>1600x1600</b>	737	142	142	345	330	765			
<b>ø1400</b>	912	142	142	345	330	765			
<b>ø1500</b>	920	142	142	345	330	765			

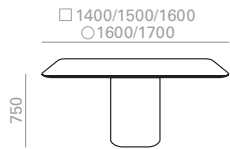

Height adjustable  
glides up charge  
Incremento por tacos  
reguladores

57

\*\*\*Marble shiny  
upcharge  
Incremento por  
mármol brillo

30

Column height / Altura columna																		
Top measures Medidas sobre	Table top / Sobre												Top & Base					
	Oak Roble		s600	Lacquered Lacado		Laminate Laminado		Laminate TP Laminado Tp		Top Technical Stone 8		Low Iron Glass Cristal óptico		Cement Cemento				
	Ref.	€	€	Ref.	€	Ref.	€	Ref.	€	Ref.	€	Ref.	€	Ref.	€			
<b>1400x1400 round square</b>	<b>ME03065</b>	1.353	156	<b>ME03066</b>	1.390	<b>ME03067</b>	1.901	<b>ME03068</b>	2.405	<b>ME03069</b>	3.724	<b>ME03070</b>	2.481	<b>ME03071</b>	2.191			
kg	127		127		127		127		81		81		133					
<b>2 boxes/ bultos</b> m3	0,79		0,79		0,79		0,79		2'96		1'43		0'79					
<b>1500x1500 round square</b>	<b>ME03072</b>	1.358	162	<b>ME03073</b>	1.437	<b>ME03074</b>	1.908	<b>ME03075</b>	2.409	<b>ME03076</b>	3.780	<b>ME03077</b>	2.586	<b>ME03078</b>	2.303			
kg	134		134		134		134		92		92		140					
<b>2 boxes/ bultos</b> m3	0,84		0,84		0,84		0,84		3'29		1'56		0'84					
<b>1600x1600 round square</b>	<b>ME03079</b>	1.586	171	<b>ME03080</b>	1.556										<b>ME03084</b>	2.883	<b>ME03085</b>	2.475
kg	141		141											103		148		
<b>2 boxes/ bultos</b> m3	0,9		0,9											1'7		0'9		
<b>ø1600</b>	<b>ME03086</b>	1.586	171	<b>ME03087</b>	1.556										<b>ME03091</b>	2.829	<b>ME03092</b>	2.475
kg	118		118											65		122		
<b>2 boxes/ bultos</b> m3	0,9		0,9											1'7		0'9		
<b>ø1700</b>	<b>ME03093</b>	1.676	192	<b>ME03094</b>	1.607										<b>ME03098</b>	2.920	<b>ME03099</b>	2.609
kg	123		123											74		128		
<b>2 boxes/ bultos</b> m3	0,96		0,96											1'85		0'96		

Amount of sand: 60 kg /  
Cantidad de arena 60 kg

Column height / Altura columna										
Top measures Medidas sobre	Table top / Sobre									
	Linoleum Linoleo		Ultra-matte Ultramate		Ultra-matte TP UltramateTp		***Marble M1 Mármol M1		***Marble M3 Mármol M3	
	Ref.	€	Ref.	€	Ref.	€	Ref.	€	Ref.	€
<b>1400x1400 round square</b>	<b>ME03100</b>	2.125	<b>ME03101</b>	2.266	<b>ME03102</b>	2.266	<b>ME03103</b>	3.944	<b>ME03105</b>	3.944
kg	127		127		127		207		207	
<b>2 boxes/ bultos</b> m3	0,84		0,79		0,79		2,96		2'96	
<b>1500x1500 round square</b>	<b>ME03106</b>	2.185	<b>ME03107</b>	2.283	<b>ME03108</b>	2.284	<b>ME03109</b>	4.139	<b>ME03111</b>	6.963
kg	134		134		134		214		214	
<b>2 boxes/ bultos</b> m3	0,84		0,84		0,84		3,29		3'29	
<b>1600x1600 round square</b>							<b>ME03115</b>	4.574	<b>ME03117</b>	8.245
kg							221		221	
<b>2 boxes/ bultos</b> m3							1,7		1'7	
<b>ø1600</b>							<b>ME03121</b>	4.574	<b>ME03123</b>	8.245
kg							198		198	
<b>2 boxes/ bultos</b> m3							3,64		3'64	

PSTOP-TECH									
Top measures Medidas sobre									
	Up charge for TOP-TECH Power Box. Incremento por sistema eléctrico TOP-TECH.	Up charge for double USB charge. Installation included. Incremento por doble USB de carga. Instalación incluida.	Up charge for power socket. Installation included. Incremento por toma de alimentación. Instalación incluida.	Incremento por base laca brillo.	Access panel for wiring up charge. Incremento por panel de acceso para cableado.	Oak base up charge Incremento por base de roble			
	€	€	€	€	€	€			
<b>1400x1400 round square</b>	803	142	142	345	330	765			
<b>1500x1500 round square</b>	810	142	142	345	330	765			
<b>1600x1600 round square</b>	816	142	142	345	330	765			
<b>ø1600</b>	929	142	142	345	330	765			
<b>ø1700</b>	936	142	142	345	330	765			

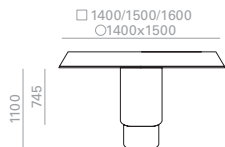

\*\*\*Marble shiny upcharge  
Incremento por mármol brillo

Column height / Altura columna															
Top measures Medidas sobre	Table top / Sobre													Top & Base	
	Oak Roble		s600	Lacquered Lacado		Laminate Laminado		Laminate TP LaminadoTp		Top Technical Stone 8		Low Iron Glass Cristal óptico		Cement Cemento	
	Ref.	€	€	Ref.	€	Ref.	€	Ref.	€	Ref.	€	Ref.	€	Ref.	€
<b>1400x1400</b>	ME03130	3.602	156	ME03131	3.638	ME03132	4.194	ME03133	5.180	ME03134	5.570	ME03135	4.520	ME03136	4.416
kg	127		127		127		127		81		81		133		
<b>2 boxes/ bultos</b> m3	0,79		0,79		0,79		0,79		2'96		1'43		0'79		
<b>1500x1500</b>	ME03137	3.608	162	ME03138	3.682	ME03139	4.202	ME03140	4.703	ME03141	5.627	ME03142	4.591	ME03143	4.527
kg	134		134		134		134		92		92		140		
<b>2 boxes/ bultos</b> m3	0,84		0,84		0,84		0,84		3'29		1'56		0'84		
<b>1600x1600</b>	ME03144	3.808	171	ME03145	3.817							ME03149	4.885	ME03150	4.711
kg	141		141								103		148		
<b>2 boxes/ bultos</b> m3	0,9		0,9								1'7		0'9		
<b>ø1400</b>	ME03151	3.612	156	ME03152	3.648	ME03153	4.194	ME03154	4.698	ME03155	6.019	ME03156	4.648	ME03157	4.427
kg	118		118		118		118		65		65		122		
<b>2 boxes/ bultos</b> m3	0,79		0,79		0,79		0,79		2'96		1'43		0'56		
<b>ø1500</b>	ME03158	3.615	162	ME03159	3.696	ME03160	4.194	ME03161	4.703	ME03162	6.073	ME03163	4.753	ME03164	4.538
kg	123		123		123		123		74		74		128		
<b>2 boxes/ bultos</b> m3	0,84		0,84		0,84		0,84		3'29		1'56		0'84		

Amount of sand: 50 kg. /  
Cantidad de arena 50 kg.

Column height / Altura columna						
Top measures Medidas sobre	Table top / Sobre					
	Linoleum Linoleo		Ultra-matte Ultramate		Ultra-matte TP UltramateTp	
	Ref.	€	Ref.	€	Ref.	€
<b>1400x1400</b>	ME03165	4.417	ME03166	4.558	ME03167	4.558
kg	127		127		127	
<b>2 boxes/ bultos</b> m3	0,79		0,79		0,79	
<b>1500x1500</b>	ME03171	4.478	ME03172	4.576	ME03173	4.578
kg	134		134		134	
<b>2 boxes/ bultos</b> m3	0,84		0,84		0,84	
<b>ø1400</b>	ME03183	4.417	ME03184	4.558	ME03185	4.558
kg	118		118		118	
<b>2 boxes/ bultos</b> m3	0,79		0,79		0,79	
<b>ø1500</b>	ME03189	4.478	ME03190	4.576	ME03191	4.578
kg	123		123		123	
<b>2 boxes/ bultos</b> m3	0,84		0,84		0,84	

PS TOP-TECH				
Top measures Medidas sobre				
	Up charge for TOP-TECH Power Box. Incremento por sistema eléctrico TOP-TECH.	Up charge for double USB charge. Installation included. Incremento por doble USB de carga. Instalación incluida.	Up charge for power socket. Installation included. Incremento por toma de alimentación. Instalación incluida.	Bright lacquered base up charge. Incremento por base laca brillo.
	€	€	€	€
<b>1400x1400</b>	720	142	142	345
<b>1500x1500</b>	726	142	142	345
<b>1600x1600</b>	737	142	142	345
<b>ø1400</b>	912	142	142	345
<b>ø1500</b>	920	142	142	345

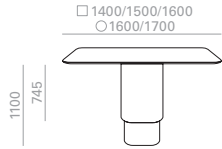

\*\*\*Marble shiny upcharge  
Incremento por mármol brillo

Column height / Altura columna																		
Top measures Medidas sobre	Table top / Sobre												Top & Base					
	Oak Roble		s600	Lacquered Lacado		Laminate Laminado		Laminate TP Laminado Tp		Top Technical Stone 8		Low Iron Glass Cristal óptico		Cement Cemento				
	Ref.	€	€	Ref.	€	Ref.	€	Ref.	€	Ref.	€	Ref.	€	Ref.	€			
<b>1400x1400 round square</b>	ME03195	3.612	156	ME03196	3.648	ME03197	4.194	ME03198	4.698	ME03199	6.019	ME03200	4.738	ME03201	4.427			
kg	127		127		127		127		81		81		133					
<b>2 boxes/ bultos</b> m3	0,79		0,79		2,43		0,79		1'43		1'3		0'79					
<b>1500x1500 round square</b>	ME03202	3.615	162	ME03203	3.696	ME03204	4.202	ME03205	4.703	ME03206	6.073	ME03207	4.845	ME03208	4.538			
kg	134		134		134		134		92		92		140					
<b>2 boxes/ bultos</b> m3	0,84		0,84		0,84		0,84		3'29		1'56		0'84					
<b>1600x1600 round square</b>	ME03209	3.843	171	ME03210	3.814										ME03214	5.140	ME03215	4.711
kg	141		141											103		148		
<b>2 boxes/ bultos</b> m3	0,9		0,9											1'7		0'9		
<b>ø1600</b>	ME03216	3.843	171	ME03217	3.814										ME03221	5.087	ME03222	4.711
kg	118		118											65		122		
<b>2 boxes/ bultos</b> m3	0,9		0,9											1'7		0'9		
<b>ø1700</b>	ME03223	3.931	192	ME03224	3.864										ME03228	5.179	ME03229	4.847
kg	123		123											74		128		
<b>2 boxes/ bultos</b> m3	0,96		0,96											1'85		0'96		

Amount of sand: 50 kg. /  
Cantidad de arena 50 kg.

Column height / Altura columna						
Top measures Medidas sobre	Table top / Sobre					
	Linoleum Linoleo		Ultra-matte Ultramate		Ultra-matte TP UltramateTp	
	Ref.	€	Ref.	€	Ref.	€
<b>1400x1400 round square</b>	ME03230	4.417	ME03231	4.558	ME03232	4.558
kg	127		127		127	
<b>2 boxes/ bultos</b> m3	0,79		0,79		0,79	
<b>1500x1500 round square</b>	ME03236	4.348	ME03237	4.576	ME03238	4.578
kg	134		134		134	
<b>2 boxes/ bultos</b> m3	0,68		0,84		0,84	

PSTOP-TECH								
Top measures Medidas sobre		Up charge for TOP-TECH Power Box. Incremento por sistema eléctrico TOP-TECH.		Up charge for double USB charge. Installation included. Incremento por doble USB de carga. Instalación incluida.		Up charge for power socket. Installation included. Incremento por toma de alimentación. Instalación incluida.		Bright lacquered base up charge. Incremento por base laca brillo.
<b>1400x1400 round square</b>		803		142		142		345
<b>1500x1500 round square</b>		810		142		142		345
<b>1600x1600 round square</b>		816		142		142		345
<b>ø1600</b>		929		142		142		345
<b>ø1700</b>		936		142		142		345

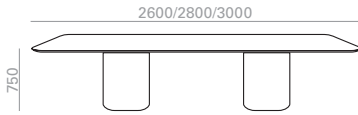

\*\*\*Marble shiny upcharge  
Incremento por mármol brillo

| 30 |



Height adjustable glides up charge  
Incremento por tacos reguladores

| 114 |

Column height / Altura columna															
Top measures Medidas sobre	Table top / Sobre												Top & Base		
	Oak Roble		s600	Lacquered Lacado		Laminate Laminado		Laminate TP Laminado Tp		*Top Technical Stone 8		Low Iron Glass Cristal óptico		Cement Cemento	
	Ref.	€	€	Ref.	€	Ref.	€	Ref.	€	Ref.	€	Ref.	€	Ref.	€
2600x1500 round square	ME03260	2.988	264	ME03261	2.291	ME03262	3.575	ME03263	3.814	ME03264	5.227	ME03265	3.870	ME03266	3.806
kg	260		286'6		241'8		242		310		292		265		
2 boxes/ bultos  m3	1,46		1,46		1,46		1,46		5'49		5'49		1'46		
2800x1500 round square	ME03267	3.024	285	ME03268	2.349	ME03269	3.598	ME03270	3.843	ME03271	5.424	ME03272	3.995	ME03273	3.839
kg	262		292		245		245		317		299		267		
2 boxes/ bultos  m3	1,52		1,52		1,52		1,52		5'83		5'83		1'52		
3000x1500 round square	ME03274	3.077	306	ME03275	2.418	ME03276	3.632	ME03277	3.892	ME03278	5.759	ME03279	4.130	ME03280	4.061
kg	257'3		292'2		228		228		318		300		262		
2 boxes/ bultos  m3	1,57		1,57		1,57		1,57		6'17		6'17		1'57		

Column height / Altura columna										
Top measures Medidas sobre	Table top / Sobre									
	Linoleum Linoleo		Ultra-matte Ultramate		Ultra-matte TP Ultramate Tp		***Marble M1 Mármol M1		***Marble M3 Mármol M3	
	Ref.	€	Ref.	€	Ref.	€	Ref.	€	Ref.	€
2600x1500 round square	ME03281	3.704	ME03282	3.991	ME03283	4.039	ME03284	6.984	ME03286	12.941
kg	242		242		242		402		402	
2 boxes/ bultos  m3	1,46		1,46		1,46		5,49		5'49	
2800x1500 round square	ME03287	3.723	ME03288	4.012	ME03289	4.069	ME03290	7.238	ME03292	13.198
kg	245		245		245		417		417	
2 boxes/ bultos  m3	1,52		1,52		1,52		5,83		5'83	
3000x1500 round square	ME03293	3.752	ME03294	4.044	ME03295	4.113	ME03296	8.028	ME03298	14.966
kg	227'6		228		228		459		459	
2 boxes/ bultos  m3	1,57		1,57		1,57		6,17		6'17	

Amount of sand: 120 kg. (2x60 kg.) /  
Cantidad de arena 120 kg. (2x60 kg.)

PSTOP-TECH												
Top measures Medidas sobre		Up charge for TOP-TECH Power Box. Incremento por sistema eléctrico TOP-TECH.		Up charge for double USB charge. Installation included. Incremento por doble USB de carga. Instalación incluida.		Up charge for power socket. Installation included. Incremento por toma de alimentación. Instalación incluida.		Incremento por base laca brillo.		Acces panel for wiring up charge. Incremento por panel de acceso para cableado.		Oak base up charge Incremento por base de roble
2600x1500 round square		846		142		142		690		330		1.530
2800x1500 round square		857		142		142		690		330		1.530
3000x1500 round square		864		142		142		690		330		1.530

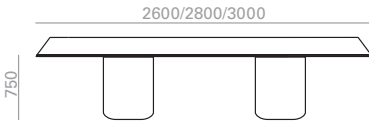

\*\*\*Marble shiny upcharge  
Incremento por mármol brillo

| 30 |



Height adjustable glides up charge  
Incremento por tacos reguladores

| 114 |

Column height / Altura columna																
Top measures Medidas sobre	Table top / Sobre														Top & Base	
	Oak Roble		s600	Lacquered Lacado		Laminate Laminado		Laminate TP Laminado Tp		*Top Technical Stone 8		Low Iron Glass Cristal óptico		Cement Cemento		
	Ref.	€	€	Ref.	€	Ref.	€	Ref.	€	Ref.	€	Ref.	€	Ref.	€	
2600x1500	ME03299	2.988	264	ME03300	2.291	ME03301	3.575	ME03302	3.814	ME03303	5.227	ME03304	3.870	ME03305	3.806	
kg	260		286'6		241'8		242		310		292		265			
2 boxes/ bultos  m3	1,46		1,46		1,46		1,46		5'49		5'49		1'46			

2800x1500	ME03306	3.024	285	ME03307	2.349	ME03308	3.598	ME03309	3.843	ME03310	5.424	ME03311	3.995	ME03312	3.839
kg	262		292		245		245		317		299		267		
2 boxes/ bultos  m3	1,52		1,52		1,52		1,52		5'83		5'83		1'52		

3000x1500	ME03313	3.077	306	ME03314	2.418	ME03315	3.632	ME03316	3.892	ME03317	5.759	ME03318	4.130	ME03319	4.061
kg	257'3		292'2		228		228		318		300		262		
2 boxes/ bultos  m3	1,57		1,57		1,57		1,57		6'17		6'17		1'63		

Column height / Altura columna															
Top measures Medidas sobre	Table top / Sobre														
	Linoleum Linoleo		Ultra-matte Ultramate		Ultra-matte TP Ultramate Tp		***Marble M1 Mármol M1		***Marble M3 Mármol M3						
	Ref.	€	Ref.	€	Ref.	€	Ref.	€	Ref.	€					
2600x1500	ME03320	3.704	ME03321	3.991	ME03322	4.039	ME03323	6.246	ME03325	12.208					
kg	242		242		242		402		402						
2 boxes/ bultos  m3	1,46		1,46		1,46		5,49		5'49						

Amount of sand: 120 kg. (2x60 kg.) /  
Cantidad de arena 120 kg. (2x60 kg.)

2800x1500	ME03326	3.723	ME03327	4.012	ME03328	4.069	ME03329	6.462	ME03331	12.424
kg	245		245		245		417		417	
2 boxes/ bultos  m3	1,52		1,52		1,52		5,83		5'83	

3000x1500	ME03332	3.752	ME03333	4.044	ME03334	4.113	ME03335	7.458	ME03337	14.401
kg	227'6		228		228		459		459	
2 boxes/ bultos  m3	1,57		1,57		1,57		6,17		6'17	

PSTOP-TECH											
Top measures Medidas sobre											
	Up charge for TOP-TECH Power Box. Incremento por sistema eléctrico TOP-TECH.	Up charge for double USB charge. Installation included. Incremento por doble USB de carga. Instalación incluida.	Up charge for power socket. Installation included. Incremento por toma de alimentación. Instalación incluida.	Incremento por base laca brillo.	Acces panel for wiring up charge. Incremento por panel de acceso para cableado.	Oak base up charge Incremento por base de roble					
	€	€	€	€	€	€					
2600x1500	759	142	142	690	330	1.530					
2800x1500	771	142	142	690	330	1.530					
3000x1500	782	142	142	690	330	1.530					

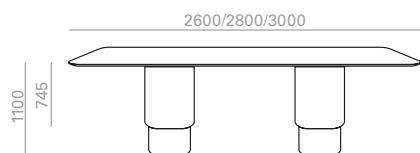

\*\*\*Marble shiny upcharge  
Incremento por mármol brillo

Column height / Altura columna																
Top measures Medidas sobre	Table top / Sobre														Top & Base	
	Oak Roble		s600	Lacquered Lacado		Laminate Laminado		Laminate TP Laminado Tp		*Top Technical Stone 8		Low Iron Glass Cristal óptico		Cement Cemento		
	Ref.	€	€	Ref.	€	Ref.	€	Ref.	€	Ref.	€	Ref.	€	Ref.	€	
2600x1500 round square	ME03338	7.501	264	ME03339	6.804	ME03340	8.090	ME03341	8.327	ME03342	9.742	ME03343	8.383	ME03344	8.279	
kg	260		286'6		241'8		242		310		292		265			
2 boxes/ bultos  m3	1,46		1,46		1,46		1,46		5'49		5'49		1'46			

2800x1500 round square	ME03345	7.537	285	ME03346	6.864	ME03347	8.113	ME03348	8.359	ME03349	9.939	ME03350	8.512	ME03351	8.312
kg	262		292		245		245		317		299		267		
2 boxes/ bultos  m3	1,52		1,52		1,52		1,52		5'83		5'83		1'52		

3000x1500 round square	ME03352	7.589	306	ME03353	6.932	ME03354	8.144	ME03355	8.407	ME03356	10.272	ME03357	8.642	ME03358	8.533
kg	257'3		292'2		228		228		318		300		262		
2 boxes/ bultos  m3	1,57		1,57		1,57		1,57		6'17		6'17		1'57		

Column height / Altura columna						
Top measures Medidas sobre	Table top / Sobre					
	Linoleum Linoleo		Ultra-matte Ultramate		Ultra-matte TP Ultramate Tp	
	Ref.	€	Ref.	€	Ref.	€
2600x1500 round square	ME03359	8.217	ME03360	8.507	ME03361	8.553
kg	242		242		242	
2 boxes/ bultos  m3	1,46		1,46		1,46	

Amount of sand: 100 kg. (2x50 kg.) /  
Cantidad de arena 100 kg. (2x50 kg.)

2800x1500 round square	ME03365	8.238	ME03366	8.526	ME03367	8.582
kg	245		245		245	
2 boxes/ bultos  m3	1,52		1,52		1,52	

3000x1500 round square	ME03371	8.265	ME03372	8.559	ME03373	8.626
kg	227'6		228		228	
2 boxes/ bultos  m3	1,57		1,57		1,57	

PS TOP-TECH

Top measures Medidas sobre				
	Up charge for TOP-TECH Power Box. Incremento por sistema eléctrico TOP-TECH.	Up charge for double USB charge. Installation included. Incremento por doble USB de carga. Instalación incluida.	Up charge for power socket. Installation included. Incremento por toma de alimentación. Instalación incluida.	Bright lacquered base up charge. Incremento por base laca brillo.
	€	€	€	€
2600x1500 round square	846	142	142	690
2800x1500 round square	857	142	142	690
3000x1500 round square	864	142	142	690



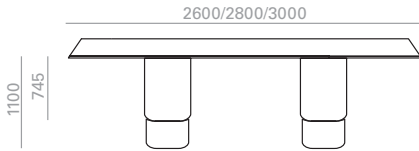

\*\*\*Marble shiny upcharge  
Incremento por mármol brillo

Column height / Altura columna															
Top measures Medidas sobre	Table top / Sobre													Top & Base	
	Oak Roble		s600	Lacquered Lacado		Laminate Laminado		Laminate TP Laminado Tp		*Top Technical Stone 8		Low Iron Glass Cristal óptico		Cement Cemento	
	Ref.	€	€	Ref.	€	Ref.	€	Ref.	€	Ref.	€	Ref.	€	Ref.	€
2600x1500	ME03377	7.501	264	ME03378	6.804	ME03379	8.090	ME03380	8.327	ME03381	9.742	ME03382	8.383	ME03383	8.279
kg	260		286'6		241'8		242		310		292		265		
2 boxes/ bultos  m3	1,46		1,46		1,46		1,46		5'49		5'49		1'46		

2800x1500	ME03384	7.537	285	ME03385	6.864	ME03386	8.113	ME03387	8.359	ME03388	9.939	ME03389	8.512	ME03390	8.312
kg	262		292		245		245		317		299		267		
2 boxes/ bultos  m3	1,52		1,52		1,52		1,52		5'83		5'83		1'52		

3000x1500	ME03391	7.589	306	ME03392	6.932	ME03393	8.144	ME03394	8.407	ME03395	10.272	ME03396	8.642	ME03397	8.533
kg	257'3		292'2		228		228		318		300		262		
2 boxes/ bultos  m3	1,57		1,57		1,57		1,57		6'17		6'17		1'57		

Column height / Altura columna						
Top measures Medidas sobre	Table top / Sobre					
	Linoleum Linoleo		Ultra-matte Ultramate		Ultra-matte TP Ultramate Tp	
	Ref.	€	Ref.	€	Ref.	€
2600x1500	ME03398	8.217	ME03399	8.507	ME03400	8.553
kg	242		242		242	
2 boxes/ bultos  m3	1,46		1,46		1,46	

Amount of sand: 100 kg. (2x50 kg.) /  
Cantidad de arena 100 kg. (2x50 kg.)

2800x1500	ME03404	8.238	ME03405	8.526	ME03406	8.582
kg	245		245		245	
2 boxes/ bultos  m3	1,52		1,52		1,52	

3000x1500	ME03410	8.265	ME03411	8.559	ME03412	8.626
kg	227'6		228		228	
2 boxes/ bultos  m3	1,57		1,57		1,57	

PSTOP-TECH								
Top measures Medidas sobre		Up charge for TOP-TECH Power Box. Incremento por sistema eléctrico TOP-TECH.		Up charge for double USB charge. Installation included. Incremento por doble USB de carga. Instalación incluida.		Up charge for power socket. Installation included. Incremento por toma de alimentación. Instalación incluida.		Bright lacquered base up charge. Incremento por base laca brillo.
2600x1500		759		142		142		690
2800x1500		771		142		142		690
3000x1500		782		142		142		690



\*\*\*Marble shiny upcharge  
Incremento por mármol brillo

| 30 |



Height adjustable glides up charge  
Incremento por tacos reguladores

| 171 |

Column height / Altura columna															
Top measures Medidas sobre	Table top / Sobre													Top & Base	
	Oak Roble		s600	Lacquered Lacado		Laminate Laminado		Laminate TP Laminado Tp		*Top Technical Stone 8		Low Iron Glass Cristal óptico		Cement Cemento	
	Ref.	€	€	Ref.	€	Ref.	€	Ref.	€	Ref.	€	Ref.	€	Ref.	€
<b>3500x1500 round square</b>	<b>ME03416</b>	4.720	357	<b>ME03417</b>	3.247	<b>ME03418</b>	6.315	<b>ME03419</b>	6.639	<b>ME03420</b>	7.680	<b>ME03421</b>	5.486	<b>ME03422</b>	5.073
kg	270'8		311'5		236'2		236		339		321		276		
<b>3 boxes/ bultos</b> m3	2,32		2,32		2,32		2,32		7'95		7'95		2'32		
<b>4000x1500 round square</b>	<b>ME03423</b>	4.825	408	<b>ME03424</b>	3.401	<b>ME03425</b>	6.334	<b>ME03426</b>	6.712	<b>ME03427</b>	8.214	<b>ME03428</b>	5.671	<b>ME03429</b>	5.514
kg	372'1		419		333		333		447		429		377		
<b>3 boxes/ bultos</b> m3	2,46		2,46		2,46		2,46		8'8		8'8		2'46		
<b>4500x1500 round square</b>	<b>ME03430</b>	5.017	459	<b>ME03431</b>	3.642	<b>ME03432</b>	6.418	<b>ME03433</b>	6.820	<b>ME03434</b>	8.818	<b>ME03435</b>	6.056	<b>ME03436</b>	5.828
kg	386		438		341		341		468		450		391		
<b>3 boxes/ bultos</b> m3	2,6		2,6		2,6		2,6		9'65		9'65		2'6		

Column height / Altura columna										
Top measures Medidas sobre	Table top / Sobre									
	Linoleum Linoleo		Ultra-matte Ultramate		Ultra-matte TP Ultramate Tp		***Marble M1 Mármol M1		***Marble M3 Mármol M3	
	Ref.	€	Ref.	€	Ref.	€	Ref.	€	Ref.	€
<b>3500x1500 round square</b>	<b>ME03437</b>	6.620	<b>ME03438</b>	7.210	<b>ME03439</b>	7.153	<b>ME03440</b>	9.468	<b>ME03442</b>	17.561
kg	236		236'2		236		506		506	
<b>3 boxes/ bultos</b> m3	2,32		2,32		2,32		7,95		7'95	
<b>4000x1500 round square</b>	<b>ME03443</b>	6.656	<b>ME03444</b>	7.238	<b>ME03445</b>	7.225	<b>ME03446</b>	11.453	<b>ME03448</b>	20.323
kg	333		333		333		640'4		640	
<b>3 boxes/ bultos</b> m3	2,46		2,46		2,46		8,8		8'8	
<b>4500x1500 round square</b>	<b>ME03449</b>	6.724	<b>ME03450</b>	7.306	<b>ME03451</b>	7.330	<b>ME03452</b>	11.351	<b>ME03454</b>	20.988
kg	341		341		341		688		688	
<b>3 boxes/ bultos</b> m3	2,6		2,6		2,6		9,65		9'65	

Amount of sand: 180 kg. (3x60 kg.) /  
Cantidad de arena 180 kg. (3x60 kg.)

PSTOP-TECH																		
Top measures Medidas sobre		Up charge for TOP-TECH Power Box. Incremento por sistema eléctrico TOP-TECH.		Up charge for double USB charge. Installation included. Incremento por doble USB de carga. Instalación incluida.		Up charge for power socket. Installation included. Incremento por toma de alimentación. Instalación incluida.		Incremento por base laca brillo.		Acces panel for wiring up charge. Incremento por panel de acceso para cableado.		Oak base up charge Incremento por base de roble						
													€	€	€	€	€	€
													<b>3500x1500 round square</b>	1.086	142	142	1.035	330
<b>4000x1500 round square</b>	1.109	142	142	1.035	330	2.295												
<b>4500x1500 round square</b>	1.133	142	142	1.035	330	2.295												

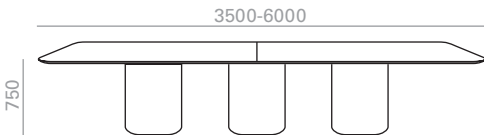

\*\*\*Marble shiny upcharge  
Incremento por mármol brillo

| 30 |



Height adjustable glides up charge  
Incremento por tacos reguladores

| 171 |

Column height / Altura columna															
Top measures Medidas sobre	Table top / Sobre												Top & Base		
	Oak Roble		s600	Lacquered Lacado		Laminate Laminado		Laminate TP Laminado Tp		*Top Technical Stone 8		Low Iron Glass Cristal óptico		Cement Cemento	
	Ref.	€	€	Ref.	€	Ref.	€	Ref.	€	Ref.	€	Ref.	€	Ref.	€
5000x1500 round square	ME03455	5.149	510	ME03456	3.833	ME03457	6.458	ME03458	6.928	ME03459	9.394	ME03460	6.376	ME03461	6.363
kg	399			457		350		350		489		471		404	
3 boxes/ bultos  m3	2,73			2,73		2,73		2,73		10'5		10'5		2'73	
5500x1500 round square	ME03462	6.378	561	ME03463	4.149	ME03464	6.558	ME03465	7.059	ME03466	10.151	ME03467	6.850	ME03468	6.572
kg	413			477		358		358		509		491		418	
3 boxes/ bultos  m3	2,87			2,87		2,87		2,87		11'35		11'35		2'87	
6000x1500 round square	ME03469	6.502	612	ME03470	4.374	ME03471	8.708	ME03472	9.214	ME03473	10.512	ME03474	7.418	ME03475	6.905
kg	426			496		367		367		530		512		431	
3 boxes/ bultos  m3	3			3		3		3		12'2		12'2		3	

Column height / Altura columna										
Top measures Medidas sobre	Table top / Sobre									
	Linoleum Linoleo		Ultra-matte Ultramate		Ultra-matte TP UltramateTp		***Marble M1 Mármol M1		***Marble M3 Mármol M3	
	Ref.	€	Ref.	€	Ref.	€	Ref.	€	Ref.	€
5000x1500 round square	ME03476	6.776	ME03477	7.363	ME03478	7.431	ME03479	12.163	ME03481	22.567
kg	350		350		350		735		735	
3 boxes/ bultos  m3	2,73		2,73		2,73		10,5		10'5	
5500x1500 round square	ME03482	6.851	ME03483	8.991	ME03484	7.551	ME03485	12.994	ME03487	24.172
kg	358		358		358		781'6		782	
3 boxes/ bultos  m3	2,87		2,87		2,87		11,35		11'35	
6000x1500 round square	ME03488	9.234	ME03489	10.108	ME03490	10.040	ME03491	13.803	ME03493	25.755
kg	367		367		367		829		829	
3 boxes/ bultos  m3	3		3		3		12,2		12'2	

Amount of sand: 180 kg. (3x60 kg.) /  
Cantidad de arena 180 kg. (3x60 kg.)

PSTOP-TECH										
Top measures Medidas sobre										
	Up charge for TOP-TECH Power Box. Incremento por sistema eléctrico TOP-TECH.	Up charge for double USB charge. Installation included. Incremento por doble USB de carga. Instalación incluida.	Up charge for power socket. Installation included. Incremento por toma de alimentación. Instalación incluida.	***Marble shiny upcharge Incremento por mármol brillo.	Acces panel for wiring up charge. Incremento por panel de acceso para cableado.	Oak base up charge Incremento por base de roble				
	€	€	€	€	€	€				
5000x1500 round square	1.158	142	142	1.035	330	2.295				
5500x1500 round square	1.182	142	142	1.035	330	2.295				
6000x1500 round square	1.224	142	142	1.035	330	2.295				



\*\*\*Marble shiny upcharge  
Incremento por mármol brillo



Height adjustable glides up charge  
Incremento por tacos reguladores

| 30 |

| 171 |

Column height / Altura columna																
Top measures Medidas sobre	Table top / Sobre														Top & Base	
	Oak Roble		s600	Lacquered Lacado		Laminate Laminado		Laminate TP Laminado Tp		*Top Technical Stone 8		Low Iron Glass Cristal óptico		Cement Cemento		
	Ref.	€	€	Ref.	€	Ref.	€	Ref.	€	Ref.	€	Ref.	€	Ref.	€	
<b>3500x1500</b>	<b>ME03494</b>	4.720	357	<b>ME03495</b>	3.247	<b>ME03496</b>	6.315	<b>ME03497</b>	6.639	<b>ME03498</b>	7.680	<b>ME03499</b>	5.486	<b>ME03500</b>	5.073	
<b>kg</b>	270'8		311'5		236'2		236		339		321		276			
<b>3 boxes/ bultos</b>	2,32		2,32		2,32		2,32		7'95		7'95		2'32			

<b>4000x1500</b>	<b>ME03501</b>	4.825	408	<b>ME03502</b>	3.401	<b>ME03503</b>	6.334	<b>ME03504</b>	6.712	<b>ME03505</b>	8.214	<b>ME03506</b>	5.671	<b>ME03507</b>	5.514
<b>kg</b>	372'1		419		333		333		447		429		377		
<b>3 boxes/ bultos</b>	2,46		2,46		2,46		2,46		8'8		8'8		2'46		







<b>4500x1500</b>	<b>ME03508</b>	5.017	459	<b>ME03509</b>	3.642	<b>ME03510</b>	6.418	<b>ME03511</b>	6.820	<b>ME03512</b>	8.818	<b>ME03513</b>	6.056	<b>ME03514</b>	5.828
<b>kg</b>	386		438		341		341		468		450		391		
<b>3 boxes/ bultos</b>	2,6		2,6		2,6		2,6		9'65		9'65		2'6		

Column height / Altura columna															
Top measures Medidas sobre	Table top / Sobre														
	Linoleum Linoleo		Ultra-matte Ultramate		Ultra-matte TP Ultramate Tp		***Marble M1 Mármol M1		***Marble M3 Mármol M3						
	Ref.	€	Ref.	€	Ref.	€	Ref.	€	Ref.	€					
<b>3500x1500</b>	<b>ME03515</b>	6.620	<b>ME03516</b>	7.210	<b>ME03517</b>	7.153	<b>ME03518</b>	8.820	<b>ME03520</b>	16.913					
<b>kg</b>	236		236'2		236		506		506						
<b>3 boxes/ bultos</b>	2,32		2,32		2,32		7,95		7'95						

Amount of sand: 150 kg. (3x50 kg.) /  
Cantidad de arena 150 kg. (3x50 kg.)

<b>4000x1500</b>	<b>ME03521</b>	6.656	<b>ME03522</b>	7.238	<b>ME03523</b>	7.225	<b>ME03524</b>	10.731	<b>ME03526</b>	19.600
<b>kg</b>	333		333		333		640'4		640	
<b>3 boxes/ bultos</b>	2,46		2,46		2,46		8,8		8'8	

<b>4500x1500</b>	<b>ME03527</b>	6.724	<b>ME03528</b>	7.306	<b>ME03529</b>	7.330	<b>ME03530</b>	10.556	<b>ME03532</b>	20.194
<b>kg</b>	341		341		341		688		688	
<b>3 boxes/ bultos</b>	2,6		2,6		2,6		9,65		9'65	

PSTOP-TECH											
Top measures Medidas sobre											
	Up charge for TOP-TECH Power Box. Incremento por sistema eléctrico TOP-TECH.	Up charge for double USB charge. Installation included. Incremento por doble USB de carga. Instalación incluida.	Up charge for power socket. Installation included. Incremento por toma de alimentación. Instalación incluida.	Incremento por base laca brillo.	Acces panel for wiring up charge. Incremento por panel de acceso para cableado.	Oak base up charge Incremento por base de roble					
€	€	€	€	€	€	€					
<b>3500x1500</b>	963	142	142	1.035	330	2.295					
<b>4000x1500</b>	975	142	142	1.035	330	2.295					
<b>4500x1500</b>	999	142	142	1.035	330	2.295					

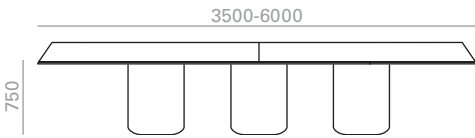

\*\*\*Marble shiny upcharge  
Incremento por mármol brillo

| 30 |



Height adjustable glides up charge  
Incremento por tacos reguladores

| 171 |

Column height / Altura columna															
Top measures Medidas sobre	Table top / Sobre												Top & Base		
	Oak Roble		s600	Lacquered Lacado		Laminate Laminado		Laminate TP Laminado Tp		*Top Technical Stone 8		Low Iron Glass Cristal óptico		Cement Cemento	
	Ref.	€	€	Ref.	€	Ref.	€	Ref.	€	Ref.	€	Ref.	€	Ref.	€
5000x1500	ME03533	5.149	510	ME03534	3.833	ME03535	6.458	ME03536	6.928	ME03537	9.394	ME03538	6.376	ME03539	6.363
kg	399			457		350		350		489		471		404	
3 boxes/ bultos  m3	2,73			2,73		2,73		2,73		10'5		10'5		2'73	

5500x1500	ME03540	6.378	561	ME03541	4.149	ME03542	6.558	ME03543	7.059	ME03544	10.151	ME03545	6.376	ME03546	6.572
kg	413			477		358		358		509		491		418	
3 boxes/ bultos  m3	2,87			2,87		2,87		2,87		11'35		11'35		2'87	

6000x1500	ME03547	6.502	612	ME03548	4.374	ME03549	8.708	ME03550	9.214	ME03551	10.512	ME03552	7.418	ME03553	6.905
kg	426			496		367		367		530		512		431	
3 boxes/ bultos  m3	3			3		3		3		12'2		12'2		3	

Column height / Altura columna										
Top measures Medidas sobre	Table top / Sobre									
	Linoleum Linoleo		Ultra-matte Ultramate		Ultra-matte TP UltramateTp		***Marble M1 Mármol M1		***Marble M3 Mármol M3	
	Ref.	€	Ref.	€	Ref.	€	Ref.	€	Ref.	€
5000x1500	ME03554	6.776	ME03555	7.363	ME03556	7.431	ME03557	11.293	ME03559	21.707
kg	350		350		350		735		735	
3 boxes/ bultos  m3	2,73		2,73		2,73		10,5		10'5	

Amount of sand: 150 kg. (3x50 kg.) /  
Cantidad de arena 150 kg. (3x50 kg.)

5500x1500	ME03560	6.851	ME03561	8.991	ME03562	7.551	ME03563	12.048	ME03565	23.231
kg	358		358		358		781'6		782	
3 boxes/ bultos  m3	2,87		2,87		2,87		11,35		11'35	

6000x1500	ME03566	9.234	ME03567	10.108	ME03568	10.040	ME03569	12.790	ME03571	24.742
kg	367		367		367		829		829	
3 boxes/ bultos  m3	3		3		3		12,2		12'2	

PSTOP-TECH										
Top measures Medidas sobre										
	Up charge for TOP-TECH Power Box. Incremento por sistema eléctrico TOP-TECH.	Up charge for double USB charge. Installation included. Incremento por doble USB de carga. Instalación incluida.	Up charge for power socket. Installation included. Incremento por toma de alimentación. Instalación incluida.	Incremento por base laca brillo.	Acces panel for wiring up charge. Incremento por panel de acceso para cableado.	Oak base up charge Incremento por base de roble				
	€	€	€	€	€	€				
5000x1500	1.023	142	142	1.035	330	2.295				
5500x1500	1.182	142	142	1.035	330	2.295				
6000x1500	1.088	142	142	1.035	330	2.295				

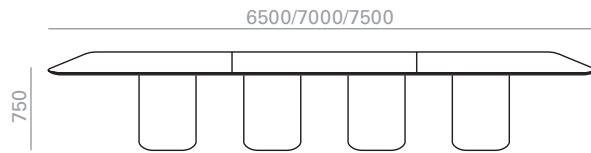

\*\*\*Marble shiny upcharge  
Incremento por mármol brillo

| 30 |



Height adjustable glides up charge  
Incremento por tacos reguladores

| 228 |

Column height / Altura columna																
Top measures Medidas sobre	Table top / Sobre														Top & Base	
	Oak Roble		s600	Lacquered Lacado		Laminate Laminado		Laminate TP Laminado Tp		*Top Technical Stone 8		Low Iron Glass Cristal óptico		Cement Cemento		
	Ref.	€	€	Ref.	€	Ref.	€	Ref.	€	Ref.	€	Ref.	€	Ref.	€	
6500x1500 round square	ME03572	7.185	663	ME03573	5.106	ME03574	9.329	ME03575	9.853	ME03576	12.588	ME03577	8.369	ME03578	8.016	
kg	528		604		464		464		639		620'7		533			
4 boxes/ bultos  m3	3,25		3,25		3,25		3,25		13'92		13'92		3'25			

7000x1500 round square	ME03579	7.320	714	ME03580	5.287	ME03581	9.402	ME03582	9.944	ME03583	13.139	ME03584	8.653	ME03585	8.330
kg	541		623		472		472		659		641		546		
4 boxes/ bultos  m3	3,31		3,31		3,31		3,31		14'27		14'27		3'31		

7500x1500 round square	ME03586	7.447	765	ME03587	5.462	ME03588	9.457	ME03589	10.062	ME03590	13.715	ME03591	9.069	ME03592	8.642
kg	555		642		481		481		680		662		560		
4 boxes/ bultos  m3	4,46		4,46		4,46		4,46		21'46		21'46		4'46		

Column height / Altura columna															
Top measures Medidas sobre	Table top / Sobre														
	Linoleum Linoleo		Ultra-matte Ultramate		Ultra-matte TP Ultramate Tp		***Marble M1 Mármol M1		***Marble M3 Mármol M3						
	Ref.	€	Ref.	€	Ref.	€	Ref.	€	Ref.	€					
6500x1500 round square	ME03593	9.809	ME03594	10.682	ME03595	10.641	ME03596	15.985	ME03598	31.023					
kg	464		464		464		964		964						
4 boxes/ bultos  m3	19,84		19,84		19,84		13,4		13'4						

Amount of sand: 240 kg. (4x60 kg.) /  
Cantidad de arena 240 kg. (4x60 kg.)

7000x1500 round square	ME03599	9.877	ME03600	10.752	ME03601	10.723	ME03602	16.813	ME03604	32.620
kg	472		472		472		1011		1011	
4 boxes/ bultos  m3	3,31		3,31		3,31		14,27		14'27	

7500x1500 round square	ME03605	9.925	ME03606	10.800	ME03607	10.833	ME03608	17.983	ME03610	35.328
kg	481		481		481		1058		1058	
4 boxes/ bultos  m3	4,46		4,46		4,46		21,46		21'46	

PSTOP-TECH												
Top measures Medidas sobre		Up charge for TOP-TECH Power Box. Incremento por sistema eléctrico TOP-TECH.		Up charge for double USB charge. Installation included. Incremento por doble USB de carga. Instalación incluida.		Up charge for power socket. Installation included. Incremento por toma de alimentación. Instalación incluida.		Incremento por base laca brillo.		Acces panel for wiring up charge. Incremento por panel de acceso para cableado.		Oak base up charge Incremento por base de roble
6500x1500 round square		1.500		142		142		1.380		330		3.060
7000x1500 round square		1.527		142		142		1.380		330		3.060
7500x1500 round square		1.550		142		142		1.380		330		3.060

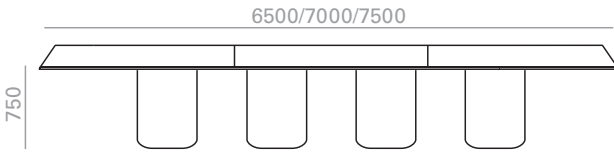

\*\*\*Marble shiny upcharge  
Incremento por mármol brillo

| 30 |



Height adjustable glides up charge  
Incremento por tacos reguladores

| 228 |

Column height / Altura columna															
Top measures Medidas sobre	Table top / Sobre													Top & Base	
	Oak Roble		s600	Lacquered Lacado		Laminate Laminado		Laminate TP Laminado Tp		*Top Technical Stone 8		Low Iron Glass Cristal óptico		Cement Cemento	
	Ref.	€	€	Ref.	€	Ref.	€	Ref.	€	Ref.	€	Ref.	€	Ref.	€
6500x1500	ME03611	7.185	663	ME03612	5.106	ME03613	9.329	ME03614	9.853	ME03615	12.588	ME03616	8.369	ME03617	8.016
kg	528		604		464		464		639		620'7		533		
4 boxes/ bultos  m3	3,17		3,17		3,17		3,17		13'4		13'4		3'17		

7000x1500	ME03618	7.320	714	ME03619	5.287	ME03620	9.402	ME03621	9.944	ME03622	13.139	ME03623	8.653	ME03624	8.330
kg	541		623		472		472		659		641		546		
4 boxes/ bultos  m3	21,23		3,31		21,23		3,31		14'27		14'27		3'31		

7500x1500	ME03625	7.447	765	ME03626	5.462	ME03627	9.457	ME03628	10.062	ME03629	13.715	ME03630	9.069	ME03631	8.642
kg	555		642		481		481		680		662		560		
4 boxes/ bultos  m3	3,44		3,44		3,44		3,44		15'09		15'09		3'44		

Column height / Altura columna															
Top measures Medidas sobre	Table top / Sobre														
	Linoleum Linoleo		Ultra-matte Ultramate		Ultra-matte TP UltramateTp		***Marble M1 Mármol M1		***Marble M3 Mármol M3						
	Ref.	€	Ref.	€	Ref.	€	Ref.	€	Ref.	€					
6500x1500	ME03632	9.809	ME03633	10.682	ME03634	10.641	ME03635	14.906	ME03637	29.936					
kg	464		464		464		964		964						
4 boxes/ bultos  m3	3,17		3,17		3,17		13,4		13'4						

Amount of sand: 200 kg. (4x50 kg.) /  
Cantidad de arena 200 kg. (4x50 kg.)

7000x1500	ME03638	9.877	ME03639	10.752	ME03640	10.723	ME03641	15.649	ME03643	31.453				
kg	472		472		472		1011		1011					
4 boxes/ bultos  m3	3,31		3,31		3,31		14,27		14'27					

7500x1500	ME03644	9.925	ME03645	10.800	ME03646	10.833	ME03647	16.749	ME03649	34.095				
kg	481		481		481		1058		1058					
4 boxes/ bultos  m3	3,44		3,44		3,44		15,09		15'09					

PSTOP-TECH											
Top measures Medidas sobre											
	Up charge for TOP-TECH Power Box. Incremento por sistema eléctrico TOP-TECH.	Up charge for double USB charge. Installation included. Incremento por doble USB de carga. Instalación incluida.	Up charge for power socket. Installation included. Incremento por toma de alimentación. Instalación incluida.	***Marble shiny upcharge Incremento por mármol brillo.	Access panel for wiring up charge. Incremento por panel de acceso para cableado.	Oak base up charge Incremento por base de roble					
	€	€	€	€	€	€					
6500x1500	1.322	142	142	1.380	330	3.060					
7000x1500	1.347	142	142	1.380	330	3.060					
7500x1500	1.367	142	142	1.380	330	3.060					

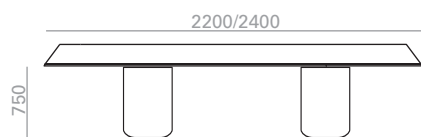

\*\*\*Marble shiny upcharge  
Incremento por mármol brillo

| 30 |



Height adjustable glides up charge  
Incremento por tacos reguladores

| 84 |

Column height / Altura columna																
Top measures Medidas sobre	Table top / Sobre														Top & Base	
	Oak Roble		s600	Lacquered Lacado		Laminate Laminado		Laminate TP Laminado Tp		*Top Technical Stone 8		Low Iron Glass Cristal óptico		Cement Cemento		
	Ref.	€	€	Ref.	€	Ref.	€	Ref.	€	Ref.	€	Ref.	€	Ref.	€	
2200x1200	ME03655	1.652	177	ME03656	1.324	ME03657	1.667	ME03658	1.589	ME03659	3.746	ME03660	2.589	ME03661	2.804	
kg	126		126		126		126		140		150		128			
2 boxes/ bultos  m3	0,84		0,84		0,84		0,84		3'69		3'69		0'84			

2400x1200	ME03668	1.694	195	ME03669	1.343	ME03670	1.694	ME03671	1.614	ME03672	3.893	ME03673	2.686	ME03674	2.904
kg	131		131		131		131		148		158		133		
2 boxes/ bultos  m3	0,88		0,88		0,88		0,88		3'97		3'97		0'88		

Column height / Altura columna										
Top measures Medidas sobre	Table top / Sobre									
	Linoleum Linoleo		Ultra-matte Ultramate		Ultra-matte TP Ultramate Tp		***Marble M1 Mármol M1		***Marble M3 Mármol M3	
	Ref.	€	Ref.	€	Ref.	€	Ref.	€	Ref.	€
2200x1200	ME03662	2.418	ME03663	2.244	ME03664	2.244	ME03665	4.120	ME03667	8.394
kg	128		126		126		284		284	
2 boxes/ bultos  m3	0,84		0,84		0,84		3,69		3'69	

Amount of sand: 80 kg. (2x40 kg.) /  
Cantidad de arena 80 kg. (2x40 kg.)

2400x1200	ME03675	2.510	ME03676	2.266	ME03677	2.296	ME03678	4.318	ME03680	9.001
kg	131		131		131		312		312	
2 boxes/ bultos  m3	0,88		0,88		0,88		3,97		3'97	

PSTOP-TECH						
Top measures Medidas sobre						
	Up charge for TOP-TECH Power Box. Incremento por sistema eléctrico TOP-TECH.	Up charge for double USB charge. Installation included. Incremento por doble USB de carga. Instalación incluida.	Up charge for power socket. Installation included. Incremento por toma de alimentación. Instalación incluida.	Bright lacquered base up charge. Incremento por base laca brillo.	Access panel for wiring up charge. Incremento por panel de acceso para cableado.	
	€	€	€	€	€	€
2200x1200	936	142	142	558	330	
2400x1200	948	142	142	558	330	





\*\*\*Marble shiny upcharge  
Incremento por mármol brillo

| 30 |



Height adjustable glides up charget  
Incremento por tacos reguladores

| 84 |

Column height / Altura columna																
Top measures Medidas sobre	Table top / Sobre														Top & Base	
	Oak Roble		s600	Lacquered Lacado		Laminate Laminado		Laminate TP Laminado Tp		*Top Technical Stone 8		Low Iron Glass Cristal óptico		Cement Cemento		
	Ref.	€	€	Ref.	€	Ref.	€	Ref.	€	Ref.	€	Ref.	€	Ref.	€	
2200x1200	ME03681	1.652	177	ME03682	1.324	ME03683	1.667	ME03684	1.589	ME03685	4.262	ME03686	2.685	ME03687	2.804	
kg	126			126			126			140			150		128	
2 boxes/ bultos  m3	0,84			0,84			0,84			3'69			3'69		0'84	

2400x1200	ME03694	1.694	195	ME03695	1.343	ME03696	1.694	ME03697	1.614	ME03698	4.439	ME03699	2.686	ME03700	2.904
kg	131			131			131			148			158		133
2 boxes/ bultos  m3	0,88			0,88			0,88			3'97			3'97		0'88

Column height / Altura columna										
Top measures Medidas sobre	Table top / Sobre									
	Linoleum Linoleo		Ultra-matte Ultramate		Ultra-matte TP Ultramate Tp		***Marble M1 Mármol M1		***Marble M3 Mármol M3	
	Ref.	€	Ref.	€	Ref.	€	Ref.	€	Ref.	€
2200x1200	ME03688	2.418	ME03689	2.244	ME03690	2.244	ME03691	4.696	ME03693	5.075
kg	128		126		126		284		284	
2 boxes/ bultos  m3	0,84		0,84		0,84		3,69		3'69	

Amount of sand: 80 kg. (2x40 kg.) /  
Cantidad de arena 80 kg. (2x40 kg.)

2400x1200	ME03701	2.510	ME03702	2.266	ME03703	2.296	ME03704	5.393	ME03706	9.001
kg	131		131		131		312		312	
2 boxes/ bultos  m3	0,88		0,88		0,88		3,97		3'97	

PSTOP-TECH										
Top measures Medidas sobre		Up charge for TOP-TECH Power Box. Incremento por sistema eléctrico TOP-TECH.		Up charge for double USB charge. Installation included. Incremento por doble USB de carga. Instalación incluida.		Up charge for power socket. Installation included. Incremento por toma de alimentación. Instalación incluida.		Bright lacquered base up charge. Incremento por base laca brillo.		Acces panel for wiring up charge. Incremento por panel de acceso para cableado.
2200x1200		936		142		142		558		330
2400x1200		948		142		142		558		330

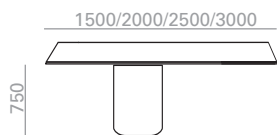

\*\*\*Marble shiny upcharge  
Incremento por mármol brillo

| 30 |



Height adjustable glides up charge  
Incremento por tacos reguladores

| 57 |

Column height / Altura columna															
Top measures Medidas sobre	Table top / Sobre												Top & Base		
	Oak Roble		s600	Lacquered Lacado		Laminate Laminado		Laminate TP Laminado Tp		*Top Technical Stone 8		Low Iron Glass Cristal óptico		Cement Cemento	
	Ref.	€	€	Ref.	€	Ref.	€	Ref.	€	Ref.	€	Ref.	€	Ref.	€
<b>1500x1500</b>	<b>ME03747</b>	1.300	162	<b>ME03748</b>	1.175	<b>ME03749</b>	1.232	<b>ME03750</b>	1.916	<b>ME03751</b>	3.105	<b>ME03752</b>	2.478	<b>ME03753</b>	2.306
kg	110		110		110		110		120		133		110		
<b>2 boxes/ bultos</b> m3	0,73		0,73		0,73		0,73		3'18		3'18		0'73		

<b>2000x1500</b>	<b>ME03757</b>	1.836	216	<b>ME03758</b>	1.262	<b>ME03759</b>	1.812	<b>ME03760</b>	1.960	<b>ME03761</b>	3.648	<b>ME03762</b>	2.817	<b>ME03763</b>	3.003
kg	129		129		129		129		139		159		129		
<b>2 boxes/ bultos</b> m3	0,86		0,86		0,86		0,86		4'03		4'03		0'86		

Amount of sand: 50 kg. /  
Cantidad de arena 50 kg.

Column height / Altura columna						
Top measures Medidas sobre	Table top / Sobre					
	Linoleum Linoleo		Ultra-matte Ultramate		Ultra-matte TP Ultramate Tp	
	Ref.	€	Ref.	€	Ref.	€
<b>1500x1500</b>	<b>ME03754</b>	2.435	<b>ME03755</b>	1.754	<b>ME03756</b>	1.728
kg	110		110		110	
<b>2 boxes/ bultos</b> m3	0,73		0,73		0,73	

<b>2000x1500</b>	<b>ME03764</b>	2.611	<b>ME03765</b>	2.925	<b>ME03766</b>	2.676
kg	129		129		129	
<b>2 boxes/ bultos</b> m3	0,86		0,86		0,86	

PSTOP-TECH									
Top measures Medidas sobre	Up charge for TOP-TECH Power Box. Incremento por sistema eléctrico TOP-TECH.	Up charge for double USB charge. Installation included. Incremento por doble USB de carga. Instalación incluida.	Up charge for power socket. Installation included. Incremento por toma de alimentación. Instalación incluida.	Incremento por base laca brillo.	Acces panel for wiring up charge. Incremento por panel de acceso para cableado.	Oak base up charge Incremento por base de roble			
	€	€	€	€	€	€			
<b>1500x1500</b>	885	142	142	297	330	1.530			
<b>2000x1500</b>	915	142	142	297	330	1.530			

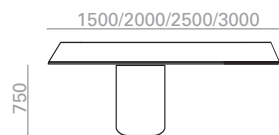

\*\*\*Marble shiny upcharge  
Incremento por mármol brillo

| 30 |



Height adjustable glides up charge  
Incremento por tacos reguladores

| 57 |

Column height / Altura columna															
Top measures Medidas sobre	Table top / Sobre													Top & Base	
	Oak Roble		s600	Lacquered Lacado		Laminate Laminado		Laminate TP Laminado Tp		*Top Technical Stone 8		Low Iron Glass Cristal óptico		Cement Cemento	
	Ref.	€	€	Ref.	€	Ref.	€	Ref.	€	Ref.	€	Ref.	€	Ref.	€
2500x1500	ME03767	1.962	264	ME03768	1.319	ME03769	1.833	ME03770	2.003	ME03771	4.108	ME03772	3.127	ME03773	3.337
kg	147		147		147		147		164		172		147		
2 boxes/ bultos  m3	1		1,14		1,14		1,14		1'82		1'82		1		

3000x1500	ME03777	2.006	306	ME03778	1.414	ME03779	1.864	ME03780	2.053	ME03781	4.680	ME03782	3.330	ME03783	3.670
kg	164		164		164		164		164		164		164		
2 boxes/ bultos  m3	1,14		1,14		1,14		1,14		1'88		2'07		1'14		

Amount of sand: 50 kg. /  
Cantidad de arena 50 kg.

Column height / Altura columna						
Top measures Medidas sobre	Table top / Sobre					
	Linoleum Linoleo		Ultra-matte Ultramate		Ultra-matte TP Ultramate Tp	
	Ref.	€	Ref.	€	Ref.	€
2500x1500	ME03774	2.825	ME03775	2.938	ME03776	2.711
kg	147		147		147	
2 boxes/ bultos  m3	1		1		1	

3000x1500	ME03784	3.063	ME03785	2.954	ME03786	2.759
kg	164		164		164	
2 boxes/ bultos  m3	1,14		1,14		1,14	

PSTOP-TECH									
Top measures Medidas sobre									
	Up charge for TOP-TECH Power Box. Incremento por sistema eléctrico TOP-TECH.	Up charge for double USB charge. Installation included. Incremento por doble USB de carga. Instalación incluida.	Up charge for power socket. Installation included. Incremento por toma de alimentación. Instalación incluida.	Incremento por base laca brillo.	Acces panel for wiring up charge. Incremento por panel de acceso para cableado.	Oak base up charge Incremento por base de roble			
	€	€	€	€	€	€			
2500x1500	947	142	142	297	330	1.530			
3000x1500	977	142	142	297	330	1.530			

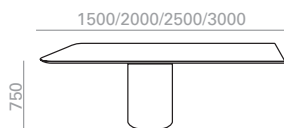

\*\*\*Marble shiny upcharge  
Incremento por mármol brillo

| 30 |



Height adjustable glides up charger  
Incremento por tacos reguladores

| 57 |

Column height / Altura columna															
Top measures Medidas sobre	Table top / Sobre												Top & Base		
	Oak Roble		s600	Lacquered Lacado		Laminate Laminado		Laminate TP Laminado Tp		*Top Technical Stone 8		Low Iron Glass Cristal óptico		Cement Cemento	
	Ref.	€	€	Ref.	€	Ref.	€	Ref.	€	Ref.	€	Ref.	€	Ref.	€
<b>1500x1500</b>	<b>ME03707</b>	1.300	162	<b>ME03708</b>	1.175	<b>ME03709</b>	1.232	<b>ME03710</b>	1.916	<b>ME03711</b>	3.386	<b>ME03712</b>	2.478	<b>ME03713</b>	2.306
kg	110		110		110		110		120		133		110		
<b>2 boxes/ bultos</b> m3	0,73		0,73		0,73		0,73		3'18		3'18		0'73		

<b>2000x1500</b>	<b>ME03717</b>	1.836	216	<b>ME03718</b>	1.262	<b>ME03719</b>	1.812	<b>ME03720</b>	1.960	<b>ME03721</b>	4.025	<b>ME03722</b>	2.817	<b>ME03723</b>	3.003
kg	129		129		129		129		139		159		129		
<b>2 boxes/ bultos</b> m3	0,86		0,86		0,86		0,86		4'03		4'03		0'86		

Amount of sand: 50 kg. /  
Cantidad de arena 50 kg.

Column height / Altura columna						
Top measures Medidas sobre	Table top / Sobre					
	Linoleum Linoleo		Ultra-matte Ultramate		Ultra-matte TP Ultramate Tp	
	Ref.	€	Ref.	€	Ref.	€
<b>1500x1500</b>	<b>ME03714</b>	2.435	<b>ME03715</b>	1.754	<b>ME03716</b>	1.728
kg	110		110		110	
<b>2 boxes/ bultos</b> m3	0,73		0,73		0,73	

<b>2000x1500</b>	<b>ME03724</b>	2.611	<b>ME03725</b>	2.925	<b>ME03726</b>	2.676
kg	129		129		129	
<b>2 boxes/ bultos</b> m3	0,86		0,86		0,86	

PSTOP-TECH									
Top measures Medidas sobre	Up charge for TOP-TECH Power Box. Incremento por sistema eléctrico TOP-TECH.	Up charge for double USB charge. Installation included. Incremento por doble USB de carga. Instalación incluida.	Up charge for power socket. Installation included. Incremento por toma de alimentación. Instalación incluida.	Incremento por base laca brillo.	Acces panel for wiring up charge. Incremento por panel de acceso para cableado.	Oak base up charge Incremento por base de roble			
	€	€	€	€	€	€			
<b>1500x1500</b>	885	142	142	297	330	1.530			
<b>2000x1500</b>	915	142	142	297	330	1.530			

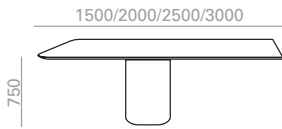

\*\*\*Marble shiny upcharge  
Incremento por mármol brillo

| 30 |



Height adjustable glides up charge  
Incremento por tacos reguladores

| 57 |

Column height / Altura columna																
Top measures Medidas sobre	Table top / Sobre														Top & Base	
	Oak Roble		s600	Lacquered Lacado		Laminate Laminado		Laminate TP Laminado Tp		*Top Technical Stone 8		Low Iron Glass Cristal óptico		Cement Cemento		
	Ref.	€	€	Ref.	€	Ref.	€	Ref.	€	Ref.	€	Ref.	€	Ref.	€	
2500x1500	ME03727	1.962	264	ME03728	1.319	ME03729	1.833	ME03730	2.003	ME03731	4.578	ME03732	3.127	ME03733	3.337	
kg	147		147		147		147		164		172		147			
2 boxes/ bultos  m3	1		1,14		1,14		1,14		1'82		1'82		1			

3000x1500	ME03737	2.006	306	ME03738	1.414	ME03739	1.864	ME03740	2.053	ME03741	5.247	ME03742	3.330	ME03743	3.670
kg	164		164		164		164		164		164		164		
2 boxes/ bultos  m3	1,14		1,14		1,14		1,14		1'88		2'07		1'14		

Column height / Altura columna						
Top measures Medidas sobre	Table top / Sobre					
	Linoleum Linoleo		Ultra-matte Ultramate		Ultra-matte TP Ultramate Tp	
	Ref.	€	Ref.	€	Ref.	€
2500x1500	ME03734	2.825	ME03735	2.938	ME03736	2.711
kg	147		147		147	
2 boxes/ bultos  m3	1		1		1	

Amount of sand: 50 kg. /  
Cantidad de arena 50 kg.

3000x1500	ME03744	3.063	ME03745	2.954	ME03746	2.759
kg	164		164		164	
2 boxes/ bultos  m3	1,14		1,14		1,14	

PSTOP-TECH									
Top measures Medidas sobre									
	Up charge for TOP-TECH Power Box. Incremento por sistema eléctrico TOP-TECH.	Up charge for double USB charge. Installation included. Incremento por doble USB de carga. Instalación incluida.	Up charge for power socket. Installation included. Incremento por toma de alimentación. Instalación incluida.	Incremento por base laca brillo.	Acces panel for wiring up charge. Incremento por panel de acceso para cableado.	Oak base up charge Incremento por base de roble			
	€	€	€	€	€	€			
2500x1500	947	142	142	297	330	1.530			
3000x1500	977	142	142	297	330	1.530			

## Maximum table heights Alturas máximas de mesa

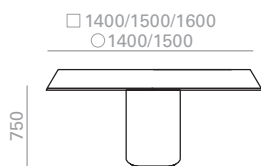
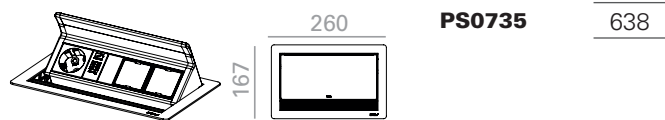

Table top				
Oak Roble	Lacquered Lacado	Laminate Laminado	Laminate TP Laminado Tp	Top Technical Stone 8
747	747	747	747	758

Table top				
Linoleum Linoleo	Ultra-matte Ultramate	Ultra-matte TP Ultramate Tp	***Marble M1 Mármol M1	Low Iron Glass Cristal óptico
747	747	747	752	755

## PS-IN SURFACE



**PS0735** 638

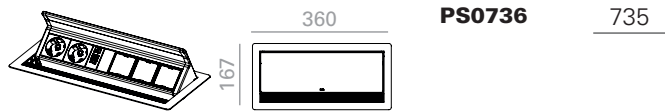

**PS0736** 735



**PS0804** 142

## PS-QI



**PS0714** 243

## Preinstalled (Optional) / Preinstalación (Opcional) IN0006

First installation / Primera instalación 270  
Second and more installations / Segunda y más instalaciones 90

## PS-UNDERTOP



**PS0787** 441



**PS0789** 510



**PS0788** 611



**PS0790** 659

## PS-INTREGATED

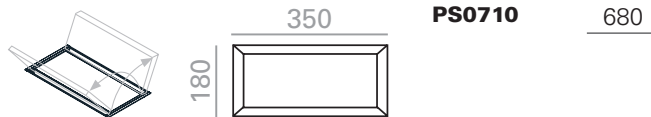

**PS0710** 680

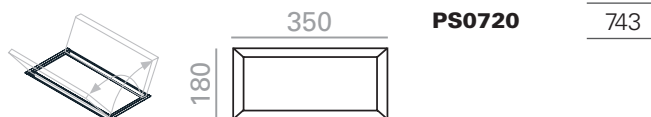

**PS0720** 743



**PS0795** 453



**PS0796** 468

**UNDERTOP-TECH POWER BOXES  
CAJA DE CONEXIONES BAJO EL SOBRE**

Power box mounted in the under-top. It is served in the same color as base, black or white. For other finishing, contact the customer department. There are two power system sizes available and data slots can be customized according to the below diagram.

El sistema va montado debajo de la tapa. Se sirve en el mismo acabado que las bases, blanco o negro. Para cualquier otro acabado contactar con el departamento comercial. Hay dos sistemas de alimentacion disponibles y las cantidades se pueden personalizar de acuerdo al diagrama inferior.

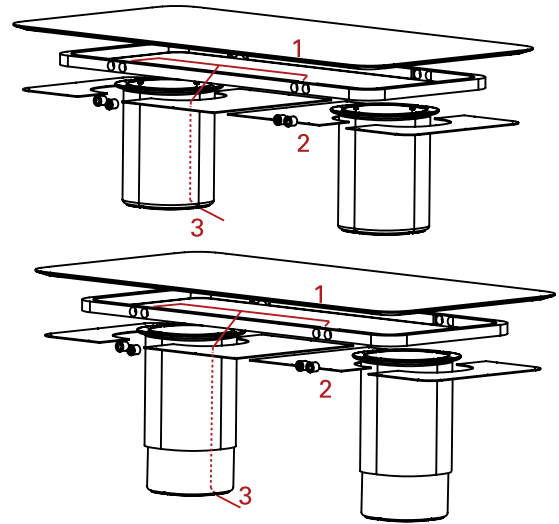
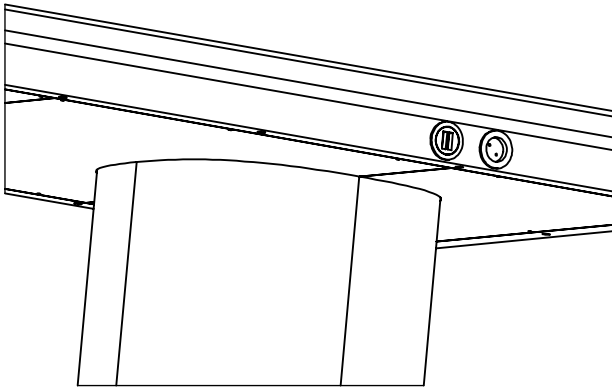

**1 POWER BOXES DISTRIBUTION DISTRIBUCIÓN DE SISTEMAS**

By default power box is placed in the center of the table and in lengthwise direction. If more than one power box is installed, inform the Customer Department about the desired position.

Por defecto la posición del sistema irá en el centro de la mesa y en sentido longitudinal. Si se solicita más de un sistema eléctrico, comunicar la posición deseada al Departamento Comercial.

2200-3500 (4 powers + 4 USB 2 charges)



4000-5000 (6 powers + 6 USB 2 charges)

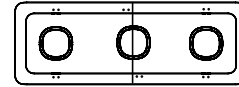

5500-7500 (8 powers + 8 USB 2 charges)

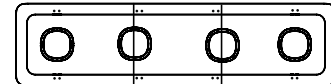

**2 WIRING MANAGEMENT GESTIÓN DEL CABLEADO**

Wire pass through an aluminum grommet keeping it hidden. By default color is silver, for other finishings ask the Customer Department.

El cable se pasa a través de un perfil pasacables de aluminio que lo mantiene oculto. Su color de serie es el plata, para otros acabados consultar al Departamento Comercial.

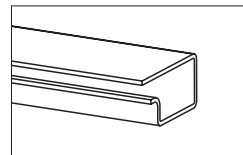

**3 CABLEWAY OUT SALIDA DE CABLEADO**

The cable way out can be performed directly from the power system or through a canal in the base bottom, so that is hidden until it gets to the floor.

La salida del cable se realiza directamente desde el propio sistema como por unas canalizaciones en la parte inferior de la base, de modo que el cable queda oculto hasta llegar al suelo.

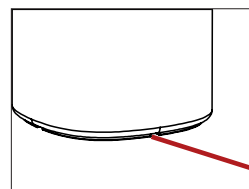



**IN-SURFACE POWER BOXES  
CAJAS DE CONEXIONES DENTRO DEL SOBRE**

Aluminum power box mounted in the table top with a folding protective lid. It is served in anodized silver, black or white, for other finishing, contact the Customer Department. There are two power system sizes available and data slots can be customized according to the below diagram.

Caja de conexiones de aluminio integrada dentro de la superficie del sobre con tapa abatible. Se sirve en color anodizado plata, negro o blanco, para otros acabados consultar al Departamento Comercial. Se ofrecen formatos de caja de dos tamaños de caja diferentes y con opciones de conectividad configurable.

**PS0735**

**PS0736**

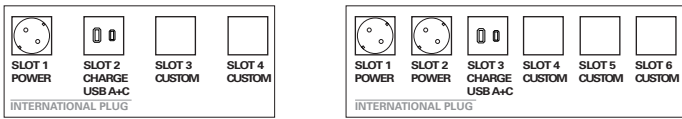

CHOOSE DATA PORT FOR DATA CUSTOM PORT SLOTS

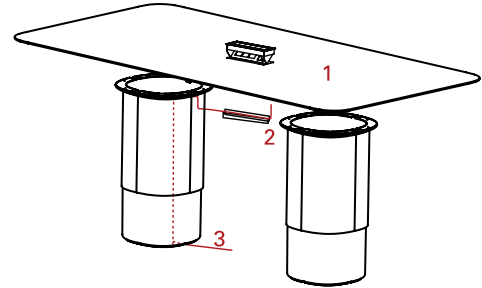
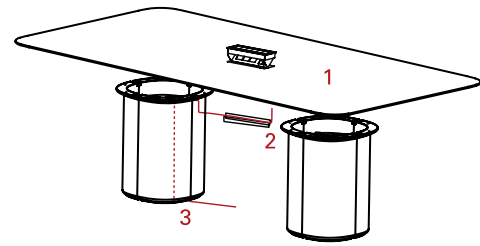
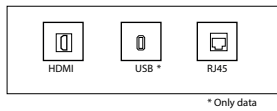

**1 POWER BOXES DISTRIBUTION DISTRIBUCIÓN DE SISTEMAS**

By standard, the position of the system will be in the central of the table, placed horizontally. When there are two system boxes, these will be separated 1/3 between them and placed horizontally. For other options, please contact the Customer Department.

De serie, la disposición del sistema será en el centro de la mesa y en sentido longitudinal. Cuando se disponga de dos sistemas, estos se colocarán con una separación de 1/3 de la longitud total de la mesa, y en sentido longitudinal. Otras opciones consultar con el Departamento Comercial.

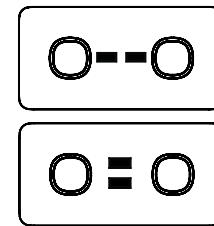

**OPTIONAL PREINSTALLED WIRING  
PREINSTALACIÓN DEL CABLEADO**

**IN0006**

Preinstalled wiring consists in the addition of the necessary mechanisms to integrate power systems in the table, so that wiring is hidden until the way out in the door. Necessary grommet are included and 3m cable (from the power system). For other cable dimensions contact the Customer Department.

La preinstalación consiste en el montaje de los mecanismos necesarios para integrar el sistema de electrificación en la mesa, de modo que el cableado quede oculto hasta su salida por la base. Se incluyen los pasacables necesarios y 3 metros de cable (midiendo desde el sistema de conexiones). Para otras longitudes de cable consultar al Departamento Comercial.

**2 WIRING MANAGEMENT GESTIÓN DEL CABLEADO**

Wire pass through an aluminum grommet keeping it hidden. By default color is silver, for other finishings ask the Customer Department.

El cable se pasa a través de un perfil pasacables de aluminio que lo mantiene oculto. Su color de serie es el plata, para otros acabados consultar al Departamento Comercial.

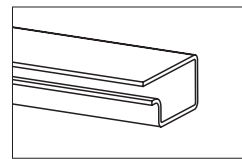

**3 CABLEWAY OUT SALIDA DE CABLEADO**

The cable way out can be performed directly from the power system or through a canal in the base bottom, so that is hidden until it gets to the floor.

La salida del cable se realiza directamente desde el propio sistema como por unas canalizaciones en la parte inferior de la base, de modo que el cable queda oculto hasta llegar al suelo.

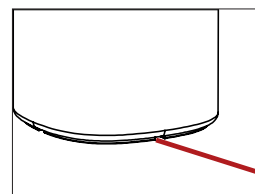

**IN-SURFACE SOCKET POWERS  
TORRES DE CONEXIONES DENTRO DEL SOBRE**

Socket tower mounted in the table top. The hidden system manually rises with a slight push. Available in silver, white or black color, for for other finishing, contact the Customer Department.

Torre de conexiones integrada dentro de la superficie del sobre. El sistema eléctrico oculto se alza manualmente al pulsarlo. Disponible en color plata, blanco o negro, para otros acabados consultar al Departamento Comercial.

**PS0795**

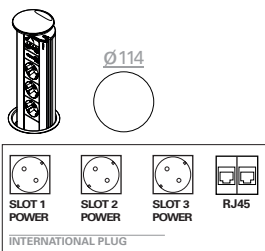

**PS0796**

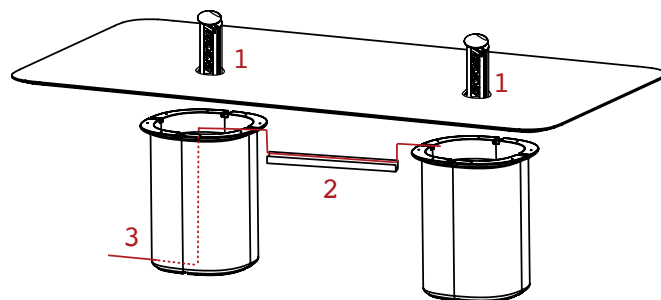
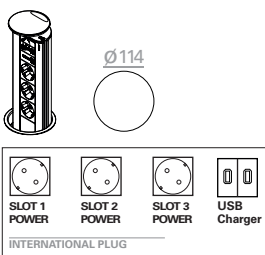

**1 POWER BOXES DISTRIBUTION DISTRIBUCIÓN DE SISTEMAS**

By standard, the position of the system will be in the central of the table, placed horizontally. When there are two system boxes, these will be separated 1/3 between them and placed horizontally. For other options, please contact the Customer Department.

En mesas con más de una base, por defecto la posición del sistema irá en el centro de la mesa y en sentido longitudinal. Si se solicita más de un sistema eléctrico, comunicar la posición deseada al Departamenteo Comercial.

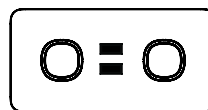
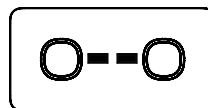

**2 WIRING MANAGEMENT GESTIÓN DEL CABLEADO**

Wire pass through an aluminum grommet keeping it hidden. By default color is silver, for other finishings ask the Customer Department.

El cable se pasa a través de un perfil pasacables de aluminio que lo mantiene oculto. Su color de serie es el plata, para otros acabados consultar al Departamento Comercial.

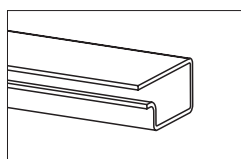

**3 CABLEWAY OUT SALIDA DE CABLEADO**

The cable way out can be performed directly from the power system or through a canal in the base bottom, so that is hidden until it gets to the floor.

La salida del cable se realiza directamente desde el propio sistema como por unas canalizaciones en la parte inferior de la base, de modo que el cable queda oculto hasta llegar al suelo.

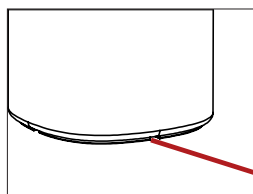

**OPTIONAL PREINSTALLED WIRING  
PREINSTALACIÓN DEL CABLEADO**

**IN0006**

Preinstalled wiring consists in the addition of the necessary mechanisms to integrate power systems in the table, so that wiring is hidden until the way out in the floor. Necessary grommet are included and 3m cable (from the power system). For other cable dimensions contact the Sales Department. For each wire Reverse base, you must ask for une IN0006 to the Customer Department.

La preinstalación consiste en el montaje de los mecanismos necesarios para integrar el sistema de electrificación en la mesa, de modo que el cableado quede oculto hasta su salida por la base. Se incluyen los pasacables necesarios y 3 metros de cable (midiendo desde el sistema de conexiones). Por cada base por al que se desee bajar el cable se solicita un IN0006 al Departamento Comercial.

**INTEGRATED POWER BOXES  
CAJAS DE CONEXIONES INTEGRADAS**

The black finish is integrated with the top. Its opening is towards both sides.

El acabado negro está integrado con la parte superior. Su apertura es hacia ambos lados.

**PS0710**

**PS0720**

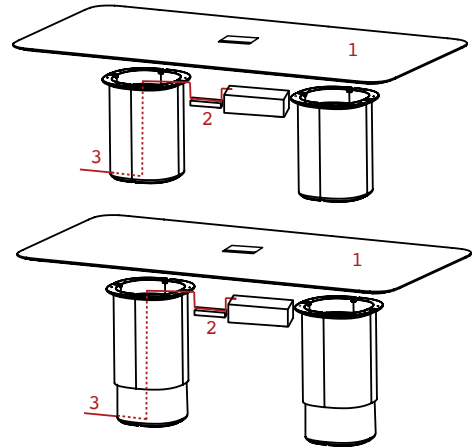
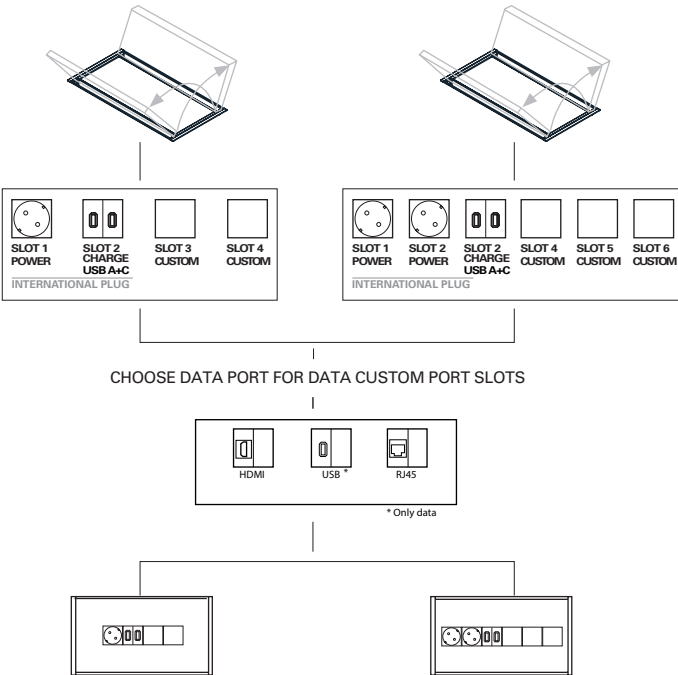

**1 POWER BOXES DISTRIBUTION DISTRIBUCIÓN DE SISTEMAS**

By standard, the position of the system will be in the central of the table, placed horizontally. When there are two system boxes, these will be separated 1/3 between them and placed horizontally. For other options, please contact the Customer Department.

De serie, la disposición del sistema será en el centro de la mesa y en sentido longitudinal. Cuando se disponga de dos sistemas, estos se colocarán con una separación de 1/3 de la longitud total de la mesa, y en sentido longitudinal. Otras opciones consultar con el Departamento Comercial.

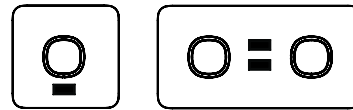

**2 WIRING MANAGEMENT GESTIÓN DEL CABLEADO**

Wire pass through an aluminum grommet keeping it hidden. By default color is silver, for other finishings ask the Customer Department.

El cable se pasa a través de un perfil pasacables de aluminio que lo mantiene oculto. Su color de serie es el plata, para otros acabados consultar al Departamento Comercial.

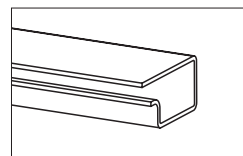

**OPTIONAL PREINSTALLED WIRING  
PREINSTALACIÓN DEL CABLEADO**

**IN0006**

Preinstalled wiring consists in the addition of the necessary mechanisms to integrate power systems in the table, so that wiring is hidden until the way out in the door. Necessary grommet are included and 3m cable (from the power system). For other cable dimensions contact the Customer Department.

La preinstalación consiste en el montaje de los mecanismos necesarios para integrar el sistema de electrificación en la mesa, de modo que el cableado quede oculto hasta su salida por la base. Se incluyen los pasacables necesarios y 3 metros de cable (midiendo desde el sistema de conexiones). Para otras longitudes de cable consultar al Departamento Comercial.

**3 CABLE WAY OUT SALIDA DE CABLEADO**

The cable way out can be performed directly from the power system or through a canal in the base bottom, so that is hidden until it gets to the floor.

La salida del cable se realiza directamente desde el propio sistema como por unas canalizaciones en la parte inferior de la base, de modo que el cable queda oculto hasta llegar al suelo.

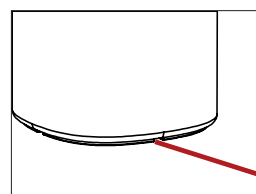

**IN-SURFACE POWER BOXES  
CAJAS DE CONEXIONES DENTRO DEL SOBRE**

It is a data dynamo with 2 amp dual charging USB. Available in two finish: black or white.

Es una dínamo de datos con 2 amp de carga dual USB. Disponible en dos acabados: negro o blanco.

**PS0804**

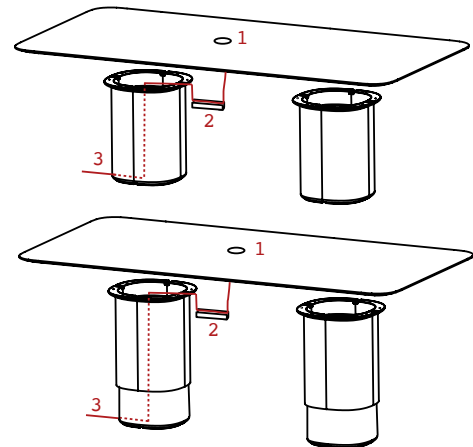
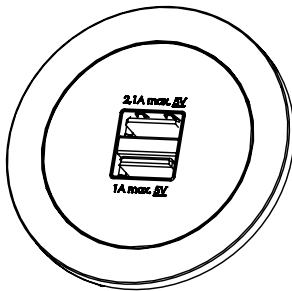

**1 POWER BOXES DISTRIBUTION DISTRIBUCIÓN DE SISTEMAS**

By standard, the position of the system will be in the central of the table, placed horizontally. When there are two system boxes, these will be separated 1/3 between them and placed horizontally. For other options, please contact the Customer Department.

De serie, la disposición del sistema será en el centro de la mesa y en sentido longitudinal. Cuando se disponga de dos sistemas, estos se colocarán con una separación de 1/3 de la longitud total de la mesa, y en sentido longitudinal. Otras opciones consultar con el Departamento Comercial.

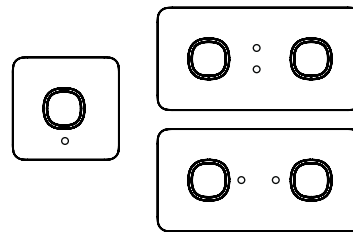

**OPTIONAL PREINSTALLED WIRING  
PREINSTALACIÓN DEL CABLEADO**

**IN0006**

Preinstalled wiring consists in the addition of the necessary mechanisms to integrate power systems in the table, so that wiring is hidden until the way out in the door. Necessary grommet are included and 3m cable (from the power system). For other cable dimensions contact the Customer Department.

La preinstalación consiste en el montaje de los mecanismos necesarios para integrar el sistema de electrificación en la mesa, de modo que el cableado quede oculto hasta su salida por la base. Se incluyen los pasacables necesarios y 3 metros de cable (midiendo desde el sistema de conexiones). Para otras longitudes de cable consultar al Departamento Comercial.

**2 WIRING MANAGEMENT GESTIÓN DEL CABLEADO**

Wire pass through an aluminum grommet keeping it hidden. By default color is silver, for other finishings ask the Customer Department.

El cable se pasa a través de un perfil pasacables de aluminio que lo mantiene oculto. Su color de serie es el plata, para otros acabados consultar al Departamento Comercial.

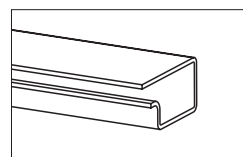

**3 CABLE WAY OUT SALIDA DE CABLEADO**

The cable way out can be performed directly from the power system or through a canal in the base bottom, so that is hidden until it gets to the floor.

La salida del cable se realiza directamente desde el propio sistema como por unas canalizaciones en la parte inferior de la base, de modo que el cable queda oculto hasta llegar al suelo.

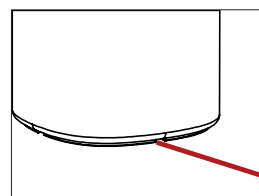

**UNDER-TOP POWER BOXES  
CAJA DE CONEXIONES BAJO EL SOBRE**

Power box mounted under the table top. Available in black or white color (silver or black in USA), for other finishing, contact the Customer Department. There are two power system sizes available and data slots can be customized according to the below diagram.

Regleta de conexiones bajo la superficie del sobre. Se sirve en color negro o blanco (plata o negro en USA. Para otros acabados consultar al departamento comercial. Se ofrecen formatos de caja de dos tamaños de caja diferentes y con opciones de conectividad configurable.

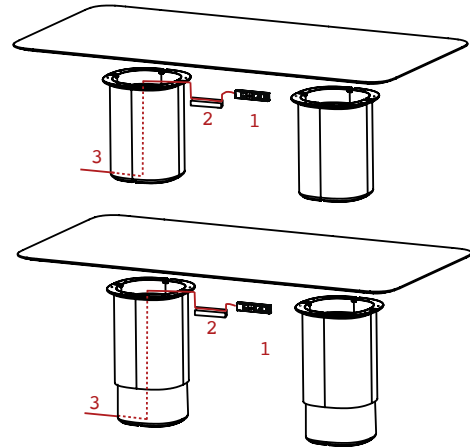

**1 POWER BOXES DISTRIBUTION DISTRIBUCIÓN DE SISTEMAS**

By default power box is placed in the center of the table and in lengthwise direction. If more than one power box is installed, inform the Customer Department about the desired position.

De serie, el sistema se instala a la izquierda de la mesa, orientado hacia la pata opuesta, y el cable bajaría por al misma pata. Para distribuciones especiales consultar al Departamento Comercial.

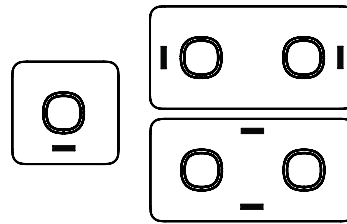

**2 WIRING MANAGEMENT GESTIÓN DEL CABLEADO**

Wire pass through an aluminum grommet keeping it hidden. By default color is silver, for other finishings ask the Customer Department.

El cable se pasa a través de un perfil pasacables de aluminio que lo mantiene oculto. Su color de serie es el plata, para otros acabados consultar al Departamento Comercial.

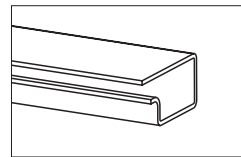

**3 CABLE WAY OUT SALIDA DE CABLEADO**

The cable way out can be performed directly from the power system or through a canal in the base bottom, so that is hidden until it gets to the floor.

La salida del cable se realiza directamente desde el propio sistema como por unas canalizaciones en la parte inferior de la base, de modo que el cable queda oculto hasta llegar al suelo.

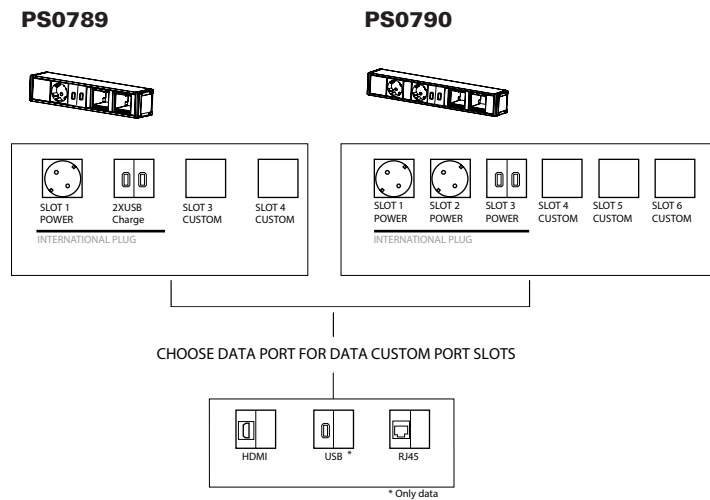
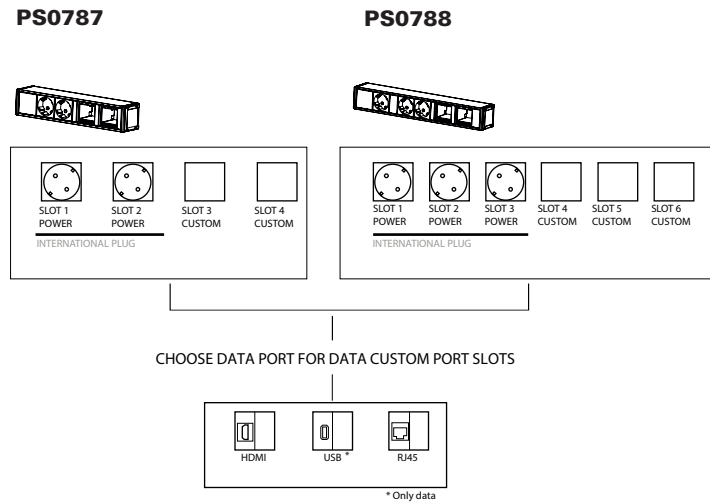
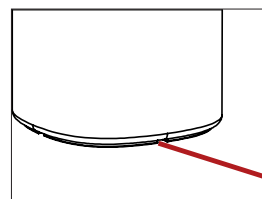

**OPTIONAL PREINSTALLED WIRING  
PREINSTALACIÓN DEL CABLEADO**

**IN0006**

Preinstalled wiring consists in the addition of the necessary mechanisms to integrate power systems in the table, so that wiring is hidden until the way out in the door. Necessary grommet are included and 3m cable (from the power system). For other cable dimensions contact the Customer Department.

La preinstalación consiste en el montaje de los mecanismos necesarios para integrar el sistema de electrificación en la mesa, de modo que el cableado quede oculto hasta su salida por la base. Se incluyen los pasacables necesarios y 3 metros de cable (midiéndolo desde el sistema de conexiones). Para otras longitudes de cable consultar al Departamento Comercial.



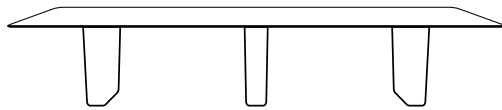

**Description**  
**Descripción**

Table program available with different types of bases and table tops. Pure Eco thermo-polymer (100% recycled) bases available in several colors. Table tops in several shapes and sizes available in various finishes.

Programa de mesas disponible con diferentes tipos de bases y sobres de mesa. Bases de termopolímero Pure Eco (100% reciclado) disponible en diferentes colores. Sobres de tablero de diferentes formas y medidas disponible en diferentes acabados.

**Wood finish Oak**  
**Acabado madera Roble**



**Wood lacquer finish**  
**Acabado lacas madera**



**Laminated**  
**Laminado**



**Laminated TP**  
**Laminado TP**

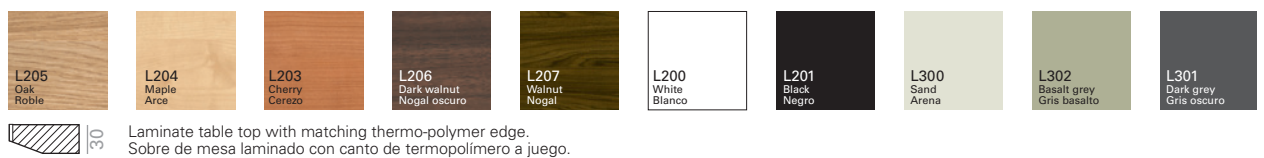

**Glass finish**  
**Acabado de cristal**

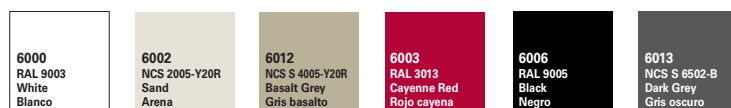

**Technical Stone 8**  
**Acabado Technical Stone 8**

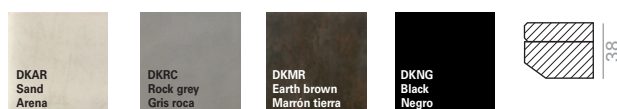

**M1 marble finish**  
**Acabado de mármol M1**



**M3 marble finish**  
**Acabado de mármol M3**



**Ultra-matte finish**  
**Acabado ultramate**

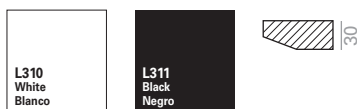

**Linoleum finish**  
**Acabado linóleo**

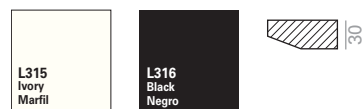

**Pure Eco Thermo-polymer finish**  
**Acabado de Termopolímero Pure Eco**

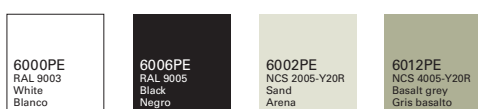

**Power box**  
**Caja de conexiones**



**Intellectual property Propiedad intelectual**

All our collections are protected by international industrial design registries, designs patents, copyrights and intellectual Property laws. Unauthorized use of AW International Property is a criminal offence and can lead to prosecution.  
Todas nuestras colecciones están protegidas por registros de diseño industrial, diseño de patente, copyright y derechos de propiedad intelectual todo el mundo. El uso no autorizado de los diseños y propiedad intelectual de AW supone un delito que puede ser sometido a acción judicial.



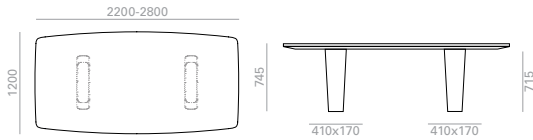

Height adjustable  
glides up charger  
Incremento por tacos  
reguladores

84

\*\*\*Marble shiny  
upcharge  
Incremento por  
mármol brillo

30

Amount of sand: 50 kg.(2x25 kg.)  
Cantidad de arena 50 kg.(2x25 kg.)

Top measures Medidas sobre	Table top / Sobre												
	Oak Roble		s600	Lacquered Lacado		Laminate Laminado		LaminateTP Laminado TP		Top Technical Stone 8		Low Iron Glass Cristal Óptico	
	Ref.	€	€	Ref.	€	Ref.	€	Ref.	€	Ref.	€	Ref.	€
<b>2200x1200</b>	<b>ME02000</b>	1.940	209	<b>ME02001</b>	1.602	<b>ME02002</b>	1.884	<b>ME02003</b>	1.808	<b>ME02004</b>	4.298	<b>ME02005</b>	2.480
kg	132'04		132'04		132'04		132'04		228'4		215'2		
<b>2 boxes / bultos</b>	1'44 m3		1'44 m3		1'44 m3		1'44 m3		3'91 m3		1'56 m3		
<b>2400x1200</b>	<b>ME02012</b>	1.996	230	<b>ME02013</b>	1.650	<b>ME02014</b>	1.925	<b>ME02015</b>	1.846	<b>ME02016</b>	4.506	<b>ME02017</b>	2.993
kg	137'68		137'68		137'68		137'68		242'8		228'4		
<b>2 boxes / bultos</b>	1'48 m3		1'48 m3		1'48 m3		1'48 m3		4'19 m3		1'64 m3		
<b>2600x1200</b>	<b>ME02024</b>	2.594	309	<b>ME02025</b>	1.880	<b>ME02026</b>	2.384	<b>ME02027</b>	2.530	<b>ME02028</b>	5.185	<b>ME02029</b>	3.289
kg	143'32		143'32		143'32		143'32		257'2		241'6		
<b>2 boxes / bultos</b>	1'53 m3		1'53 m3		1'53 m3		1'53 m3		4'47 m3		4'47 m3		
<b>2800x1200</b>	<b>ME02036</b>	2.629	335	<b>ME02037</b>	1.949	<b>ME02038</b>	2.402	<b>ME02039</b>	2.567	<b>ME02040</b>	5.401	<b>ME02041</b>	3.507
kg	148'96		148'96		148'96		148'96		271'6		254'8		
<b>2 boxes / bultos</b>	1'57 m3		1'57 m3		1'57 m3		1'57 m3		4'75 m3		4'75 m3		

Top measures Medidas sobre	Table top / Sobre									
	Linoleum Linóleo		Ultra-matte Ultramate		Ultra-matteTP UltramateTP		***Marble M3 Mármol M3		***M1 Marble Mármol M1	
	Ref.	€	Ref.	€	Ref.	€	Ref.	€	Ref.	€
<b>2200x1200</b>	<b>ME02006</b>	2.510	<b>ME02007</b>	2.664	<b>ME02008</b>	2.556	<b>ME02009</b>	8.404	<b>ME02011</b>	5.058
kg	132'04		132'04		132'04		228'4		228'4	
<b>2 boxes / bultos</b>	1'44 m3		1'44 m3		1'44 m3		3'91 m3		3'91 m3	
<b>2400x1200</b>	<b>ME02018</b>	2.622	<b>ME02019</b>	2.737	<b>ME02020</b>	2.594	<b>ME02021</b>	8.679	<b>ME02023</b>	5.320
kg	137'68		137'68		137'68		242'8		242'8	
<b>2 boxes / bultos</b>	1'48 m3		1'48 m3		1'48 m3		4'19 m3		4'19 m3	
<b>2600x1200</b>	<b>ME02030</b>	3.315	<b>ME02031</b>	3.747	<b>ME02032</b>	3.485	<b>ME02033</b>	10.553	<b>ME02035</b>	6.224
kg	143'32		143'32		143'32		257'2		257'2	
<b>2 boxes / bultos</b>	1'53 m3		1'53 m3		1'53 m3		4'47 m3		4'77 m3	
<b>2800x1200</b>	<b>ME02042</b>	3.470	<b>ME02043</b>	3.767	<b>ME02044</b>	3.522	<b>ME02045</b>	10.843	<b>ME02047</b>	6.511
kg	148'96		148'96		148'96		271'6		271'6	
<b>2 boxes / bultos</b>	1'57 m3		1'57 m3		1'57 m3		4'75 m3		4'75 m3	

PSTOP-TECH

Top measures Medidas sobre					
	Up charge forTOP-TECH Power Box. Incremento por sistema eléctrico TOP-TECH.	Up charge for double USB charge. Installation included. Incremento por doble USB de carga. Instalación incluida.	Up charge for power socket. Installation included. Incremento por toma de alimentación. Instalación incluida.	Bright lacquered base up charge. Incremento por base laca brillo.	Acces panel for wiring up charge. Incremento por panel de acceso para cableado.
	€	€	€	€	€
<b>2200x1200</b>	725	142	142	544	330
<b>2400x1200</b>	735	142	142	544	330
<b>2600x1200</b>	744	142	142	544	330
<b>2800x1200</b>	754	142	142	544	330



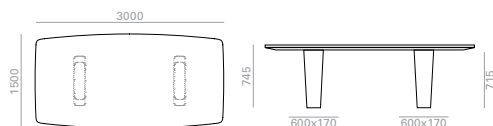

Height adjustable glides up charger  
Incremento por tacos reguladores

| 84 |

\*\*\*Marble shiny upcharge  
Incremento por mármol brillo

| 30 |

Amount of sand: 50 kg.(2x25 kg.)  
Cantidad de arena 50 kg.(2x25 kg.)

Top measures Medidas sobre	Table top / Sobre										
	Oak Roble		s600	Lacquered Lacado		Laminate Laminado		Laminate TP Laminado TP		Low Iron Glass Cristal Óptico	
	Ref.	€	€	Ref.	€	Ref.	€	Ref.	€	Ref.	€
3000x1500	ME02048	2.679	360	ME02049	2.031	ME02050	2.463	ME02051	2.657	ME02052	4.025
kg	175'75			175'75		175'75		175'75		317'5	
2 boxes / bultos	1'85 m3			1'85 m3		1'85 m3		1'85 m3		6'01 m3	

Top measures Medidas sobre	Table top / Sobre									
	Linoleum Linóleo		Ultra-matte Ultramate		Ultra-matte TP Ultramate TP		***Marble M3 Mármol M3		***M1 Marble Mármol M1	
	Ref.	€	Ref.	€	Ref.	€	Ref.	€	Ref.	€
3000x1500	ME02053	3.515	ME02054	3.815	ME02055	3.581	ME02056	15.214	ME02058	8.127
kg	175'75		175'75		175'75		340		340	
2 boxes / bultos	1'85 m3		1'85 m3		1'85 m3		6'01 m3		6'01 m3	

PSTOP-TECH										
Top measures Medidas sobre		Up charge for TOP-TECH Power Box. Incremento por sistema eléctrico TOP-TECH.		Up charge for double USB charge. Installation included. Incremento por doble USB de carga. Instalación incluida.		Up charge for power socket. Installation included. Incremento por toma de alimentación. Instalación incluida.		Bright lacquered base up charge. Incremento por base laca brillo.		Acces panel for wiring up charge. Incremento por panel de acceso para cableado.
		€		€		€		€		€
3000x1500		800		142		142		646		330

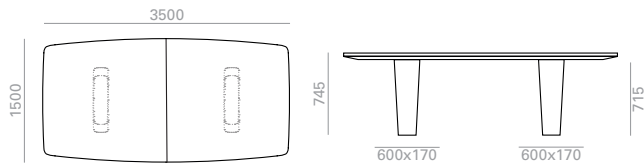

Height adjustable  
glides up charget  
Incremento por tacos  
reguladores

| 84 |

\*\*\*Marble shiny  
upcharge  
Incremento por  
mármol brillo

| 30 |

Amount of sand: 50 kg.(2x25 kg.)  
Cantidad de arena 50 kg.(2x25 kg.)

Top measures Medidas sobre	Table top / Sobre										
	Oak Roble		s600	Lacquered Lacado		Laminate Laminado		LaminateTP LaminadoTP		Low Iron Glass Cristal Óptico	
	Ref.	€	€	Ref.	€	Ref.	€	Ref.	€	Ref.	€
3500x1500	ME02059	4.105	420	ME02060	2.465	ME02061	3.853	ME02062	4.059	ME02063	4.888
kg	223'38		223'38		223'38		223'38		388'75		
3 boxes / bultos	1'6 m3		1'6 m3		1'6 m3		1'6 m3		2'56 m3		

Top measures Medidas sobre	Table top / Sobre									
	Linoleum Linóleo		Ultra-matte Ultramate		Ultra-matte TP UltramateTP		***Marble M3 Mármol M3		***M1 Marble Mármol M1	
	Ref.	€	Ref.	€	Ref.	€	Ref.	€	Ref.	€
3500x1500	ME02064	6.101	ME02065	6.558	ME02066	5.931	ME02067	17.825	ME02069	9.560
kg	223'38		223'38		223'38		415		415	
3 boxes / bultos	1'6 m3		1'6 m3		1'6 m3		7'2 m3		7'2 m3	

PSTOP-TECH										
Top measures Medidas sobre		Up charge forTOP-TECH Power Box. Incremento por sistema eléctrico TOP-TECH.		Up charge for double USB charge. Installation included. Incremento por doble USB de carga. Instalación incluida.		Up charge for power socket. Installation included. Incremento por toma de alimentación. Instalación incluida.		Bright lacquered base up charge. Incremento por base laca brillo.		Acces panel for wiring up charge. Incremento por panel de acceso para cableado.
	€		€		€		€		€	
	3500x1500	1.003		142		142		646		330

Top measures Medidas sobre	Table top / Sobre										
	Oak Roble		s600	Lacquered Lacado		Laminate Laminado		LaminateTP LaminadoTP		Low Iron Glass Cristal Óptico	
	Ref.	€	€	Ref.	€	Ref.	€	Ref.	€	Ref.	€
4000x1500	ME02070	4.335	480	ME02071	2.754	ME02072	4.073	ME02073	4.298	ME02074	5.584
kg	241		241		241		241		430		
3 boxes / bultos	1'97 m3		1'97 m3		1'97 m3		1'97 m3		8'28 m3		
4500x1500	ME02081	4.459	539	ME02082	2.926	ME02083	4.157	ME02084	4.410	ME02085	5.962
kg	258'62		258'62		258'62		258'62		471'25		
3 boxes / bultos	2'11 m3		2'11 m3		2'11 m3		2'11 m3		9'51 m3		
5000x1500	ME02092	4.554	599	ME02093	3.088	ME02094	4.229	ME02095	4.592	ME02096	6.474
kg	276'25		276'25		276'25		276'25		512'5		
3 boxes / bultos	2'25 m3		2'25 m3		2'25 m3		2'25 m3		9'98 m3		
5500x1500	ME02103	4.636	659	ME02104	3.291	ME02105	4.301	ME02106	4.625	ME02107	6.951
kg	287'53		293'88		293'88		293'88		553'75		
3 boxes / bultos	2'38 m3		2'38 m3		2'38 m3		2'38 m3		10'83 m3		
6000x1500	ME02114	4.717	719	ME02115	3.460	ME02116	4.375	ME02117	4.719	ME02118	7.641
kg	311'5		311'5		311'5		311'5		595		
3 boxes / bultos	2'52 m3		2'52 m3		2'52 m3		2'52 m3		11'68 m3		

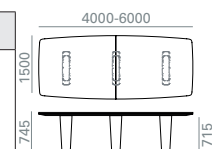

Height adjustable glides up charger  
Incremento por tacos reguladores

| 84 |

\*\*\*Marble shiny upcharge  
Incremento por mármol brillo

| 30 |

Amount of sand:  
150 kg.(3x50 kg.)  
Cantidad de arena  
150 kg.(3x50 kg.)

Top measures Medidas sobre	Table top / Sobre									
	Linoleum Linóleo		Ultra-matte Ultramate		Ultra-matte TP UltramateTP		***Marble M3 Mármol M3		***M1 Marble Mármol M1	
	Ref.	€	Ref.	€	Ref.	€	Ref.	€	Ref.	€
4000x1500	ME02075	6.323	ME02076	6.779	ME02077	6.180	ME02078	20.652	ME02080	11.592
kg	241		241		241		460		460	
3 boxes / bultos	1'97 m3		1'97 m3		1'97 m3		8'28 m3		8'28 m3	
4500x1500	ME02086	6.420	ME02087	6.869	ME02088	6.209	ME02089	21.331	ME02091	11.484
kg	258'62		258'62		258'62		505		505	
3 boxes / bultos	2'11 m3		2'11 m3		2'11 m3		9'13 m3		9'13 m3	
5000x1500	ME02097	6.508	ME02098	6.941	ME02099	6.387	ME02100	22.945	ME02102	12.311
kg	276'25		276'25		276'25		550		550	
3 boxes / bultos	2'25 m3		2'25 m3		2'25 m3		9'98 m3		9'98 m3	
5500x1500	ME02108	6.609	ME02109	7.788	ME02110	6.515	ME02111	24.587	ME02113	13.161
kg	293'88		293'88		293'88		595		595	
3 boxes / bultos	16'61 m3		16'61 m3		16'61 m3		10'83 m3		10'83 m3	
6000x1500	ME02119	6.684	ME02120	7.662	ME02121	6.610	ME02122	26.201	ME02124	13.990
kg	311'5		311'5		311'5		640		640	
3 boxes / bultos	2'52 m3		2'52 m3		2'52 m3		11'68 m3		11'68 m3	

PSTOP-TECH

Top measures Medidas sobre					
	Up charge for TOP-TECH Power Box. Incremento por sistema eléctrico TOP-TECH.	Up charge for double USB charge. Installation included. Incremento por doble USB de carga. Instalación incluida.	Up charge for power socket. Installation included. Incremento por toma de alimentación. Instalación incluida.	Bright lacquered base up charge. Incremento por base laca brillo.	Access panel for wiring up charge. Incremento por panel de acceso para cableado.
	€	€	€	€	€
4000x1500	1.025	142	142	969	330
4500x1500	1.047	142	142	969	330
5000x1500	1.070	142	142	969	330
5500x1500	1.093	142	142	969	330
6000x1500	1.131	142	142	969	330

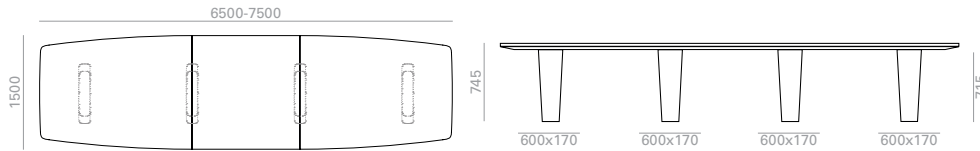

Height adjustable glides up charger  
Incremento por tacos reguladores

\*\*\*Marble shiny upcharge  
Incremento por mármol brillo

| 168 |

| 30 |

Amount of sand: 200 kg.(4x50 kg.)  
Cantidad de arena 200 kg.(4x50 kg.)

Top measures Medidas sobre	Table top / Sobre										
	Oak Roble		s600	Lacquered Lacado		Laminate Laminado		Laminate TP Laminado TP		Low Iron Glass Cristal Óptico	
	Ref.	€	€	Ref.	€	Ref.	€	Ref.	€	Ref.	€
6500x1500	ME02125	6.313	779	ME02126	3.998	ME02127	5.903	ME02128	6.221	ME02129	8.520
kg	359'12			359'12			359'12			666'25	
4 boxes / bultos	2'96 m3			2'96 m3			2'96 m3			4'84 m3	
7000x1500	ME02136	6.404	839	ME02137	4.121	ME02138	5.971	ME02139	6.309	ME02140	9.040
kg	376'75			376'75			376'75			707'5	
4 boxes / bultos	3'09 m3			3'09 m3			3'09 m3			4'94 m3	
7500x1500	ME02147	6.498	899	ME02148	4.247	ME02149	6.094	ME02150	6.413	ME02151	9.343
kg	394'38			394'38			394'38			748'75	
4 boxes / bultos	3'23 m3			3'23 m3			3'23 m3			14'84 m3	

Top measures Medidas sobre	Table top / Sobre									
	Linoleum Linóleo		Ultra-matte Ultramate		Ultra-matte TP Ultramate TP		***Marble M3 Mármol M3		***M1 Marble Mármol M1	
	Ref.	€	Ref.	€	Ref.	€	Ref.	€	Ref.	€
6500x1500	ME02130	9.455	ME02131	10.003	ME02132	9.090	ME02133	31.545	ME02135	16.181
kg	359'12		359'12		359'12		715		715	
4 boxes / bultos	2'96 m3		2'96 m3		2'96 m3		13'66 m3		13'66 m3	
7000x1500	ME02141	9.557	ME02142	10.075	ME02143	9.184	ME02144	33.170	ME02146	17.190
kg	376'75		376'75		376'75		760		760	
4 boxes / bultos	3'09 m3		3'09 m3		3'09 m3		13'97 m3		13'97 m3	
7500x1500	ME02152	9.634	ME02153	10.142	ME02154	9.289	ME02155	35.942	ME02157	18.219
kg	394'38		394'38		394'38		805		805	
4 boxes / bultos	3'23 m3		3'23 m3		3'23 m3		14'84 m3		14'84 m3	

PSTOP-TECH										
Top measures Medidas sobre		Up charge for TOP-TECH Power Box. Incremento por sistema eléctrico TOP-TECH.		Up charge for double USB charge. Installation included. Incremento por doble USB de carga. Instalación incluida.		Up charge for power socket. Installation included. Incremento por toma de alimentación. Instalación incluida.		Bright lacquered base up charge. Incremento por base laca brillo.		Acces panel for wiring up charge. Incremento por panel de acceso para cableado.
	€	€	€	€	€	€				
	6500x1500	1.387	142	142	1.292	330				
7000x1500	1.411	142	142	1.292	330					
7500x1500	1.432	142	142	1.292	330					

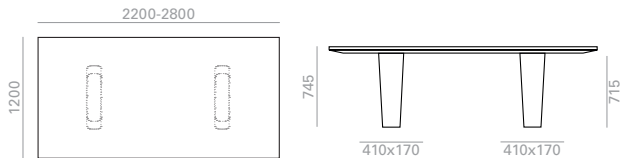

Height adjustable  
glides up charger  
Incremento por tacos  
reguladores

| 84 |

\*\*\*Marble shiny  
upcharge  
Incremento por  
mármol brillo

| 30 |

Amount of sand: 150 kg.(3x50 kg.)  
Cantidad de arena 150 kg.(3x50 kg.)

Top measures Medidas sobre	Table top / Sobre												
	Oak Roble		s600	Lacquered Lacado		Laminate Laminado		Laminate TP Laminado TP		Top Technical Stone 8		Low Iron Glass Cristal Óptico	
	Ref.	€	€	Ref.	€	Ref.	€	Ref.	€	Ref.	€	Ref.	€
2200x1200	ME02158	1.929	209	ME02159	1.592	ME02160	1.920	ME02161	1.846	ME02162	4.119	ME02163	2.376
kg	132'04		132'04		132'04		132'04		228'4		215'2		
2 boxes / bultos	1'44 m3		1'44 m3		1'44 m3		1'44 m3		3'91 m3		1'56 m3		
2400x1200	ME02170	1.985	230	ME02171	1.641	ME02172	1.961	ME02173	1.882	ME02174	4.279	ME02175	2.966
kg	137'68		137'68		137'68		137'68		242'8		228'4		
2 boxes / bultos	1'48 m3		1'48 m3		1'48 m3		1'48 m3		4'19 m3		1'64 m3		
2600x1200	ME02182	2.581	309	ME02183	1.872	ME02184	2.431	ME02185	2.581	ME02186	4.846	ME02187	3.163
kg	143'32		143'32		143'32		143'32		257'2		241'6		
2 boxes / bultos	1'53 m3		1'53 m3		1'53 m3		1'53 m3		4'47 m3		4'47 m3		
2800x1200	ME02194	2.614	335	ME02195	1.941	ME02196	2.451	ME02197	2.618	ME02198	5.172	ME02199	3.486
kg	148'96		148'96		148'96		148'96		271'6		254'8		
2 boxes / bultos	1'57 m3		1'57 m3		1'57 m3		1'57 m3		4'75 m3		4'75 m3		

Top measures Medidas sobre	Table top / Sobre									
	Linoleum Linóleo		Ultra-matte Ultramate		Ultra-matte TP Ultramate TP		***Marble M3 Mármol M3		***M1 Marble Mármol M1	
	Ref.	€	Ref.	€	Ref.	€	Ref.	€	Ref.	€
2200x1200	ME02164	2.487	ME02165	2.638	ME02166	2.530	ME02167	7.990	ME02169	4.628
kg	132'04		132'04		132'04		228'4		228'4	
2 boxes / bultos	1'44 m3		1'44 m3		1'44 m3		3'91 m3		3'91 m3	
2400x1200	ME02176	2.596	ME02177	2.711	ME02178	2.592	ME02179	8.234	ME02181	4.878
kg	137'68		137'68		137'68		242'8		242'8	
2 boxes / bultos	1'48 m3		1'48 m3		1'48 m3		4'19 m3		4'19 m3	
2600x1200	ME02188	3.282	ME02189	3.710	ME02190	3.451	ME02191	10.059	ME02193	5.727
kg	143'32		143'32		143'32		257'2		257'2	
2 boxes / bultos	1'53 m3		1'53 m3		1'53 m3		4'47 m3		4'47 m3	
2800x1200	ME02200	3.433	ME02201	3.730	ME02202	3.487	ME02203	10.311	ME02205	5.978
kg	148'96		148'96		148'96		271'6		271'6	
2 boxes / bultos	1'57 m3		1'57 m3		1'57 m3		4'75 m3		4'75 m3	

PSTOP-TECH

Top measures Medidas sobre		Up charge for TOP-TECH Power Box. Incremento por sistema eléctrico TOP-TECH.		Up charge for double USB charge. Installation included. Incremento por doble USB de carga. Instalación incluida.		Up charge for power socket. Installation included. Incremento por toma de alimentación. Instalación incluida.		Bright lacquered base up charge. Incremento por base laca brillo.		Access panel for wiring up charge. Incremento por panel de acceso para cableado.
	€	€	€	€	€	€				
2200x1200	725	142	142	142	544	330				
2400x1200	735	142	142	544	330					
2600x1200	744	142	142	544	330					
2800x1200	754	142	142	544	330					

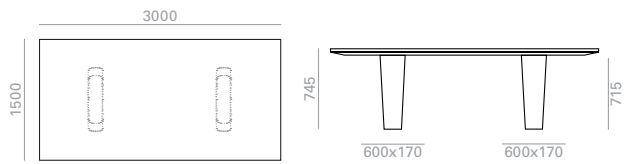

Height adjustable  
glides up charger  
Incremento por tacos  
reguladores

| 84 |

\*\*\*Marble shiny  
upcharge  
Incremento por  
mármol brillo

| 30 |

Amount of sand: 150 kg.(3x50 kg.)  
Cantidad de arena 150 kg.(3x50 kg.)

Top measures Medidas sobre	Table top / Sobre										
	Oak Roble		s600	Lacquered Lacado		Laminate Laminado		LaminateTP LaminadoTP		Low Iron Glass Cristal Óptico	
	Ref.	€	€	Ref.	€	Ref.	€	Ref.	€	Ref.	€
3000x1500	ME02206	2.667	360	ME02207	2.019	ME02208	2.512	ME02209	2.711	ME02210	3.961
kg	175'75		175'75		175'75		175'75		317'5		
2 boxes / bultos	1'83 m3		1'83 m3		1'83 m3		1'83 m3		6'01 m3		

Top measures Medidas sobre	Table top / Sobre									
	Linoleum Linóleo		Ultra-matte Ultramate		Ultra-matte TP UltramateTP		***Marble M3 Mármol M3		***M1 Marble Mármol M1	
	Ref.	€	Ref.	€	Ref.	€	Ref.	€	Ref.	€
3000x1500	ME02211	3.480	ME02212	3.778	ME02213	3.546	ME02214	14.634	ME02216	7.546
kg	175'75		175'75		175'75		340		340	
2 boxes / bultos	1'83 m3		1'83 m3		1'83 m3		6'01 m3		6'01 m3	

PSTOP-TECH										
Top measures Medidas sobre		Up charge forTOP-TECH Power Box. Incremento por sistema eléctrico TOP-TECH.		Up charge for double USB charge. Installation included. Incremento por doble USB de carga. Instalación incluida.		Up charge for power socket. Installation included. Incremento por toma de alimentación. Instalación incluida.		Bright lacquered base up charge. Incremento por base laca brillo.		Acces panel for wiring up charge. Incremento por panel de acceso para cableado.
	€		€		€		€		€	
	3000x1500	800		142		142		646		330

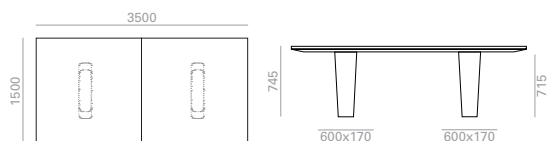

Height adjustable glides up charged  
Incremento por tacos reguladores

| 84 |

\*\*\*Marble shiny upcharge  
Incremento por mármol brillo

| 30 |

Top measures Medidas sobre	Table top / Sobre										
	Oak Roble		s600	Lacquered Lacado		Laminate Laminado		LaminateTP LaminadoTP		Low Iron Glass Cristal Óptico	
	Ref.	€	€	Ref.	€	Ref.	€	Ref.	€	Ref.	€
3500x1500	ME02217	4.082	420	ME02218	2.449	ME02219	3.931	ME02220	4.140	ME02221	4.941
kg	223'38		223'38		223'38		223'38		388'75		
3 boxes / bultos	1'6 m3		1'6 m3		1'6 m3		1'6 m3		2'56 m3		

Top measures Medidas sobre	Table top / Sobre									
	Linoleum Linóleo		Ultra-matte Ultramate		Ultra-matte TP UltramateTP		***Marble M3 Mármol M3		***M1 Marble Mármol M1	
	Ref.	€	Ref.	€	Ref.	€	Ref.	€	Ref.	€
3500x1500	ME02222	6.039	ME02223	6.491	ME02224	5.872	ME02225	17.164	ME02227	8.900
kg	223'38		223'38		223'38		415		415	
3 boxes / bultos	1'6 m3		1'6 m3		1'6 m3		7'2 m3		7'2 m3	

PSTOP-TECH										
Top measures Medidas sobre		Up charge for TOP-TECH Power Box. Incremento por sistema eléctrico TOP-TECH.		Up charge for double USB charge. Installation included. Incremento por doble USB de carga. Instalación incluida.		Up charge for power socket. Installation included. Incremento por toma de alimentación. Instalación incluida.		Bright lacquered base up charge. Incremento por base laca brillo.		Acces panel for wiring up charge. Incremento por panel de acceso para cableado.
	€	€	€	€	€	€	€			
	3500x1500	1.003	142	142	646	330				

Top measures Medidas sobre	Table top / Sobre										
	Oak Roble		s600	Lacquered Lacado		Laminate Laminado		LaminateTP LaminadoTP		Low Iron Glass Cristal Óptico	
	Ref.	€	€	Ref.	€	Ref.	€	Ref.	€	Ref.	€
4000x1500	ME02228	4.311	480	ME02229	2.741	ME02230	4.154	ME02231	4.383	ME02232	5.653
kg	241		241		241		241		430		
3 boxes / bultos	1'97 m3		1'97 m3		1'97 m3		1'97 m3		3'71 m3		
4500x1500	ME02239	4.434	539	ME02240	2.908	ME02241	4.241	ME02242	4.495	ME02243	5.935
kg	258'62		258'62		258'62		258'62		471'25		
3 boxes / bultos	2'11 m3		2'11 m3		2'11 m3		1'52 m3		2'15 m3		
5000x1500	ME02250	4.528	599	ME02251	3.073	ME02252	4.312	ME02253	4.592	ME02254	6.304
kg	276'25		276'25		276'25		276'25		512'5		
3 boxes / bultos	2'25 m3		2'25 m3		2'25 m3		2'25 m3		9'98 m3		
5500x1500	ME02261	4.611	659	ME02262	3.275	ME02263	4.387	ME02264	4.717	ME02265	6.902
kg	287'53		293'88		293'88		293'88		553'75		
3 boxes / bultos	2'38 m3		2'38 m3		2'38 m3		2'38 m3		10'83 m3		
6000x1500	ME02272	4.693	719	ME02273	3.443	ME02274	4.463	ME02275	4.814	ME02276	7.842
kg	311'5		311'5		311'5		311'5		595		
3 boxes / bultos	2'52 m3		2'52 m3		2'52 m3		2'52 m3		11'68 m3		

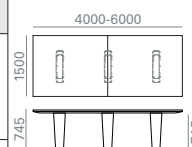

Height adjustable  
glides up charger  
Incremento por tacos  
reguladores

| 126 |

\*\*\*Marble shiny  
upcharge  
Incremento por  
mármol brillo

| 30 |

Top measures Medidas sobre	Table top / Sobre									
	Linoleum Linóleo		Ultra-matte Ultramate		Ultra-matteTP UltramateTP		***Marble M3 Mármol M3		***M1 Marble Mármol M1	
	Ref.	€	Ref.	€	Ref.	€	Ref.	€	Ref.	€
4000x1500	ME02233	6.261	ME02234	6.713	ME02235	6.119	ME02236	19.912	ME02238	10.855
kg	241		241		241		460		460	
3 boxes / bultos	1'97 m3		1'97 m3		1'97 m3		8'28 m3		8'28 m3	
4500x1500	ME02244	6.354	ME02245	6.800	ME02246	6.147	ME02247	20.521	ME02249	10.670
kg	258'62		258'62		258'62		505		505	
3 boxes / bultos	2'11 m3		2'11 m3		2'11 m3		9'13 m3		9'13 m3	
5000x1500	ME02255	6.440	ME02256	6.872	ME02257	6.323	ME02258	22.063	ME02260	11.427
kg	276'25		276'25		276'25		550		550	
3 boxes / bultos	2'25 m3		2'25 m3		2'25 m3		9'98 m3		9'98 m3	
5500x1500	ME02266	6.545	ME02267	7.644	ME02268	6.449	ME02269	23.621	ME02271	12.200
kg	293'88		293'88		293'88		595		595	
3 boxes / bultos	2'38 m3		2'38 m3		2'38 m3		10'83 m3		10'83 m3	
6000x1500	ME02277	6.617	ME02278	7.789	ME02279	6.546	ME02280	25.165	ME02282	12.953
kg	311'5		311'5		311'5		640		640	
3 boxes / bultos	2'52 m3		2'52 m3		2'52 m3		11'68 m3		11'68 m3	

PSTOP-TECH

Top measures Medidas sobre		Up charge for TOP-TECH Power Box. Incremento por sistema eléctrico TOP-TECH.		Up charge for double USB charge. Installation included. Incremento por doble USB de carga. Instalación incluida.		Up charge for power socket. Installation included. Incremento por toma de alimentación. Instalación incluida.		Bright lacquered base up charge. Incremento por base laca brillo.		Access panel for wiring up charge. Incremento por panel de acceso para cableado.
	€	€	€	€	€	€				
4000x1500		1.025		142		142		969		330
4500x1500		1.047		142		142		969		330
5000x1500		1.070		142		142		969		330
5500x1500		1.093		142		142		969		330
6000x1500		1.131		142		142		969		330



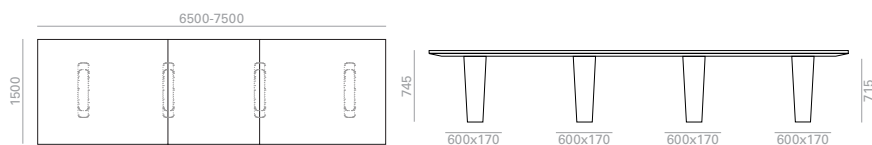

Height adjustable glides up charge  
Incremento por tacos reguladores

\*\*\*Marble shiny upcharge  
Incremento por mármol brillo

| 168 |

| 30 |

Amount of sand: 200 kg.(4x50 kg.)  
Cantidad de arena 200 kg.(4x50 kg.)

Top measures Medidas sobre	Table top / Sobre										
	Oak Roble		s600	Lacquered Lacado		Laminate Laminado		LaminateTP LaminadoTP		Low Iron Glass Cristal Óptico	
	Ref.	€	€	Ref.	€	Ref.	€	Ref.	€	Ref.	€
6500x1500	ME02283	6.277	779	ME02284	3.975	ME02285	6.022	ME02286	6.345	ME02287	8.466
kg	359'12		359'12		359'12		359'12		666'25		
4 boxes / bultos	2'95 m3		2'95 m3		2'95 m3		2'95 m3		4'68 m3		
7000x1500	ME02294	6.371	839	ME02295	4.099	ME02296	6.089	ME02297	6.437	ME02298	8.772
kg	376'75		376'75		376'75		376'75		707'5		
4 boxes / bultos	3'09 m3		3'09 m3		3'09 m3		3'09 m3		4'94 m3		
7500x1500	ME02305	6.465	899	ME02306	4.222	ME02307	6.214	ME02308	6.540	ME02309	9.204
kg	394'38		394'38		394'38		394'38		748'75		
4 boxes / bultos	3'23 m3		3'23 m3		3'23 m3		3'23 m3		14'84 m3		

Top measures Medidas sobre	Table top / Sobre									
	Linoleum Linóleo		Ultra-matte Ultramate		Ultra-matteTP UltramateTP		***Marble M3 Mármol M3		***M1 Marble Mármol M1	
	Ref.	€	Ref.	€	Ref.	€	Ref.	€	Ref.	€
6500x1500	ME02288	9.363	ME02289	9.905	ME02290	9.002	ME02291	30.436	ME02293	15.076
kg	359'12		359'12		359'12		715		715	
4 boxes / bultos	2'95 m3		2'95 m3		2'95 m3		13'1 m3		13'1 m3	
7000x1500	ME02299	9.463	ME02300	9.976	ME02301	9.095	ME02302	31.983	ME02304	15.836
kg	376'75		376'75		376'75		760		760	
4 boxes / bultos	3'09 m3		3'09 m3		3'09 m3		13'97 m3		13'97 m3	
7500x1500	ME02310	9.541	ME02311	10.041	ME02312	9.198	ME02313	34.684	ME02315	16.960
kg	394'38		394'38		394'38		805		805	
4 boxes / bultos	3'23 m3		3'23 m3		3'23 m3		14'84 m3		14'84 m3	

PSTOP-TECH										
Top measures Medidas sobre		Up charge for TOP-TECH Power Box. Incremento por sistema eléctrico TOP-TECH.		Up charge for double USB charge. Installation included. Incremento por doble USB de carga. Instalación incluida.		Up charge for power socket. Installation included. Incremento por toma de alimentación. Instalación incluida.		Bright lacquered base up charge. Incremento por base laca brillo.		Acces panel for wiring up charge. Incremento por panel de acceso para cableado.
	€	€	€	€	€	€				
6500x1500	1.387	142	142	1.292	330					
7000x1500	1.411	142	142	1.292	330					
7500x1500	1.432	142	142	1.292	330					

## Maximum table heights Alturas máximas de mesa

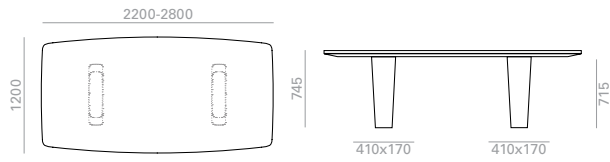
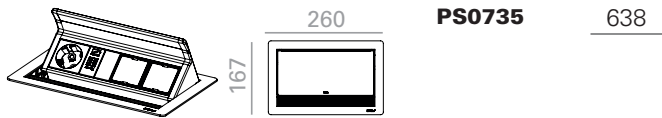

Table top / Sobre				
Oak Roble	Lacquered Lacado	Laminate Laminado	Laminate TP Laminado TP	Top Technical Stone 8
750	750	750	750	758

Table top / Sobre				
Linoleum Linóleo	Ultra-matte Ultramate	Ultra-matte TP Ultramate TP	***Marble M3 Mármol M3	Low Iron Glass Cristal Óptico
750	750	750	752	755

**PS-IN SURFACE**



**PS0735** 638

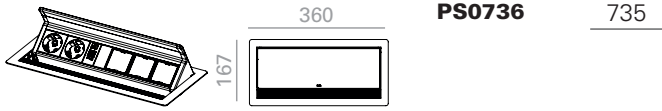

**PS0736** 735



**PS0804** 142

**PS-QI**



**PS0714** 243

**Preinstalled (Optional) / Preinstalación (Opcional) IN0006**

First installation / Primera instalación 270  
 Second and more installations / Segunda y más instalaciones 90

**PS-UNDERTOP**

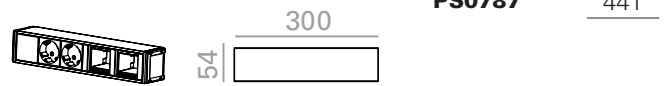

**PS0787** 441

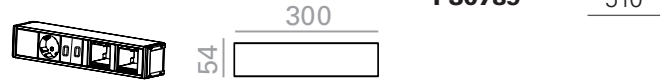

**PS0789** 510



**PS0788** 611

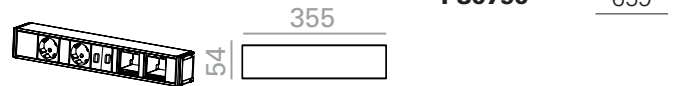

**PS0790** 659

**PS-INTREGATED**

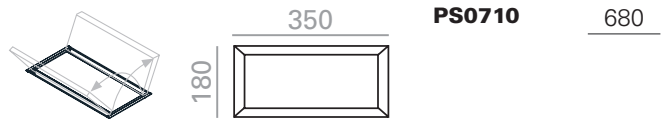

**PS0710** 680

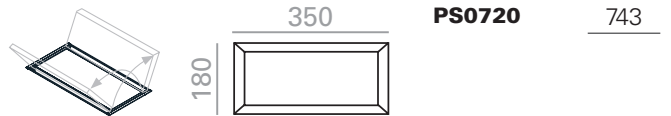

**PS0720** 743



**PS0795** 453



**PS0796** 468

**UNDERTOP-TECH POWER BOXES  
CAJA DE CONEXIONES TOP-TECH BAJO EL SOBRE**

Power box mounted in the under-top, available for any status model. It is served in the same color as base, black or white. For other finishing, contact the customer department. There are two power system sizes available and data slots can be customized according to the below diagram.

El sistema va montado debajo de la tapa, esta disponible para cualquier modelo de la mesa Status. Se sirve en el mismo acabado que las bases, blanco o negro. Para cualquier otro acabado contactar con el departamento comercial. Hay dos sistemas de alimentacion disponibles y las cantidades se pueden personalizar de acuerdo al diagrama inferior.

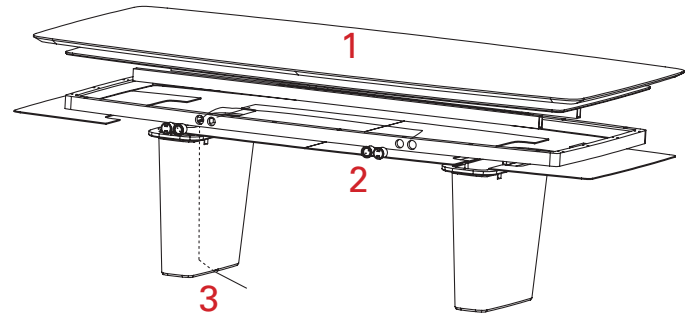
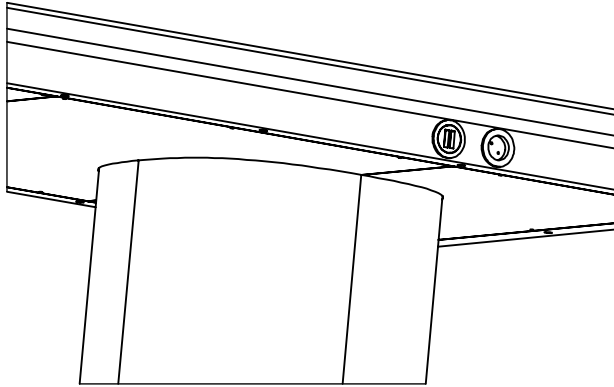

**1 POWER BOXES DISTRIBUTION DISTRIBUCIÓN DE SISTEMAS**

By default power box is placed in the center of the table and in lengthwise direction. If more than one power box is installed, inform the Customer Department about the desired position.

Por defecto la posición del sistema irá en el centro de la mesa y en sentido longitudinal. Si se solicita más de un sistema eléctrico, comunicar la posición deseada al Departamento Comercial.

2200-3500 (4 powers + 4 USB 2 charges)

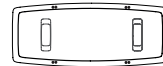

4000-5000 (6 powers + 6 USB 2 charges)

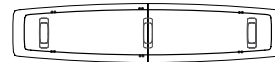

5500-7500 (8 powers + 8 USB 2 charges)



**2 WIRING MANAGEMENT GESTIÓN DEL CABLEADO**

Wire pass through an aluminum grommet keeping it hidden. By default color is silver, for other finishings ask the Customer Department.

El cable se pasa a través de un perfil pasacables de aluminio que lo mantiene oculto. Su color de serie es el plata, para otros acabados consultar al Departamento Comercial.

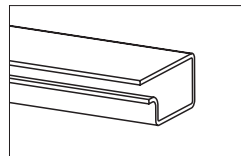

**OPTIONAL PREINSTALLED WIRING**

**3 CABLE WAY OUT SALIDA DE CABLEADO**

The cable way out can be performed directly from the power system or through a canal in the base bottom, so that is hidden until it gets to the floor.

La salida del cable se realiza directamente desde el propio sistema como por unas canalizaciones en la parte inferior de la base, de modo que el cable queda oculto hasta llegar al suelo.

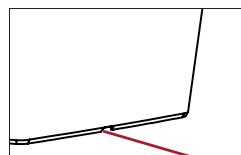

**IN-SURFACE POWER BOXES  
CAJAS DE CONEXIONES DENTRO DEL SOBRE**

Aluminum power box mounted in the table top with a folding protective lid. It is served in anodized silver, black or white, for other finishing, contact the Customer Department. There are two power system sizes available and data slots can be customized according to the below diagram.

Caja de conexiones de aluminio integrada dentro de la superficie del sobre con tapa abatible, disponible para cualquier modelo de mesa Reverse. Se sirve en color anodizado plata, negro o blanco, para otros acabados consultar al Departamento Comercial. Se ofrecen dos tamaños de caja diferentes y con conectividad configurable, acorde al siguiente esquema:

**PS0735**

**PS0736**

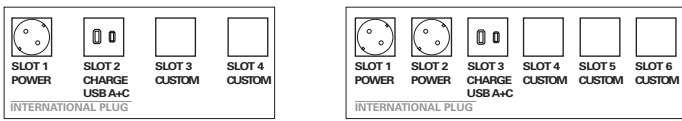

CHOOSE DATA PORT FOR DATA CUSTOM PORT SLOTS

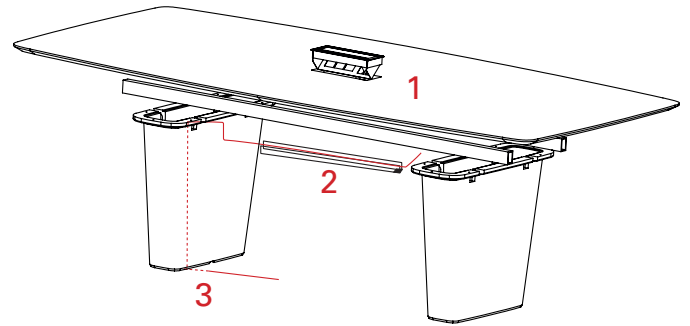
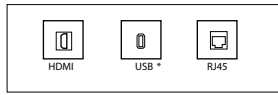

**1 POWER BOXES DISTRIBUTION DISTRIBUCIÓN DE SISTEMAS**

By default power box is placed in the center of the table and in lengthwise direction. If more than one power box is installed, inform the Customer Department about the desired position.

Por defecto la posición del sistema irá en el centro de la mesa y en sentido longitudinal. Si se solicita más de un sistema eléctrico, comunicar la posición deseada al Departamento Comercial.

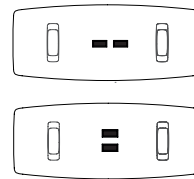

**2 WIRING MANAGEMENT GESTIÓN DEL CABLEADO**

Wire pass through an aluminum grommet keeping it hidden. By default color is silver, for other finishings ask the Customer Department.

El cable se pasa a través de un perfil pasacables de aluminio que lo mantiene oculto. Su color de serie es el plata, para otros acabados consultar al Departamento Comercial.

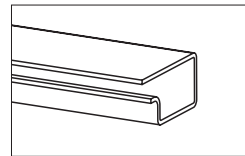

**3 CABLEWAY OUT SALIDA DE CABLEADO**

The cable way out can be performed directly from the power system or through a canal in the base bottom, so that is hidden until it gets to the floor.

La salida del cable se realiza directamente desde el propio sistema como por unas canalizaciones en la parte inferior de la base, de modo que el cable queda oculto hasta llegar al suelo.

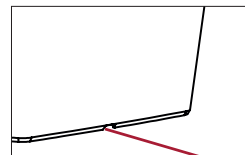

**OPTIONAL PREINSTALLED WIRING  
PREINSTALACIÓN DEL CABLEADO**

**IN0006**

Preinstalled wiring consists in the addition of the necessary mechanisms to integrate power systems in the table, so that wiring is hidden until the way out in the floor. Necessary grommet are included and 3m cable (from the power system). For other cable dimensions contact the Customer Department. Tables with only one base are exempt of this charge, for the rest of tables ask the Customer Department.

La preinstalación consiste en el montaje de los mecanismos necesarios para integrar el sistema de electrificación en la mesa, de modo que el cableado quede oculto hasta su salida por la base. Se incluyen los pasacables necesarios y 3 metros de cable (midiendo desde el sistema de conexiones). Las mesas de una sola base quedan exentas de este cargo, para el resto consultar al Departamento Comercial.

**IN-SURFACE POWER BOXES  
CAJAS DE CONEXIONES DENTRO DEL SOBRE**

It is a data dynamo with 2 amp dual charging USB. Available in two finish: black or white.

Es una dínamo de datos con 2 amp de carga dual USB. Disponible en dos acabados: negro o blanco.

PS0804

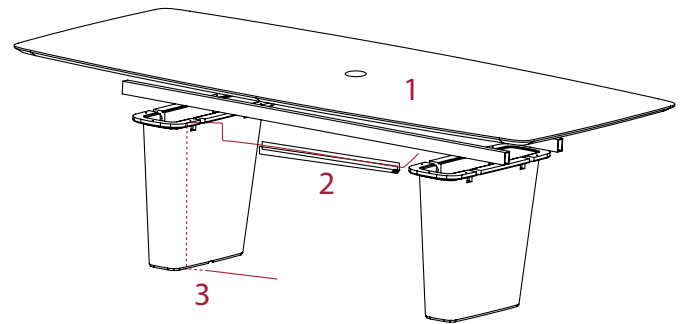
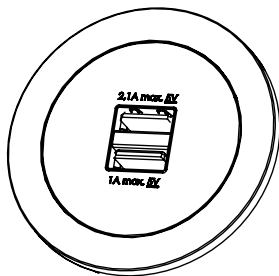

**1 POWER BOXES DISTRIBUTION DISTRIBUCIÓN DE SISTEMAS**

By standard, the position of the system will be in the central of the table, placed horizontally. When there are two system boxes, these will be separated 1/3 between them and placed horizontally. For other options, please contact the Customer Department.

De serie, la disposición del sistema será en el centro de la mesa y en sentido longitudinal. Cuando se disponga de dos sistemas, estos se colocarán con una separación de 1/3 de la longitud total de la mesa, y en sentido longitudinal. Otras opciones consultar con el Departamento Comercial.

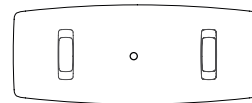

**2 WIRING MANAGEMENT GESTIÓN DEL CABLEADO**

Wire pass through an aluminum grommet keeping it hidden. By default color is silver, for other finishings ask the Customer Department.

El cable se pasa a través de un perfil pasacables de aluminio que lo mantiene oculto. Su color de serie es el plata, para otros acabados consultar al Departamento Comercial.

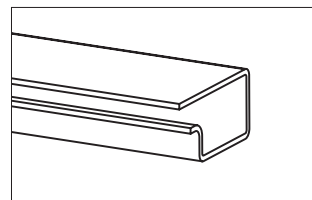

**OPTIONAL PREINSTALLED WIRING  
PREINSTALACIÓN DEL CABLEADO**

IN0006

Preinstalled wiring consists in the addition of the necessary mechanisms to integrate power systems in the table, so that wiring is hidden until the way out in the door. Necessary grommet are included and 3m cable (from the power system). For other cable dimensions contact the Customer Department.

La preinstalación consiste en el montaje de los mecanismos necesarios para integrar el sistema de electrificación en la mesa, de modo que el cableado quede oculto hasta su salida por la base. Se incluyen los pasacables necesarios y 3 metros de cable (midiendo desde el sistema de conexiones). Para otras longitudes de cable consultar al Departamento Comercial.

**3 CABLE WAY OUT SALIDA DE CABLEADO**

The cable way out can be performed directly from the power system or through a canal in the base bottom, so that is hidden until it gets to the floor.

La salida del cable se realiza directamente desde el propio sistema como por unas canalizaciones en la parte inferior de la base, de modo que el cable queda oculto hasta llegar al suelo.

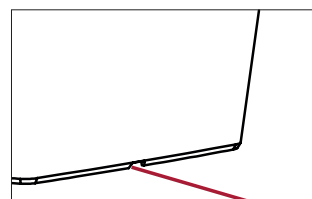

**QI CHARGING POWER BOXES  
CAJAS DE CONEXIONES QI**

The inductive charging station, allows maximum larger contact surface. Available in two finish: black or white.

La estación de carga inductiva permite una superficie de contacto máxima más grande. Disponible en dos acabados: negro o blanco.

**PS0714**

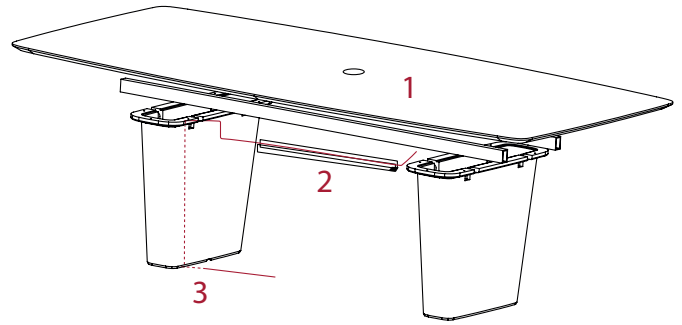
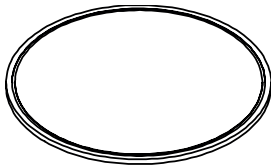

**1 POWER BOXES DISTRIBUTION DISTRIBUCIÓN DE SISTEMAS**

By standard, the position of the system will be in the central of the table, placed horizontally. When there are two system boxes, these will be separated 1/3 between them and placed horizontally. For other options, please contact the Customer Department.

En mesas con una sola base el sistema eléctrico iría instalado descentrado respecto a la base. En mesas con más de una base, por defecto la posición del sistema irá en el centro de la mesa y en sentido longitudinal. Si se solicita más de un sistema eléctrico, comunicar la posición deseada al Departamento Comercial.

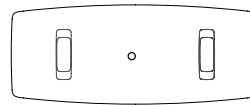

**2 WIRING MANAGEMENT GESTIÓN DEL CABLEADO**

Wire pass through an aluminum grommet keeping it hidden. By default color is silver, for other finishings ask the Customer Department.

El cable se pasa a través de un perfil pasacables de aluminio que lo mantiene oculto. Su color de serie es el plata, para otros acabados consultar al Departamento Comercial.

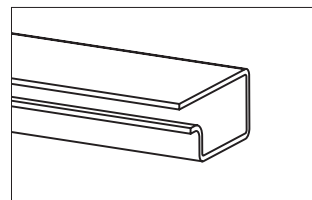

**OPTIONAL PREINSTALLED WIRING  
PREINSTALACIÓN DEL CABLEADO**

**IN0006**

Preinstalled wiring consists in the addition of the necessary mechanisms to integrate power systems in the table, so that wiring is hidden until the way out in the floor. Necessary grommet are included and 3m cable (from the power system). For other cable dimensions contact the Sales Department. For each wire Reverse base, you must ask for une IN0006 to the Customer Department.

La preinstalación consiste en el montaje de los mecanismos necesarios para integrar el sistema de electrificación en la mesa, de modo que el cableado quede oculto hasta su salida por la base. Se incluyen los pasacables necesarios y 3 metros de cable (midiendo desde el sistema de conexiones). Por cada base por al que se desee bajar el cable se solicita un IN0006 al Departamento Comercial.

**3 CABLEWAY OUT SALIDA DE CABLEADO**

The cable way out can be performed directly from the power system or through a canal in the base bottom, so that is hidden until it gets to the floor.

La salida del cable se realiza directamente desde el propio sistema como por unas canalizaciones en la parte inferior de la base, de modo que el cable queda oculto hasta llegar al suelo.

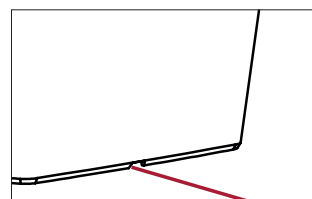

**INTEGRATED POWER BOXES  
CAJAS DE CONEXIONES INTEGRADAS**

The black finish is integrated with the top. Its opening is towards both sides.

El acabado negro está integrado con la parte superior. Su apertura es hacia ambos lados.

**PS0710**

**PS0720**

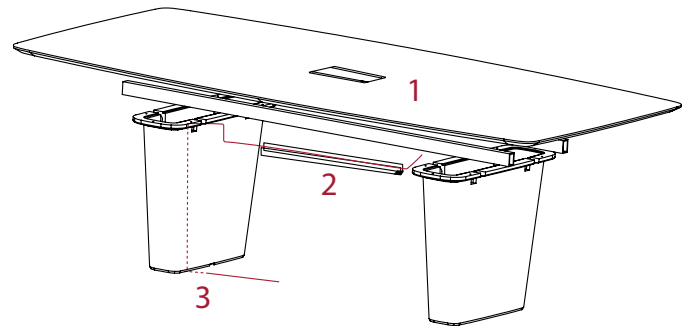
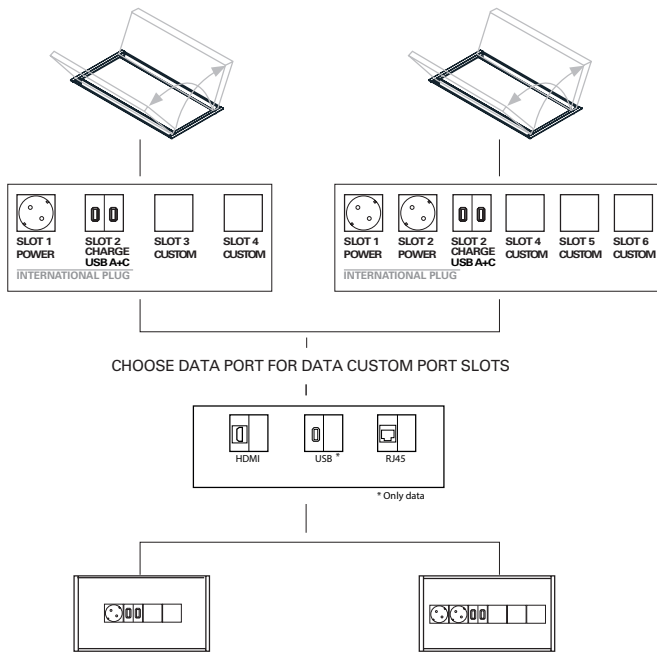

**1 POWER BOXES DISTRIBUTION DISTRIBUCIÓN DE SISTEMAS**

By standard, the position of the system will be in the central of the table, placed horizontally. When there are two system boxes, these will be separated 1/3 between them and placed horizontally. For other options, please contact the Customer Department.

De serie, la disposición del sistema será en el centro de la mesa y en sentido longitudinal. Cuando se disponga de dos sistemas, estos se colocarán con una separación de 1/3 de la longitud total de la mesa, y en sentido longitudinal. Otras opciones consultar con el Departamento Comercial.

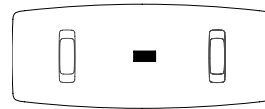

**2 WIRING MANAGEMENT GESTIÓN DEL CABLEADO**

Wire pass through an aluminum grommet keeping it hidden. By default color is silver, for other finishings ask the Customer Department.

El cable se pasa a través de un perfil pasacables de aluminio que lo mantiene oculto. Su color de serie es el plata, para otros acabados consultar al Departamento Comercial.

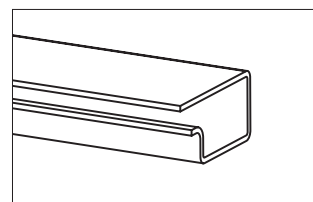

**OPTIONAL PREINSTALLED WIRING  
PREINSTALACIÓN DEL CABLEADO**

**IN0006**

Preinstalled wiring consists in the addition of the necessary mechanisms to integrate power systems in the table, so that wiring is hidden until the way out in the door. Necessary grommet are included and 3m cable (from the power system). For other cable dimensions contact the Customer Department.

La preinstalación consiste en el montaje de los mecanismos necesarios para integrar el sistema de electrificación en la mesa, de modo que el cableado quede oculto hasta su salida por la base. Se incluyen los pasacables necesarios y 3 metros de cable (midiendo desde el sistema de conexiones). Para otras longitudes de cable consultar al Departamento Comercial.

**3 CABLE WAY OUT SALIDA DE CABLEADO**

The cable way out can be performed directly from the power system or through a canal in the base bottom, so that is hidden until it gets to the floor.

La salida del cable se realiza directamente desde el propio sistema como por unas canalizaciones en la parte inferior de la base, de modo que el cable queda oculto hasta llegar al suelo.

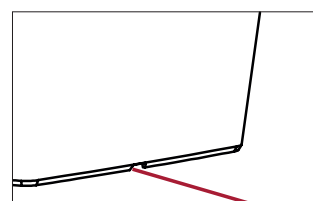



**UNDER-TOP POWER BOXES  
CAJA DE CONEXIONES BAJO EL SOBRE**

Power box mounted under the table top. Available in black or white color (silver or black in USA), for other finishing, contact the Customer Department. There are two power system sizes available and data slots can be customized according to the below diagram.

Regleta de conexiones bajo la superficie del sobre. Se sirve en color negro o blanco (plata o negro en USA). Para otros acabados consultar al departamento comercial. Se ofrecen formatos de caja de dos tamaños de caja diferentes y con opciones de conectividad configurable.

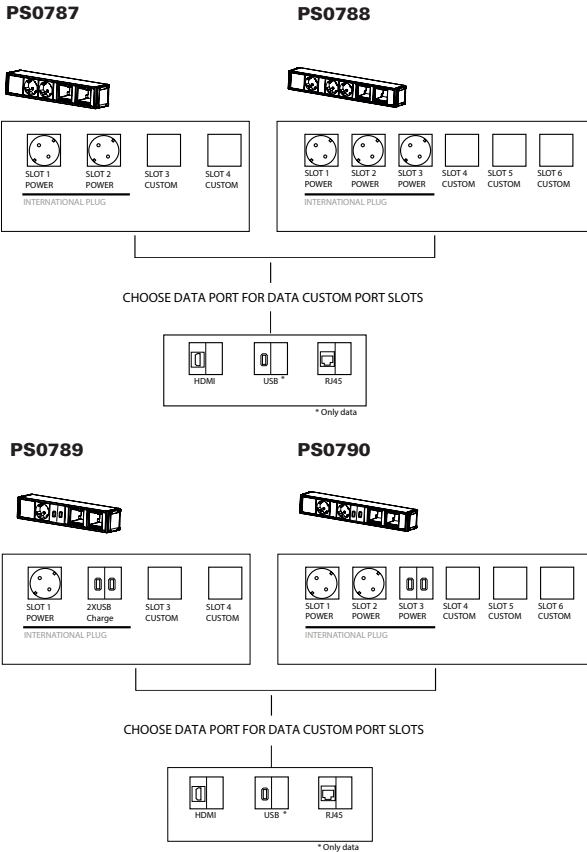

**OPTIONAL PREINSTALLED WIRING  
PREINSTALACIÓN DEL CABLEADO**

**IN0006**

Preinstalled wiring consists in the addition of the necessary mechanisms to integrate power systems in the table, so that wiring is hidden until the way out in the door. Necessary grommet are included and 3m cable (from the power system). For other cable dimensions contact the Customer Department.

La preinstalación consiste en el montaje de los mecanismos necesarios para integrar el sistema de electrificación en la mesa, de modo que el cableado quede oculto hasta su salida por la base. Se incluyen los pasacables necesarios y 3 metros de cable (midiendo desde el sistema de conexiones). Para otras longitudes de cable consultar al Departamento Comercial.

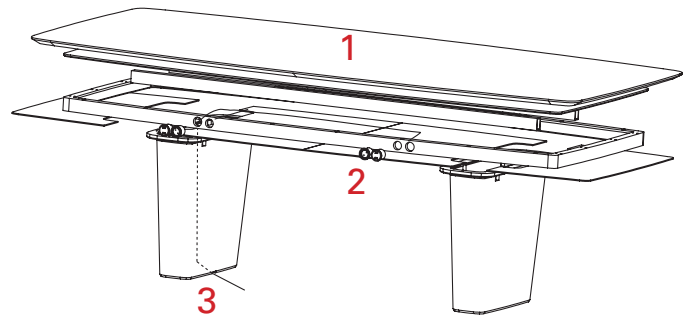

**1 POWER BOXES DISTRIBUTION DISTRIBUCIÓN DE SISTEMAS**

By standard, the position of the system will be in the central of the table, placed horizontally. When there are two system boxes, these will be separated 1/3 between them and placed horizontally. For other options, please contact the Customer Department.

De serie, el sistema se instala a la izquierda de la mesa, orientado hacia la pata opuesta, y el cable bajaría por al misma pata. Para distribuciones especiales consultar al Departamento Comercial.

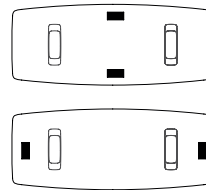

**2 WIRING MANAGEMENT GESTIÓN DEL CABLEADO**

Wire pass through an aluminum grommet keeping it hidden. By default color is silver, for other finishings ask the Customer Department.

El cable se pasa a través de un perfil pasacables de aluminio que lo mantiene oculto. Su color de serie es el plata, para otros acabados consultar al Departamento Comercial.

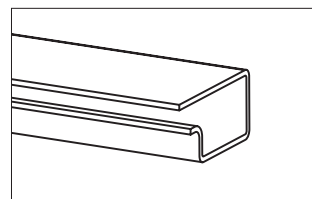

**3 CABLE WAY OUT SALIDA DE CABLEADO**

The cable way out can be performed directly from the power system or through a canal in the base bottom, so that is hidden until it gets to the floor.

La salida del cable se realiza directamente desde el propio sistema como por unas canalizaciones en la parte inferior de la base, de modo que el cable queda oculto hasta llegar al suelo.

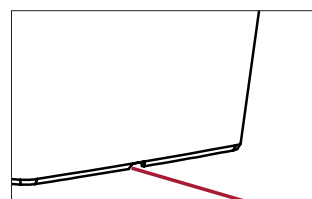

**IN-SURFACE SOCKET POWERS  
TORRES DE CONEXIONES DENTRO DEL SOBRE**

Socket tower mounted in the table top. The hidden system manually rises with a slight push. Valid for Reverse tables with bases Reverse 38, 50 and 60. Available in silver, white or black color, for for other finishing, contact the Customer Department.

Torre de conexiones integrada dentro de la superficie del sobre. El sistema eléctrico oculto se alza manualmente al pulsarlo. Disponible mesas Reverse con bases Reverse 38, 50 y 60. Disponible en color plata, blanco o negro, para otros acabados consultar al Departamento Comercial.

**PS0795**

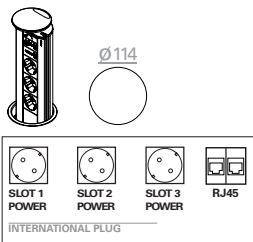

**PS0796**

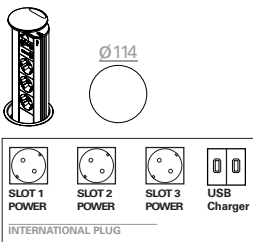

**OPTIONAL PREINSTALLED WIRING  
PREINSTALACIÓN DEL CABLEADO**

**IN0006**

Preinstalled wiring consists in the addition of the necessary mechanisms to integrate power systems in the table, so that wiring is hidden until the way out in the floor. Necessary grommet are included and 3m cable (from the power system). For each wire Reverse base, you must ask for one IN0006 to the Customer Department.

La preinstalación consiste en el montaje de los mecanismos necesarios para integrar el sistema de electrificación en la mesa, de modo que el cableado quede oculto hasta su salida por la base. Se incluyen los pasacables necesarios y 3 metros de cable (midiendo desde el sistema de conexiones). Por cada base por al que se desee bajar el cable se solicita un IN0006 al Departamento Comercial.

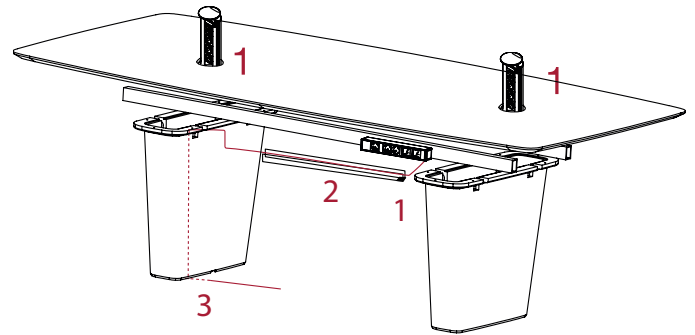

**1 POWER BOXES DISTRIBUTION DISTRIBUCIÓN DE SISTEMAS**

In tables with only one Reverse base power box can't be centered with the base. In tables with more than one base, by default power box is placed in the center of the table and in lengthwise direction. If more than one power box is installed, inform the Customer Department about the desired position.

En mesas con más de una base, por defecto la posición del sistema irá en el centro de la mesa y en sentido longitudinal. Si se solicita más de un sistema eléctrico, comunicar la posición deseada al Departamento Comercial.



**2 WIRING MANAGEMENT GESTIÓN DEL CABLEADO**

Wire pass through an aluminum grommet keeping it hidden. By default color is silver, for other finishings ask the Customer Department.

El cable se pasa a través de un perfil pasacables de aluminio que lo mantiene oculto. Su color de serie es el plata, para otros acabados consultar al Departamento Comercial.

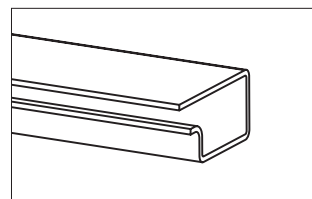

**3 CABLE WAY OUT SALIDA DE CABLEADO**

The cable way out can be performed directly from the power system or thru a canal in the base bottom, so that is hidden until it gets to the floor.

La salida del cable se realiza directamente desde el propio sistema como por unas canalizaciones en la parte inferior de la base, de modo que el cable queda oculto hasta llegar al suelo.

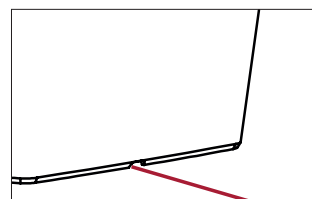





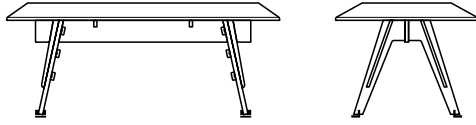

**Description**  
**Descripción**

Table with structure and 4-legged base in solid oak wood and aluminum stoppers in black finish. Table top available in several sizes and finishes: oak, lacquered, linoleum, smoked glass and marble.

Mesa con estructura y base de 4 patas de madera maciza de roble y tacos de aluminio en acabado negro. Sobre de mesa disponible en diferentes medidas y acabado roble, lacado, linóleo, cristal fumé y mármol.

**Wood finish Oak**  
**Acabado madera**  
**Roble**



**Wood lacquer finish**  
**Acabado laca madera**



**Linoleum finish**  
**Acabado linóleo**

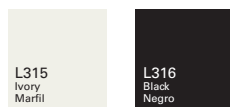

**Smoked glass finish**  
**Acabado de cristal fumé**

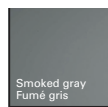

**M1 marble finish**  
**Acabado de mármol**  
**M1**

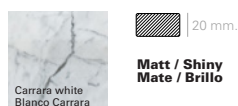

**M3 marble finish**  
**Acabado de mármol**  
**M3**



**Aluminum finish**  
**Acabado aluminio**



**Intellectual property Propiedad intelectual**

All our collections are protected by international industrial design registries, designs patents, copyrights and intellectual Property laws. Unauthorized use of AW International Property is a criminal offence and can lead to prosecution.  
Todas nuestras colecciones están protegidas por registros de diseño industrial, diseño de patente, copyright y derechos de propiedad intelectual en todo el mundo. El uso no autorizado de los diseños y propiedad intelectual de AW supone un delito que puede ser sometido a acción judicial.



ME2670

1500 x 750

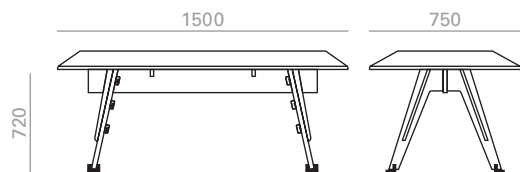

	Table top / Sobre					
	*Oak Roble	Lacquered Lacado	Linoleum Linóleo	Smoked gray Fumé gris	***M1 Marble Mármol M1	***M3 Marble Mármol M3
	€	€	€	€	€	€
	2.563	2.645	2.913	2.640	4.361	6.692
kg	34.7	34.7	34.7	34.7	34.7	34.7
1 box / bulto  m3	0.11	0.11	0.11	0.11	0.11	0.11

SERIE 600	*Matte lacquered and premium upcharge	348	***Marble shiny upcharge	30
	*Incremento por lacado mate y premium			

ME2671

1600 x 800

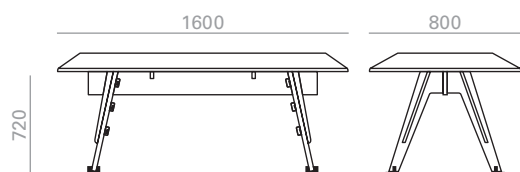

	Table top / Sobre					
	*Oak Roble	Lacquered Lacado	Linoleum Linóleo	Smoked gray Fumé gris	***M1 Marble Mármol M1	***M3 Marble Mármol M3
	€	€	€	€	€	€
	3.019	3.071	3.369	2.685	4.406	6.737
kg	37.69	37.69	37.69	37.69	37.69	37.69
1 box / bulto  m3	0.12	0.12	0.12	0.12	0.12	0.12

SERIE 600	*Matte lacquered and premium upcharge	369	***Marble shiny upcharge	30
	*Incremento por lacado mate y premium			

# Andreu World

## ME2672

1800 x 900

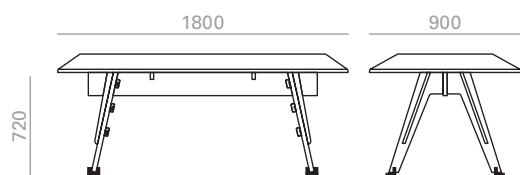

	Table top / Sobre					
	*Oak Roble	Lacquered Lacado	Linoleum Linóleo	Smoked gray Fumé gris	***M1 Marble Mármol M1	***M3 Marble Mármol M3
	€	€	€	€	€	€
	3.071	3.123	3.421	2.721	3.421	4.460
kg	44.07	44.07	44.07	44.07	44.07	44.07
1 box / bulto  m3	0.14	0.14	0.14	0.14	0.14	0.14

SERIE 600	*Matte lacquered and premium upcharge	390	***Marble shiny upcharge	30
	*Incremento por lacado mate y premium		Incremento por mármol brillo	

## ME2673

2000 x 1000

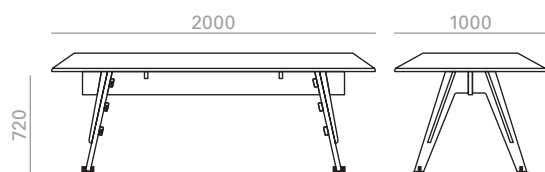

	Table top / Sobre					
	*Oak Roble	Lacquered Lacado	Linoleum Linóleo	Smoked gray Fumé gris	***M1 Marble Mármol M1	***M3 Marble Mármol M3
	€	€	€	€	€	€
	3.160	3.206	3.510	2.739	4.547	6.877
kg	50.82	50.82	50.82	50.82	50.82	50.82
1 box / bulto  m3	0.16	0.16	0.16	0.16	0.16	0.16

SERIE 600	*Matte lacquered and premium upcharge	408	***Marble shiny upcharge	30
	*Incremento por lacado mate y premium		Incremento por mármol brillo	

# Andreu World

## ME2674

2200 x 1000

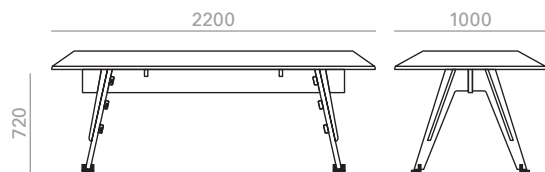

	Table top / Sobre			
	*Oak Roble	Lacquered Lacado	Linoleum Linóleo	Smoked gray Fumé gris
	€	€	€	€
	3.240	3.284	3.890	2.990
kg	54.63	54.63	54.63	54.63
1 box / bulto  m3	0.17	0.17	0.17	0.17

SERIE  
600

\*Matte  
lacquered  
and premium  
upcharge  
\*Incremento  
por lacado  
mate y  
premium

| 435 |

## ME2675

2400 x 1000

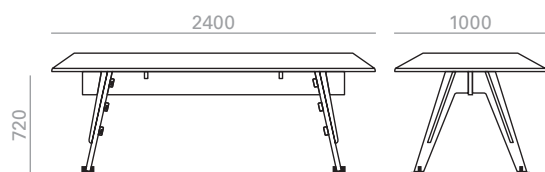

	Table top / Sobre			
	*Oak Roble	Lacquered Lacado	Linoleum Linóleo	Smoked gray Fumé gris
	€	€	€	€
	3.290	3.332	3.940	3.176
kg	58.89	58.89	58.89	58.89
1 box / bulto  m3	0.21	0.21	0.21	0.21

SERIE  
600

\*Matte  
lacquered  
and premium  
upcharge  
\*Incremento  
por lacado  
mate y  
premium

| 444 |



# Andreu World

## ME2676

2600 x 1200

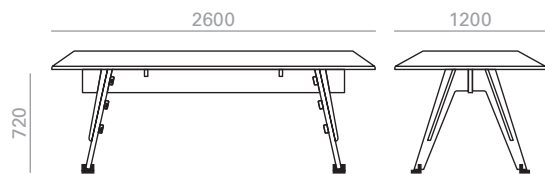

	Table top / Sobre			
	*Oak Roble	Lacquered Lacado	Linoleum Linóleo	Smoked gray Fumé gris
	€	€	€	€
	4.289	4.042	4.969	3.389
kg	72.37	72.37	72.37	72.37
1 box / bulto  m3	0.22	0.22	0.22	0.22

SERIE  
600

\*Matte  
lacquered  
and premium  
upcharge

\*Incremento  
por lacado  
mate y  
premium

| 444 |

## ME2677

2800 x 1200

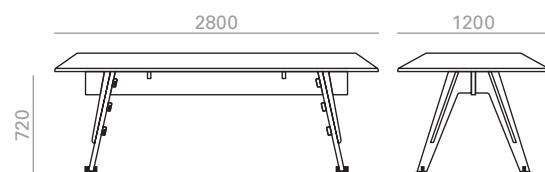

	Table top / Sobre			
	*Oak Roble	Lacquered Lacado	Linoleum Linóleo	Smoked gray Fumé gris
	€	€	€	€
	4.321	4.074	5.284	3.547
kg	77.7	77.7	77.7	77.7
1 box / bulto  m3	0.24	0.24	0.24	0.24

SERIE  
600

\*Matte  
lacquered  
and premium  
upcharge

\*Incremento  
por lacado  
mate y  
premium

| 483 |

## ME2678

3000 x 1200

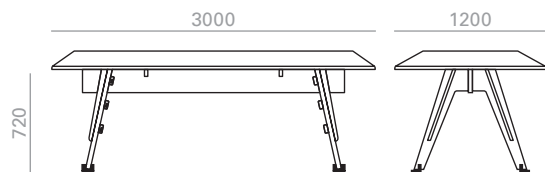

	Table top / Sobre			
	*Oak Roble	Lacquered Lacado	Linoleum Linóleo	Smoked gray Fumé gris
	€	€	€	€
	4.347	4.100	5.605	3.953
kg	82.42	82.42	82.42	82.42
<b>1 box / bulto</b> m3	0.25	0.25	0.25	0.25

SERIE 600	*Matte lacquered and premium upcharge	501	***Marble shiny upcharge Incremento por mármol brillo	30
	*Incremento por lacado mate y premium			

### Maximum table heights Alturas máximas de mesa

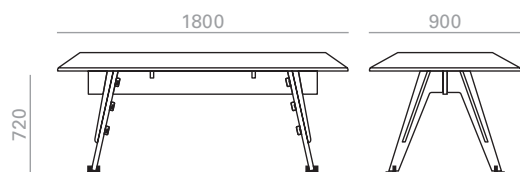
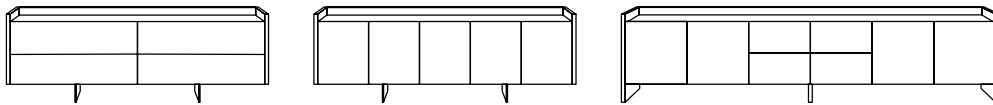

Table top / Sobre					
*Oak Roble	Lacquered Lacado	Linoleum Linóleo	Smoked gray Fumé gris	***M1 Marble Mármol M1	***M3 Marble Mármol M3
750	750	750	750	750	750



**Description** Wooden sideboards available in different sizes and finishes. Wall version and version with wooden or steel legs available in two different heights.  
**Descripción** Aparadores de madera disponibles en diferentes medidas y acabados. Versión de pared y versión con patas de madera o acero disponibles en dos alturas diferentes.

**Wood finish Oak**  
**Acabado madera**  
**Roble**



**Wood lacquer finish**  
**Acabado lacas madera**



**Wood finish Walnut**  
**Acabado madera**  
**Nogal**

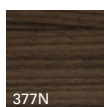

**Glass finish**  
**Acabado de cristal**

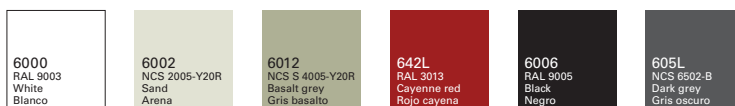

**Technical Stone 8 finish**  
**Acabado Technical**  
**Stone 8**

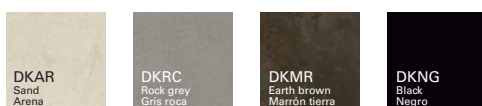

**M1 marble finish**  
**Acabado de mármol**  
**M1**

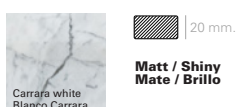

**M3 marble finish**  
**Acabado de mármol**  
**M3**

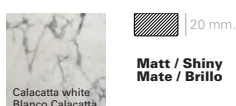

**Intellectual property Propiedad intelectual**

All our collections are protected by international industrial design registries, designs patents, copyrights and intellectual Property laws. Unauthorized use of AW International Property is a criminal offence and can lead to prosecution.  
 Todas nuestras colecciones están protegidas por registros de diseño industrial, diseño de patente, copyright y derechos de propiedad intelectual todo el mundo. El uso no autorizado de los diseños y propiedad intelectual de AW supone un delito que puede ser sometido a acción judicial.



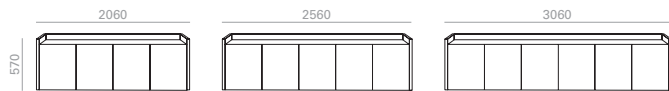

\*\*\*Marble shiny upcharge  
Incremento por mármol brillo

Credenza top															
Top measures Medidas sobre	Exterior material Material exterior			Lacquered Lacado		Low Iron Glass Cristal óptico		Top Technical Stone 8		***Marble M1 Mármol M1		***Marble M3 Mármol M3		Oak Roble	
				€	Ref.	€	Ref.	€	Ref.	€	Ref.	€	Ref.	€	Ref.
	2060x513x570	Oak Roble	S600	153	AP04000	3.091	AP04001	3.510	AP04002	3.810	AP04003	3.611	AP04005	4.638	AP04730
kg					123'42	125'4	129'47	163'13	163'13	123'42					
4 boxes / bultos					1,09	1,09	1,09	1,09	1'09	1'09					
2560x513x570	Oak Roble	S600	216	AP04006	3.578	AP04007	4.081	AP04008	4.462	AP04009	4.285	AP04011	5.598	AP04731	3.578
				kg		146'52	148'5	152'57	186'23	186'23	146'52				
				4 boxes / bultos		1,33	1,33	1,33	1,33	1'33	1'33				
3060x513x570	Oak Roble	S600	309	AP04012	4.306	AP04013	4.847	AP04014	5.251	AP04015	5.044	AP04017	6.636	AP04732	4.306
				kg		170'5	172'48	176'55	210'21	210'21	170'5				
				5 boxes / bultos		1,6	1,6	1,6	1,6	1'6	1'6				
2060x513x570	Walnut Nogal			AP04018	3.167	AP04019	3.578	AP04020	3.873	AP04021	3.673	AP04023	4.691	AP04733	3.167
				kg		123'42	125'4	129'47	163'13	163'13	123'42				
				4 boxes / bultos		1,09	1,09	1,09	1,09	1'09	1'09				
2560x513x570	Walnut Nogal			AP04024	3.656	AP04025	4.154	AP04026	4.532	AP04027	4.354	AP04029	5.660	AP04734	3.656
				kg		146'52	148'5	152'57	186'23	186'23	146'52				
				4 boxes / bultos		1,33	1,33	1,33	1,33	1'33	1'33				
3060x513x570	Walnut Nogal			AP04030	4.396	AP04031	4.927	AP04032	5.329	AP04033	5.122	AP04035	6.702	AP04735	4.396
				kg		170'5	172'48	176'55	210'21	210'21	170'5				
				5 boxes / bultos		1,6	1,6	1,6	1,6	1'6	1'6				
2060x513x570	Lacquered Lacado			AP04036	2.819	AP04037	3.267	AP04038	3.573	AP04039	3.374	AP04041	4.432	AP04736	2.819
				kg		123'42	125'4	129'47	163'13	163'13	123'42				
				4 boxes / bultos		1,09	1,09	1,09	1,09	1'09	1'09				
2560x513x570	Lacquered Lacado			AP04042	3.273	AP04043	3.809	AP04044	4.201	AP04045	4.022	AP04047	5.371	AP04737	3.273
				kg		146'52	148'5	152'57	186'23	186'23	146'52				
				4 boxes / bultos		1,33	1,33	1,33	1,33	1'33	1'33				
3060x513x570	Lacquered Lacado			AP04048	3.972	AP04049	4.546	AP04050	4.963	AP04051	4.756	AP04053	6.385	AP04738	3.972
				kg		170'5	172'48	176'55	210'21	210'21	170'5				
				5 boxes / bultos		1,6	1,6	1,6	1,6	1'6	1'6				

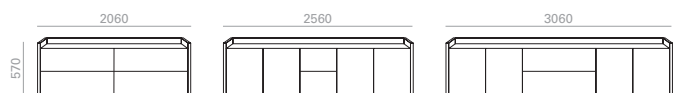

\*\*\*Marble shiny upcharge  
Incremento por mármol brillo

Credenza top															
Top measures Medidas sobre	Exterior material Material exterior			Lacquered Lacado		Low Iron Glass Cristal óptico		Top Technical Stone 8		***Marble M1 Mármol M1		***Marble M3 Mármol M3		Oak Roble	
				Ref.	€	Ref.	€	Ref.	€	Ref.	€	Ref.	€	Ref.	€
	€			Ref.	€	Ref.	€	Ref.	€	Ref.	€	Ref.	€	Ref.	€
2060x513x570	Oak Roble	S600	153	AP04072	4.399	AP04073	4.693	AP04074	4.799	AP04075	4.713	AP04077	6.144	AP04739	4.546
				kg		125'62	127'6	131'67	165'33	165'33	125'62				
				4 boxes / bultos		1,09	1,09	1,09	1,09	1'09	1'09				
2560x513x570	Oak Roble	S600	216	AP04078	4.568	AP04079	4.960	AP04080	5.057	AP04081	5.011	AP04083	6.687	AP04740	4.764
				kg		135'52	137'5	141'57	175'23	175'23	135'52				
				4 boxes / bultos		1,33	1,33	1,33	1,33	1'33	1'33				
3060x513x570	Oak Roble	S600	309	AP04084	4.606	AP04085	5.113	AP04086	5.329	AP04087	5.246	AP04089	7.434	AP04741	4.860
				kg		172'7	174'68	178'75	212'41	212'41	172'7				
				5 boxes / bultos		1,6	1,6	1,6	1,6	1'6	1'6				
2060x513x570	Walnut Nogal			AP04090	4.463	AP04091	4.750	AP04092	4.855	AP04093	4.769	AP04095	6.204	AP04742	4.607
				kg		125'62	127'6	131'67	165'33	165'33	125'62				
				4 boxes / bultos		1,09	1,09	1,09	1,09	1'09	1'09				
2560x513x570	Walnut Nogal			AP04096	4.645	AP04097	5.028	AP04098	5.124	AP04099	5.078	AP04101	6.757	AP04743	4.837
				kg		135'52	137'5	141'57	175'23	175'23	135'52				
				4 boxes / bultos		1,33	1,33	1,33	1,33	1'33	1'33				
3060x513x570	Walnut Nogal			AP04102	4.683	AP04103	5.185	AP04104	5.396	AP04105	5.314	AP04107	7.500	AP04744	4.935
				kg		172'7	174'68	178'75	212'41	212'41	172'7				
				5 boxes / bultos		1,6	1,6	1,6	1,6	1'6	1'6				
2060x513x570	Lacquered Lacado			AP04108	4.181	AP04109	4.495	AP04110	4.614	AP04111	4.524	AP04113	5.962	AP04745	4.339
				kg		125'62	127'6	131'67	165'33	165'33	125'62				
				4 boxes / bultos		1,09	1,09	1,09	1,09	1'09	1'09				
2560x513x570	Lacquered Lacado			AP04114	4.287	AP04115	4.705	AP04116	4.797	AP04117	4.767	AP04119	6.449	AP04746	4.495
				kg		135'52	137'5	141'57	175'23	175'23	135'52				
				4 boxes / bultos		1,33	1,33	1,33	1,33	1'33	1'33				
3060x513x570	Lacquered Lacado			AP04120	4.525	AP04121	4.764	AP04122	4.996	AP04123	4.907	AP04125	7.102	AP04747	4.645
				kg		172'7	174'68	178'75	212'41	212'41	172'7				
				5 boxes / bultos		1,6	1,6	1,6	1,6	1'6	1'6				

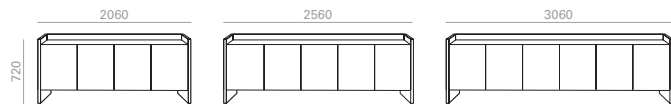

\*\*\*Marble shiny upcharge  
Incremento por mármol brillo

| 30 |



2060/2560 mm.  
Steel legs upcharge.  
Incremento por patas de acero.

| 183 |

3060 mm.  
Steel legs upcharge.  
Incremento por patas de acero.

| 276 |

Credenza top

Top measures Medidas sobre	Exterior material Material exterior			Credenza top											
				Lacquered Lacado		Low Iron Glass Cristal óptico		Top Technical Stone 8		***Marble M1 Mármol M1		***Marble M3 Mármol M3		Oak Roble	
	€	Ref.	€	Ref.	€	Ref.	€	Ref.	€	Ref.	€	Ref.	€		
2060x513x720	Oak Roble	S600	156	AP04432	2.967	AP04433	3.398	AP04434	3.703	AP04435	3.501	AP04437	4.545	AP04748	2.967
kg				125'62		127'6		131'67		165'33		165'33		125'62	
4 boxes / bultos				1,1		1,1		1,1		1,1		1'1		1'1	
2560x513x720	Oak Roble	S600	219	AP04438	3.453	AP04439	3.970	AP04440	4.354	AP04441	4.177	AP04443	5.505	AP04749	3.453
kg				148'72		150'7		154'77		188'43		188'43		148'72	
4 boxes / bultos				1,34		1,34		1,34		1,34		1'34		1'34	
3060x513x720	Oak Roble	S600	312	AP04444	4.275	AP04445	4.820	AP04446	5.224	AP04447	5.017	AP04449	6.613	AP04750	4.275
kg				178'2		180'18		184'25		217'91		217'91		178'2	
5 boxes / bultos				1,62		1,62		1,62		1,62		1'62		1'62	
2060x513x720	Walnut Nogal			AP04450	3.051	AP04451	3.474	AP04452	3.775	AP04453	3.575	AP04455	4.606	AP04751	3.051
kg				125'62		127'6		131'67		165'33		165'33		125'62	
4 boxes / bultos				1,1		1,1		1,1		1,1		1'1		1'1	
2560x513x720	Walnut Nogal			AP04456	3.545	AP04457	4.054	AP04458	4.432	AP04459	4.253	AP04461	5.573	AP04752	3.545
kg				148'72		150'7		154'77		188'43		188'43		148'72	
4 boxes / bultos				1,34		1,34		1,34		1,34		1'34		1'34	
3060x513x720	Walnut Nogal			AP04462	4.372	AP04463	4.904	AP04464	5.308	AP04465	5.101	AP04467	6.685	AP04753	4.372
kg				178'2		180'18		184'25		217'91		217'91		178'2	
5 boxes / bultos				1,62		1,62		1,62		1,62		1'62		1'62	
2060x513x720	Lacquered Lacado			AP04468	2.660	AP04469	3.127	AP04470	3.436	AP04471	3.237	AP04473	4.316	AP04754	2.660
kg				125'62		127'6		131'67		165'33		165'33		125'62	
4 boxes / bultos				1,1		1,1		1,1		1,1		1'1		1'1	
2560x513x720	Lacquered Lacado			AP04474	3.112	AP04475	3.670	AP04476	4.064	AP04477	3.885	AP04479	5.252	AP04755	3.112
kg				148'72		150'7		154'77		188'43		188'43		148'72	
4 boxes / bultos				1,34		1,34		1,34		1,34		1'34		1'34	
3060x513x720	Lacquered Lacado			AP04480	3.903	AP04481	4.491	AP04482	4.907	AP04483	4.700	AP04485	6.337	AP04756	3.903
kg				178'2		180'18		184'25		217'91		217'91		178'2	
5 boxes / bultos				1,62		1,62		1,62		1,62		1'62		1'62	

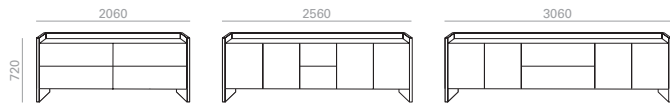

\*\*\*Marble shiny upcharge  
Incremento por mármol brillo

| 30 |



2060/2560 mm.  
Steel legs upcharge.  
Incremento por patas de acero.

| 183 |

3060 mm.  
Steel legs upcharge.  
Incremento por patas de acero.

| 276 |

Credenza top															
Top measures Medidas sobre	Exterior material Material exterior			Lacquered Lacado		Low Iron Glass Cristal óptico		Top Technical Stone 8		***Marble M1 Mármol M1		***Marble M3 Mármol M3		Oak Roble	
				Ref.	€	Ref.	€	Ref.	€	Ref.	€	Ref.	€	Ref.	€
	€			Ref.	€	Ref.	€	Ref.	€	Ref.	€	Ref.	€	Ref.	€
2060x513x720	Oak Roble	S600	156	AP04504	4.290	AP04505	4.594	AP04506	4.706	AP04507	4.617	AP04509	6.054	AP04757	4.442
kg				127'82		129'8		133'87		167'53		167'53		127'82	
4 boxes / bultos				1,1		1,1		1,1		1,1		1'1		1'1	
2560x513x720	Oak Roble	S600	219	AP04510	4.444	AP04511	4.851	AP04512	4.953	AP04513	4.896	AP04515	6.560	AP04758	4.465
kg				137'72		139'7		143'77		177'43		177'43		137'72	
4 boxes / bultos				1,34		1,34		1,34		1,34		1'34		1'34	
3060x513x720	Oak Roble	S600	312	AP04516	4.578	AP04517	5.086	AP04518	5.306	AP04519	5.222	AP04521	7.408	AP04759	4.832
kg				180'4		182'38		186'45		220'11		220'11		180'4	
5 boxes / bultos				1,62		1,62		1,62		1,62		1'62		1'62	
2060x513x720	Walnut Nogal			AP04522	4.363	AP04523	4.660	AP04524	4.768	AP04525	4.679	AP04527	6.117	AP04760	4.511
kg				127'82		129'8		133'87		167'53		167'53		127'82	
4 boxes / bultos				1,1		1,1		1,1		1,1		1'1		1'1	
2560x513x720	Walnut Nogal			AP04528	4.539	AP04529	4.937	AP04530	5.037	AP04531	4.977	AP04533	6.652	AP04761	4.738
kg				137'72		139'7		143'77		177'43		177'43		137'72	
4 boxes / bultos				1,34		1,34		1,34		1,34		1'34		1'34	
3060x513x720	Walnut Nogal			AP04534	4.662	AP04535	5.168	AP04536	5.377	AP04537	5.295	AP04539	7.484	AP04762	4.915
kg				180'4		182'38		186'45		220'11		220'11		180'4	
5 boxes / bultos				1,62		1,62		1,62		1,62		1'62		1'62	
2060x513x720	Lacquered Lacado			AP04540	4.045	AP04541	4.370	AP04542	4.495	AP04543	4.402	AP04545	5.842	AP04763	4.208
kg				127'82		129'8		133'87		167'53		167'53		127'82	
4 boxes / bultos				1,1		1,1		1,1		1,1		1'1		1'1	
2560x513x720	Lacquered Lacado			AP04546	4.141	AP04547	4.566	AP04548	4.681	AP04549	4.630	AP04551	6.307	AP04764	4.354
kg				137'72		139'7		143'77		177'43		177'43		137'72	
4 boxes / bultos				1,34		1,34		1,34		1,34		1'34		1'34	
3060x513x720	Lacquered Lacado			AP04552	4.260	AP04553	4.798	AP04554	5.029	AP04555	4.942	AP04557	7.132	AP04765	4.529
kg				180'4		182'38		186'45		220'11		220'11		180'4	
5 boxes / bultos				1,62		1,62		1,62		1,62		1'62		1'62	

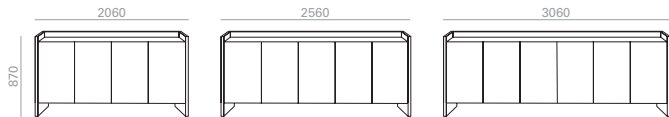

\*\*\*Marble shiny upcharge  
Incremento por mármol brillo

| 30 |



2060/2560 mm.  
Steel legs upcharge.  
Incremento por patas de acero.

| 183 |

3060 mm.  
Steel legs upcharge.  
Incremento por patas de acero.

| 276 |

Credenza top

Top measures Medidas sobre	Exterior material Material exterior			Lacquered Lacado		Low Iron Glass Cristal óptico		Top Technical Stone 8		***Marble M1 Mármol M1		***Marble M3 Mármol M3		Oak Roble			
				€	Ref.	€	Ref.	€	Ref.	€	Ref.	€	Ref.	€	Ref.	€	
	2060x513x870	Oak Roble	S600	162	AP04576	3.380	AP04577	3.763	AP04578	4.055	AP04579	3.857	AP04581	4.851	AP04766	3.380	
kg					156'42		158'4		162'47		196'13		196'13		156'42		
4 boxes / bultos					m3		1,12		1,12		1,12		1,12		1'12		
2560x513x870	Oak Roble	S600	225	AP04582	3.922	AP04583	4.384	AP04584	4.756	AP04585	4.577	AP04587	5.854	AP04767	3.922		
				kg		185'02		187		191'07		224'73		224'73		185'02	
				4 boxes / bultos		m3		1,36		1,36		1,36		1'36		1'36	
3060x513x870	Oak Roble	S600	318	AP04588	4.846	AP04589	5.322	AP04590	5.713	AP04591	5.506	AP04593	7.035	AP04768	4.846		
				kg		224'4		226'38		230'45		264'11		264'11		224'4	
				5 boxes / bultos		m3		1,64		1,64		1,64		1'64		1'64	
2060x513x870	Walnut Nogal			AP04594	3.479	AP04595	3.853	AP04596	4.142	AP04597	3.941	AP04599	4.925	AP04769	3.479		
				kg		156'42		158'4		162'47		196'13		196'13		156'42	
				4 boxes / bultos		m3		1,12		1,12		1,12		1'12		1'12	
2560x513x870	Walnut Nogal			AP04600	4.025	AP04601	4.482	AP04602	4.846	AP04603	4.669	AP04605	5.932	AP04770	4.025		
				kg		185'02		187		191'07		224'73		224'73		185'02	
				4 boxes / bultos		m3		1,36		1,36		1,36		1'36		1'36	
3060x513x870	Walnut Nogal			AP04606	4.962	AP04607	5.427	AP04608	5.814	AP04609	5.607	AP04611	7.123	AP04771	4.962		
				kg		224'4		226'38		230'45		264'11		264'11		224'4	
				5 boxes / bultos		m3		1,64		1,64		1,64		1'64		1'64	
2060x513x870	Lacquered Lacado			AP04612	3.012	AP04613	3.440	AP04614	3.742	AP04615	3.542	AP04617	4.578	AP04772	3.012		
				kg		156'42		158'4		162'47		196'13		196'13		156'42	
				4 boxes / bultos		m3		1,12		1,12		1,12		1'12		1'12	
2560x513x870	Lacquered Lacado			AP04618	3.522	AP04619	4.030	AP04620	4.415	AP04621	4.235	AP04623	5.556	AP04773	3.522		
				kg		185'02		187		191'07		224'73		224'73		185'02	
				4 boxes / bultos		m3		1,36		1,36		1,36		1'36		1'36	
3060x513x870	Lacquered Lacado			AP04624	4.405	AP04625	4.932	AP04626	5.335	AP04627	5.129	AP04629	6.708	AP04774	4.405		
				kg		224'4		226'38		230'45		264'11		264'11		224'4	
				5 boxes / bultos		m3		1,64		1,64		1,64		1'64		1'64	



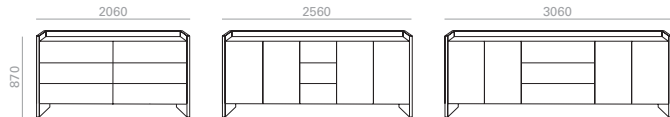

\*\*\*Marble shiny upcharge  
Incremento por mármol brillo

| 30 |



2060/2560 mm.  
Steel legs upcharge.  
Incremento por patas de acero.

| 183 |

3060 mm.  
Steel legs upcharge.  
Incremento por patas de acero.

| 276 |

Credenza top															
Top measures Medidas sobre	Exterior material Material exterior			Lacquered Lacado		Low Iron Glass Cristal óptico		Top Technical Stone 8		***Marble M1 Mármol M1		***Marble M3 Mármol M3		Oak Roble	
				Ref.	€	Ref.	€	Ref.	€	Ref.	€	Ref.	€	Ref.	€
	€	Ref.	€	Ref.	€	Ref.	€	Ref.	€	Ref.	€	Ref.	€	Ref.	€
2060x513x870	Oak Roble	S600	162	AP04648	5.557	AP04649	5.748	AP04650	5.797	AP04651	5.728	AP04653	7.145	AP04775	5.652
				kg		157'52	159'5	163'57	197'23	197'23	157'52				
	4 boxes / bultos		m3	1,12	1,12	1,12	1,12	1'12	1'12	1'12					
2560x513x870	Oak Roble	S600	225	AP04654	5.605	AP04655	5.916	AP04656	5.948	AP04657	5.916	AP04659	7.559	AP04776	5.760
				kg		196'02	198	202'07	235'73	235'73	196'02				
	4 boxes / bultos		m3	1,36	1,36	1,36	1,36	1'36	1'36	1'36					
3060x513x870	Oak Roble	S600	318	AP04660	5.780	AP04661	5.955	AP04662	6.124	AP04663	6.055	AP04665	8.228	AP04777	5.867
				kg		225'5	227'48	231'55	265'21	265'21	225'5				
	5 boxes / bultos		m3	1,64	1,64	1,64	1,64	1'64	1'64	1'64					
2060x513x870	Walnut Nogal			AP04666	5.645	AP04667	5.827	AP04668	5.873	AP04669	5.806	AP04671	7.223	AP04778	5.736
				kg		157'52	159'5	163'57	197'23	197'23	157'52				
	4 boxes / bultos		m3	1,12	1,12	1,12	1,12	1'12	1'12	1'12					
2560x513x870	Walnut Nogal			AP04672	5.724	AP04673	6.021	AP04674	6.051	AP04675	6.019	AP04677	7.664	AP04779	5.871
				kg		196'02	198	202'07	235'73	235'73	196'02				
	4 boxes / bultos		m3	1,36	1,36	1,36	1,36	1'36	1'36	1'36					
3060x513x870	Walnut Nogal			AP04678	5.886	AP04679	6.049	AP04680	6.212	AP04681	6.147	AP04683	8.317	AP04780	5.967
				kg		225'5	227'48	231'55	265'21	265'21	225'5				
	5 boxes / bultos		m3	1,64	1,64	1,64	1,64	1'64	1'64	1'64					
2060x513x870	Lacquered Lacado			AP04684	5.216	AP04685	5.440	AP04686	5.505	AP04687	5.430	AP04689	6.852	AP04781	5.328
				kg		157'52	159'5	163'57	197'23	197'23	157'52				
	4 boxes / bultos		m3	1,12	1,12	1,12	1,12	1'12	1'12	1'12					
2560x513x870	Lacquered Lacado			AP04690	5.199	AP04691	5.549	AP04692	5.596	AP04693	5.561	AP04695	7.213	AP04782	5.373
				kg		196'02	198	202'07	235'73	235'73	196'02				
	4 boxes / bultos		m3	1,36	1,36	1,36	1,36	1'36	1'36	1'36					
3060x513x870	Lacquered Lacado			AP04696	5.395	AP04697	5.592	AP04698	5.780	AP04699	5.707	AP04701	7.888	AP04783	5.494
				kg		225'5	227'48	231'55	265'21	265'21	225'5				
	5 boxes / bultos		m3	1,64	1,64	1,64	1,64	1'64	1'64	1'64					

Maximum table heights  
 Alturas máximas de mesa

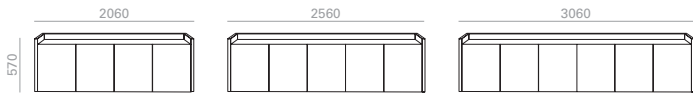

Lacquered Lacado	Low Iron Glass Cristal óptico	Top Technical Stone 8	***Marble M1 Mármol M1	***Marble M3 Mármol M3	Oak Roble
570	570	570	570	570	570

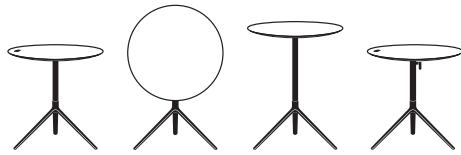

**Description**  
**Descripción**

Table with three-legged base in die-cast aluminum, available in different heights with polished aluminum finish in white or black. Tops made of round TOP 23 table top in oak finish, lacquered, Compacto HPL, laminate, ultra-matte and linoleum finish. Fold

Mesa con base de tres patas de inyección de aluminio, disponible en diferentes alturas y acabado aluminio pulido, blanco o negro. Sobres de tablero TOP 23 redondo en acabado roble, lacado, Compacto HPL, laminado, ultramate y linóleo. Opción de sistema abatible.

**Wood finish Oak**  
**Acabado madera Roble**



**Wood lacquer finish**  
**Acabado lacas madera**

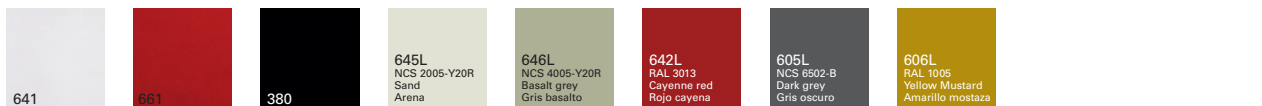

**Laminated**  
**Laminado**



**Compacto HPL finish**  
**Acabado Compacto HPL**

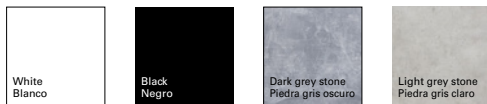

**Ultra-matte finish**  
**Acabado ultramate**



**Intellectual property Propiedad intelectual**

All our collections are protected by international industrial design registries, designs patents, copyrights and intellectual Property laws. Unauthorized use of AW International Property is a criminal offence and can lead to prosecution.

Todas nuestras colecciones están protegidas por registros de diseño industrial, diseño de patente, copyright y derechos de propiedad intelectual en todo el mundo. El uso no autorizado de los diseños y propiedad intelectual de AW supone un delito que puede ser sometido a acción judicial.





Folding system  
upcharge  
Incremento por  
sistema abatible

45

Table top / Sobre	Oak Roble		s600	Lacquered Lacado		Compacto HPL Compacto HPL		Laminate Laminado		Ultra-matte Ultramate		Linoleum Linoleo		
	Ref.	€	€	Ref.	€	Ref.	€	Ref.	€	Ref.	€	Ref.	€	
ø600	ME6010	418	90	ME6011	393	ME6012	396	ME6013	506	ME6014	530	ME6015	658	
kg	21			21			21			21			21	
2 boxes / bultos	0,34 m3			0,34 m3			0,34 m3			0'34 m3			0'34 m3	
ø700	ME6016	465	96	ME6017	420	ME6018	423	ME6019	555	ME6020	590	ME6021	731	
kg	22			22			22			22			22	
2 boxes / bultos	0,36 m3			0,36 m3			0,36 m3			0'36 m3			0'36 m3	
ø800	ME6022	515	102	ME6023	455	ME6024	469	ME6025	605	ME6026	655	ME6027	803	
kg	25			25			25			25			25	
2 boxes / bultos	0,38 m3			0,38 m3			0,38 m3			0'38 m3			0'38 m3	
ø900	ME6028	587	108	ME6029	490	ME6030	512	ME6031	677	ME6032	735	ME6033	883	
kg	28			28			28			28			28	
2 boxes / bultos	0,4 m3			0,4 m3			0,4 m3			0'4 m3			0'4 m3	



Folding system  
upcharge  
Incremento por  
sistema abatible

45

Table top / Sobre	Oak Roble		s600	Lacquered Lacado		Compacto HPL Compacto HPL		Laminate Laminado		Ultra-matte Ultramate		Linoleum Linoleo		
	Ref.	€	€	Ref.	€	Ref.	€	Ref.	€	Ref.	€	Ref.	€	
ø600	ME6034	453	90	ME6035	432	ME6036	434	ME6037	544	ME6038	568	ME6039	697	
kg	24			24			24			24			24	
2 boxes / bultos	0,42 m3			0,42 m3			0,42 m3			0'42 m3			0'42 m3	
ø700	ME6040	503	96	ME6041	458	ME6042	460	ME6043	593	ME6044	627	ME6045	769	
kg	25			25			25			25			25	
2 boxes / bultos	0,44 m3			0,44 m3			0,44 m3			0'44 m3			0'44 m3	
ø800	ME6046	552	102	ME6047	491	ME6048	506	ME6049	643	ME6050	692	ME6051	842	
kg	28			28			28			28			28	
2 boxes / bultos	0,46 m3			0,46 m3			0,46 m3			0'46 m3			0'46 m3	



Folding system  
upcharge  
Incremento por  
sistema abatible

45

Table top / Sobre	Oak Roble		s600	Lacquered Lacado		Compacto HPL Compacto HPL		Laminate Laminado		Ultra-matte Ultramate		Linoleum Linoleo	
	Ref.	€		€	Ref.	€	Ref.	€	Ref.	€	Ref.	€	
ø600	ME6052	471	90	ME6053	447	ME6054	450	ME6055	559	ME6056	585	ME6057	711
kg	25		25		25		25		25		25		
2 boxes / bultos	0,49 m3		0,49 m3		0,49 m3		0,49 m3		0,49 m3		0,49 m3		
ø700	ME6058	521	96	ME6059	473	ME6060	477	ME6061	609	ME6062	645	ME6063	784
kg	26		26		26		26		26		26		
2 boxes / bultos	0,51 m3		0,51 m3		0,51 m3		0,51 m3		0,51 m3		0,51 m3		
ø800	ME6064	569	102	ME6065	507	ME6066	522	ME6067	660	ME6068	707	ME6069	859
kg	29		29		29		29		29		29		
2 boxes / bultos	0,53 m3		0,53 m3		0,53 m3		0,53 m3		0,53 m3		0,53 m3		

Maximum table heights  
Alturas máximas de mesa



Table top					
Oak Roble	Lacquered Lacado	Compacto HPL Compacto HPL	Laminate Laminado	Ultra-matte Ultramate	Linoleum Linoleo
750	750	739	750	750	750

Maximum table heights  
Alturas máximas de mesa



Table top					
Oak Roble	Lacquered Lacado	Compacto HPL Compacto HPL	Laminate Laminado	Ultra-matte Ultramate	Linoleum Linoleo
900	900	900	900	900	889

Maximum table heights  
Alturas máximas de mesa



Table top					
Oak Roble	Lacquered Lacado	Compacto HPL Compacto HPL	Laminate Laminado	Ultra-matte Ultramate	Linoleum Linoleo
1090	1090	1090	1090	1090	1079



**Andreu World**

**Occasional Tables**

**Mesas ocasionales**





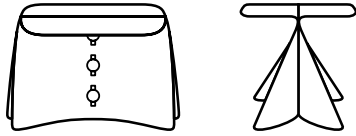

**Description**  
**Descripción**

Occasional table with oak structure and top available in two different heights.  
Mesa ocasional con estructura y sobre de roble disponible en dos alturas diferentes.

**Wood finish Oak**  
**Acabado madera**  
**Roble**



**Wood lacquer finish**  
**Acabado lacas madera**



**Intellectual property Propiedad intelectual**

All our collections are protected by international industrial design registries, designs patents, copyrights and intellectual Property laws. Unauthorized use of AW International Property is a criminal offence and can lead to prosecution.  
Todas nuestras colecciones están protegidas por registros de diseño industrial, diseño de patente, copyright y derechos de propiedad intelectual en todo el mundo. El uso no autorizado de los diseños y propiedad intelectual de AW supone un delito que puede ser sometido a acción judicial.



Occasional Table.

ME2695

742

0'08 m3

Mesa auxiliar.

3'76 kg

x1

1 boxes bultos

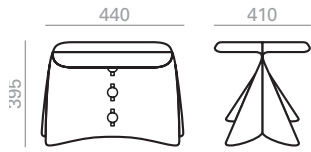

Occasional Table.

ME2696

785

0'09 m3

Mesa auxiliar.

4'66 kg

x1

1 boxes bultos

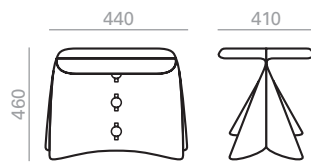

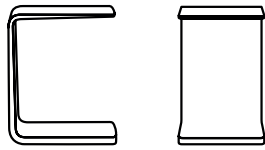

**Description** Oak occasional table.  
**Descripción** Mesa auxiliar de roble.

**Wood finish Oak**  
**Acabado madera**  
**Roble**



**Wood lacquer finish**  
**Acabado lacas madera**



**Intellectual property Propiedad intelectual**

All our collections are protected by international industrial design registries, designs patents, copyrights and intellectual Property laws. Unauthorized use of AW International Property is a criminal offence and can lead to prosecution.  
Todas nuestras colecciones están protegidas por registros de diseño industrial, diseño de patente, copyright y derechos de propiedad intelectual en todo el mundo. El uso no autorizado de los diseños y propiedad intelectual de AW supone un delito que puede ser sometido a acción judicial.



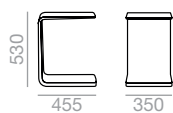

Auxiliary table.  
Mesa auxiliar.

**ME5486**  
**Oak Roble**

526

0'15 m3  
 14 kg  
 x1  
1 boxes bultos



Incremento por Lacado  
Mate y Premium  
Matt Lacquered and  
Premium Upcharge

| 75 |

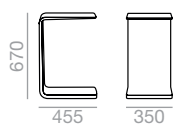

Auxiliary table.  
Mesa auxiliar.

**ME5488**  
**Oak Roble**

530

0'26 m3  
 15 kg  
 x1  
1 boxes bultos



Incremento por Lacado  
Mate y Premium  
Matt Lacquered and  
Premium Upcharge

| 80 |

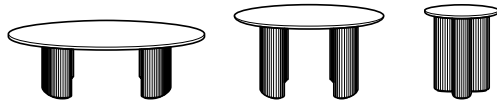

**Description**

Occasional table with Pure Eco thermo-polymer (100% recycled) available in several colors. Round table tops in several sizes available in various finishes.

**Descripción**

Mesa ocasional con base de termopolímero Pure Eco (100% reciclado) disponible en diferentes colores. Sobres redondos de diferentes medidas disponible en diferentes acabados.

**Wood finish Oak**

**Acabado madera Roble**



**Wood lacquer finish**

**Acabado lacas madera**



**Technical Stone 8 finish**

**Acabado Technical Stone 8**

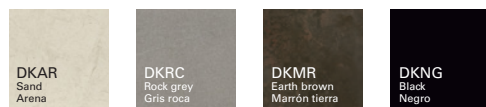

**Compacto HPL finish**

**Acabado Compacto HPL**

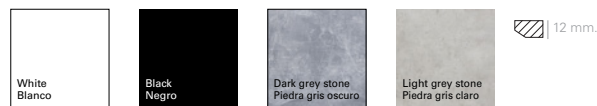

**Solid Surface finish**

**Acabado Solid Surface**



**M1 marble finish**

**Acabado de mármol M1**

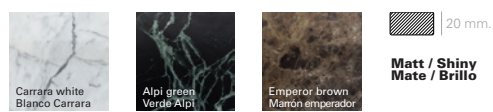

**M2 marble finish**

**Acabado de mármol M2**

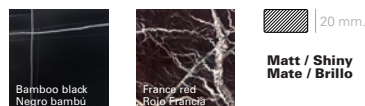

**M3 marble finish**

**Acabado de mármol M3**



**Pure Eco Thermo-polymer finish**

**Acabado de Termo-polímero Pure Eco**

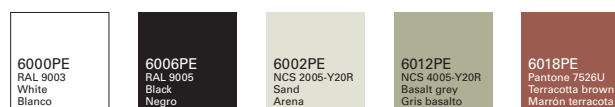

**Intellectual property Propiedad intelectual**

All our collections are protected by international industrial design registries, designs patents, copyrights and intellectual Property laws. Unauthorized use of AW International Property is a criminal offence and can lead to prosecution.

Todas nuestras colecciones están protegidas por registros de diseño industrial, diseño de patente, copyright y derechos de propiedad intelectual en todo el mundo. El uso no autorizado de los diseños y propiedad intelectual de AW supone un delito que puede ser sometido a acción judicial.



ME1746

ø410

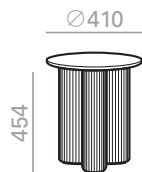

	Table top / Sobre				
	*Oak Roble	Lacquered Lacado	Technical Stone 8	Solid Surface	Compacto HPL
	€	€	€	€	€
	442	377	542	485	390
kg	12.45	12.45	12.45	12.45	12.45
1 box / bulto  m3	0.09	0.09	0.09	0.09	0.09

	Table top / Sobre		
	***M1 Marble M1	***M2 Marble M2	***M3 Marble M3
	€	€	€
	813	865	948
kg	12.45	12.45	12.45
1 box / bulto  m3	0.09	0.09	0.09

SERIE 600	*Matte lacquered and premium upcharge	66	***Marble shiny upcharge	30
	*Incremento por lacado mate y premium		Incremento por mármol brillo	

ME1747

ø800



	Table top / Sobre				
	*Oak Roble	Lacquered Lacado	Technical Stone 8	Solid Surface	Compacto HPL
	€	€	€	€	€
	858	692	1.118	929	708
kg	26.5	26.5	26.5	26.5	26.5
1 box / bulto  m3	0.13	0.13	0.13	0.13	0.13

	Table top / Sobre		
	***M1 Marble Mármol M1	***M2 Marble Mármol M2	***M3 Marble Mármol M3
	€	€	€
	1.974	2.171	2.418
kg	26.5	26.5	26.5
1 box / bulto  m3	0.13	0.13	0.13

SERIE 600

\*Matte lacquered and premium upcharge  
 \*Incremento por lacado mate y premium

| 147 |

\*\*\*Marble shiny upcharge  
 Incremento por mármol brillo

| 30 |

ME1748

∅900



	Table top / Sobre				
	*Oak Roble	Lacquered Lacado	Technical Stone 8	Solid Surface	Compacto HPL
	€	€	€	€	€
	939	731	1.189	934	756
kg	27.92	27.92	27.92	27.92	27.92
1 box / bulto  m3	0.14	0.14	0.14	0.14	0.14

	Table top / Sobre		
	***M1 Marble Mármol M1	***M2 Marble Mármol M2	***M3 Marble Mármol M3
	€	€	€
	2.032	2.271	2.577
kg	27.92	27.92	27.92
1 box / bulto  m3	0.14	0.14	0.14

SERIE 600	*Matte lacquered and premium upcharge	147	***Marble shiny upcharge	30
	*Incremento por lacado mate y premium		Incremento por mármol brillo	



ME1749

∅1000

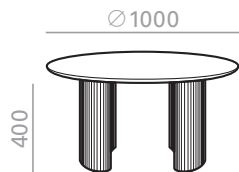

	Table top / Sobre				
	*Oak Roble	Lacquered Lacado	Technical Stone 8	Solid Surface	Compacto HPL
	€	€	€	€	€
	1.027	750	1.261	1.231	842
kg	29.51	29.51	29.51	29.51	29.51
1 box / bulto  m3	0.14	0.14	0.14	0.14	0.14

	Table top / Sobre		
	***M1 Marble Mármol M1	***M2 Marble Mármol M2	***M3 Marble Mármol M3
	€	€	€
	2.227	2.513	2.919
kg	29.51	29.51	29.51
1 box / bulto  m3	0.14	0.14	0.14

SERIE 600	*Matte lacquered and premium upcharge *Incremento por lacado mate y premium	147	***Marble shiny upcharge Incremento por mármol brillo	30
--------------	--	-----	--	----

ME1753

∅1100

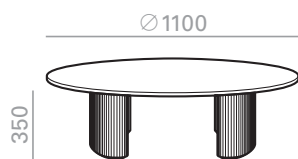

	Table top / Sobre				
	*Oak Roble	Lacquered Lacado	Technical Stone 8	Solid Surface	Compacto HPL
	€	€	€	€	€
	1.110	844	1.334	1.274	1.042
kg	35.48	35.48	35.48	35.48	35.48
1 box / bulto  m3	0.22	0.22	0.22	0.22	0.22

	Table top / Sobre		
	***M1 Marble Mármol M1	***M2 Marble Mármol M2	***M3 Marble Mármol M3
	€	€	€
	2.497	2.835	3.310
kg	35.48	35.48	35.48
1 box / bulto  m3	0.22	0.22	0.22

SERIE 600	*Matte lacquered and premium upcharge	147	***Marble shiny upcharge	30
	*Incremento por lacado mate y premium		Incremento por mármol brillo	

ME1754

∅1200

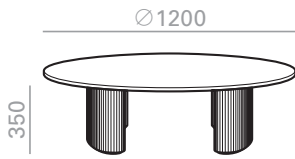

	Table top / Sobre				
	*Oak Roble	Lacquered Lacado	Technical Stone 8	Solid Surface	Compacto HPL
	€	€	€	€	€
	1.173	877	1.410	1.334	1.044
kg	38.1	38.1	38.1	38.1	38.1
1 box / bulto  m3	0.22	0.22	0.22	0.22	0.22

	Table top / Sobre		
	***M1 Marble Mármol M1	***M2 Marble Mármol M2	***M3 Marble Mármol M3
	€	€	€
	2.750	3.145	3.718
kg	38.1	38.1	38.1
1 box / bulto  m3	0.22	0.22	0.22

SERIE 600	*Matte lacquered and premium upcharge	147	***Marble shiny upcharge	30
	*Incremento por lacado mate y premium		Incremento por mármol brillo	

ME1755

∅1300

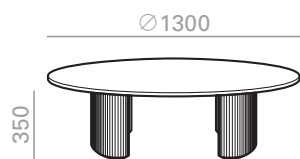
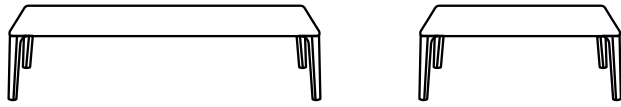

	Table top / Sobre				
	*Oak Roble	Lacquered Lacado	Technical Stone 8	Solid Surface	Compacto HPL
	€	€	€	€	€
	1.313	919	1.484	1.402	1.060
kg	39.44	39.44	39.44	39.44	39.44
1 box / bulto  m3	0.23	0.23	0.23	0.23	0.23

	Table top / Sobre		
	***M1 Marble Mármol M1	***M2 Marble Mármol M2	***M3 Marble Mármol M3
	€	€	€
	3.016	3.455	4.169
kg	39.44	39.44	39.44
1 box / bulto  m3	0.23	0.23	0.23

SERIE 600	*Matte lacquered and premium upcharge	147	***Marble shiny upcharge	30
	*Incremento por lacado mate y premium		Incremento por mármol brillo	



**Description**  
**Descripción**

Table with 4 aluminum legs and injected aluminum column, available in 2 heights. Available finishes include polished aluminum, matte white and black and plywood tops in different shapes and sizes in oak, lacquer, Technical Stone, HPL, Calacatta marble and  
Mesa con base de 4 aspas de aluminio y columna de inyección de aluminio, disponible en 2 alturas. Disponible en acabados aluminio pulido, blanco mate o negro mate y sobres de tablero de diferentes formas y medidas en acabado roble, lacado, Technical Stone

**Wood finish Oak**  
**Acabado madera Roble**



**Wood lacquer finish**  
**Acabado lacas madera**



**M1 marble finish**  
**Acabado de mármol M1**

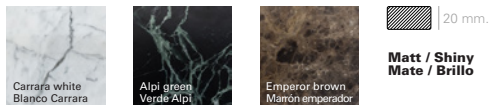

**M2 marble finish**  
**Acabado de mármol M2**

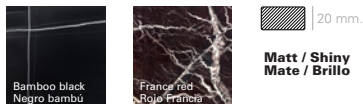

**Aluminum finish**  
**Acabado aluminio**



**Intellectual property Propiedad intelectual**

All our collections are protected by international industrial design registries, designs patents, copyrights and intellectual Property laws. Unauthorized use of AW International Property is a criminal offence and can lead to prosecution.  
Todas nuestras colecciones están protegidas por registros de diseño industrial, diseño de patente, copyright y derechos de propiedad intelectual en todo el mundo. El uso no autorizado de los diseños y propiedad intelectual de AW supone un delito que puede ser sometido a acción judicial.



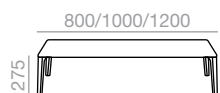

\*\*\*Marble shiny upcharge  
Incremento por mármol brillo

SERIE 600

\*Matte lacquered and premium upcharge  
\*Incremento por lacado mate y premium

30

141

Table height / Altura de mesa 275									
Top measures Medidas sobre	Aluminium finish Acabado de Aluminio	Table top / Sobre							
		Oak Roble		Lacquered Lacado		***Marble M1 Mármol M1		***Marble M2 Mármol M2	
		Ref.	€	Ref.	€	Ref.	€	Ref.	€
800x800	Matte Mate	ME2140	900	ME2146	605	ME2150	1.841	ME2152	2.125
	Polished aliminum Aluminio pulido	ME2141	922	ME2147	639	ME2151	1.860	ME2153	2.189
kg		17		17		53		53	
1 box / bulto m3		0,31		0,31		0,7		0,7	
1000x1000	Matte Mate	ME2154	1.023	ME2156	634	ME2158	2.118	ME2160	2.550
	Polished aliminum Aluminio pulido	ME2155	1.063	ME2157	667	ME2159	2.140	ME2161	2.622
kg		20		20		65		65	
1 box / bulto m3		0,46		0,46		0,98		0,98	
1200x1200	Matte Mate	ME2162	1.300	ME2164	680	ME2166	2.483	ME2168	3.047
	Polished aliminum Aluminio pulido	ME2163	1.323	ME2165	734	ME2167	2.507	ME2169	3.193
kg		26		26		87		87	
1 box / bulto m3		0,64		0,64		1,3		1,3	
800x500	Matte Mate	ME2170	784	ME2172	583	ME2174	1.691	ME2176	1.882
	Polished aliminum Aluminio pulido	ME2171	820	ME2173	613	ME2175	1.715	ME2177	1.905
kg		12		12		33		33	
1 box / bulto m3		0,2		0,2		0,51		0,51	
1200x600	Matte Mate	ME2178	900	ME2180	612	ME2182	1.939	ME2184	2.256
	Polished aliminum Aluminio pulido	ME2179	941	ME2181	644	ME2183	1.958	ME2185	2.318
kg		16		16		48		48	
1 box / bulto m3		0,35		0,35		0,7		0,7	

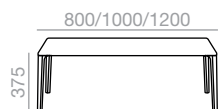

\*\*\*Marble shiny upcharge  
Incremento por mármol brillo

SERIE 600

\*Matte lacquered and premium upcharge  
\*Incremento por lacado mate y premium

30

141

Table height / Altura de mesa 375									
Top measures Medidas sobre	Aluminium finish Acabado de Aluminio	Table top / Sobre							
		Oak Roble		Lacquered Lacado		***Marble M1 Mármol M1		***Marble M2 Mármol M2	
		Ref.	€	Ref.	€	Ref.	€	Ref.	€
800x800	Matte Mate	ME2400	961	ME2402	646	ME2404	1.967	ME2406	2.270
	Polished aliminum Aluminio pulido	ME2401	1.003	ME2403	681	ME2405	1.989	ME2407	2.292
kg		13		13		49'6		49'6	
1 box / bulto m3		0,42		0,42		0,82		0,82	
1000x1000	Matte Mate	ME2408	1.091	ME2410	674	ME2412	2.263	ME2414	2.726
	Polished aliminum Aluminio pulido	ME2409	1.135	ME2411	725	ME2413	2.286	ME2415	2.749
kg		16'4		16'4		70'8		70'8	
1 box / bulto m3		0,63		0,63		1,15		1,15	
1200x1200	Matte Mate	ME2416	1.377	ME2418	705	ME2420	2.602	ME2422	3.258
	Polished aliminum Aluminio pulido	ME2417	1.339	ME2419	742	ME2421	2.625	ME2423	3.346
kg		23'15		23'15		111'15		111'15	
1 box / bulto m3		0,87		0,87		1,53		1,53	
800x500	Matte Mate	ME2424	835	ME2426	620	ME2428	1.770	ME2430	1.971
	Polished aliminum Aluminio pulido	ME2425	875	ME2427	653	ME2429	1.831	ME2431	1.995
kg		10'2		10'2		35'4		35'4	
1 box / bulto m3		0,28		0,28		0,6		0,6	
1200x600	Matte Mate	ME2432	959	ME2434	652	ME2436	2.070	ME2438	2.408
	Polished aliminum Aluminio pulido	ME2433	1.001	ME2435	688	ME2437	2.092	ME2439	2.431
kg		14'65		14'65		52'9		52'9	
1 box / bulto m3		0,48		0,48		0,82		0,82	

Maximum table heights  
Alturas máximas de mesa

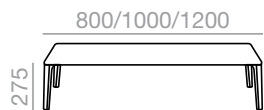

Table top			
Oak Roble	Lacquered Lacado	***Marble M1 Mármol M1	***Marble M2 Mármol M2
276	276	278	278

Maximum table heights  
Alturas máximas de mesa

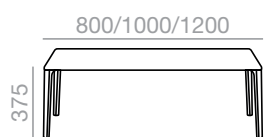

Table top			
Oak Roble	Lacquered Lacado	***Marble M1 Mármol M1	***Marble M2 Mármol M2
373	373	375	375





**Description**  
**Descripción**

Table with injected aluminum circular base and oval column, available in 2 heights. Available finishes include polished aluminum, matte white and black and plywood tops in different shapes and sizes in oak, lacquer, Technical Stone, HPL, Carrara marble an  
Mesa con base circular y columna ovalada de inyección de aluminio, disponible en 2 alturas. Disponible en acabados aluminio pulido, blanco mate o negro mate y sobres de tablero de diferentes formas y medidas en acabado roble, lacado, Technical Stone, Comp

**Wood finish Oak**  
**Acabado madera Roble**



**Wood lacquer finish**  
**Acabado lacas madera**



**Compacto HPL finish**  
**Acabado Compacto HPL**

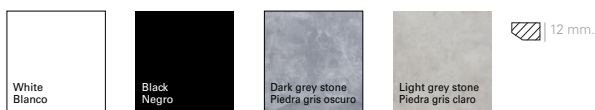

**Solid Surface finish**  
**Acabado Solid Surface**

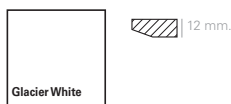

**Technical Stone decorative finish**  
**Acabado Technical Stone**

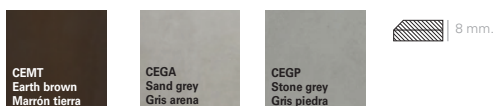

**M1 marble finish**  
**Acabado de mármol M1**

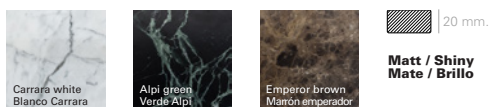

**M2 marble finish**  
**Acabado de mármol M2**

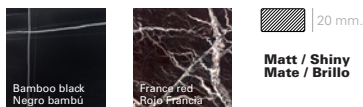

**Aluminum finish**  
**Acabado aluminio**



**Certificates**  
**Certificados**

Quality - Resistance  
Calidad - Resistencia

UNE CEN/TR 581-4

Durability of exterior-grade furniture.  
Durabilidad de mobiliario de exterior.

**Intellectual property Propiedad intelectual**

All our collections are protected by international industrial design registries, designs patents, copyrights and intellectual Property laws. Unauthorized use of AW International Property is a criminal offence and can lead to prosecution.  
Todas nuestras colecciones están protegidas por registros de diseño industrial, diseño de patente, copyright y derechos de propiedad intelectual todo el mundo. El uso no autorizado de los diseños y propiedad intelectual de AW supone un delito que puede ser sometido a acción judicial.



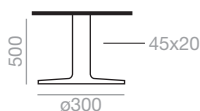
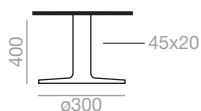

\*\*\*Marble shiny upcharge  
Incremento por mármol brillo

SERIE 600

\*Matte lacquered and premium upcharge  
\*Incremento por lacado mate y premium

30

57

Column height / Altura columna 400															
Top measures Medidas sobre	Aluminium finish Acabado de Aluminio	Table top / Sobre													
		Lacquered Lacado		Oak Roble		Solid Surface Solid Surface		***Marble M1 Mármol M1		***Marble M2 Mármol M2		Compacto HPL Compacto HPL		Technical Stone	
		Ref.	€	Ref.	€	Ref.	€	Ref.	€	Ref.	€	Ref.	€	Ref.	€
400x400	Matte Mate	ME6350	319	ME6368	355	ME6386	395	ME6404	480	ME6514	518	ME6422	279	ME6484	337
	Polished aliminum Aluminio pulido	ME6352	327	ME6370	368	ME6388	411	ME6406	485	ME6515	502	ME6424	291	ME6486	350
<b>kg</b>		9		9		10		16		257		10		16	
<b>1 box / bulto</b> <b>m3</b>		0,09		0,09		0,09		0,09		0'09		0'09		0'09	

ellipse/ elipse 450x450	Matte Mate	ME6353	332	ME6371	365	ME6389	409	ME6407	615	ME6516	705	ME6427	286	ME6489	540
	Polished aliminum Aluminio pulido	ME6355	345	ME6373	377	ME6391	416	ME6409	627	ME6517	720	ME6429	299	ME6491	554
<b>kg</b>		9		9		10		15		257		9		15	
<b>1 box / bulto</b> <b>m3</b>		0,11		0,11		0,11		0,11		0'11		0'11		0'11	

ø450	Matte Mate	ME6356	331	ME6374	389	ME6392	409	ME6410	688	ME6518	702	ME6432	282	ME6494	540
	Polished aliminum Aluminio pulido	ME6358	345	ME6376	399	ME6394	477	ME6412	700	ME6519	717	ME6434	312	ME6496	554
<b>kg</b>		9		9		10		16		279		10		16	
<b>1 box / bulto</b> <b>m3</b>		0,11		0,11		0,11		0,11		0'11		0'11		0'11	

Column height / Altura columna 500															
Top measures Medidas sobre	Aluminium finish Acabado de Aluminio	Table top / Sobre													
		Lacquered Lacado		Oak Roble		Solid Surface Solid Surface		***Marble M1 Mármol M1		***Marble M2 Mármol M2		Compacto HPL Compacto HPL		Technical Stone	
		Ref.	€	Ref.	€	Ref.	€	Ref.	€	Ref.	€	Ref.	€	Ref.	€
400x400	Matte Mate	ME6359	321	ME6377	358	ME6395	409	ME6413	533	ME6520	488	ME6437	288	ME6499	339
	Polished aliminum Aluminio pulido	ME6361	339	ME6379	378	ME6397	429	ME6415	555	ME6521	502	ME6439	309	ME6501	353
<b>kg</b>		9		9		11		16		279		10		16	
<b>1 box / bulto</b> <b>m3</b>		0,1		0,1		0,1		0,1		0'1		0'1		0'1	

ellipse/ elipse 450x450	Matte Mate	ME6362	333	ME6380	367	ME6398	407	ME6416	617	ME6522	707	ME6442	288	ME6504	544
	Polished aliminum Aluminio pulido	ME6364	354	ME6382	389	ME6400	429	ME6418	639	ME6523	730	ME6444	309	ME6506	557
<b>kg</b>		9		9		10		15		279		10		15	
<b>1 box / bulto</b> <b>m3</b>		0,13		0,13		0,13		0,13		0'13		0'13		0'13	

ø450	Matte Mate	ME6365	333	ME6383	388	ME6401	410	ME6419	693	ME6524	704	ME6447	300	ME6509	544
	Polished aliminum Aluminio pulido	ME6367	354	ME6385	407	ME6403	430	ME6421	714	ME6525	727	ME6449	301	ME6511	557
<b>kg</b>		9		9		11		16		12'75		10		16	
<b>1 box / bulto</b> <b>m3</b>		0,13		0,13		0,13		0,13		0'13		0'13		0'13	

Maximum table heights  
 Alturas máximas de mesa

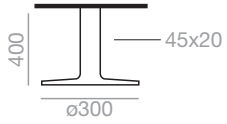

Table top			
Lacquered Lacado	Oak Roble	Solid Surface Solid Surface	***Marble M1 Mármol M1
418	418	412	420

Maximum table heights  
 Alturas máximas de mesa

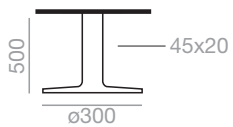
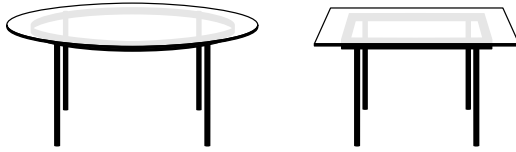

Table top			
Lacquered Lacado	Oak Roble	Solid Surface Solid Surface	***Marble M1 Mármol M1
518	518	512	520





**Description**  
**Descripción**

Occasional table with 4 legs steel tube base finished in white, black or polished chrome. Available in 3 heights. Glass table tops in different shapes and sizes finished in transparent or smoked gray.

Mesa auxiliar con base de 4 patas de tubo de acero y acabado blanco, negro o cromo brillo. Disponible en 3 alturas. Sobres de cristal en diferentes formas y medidas en acabado transparente o fume gris.

**Glass finish**  
**Acabado de cristal**



**Steel finish**  
**Acabado de acero**



**Intellectual property Propiedad intelectual**

All our collections are protected by international industrial design registries, designs patents, copyrights and intellectual Property laws. Unauthorized use of AW International Property is a criminal offence and can lead to prosecution.

Todas nuestras colecciones están protegidas por registros de diseño industrial, diseño de patente, copyright y derechos de propiedad intelectual en todo el mundo. El uso no autorizado de los diseños y propiedad intelectual de AW supone un delito que puede ser sometido a acción judicial.



Element 37

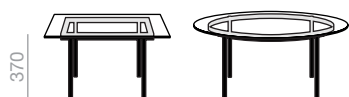

Ref.	Top measures Medidas sobre	Steel finish Acabado acero	Table top / Sobre		Polished chrome frame up charge. Incremento estructura en cromo brillo.	Packaging info Datos de embalaje	
			Transparent Transparente	Smoked gray Fumé gris		kg	2 boxes/bultos <input type="checkbox"/> m3
			€	€			
ME1031	750 x 750	Matte white/Matte black Blanco mate/Negro mate	731	814	101	28,27	0,5
ME1032	1000 x 1000	Matte white/Matte black Blanco mate/Negro mate	831	885	195	45,25	0,87
ME1033	ø800	Matte white/Matte black Blanco mate/Negro mate	750	786	105	31,6	0,57
ME1034	ø900	Matte white/Matte black Blanco mate/Negro mate	806	850	150	37,59	0,71
ME1035	ø1300	Matte white/Matte black Blanco mate/Negro mate	1.073	1.165	233	67,29	1,45

Element 45

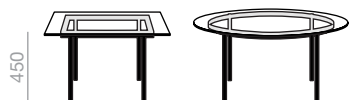

Ref.	Top measures Medidas sobre	Steel finish Acabado acero	Table top / Sobre		Polished chrome frame up charge. Incremento estructura en cromo brillo.	Packaging info Datos de embalaje	
			Transparent Transparente	Smoked gray Fumé gris		kg	2 boxes/bultos <input type="checkbox"/> m3
			€	€			
ME1036	1000 x 1000	Matte white/Matte black Blanco mate/Negro mate	837	891	206	45,25	0,94
ME1037	1400 x 1400	Matte white/Matte black Blanco mate/Negro mate	1.113	1.218	333	75,05	1,81
ME1038	ø800	Matte white/Matte black Blanco mate/Negro mate	757	792	110	31,6	0,61
ME1039	ø900	Matte white/Matte black Blanco mate/Negro mate	811	855	150	37,59	0,77
ME1040	ø1300	Matte white/Matte black Blanco mate/Negro mate	1.080	1.172	254	67,29	1,57

Element 50

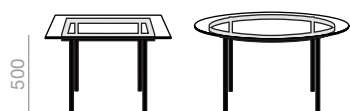

Ref.	Top measures Medidas sobre	Steel finish Acabado acero	Table top / Sobre		Polished chrome frame up charge. Incremento estructura en cromo brillo.	Packaging info Datos de embalaje	
			Transparent Transparente	Smoked gray Fumé gris		kg	2 boxes/bultos  m3
			€	€			
ME1041	600 x 600	Matte white/Matte black Blanco mate/Negro mate	628	648	98	21,35	0,37
ME1042	750 x 750	Matte white/Matte black Blanco mate/Negro mate	741	824	114	28,27	0,56
ME1043	ø500	Matte white/Matte black Blanco mate/Negro mate	598	612	75	21	0,22





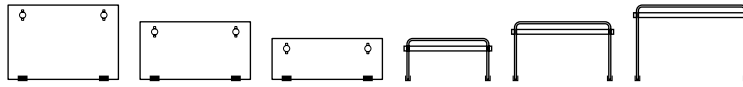

**Description**  
**Descripción**

Oak occasional table available in 3 different heights and sizes. Aluminum stoppers in black finish.  
Mesa ocasional de roble disponible en 3 alturas y medidas diferentes. Tacos de aluminio en acabado negro.

**Wood finish Oak**  
**Acabado madera**  
**Roble**



**Wood lacquer finish**  
**Acabado lacas madera**



**Intellectual property Propiedad intelectual**

All our collections are protected by international industrial design registries, designs patents, copyrights and intellectual Property laws. Unauthorized use of AW International Property is a criminal offence and can lead to prosecution.  
Todas nuestras colecciones están protegidas por registros de diseño industrial, diseño de patente, copyright y derechos de propiedad intelectual en todo el mundo. El uso no autorizado de los diseños y propiedad intelectual de AW supone un delito que puede ser sometido a acción judicial.



Occasional Table.  
Mesa auxiliar.

**ME2692**

703

0'11 m<sup>3</sup>  
8'23 kg  
x1  
1 boxes bultos

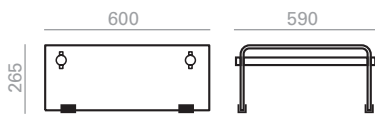

Occasional Table.  
Mesa auxiliar.

**ME2691**

805

0'2 m<sup>3</sup>  
10'81 kg  
x1  
1 boxes bultos

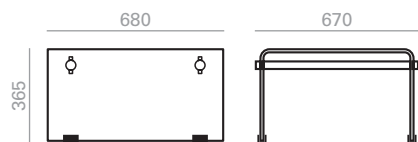

Occasional Table.  
Mesa auxiliar.

**ME2690**

984

0'3 m<sup>3</sup>  
13'32 kg  
x1  
1 boxes bultos

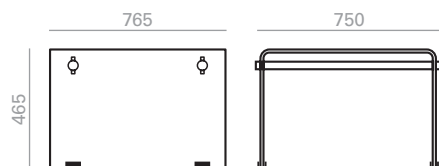

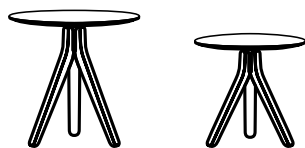

**Description**  
**Descripción**

Occasional table available with central base in ash wood. Round table tops available in different sizes and finished in oak, marble, lacquered, Solid Surface or Technical Stone. Available in 2 heights.

Mesa auxiliar disponible con bases centrales en madera de fresno. Sobres de mesa redondos disponibles en diferentes medidas y acabado roble, lacado, Solid Surface, mármol, Compacto HPL o Technical Stone. Disponible en 2 alturas.

**Wood finish Ash**  
**Acabado madera Fresno**



**Wood lacquer finish**  
**Acabado lacas madera**

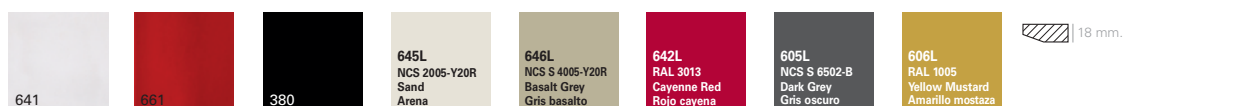

**Compacto HPL finish**  
**Acabado Compacto HPL**

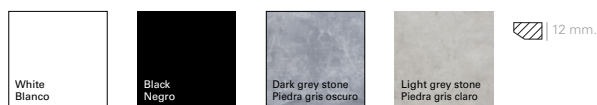

**Solid Surface finish**  
**Acabado Solid Surface**

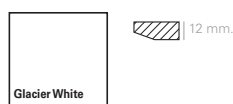

**Technical Stone decorative finish**  
**Acabado Technical Stone**

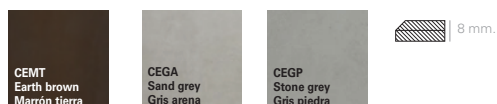

**M1 marble finish**  
**Acabado de mármol M1**

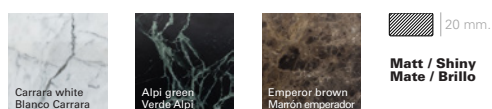

**M2 marble finish**  
**Acabado de mármol M2**

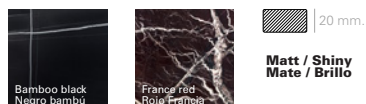

**Intellectual property Propiedad intelectual**

All our collections are protected by international industrial design registries, designs patents, copyrights and intellectual Property laws. Unauthorized use of AW International Property is a criminal offence and can lead to prosecution.  
Todas nuestras colecciones están protegidas por registros de diseño industrial, diseño de patente, copyright y derechos de propiedad intelectual todo el mundo. El uso no autorizado de los diseños y propiedad intelectual de AW supone un delito que puede ser sometido a acción judicial.





\*\*\*Marble shiny upcharge  
Incremento por mármol brillo

30

SERIE 600

\*Matte lacquered and premium upcharge  
\*Incremento por lacado mate y premium

105

Column height / Altura columna 450														
Top measures Medidas sobre	Table top / Sobre													
	Lacquered Lacado		Oak Roble		Solid Surface Solid Surface		***Marble M1 Mármol M1		***Marble M2 Mármol M2		Compacto HPL Compacto HPL		Technical Stone	
	Ref.	€	Ref.	€	Ref.	€	Ref.	€	Ref.	€	Ref.	€	Ref.	€
ø450	ME2872	442	ME2873	492	ME2874	546	ME2875	718	ME2876	786	ME2877	437	ME2878	543
kg	6'1		4		6'1		11		11		6'1		6'1	
1 box / bulto  m3	0,13		0,13		0,13		0,13		0'13		0'13		0'13	

Column height / Altura columna 550														
Top measures Medidas sobre	Table top / Sobre													
	Lacquered Lacado		Oak Roble		Solid Surface Solid Surface		***Marble M1 Mármol M1		***Marble M2 Mármol M2		Compacto HPL Compacto HPL		Technical Stone	
	Ref.	€	Ref.	€	Ref.	€	Ref.	€	Ref.	€	Ref.	€	Ref.	€
ø550	ME2879	470	ME2880	536	ME2881	718	ME2882	780	ME2883	947	ME2884	481	ME2885	663
kg	8'5		8'5		8'5		13'2		13'2		8'5		8'5	
1 box / bulto  m3	0,23		0,23		0,23		0,23		0'23		0'23		0'23	

Maximum table heights  
Alturas máximas de mesa

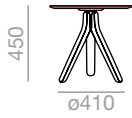

Table top					
Lacquered Lacado	Oak Roble	Solid Surface Solid Surface	***Marble M1 Mármol M1	***Marble M2 Mármol M2	Compacto HPL Compacto HPL
447	447	441	449	449	441

Maximum table heights  
Alturas máximas de mesa



Table top					
Lacquered Lacado	Oak Roble	Solid Surface Solid Surface	***Marble M1 Mármol M1	***Marble M2 Mármol M2	Compacto HPL Compacto HPL
547	547	541	549	549	541



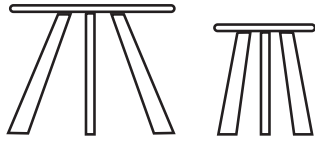

**Description** Occasional table made in solid oak wood or lacquered  
**Descripción** Mesa auxiliar en madera maciza de roble o lacada.

**Wood finish Oak**  
**Acabado madera**  
**Roble**



**Wood lacquer finish**  
**Acabado lacas madera**

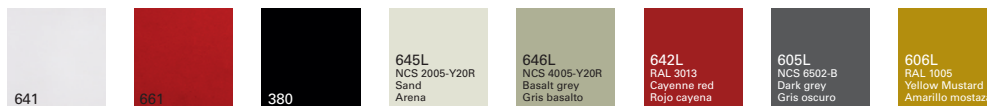

**Intellectual property Propiedad intelectual**

All our collections are protected by international industrial design registries, designs patents, copyrights and intellectual Property laws. Unauthorized use of AW International Property is a criminal offence and can lead to prosecution.  
 Todas nuestras colecciones están protegidas por registros de diseño industrial, diseño de patente, copyright y derechos de propiedad intelectual en todo el mundo. El uso no autorizado de los diseños y propiedad intelectual de AW supone un delito que puede ser sometido a acción judicial.



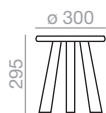

Auxiliary table ø300.  
Mesa auxiliar ø300.

**ME0564**  
**Oak Roble**

305

0'04 m3  
 6 kg  
 x1  
1 boxes bultos

**ME0562**  
**Lacquered Lacado**

228



Incremento por Lacado  
Mate y Premium  
Matt Lacquered and  
Premium Upcharge

| 36 |

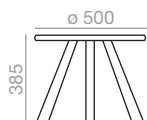

Auxiliary table ø500.  
Mesa auxiliar ø500.

**ME0565**  
**Oak Roble**

397

0'11 m3  
 9 kg  
 x1  
1 boxes bultos

**ME0563**  
**Lacquered Lacado**

253



Incremento por Lacado  
Mate y Premium  
Matt Lacquered and  
Premium Upcharge

| 45 |





**Description**

Occasional table with a 3-foot solid ash wood base, available in 2 heights and sizes, and an oak wood top.

**Descripción**

Mesa auxiliar con base de 3 pies de madera maciza de fresno, disponible en 2 alturas y tamaños, y sobre de madera de roble.

**Wood finish Ash  
Acabado madera  
Fresno**



**Wood finish Oak  
Acabado madera  
Roble**



**Wood lacquer finish  
Acabado lacas madera**



**Intellectual property Propiedad intelectual**

All our collections are protected by international industrial design registries, designs patents, copyrights and intellectual Property laws. Unauthorized use of AW International Property is a criminal offence and can lead to prosecution.  
Todas nuestras colecciones están protegidas por registros de diseño industrial, diseño de patente, copyright y derechos de propiedad intelectual en todo el mundo. El uso no autorizado de los diseños y propiedad intelectual de AW supone un delito que puede ser sometido a acción judicial.

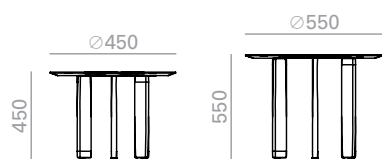

SERIE 600	<p>*Matte lacquered and premium upcharge</p> <p>*Incremento por lacado mate y premium</p>	120
--------------	---	-----

Top / Sobre	Top measures / Medidas sobre			
	Ø450		Ø550	
	Ref.	€	Ref.	€
Oak / Roble	ME6551	579	ME6552	604
kg	10'5		12'87	
1 box / bulto  m3	0,1		0,17	



**Description**  
**Descripción**

Table with 4 aluminum legs and injected aluminum column, available in 2 heights. Available finishes include polished aluminum, matte white and black and plywood tops in different shapes and sizes in oak, lacquer, Technical Stone, HPL, Carrara marble and b  
Mesa con base de 4 aspas de aluminio y columna de inyección de aluminio, disponible en 2 alturas. Disponible en acabados aluminio pulido, blanco mate o negro mate y sobres de tablero de diferentes formas y medidas en acabado roble, lacado, Technical Stone

**Wood finish Oak**  
**Acabado madera Roble**



**Wood lacquer finish**  
**Acabado lacas madera**



**Compacto HPL finish**  
**Acabado Compacto HPL**

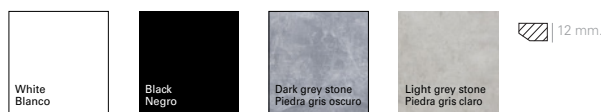

**Solid Surface finish**  
**Acabado Solid Surface**

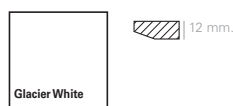

**Technical Stone decorative finish**  
**Acabado Technical Stone**

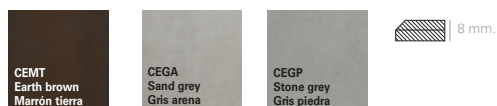

**M1 marble finish**  
**Acabado de mármol M1**

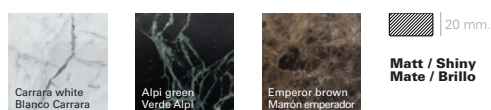

**M2 marble finish**  
**Acabado de mármol M2**

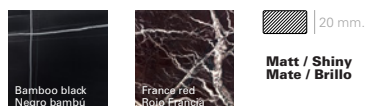

**Aluminum finish**  
**Acabado aluminio**



**Certificates**  
**Certificados**

Quality - Resistance      UNE CEN/TR 581-4      Durability of exterior-grade furniture.  
Calidad - Resistencia      Durabilidad de mobiliario de exterior.

**Intellectual property Propiedad intelectual**

All our collections are protected by international industrial design registries, designs patents, copyrights and intellectual Property laws. Unauthorized use of AW International Property is a criminal offence and can lead to prosecution.  
Todas nuestras colecciones están protegidas por registros de diseño industrial, diseño de patente, copyright y derechos de propiedad intelectual todo el mundo. El uso no autorizado de los diseños y propiedad intelectual de AW supone un delito que puede ser sometido a acción judicial.



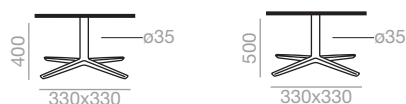

\*\*\*Marble shiny upcharge  
Incremento por mármol brillo

SERIE 600

\*Matte lacquered and premium upcharge  
\*Incremento por lacado mate y premium

30

60

Column height / Altura columna 400															
Top measures Medidas sobre	Aluminium finish Acabado de Aluminio	Table top / Sobre													
		Lacquered Lacado		Oak Roble		Solid Surface Solid Surface		***Marble M1 Mármol M1		***Marble M2 Mármol M2		Compacto HPL Compacto HPL		Technical Stone	
		Ref.	€	Ref.	€	Ref.	€	Ref.	€	Ref.	€	Ref.	€	Ref.	€
450x450	Matte Mate	ME6700	333	ME6718	382	ME6736	402	ME6754	449	ME6913	549	ME6772	297	ME6883	357
	Polished aluminum Aluminio Pulido	ME6702	378	ME6720	424	ME6738	471	ME6756	518	ME6914	577	ME6774	351	ME6885	404
<b>kg</b>		9		9		11		18		18		10		16	
<b>1 box / bulto</b> <b>m3</b>		0,11		0,11		0,11		0,11		0'11		0'11		0'11	

500x500	Matte Mate	ME6703	338	ME6721	389	ME6739	414	ME6757	641	ME6915	754	ME6777	301	ME6888	568
	Polished aluminum Aluminio Pulido	ME6705	387	ME6723	432	ME6741	471	ME6759	698	ME6916	812	ME6779	358	ME6890	614
<b>kg</b>		9		9		10		16		16		10		15	
<b>1 box / bulto</b> <b>m3</b>		0,13		0,13		0,13		0,13		0'13		0'13		0'13	

ø500	Matte Mate	ME6706	345	ME6724	389	ME6742	496	ME6760	646	ME6917	760	ME6782	310	ME6893	568
	Polished aluminum Aluminio Pulido	ME6708	387	ME6726	450	ME6744	546	ME6762	703	ME6918	816	ME6784	368	ME6895	614
<b>kg</b>		9		9		11		17		17		10		16	
<b>1 box / bulto</b> <b>m3</b>		0,13		0,13		0,13		0,13		0'18		0'13		0'13	

Column height / Altura columna 500															
Top measures Medidas sobre	Aluminium finish Acabado de Aluminio	Table top / Sobre													
		Lacquered Lacado		Oak Roble		Solid Surface Solid Surface		***Marble M1 Mármol M1		***Marble M2 Mármol M2		Compacto HPL Compacto HPL		Technical Stone	
		Ref.	€	Ref.	€	Ref.	€	Ref.	€	Ref.	€	Ref.	€	Ref.	€
450x450	Matte Mate	ME6709	334	ME6727	387	ME6745	409	ME6763	450	ME6919	551	ME6787	301	ME6898	360
	Polished aluminum Aluminio Pulido	ME6711	395	ME6729	448	ME6747	471	ME6765	518	ME6920	580	ME6789	363	ME6900	407
<b>kg</b>		10		10		11		18		301		10		16	
<b>1 box / bulto</b> <b>m3</b>		0,13		0,13		0,13		0,13		0'13		0'13		0'13	

500x500	Matte Mate	ME6712	339	ME6730	393	ME6748	418	ME6766	644	ME6921	758	ME6792	308	ME6903	571
	Polished aluminum Aluminio Pulido	ME6714	408	ME6732	456	ME6750	480	ME6768	706	ME6922	820	ME6794	368	ME6905	617
<b>kg</b>		9		9		11		16		301		10		15	
<b>1 box / bulto</b> <b>m3</b>		0,16		0,16		0,16		0,16		0'16		0'16		0'16	

ø500	Matte Mate	ME6715	343	ME6733	395	ME6751	496	ME6769	651	ME6923	764	ME6797	315	ME6908	571
	Polished aluminum Aluminio Pulido	ME6717	408	ME6735	456	ME6753	562	ME6771	714	ME6924	827	ME6799	377	ME6910	617
<b>kg</b>		10		10		11		18		301		10		16	
<b>1 box / bulto</b> <b>m3</b>		0,16		0,16		0,16		0,16		0'16		0'16		0'16	

Maximum table heights  
Alturas máximas de mesa



Table top					
Lacquered Lacado	Oak Roble	Solid Surface Solid Surface	***Marble M1 Mármol M1	***Marble M2 Mármol M2	Compacto HPL Compacto HPL
418	418	412	420	420	412

Maximum table heights  
Alturas máximas de mesa

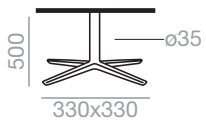
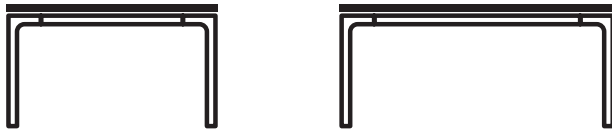

Table top					
Lacquered Lacado	Oak Roble	Solid Surface Solid Surface	***Marble M1 Mármol M1	***Marble M2 Mármol M2	Compacto HPL Compacto HPL
518	518	512	520	520	512





**Description**  
**Descripción**

Table with 4 injected aluminum legs, available in 2 heights. Available finishes include polished aluminum, matte white and black and plywood tops in different shapes and sizes in oak, lacquer, Technical Stone, HPL, Carrara marble and black marble bamboo.  
Mesa con base de 4 patas de inyección de aluminio, disponible en 2 alturas. Disponible en acabados aluminio pulido, blanco mate o negro mate y sobres de tablero de diferentes formas y medidas en acabado roble, lacado, Technical Stone, Compacto HP, mármol Carrara y mármol negro bambú.

**Wood finish Oak**  
**Acabado madera Roble**



**Wood lacquer finish**  
**Acabado lacas madera**



**Compacto HPL finish**  
**Acabado Compacto HPL**

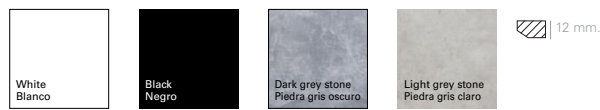

**Solid Surface finish**  
**Acabado Solid Surface**

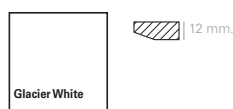

**Technical Stone decorative finish**  
**Acabado Technical Stone**

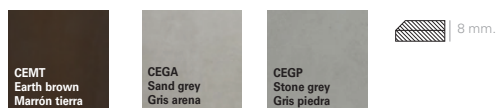

**M1 marble finish**  
**Acabado de mármol M1**

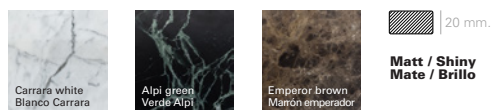

**M2 marble finish**  
**Acabado de mármol M2**

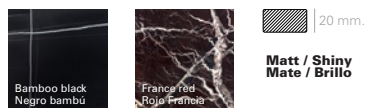

**Aluminum finish**  
**Acabado aluminio**



**Certificates**  
**Certificados**

Quality - Resistance  
Calidad - Resistencia

UNE CEN/TR 581-4

Durability of exterior-grade furniture.  
Durabilidad de mobiliario de exterior.

**Intellectual property Propiedad intelectual**

All our collections are protected by international industrial design registries, designs patents, copyrights and intellectual Property laws. Unauthorized use of AW International Property is a criminal offence and can lead to prosecution.  
Todas nuestras colecciones están protegidas por registros de diseño industrial, diseño de patente, copyright y derechos de propiedad intelectual todo el mundo. El uso no autorizado de los diseños y propiedad intelectual de AW supone un delito que puede ser sometido a acción judicial.



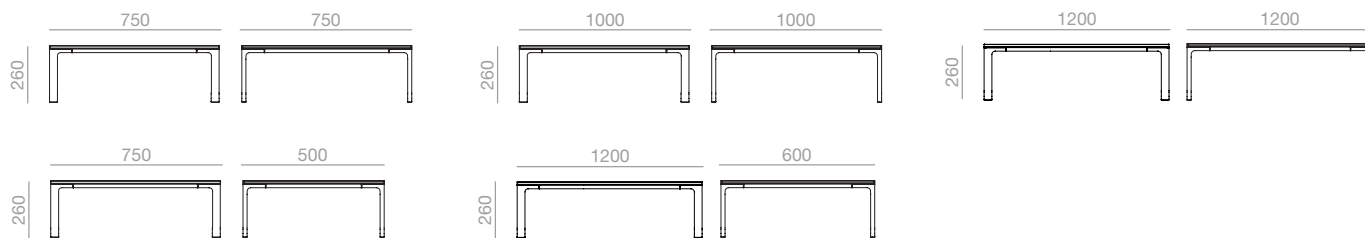

Table height / Altura de mesa 260

Top measures Medidas sobre	Aluminium finish Acabado de Aluminio	Table top / Sobre													
		Lacquered Lacado		Oak Roble		Solid Surface Solid Surface		***Marble M1 Mármol M1		***Marble M2 Mármol M2		Compacto HPL Compacto HPL		Technical Stone	
		Ref.	€	Ref.	€	Ref.	€	Ref.	€	Ref.	€	Ref.	€	Ref.	€
750x750	Matte Mate	ME8512	734	ME8548	811	ME8584	1.069	ME8620	1.084	ME8950	1.269	ME8664	771	ME8760	892
	Polished aliminum Aluminio pulido	ME8514	859	ME8550	936	ME8586	1.193	ME8622	1.214	ME8951	1.324	ME8666	895	ME8762	947
kg		19		19		30		41		41		26		41	
1 box / bulto  m3		0,16		0,16		0,16		0,5		0'5		0'16		0'5	
1000x1000	Matte Mate	ME8970	1.017	ME8972	1.179	ME8974	1.838	ME8976	1.731	ME8978	2.349	ME8980	998	ME8982	1.031
	Polished aliminum Aluminio pulido	ME8971	1.204	ME8973	1.371	ME8975	2.024	ME8977	1.917	ME8979	2.547	ME8981	1.187	ME8983	1.219
kg		23		23		23		23		23		23		23	
1 box / bulto  m3		0,66		0,66		0,66		0,81		0'81		0'66		0'81	
1200x1200	Matte Mate	ME8515	1.065	ME8551	1.244	ME8587	1.910	ME8623	1.866	ME8952	2.519	ME8669	1.124		
	Polished aliminum Aluminio pulido	ME8517	1.273	ME8553	1.451	ME8589	2.116	ME8625	1.957	ME8953	2.611	ME8671	1.330		
kg		24		24		41		58		58		35			
1 box / bulto  m3		0,41		0,41		0,41		1,1		1'1		0'41			
750x500	Matte Mate	ME8518	681	ME8554	738	ME8590	865	ME8626	964	ME8954	1.113	ME8674	688	ME8765	798
	Polished aliminum Aluminio pulido	ME8520	797	ME8556	856	ME8592	977	ME8628	1.082	ME8955	1.187	ME8676	803	ME8767	850
kg		17		17		24		31		79		22		23	
1 box / bulto  m3		0,11		0,11		0,11		0,37		0'37		0'11		0'37	
1200x600	Matte Mate	ME8521	810	ME8557	897	ME8593	1.263	ME8629	1.265	ME8956	1.591	ME8679	829	ME8770	1.102
	Polished aliminum Aluminio pulido	ME8523	969	ME8559	1.102	ME8595	1.421	ME8631	1.367	ME8957	1.666	ME8681	987	ME8772	1.176
kg		21		21		35		49		79		30		31	
1 box / bulto  m3		0,21		0,21		0,21		0,63		0'63		0'21		0'63	

\*\*\*Marble shiny upcharge  
Incremento por mármol brillo

| 30 |



\*\*Upcharge CRB.  
\*\*Incremento por CRB.

| 132 |



\*Matte lacquered and premium upcharge  
\*Incremento por lacado mate y premium

| 132 |



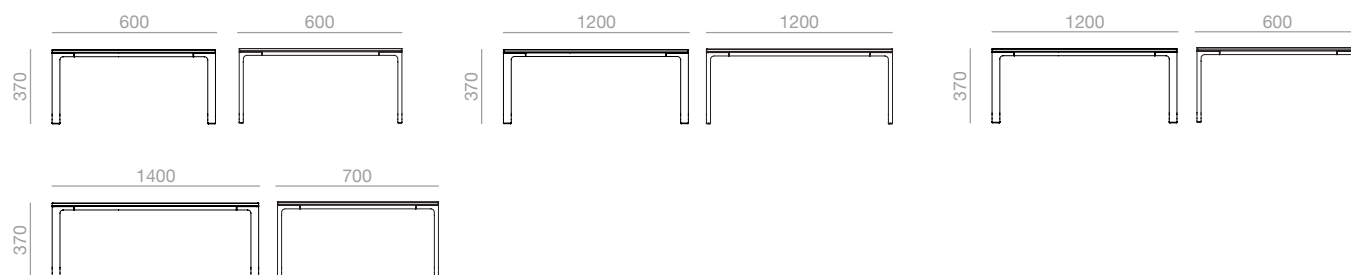

**Table height / Altura de mesa 370**

Top measures Medidas sobre	Aluminium finish Acabado de Aluminio	Table top / Sobre													
		Lacquered Lacado		Oak Roble		Solid Surface Solid Surface		***Marble M1 Mármol M1		***Marble M2 Mármol M2		Compacto HPL Compacto HPL		Technical Stone	
		Ref.	€	Ref.	€	Ref.	€	Ref.	€	Ref.	€	Ref.	€	Ref.	€
600x600	Matte Mate	ME8524	686	ME8560	728	ME8596	902	ME8632	948	ME8958	1.112	ME8684	655	ME8795	824
	Polished aliminum Aluminio pulido	ME8526	795	ME8562	837	ME8598	1.008	ME8634	991	ME8959	1.151	ME8686	761	ME8797	869
<b>kg</b>		18		18		25		31		31		22		49	
<b>1 box / bulto</b> <b>m3</b>		0,15		0,15		0,15		0,43		0'43		0'15		0'43	
1200x1200	Matte Mate	ME8527	1.082	ME8563	1.257	ME8599	1.924	ME8635	1.884	ME8960	2.538	ME8689	1.136		
	Polished aliminum Aluminio pulido	ME8529	1.284	ME8565	1.462	ME8601	2.126	ME8637	1.969	ME8961	2.623	ME8691	1.339		
<b>kg</b>		32		31		60		87		79		50			
<b>1 box / bulto</b> <b>m3</b>		0,59		0,59		0,59		1,31		1'31		0'59			
1200x600	Matte Mate	ME8530	825	ME8566	912	ME8602	1.179	ME8638	1.285	ME8962	1.610	ME8694	842	ME8800	1.120
	Polished aliminum Aluminio pulido	ME8532	979	ME8568	1.068	ME8604	1.335	ME8640	1.379	ME8963	1.677	ME8696	999	ME8802	1.190
<b>kg</b>		22		22		36		50		50		31		87	
<b>1 box / bulto</b> <b>m3</b>		0,29		0,29		0,29		0,75		0'75		0'29		0'75	
1400x700	Matte Mate	ME8533	926	ME8569	1.080	ME8605	1.468	ME8641	1.495	ME8964	1.869	ME8699	975	ME8805	1.183
	Polished aliminum Aluminio pulido	ME8535	1.116	ME8571	1.270	ME8607	1.657	ME8643	1.599	ME8965	1.947	ME8701	1.166	ME8807	1.342
<b>kg</b>		26		26		45		63		63		38		50	
<b>1 box / bulto</b> <b>m3</b>		0,4		0,4		0,4		0,96		0'96		0'4		0'96	

\*\*\*Marble shiny upcharge  
Incremento por mármol brillo

| 30 |



\*\*Upcharge CRB.  
\*\*Incremento por CRB.

| 132 |

SERIE  
600

\*Matte lacquered and premium upcharge  
\*Incremento por lacado mate y premium

| 132 |

Maximum table heights  
Alturas máximas de mesa

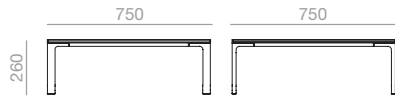
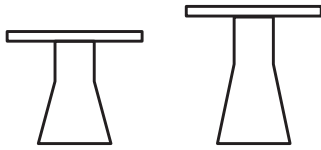

Table top					
Lacquered Lacado	Oak Roble	Solid Surface Solid Surface	***Marble M1 Mármol M1	***Marble M2 Mármol M2	Compacto HPL Compacto HPL
258	258	252	260	260	252

Maximum table heights  
Alturas máximas de mesa



Table top					
Lacquered Lacado	Oak Roble	Solid Surface Solid Surface	***Marble M1 Mármol M1	***Marble M2 Mármol M2	Compacto HPL Compacto HPL
368	368	362	370	370	362



**Description**  
**Descripción**

Occasional table with Pure Eco thermo-polymer (100% recycled) available in several colors. Table tops in several shapes and sizes available in various finishes.

Mesa auxiliar con base central de termopolímero Pure Eco (100% reciclado) disponible en diferentes colores. Sobres de tablero de diferentes formas y medidas disponibles en diferentes acabados.

**Wood finish Oak**  
**Acabado madera Roble**



**Wood lacquer finish**  
**Acabado lacas madera**



**Compacto HPL finish**  
**Acabado Compacto HPL**

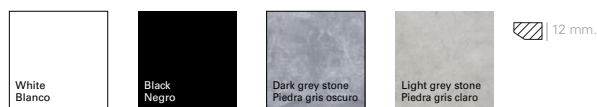

**Solid Surface finish**  
**Acabado Solid Surface**

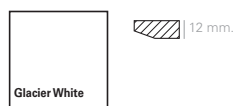

**Technical Stone decorative finish**  
**Acabado Technical Stone**

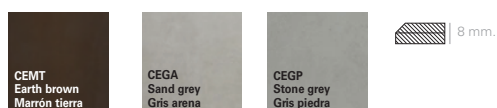

**M1 marble finish**  
**Acabado de mármol M1**

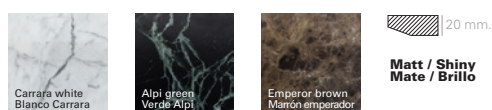

**M2 marble finish**  
**Acabado de mármol M2**

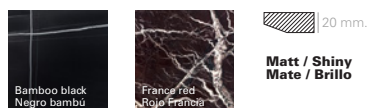

**Pure Eco Thermo-polymer finish**  
**Acabado de Termo-polímero Pure Eco**

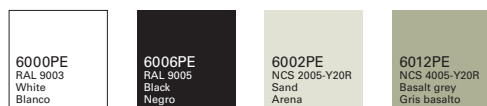

**Certificates**  
**Certificados**

Quality - Resistence / Calidad - Resistencia      UNE CEN/TR 581-4      Durability of exterior-grade furniture. / Durabilidad de mobiliario de exterior.

**Intellectual property Propiedad intelectual**

All our collections are protected by international industrial design registries, designs patents, copyrights and intellectual Property laws. Unauthorized use of AW International Property is a criminal offence and can lead to prosecution. Todas nuestras colecciones están protegidas por registros de diseño industrial, diseño de patente, copyright y derechos de propiedad intelectual todo el mundo. El uso no autorizado de los diseños y propiedad intelectual de AW supone un delito que puede ser sometido a acción judicial.



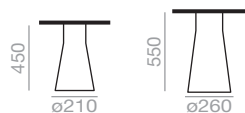

\*\*\*Marble shiny upcharge  
Incremento por mármol brillo

30



Incremento por base laca brillo

Upcharge for bright lacquered finish bases.

240

Amount of sand: 9,75 kg.  
Cantidad de arena 9,75 kg.

Column height / Altura columna 450															
Top measures Medidas sobre	Table top / Sobre														
	Oak Roble		s600	Lacquered Lacado		Solid Surface Solid Surface		***Marble M1 Mármol M1		***Marble M2 Mármol M2		Compacto HPL Compacto HPL		Technical Stone	
	Ref.	€	€	Ref.	€	Ref.	€	Ref.	€	Ref.	€	Ref.	€	Ref.	€
400x400	ME5101	356	57	ME5100	320	ME5102	422	ME5103	456	ME5380	539	ME5104	292	ME5137	362
kg	14			16		14		14		21'6		17		16	
1 box/ bulto  m3	0,1			0,1		0,1		0,1		0'1		0'1		0'1	
ellipse/ elipse 450x450	ME5106	374	57	ME5105	322	ME5107	423	ME5108	602	ME5381	693	ME5109	297	ME5138	515
kg	14			14		14		14		24'3		14		17	
1 box/ bulto  m3	0,12			0,12		0,12		0,12		0'1		0'12		0'12	
ø450	ME5111	378	57	ME5110	327	ME5112	429	ME5113	602	ME5382	690	ME5114	299	ME5139	515
kg	14			14		14		21'6		21'6		14		17	
1 box/ bulto  m3	0,12			0,12		0,12		0,12		0'1		0'12		0'12	

Column height / Altura columna 450				
Top measures Medidas sobre	Top & Base			
	***Marble M1 Mármol M1		Cement Cemento	
	Ref.	€	Ref.	€
400x400	ME5480	2.216	ME5460	578
kg	37		12	
1 box/ bulto  m3	0,1		0'1	
ellipse/ elipse 450x450	ME5481	2.371	ME5461	581
kg	40		12	
1 box/ bulto  m3	0,12		0'1	
ø450	ME5482	2.371	ME5462	584
kg	37		12	
1 box/ bulto  m3	0,12		0'1	

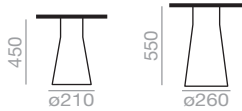

\*\*\*Marble shiny upcharge  
Incremento por mármol brillo

30

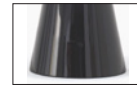

Incremento por base laca brillo  
Upcharge for bright lacquered finish bases.

240

Amount of sand: 17,80 kg.  
Cantidad de arena 17,80 kg.

Column height / Altura columna 550															
Top measures Medidas sobre	Table top / Sobre														
	Oak Roble		s600	Lacquered Lacado		Solid Surface Solid Surface		***Marble M1 Mármol M1		***Marble M2 Mármol M2		Compacto HPL Compacto HPL		Technical Stone	
	Ref.	€	€	Ref.	€	Ref.	€	Ref.	€	Ref.	€	Ref.	€	Ref.	€
500x500	ME5116	395	57	ME5115	340	ME5117	582	ME5118	564	ME5383	617	ME5119	324	ME5140	375
kg	18			16		18		18		94		18		25	
1 box/ bulto  m3	0,17			0,17		0,17		0,17		0'17		0'17		0'17	
ellipse/ elipse 550x550	ME5121	409	57	ME5120	343	ME5122	627	ME5123	715	ME5384	843	ME5124	335	ME5141	542
kg	18			18		18		18		94		18		26	
1 box/ bulto  m3	0,21			0,21		0,21		0,21		0'17		0'21		0'21	
ø550	ME5126	416	63	ME5125	352	ME5127	629	ME5128	715	ME5385	843	ME5129	339	ME5142	542
kg	24			18		18		18		18		18		25	
1 box/ bulto  m3	0,21			0,21		0,21		0,21		0'17		0'21		0'21	

Column height / Altura columna 550				
Top measures Medidas sobre	Top & Base			
	***Marble M1 Mármol M1		Cement Cemento	
	Ref.	€	Ref.	€
500x500	ME5483	3.194	ME5463	603
kg	60		16	
1 box/ bulto  m3	0,17		0'17	
ellipse/ elipse 550x550	ME5484	3.400	ME5464	611
kg	63		16	
1 box/ bulto  m3	0,21		0'17	
ø550	ME5485	3.400	ME5465	616
kg	59		16	
1 box/ bulto  m3	0,21		0'17	

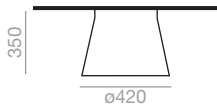

\*\*\*Marble shiny upcharge  
Incremento por mármol brillo

30

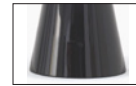

Incremento por base laca brillo  
Upcharge for bright lacquered finish bases.

240

Amount of sand: 35 kg.  
Cantidad de arena 35 kg.

Column height / Altura columna 350															
Top measures Medidas sobre	Table top / Sobre														
	Oak Roble		s600	Lacquered Lacado		Solid Surface Solid Surface		***Marble M1 Mármol M1		***Marble M2 Mármol M2		Compacto HPL Compacto HPL		Technical Stone	
	Ref.	€	€	Ref.	€	Ref.	€	Ref.	€	Ref.	€	Ref.	€	Ref.	€
800x800	ME5311	602	126	ME5310	522	ME5312	786	ME5313	1.121	ME5386	1.387	ME5314	470	ME5315	895
kg	44			44		50		71		94		47		46	
1 box/ bulto  m3	0,15			0,15		0,15		0,37		0'37		0'15		0'17	

900x900	ME5332	717	126	ME5331	578	ME5333	788	ME5334	1.176	ME5387	1.545	ME5335	510	ME5336	920
kg	46			46		53		80		94		50		49	
1 box/ bulto  m3	0,17			0,17		0,17		0,44		0'44		0'17		0'19	

1000x1000	ME5351	766	126	ME5350	603
kg	49			49	
1 box/ bulto  m3	0,19			0,19	

ME5352	1.396	ME5388	1.853	ME5353	567	ME5354	966
91		94		53		52	
0,5		0'5		0'19		0'22	

1100x1100	ME5367	797	126	ME5366	653
kg	51			51	
1 box/ bulto  m3	0,22			0,22	

ME5368	1.569	ME5389	2.122	ME5369	684
102		94		56	
0,58		0'58		0'22	

Column height / Altura columna 350				
Top measures Medidas sobre	Top & Base			
	***Marble M1 Mármol M1		Cement Cemento	
	Ref.	€	Ref.	€
800x800	ME5630	4.249	ME5466	960
kg	134		40	
1 box/ bulto  m3	0,37		0'15	

900x900	ME5631	4.303	ME5467	1.032
kg	144		40	
1 box/ bulto  m3	0,44		0'17	

1000x1000	ME5632	4.522	ME5468	1.092
kg	156		43	
1 box/ bulto  m3	0,5		0'19	

1100x1100	ME5633	4.468	ME5469	1.167
kg	169		46	
1 box/ bulto  m3	0,58		0'22	

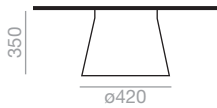

\*\*\*Marble shiny upcharge  
Incremento por mármol brillo

30



Incremento por base laca brillo  
Upcharge for bright lacquered finish bases.

240

Amount of sand: 35 kg.  
Cantidad de arena 35 kg.

Column height / Altura columna 350															
Top measures Medidas sobre	Table top / Sobre														
	Oak Roble		s600	Lacquered Lacado		Solid Surface Solid Surface		***Marble M1 Mármol M1		***Marble M2 Mármol M2		Compacto HPL Compacto HPL		Technical Stone	
	Ref.	€	€	Ref.	€	Ref.	€	Ref.	€	Ref.	€	Ref.	€	Ref.	€
ellipse/ elipse 900x900	ME5318	715	126	ME5317	571	ME5319	788	ME5320	1.433	ME5390	1.801	ME5321	504	ME5322	994
kg	46		46		53		80		94		50		49		
1 box/ bulto  m3	0,17		0,17		0,17		0,44		0'44		0'17		0'19		

ellipse/ elipse 1000x1000	ME5339	765	126	ME5338	593
kg	49		49		
1 box/ bulto  m3	0,19		0,19		

ME5340	1.591	ME5391	2.046	ME5341	565	ME5342	1.026
91		108		53		52	
0,5		0'5		0'19		0'22	

ellipse/ elipse 1100x1100	ME5357	796	126	ME5356	647
kg	51		51		
1 box/ bulto  m3	0,22		0,22		

ME5358	1.764	ME5392	2.314	ME5359	679
102		108		56	
0,58		0'58		0'22	

ellipse/ elipse 1200x1200	ME5371	822	126	ME5370	690
kg	54		54		
1 box/ bulto  m3	0,24		0,24		

ME5372	2.023	ME5393	2.678	ME5373	684
114		108		60	
0,66		0'66		0'24	

Column height / Altura columna 350				
Top measures Medidas sobre	Top & Base			
	***Marble M1 Mármol M1		Cement Cemento	
	Ref.	€	Ref.	€
ellipse/ elipse 900x900	ME5634	4.555	ME5470	1.029
kg	144		39	
1 box/ bulto  m3	0,44		0'17	

ellipse/ elipse 1000x1000	ME5635	4.714	ME5471	1.070
kg	156		41	
1 box/ bulto  m3	0,5		0'19	

ellipse/ elipse 1100x1100	ME5636	4.794	ME5472	1.159
kg	169		44	
1 box/ bulto  m3	0,58		0'22	

ellipse/ elipse 1200x1200	ME5637	5.048	ME5473	1.237
kg	183		46	
1 box/ bulto  m3	0,66		0'24	

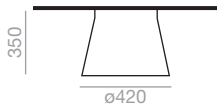

\*\*\*Marble shiny upcharge  
Incremento por mármol brillo

30



Incremento por base laca brillo  
Upcharge for bright lacquered finish bases.

240

Amount of sand: 35 kg.  
Cantidad de arena 35 kg.

Column height / Altura columna 350															
Top measures Medidas sobre	Table top / Sobre														
	Oak Roble		s600	Lacquered Lacado		Solid Surface Solid Surface		***Marble M1 Mármol M1		***Marble M2 Mármol M2		Compacto HPL Compacto HPL		Technical Stone	
	Ref.	€	€	Ref.	€	Ref.	€	Ref.	€	Ref.	€	Ref.	€	Ref.	€
ø900	ME5325	715	126	ME5324	571	ME5326	788	ME5327	1.433	ME5394	1.801	ME5328	504	ME5329	1.008
kg	46		46		53		80		108		50		49		
2 boxes/ bultos  m3	0,17		0,17		0,17		0,44		0'44		0'17		0'44		

ø1000	ME5345	765	126	ME5344	593
kg	49		49		
2 boxes/ bultos  m3	0,19		0,19		

ME5346	1.591	ME5395	2.046	ME5347	565	ME5348	1.026
91		108		53		52	
0,5		0'5		0'19		0'5	

ø1100	ME5362	796	126	ME5361	647
kg	51		51		
2 boxes/ bultos  m3	0,22		0,22		

ME5363	1.764	ME5396	2.314	ME5364	679
102		108		56	
0,58		0'58		0'22	

ø1200	ME5375	819	126	ME5374	689
kg	54		54		
2 boxes/ bultos  m3	0,24		0,24		

ME5376	2.023	ME5397	2.678	ME5377	686
114		108		60	
0,66		0'66		0'24	

Column height / Altura columna 350				
Top measures Medidas sobre	Top & Base			
	***Marble M1 Mármol M1		Cement Cemento	
	Ref.	€	Ref.	€
ø900	ME5638	4.555	ME5474	1.029
kg	133		38	
2 boxes/ bultos  m3	0,44		0'17	

ø1000	ME5639	4.714	ME5475	1.070
kg	142		40	
2 boxes/ bultos  m3	0,5		0'19	

ø1100	ME5640	4.794	ME5476	1.159
kg	153		42	
2 boxes/ bultos  m3	0,58		0'28	

ø1200	ME5641	5.048	ME5477	1.237
kg	164		45	
2 boxes/ bultos  m3	0,66		0'24	



Maximum table heights  
Alturas máximas de mesa

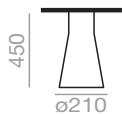

Table top					
Oak Roble	Lacquered Lacado	Solid Surface Solid Surface	***Marble M1 Mármol M1	***Marble M2 Mármol M2	Compacto HPL Compacto HPL
462	462	456	464	464	456

Maximum table heights  
Alturas máximas de mesa

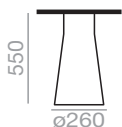

Table top					
Oak Roble	Lacquered Lacado	Solid Surface Solid Surface	***Marble M1 Mármol M1	***Marble M2 Mármol M2	Compacto HPL Compacto HPL
560	560	554	562	562	554

Maximum table heights  
 Alturas máximas de mesa

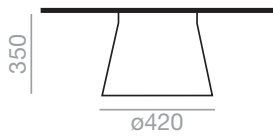

Table top					
Oak Roble	Lacquered Lacado	Solid Surface Solid Surface	***Marble M1 Mármol M1	***Marble M2 Mármol M2	Compacto HPL Compacto HPL
350	350	344	364	364	344

**PS-UNDERTOP**

**Preinstalled (Optional) / Preinstalación (Opcional)**



**PS0786**

326

**IN0007**

62

**UNDER-TOP POWER BOXES  
CAJA DE CONEXIONES BAJO EL SOBRE**

Power box mounted under the table top, available for any Reverse Occasional model. Available in black or white color (silver or black in USA), for other finishing, contact the Customer Department. Data slot can be customized according to the below diagram:

Regleta de conexiones montada bajo la superficie del sobre disponible para cualquier modelo de mesa Reverse Occasional. Se sirve en color negro o blanco (plata o negro en USA, para otros acabados consultar al Departamento Comercial. Se ofrecen dos tamaños de caja diferentes y con conectividad configurable, acorde al siguiente esquema:

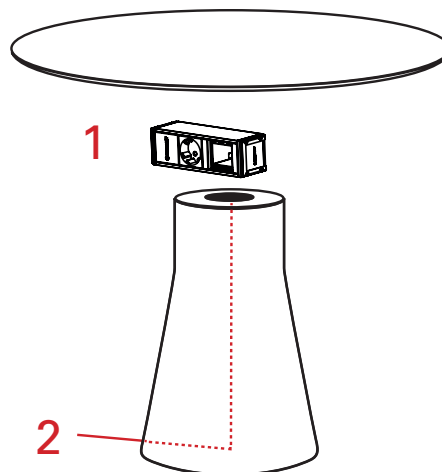
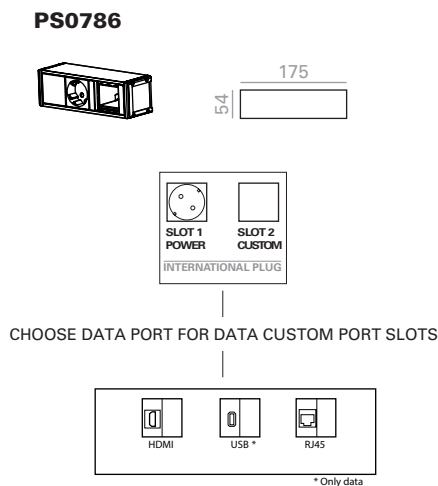

**1 POWER BOXES DISTRIBUTION DISTRIBUCIÓN DE SISTEMAS**

By default, power system will be placed according to the image below. De serie el sistema se dispondrá en la posición que indica la siguiente imagen.

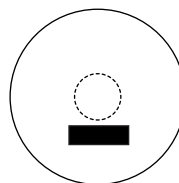

**2 WIRING MANAGEMENT SALIDA DE CABLEADO**

The cable way out can be performed directly from the power system or through a canal in the base bottom, so that is hidden until it gets to the floor.

La salida del cable se realiza directamente desde el propio sistema como por unas canalizaciones en la parte inferior de la base, de modo que el cable queda oculto hasta llegar al suelo.

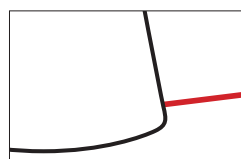

**OPTIONAL PREINSTALLED WIRING  
PREINSTALACIÓN DEL CABLEADO**

**IN0007**

Preinstalled wiring consists in the addition of the necessary mechanisms to integrate power systems in the table, so that wiring is hidden until the way out in the floor. Necessary grommet are included and 3m cable (from the power system). For other cable dimensions contact the Customer Department.

La preinstalación consiste en el montaje de los mecanismos necesarios para integrar el sistema de electrificación en la mesa, de modo que el cableado quede oculto hasta su salida por la base. Se incluyen los pasacables necesarios y 3 metros de cable (midiendo desde el sistema de conexiones).

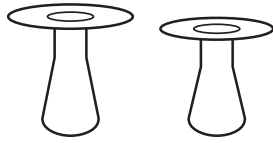

**Description**  
**Descripción**

Occasional table with central base and top in ash wood, with centre top in marble, lacquered wood or Technical Stone 8. Round table tops only version, in 2 sizes. Available in 2 heights.

Mesa auxiliar con base central y sobre en madera de fresno, con centro en diferentes acabados, mármol, madera lacada o Technical Stone 8. Sobres de mesa sólo redondos, en dos medidas. Disponible en 2 alturas.

**Wood finish Ash**  
**Acabado madera**  
**Fresno**



**Wood lacquer finish**  
**Acabado lacas madera**



**Compacto HPL finish**  
**Acabado Compacto**  
**HPL**

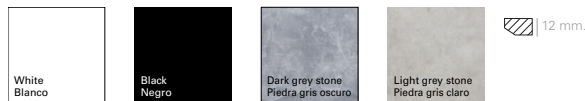

**Solid Surface finish**  
**Acabado Solid Surface**

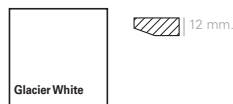

**Technical Stone decorative finish**  
**Acabado Technical**  
**Stone**

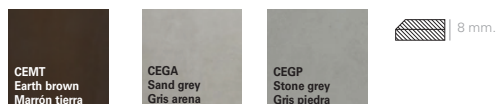

**M1 marble finish**  
**Acabado de mármol**  
**M1**

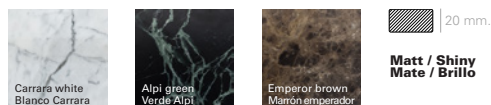

**M2 marble finish**  
**Acabado de mármol**  
**M2**

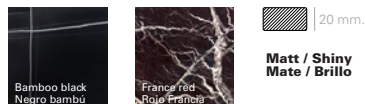

**M3 marble finish**  
**Acabado de mármol**  
**M3**

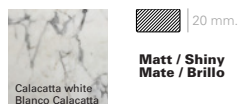

**Intellectual property Propiedad intelectual**

All our collections are protected by international industrial design registries, designs patents, copyrights and intellectual Property laws. Unauthorized use of AW International Property is a criminal offence and can lead to prosecution.  
Todas nuestras colecciones están protegidas por registros de diseño industrial, diseño de patente, copyright y derechos de propiedad intelectual todo el mundo. El uso no autorizado de los diseños y propiedad intelectual de AW supone un delito que puede ser sometido a acción judicial.



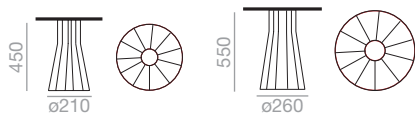

\*\*\*Marble shiny upcharge  
Incremento por mármol brillo

Table Height / Altura de mesa 450										
Top measures Medidas sobre	Ash/ Fresno *Centre Top/ Centro sobre									
	Lacquered Lacado		Technical Stone		***Marble M3 Mármol M3		***Marble M2 Mármol M2		***Marble M1 Mármol M1	
	Ref.	€	Ref.	€	Ref.	€	Ref.	€	Ref.	€
ø450	ME5642	1.543	ME5643	1.529	ME5644	1.655	ME5645	1.647	ME5646	1.611
kg	12		13		15		15		15	
1 box/ bulto  m3	0,13		0,13		0,13		0,13		0'13	

Table Height / Altura de mesa 550										
Top measures Medidas sobre	Ash/ Fresno *Centre Top/ Centro sobre									
	Lacquered Lacado		Technical Stone		***Marble M3 Mármol M3		***Marble M2 Mármol M2		***Marble M1 Mármol M1	
	Ref.	€	Ref.	€	Ref.	€	Ref.	€	Ref.	€
ø550	ME5647	1.747	ME5648	1.790	ME5649	1.914	ME5650	1.845	ME5651	1.859
kg	16		18		19		19		19	
1 box/ bulto  m3	0,23		0,23		0,23		0,23		0'23	

Maximum table heights  
Alturas máximas de mesa

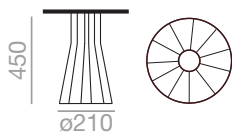

Ash/ Fresno				
Lacquered Lacado	Technical Stone	***Marble M3 Mármol M3	***Marble M2 Mármol M2	***Marble M1 Mármol M1
480	470	482	482	482

Maximum table heights  
Alturas máximas de mesa

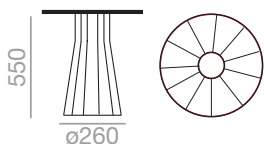

Ash/ Fresno				
Lacquered Lacado	Technical Stone	***Marble M3 Mármol M3	***Marble M2 Mármol M2	***Marble M1 Mármol M1
562	552	564	564	564





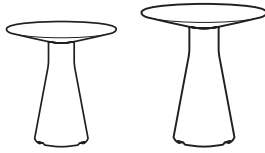

**Description**  
**Descripción**

Occasional tables with central base and top in Pure Eco thermo-polymer (100% recycled) available in several colors. Available in 2 different sizes and heights.

Mesas ocasionales con base central y sobre de termopolimero Pure Eco (100% reciclado) disponible en diferentes colores. Disponible en 2 medidas y alturas diferentes.

**Pure Eco Thermo-polymer finish**  
**Acabado de Termopolimero Pure Eco**

<p>6000PE RAL 9003 White Blanco</p>	<p>6006PE RAL 9005 Black Negro</p>	<p>6002PE NCS 2005-Y20R Sand Arena</p>	<p>6012PE NCS 4005-Y20R Basalt grey Gris basalto</p>
---	--	--	--

**Intellectual property Propiedad intelectual**

All our collections are protected by international industrial design registries, designs patents, copyrights and intellectual Property laws. Unauthorized use of AW International Property is a criminal offence and can lead to prosecution.

Todas nuestras colecciones están protegidas por registros de diseño industrial, diseño de patente, copyright y derechos de propiedad intelectual en todo el mundo. El uso no autorizado de los diseños y propiedad intelectual de AW supone un delito que puede ser sometido a acción judicial.





Auxiliary table.  
Mesa auxiliar.

**ME5890**

219

0'14 m3  
14 kg  
x1  
1 boxes bultos



Auxiliary table.  
Mesa auxiliar.

**ME5891**

246

0'23 m3  
24 kg  
x1  
1 boxes bultos



**Description**  
**Descripción**

Occasional table with 4 legs steel tube base finished in polished chrome, white or black . Round table tops in different sizes finished in oak, lacquer, smoked gray glass, Carrara marble and black marble bamboo.

Mesa auxiliar con base de 4 patas de tubo de acero y acabado cromo brillo, blanco o negro. Disponible en 2 alturas. Sobres redondos de diferentes medidas y acabado roble, lacado, cristal Fume gris, mármol Carrara y mármol negro bambú.

**Wood finish Oak**  
**Acabado madera Roble**



**Wood lacquer finish**  
**Acabado lacas madera**



**Smoked glass finish**  
**Acabado de cristal fumé**



**M1 marble finish**  
**Acabado de mármol M1**

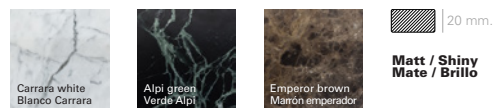

**M2 marble finish**  
**Acabado de mármol M2**

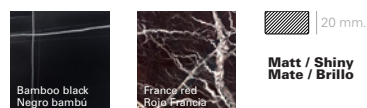

**Steel finish**  
**Acabado de acero**



**Intellectual property Propiedad intelectual**

All our collections are protected by international industrial design registries, designs patents, copyrights and intellectual Property laws. Unauthorized use of AW International Property is a criminal offence and can lead to prosecution.  
Todas nuestras colecciones están protegidas por registros de diseño industrial, diseño de patente, copyright y derechos de propiedad intelectual en todo el mundo. El uso no autorizado de los diseños y propiedad intelectual de AW supone un delito que puede ser sometido a acción judicial.



ø450



\*\*\*Marble shiny upcharge  
Incremento por mármol brillo

Table height / Altura de mesa 450											
Lower top Sobre inferior	Upper top / Sobre superior										
	*Oak Roble		s600	Lacquered Lacado		Glass Cristal		***M1 Marble Mármol M1		***M2 Marble Mármol M2	
	Ref.	€	€	Ref.	€	Ref.	€	Ref.	€	Ref.	€
Oak Roble	ME1900	850	114	ME1905	811	ME1910	944	ME1915	1.429	ME1920	1.552
kg	7.3		9.3		9.6		14.7		14.7		
1 box / bulto  m3	0.12		0.12		0.12		0.12		0.12		
Lacquered Lacado	ME1901	811	57	ME1906	761	ME1911	978	ME1916	1.346	ME1921	1.468
kg	9.3		11.4		11.7		16.8		16.8		
1 box / bulto  m3	0.12		0.12		0.12		0.12		0.12		
Smoked gray glass Cristal fumé gris	ME1902	899	57	ME1907	864	ME1912	910	ME1917	1.440	ME1922	1.563
kg	9.6		11.7		11.9		17		17		
1 box / bulto  m3	0.42		0.42		0.42		0.42		0.42		
Carrara Marble Mármol Carrara	ME1903	1.429	57	ME1908	1.391	ME1913	1.440	ME1918	1.846	ME1923	1.968
kg	14.7		16.8		17		22.1		22.1		
1 box / bulto  m3	0.42		0.42		0.42		0.42		0.42		
Bamboo Marble Mármol Bambú	ME1904	1.552	57	ME1909	1.514	ME1914	1.563	ME1919	1.968	ME1924	2.095
kg	14.7		16.8		17		22.1		22.1		
1 box / bulto  m3	0.42		0.42		0.42		0.42		0.42		

ø550

Table height / Altura de mesa 550											
Lower top Sobre inferior	Upper top / Sobre superior										
	*Oak Roble		s600	Lacquered Lacado		Glass Cristal		***M1 Marble Mármol M1		***M2 Marble Mármol M2	
	Ref.	€	€	Ref.	€	Ref.	€	Ref.	€	Ref.	€
Oak Roble	ME1925	895	120	ME1930	861	ME1935	976	ME1940	1.490	ME1945	1.612
kg	10.1		13.2		13.6		21.2		21.2		
1 box / bulto  m3	0.17		0.17		0.17		0.17		0.17		
Lacquered Lacado	ME1926	861	60	ME1931	826	ME1936	940	ME1941	1.419	ME1946	1.545
kg	13.2		16.3		16.7		24.3		24.3		
1 box / bulto  m3	0.17		0.17		0.17		0.17		0.17		
Smoked gray glass Cristal fumé gris	ME1927	976	60	ME1932	940	ME1937	995	ME1942	1.511	ME1947	1.633
kg	13.6		16.7		16.3		24.7		24.7		
1 box / bulto  m3	0.61		0.61		0.61		0.61		0.61		
Carrara Marble Mármol Carrara	ME1928	1.490	60	ME1933	1.455	ME1938	1.511	ME1943	1.893	ME1948	2.017
kg	21.2		24.3		24.7		32.3		32.3		
1 box / bulto  m3	0.61		0.61		0.61		0.61		0.61		
Bamboo Marble Mármol Bambú	ME1929	1.612	60	ME1934	1.577	ME1939	1.633	ME1944	2.017	ME1949	2.139
kg	21.2		24.3		24.7		31.3		32.3		
1 box / bulto  m3	0.61		0.61		0.61		0.61		0.61		

ø900



\*\*\*Marble shiny upcharge  
Incremento por mármol brillo

Table height / Altura de mesa 370											
Lower top Sobre inferior	Upper top / Sobre superior										
	*Oak Roble		s600	Lacquered Lacado		Glass Cristal		***M1 Marble Mármol M1		***M2 Marble Mármol M2	
	Ref.	€	€	Ref.	€	Ref.	€	Ref.	€	Ref.	€
Oak Roble	ME1950	1.570	220	ME1955	1.503	ME1960	1.656	ME1965	2.972	ME1970	3.236
kg	17		19.6		26.6		46.9		46.9		
1 box / bulto m3	0.47		0.47		0.81		0.81		0.81		
Lacquered Lacado	ME1951	1.503	110	ME1956	1.456	ME1961	1.549	ME1966	2.885	ME1971	3.150
kg	19		21.6		28.6		48.9		48.9		
1 box / bulto m3	0.47		0.47		0.81		0.81		0.81		
Smoked gray glass Cristal fumé gris	ME1952	1.608	110	ME1957	1.461	ME1962	1.592	ME1967	3.015	ME1972	3.278
kg	24.1		26.7		33.7		54		54		
1 box / bulto m3	0.81		0.81		0.81		0.81		0.81		
Carrara Marble Mármol Carrara	ME1953	2.972	110	ME1958	2.885	ME1963	3.015	ME1968	4.268	ME1973	4.532
kg	40.1		42.7		49.7		70		70		
1 box / bulto m3	0.81		0.81		0.81		0.81		0.81		
Bamboo Marble Mármol Bambú	ME1954	3.236	110	ME1959	3.150	ME1964	3.278	ME1969	4.532	ME1974	4.798
kg	40.1		42.7		49.7		70		70		
1 box / bulto m3	0.81		0.81		0.81		0.81		0.81		

ø1200

Table height / Altura de mesa 370											
Lower top Sobre inferior	Upper top / Sobre superior										
	*Oak Roble		s600	Lacquered Lacado		Glass Cristal		***M1 Marble Mármol M1		***M2 Marble Mármol M2	
	Ref.	€	€	Ref.	€	Ref.	€	Ref.	€	Ref.	€
Oak Roble	ME1975	1.686	276	ME1980	1.598	ME1985	1.822	ME1990	3.433	ME1995	3.737
kg	27.1		31.6		44.4		79		79		
1 box / bulto m3	0.79		0.79		1.31		1.31		1.31		
Lacquered Lacado	ME1976	1.598	138	ME1981	1.511	ME1986	1.663	ME1991	3.346	ME1996	3.649
kg	30.7		35.2		48		82.6		82.6		
1 box / bulto m3	0.79		0.79		1.31		1.31		1.31		
Smoked gray glass Cristal fumé gris	ME1977	1.752	138	ME1982	1.663	ME1987	1.894	ME1992	3.373	ME1997	3.676
kg	41.6		46.1		58.9		93.5		93.5		
1 box / bulto m3	1.31		1.31		1.31		1.31		1.31		
Carrara Marble Mármol Carrara	ME1978	3.433	138	ME1983	3.346	ME1988	3.415	ME1993	4.925	ME1998	5.233
kg	71.9		76.4		89.2		123.8		123.8		
1 box / bulto m3	1.31		1.31		1.31		1.31		1.31		
Bamboo Marble Mármol Bambú	ME1979	3.737	138	ME1984	3.649	ME1989	3.723	ME1994	5.233	ME1999	5.536
kg	71.9		76.4		89.2		123.8		123.8		
1 box / bulto m3	1.31		1.31		1.31		1.31		1.31		

Maximum table heights  
Alturas máximas de mesa



Upper top / Sobre superior				
*Oak Roble	Lacquered Lacado	Glass Cristal	***M1 Marble Mármol M1	***M2 Marble Mármol M2
449	449	441	451	451

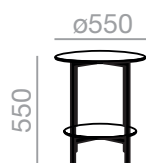

Upper top / Sobre superior				
*Oak Roble	Lacquered Lacado	Glass Cristal	***M1 Marble Mármol M1	***M2 Marble Mármol M2
549	549	541	551	551

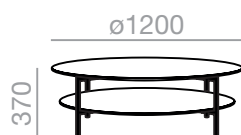

Upper top / Sobre superior				
*Oak Roble	Lacquered Lacado	Glass Cristal	***M1 Marble Mármol M1	***M2 Marble Mármol M2
370	370	370	370	370



**Description**

Occasional table with structure and base of 4 solid oak legs and oak top available in two different sizes.

**Descripción**

Mesa ocasional con estructura y base de 4 patas de madera maciza de roble y sobre de tablero de roble disponible en dos medidas diferentes.

**Wood finish Oak**

**Acabado madera  
Roble**



**Wood lacquer finish**

**Acabado lacas madera**

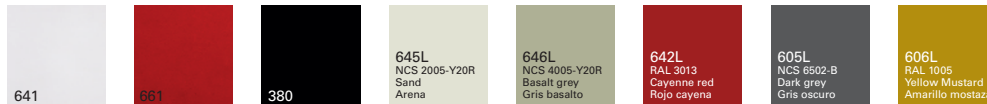

**Intellectual property Propiedad intelectual**

All our collections are protected by international industrial design registries, designs patents, copyrights and intellectual Property laws. Unauthorized use of AW International Property is a criminal offence and can lead to prosecution.

Todas nuestras colecciones están protegidas por registros de diseño industrial, diseño de patente, copyright y derechos de propiedad intelectual en todo el mundo. El uso no autorizado de los diseños y propiedad intelectual de AW supone un delito que puede ser sometido a acción judicial.



Occasional Table.

**ME2680**

708

0'14 m<sup>3</sup>

Mesa auxiliar.

4'28 kg

x1

1 boxes bultos

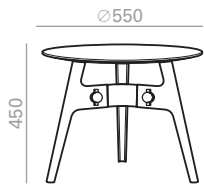

Occasional Table.

**ME2681**

729

0'23 m<sup>3</sup>

Mesa auxiliar.

5'02 kg

x1

1 boxes bultos

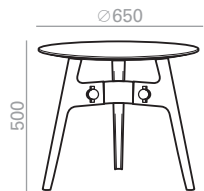





**Description**  
**Descripción**

Table with three-legged base in die-cast aluminum and pneumatic height adjustment, finished in polished aluminum, white or black. Top made of round TOP 18 table top finished in oak, walnut or lacquered.

Mesa ocasional con tres patas de inyección de aluminio, regulable en altura y acabado aluminio pulido, blanco o negro. Sobres de tablero Top 18 redondo en acabado roble, lacado o nogal.

**Wood finish Oak**  
**Acabado madera**  
**Roble**



**Wood lacquer finish**  
**Acabado lacas madera**



**Wood finish Walnut**  
**Acabado madera**  
**Nogal**

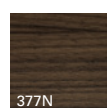

**Aluminum finish**  
**Acabado aluminio**



**Intellectual property Propiedad intelectual**

All our collections are protected by international industrial design registries, designs patents, copyrights and intellectual Property laws. Unauthorized use of AW International Property is a criminal offence and can lead to prosecution.  
Todas nuestras colecciones están protegidas por registros de diseño industrial, diseño de patente, copyright y derechos de propiedad intelectual en todo el mundo. El uso no autorizado de los diseños y propiedad intelectual de AW supone un delito que puede ser sometido a acción judicial.





Table top /	*Oak Roble		s600	Walnut Nogal		Lacquered Lacado	
	Ref.	€	€	Ref.	€	Ref.	€
	<b>ME6070</b>	604	84	<b>ME6071</b>	623	<b>ME6072</b>	581
 <b>kg</b>	9		9		9		
<b>1 box / bulto</b>	0.13 m3		0.13 m3		0.13 m3		

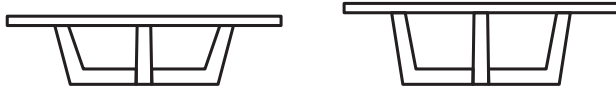

**Description**  
**Descripción**

Occasional tables made of solid oak base and top. Available in two different height and 4 different top dimensions.  
Mesa con sobre y base de madera de roble. Disponible en 2 alturas y 4 medidas de sobre.

**Wood finish Oak**  
**Acabado madera**  
**Roble**



**Wood lacquer finish**  
**Acabado lacas madera**



**Intellectual property Propiedad intelectual**

All our collections are protected by international industrial design registries, designs patents, copyrights and intellectual Property laws. Unauthorized use of AW International Property is a criminal offence and can lead to prosecution.  
Todas nuestras colecciones están protegidas por registros de diseño industrial, diseño de patente, copyright y derechos de propiedad intelectual en todo el mundo. El uso no autorizado de los diseños y propiedad intelectual de AW supone un delito que puede ser sometido a acción judicial.



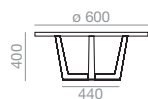

Auxiliary table.  
Mesa auxiliar.

**ME3696**  
Oak Roble

1.032

0'24 m3  
14 kg  
x1  
1 boxes bultos



Matt Lacquered and Premium Upcharge

90

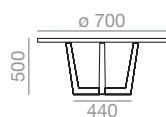

Auxiliary table.  
Mesa auxiliar.

**ME3697**  
Oak Roble

1.091

0'32 m3  
16 kg  
x1  
1 boxes bultos



Matt Lacquered and Premium Upcharge

90

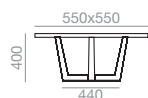

Auxiliary table.  
Mesa auxiliar.

**ME3698**  
Oak Roble

1.027

0'21 m3  
14 kg  
x1  
1 boxes bultos



Matt Lacquered and Premium Upcharge

90

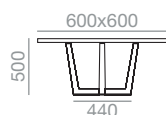

Auxiliary table.  
Mesa auxiliar.

**ME3699**  
Oak Roble

1.091

0'29 m3  
16 kg  
x1  
1 boxes bultos



Matt Lacquered and Premium Upcharge

90

**ME3701**  
Lacquered Lacado

1.020

**ME3702**  
Lacquered Lacado

994

**ME3703**  
Lacquered Lacado

1.012

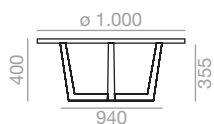

Low table.  
Mesa baja.

**ME3686**

1.860

0'6 m3  
41 kg  
x1  
1 boxes bultos

SERIE  
600

Incremento por Lacado  
Mate y Premium  
Matt Lacquered and  
Premium Upcharge

| 116 |

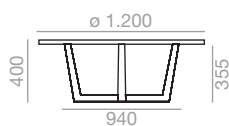

Low table.  
Mesa baja.

**ME3687**

2.099

0'84 m3  
51 kg  
x1  
1 boxes bultos

SERIE  
600

Incremento por Lacado  
Mate y Premium  
Matt Lacquered and  
Premium Upcharge

| 128 |

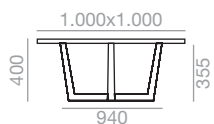

Low table.  
Mesa baja.

**ME3688**

1.969

0'6 m3  
41 kg  
x1  
1 boxes bultos

SERIE  
600

Incremento por Lacado  
Mate y Premium  
Matt Lacquered and  
Premium Upcharge

| 116 |

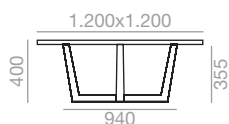

Low table.  
Mesa baja.

**ME3689**

2.179

0'84 m3  
51 kg  
x1  
1 boxes bultos

SERIE  
600

Incremento por Lacado  
Mate y Premium  
Matt Lacquered and  
Premium Upcharge

| 128 |

PS-UNDER TOP



**PS0786**

326

**Preinstalled (Optional) / Preinstalación (Opcional)**

62

**IN0007**

**UNDER-TOP POWER BOXES  
CAJA DE CONEXIONES BAJO EL SOBRE**

Power box mounted under the table top, available for any Reverse Occasional model. Available in black or white color (silver or black in USA), for other finishing, contact the Customer Department. Data slot can be customized according to the below diagram:

Regleta de conexiones montada bajo la superficie del sobre disponible para cualquier modelo de mesa Reverse Occasional. Se sirve en color negro o blanco (plata o negro en USA, para otros acabados consultar al Departamento Comercial. Se ofrecen dos tamaños de caja diferentes y con conectividad configurable, acorde al siguiente esquema:

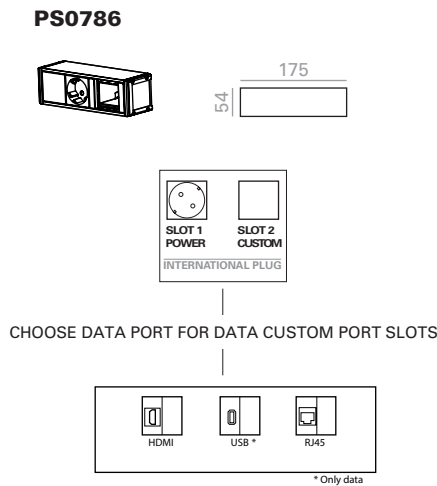

**1 POWER BOXES DISTRIBUTION DISTRIBUCIÓN DE SISTEMAS**

By default, power system will be placed according to the image below. De serie el sistema se dispondrá en la posición que indica la siguiente imagen.

**2 WIRING MANAGEMENT SALIDA DE CABLEADO**

The cable way out can be performed directly from the power system or thru a canal in the base bottom, so that is hidden until it gets to the floor. La salida del cable se realiza directamente desde el propio sistema como por unas canalizaciones en la parte inferior de la base, de modo que el cable queda oculto hasta llegar al suelo.

**OPTIONAL PREINSTALLED WIRING  
PREINSTALACIÓN DEL CABLEADO**

**IN0007**

Preinstalled wiring consists in the addition of the necessary mechanisms to integrate power systems in the table, so that wiring is hidden until the way out in the floor. Necessary grommet are included and 3m cable (from the power system). For other cable dimensions contact the Customer Department.

La preinstalación consiste en el montaje de los mecanismos necesarios para integrar el sistema de electrificación en la mesa, de modo que el cableado quede oculto hasta su salida por la base. Se incluyen los pasacables necesarios y 3 metros de cable (midiendo desde el sistema de conexiones).

## SALES CONDITIONS/REMARKS

1- This price-list is valid from the 01/01/2024

### 2- HOW TO ORDER.

Please specify:

- Model name and reference No. (ie. Alya BU-1522).
- Wood color name and reference N°. (ie. Natural beech Ref.300).
- Fabric category and reference No.
- Quantity.

### 3- DELIVERY TIME:

Is 4- 5 weeks after order confirmation. Loading date for orders with customer's special finishes or C.O.M. (Customer's Own Material) cannot be confirmed until confirmation of our counter-sample or C.O.M. arrives at Andreu World.

4- Goods remain our property until full payment.

5- Delivery terms indicated in our order confirmation are to be considered as indicative and are not binding for the manufacturer.

### 6- PRICE INCREASES:

Price increases given next to the product price in the catalogue are to be added per unit.

### 7- WITHOUT FABRIC:

Articles will be supplied with a protective white fabric (muslin) for upholstery by the customer. This option is not recommended for certain models due to difficulties in the upholstery process. Warning: Please mark on your purchase order if the articles without fabric should be provided with a cover.

### 8- UPHOLSTERED WITH CUSTOMER'S OWN MATERIAL (C.O.M.):

Not all upholsteries are suitable for all models of our catalog. For difficult cases where additional working time is required, an added cost may be applied. This fee will be communicated by Andreu World to be validated by the client.

t can be supplied at the price indicated in the Customer's Own Material category, but materials must arrive at the factory with the paid freight and at least 3 weeks before the loading date.

If materials are shipped from non-European Union countries, please be sure to include an invoice with no commercial value for customs clearance purposes. Any additional expenses incurred by Andreu World in using C.O.M. will be charged in the final invoice. Not all fabrics are suitable for the following models: Alya, Brandy, Flex chair, Flex High Back, Flex Corporate, Flex Executive, Lineal, Lineal Comfort, Lineal Corporate, Ronda, Tauro and Wok.

The fabric needed to upholster one or two units it is next to the pattern's detail. Should the width of your fabric be different from 140 cm., please contact with Customer Department. The quantity of fabric needed can vary significantly depending on the fabric's width. When C.O.M. requirements exceed one roll, one additional meter per roll has to be considered.

To facilitate the C.O.M. process, it is advisable to have the fabric sent to us 4 weeks before your expected loading date.

- The C.O.M.-requirement for fabrics with special rapport, because of its design, will be supplied on request after inspecting the size of the rapport.
- For C.O.M., facing and direction should be indicated.
- Please indicate the reference number of the order and the chairs which correspond to the C.O.M.

### 9- COVERS:

Andreu World's Upholstery Catalog includes fabrics that are suitable for covers. Please get in touch with the Sales Contact to consult each fabric's suitability for this use. We offer chair covers, as well as loose covers for some of our chairs. Some chair covers have Velcro adjustment. Maintenance: We recommend that you follow the cleaning instructions listed in our fabrics catalogue. We offer chairs with loose covers, as well as separate covers for some of our chairs. In both cases the covers will be fitted to the chair with Velcro. Maintenance: We recommend to follow the cleaning instructions that appear in our fabric sample catalogue.

### 10- MODEL WITH LOOSE COVERS:

The chair will be upholstered always with a protecting white fabric (muslin) and the cover will be manufactured in the fabric chosen by the customer.

### 11- COVERS IN C.O.M:

We can produce our covers with your own fabric, but we shall remind you that there are some fabrics that cannot be used to make covers due to its thickness and other particularities.

### 12- FABRIC ORDERS:

For fabric orders from the Andreu World catalogue, freight costs will be paid by the customer.

### 13- INTERLINER:

Andreu World supplies this material. Please contact our Sales Department for information of the price increases.

### 14- FSC®:

The majority of the products included in the catalogue of Andreu World are certified with the Forest Stewardship Council (FSC®) certification that ensures a sustainable use of wood. The full list of models with FSC® certification is available on Andreu World website: [www.andreuworld.com](http://www.andreuworld.com).

### 15- VARIATIONS IN COLOR OR TONALITY:

Since wood is a natural material, slight tone differences may be noticed on the individual elements of the product. In addition, if products are purchased at different times, natural ageing and climatic conditions may cause variations in color and/or tonality. Andreu World therefore accepts no claims or complaints with respect to tone differences and no goods may be returned for such reasons.

### 16- FINISHES IN SERIES 600 AND 800:

Price increases in Series 600 (matte lacquered) and in Series 800 (bright lacquered) are indicated next to each model price.

### 17- SPECIAL COLOR FINISHES:

Andreu World allows you to order finishes for the models of your choice using stain and lacquer samples supplied by you. To do so, please bear in mind the following surcharges:

#### a) SPECIAL CUSTOMER STAINS:

Gloss: model price + S/800 surcharge cost

#### b) SPECIAL CUSTOMER LACQUER:

Matte: model price + S/600 surcharge cost

Gloss: model price + S/800 surcharge cost

For seats orders under 10 units, add 100 Euros to the final amount shown on the order.

For tables orders, please contact our Customer Department.

Upon request, Andreu World can also supply a gloss finish on the model of your choice using the stains as shown in the color finishes catalogue. The surcharges are as follow:

Seats: model price + S/800 surcharge cost

### 18- TRANSPORT:

Andreu World pays the transport on the Peninsula and Balears except Andorra, Ceuta, Melilla and Canarias.

a) Andreu World cannot be held responsible for damage happened during the transport unless the following conditions are fulfilled:

- Transport is paid by Andreu World,
- The forwarder is assigned by Andreu World,
- The forwarder's delivery note states that the goods were accepted "PENDING INSPECTION"; and
- The damage is reported within 24 hours of reception. Failing these conditions, the damage will not be covered by the transport insurance and Andreu World is free from all responsibility.

- When carriage is for customer account or the carrier is chosen by the customer, the customer shall be responsible for any damage sustained during carriage.
- Orders for less than 1.000 Euros will have a transport up-charge 150 Euros

### 19- PACKING REINFORCEMENT:

The price increase for packing reinforcement is:

Seating/Tables: 50 Euros for the special packing.

### 20- SPECIAL MEASUREMENTS AND MODIFICATIONS:

Should you require any special measurement or modification to our standard products, please contact our sales department for information on viability, price and delivery time.

21- WEIGHTS AND VOLUMES: Weights and volumes that appear in the price-list refer to the weight and volume of the box including the products.

22- The manufacturer reserves the right to modify at any time the sizes and the patterns of the model, as well as to introduce any improvements and modifications deemed necessary in the manufacturer's sole criteria Warning: While we have tried to ensure that all prices, sizes, volumes, weights, and other specifications are accurate, they are intended only as a guide and are subject to modification without notice. Volumes, weights, number of boxes and units per box can vary depending on the combination of products or the total number of units ordered.

23- GUARANTEE: Andreu World products are guaranteed against all defects in materials and manufacturing processes for 10 years from the date of invoice. For special productions requested by customers, whether modifications or new models, as well as mechanisms, electrical components, models with natural wicker and the collections that make up our outdoor catalog, the guarantee will be two years. This guarantee does not include defects caused by misuse, accident, negligence, shipping damage, abuse, or the normal aging and wear and tear of the use itself. This guarantee does not extend to fabrics, leathers, covers and materials, not included in the Andreu World offering, owned by the customer or purchased by Andreu World at the customer's request. The correct selection of the product for each application is the responsibility of the buyer. This constitutes the complete and only guarantee, and replaces all possible guarantees of any kind, either implicitly or explicitly, including but not limited to compliance with Law 23/2003 dated July 10, 2003. Repair, exchange or prorated discount on the total price constitute the total responsibility of Andreu World and the only possible solution to the buyer. Andreu World assumes no responsibility for commercial losses and any consequences for damages that may result from any defect in the product, shortage or delay. It is understood that these solution and responsibility limitations are part of the terms and conditions of purchase from Andreu World of its products, and when an order is placed, the conditions, terms and limitations are being accepted.



## CONDICIONES DE VENTA/OBSERVACIONES

1 - Lista de precios vigente a partir del 01/01/2024

### 2 - CÓMO REALIZAR UN PEDIDO.

Concreten, por favor:

- Nombre y número de referencia del modelo (por ej., Alya BU-1522)
- Nombre y número de referencia del color de la madera (por ej., Haya natural, ref.300)
- Categoría y número de referencia de la tela.
- Cantidad.

### 3 - PLAZO DE ENTREGA:

Entre 4 y 5 semanas tras la confirmación del pedido. La fecha de carga para pedidos con acabados especiales para el cliente o con tela cliente no podrá confirmarse hasta la ratificación de nuestra contra muestra o cuando la tela cliente llegue a Andreu World.

4 - Las mercancías serán de nuestra propiedad hasta que se paguen en su totalidad.

5 - Los plazos de entrega indicados en nuestro pedido de confirmación se considerarán como indicativos y no tendrán carácter obligatorio para el fabricante.

### 6 - INCREMENTOS DE PRECIOS:

Junto a los precios de cada modelo figuran los incrementos a añadir por unidad.

### 7 - PRETAPIZADO:

Los artículos se suministrarán con una tela blanca protectora (muslin) para ser posteriormente tapizados por el cliente. Hay algunos modelos en que no recomendamos esta posibilidad debido a la dificultad de su realización. Advertencia: Por favor, señale en la orden de compra si los artículos solicitados en pretapizado llevarán una funda.

### 8 - TAPIZADO CON TELA CLIENTE:

No todas las tapicerías son aptas para todos los modelos de nuestro catálogo. En los casos en los que exista una dificultad añadida que requiera un aumento del tiempo de trabajo, cabe la posibilidad de que suponga un extra coste, que será comunicado por Andreu World para ser validado por el cliente.

Podrán suministrarse por el precio indicado en la categoría de tela cliente, pero las telas tienen que llegar a nuestras fábricas a portes pagados y con una antelación de 3-4 semanas desde la fecha de entrega del pedido.

Para los países no pertenecientes a la Unión Europea deben incluir una factura sin valor comercial, requisito obligatorio para pasar las aduanas en España. Cualquier gasto causado por la tela cliente se cargará en la factura.

No todas las tapicerías son aptas para los siguientes modelos: Alya, Brandy, Flex chair, Flex High Back, Flex Corporate, Flex Executive, Lineal, Lineal Comfort, Lineal Corporate, Ronda, Tauro y Wok.

La tela necesaria para tapizar una o dos unidades se encuentra junto al detalle de cada modelo. Si el ancho de su tela no es de 140 cm., por favor consulte con el Departamento Comercial. Las necesidades de tela varían en ocasiones de forma significativa según el ancho del rollo. Cuando las necesidades de tela cliente excede de un rollo, se debe considerar un metro más por rollo.

Para evitar problemas se recomienda enviar la tapicería 4 semanas antes de la fecha de entrega prevista para su pedido.

- La solicitud de tela cliente para telas con estampado especial, a causa de su diseño, se proporcionará sobre pedido después de inspeccionar el tamaño del estampado.
- Para la tela cliente deberá indicarse la cara buena y la dirección de la tela para su correcto tapizado.
- Por favor, indiquen el número de referencia del pedido y las sillas que correspondan a la tela cliente.

### 9 - FUNDAS:

Dentro del Catálogo de tapizados de Andreu World se ofrecen unas telas válidas para fundas. Rogamos se pongan en contacto con la Comercial para consultar la validez de la tela. Ofrecemos sillas con fundas, así como también fundas sueltas para algunas de nuestras sillas. En algunos casos la funda se ajustará a la silla con Velcro. Mantenimiento: Recomendamos que sigan las instrucciones de limpieza que figuran en nuestro catálogo de telas.

### 10 - MODELO CON FUNDAS:

La silla se tapizará siempre con una tela blanca protectora (muslin) y la funda se fabricará en la tela elegida por el cliente.

### 11 - FUNDAS EN TELA CLIENTE:

Podemos producir nuestras fundas con su tela, pero les advertimos que hay algunas telas que no pueden usarse para hacer una funda a causa de su espesor u otras peculiaridades.

### 12 - PEDIDOS DE TELAS:

En los pedidos de tapicerías del Catálogo de Andreu World los portes de envío serán a cuenta del cliente.

### 13 - INTERLINER:

Andreu World proporciona este material. Por favor contactar con nuestro Departamento Comercial para informarse de estos incrementos.

### 14 - FSC®:

Dentro del catálogo Andreu World, la gran mayoría de los modelos cumplen los requisitos del certificado FSC® que garantiza el uso sostenible de la madera. El listado completo de modelos que cumplen el FSC® está disponible en la web de Andreu World [www.andreuworld.com](http://www.andreuworld.com)

### 15- VARIACIONES EN EL COLOR O TONALIDAD:

Como la madera es un material natural, puede haber ligeras diferencias de tono entre los distintos elementos que componen el producto. Además, si los productos se compran en períodos distintos, el tiempo transcurrido y las condiciones climáticas pueden causar variaciones en el color y/o tonalidad. Por lo tanto, Andreu World no aceptará ninguna reclamación sobre este asunto y ningún artículo podrá devolverse por ello.

### 16- ACABADOS EN LA SERIE 600 Y EN LA SERIE 800:

Los incrementos de precios para los acabados de la Serie 600 (lacados mate) y de la Serie 800 (lacados brillo) están indicados junto al precio para cada modelo.

### 17- ACABADOS ESPECIALES DE COLOR:

Andreu World ofrece la posibilidad de acabar sus modelos con muestras de tintes y lacas suministradas por los clientes. Para ello, hay que tener en cuenta los siguientes incrementos:

#### a) TINTES ESPECIALES CLIENTE:

Brillo: precio del modelo + precio incremento s/800

#### b) LACA ESPECIALES CLIENTE:

Mate: precio del modelo + precio incremento s/600

Brillo: precio del modelo + precio incremento s / 800

Si el pedido fuera inferior a 10 unidades, se añadirán 100 Euros al valor final del pedido. Para mesas consulte con el Departamento Comercial.

Andreu World también ofrece la posibilidad de dar acabado brillo a las lacas pertenecientes a su Catálogo de acabados de color. Los incrementos serían los siguientes:

Asientos: precio del modelo + precio incremento s/800

### 18 - TRANSPORTE:

Andreu World cubre los portes de envío en la Península y Baleares salvo Andorra, Ceuta, Melilla y Canarias.

a) Andreu World sólo se responsabilizará de daños producidos en el transporte, cuando se cumplan los requisitos siguientes:

- Que el porte sea pagado por Andreu World,
  - Que la agencia de transportes sea asignada por Andreu World,
  - Que en el albarán de recepción de la agencia figure que la mercancía ha sido aceptada "SALVO EXAMEN", y
  - Que el daño sea comunicado en el plazo de 24 horas desde la recepción.
- Si no se dan estas condiciones el seguro de transporte no cubrirá el daño y Andreu World quedará exenta de toda responsabilidad.

b) Cuando el transporte sea pagado por el cliente o la agencia de transportes elegida por el cliente, el cliente será el responsable de los posibles daños producidos durante el transporte.

c) Los pedidos inferiores a 1.000 Euros tendrán un suplemento de transporte de 150 Euros.

### 19 - GASTOS POR ENVÍO AÉREO:

El aumento de precio por envío de la carga por avión será:  
Asientos/Mesas: 50 Euros por refuerzo especial.

### 20- MEDIDAS ESPECIALES Y MODIFICACIONES:

Cualquier medida especial o modificación sobre nuestra oferta estándar de producto que usted precise, deberá consultarla con nuestro Departamento Comercial, el cual le confirmará su viabilidad, precio y plazo de servicio.

21- PESOS Y VOLÚMENES: Los pesos y volúmenes que figuran en el catálogo de precios se refieren al peso y volumen de la caja en la que van los productos.

22- El fabricante se reserva el derecho, según su propio criterio, a modificar en cualquier momento los tamaños y modelos del prototipo, ya consistan en mejoras o en variantes. Advertencia: Si bien hemos tratado de asegurar que todos los precios, tamaños, volúmenes, pesos, y otras especificaciones sean precisas, ello se pretende sólo como una guía y está sujeto a modificación sin previo aviso. Los volúmenes, pesos, número de cajas y unidades por caja pueden variar dependiendo de la combinación de productos o del número total de unidades pedidas.

23- GARANTÍA: Los productos de Andreu World están garantizados contra todos los defectos en materiales y procesos de elaboración por 10 años desde la fecha de factura. Para las producciones especiales solicitadas por los clientes, ya sean modificaciones o nuevos modelos, así como para los mecanismos, componentes eléctricos, los modelos con rejilla natural y las colecciones que componen nuestros catálogo de exterior, la garantía será de dos años. Esta garantía no incluye las deficiencias ocasionadas por un uso indebido, accidente, negligencia, daños de transporte, abuso, o el envejecimiento y desgaste normal del propio uso. Esta garantía no se extiende a telas, pieles, fundas y materiales, no incluidos en la oferta de Andreu World, propiedad del cliente o comprados por Andreu World a petición del cliente. La correcta selección del producto para cada aplicación es responsabilidad del comprador. Ésta constituye la completa y única garantía, y reemplaza a todas aquellas posibles garantías de cualquier clase bien de forma implícita o explícita, incluyendo pero no limitando el cumplimiento de la Ley 23/2003 del 10 de julio de 2003. La reparación, cambio o el descuento prorrateado sobre el precio total constituyen la responsabilidad total de Andreu World y la única solución posible al comprador. Andreu World no asume ninguna responsabilidad por pérdidas comerciales y cualquier consecuencia en daños que puedan ser resultado de cualquier defecto en el producto, falta o retraso. Se entiende que estas limitaciones de solución y responsabilidad son parte de los términos y condiciones de compra a Andreu World de sus productos, y cuando se pasa un pedido se están aceptando las condiciones, términos y limitaciones.

## MAINTENANCE

### 1- WOOD/LACQUER

The majority of the beech, oak, walnut, maple, and ash woods used in the AW collections is obtained from sustainable wood sources. The FSC® (Forest Stewardship Council) certificate guarantees that our FSC®-certified products have been extracted from reforested areas and are prepared according to the FSC® Principles and Criteria, which define the minimum standards for good forest management worldwide.

#### MAINTENANCE

We recommend cleaning stains with a damp cloth and a soap solution.

### 2- WEBBING

30 mm. thick polypropylene webbing with satin finish. Used in Valeria and Smart collection.

#### MAINTENANCE

To clean, gently wipe the webbing belts using a brush and a cloth soaked in soapy water. Remove the excess soap and dry with a cloth.

### 3- UPHOLSTERY/COVERS

The Andreu World catalog offers different types of fabrics, leathers and synthetic leathers manufactured by world-leading companies.

#### MAINTENANCE

Information on maintenance, composition and technical characteristics, as well as the suitability of each fabric for use as covers, can be found in our upholstery catalogs.

### 4- CERAMICS

The ceramic tops and boards of the bases and tables included in the Andreu World are waterproof, hygienic and colorfast. They are fireproof and abrasion-resistant, as well as 100% recyclable.

#### MAINTENANCE

We recommend the use of regular detergents for cleaning. Lime, wine, ice cream, coffee and grease stains should be removed using an alkaline detergent or a descaling product. Wipe clean bird droppings as quickly as possible, since they can cause permanent stains.

### 5.- HIGH PRESSURE LAMINATES

The high pressure laminate table tops are suitable for outdoor use. They are treated against UV action and are highly resistant to wear, heat and moisture.

#### MAINTENANCE

The surface should be cleaned with a nonabrasive sponge, water and detergent. The imporosity of the surface helps prevent the penetration of dirt. Wipe clean bird droppings as soon as possible, since they can cause permanent stains on the surface of high pressure laminate.

### 6. – LAMINATED BOARDS

The laminated plywood table tops are suitable for covered outdoor spaces. They are extremely resistant to impacts and scratches and have been specifically designed for those uses which require a high-quality finish and a consistent surface.

#### MAINTENANCE

Cleaning is simple and only requires water and detergent.

### 7- STEEL

Steel is robust, hard, rigid and weather-resistant, making it suitable for a large number of uses. Andreu World uses chromed steel.

#### MAINTENANCE

Chromed steel requires regular cleaning with soapy water. In the case of stains, avoid abrasive sponges or fabrics.

Stainless steel only requires regular cleaning with soapy water. Stainless steel is synonymous with an attractive finish and durability. Any stains caused by aggressive products require a specific cleaning:

- Water- and lime-stains: Remains of lime can be removed by soaking with a 25% vinegar solution or a 15% nitric acid solution. Rinse well and continue washing with soap or detergent and water. Rinse with hot water. Wipe dry with a soft, clean cloth.

- Oil and Grease: Rinse with an organic/hydrocarbon (e.g., alcohol) product, then clean with soap or detergent and water. Rinse well with cold water and a dry cloth. Soaking is advisable before cleaning with hot soapy water.

- Tea and Coffee stains: Wash with washing soda (sodium bicarbonate) and hot water. Then wash with soap or detergent and water. Rinse thoroughly with hot water. Wipe dry with a soft, clean cloth.

For the correct maintenance of stainless steel structures in areas near the coast and for areas in permanent contact with marine environments, we recommend regular cleaning with soapy water.

### 8- THERMO-POLYMER

The Flex Chair, Flex High Back, Sail and Sit collection seats and backrests are made of high-quality, resistant thermopolymer that offers enormous versatility for all types of indoor and outdoor environments.

#### MAINTENANCE

Only soap and water is required for cleaning.

### 9. - GLASS

Tempered glass coated with high-adhesion vitrified paint that prevents color changes over time.

#### MAINTENANCE

Any cleaning product (including solvents) can be used

### 10- ALUMINUM

Aluminum is a lightweight, resistant alternative of proven effectiveness for outdoor and indoor furniture. It is 100% recyclable.

#### MAINTENANCE

Requires only soap and water.

### 11- SOLID SURFACE

Solid Surface is a non-porous and homogeneous material comprised of natural minerals and a small percentage of highly durable resins. These tops, made of natural minerals, are similar in appearance and feel to natural stone and are available in white. Suitable for outdoor use.

#### MAINTENANCE

The Solid surface tops does not absorb liquids, but is recommended to dry spills or drops immediately. Generally, most stains can be removed using a microfiber cloth dampened with household cleaner spray with circular movements.

### 12- MARBLE

Marble is a natural stone of great warmth and personality. It is able to be used in numerous environments and the ideal material for cutting edge installations.

#### MAINTENANCE

Proper cleaning of marble is essential for the life of the product. It is recommended to use neutral detergents diluted in water. It is not advisable to use cleaning products that contain acetone, lemon, or vinegar as these substances could dull or abrade the surface over time.

Marble is a natural material susceptible to staining due to its porosity. Therefore all spills should be cleaned up immediately to avoid staining.

## MANTENIMIENTO

### 1- MADERA/LACA

La madera utilizada en las colecciones de AW, de haya, roble nogal, arce y fresno, en su mayoría están desarrolladas a partir de maderas sostenibles. La certificación FSC® (Forest Stewardship Council) garantiza que nuestros productos certificados como FSC® se extraen de bosques reforestados y se elaboran de acuerdo a los Principios y Criterios del FSC®, los cuales definen los niveles mínimos de buena gestión para los bosques de todo el mundo.

### MANTENIMIENTO

En caso de manchas se recomienda limpiar la superficie con un paño húmedo en una solución jabonosa.

### 2- CINCHA

Cincha realizada en polipropileno de 30 mm de grosor y en acabado mate. Utilizada en la colección Valeria y Smart.

### MANTENIMIENTO

Para la limpieza se recomienda frotar suavemente las cintas con un cepillo y un paño empapado con agua jabonosa. Posteriormente retirar los excesos de jabón y secar con un paño.

### 3- TAPICERÍAS/FUNDAS

Andreu World ofrece en su catálogo distintos tipos de tapicerías, pieles y polipiel, fabricadas por líderes mundiales.

### MANTENIMIENTO

El mantenimiento, su composición, así como sus características técnicas, y si son aptas para su confección como fundas, está indicado en nuestros catálogos de tapizados.

### 4- CERÁMICA

Los sobres y tableros cerámicos de las mesas incluidas en las colecciones de Andreu World son impermeables, higiénicos y presentan colores inalterables. Son ignífugos y resistentes a la abrasión. Es 100% reciclable.

### MANTENIMIENTO

Para su limpieza se recomienda usar una esponja no abrasiva, agua caliente y detergente común. Para las manchas de cal, vino, helado, café o grasa se debe emplear un detergente alcalino o un desincrustante.

### 5- TABLEROS COMPACTOS

Los sobres de mesa de tablero compacto son idóneos para su uso en exterior. Incorporan un tratamiento que los protege de la acción UV, unido a la elevada resistencia al desgaste, al calor y a la humedad. La naturaleza no porosa ayuda a que la suciedad no penetre.

### MANTENIMIENTO

Solo requiere limpiar la superficie con una esponja no abrasiva, agua caliente y jabón.

### 6- TABLERO LAMINADO

Los sobres de tablero contrachapado laminado son extremadamente resistentes a los golpes y al rayado, están especialmente preparados para aquellos usos donde se necesita un buen acabado y una superficie consistente.

### MANTENIMIENTO

Su limpieza requiere únicamente agua caliente y jabón.

### 7- ACERO

El acero se caracteriza por ser robusto, duro, rígido y resistente a la agresión de agentes climáticos, permitiendo un gran número de usos.

Andreu World utiliza dos tipos de acero:

- Acero con acabado cromado.
- Acero inoxidable 304L, muy resistente, idóneo para exteriores situados a más de 20km de la costa.

### MANTENIMIENTO

El Acero cromado, requiere una limpieza regular con agua jabonosa. En caso de manchas, se deben evitar las esponjas o tejidos abrasivos.

En el caso de acero inoxidable, su mantenimiento tan solo requiere una limpieza regular con agua jabonosa. El acero inoxidable es sinónimo de durabilidad con buen aspecto, siempre que se tengan en cuenta las manchas de productos agresivos y se proceda a una limpieza específica:

- Marcas de agua y cal: Restos importantes de cal pueden ser eliminados remojando con una solución de vinagre al 25% o ácido nítrico al 15%. Aclarar bien y continuar lavando con jabón o detergente y agua. Aclarar con agua caliente. Limpie en seco con un paño de limpieza suave.
- Aceite y Grasa: Lavar con un producto orgánico/hidrocarbónico (por ejemplo alcohol), después limpiar con jabón o detergente suave y agua. Aclarar bien con agua fría y un trapo seco. Se recomienda remojar antes de limpiar con agua caliente enjabonada.
- Marcas de Té y Café: Lavar con soda de lavar (bicarbonato de sodio) y agua caliente. Continuar con un lavado con jabón o detergente y agua. Aclarar a fondo con agua caliente. Limpie en seco con un paño de limpieza suave.

Para un óptimo mantenimiento de las estructuras metálicas de acero inoxidable en zonas cercanas a la costa y en permanente contacto con ambientes marinos, se recomienda una limpieza regular con agua jabonosa.

### 8- TERMOPOLÍMERO

Los asientos y respaldos de las colecciones Flex Chair, Flex High Back, Sail y Sit están realizados en termopolímero de alta calidad y resistencia que le otorgan gran versatilidad para todo tipo de ambientes tanto de interior como de exterior.

### MANTENIMIENTO

Su limpieza requiere únicamente agua caliente y jabón.

### 9- CRISTAL

Vidrio templado recubierto con pintura vitrificada de gran adherencia que evita variaciones de color a lo largo del tiempo.

### MANTENIMIENTO

Puede utilizarse cualquier producto de limpieza (incluidos disolventes).

### 10- ALUMINIO

El aluminio es una alternativa ligera, resistente y de contrastada eficacia en la realización de mobiliario de interior o exterior. Es 100% reciclable.

### MANTENIMIENTO

Solo precisa de agua y jabón.

### 11- SOLID SURFACE

Solid Surface es un material compacto y homogéneo, compuesto de minerales naturales y un bajo porcentaje de resinas de alta resistencia. Estos sobres, compuestos por minerales naturales, son en su apariencia y tacto similares a la piedra natural y están disponibles en blanco. Válido para uso en exterior.

### MANTENIMIENTO

Los Top Solid Surface no absorben líquidos, pero se recomienda pasar una esponja o bayeta humedecida para secar las salpicaduras. Las manchas en superficie se pueden eliminar utilizando una bayeta de microfibra humedecida con detergente doméstico en spray realizando movimientos circulares.

### 12- MÁRMOL

El mármol es una piedra natural de gran calidez y gran personalidad que le permiten su aplicación en múltiples ambientes, siendo un material idóneo para la decoración de vanguardia.

### MANTENIMIENTO

La limpieza del mármol es fundamental para la duración del producto. Se recomienda utilizar detergentes neutros diluidos en agua. No es recomendable utilizar materiales de limpieza que contengan acetona, limón, o vinagre porque con el tiempo podrían opacar o desgastar la superficie.

El mármol es un material natural vulnerable ante las manchas debido a su porosidad por lo que debe limpiarse inmediatamente después de cualquier mancha.

## CERTIFICATIONS

### 1.- WEBBING

EN 1021 part 1-2:94 Fire resistance

### 3. - CERAMICS

UNE EN ISO 10545-3 Water absorption

UNE EN ISO 10545-4 Flexural strength

UNE EN ISO 10545-6 Abrasion resistance

UNE EN ISO 10545-4 Breakage strength

UNE ENV 12633 Friction coefficient

UNE EN ISO 1054512 Frost resistance

UNE EN ISO 10545-9 Resistance to thermal shock

UNE EN 13501-1:02 Fire resistance

### 4.- COMPACT BOARDS

EN 438-6 Exterior-grade compact laminates (2mm and thicker)

EN 438-2-10 Abrasion resistance

EN 438-2-12 Resistance to boiling water

EN 438-2-14 Resistance to water vapor

EN 438-2-16 Resistance to dry heat 180°C

EN 12721 Resistance to wet heat

EN 438-2-17 Dimensional stability at high temperature

EN 438-2-21 Resistance to impact by large-diameter ball

EN 438-2-24 Resistance to crazing

EN 438-2-25 Resistance to scratching

EN 438-2-26 Stain resistance

EN 438-2-27 Colorfastness in artificial light

EN 438-2-30 Resistance to cigarette burns.

Fire resistance C-s1,d0

### 5.- LAMINATED BOARDS

UNE-EN 315:2001 Plywood. Dimensional tolerances

EN 314-2/clase 3 Bonding quality

EN 438-2-10 Abrasion resistance

EN 438-2-12 Resistance to boiling water

EN 438-2-14 Resistance to water vapor

EN 438-2-16 Resistance to dry heat 180°C

EN 12721 Resistance to wet heat

EN 438-2-17 Dimensional stability at high temperature

EN 438-2-21 Resistance to impact by large-diameter ball

EN 438-2-20 Resistance to impact by small-diameter ball

EN 438-2-23 Cracking resistance

EN 438-2-24 Resistance to crazing

EN 438-2-25 Resistance to scratching

EN 438-2-26 Stain resistance

EN 438-2-27 Colorfastness in artificial light

EN 438-2-30 Resistance to cigarette burns

EN 438-2-33 Resistance to blistering

\*\*For more detailed information on test results contact Export Department.

## CERTIFICACIONES

### 1-CINCHA

EN 1021 part 1-2:94 Reacción al fuego

### 3- CERÁMICA

UNE EN ISO 10545-3 Absorción de agua

UNE EN ISO 10545-4 Resistencia a la flexión

UNE EN ISO 10545-6 Resistencia a la abrasión

UNE EN ISO 10545-4 Fuerza de rotura

UNE ENV 12633 Resistencia al deslizamiento

UNE EN ISO 1054512 Resistencia al hielo/deshielo

UNE EN ISO 10545-9 Resistencia al choque térmico

UNE EN 13501-1:02 Reacción al fuego

### 4- TABLERO COMPACTO

EN 438-6 Compactos para exteriores de 2 mm de espesor y mayores.

EN 438-2-10 Resistencia a la abrasión.

EN 438-2-12 Resistencia al agua hirviendo.

EN 438-2-14 Resistencia al vapor de agua.

EN 438-2-16 Resistente al calor seco 180°C.

EN 12721 Resistencia al calor húmedo.

EN 438-2-17 Estabilidad dimensional a temperatura elevada.

EN 438-2-21 Resistencia al impacto de una bola de gran diámetro.

EN 438-2-24 Resistencia al agrietado.

EN 438-2-25 Resistencia al rayado.

EN 438-2-26 Resistencia a las manchas.

EN 438-2-27 Solidez del color a la luz artificial.

EN 438-2-30 Resistencia a las quemaduras de cigarrillo.

Reacción al fuego C-s1,d0

### 5- TABLERO LAMINADO

UNE-EN 315:2001 Tablero contrachapado. Tolerancias dimensionales

EN 314-2/clase 3 Calidad del encolado. Especificaciones

EN 438-2-10 Resistencia a la abrasión

EN 438-2-12 Resistencia al agua hirviendo

EN 438-2-14 Resistencia al vapor de agua

EN 438-2-16 Resistente al calor seco 180°

EN 12721 Resistente al calor húmedo

EN 438-2-17 Estabilidad dimensional a temperatura elevada

EN 438-2-21 Resistencia al impacto de una bola de gran diámetro

EN 438-2-20 Resistencia al impacto de una bola de pequeño diámetro

EN 438-2-23 Resistencia a las fisuras

EN 438-2-24 Resistencia al agrietado

EN 438-2-25 Resistencia al rayado

EN 438-2-26 Resistencia a las manchas

EN 438-2-27 Solidez del color a la luz artificial

EN 438-2-30 Resistencia a las quemaduras de cigarrillo

EN 438-2-33 Resistencia a la formación de ampollas

\*\*Para recibir información detallada sobre los resultados de los ensayos contactar con nuestro Departamento comercial.