



Lista PVP - España

Updated Actualizada
1 / 1 / 2024

Intellectual Property Guarantee

All designs are original and to owned by Andreu World, S.L.

All models comprising furniture collections with the trademark "Andreu World" are protected by industrial design registries, design patents, copyrights and intellectual property rights worldwide. Only Andreu World, S.L. and persons or companies authorized by Andreu World have the right to use these protected designs.

With the aim of defending quality, protecting originality and emphasizing the value of each of these designs, Andreu World, S.L. with the interest of its customers, suppliers, employees, designers and stakeholders, will exercise any and all legal actions as may be necessary against anyone who manufactures, offers, uses, sells, purchases, imports or exports any products using Andreu World, S.L. designs without the company's express written permission.

To purchase furniture with the Andreu World trademark, please only address authorized dealers or distributors of Andreu World. If you are unsure of the origin of a furniture piece, please consult the official dealers and sale point list at www.andreuworl.com or contact us directly by phone on +34961805700 or e-mail us at: aworld@andreuworl.com

Garantía de Propiedad Intelectual

Todos los diseños son originales y propiedad de Andreu World, S.L.

La totalidad de los modelos que componen las colecciones de muebles con marca "Andreu World" están protegidos por registros de diseño industrial, design patent, copyright y derechos de propiedad intelectual en todo el mundo. Sólo Andreu World, S.L. y las personas o mercantiles autorizadas por Andreu World tienen derecho a utilizar los diseños protegidos.

Con el objetivo de defender la calidad, reivindicar la originalidad y destacar el valor de cada uno de los diseños, Andreu World, S.L., en interés de sus clientes, proveedores, trabajadores, autores y accionistas, ejercerá las acciones legales oportunas contra todo aquel que, sin su autorización y de cualquier forma, fabrique, oferte, use, comercialice, compre, importe o exporte productos que incorporen sus diseños.

Para adquirir muebles de la marca "AndreuWorld" diríjase sólo a representantes autorizados o distribuidores oficiales de Andreu World. Si tiene alguna duda sobre la procedencia de la pieza, consulte el listado oficial de distribuidores y puntos de venta de Andreu World en www.andreuworl.com o contacte directamente con nosotros a través del teléfono: +34961805700 o vía e-mail: aworld@andreuworl.com



Stackable on the floor
Apilable sobre suelo



Stackable on trolley
Apilable sobre carro



Beech
Haya



Oak
Roble



Ash
Fresno



Maple
Arce

1	Fabrics Tapicerías	7	Fabrics Tapicerías	L1	Leather Piel	 Woven Bands Cincha	S600	Matt Lacquered and Premium Upcharge Incremento por Lacado Mate y Premium	
2	Fabrics Tapicerías	8	Fabrics Tapicerías	L2	Leather / Hide Leather Piel / Cuero	TP	Thermo-polymer Termopolimero		
3	Fabrics Tapicerías	9	Fabrics Tapicerías	L3	Leather Piel	COM	Customer's Own Material Tela Cliente	S800	Polished Lacquered Upcharge Incremento por Lacado Brillo
4	Fabrics Tapicerías	10	Fabrics Tapicerías	L6	Leather Piel	COL	Customer's Own Leather Piel Cliente	CRB	Polished Chrome Upcharge Incremento por cromo brillo
5	Fabrics Tapicerías	11	Fabrics Tapicerías						
6	Fabrics Tapicerías								

Seating Collection
Colección de Asientos



Adela Rex 7

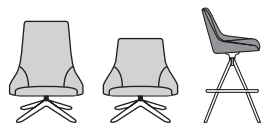

Alya 11



Alya Executive 23



Anna / Lounge /
Easy Chair / Corporate 29



Beat 33

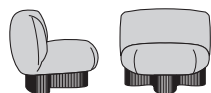

Bolete Lounge BIO
NEW 35



Brandy 37



Calma Chair NEW 43



Capri Executive 51



Capri Lounge 57

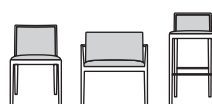

Carlotta 65



Carola 69



Casta NEW 73



Closed Bench 75

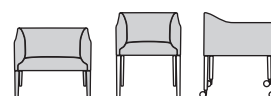

Couv/Couvé Alu 79

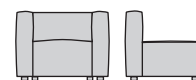

Dado 83



Duos 129

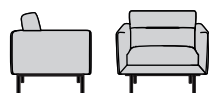

Element 133



Flex Armchair 137



Flex Chair 145



Flex High Back 167



Flex Corporate 185



Flex Executive 193



Forest Club Sofa 201



Gala 205



Gala Pure Eco NEW 209



Giro Soft 211



Grand Raglan 237

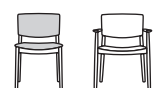

Happy 241



Hula 245



In Out Office NEW 251



Lake 265

Seating Collection
Colección de Asientos



Liceo 267



Lineal 269



Lineal Comfort 277

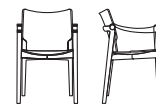

Luba **NEW** 285



Maksim **NEW** 287

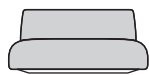

Manfred 291



Manila/Manila Corporate 293

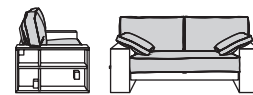

Mariya 299



Moody 301



Next 303

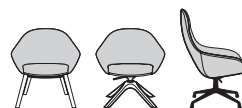

Next Lounge 309

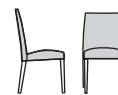

Noosa 313



Nub 315



Nuez 321



Nuez Lounge BIO 343



Olena **NEW** 347



Öru Chair 351



Pillow 355



Raglan 359

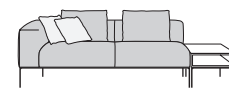

Raglan Home 381

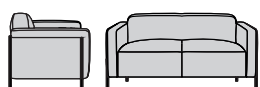

Rap 387



RDL 389



Rizo 393



Ronda 397



Sail 413

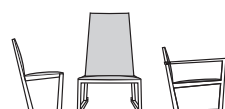

Serena 417

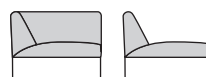

Siesta 421

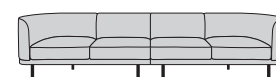

Sir **NEW** 427



Sit 449



Smart 459



Smile 463

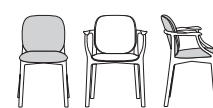

Solo Chair 471

Seating Collection
Colección de Asientos



Tauro 475



Valeria 479

Sales conditions/Remarks	483
Maintenance	485
Certificate	487

Condiciones venta/Obs.	484
Mantenimiento	486
Certificados	487



Fabrics Tapicerías	488
-----------------------	-----

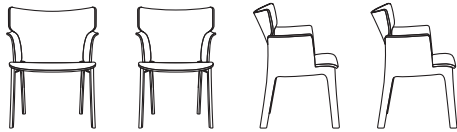

Description
Descripción

Armchair and lounge chair with seat and back in oak board or upholstered shell pad and frame in oak board available in 3 finishes: 306, 340 y 372. Lounge chair and armchair version in walnut. Armchair available in wide version.
Sillón y butaca con asiento y respaldo de tablero de roble o plafonado y estructura de tablero de roble disponible en 3 acabados: 306, 340 y 372. Versión de sillón y butaca en tablero de nogal. Disponible versión ancha de sillón.

Upholstery
Tapicería

The Adela Rex collection supports following upholsteries of Andreu World Catalogue. For fabrics in our catalogue not specified in this box or customers own materials please contact our Customer Service Department.
La colección Adela Rex admite las siguientes tapicerías del catálogo de Andreu World. Para las telas de nuestro catálogo no indicadas en este cuadro o telas cliente, consultar con nuestro Departamento Comercial.

Fabrics / Telas

- 1 Jacquard One
Jacquard Three
Sand
Era
Gravity
Rivet
Urban
Spin One
Spin Two
Spin Three
Spin Four
Spin Five
- 2 Jacquard Two
Circular One Pure Eco
Tack One (in/out)

- 3 Jacquard Four
Medley
Revive 1
Main Line Flax
Loom Two (in/out)
Mezzo
Reel two (in/out)
Jacquard Five

- 4 Jacquard 4 Special
Nexus
Heritage
Savane
Loom Three
Loom Four
Cura
Oceanic
Reel Three (in/out)
Reel Four (in/out)
Reflect
Spin Six

- 5 Silk
Synergy
Step
Step Melange
Blazer
Melange Nap
Chili
Noma
Re-wool

- 6 Go check
Swing
Chartres
Zori
Patio
Tack Two (in/out)
Tack Three (in/out)

- 7 Select
Clara 2
Tack Five (in/out)
Hero 2

- 8 Capture
Fiord 2
Tonus 4
Divina 3
Lopi
Domino
Atrium
- 9 Divina MD
Divina Melange 3
Hallingdal 65
Steelcut Trio 3
Tack Four (in/out)

- 11 Arda
Ecriture
Zero

Faux Leather / Ecopiel

- 1 Valencia
- 2 Silvertex
- 3 Maglia
- 8 Ultraleather
- 9 Fresco
Ultraleather Pro
Promessa
- 11 Volar Bio

Leather / Piel

- L1 High grade cow leather.
Piel de vaca de 1ª categoría.
- L3 Polished full grain leather.
Plena flor pulida.
- L6 Aniline leather batique-effect.
Scandinavian cattle.
Piel anilina efecto batique.
Ganado escandinavo.

Wood finish Oak
Acabado madera
Roble

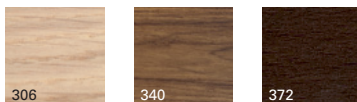

Wood finish Walnut
Acabado madera
Nogal

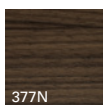

Certificates
Certificados

Fireproof polyurethane foam
Espuma de poliuretano ignifuga

UNE EN 1021:2006
BS 5852 part 2 crib 5
UNI 9175 Classe 1 IM
BKZ 5.2
California TB 117:2013
California TB 133*

*Contact our Customer Department
*Consultar con nuestro Departamento Comercial

Quality - Resistance
Calidad - Resistencia

UNE EN 16139:2013

Intellectual property Propiedad intelectual

All our collections are protected by international industrial design registries, designs patents, copyrights and intellectual Property laws. Unauthorized use of AW International Property is a criminal offence and can lead to prosecution.
Todas nuestras colecciones están protegidas por registros de diseño industrial, diseño de patente, copyright y derechos de propiedad intelectual todo el mundo. El uso no autorizado de los diseños y propiedad intelectual de AW supone un delito que puede ser sometido a acción judicial.



SO1410

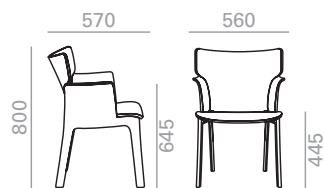

Armchair with oak seat, back and frame available in finishes 306, 340 and 372. Option of upholstered shell pad.
Sillón con asiento, respaldo y estructura de tablero de roble disponible en acabado 306, 340 y 372. Opción de asiento y respaldo plafonado.

COM cm. per unit	COL m2
------------------	--------

0,31 m3
22 kg
x2

Seat pad Asiento plafonado

1 units	50	1
10 units or more	50	

Shell pad Asiento y respaldo plafonado

1 units	90	2
10 units or more	90	

€ 520

Oak Roble



Upholstered seat pad
Asiento plafonado



Upholstered shell pad
Asiento y respaldo plafonado

COM	COL	1	2	3	4	5	6	7	8	9	10	11	L1	L2	L3	L6
618	623	627	632	636	643	648	654	660	666	672	679	685	689	711	752	858

COM	COL	1	2	3	4	5	6	7	8	9	10	11	L1	L2	L3	L6
714	722	731	740	751	761	773	785	796	808	821	833	845	856	901	981	1.193

SO1411

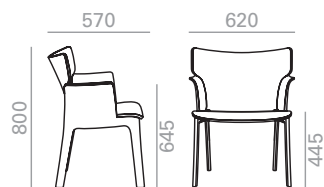

Armchair with oak seat, back and frame available in finishes 306, 340 and 372. Wide version. Option of upholstered shell pad.
Sillón con asiento, respaldo y estructura de tablero de roble disponible en acabado 306, 340 y 372. Versión ancha. Opción de asiento y respaldo plafonado.

COM cm. per unit	COL m2
------------------	--------

0,32 m3
23 kg
x2

Seat pad Asiento plafonado

1 units	50	1
10 units or more	50	

Shell pad Asiento y respaldo plafonado

1 units	90	2
10 units or more	90	

€ 539

Oak Roble



Upholstered seat pad
Asiento plafonado



Upholstered shell pad
Asiento y respaldo plafonado

COM	COL	1	2	3	4	5	6	7	8	9	10	11	L1	L2	L3	L6
643	648	652	657	661	667	672	679	685	691	697	703	710	714	736	777	881

COM	COL	1	2	3	4	5	6	7	8	9	10	11	L1	L2	L3	L6
741	752	759	770	778	790	801	814	824	836	849	861	873	884	928	1.008	1.220

BU1412

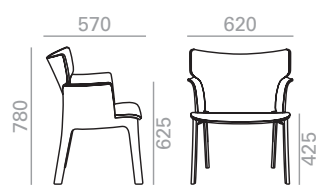

Lounge chair with oak seat, back and frame available in finishes 306, 340 and 372. Option of upholstered shell pad.
Butaca con asiento, respaldo y estructura de tablero de roble disponible en acabado 306, 340 y 372. Opción de asiento y respaldo plafonado.

COM cm. per unit	COL m2
------------------	--------

0,34 m3
23 kg
x2

Seat pad Asiento plafonado

1 units	50	1
10 units or more	50	

Shell pad Asiento y respaldo plafonado

1 units	90	2
10 units or more	90	

€ 539

Oak Roble



Upholstered seat pad
Asiento plafonado



Upholstered shell pad
Asiento y respaldo plafonado

COM	COL	1	2	3	4	5	6	7	8	9	10	11	L1	L2	L3	L6
643	648	652	657	661	668	674	678	685	691	697	703	710	716	738	778	884

COM	COL	1	2	3	4	5	6	7	8	9	10	11	L1	L2	L3	L6
741	752	759	770	778	790	801	814	824	836	849	861	873	884	928	1.008	1.220



Roble Oak



Nogal Walnut

Measures +- 5 mm.
Medidas +- 5 mm.

SO1413

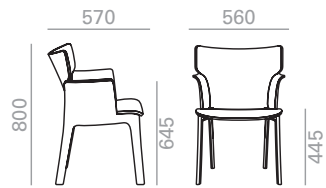

Armchair with walnut seat, back and frame. Option of upholstered shell pad.
Sillón con asiento, respaldo y estructura de tablero de nogal. Opción de asiento y respaldo plafonado.

COM cm. per unit	COL m2
------------------	--------

0,31 m3
 22 kg
 x2

Seat pad Asiento plafonado

1 units	50	1
10 units or more	50	

Shell pad Asiento y respaldo plafonado

1 units	90	2
10 units or more	90	



564



Upholstered seat pad
Asiento plafonado



Upholstered shell pad
Asiento y respaldo plafonado

COM	COL	1	2	3	4	5	6	7	8	9	10	11	L1	L2	L3	L6
663	667	671	676	680	687	692	698	704	710	716	723	729	733	755	796	902
COM	COL	1	2	3	4	5	6	7	8	9	10	11	L1	L2	L3	L6
758	768	775	784	795	805	817	829	840	852	865	877	889	900	945	1.026	1.237

SO1414

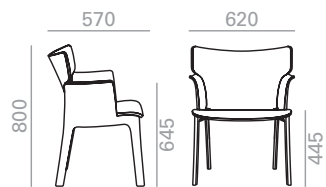

Armchair with walnut seat, back and frame. Wide version. Option of upholstered shell pad.
Sillón con asiento, respaldo y estructura de tablero de nogal. Versión ancha. Opción de asiento y respaldo plafonado.

COM cm. per unit	COL m2
------------------	--------

0,32 m3
 23 kg
 x2

Seat pad Asiento plafonado

1 units	50	1
10 units or more	50	

Shell pad Asiento y respaldo plafonado

1 units	90	2
10 units or more	90	



586



Upholstered seat pad
Asiento plafonado



Upholstered shell pad
Asiento y respaldo plafonado

COM	COL	1	2	3	4	5	6	7	8	9	10	11	L1	L2	L3	L6
690	695	699	705	708	714	719	726	732	738	744	751	757	761	783	824	928
COM	COL	1	2	3	4	5	6	7	8	9	10	11	L1	L2	L3	L6
790	799	806	817	825	837	848	861	873	883	896	908	920	931	975	1.055	1.267

BU1415

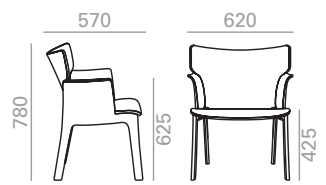

Lounge chair with walnut seat, back and frame. Option of upholstered shell pad.
Butaca con asiento, respaldo y estructura de tablero de nogal. Opción de asiento y respaldo plafonado.

COM cm. per unit	COL m2
------------------	--------

0,34 m3
 23 kg
 x2

Seat pad Asiento plafonado

1 units	50	1
10 units or more	50	

Shell pad Asiento y respaldo plafonado

1 units	90	1,5
10 units or more	90	



586



Upholstered seat pad
Asiento plafonado



Upholstered shell pad
Asiento y respaldo plafonado

COM	COL	1	2	3	4	5	6	7	8	9	10	11	L1	L2	L3	L6
690	695	699	705	708	714	720	726	731	737	743	750	756	762	783	823	927
COM	COL	1	2	3	4	5	6	7	8	9	10	11	L1	L2	L3	L6
790	799	806	817	825	837	847	861	873	883	896	907	919	930	972	1.052	1.261



Roble
Oak



Nogal
Walnut

Measures +- 5 mm.
Medidas +- 5 mm.

For wooden legs. Para bases de madera.



Optional glides on page 482.

Opciones de tacos deslizantes en página 482.



Description
Descripción

Chairs and armchairs with upholstered seat and backrest. Lounge chair version in 2 different heights. Bases available: 4-blade swivel base with self-return system or 4-legs, in solid beech wood, steel sled base in polished chrome with white or black finish and 4-blade aluminum swivel base, with self-return system with polished white or black finish; tilting option available and satellite table in black melamine finish, depending on versions. High-backed lounge chair version available, upholstered to the bottom, with fixed or swivel base. Stool version available with upholstered seat and backrest and sled base or 4-legged steel swivel, in polished chrome, white or black finish and 4-legged base in solid beech wood. Upholstered footrest version available with central 4-blade aluminum base in polished aluminum with white or black finish or fully upholstered version.

Sillas y sillones con asiento y respaldo tapizado. Versión de butaca en 2 alturas diferentes. Bases disponibles: central giratoria de 4 aspas con sistema de retorno o 4 patas, en madera maciza de haya, patín de acero en acabado cromo brillo, blanco o negro y central giratoria de aluminio de 4 aspas, con sistema de retorno y acabado aluminio pulido, blanco o negro; disponible opción basculante y mesa satélite en acabado melamina negra, según versiones. Disponible versión de butaca de respaldo alto, tapizada hasta abajo, con base fija o giratoria. Disponible versión de banqueta con asiento y respaldo tapizado y base de patín o giratoria de 4 patas de acero, en acabado cromo brillo, blanco o negro y base de 4 patas de madera maciza de haya. Disponible versión de reposapiés tapizado con base central de aluminio de 4 aspas y acabado aluminio pulido, blanco o negro o versión completamente tapizado.

Upholstery
Tapicería

The Alya collection supports following upholsteries of Andreu World Catalogue. For fabrics in our catalogue not specified in this box or customers own materials please contact our Customer Service Department.

La colección Alya admite las siguientes tapicerías del catálogo de Andreu World. Para las telas de nuestro catálogo no indicadas en este cuadro o telas cliente, consultar con nuestro Departamento Comercial.

Fabrics / Telas

- 1 Jacquard One
- Jacquard Three
- Citadel
- Sand
- Era
- Gravity
- Rivet
- Urban
- Reel One (in/out)
- Spin One
- Spin Two
- Spin Three
- Spin Four
- Spin Five

- 3 Jacquard Four
- Medley
- Revive 1
- Natte
- Main Line Flax
- Loom Two (in/out)
- Mezzo
- Reel two (in/out)
- Jacquard Five

- 4 Jacquard 4 Special
- Nexus
- Field 2
- Heritage
- Savane
- Loom Three
- Loom Four
- Cura
- Oceanic
- Reel Three (in/out)
- Reel Four (in/out)
- Reflect
- Spin Six

- 5 Silk
- Synergy
- Step
- Step Melange
- Blazer
- Melange Nap
- Chili
- Noma
- Re-wool

- 6 Go check
- Swing
- Chartres
- Zori
- Patio
- Tack Two (in/out)
- Tack Three (in/out)

- 7 Canvas 2
- Select
- Clara 2
- Tack Five (in/out)
- Hero 2

- 8 Capture
- Fiord 2
- Tonus 4
- Divina 3
- Lopi
- Domino
- Atrium
- 9 Divina MD
- Divina Melange 3
- Hallingdal 65
- Steelcut Trio 3
- Tack Four (in/out)

- 11 Arda
- Ecriture
- Zero

Faux Leather / Ecopiel

- 1 Valencia
- 2 Silvertex
- 3 Maglia
- 4 Dolce
- 8 Ultraleather
- 9 Brisa
- Brisa Distressed
- Fresco
- Ultraleather Pro
- Promessa
- 10 Tottori
- Coast (in/out)
- 11 Reef Pro
- Volar Bio

Leather / Piel

- L1 High grade cow leather.
- Piel de vaca de 1ª categoría.
- L3 Polished full grain leather.
- Plena flor pulida.
- L6 Aniline leather batique-effect.
- Scandinavian cattle.
- Piel anilina efecto batique.
- Ganado escandinavo.

Wood finish Beech
Acabado madera Haya

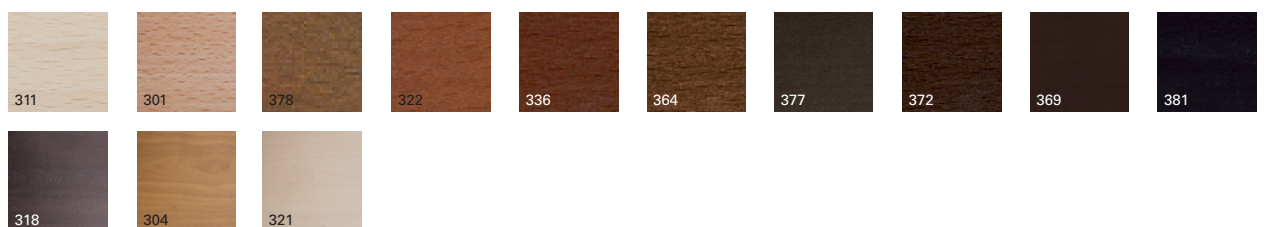

Premium finish and wood lacquers
Acabado premium y lacas madera



Eco Thermo-polymer finish
Acabado de Termo-polímero Eco

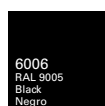

Aluminum finish
Acabado aluminio



Certificates
Certificados

Fireproof polyurethane foam
Espuma de poliuretano ignifuga

UNE EN 1021:2006
BS 5852 part 2 crib 5
UNI 9175 Classe 1 IM
BKZ 5.2
California TB 117:2013
California TB 133*

*Contact our Customer Department
*Consultar con nuestro Departamento Comercial

Quality - Resistance
Calidad - Resistencia

UNE EN 16139:2013

Intellectual property Propiedad intelectual

All our collections are protected by international industrial design registries, designs patents, copyrights and intellectual Property laws. Unauthorized use of AW International Property is a criminal offence and can lead to prosecution. Todas nuestras colecciones están protegidas por registros de diseño industrial, diseño de patente, copyright y derechos de propiedad intelectual todo el mundo. El uso no autorizado de los diseños y propiedad intelectual de AW supone un delito que puede ser sometido a acción judicial.



BU1520

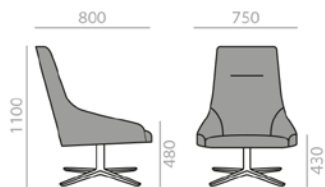

High back lounge chair with upholstered seat and backrest, and a four star aluminum central swivel base, self-return system and finished in polished aluminum, white or black. Optional tilting mechanism.

Butaca de respaldo alto con asiento y respaldo tapizado y base central giratoria de 4 aspas de aluminio con sistema de retorno y aca ado aluminio pulido, blanco o negro. Opción de sistema basculante.

	COM cm. per unit	COL m2
1 units	300	5,75
10 units or more	300	

0,78 m3
21,8 kg
x1

COM	COL	1	2	3	4	5	6	7	8	9	10	11	L1	L2	L3	L6
€ 1.438	1.474	1.519	1.555	1.585	1.634	1.684	1.732	1.781	1.831	1.880	1.928	1.978	2.024	2.221	2.579	3.525

Tilting mechanism upcharge
Incremento por sistema basculante | 42 |

Satellite auxiliary table upcharge
Incremento mesa auxiliar satélite | 150 |

BU1538

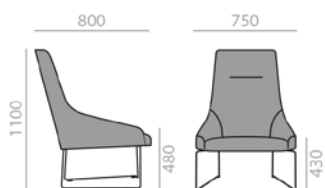

High back lounge chair with upholstered seat and backrest, steel sled base finished in polished chrome, white or black.

Butaca de respaldo alto con asiento y respaldo tapizado y base de patín de acero en acabado cromo brillo, blanco o negro.

	COM cm. per unit	COL m2
1 units	300	5,75
10 units or more	300	

0,78 m3
23,2 kg
x1

COM	COL	1	2	3	4	5	6	7	8	9	10	11	L1	L2	L3	L6
€ 1.004	1.033	1.070	1.099	1.123	1.162	1.202	1.241	1.285	1.331	1.378	1.422	1.468	1.512	1.677	1.982	2.792

BU1521

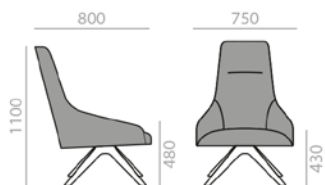

High back lounge chair with upholstered seat and backrest, and a fourstar solid beech wood central swivel base and self-return syste .

Butaca de respaldo alto con asiento y respaldo tapizado y base central giratoria de 4 aspas de madera maciza de haya con sistema de eterno.

	COM cm. per unit	COL m2
1 units	300	5,75
10 units or more	300	

0,78 m3
21 kg
x1

COM	COL	1	2	3	4	5	6	7	8	9	10	11	L1	L2	L3	L6
€ 1.443	1.475	1.516	1.550	1.577	1.628	1.677	1.729	1.779	1.829	1.879	1.931	1.981	2.025	2.208	2.539	3.427

SERIE 600 Matte lacquered and premium upcharge
Incremento por lacado mate y premium | 24 |

SERIE 800 Bright lacquered upcharge
Incremento por lacado brillo | 35 |

Satellite auxiliary table upcharge
Incremento mesa auxiliar satélite | 150 |

BU1522

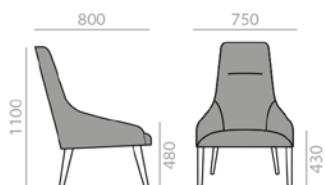

High back lounge chair with upholstered seat and backrest and a 4-legs beech wood base.

Butaca de respaldo alto con asiento y respaldo tapizado y base de 4 patas de madera maciza de haya.

	COM cm. per unit	COL m2
1 units	300	5,75
10 units or more	300	

0,78 m3
21,7 kg
x1

COM	COL	1	2	3	4	5	6	7	8	9	10	11	L1	L2	L3	L6
€ 1.109	1.141	1.181	1.214	1.243	1.294	1.342	1.392	1.442	1.491	1.540	1.590	1.640	1.683	1.862	2.188	3.055

SERIE 600 Matte lacquered and premium upcharge
Incremento por lacado mate y premium | 24 |

SERIE 800 Bright lacquered upcharge
Incremento por lacado brillo | 35 |



Measures +- 5 mm.
Medidas +- 5 mm.

BU1523

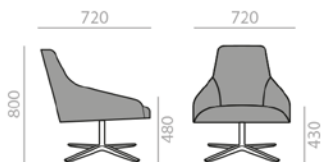

Low back lounge chair with upholstered seat and backrest, and a fourstar aluminum central swivel base, self-return system and available in polished aluminum, white or black. Optional tilting mechanism.

Butaca de respaldo bajo con asiento y respaldo tapizado y base central giratoria de 4 aspas de aluminio con sistema de retorno y acabado aluminio pulido, blanco o negro. Opción de sistema basculante.

	COM cm. per unit	COL m2
1 units	250	5
10 units or more	250	

0,46 m3
 22 kg
 x1

€	COM	COL	1	2	3	4	5	6	7	8	9	10	11	L1	L2	L3	L6
€	1.175	1.205	1.241	1.270	1.294	1.333	1.374	1.413	1.452	1.492	1.532	1.572	1.611	1.646	1.798	2.084	2.835

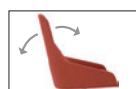

Tilting mechanism upcharge
 Incremento por sistema basculante

| 42 |



Satellite auxiliary table upcharge
 Incremento mesa auxiliar satélite

| 150 |

BU1539

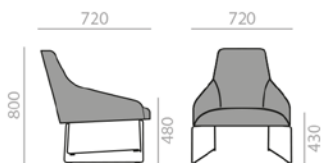

Low back lounge chair with upholstered seat and backrest, steel sled base finished in polished chrome, white or black.

Butaca de respaldo bajo con asiento y respaldo tapizado y base de patín de acero en acabado cromo brillo, blanco o negro.

	COM cm. per unit	COL m2
1 units	250	5
10 units or more	250	

0,46 m3
 23,5 kg
 x1

€	COM	COL	1	2	3	4	5	6	7	8	9	10	11	L1	L2	L3	L6
€	825	849	879	903	929	967	1.006	1.045	1.085	1.124	1.162	1.200	1.239	1.274	1.414	1.669	2.345

BU1524

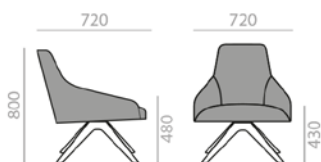

Low back lounge chair with upholstered seat and backrest, and a fourstar solid beech wood central swivel base with self-return system.

Butaca de respaldo bajo con asiento y respaldo tapizado y base central giratoria de 4 aspas de madera maciza de haya con sistema de retorno.

	COM cm. per unit	COL m2
1 units	250	5
10 units or more	250	

0,46 m3
 19,1 kg
 x1

€	COM	COL	1	2	3	4	5	6	7	8	9	10	11	L1	L2	L3	L6
€	1.289	1.318	1.353	1.382	1.405	1.443	1.482	1.521	1.559	1.598	1.635	1.675	1.712	1.747	1.889	2.162	2.896



Matte lacquered and premium upcharge
 Incremento por lacado mate y premium

| 24 |



Bright lacquered upcharge
 Incremento por lacado brillo

| 35 |



Satellite auxiliary table upcharge
 Incremento mesa auxiliar satélite

| 150 |

BU1525

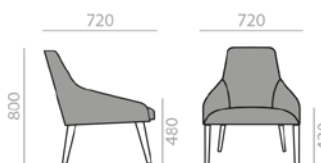

Low back lounge chair with upholstered seat and backrest and a 4 beech wood legs.

Butaca de respaldo bajo con asiento y respaldo tapizado y base de cuatro patas de madera maciza de haya.

	COM cm. per unit	COL m2
1 units	250	5
10 units or more	250	

0,46 m3
 19,8 kg
 x1

€	COM	COL	1	2	3	4	5	6	7	8	9	10	11	L1	L2	L3	L6
€	964	992	1.027	1.056	1.077	1.116	1.154	1.192	1.230	1.269	1.306	1.344	1.382	1.419	1.570	1.845	2.571



Matte lacquered and premium upcharge
 Incremento por lacado mate y premium

| 24 |



Bright lacquered upcharge
 Incremento por lacado brillo

| 35 |



Haya
 Beech

Measures +- 5 mm.
 Medidas +- 5 mm.

BU1530

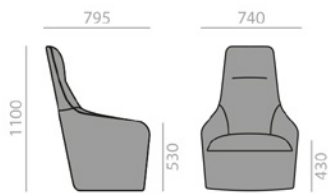

High back lounge chair fully upholstered to the floor. Optional swivel base with self-return system.

Butaca de respaldo alto con asiento y respaldo tapizado hasta abajo. Opción de base giratoria con sistema de retorno.

	COM cm. per unit	COL m2
1 units	405	7,5
10 units or more	405	

0,78 m3
 23,8 kg
 x1

COM	COL	1	2	3	4	5	6	7	8	9	10	11	L1	L2	L3	L6
€ 1.156	1.200	1.254	1.298	1.336	1.397	1.459	1.522	1.586	1.645	1.708	1.771	1.833	1.888	2.114	2.527	3.632

Swivel base upcharge
 Incremento por base giratoria | 191 |

SO1532



Armchair with a 4-star aluminum swivel base, with self-return system, and finished in polished aluminum, white or black. Upholstered seat and backrest. Optional tilting mechanism.

Sillón con asiento y respaldo tapizado y base central giratoria de 4 aspas de aluminio con sistema de retorno y acabado aluminio pulido, blanco o negro. Opción de sistema basculante.

	COM cm. per unit	COL m2
1 units	180	3,5
10 units or more	180	

0,39 m3
 18,5 kg
 x1

COM	COL	1	2	3	4	5	6	7	8	9	10	11	L1	L2	L3	L6
€ 802	820	842	860	874	898	922	947	970	997	1.026	1.053	1.083	1.109	1.213	1.402	1.902

Tilting mechanism upcharge
 Incremento por sistema basculante | 42 |

SO1533

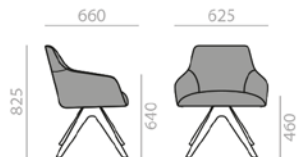

Armchair with solid beech wood central swivel base and upholstered seat and backrest.

Sillón con asiento y respaldo tapizado y base central giratoria de 4 aspas de madera maciza de haya.

	COM cm. per unit	COL m2
1 units	180	3,5
10 units or more	180	

0,39 m3
 13,7 kg
 x1

COM	COL	1	2	3	4	5	6	7	8	9	10	11	L1	L2	L3	L6
€ 805	822	842	859	873	899	925	952	976	1.003	1.029	1.054	1.081	1.105	1.197	1.373	1.841

SERIE 600 Matte lacquered and premium upcharge
 Incremento por lacado mate y premium | 26 |

SERIE 800 Bright lacquered upcharge
 Incremento por lacado brillo | 36 |

SO1534

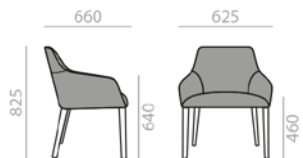

Armchair with upholstered seat and backrest and 4 solid beech wood legs.

Sillón con asiento y respaldo tapizado y base de 4 patas de madera maciza de haya.

	COM cm. per unit	COL m2
1 units	180	3,5
10 units or more	180	

0,35 m3
 14,3 kg
 x1

COM	COL	1	2	3	4	5	6	7	8	9	10	11	L1	L2	L3	L6
€ 601	618	640	658	672	695	719	744	767	791	814	839	863	887	980	1.152	1.607

SERIE 600 Matte lacquered and premium upcharge
 Incremento por lacado mate y premium | 26 |

SERIE 800 Bright lacquered upcharge
 Incremento por lacado brillo | 36 |



Measures +- 5 mm.
 Medidas +- 5 mm.

SO1535

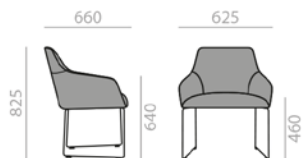

Armchair with upholstered seat and backrest, steel sled base finished in polished chrome, white or black.

Sillón con asiento y respaldo tapizado y base de patín de acero en acabado cromo brillo, blanco o negro.

	COM cm. per unit	COL m2
1 units	180	3,5
10 units or more	180	

0,36 m3
 15,5 kg
 x1

€	COM	COL	1	2	3	4	5	6	7	8	9	10	11	L1	L2	L3	L6
	575	591	611	628	644	672	700	724	751	778	805	831	859	883	979	1.154	1.628

SO1536

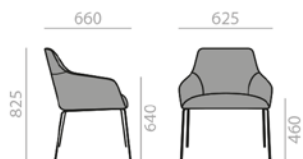

Armchair with upholstered seat and backrest and 4 steel legs finished in polished chrome, white or black.

Sillón con asiento y respaldo tapizado y base de 4 patas de acero en acabado cromo brillo, blanco o negro.

	COM cm. per unit	COL m2
1 units	180	3,5
10 units or more	180	

0,36 m3
 13,4 kg
 x1

€	COM	COL	1	2	3	4	5	6	7	8	9	10	11	L1	L2	L3	L6
	608	625	648	667	686	717	746	775	805	835	865	894	924	951	1.057	1.254	1.772

SO1537



Armchair with upholstered seat and backrest and aluminum central base with 5 casters, swivel and pneumatic height adjustment. Available in polished aluminum, white or black. Height ranges: seat 420-540 mm./arms 600-720 mm.

Sillón con asiento y respaldo tapizado y base central giratoria de aluminio de 5 ruedas, regulable en altura y acabado aluminio pulido, blanco o negro. Rangos de altura: asiento 420-540 mm./brazos 600-720 mm.

	COM cm. per unit	COL m2
1 units	180	3,5
10 units or more	180	

0,35 m3
 15,1 kg
 x1

€	COM	COL	1	2	3	4	5	6	7	8	9	10	11	L1	L2	L3	L6
	827	848	871	892	907	933	959	985	1.012	1.038	1.064	1.090	1.116	1.140	1.237	1.424	1.923

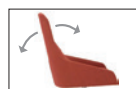

Tilting mechanism upcharge
 Incremento por sistema basculante

| 42 |

SO1556

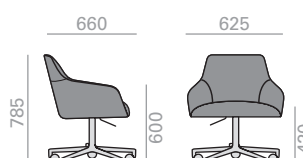

Armchair with upholstered seat and backrest and Eco thermo-polymer central base with 5 casters, swivel and pneumatic height adjustment, finished in black. Additional options include: tilting mechanism. Height ranges: seat 420-540 mm./arms 600-720 mm.

Sillón con asiento y respaldo tapizado y base central giratoria de termopolímero Eco de 5 ruedas, regulable en altura y acabado negro Opción de sistema basculante. Rangos de altura: asiento 420-540 mm./brazos 600-720 mm.

	COM cm. per unit	COL m2
1 units	180	3,5
10 units or more	180	

0,39 m3
 14,1 kg
 x1

€	COM	COL	1	2	3	4	5	6	7	8	9	10	11	L1	L2	L3	L6
	715	734	757	777	792	818	843	869	897	928	956	987	1.014	1.042	1.148	1.342	1.856

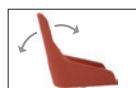

Tilting mechanism upcharge
 Incremento por sistema basculante

| 42 |

SI1550

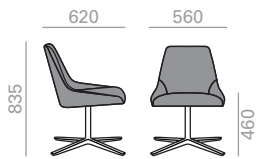

Chair with a 4-star aluminum swivel base, with self-return system, and finished in polished aluminum, white or black. Upholstered seat and backrest. Optional tilting mechanism.

Silla con asiento y respaldo tapizado y base central giratoria de 4 aspas de aluminio con sistema de retorno y acabado aluminio pulido, blanco o negro. Opción de sistema basculante.

	COM cm. per unit	COL m2
1 units	160	3,25
10 units or more	160	

0,33 m3
14,7 kg
x1

€	COM	COL	1	2	3	4	5	6	7	8	9	10	11	L1	L2	L3	L6
	669	682	699	713	724	743	761	780	798	818	836	857	877	897	975	1.117	1.503

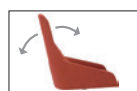

Tilting mechanism upcharge
Incremento por sistema basculante

| 42 |

SI1551



Chair with solid beech wood central swivel base and upholstered seat and backrest.

Silla con asiento y respaldo tapizado y base central giratoria de 4 aspas de madera maciza de haya.

	COM cm. per unit	COL m2
1 units	160	3,25
10 units or more	160	

0,36 m3
12,9 kg
x1

€	COM	COL	1	2	3	4	5	6	7	8	9	10	11	L1	L2	L3	L6
	676	691	707	722	732	750	768	787	804	823	841	859	877	893	991	1.125	1.479



Matte lacquered and premium upcharge
Incremento por lacado mate y premium

| 26 |



Bright lacquered upcharge
Incremento por lacado brillo

| 36 |

SI1552

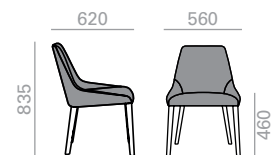

Chair with upholstered seat and backrest and 4 solid beech wood legs.

Silla con asiento y respaldo tapizado y base de 4 patas de madera maciza de haya.

	COM cm. per unit	COL m2
1 units	160	3,25
10 units or more	160	

0,33 m3
13,1 kg
x1

€	COM	COL	1	2	3	4	5	6	7	8	9	10	11	L1	L2	L3	L6
	488	502	518	533	542	561	580	597	616	634	653	671	689	705	775	902	1.241



Matte lacquered and premium upcharge
Incremento por lacado mate y premium

| 26 |



Bright lacquered upcharge
Incremento por lacado brillo

| 36 |

SI1553

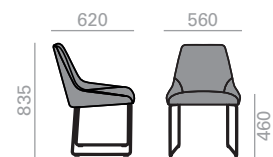

Chair with upholstered seat and backrest, steel sled base finished in polished chrome, white or black.

Silla con asiento y respaldo tapizado y base de patín de acero en acabado cromo brillo, blanco o negro.

	COM cm. per unit	COL m2
1 units	160	3,25
10 units or more	160	

0,32 m3
13,4 kg
x1

€	COM	COL	1	2	3	4	5	6	7	8	9	10	11	L1	L2	L3	L6
	473	487	503	516	527	545	564	582	602	623	642	662	683	702	777	911	1.268



Haya
Beech

Measures +- 5 mm.
Medidas +- 5 mm.

SI1554

Chair with upholstered seat and backrest and 4 steel legs finished in polished chrome, white or black.

Silla con asiento y respaldo tapizado y base de 4 patas de acero en acabado cromo brillo, blanco o negro.

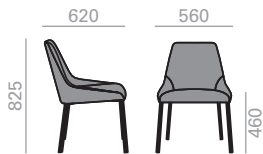

	COM cm. per unit	COL m2
1 units	160	3,25
10 units or more	160	

0,33 m3
 12,6 kg
 x1

COM	COL	1	2	3	4	5	6	7	8	9	10	11	L1	L2	L3	L6
€ 502	516	532	546	557	576	594	612	632	654	676	696	716	737	836	979	1.360

SI1555

Chair with upholstered seat and backrest and aluminum central base with 5 casters, swivel and pneumatic height adjustment. Available in polished aluminum, white or black. Optional tilting mechanism. Seat height range: 420-540 mm.

Silla con asiento y respaldo tapizado y base central giratoria de aluminio de 5 ruedas, regulable en altura y acabado aluminio pulido, blanco o negro. Opción de sistema basculante. Rango de altura de asiento: 420-540 mm.



	COM cm. per unit	COL m2
1 units	160	3,25
10 units or more	160	

0,33 m3
 14,3 kg
 x1

COM	COL	1	2	3	4	5	6	7	8	9	10	11	L1	L2	L3	L6
€ 728	745	765	782	795	816	838	859	882	903	926	947	969	989	1.068	1.212	1.614



Tilting mechanism upcharge
 Incremento por sistema basculante

| 42 |

SI1557

Chair with upholstered seat and Eco thermo-polymer central base with 5 casters, swivel and pneumatic height adjustment, finished in black. Additional options include: tilting mechanism. Seat height range: 420-540 mm.

Silla con asiento y respaldo tapizado y base central giratoria de termopolímero Eco de 5 ruedas, regulable en altura y acabado negro. Opción de sistema basculante. Rango de altura de asiento: 420-540 mm.



	COM cm. per unit	COL m2
1 units	160	3,25
10 units or more	160	

0,33 m3
 13,3 kg
 x1

COM	COL	1	2	3	4	5	6	7	8	9	10	11	L1	L2	L3	L6
€ 606	620	639	655	667	687	707	729	750	770	790	812	835	856	935	1.084	1.475



Tilting mechanism upcharge
 Incremento por sistema basculante

| 42 |

BQ1590

Barstool with upholstered shell and 4 steel legs and swivel base and finished in polished chrome, white or black.

Banqueta alta con carcasa tapizada y base giratoria de 4 patas de acero y acabado cromo brillo, blanco o negro.



	COM cm. per unit	COL m2
1 units	110	2,25
10 units or more	110	

0,28 m3
 13,9 kg
 x1

COM	COL	1	2	3	4	5	6	7	8	9	10	11	L1	L2	L3	L6
€ 576	586	599	610	619	633	648	662	676	691	705	719	734	747	798	893	1.174

BQ1591



Counter stool with upholstered shell and 4 steel legs and swivel base and finished in polished chrome, white or black.

Banqueta baja con carcasa tapizada y base giratoria de 4 patas de acero y acabado cromo brillo, blanco o negro.

	COM cm. per unit	COL m2
1 units	110	2,25
10 units or more	110	

0,22 m3
13,4 kg
x1

COM	COL	1	2	3	4	5	6	7	8	9	10	11	L1	L2	L3	L6
€ 576	586	599	610	619	633	648	662	676	691	705	719	734	747	798	893	1.174

BQ1592

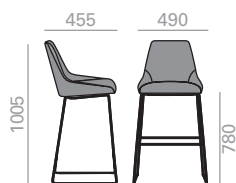

Barstool with upholstered shell and steel sled base finished in polished chrome, white or black.

Banqueta alta con carcasa tapizada y base de patín de acero en acabado cromo brillo, blanco o negro.

	COM cm. per unit	COL m2
1 units	110	2,25
10 units or more	110	

0,31 m3
15,1 kg
x1

COM	COL	1	2	3	4	5	6	7	8	9	10	11	L1	L2	L3	L6
€ 448	457	468	477	485	497	511	523	536	548	575	592	600	605	669	742	1.058

BQ1593

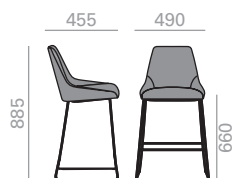

Counter stool with upholstered shell and steel sled base finished in polished chrome, white or black.

Banqueta baja con carcasa tapizada y base de patín de acero en acabado cromo brillo, blanco o negro.

	COM cm. per unit	COL m2
1 units	110	2,25
10 units or more	110	

0,26 m3
14,7 kg
x1

COM	COL	1	2	3	4	5	6	7	8	9	10	11	L1	L2	L3	L6
€ 448	457	468	477	485	497	511	523	536	548	575	592	600	605	669	742	1.058

BQ1594



Barstool with upholstered shell and 4-legs solid beech wood.

Banqueta alta con carcasa tapizada y base de 4 patas de madera maciza de haya.

	COM cm. per unit	COL m2
1 units	110	2,25
10 units or more	110	

0,31 m3
17 kg
x1

COM	COL	1	2	3	4	5	6	7	8	9	10	11	L1	L2	L3	L6
€ 552	561	572	581	589	602	615	627	640	653	666	692	698	707	769	837	1.174

SERIE 600
Matte lacquered and premium upcharge
Incremento por lacado mate y premium | 47 |

SERIE 800
Bright lacquered upcharge
Incremento por lacado brillo | 69 |



Haya
Beech



Measures +- 5 mm.
Medidas +- 5 mm.

BQ1595

 Counter stool with upholstered shell and 4-legs solid beech wood.
Banqueta baja con carcasa tapizada y base de 4 patas de madera maciza de haya.



	COM cm. per unit	COL m2
1 units	110	2,25
10 units or more	110	

 0,25 m3
 15,6 kg
 x1

COM	COL	1	2	3	4	5	6	7	8	9	10	11	L1	L2	L3	L6
€ 552	561	572	581	589	602	615	627	640	653	666	692	698	707	769	837	1.174

SERIE 600
Matte lacquered and premium upcharge
Incremento por lacado mate y premium | 47 |



SERIE 800
Bright lacquered upcharge
Incremento por lacado brillo | 69 |

BQ1558

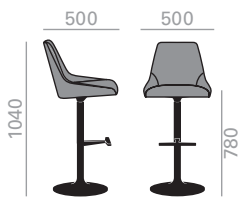
Barstool with upholstered seat and back and injection swivel central base finished in polished aluminum, white or black.
Banqueta alta con asiento y respaldo tapizado y base central giratoria de inyección de aluminio en acabado aluminio pulido, blanco o negro.



	COM cm. per unit	COL m2
1 units	110	2,25
10 units or more	110	

 0,28 m3
 12,9 kg
 x1



COM	COL	1	2	3	4	5	6	7	8	9	10	11	L1	L2	L3	L6
€ 594	604	616	627	635	649	662	676	689	703	716	746	751	760	828	900	1.202

BQ1559

Counter stool with upholstered seat and back and injection swivel central base finished in polished aluminum, white or black.
Banqueta baja con asiento y respaldo tapizado y base central giratoria de inyección de aluminio en acabado aluminio pulido, blanco o negro.



	COM cm. per unit	COL m2
1 units	110	2,25
10 units or more	110	

 0,26 m3
 12,4 kg
 x1



COM	COL	1	2	3	4	5	6	7	8	9	10	11	L1	L2	L3	L6
€ 594	604	616	627	635	649	662	676	689	703	716	746	751	760	828	900	1.202

BQ1560

Barstool with upholstered seat and back and injection swivel central base, adjustable height and finished in polished aluminum, white or black. Seat height range: 650-780 mm.
Banqueta alta con asiento y respaldo tapizado y base central giratoria de inyección de aluminio, regulable en altura y acabado aluminio pulido, blanco o negro. Rango de altura de asiento: 650-780 mm.



	COM cm. per unit	COL m2
1 units	110	2,25
10 units or more	110	

 0,25 m3
 12,4 kg
 x1

COM	COL	1	2	3	4	5	6	7	8	9	10	11	L1	L2	L3	L6
€ 599	610	622	633	641	655	668	682	695	710	724	751	757	766	834	907	1.207

RS1527

Upholstered ottoman with four star central aluminum base and finished in polished aluminum, white or black.

Reposapiés tapizado con base central de aluminio de 4 aspas y acabado aluminio pulido, blanco o negro.



	COM cm. per unit	COL m2
1 units	70	1,5
10 units or more	70	

0,14 m3
 7,7 kg
 x1

€	COM	COL	1	2	3	4	5	6	7	8	9	10	11	L1	L2	L3	L6
	407	414	424	432	438	449	460	469	480	490	501	512	522	532	572	646	843

RS1528

Fully upholstered ottoman.

Reposapiés completamente tapizado.

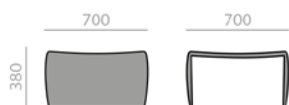

	COM cm. per unit	COL m2
1 units	230	4,5
10 units or more	215	

0,24 m3
 14,8 kg
 x1

€	COM	COL	1	2	3	4	5	6	7	8	9	10	11	L1	L2	L3	L6
	553	577	606	631	650	681	714	745	778	809	842	875	906	935	1.057	1.279	1.870

RS1529

Fully upholstered ottoman.

Reposapiés completamente tapizado.

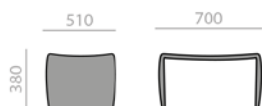



	COM cm. per unit	COL m2
1 units	165	3,25
10 units or more	150	

0,17 m3
 12 kg
 x1

€	COM	COL	1	2	3	4	5	6	7	8	9	10	11	L1	L2	L3	L6
	523	538	558	575	587	608	629	650	674	698	722	747	774	796	885	1.049	1.482

Glides for 4 star aluminum central base. Tacos para base central de aluminio de 4 aspas.

Use/Usó	Reference/Referencia		Material/Material	Price/Precio	
Hard floors. Suelos duros.	TS0544		Plastic (PE). Plástico (PE).	0 €	Standard. Estándar.
Wooden and delicated floors. Suelos de madera y delicados.	TS0556		Plastic (PE) with felt. Plástico (PE) con fieltro.	3 €	Set of 4 glides. Juego de 4 tacos.
Mats/carpet floors. Suelos de moqueta/ alfombra.	TS0557		No glide. Sin taco.	0 €	

The indicated price is for glides placed on chairs. To order loose parts, please ask to our Sales Department.

El precio indicado en Tarifa es para tacos colocados en las sillas. Para pedidos de tacos sueltos de repuesto, consultar con el Departamento Comercial.

Glides for sled bases/cantilever. Tacos para bases de patín/cantilever.

Use/Usó	Reference/Referencia		Material/Material	Price/Precio	
Hard floors. Suelos duros.	TS0531		Plastic (PE). Plástico (PE).	0 €	Standard. Estándar.
Wooden and delicated floors. Suelos de madera y delicados.	TS0538		Plastic (PE) with felt. Plástico (PE) con fieltro.	6 €	Set of 4 glides. Juego de 4 tacos.
Mats/carpet floors. Suelos de moqueta/ alfombra.	TS0537		No glide. Sin taco.	0 €	

Glides for 4 steel legs with swivel base. Tacos para base giratoria de 4 patas de acero.

Use/Usó	Reference/Referencia		Material/Material	Price/Precio	
Hard floors and mats/ carpet floors. Suelos duros y moqueta/alfombra.	TS0416		Plastic (PE). Plástico (PE).	0 €	Standard. Estándar.
Wooden and delicated floors. Suelos de madera y delicados.	TS0417		Plastic (PE) with felt. Plástico (PE) con fieltro.	12 €	Set of 4 glides. Juego de 4 tacos.

For wooden legs. Para bases de madera.



Optional glides on page 482.

Opciones de tacos deslizantes en página 482.



Description
Descripción

Upholstered armchairs with flexible foam seat and back. Offered in two different back heights. Available with 4 legs or sled steel base finished in polished chrome, white or black, 4 legs or central swivel base, in solid beech wood, and aluminum central base with 5 casters, swivel and pneumatic height adjustment, finished in polished aluminum, white or black. Additional options include: tilting mechanism (according to references) and back finished in walnut veneer.

Sillones tapizados con asiento y respaldo en espuma flexible. Se ofrecen con dos alturas diferentes de respaldo. Disponibles con base de 4 patas o patín de acero en acabado cromo brillo, blanco o negro, base de 4 patas o central giratoria de 4 aspas, en madera maciza de haya, y base central giratoria de aluminio de 5 ruedas, regulable en altura y acabado aluminio pulido, blanco o negro. Opciones disponibles: sistema basculante (según referencias) y respaldo en madera de nogal.

Upholstery
Tapicería

The Alya Executive collection supports following upholsteries of Andreu World Catalogue. For fabrics in our catalogue not specified in this box or customers own materials please contact our Customer Service Department.

La colección Alya Executive admite las siguientes tapicerías del catálogo de Andreu World. Para las telas de nuestro catálogo no indicadas en este cuadro o telas cliente, consultar con nuestro Departamento Comercial.

Fabrics / Telas

- 1 Jacquard One
- Jacquard Three
- Citadel
- Sand
- Era
- Gravity
- Rivet
- Urban
- Reel One (in/out)
- Spin One
- Spin Two
- Spin Three
- Spin Four
- Spin Five
- 2 Jacquard Two
- Solid & Stripes
- Loom One
- Circular One Pure Eco
- Tack One (in/out)

- 3 Jacquard Four
- Medley
- Revive 1
- Natte
- Main Line Flax
- Loom Two (in/out)
- Mezzo
- Reel two (in/out)
- Jacquard Five

- 4 Jacquard 4 Special
- Nexus
- Field 2
- Heritage
- Savane
- Loom Three
- Loom Four
- Cura
- Oceanic
- Reel Three (in/out)
- Reel Four (in/out)
- Reflect
- Spin Six

- 5 Silk
- Synergy
- Step
- Step Melange
- Blazer
- Melange Nap
- Chili
- Noma
- Re-wool

- 6 Go check
- Swing
- Chartres
- Zori
- Patio
- Tack Two (in/out)
- Tack Three (in/out)

- 7 Canvas 2
- Select
- Clara 2
- Tack Five (in/out)
- Hero 2

- 8 Capture
- Fiord 2
- Tonus 4
- Divina 3
- Lopi
- Domino
- Atrium
- 9 Divina MD
- Divina Melange 3
- Hallingdal 65
- Steelcut Trio 3
- Tack Four (in/out)

- 11 Arda
- Ecriture
- Zero

Faux Leather / Ecopiel

- 1 Valencia
- 2 Silvertex
- 3 Maglia
- 4 Dolce
- 8 Ultraleather
- 9 Brisa
- Brisa Distressed
- Fresco
- Ultraleather Pro
- Promessa
- 10 Tottori
- Coast (in/out)
- 11 Reef Pro
- Volar Bio

Leather / Piel

- L1 High grade cow leather.
- Piel de vaca de 1ª categoría.
- L3 Polished full grain leather.
- Plena flor pulida.
- L6 Aniline leather batique-effect.
- Scandinavian cattle.
- Piel anilina efecto batique.
- Ganado escandinavo.

Wood finish Walnut
Acabado madera
Nogal

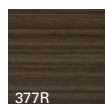

Eco Thermo-polymer finish
Acabado de Termo-polímero Eco

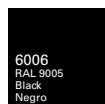

Aluminum finish
Acabado aluminio



Certificates
Certificados

Fireproof polyurethane foam

Espuma de poliuretano ignifuga

UNE EN 1021:2006
BS 5852 part 2 crib 5
UNI 9175 Classe 1 IM
BKZ 5.2
California TB 117:2013
California TB 133*

*Contact our Customer Department
*Consultar con nuestro Departamento Comercial

Quality - Resistance
Calidad - Resistencia

UNE EN 16139:2013

Intellectual property Propiedad intelectual

All our collections are protected by international industrial design registries, designs patents, copyrights and intellectual Property laws. Unauthorized use of AW International Property is a criminal offence and can lead to prosecution.

Todas nuestras colecciones están protegidas por registros de diseño industrial, diseño de patente, copyright y derechos de propiedad intelectual todo el mundo. El uso no autorizado de los diseños y propiedad intelectual de AW supone un delito que puede ser sometido a acción judicial.



SO1473

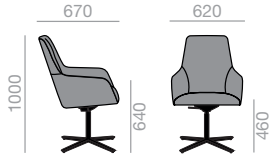

Intermediate back armchair with upholstered shell and aluminum swivel 4- star base with self-return system and finished in polished aluminum white or black. Additional options include: tilting mechanism and back finished in walnut veneer.

Sillón de respaldo intermedio con carcasa tapizada y base central giratoria de aluminio de 4 aspas con sistema de retorno en acabado aluminio pulido, blanco o negro. Opciones disponibles: sistema basculante y respaldo en madera de nogal.

COM cm. per unit	COL m2
------------------	--------

0,47 m3
19,4 kg
x1

Fully upholstered Carcasa tapizada		
1 units	195	4
10 units or more	195	

Walnut back Respaldo nogal		
1 units	150	3
10 units or more	150	

COM	COL	1	2	3	4	5	6	7	8	9	10	11	L1	L2	L3	L6	
€	1.020	1.042	1.069	1.091	1.110	1.140	1.170	1.199	1.229	1.259	1.289	1.319	1.349	1.374	1.482	1.678	2.198



SO1478

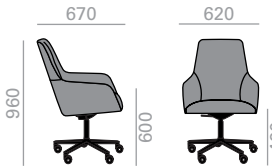

Intermediate back armchair with upholstered shell and aluminum central base with 5 casters, swivel and pneumatic height adjustmen. Available in polished aluminum, white or black. Additional options include: tilting mechanism and back finished in walnut veneer. Height ranges: seat 420-540 mm./arms 600-720 mm.

Sillón de respaldo intermedio con carcasa tapizada y base central giratoria de aluminio de 5 ruedas, regulable en altura y acabado aluminio pulido, blanco o negro. Opciones disponibles: sistema basculante y respaldo en madera de nogal. Rangos de altura: asiento 420-540 mm./brazos 600-720 mm.

COM cm. per unit	COL m2
------------------	--------

0,44 m3
19 kg
x1

Fully upholstered Carcasa tapizada		
1 units	195	4
10 units or more	195	

Walnut back Respaldo nogal		
1 units	150	3
10 units or more	150	

COM	COL	1	2	3	4	5	6	7	8	9	10	11	L1	L2	L3	L6	
€	976	1.000	1.028	1.052	1.069	1.100	1.132	1.162	1.193	1.224	1.254	1.286	1.317	1.344	1.456	1.660	2.197

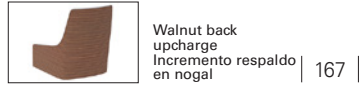

SO1471

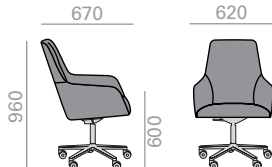

Intermediate back armchair with upholstered seat and back and Eco thermo-polymer central base with 5 casters, swivel and pneumatic height adjustment, finished in black. Additional options include: tilting mechanism and back finished in walnut veneer. Height ranges: seat 420-540 mm./arms 600-720 mm.

Sillón de respaldo intermedio con asiento y respaldo tapizado y base central giratoria de termopolímero Eco de 5 ruedas, regulable en altura y acabado negro. Opciones disponibles: sistema basculante y respaldo en madera de nogal. Rangos de altura: asiento 420-540 mm./brazos 600-720 mm.

COM cm. per unit	COL m2
------------------	--------

0,54 m3
18 kg
x1

Fully upholstered Carcasa tapizada		
1 units	195	4
10 units or more	195	

Walnut back Respaldo nogal		
1 units	150	3
10 units or more	150	

COM	COL	1	2	3	4	5	6	7	8	9	10	11	L1	L2	L3	L6	
€	847	870	896	919	936	965	994	1.023	1.052	1.081	1.110	1.140	1.169	1.195	1.301	1.493	2.034

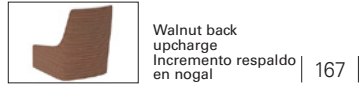

SO1491

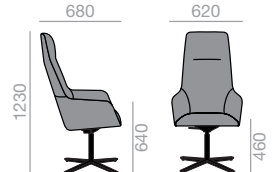

High back armchair with upholstered shell and aluminum swivel 4-star base with self-return system and finished in polished aluminum, white or black. Additional options include: tilting mechanism and back finished in walnut veneer.

Sillón de respaldo alto con carcasa tapizada y base central giratoria de aluminio de 4 aspas con sistema de retorno en acabado aluminio pulido, blanco o negro. Opciones disponibles: sistema basculante y respaldo en madera de nogal.

COM cm. per unit	COL m2
------------------	--------

0,66 m3
21,6 kg
x1

Fully upholstered Carcasa tapizada		
1 units	225	4,5
10 units or more	225	

Walnut back Respaldo nogal		
1 units	160	3,25
10 units or more	160	

COM	COL	1	2	3	4	5	6	7	8	9	10	11	L1	L2	L3	L6	
€	1.042	1.065	1.093	1.116	1.134	1.165	1.195	1.226	1.256	1.287	1.318	1.348	1.379	1.406	1.540	1.718	2.377

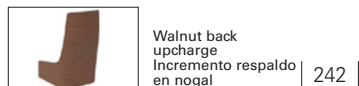

SO1496

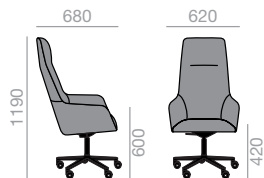

High back armchair with upholstered shell and aluminum central base with 5 casters, swivel and pneumatic height adjustment. Available in polished aluminum, white or black. Additional options include: tilting mechanism and back finished in walnut veneer. Height ranges: seat 420-540 mm./arms 600-720 mm.

Sillón de respaldo alto con carcasa tapizada y base central giratoria de aluminio de 5 ruedas, regulable en altura y acabado aluminio pulido, blanco o negro. Opciones disponibles: sistema basculante y respaldo en madera de nogal. Rangos de altura: asiento 420-540 mm./brazos 600-720 mm.

COM cm. per unit	COL m2
------------------	--------

0,66 m3
21,2 kg
x1

Fully upholstered Carcasa tapizada		4,5
1 units	225	
10 units or more	225	

Walnut back Respaldo nogal		3,25
1 units	160	
10 units or more	160	

COM	COL	1	2	3	4	5	6	7	8	9	10	11	L1	L2	L3	L6
€ 1.001	1.026	1.053	1.076	1.094	1.125	1.157	1.188	1.218	1.249	1.281	1.311	1.342	1.369	1.484	1.684	2.325

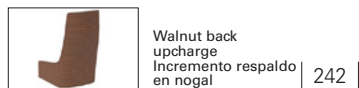

SO1472

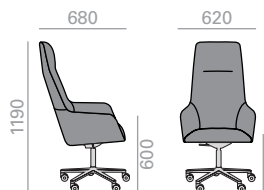

High back armchair with upholstered seat and back and Eco thermo-polymer central base with 5 casters, swivel and pneumatic height adjustment, finished in black. Additional options include: tilting mechanism and back finished in walnut veneer. Height ranges: seat 420-540 mm./arms 600-720 mm.

Sillón de respaldo alto con asiento y respaldo tapizado y base central giratoria de termopolímero Eco de 5 ruedas, regulable en altura y acabado negro. Opciones disponibles: sistema basculante y respaldo en madera de nogal. Rangos de altura: asiento 420-540 mm./brazos 600-720 mm.

COM cm. per unit	COL m2
------------------	--------

0,66 m3
20,2 kg
x1

Fully upholstered Carcasa tapizada		4,5
1 units	225	
10 units or more	225	

Walnut back Respaldo nogal		3,25
1 units	160	
10 units or more	160	

COM	COL	1	2	3	4	5	6	7	8	9	10	11	L1	L2	L3	L6
€ 899	922	949	972	990	1.021	1.051	1.081	1.112	1.142	1.173	1.203	1.239	1.270	1.402	1.636	2.263

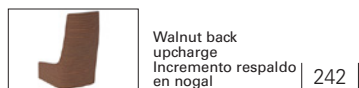

SO1479

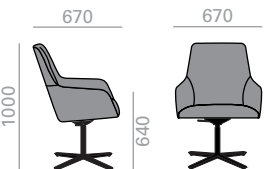

Wider version. Intermediate back armchair with upholstered seat and back and aluminum swivel 4-star base with self-return system and finished in polished aluminum, white or black. Additional options include: tilting mechanism and back finished in walnut veneer.

Versión ancha. Sillón de respaldo intermedio con carcasa tapizada y base central giratoria de aluminio de 4 aspas con sistema de retorno en acabado aluminio pulido, blanco o negro. Opciones disponibles: sistema basculante y respaldo en madera de nogal.

COM cm. per unit	COL m2
------------------	--------

0,49 m3
20,4 kg
x1

Fully upholstered Carcasa tapizada		4,5
1 units	215	
10 units or more	215	

Walnut back Respaldo nogal		3,5
1 units	165	
10 units or more	165	

COM	COL	1	2	3	4	5	6	7	8	9	10	11	L1	L2	L3	L6
€ 1.047	1.071	1.101	1.126	1.146	1.179	1.211	1.244	1.277	1.311	1.344	1.376	1.409	1.439	1.559	1.775	2.410

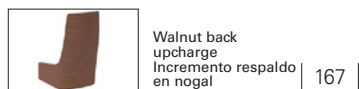

SO1480

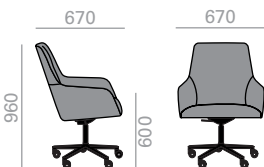

Wider version. Intermediate back armchair with upholstered seat and back and aluminum central base with 5 casters, swivel and pneumatic height adjustment. Available in polished aluminum, white or black. Additional options include: tilting mechanism and back finished in walnut veneer. Height ranges: seat 420-540 mm./arms 600-720 mm.

Versión ancha. Sillón de respaldo intermedio con asiento y respaldo tapizado y base central giratoria de aluminio de 5 ruedas, regulable en altura y acabado aluminio pulido, blanco o negro. Opciones disponibles: sistema basculante y respaldo en madera de nogal. Rangos de altura: asiento 420-540 mm./brazos 600-720 mm.

COM cm. per unit	COL m2
------------------	--------

0,53 m3
20 kg
x1

Fully upholstered Carcasa tapizada		4,5
1 units	215	
10 units or more	215	

Walnut back Respaldo nogal		3,5
1 units	165	
10 units or more	165	

COM	COL	1	2	3	4	5	6	7	8	9	10	11	L1	L2	L3	L6
€ 991	1.016	1.047	1.073	1.093	1.126	1.161	1.196	1.229	1.264	1.298	1.331	1.366	1.396	1.520	1.745	2.339

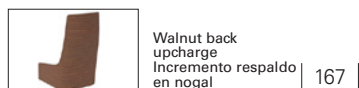

SO1481

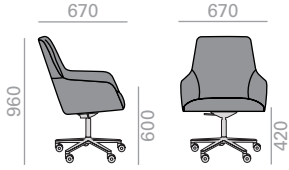

Wider version. Intermediate back armchair with upholstered seat and back and Eco thermo-polymer central base with 5 casters, swivel and pneumatic height adjustment, finished in black. Additional options include: tilting mechanism and back finished in walnut veneer. Height ranges: seat 420-540 mm./arms 600-720 mm.

Versión ancha. Sillón de respaldo intermedio con asiento y respaldo tapizado y base central giratoria de termopolímero Eco de 5 ruedas, regulable en altura y acabado negro. Opciones disponibles: sistema basculante y respaldo en madera de nogal. Rangos de altura: asiento 420-540 mm./brazos 600-720 mm.

COM cm. per unit	COL m2
------------------	--------

0,52 m3
19 kg
x1

Fully upholstered Carcasa tapizada		
1 units	215	4,5
10 units or more	215	

Walnut back Respaldo nogal		
1 units	165	3,5
10 units or more	165	

COM	COL	1	2	3	4	5	6	7	8	9	10	11	L1	L2	L3	L6
€ 862	886	915	939	957	990	1.022	1.054	1.086	1.117	1.151	1.182	1.214	1.243	1.357	1.569	2.126

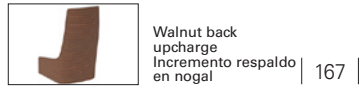

SO1482

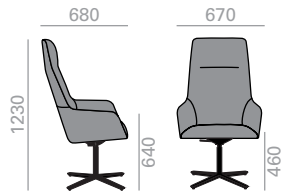

Wider version. High back armchair with upholstered seat and back and aluminum swivel 4-star base with self-return system and finished in polished aluminum, white or black. Additional options include: tilting mechanism and back finished in walnut veneer.

Versión ancha. Sillón de respaldo alto con asiento y respaldo tapizado y base central giratoria de aluminio de 4 aspas con sistema de retorno en acabado aluminio pulido, blanco o negro. Opciones disponibles: sistema basculante y respaldo en madera de nogal.

COM cm. per unit	COL m2
------------------	--------

0,7 m3
22,6 kg
x1

Fully upholstered Carcasa tapizada		
1 units	245	5
10 units or more	245	

Walnut back Respaldo nogal		
1 units	175	0
10 units or more	175	

COM	COL	1	2	3	4	5	6	7	8	9	10	11	L1	L2	L3	L6
€ 1.070	1.096	1.127	1.153	1.173	1.207	1.241	1.275	1.309	1.343	1.379	1.413	1.447	1.478	1.601	1.846	2.514

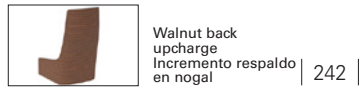

SO1483

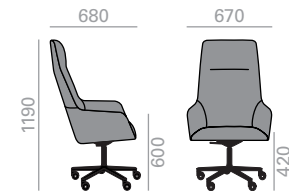

Wider version. High back armchair with upholstered seat and back and aluminum central base with 5 casters, swivel and pneumatic height adjustment. Available in polished aluminum, white or black. Additional options include: tilting mechanism and back finished in walnut veneer. Height ranges: seat 420-540 mm./arms 600-720 mm.

Versión ancha. Sillón de respaldo alto con asiento y respaldo tapizado y base central giratoria de aluminio de 5 ruedas, regulable en altura y acabado aluminio pulido, blanco o negro. Opciones disponibles: sistema basculante y respaldo en madera de nogal. Rangos de altura: asiento 420-540 mm./brazos 600-720 mm.

COM cm. per unit	COL m2
------------------	--------

0,68 m3
22,2 kg
x1

Fully upholstered Carcasa tapizada		
1 units	245	5
10 units or more	245	

Walnut back Respaldo nogal		
1 units	175	3,5
10 units or more	175	

COM	COL	1	2	3	4	5	6	7	8	9	10	11	L1	L2	L3	L6
€ 1.059	1.086	1.117	1.144	1.164	1.201	1.235	1.270	1.306	1.341	1.377	1.412	1.448	1.480	1.608	1.841	2.464

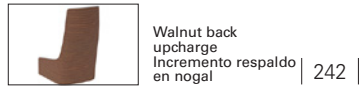

SO1484

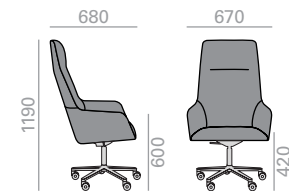

Wider version. High back armchair with upholstered seat and back and Eco thermo-polymer central base with 5 casters, swivel and pneumatic height adjustment, finished in black. Additional options include: tilting mechanism and back finished in walnut veneer. Height ranges: seat 420-540 mm./arms 600-720 mm.

Versión ancha. Sillón de respaldo alto con asiento y respaldo tapizado y base central giratoria de termopolímero Eco de 5 ruedas, regulable en altura y acabado negro. Opciones disponibles: sistema basculante y respaldo en madera de nogal. Rangos de altura: asiento 420-540 mm./brazos 600-720 mm.

COM cm. per unit	COL m2
------------------	--------

0,65 m3
21,2 kg
x1

Fully upholstered Carcasa tapizada		
1 units	245	5
10 units or more	245	

Walnut back Respaldo nogal		
1 units	175	3,5
10 units or more	175	

COM	COL	1	2	3	4	5	6	7	8	9	10	11	L1	L2	L3	L6
€ 909	935	965	991	1.010	1.043	1.078	1.111	1.144	1.178	1.211	1.245	1.279	1.308	1.429	1.650	2.235

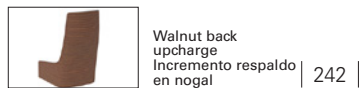

BU1489

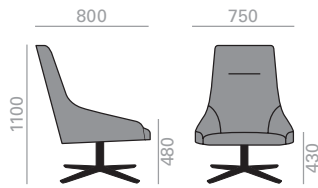

High back lounge chair with upholstered seat and back and a 4-star aluminum central swivel base, self-return system and finished in polished aluminum, white or black. Optional tilting mechanism and back finished in walnut veneer.

Butaca de respaldo alto con asiento y respaldo tapizado y base central giratoria de 4 aspas de aluminio con sistema de retorno y acabado aluminio pulido, blanco o negro. Opción de sistema basculante y respaldo en madera de nogal.

COM cm. per unit	COL m2
------------------	--------

0,78 m3
21,8 kg
x1

Fully upholstered Carcasa tapizada		5,75
1 units	300	
10 units or more	300	

Walnut back Respaldo nogal		5,75
1 units	300	
10 units or more	300	

COM	COL	1	2	3	4	5	6	7	8	9	10	11	L1	L2	L3	L6
€ 1.438	1.474	1.519	1.555	1.585	1.634	1.684	1.732	1.781	1.831	1.880	1.928	1.978	2.024	2.221	2.579	3.525

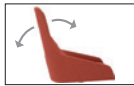

Tilting mechanism upcharge
Incremento por sistema basculante

42



Walnut back upcharge
Incremento respaldo en nogal

294

BU1490

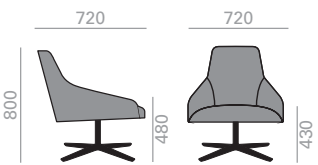

Low back lounge chair with upholstered seat and back and a 4-star aluminum central swivel base, self-return system and finished in polished aluminum, white or black. Optional tilting mechanism and back finished in walnut veneer.

Butaca de respaldo bajo con asiento y respaldo tapizado y base central giratoria de 4 aspas de aluminio con sistema de retorno y acabado aluminio pulido, blanco o negro. Opción de sistema basculante y respaldo en madera de nogal.

COM cm. per unit	COL m2
------------------	--------

0,5 m3
22 kg
x1

Fully upholstered Carcasa tapizada		5
1 units	250	
10 units or more	250	

Walnut back Respaldo nogal		5
1 units	250	
10 units or more	250	

COM	COL	1	2	3	4	5	6	7	8	9	10	11	L1	L2	L3	L6
€ 1.175	1.205	1.241	1.270	1.294	1.333	1.374	1.413	1.452	1.492	1.532	1.572	1.611	1.646	1.798	2.084	2.835

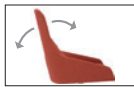

Tilting mechanism upcharge
Incremento por sistema basculante

42



Walnut back upcharge
Incremento respaldo en nogal

219

Glides for 4 star aluminum central base. Tacos para base central de aluminio de 4 aspas.

Use/Usu	Reference/Referencia	Material/Material	Price/Precio
Hard floors. Suelos duros.	TS0544	Plastic (PE). Plástico (PE).	0 € Standard. Estándar.
Wooden and delicate floors. Suelos de madera y delicados.	TS0556	Plastic (PE) with felt. Plástico (PE) con fieltro.	3 € Set of 4 glides. Juego de 4 tacos.
Mats/carpet floors. Suelos de moqueta/alfombra.	TS0557	No glide. Sin taco.	0 €

The indicated price is for glides placed on chairs. To order loose parts, please ask to our Sales Department.

El precio indicado en Tarifa es para tacos colocados en las sillas. Para pedidos de tacos sueltos de repuesto, consultar con el Departamento Comercial.

Casters. Ruedas.



Standard.
Estándar.

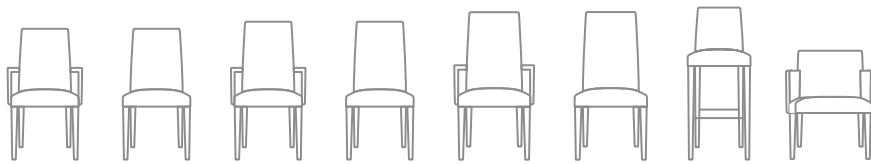

Description
Descripción

Chairs, armchairs, lounge chairs and stools with solid beech frame and upholstered seat and back. Offered in two different back heights. Easy chair and Lounge chair are also available in this collection.
Sillas, sillones, butacas y banquetas con asiento y respaldo tapizado y estructuras de madera maciza de haya. Se ofrece con dos alturas diferentes de respaldo.

Upholstery
Tapicería

The Anna collection supports following upholsteries of Andreu World Catalogue. For fabrics in our catalogue not specified in this box or customers own materials please contact our Customer Service Department.

La colección Anna admite las siguientes tapicerías del catálogo de Andreu World. Para las telas de nuestro catálogo no indicadas en este cuadro o telas cliente, consultar con nuestro Departamento Comercial.

fabrics / telas

- 1** Soft-fiber
Jacquard One
Jacquard Three
Citadel
Sand
Era
Gravity
Rivet
Urban
Reel One (in/out)
Spin One
Spin Two
Spin Three
Spin Four
Spin Five
- 2** Jacquard Two
Solid & Stripes
Loom One
Circular One Pure Eco
Tack One (in/out)

- 3** Jacquard Four
Medley
Revive 1
Natte
Main Line Flax
Loom Two (in/out)
Mezzo
Reel two (in/out)
Jacquard Five

- 4** Jacquard 4 Special
Nexus
Field 2
Remix 3
Heritage
Savane
Loom Three
Loom Four
Cura
Oceanic
Reel Three (in/out)
Reel Four (in/out)
Reflect
Spin Six

- 5** Silk
Synergy
Step
Step Melange
Blazer
Melange Nap
Chili
Noma
Re-wool

- 6** Go check
Swing
Chartres
Zori
Patio
Tack Two (in/out)
Tack Three (in/out)

- 7** Canvas 2
Select
Clara 2
Tack Five (in/out)
Hero 2

- 8** Capture
Fiord 2
Tonus 4
Divina 3
Lopi
Domino
Atrium
- 9** Divina MD
Divina Melange 3
Hallingdal 65
Steelcut Trio 3
Tack Four (in/out)

- 11** Arda
Ecriture
Zero

Faux Leather / Ecopiel

- 1** Valencia
- 2** Silvertex
- 3** Maglia
- 4** Dolce
- 8** Ultraleather
- 9** Brisa
Brisa Distressed
Fresco
Ultraleather Pro
Promessa
- 10** Tottori
Coast (in/out)
- 11** Reef Pro
Volar Bio

Leather / Piel

- L1** High grade cow leather.
Piel de vaca de 1ª categoría.
- L3** Polished full grain leather.
Piel de vaca pulida.
- L6** Aniline leather batique-effect.
Scandinavian cattle.
Piel anilina efecto batique.
Ganado escandinavo.

Wood finish Beech
Acabado madera Haya

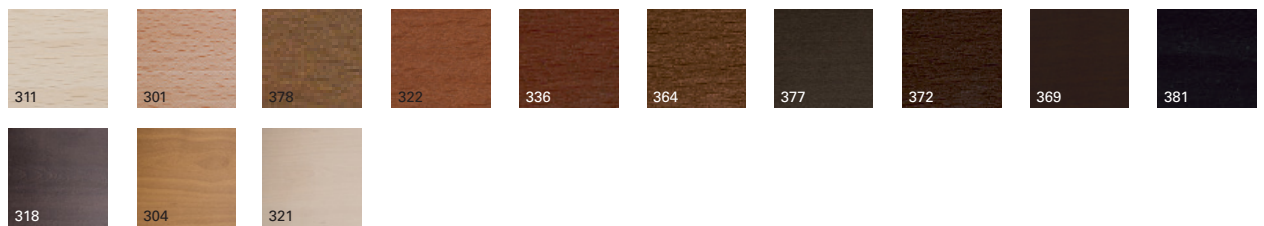

Premium finish and wood lacquers
Acabado premium y lacas madera



Certificates
Certificados

Fireproof polyurethane foam

Espuma de poliuretano ignifuga

UNE EN 1021:2006
BS 5852 part 2 crib 5
UNI 9175 Classe 1 IM
BKZ 5.2
California TB 117:2013
California TB 133*

*Contact our Customer Department
*Consultar con nuestro Departamento Comercial

Quality - Resistance
Calidad - Resistencia

UNE EN 16139:2013

Intellectual property Propiedad intelectual

All our collections are protected by international industrial design registries, designs patents, copyrights and intellectual Property laws. Unauthorized use of AW International Property is a criminal offence and can lead to prosecution.
Todas nuestras colecciones están protegidas por registros de diseño industrial, diseño de patente, copyright y derechos de propiedad intelectual en todo el mundo. El uso no autorizado de los diseños y propiedad intelectual de AW supone un delito que puede ser sometido a acción judicial.



SI1372

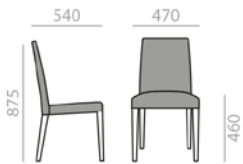

Chair with upholstered seat and backrest and solid beech wood frame. Low back version.
Silla con asiento y respaldo tapizado y estructura de madera maciza de haya. Versión de respaldo bajo.

	COM cm. per unit	COL m2
1 units	120	2,5
10 units or more	93	

0,35 m3
 18 kg
 x2

€	COM	COL	1	2	3	4	5	6	7	8	9	10	11	L1	L2	L3	L6
	261	270	281	290	298	310	322	338	346	358	378	392	405	416	462	549	777

SERIE 600	Matte lacquered and premium upcharge Incremento por lacado mate y premium	17	SERIE 800	Bright lacquered upcharge Incremento por lacado brillo	24
------------------	--	----	------------------	---	----

SO1373

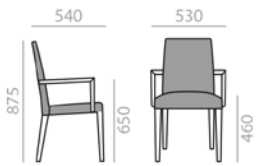

Armchair with upholstered seat and backrest and solid beech wood frame. Low back version.
Sillón con asiento y respaldo tapizado y estructura de madera maciza de haya. Versión de respaldo bajo.

	COM cm. per unit	COL m2
1 units	120	2,5
10 units or more	93	

0,27 m3
 10,4 kg
 x1

€	COM	COL	1	2	3	4	5	6	7	8	9	10	11	L1	L2	L3	L6
	355	364	376	387	393	407	425	434	447	467	480	495	510	521	572	665	907

SERIE 600	Matte lacquered and premium upcharge Incremento por lacado mate y premium	32	SERIE 800	Bright lacquered upcharge Incremento por lacado brillo	47
------------------	--	----	------------------	---	----

SI1370

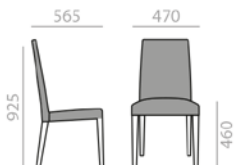

Chair with upholstered seat and backrest and solid beech wood frame. High back version.
Silla con asiento y respaldo tapizado y estructura de madera maciza de haya. Versión de respaldo alto.

	COM cm. per unit	COL m2
1 units	130	2,5
10 units or more	98	

0,28 m3
 18,4 kg
 x2

€	COM	COL	1	2	3	4	5	6	7	8	9	10	11	L1	L2	L3	L6
	262	272	283	294	300	314	326	344	351	372	386	400	413	425	475	563	804

SERIE 600	Matte lacquered and premium upcharge Incremento por lacado mate y premium	17	SERIE 800	Bright lacquered upcharge Incremento por lacado brillo	24
------------------	--	----	------------------	---	----

SO1371

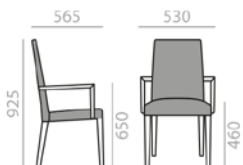

Armchair with upholstered seat and backrest and solid beech wood frame. High back version.
Sillón con asiento y respaldo tapizado y estructura de madera maciza de haya. Versión de respaldo alto.

	COM cm. per unit	COL m2
1 units	130	2,5
10 units or more	98	

0,37 m3
 10,7 kg
 x1

€	COM	COL	1	2	3	4	5	6	7	8	9	10	11	L1	L2	L3	L6
	359	370	382	393	401	416	430	444	459	480	495	510	525	538	593	693	953

SERIE 600	Matte lacquered and premium upcharge Incremento por lacado mate y premium	32	SERIE 800	Bright lacquered upcharge Incremento por lacado brillo	47
------------------	--	----	------------------	---	----

SI1368

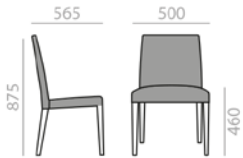

Chair with upholstered seat and backrest and solid beech wood frame. Low back, Wider version.
Silla con asiento y respaldo tapizado y estructura de madera maciza de haya. Versión de respaldo bajo y ancho especial.

	COM cm. per unit	COL m2
1 units	120	2,5
10 units or more	100	

0,35 m3
 17,6 kg
 x2

€	COM	COL	1	2	3	4	5	6	7	8	9	10	11	L1	L2	L3	L6
	273	282	294	305	313	325	338	357	371	386	400	415	430	441	493	585	831

SERIE 600	Matte lacquered and premium upcharge Incremento por lacado mate y premium	17	SERIE 800	Bright lacquered upcharge Incremento por lacado brillo	24
------------------	--	----	------------------	---	----

SO1369

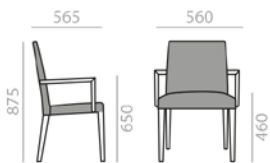

Armchair with upholstered seat and backrest and solid beech wood frame. Low back, Wider version.
Sillón con asiento y respaldo tapizado y estructura de madera maciza de haya. Versión de respaldo bajo y ancho especial.

	COM cm. per unit	COL m2
1 units	120	2,5
10 units or more	100	

0,32 m3
 9,2 kg
 x1

€	COM	COL	1	2	3	4	5	6	7	8	9	10	11	L1	L2	L3	L6
	366	377	389	400	408	421	436	458	463	491	507	521	538	551	609	709	982

SERIE 600	Matte lacquered and premium upcharge Incremento por lacado mate y premium	32	SERIE 800	Bright lacquered upcharge Incremento por lacado brillo	47
------------------	--	----	------------------	---	----

SO1384

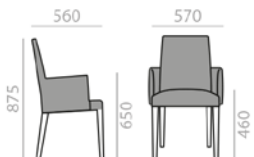

Armchair with upholstered seat, backrest and arms. Solid beech wood frame.
Sillón con asiento, brazos y respaldo tapizados y estructura de madera maciza de haya.

	COM cm. per unit	COL m2
1 units	160	3
10 units or more	155	

0,32 m3
 11 kg
 x1

€	COM	COL	1	2	3	4	5	6	7	8	9	10	11	L1	L2	L3	L6
	377	392	411	427	439	460	481	501	539	562	586	607	632	652	736	887	1.290

SERIE 600	Matte lacquered and premium upcharge Incremento por lacado mate y premium	17	SERIE 800	Bright lacquered upcharge Incremento por lacado brillo	24
------------------	--	----	------------------	---	----

BQ1385

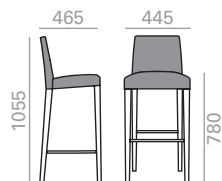

Barstool with upholstered seat and backrest. Solid beech wood frame.
Banqueta alta con asiento y respaldo tapizado y estructura de madera maciza de haya.

	COM cm. per unit	COL m2
1 units	100	2
10 units or more	80	

0,26 m3
 9 kg
 x1

€	COM	COL	1	2	3	4	5	6	7	8	9	10	11	L1	L2	L3	L6
	358	366	375	383	390	400	411	423	434	444	462	474	486	496	537	617	819

SERIE 600	Matte lacquered and premium upcharge Incremento por lacado mate y premium	24	SERIE 800	Bright lacquered upcharge Incremento por lacado brillo	35
------------------	--	----	------------------	---	----

BQ1386



Counter stool with upholstered seat and backrest. Solid beech wood frame.
Banqueta baja con asiento y respaldo tapizado y estructura de madera maciza de haya.

	COM cm. per unit	COL m2
1 units	100	2
10 units or more	80	

0,28 m3
 8,7 kg
 x1

€	COM	COL	1	2	3	4	5	6	7	8	9	10	11	L1	L2	L3	L6
	358	366	375	383	390	400	411	423	434	444	462	474	486	496	537	617	819

SERIE 600	Matte lacquered and premium upcharge Incremento por lacado mate y premium	24	SERIE 800	Bright lacquered upcharge Incremento por lacado brillo	35
-----------	--	----	-----------	---	----

SO1406

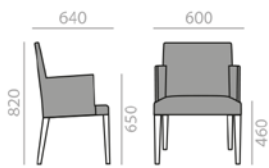

Anna Corporate. Armchair with upholstered seat, backrest and arms and solid beech wood frame. Wider version.
Anna Corporate. Sillón con asiento, brazos y respaldo tapizados y estructura de madera maciza de haya. Versión ancha.

	COM cm. per unit	COL m2
1 units	210	4,5
10 units or more	190	

0,35 m3
 12,5 kg
 x1

€	COM	COL	1	2	3	4	5	6	7	8	9	10	11	L1	L2	L3	L6
	508	528	551	571	586	611	637	662	688	733	759	788	815	841	941	1.126	1.610

SERIE 600	Matte lacquered and premium upcharge Incremento por lacado mate y premium	17	SERIE 800	Bright lacquered upcharge Incremento por lacado brillo	24
-----------	--	----	-----------	---	----

BU1405

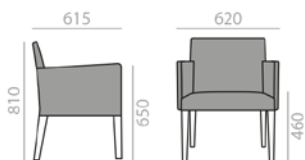

Easy Chair version. Lounge chair with upholstered seat and backrest, and solid beech wood frame.
Easy Chair version. Butaca con asiento y respaldo tapizado y estructura de madera maciza de haya.

	COM cm. per unit	COL m2
1 units	220	5,25
10 units or more	210	

0,35 m3
 15,1 kg
 x1

€	COM	COL	1	2	3	4	5	6	7	8	9	10	11	L1	L2	L3	L6
	660	687	711	738	763	799	833	869	902	936	972	1.006	1.042	1.073	1.198	1.427	2.033

SERIE 600	Matte lacquered and premium upcharge Incremento por lacado mate y premium	17	SERIE 800	Bright lacquered upcharge Incremento por lacado brillo	24
-----------	--	----	-----------	---	----

For wooden legs. Para bases de madera.



Optional glides on page 482.
Opciones de tacos deslizantes en página 482.



Description Upholstered ottoman and solid beech wood frame.
Descripción Reposapiés tapizado y estructura de madera maciza de haya.

Upholstery The Beat collection supports following upholsteries of Andreu World Catalogue. For fabrics in our catalogue not specified in this box or customers own materials please contact our Customer Service Department.
Tapicería

La colección Beat admite las siguientes tapicerías del catálogo de Andreu World. Para las telas de nuestro catálogo no indicadas en este cuadro o telas cliente, consultar con nuestro Departamento Comercial.

Fabrics / Telas

- 1** Soft-fiber
Jacquard One
Jacquard Three
Citadel
Era
Gravity
Rivet
Urban
Reel One (in/out)
Spin One
Spin Two
Spin Three
Spin Four
Spin Five
- 2** Jacquard Two
Solid & Stripes
Circular One Pure Eco
Tack One (in/out)

- 3** Jacquard Four
Medley
Revive 1
Natte
Main Line Flax
Loom Two (in/out)
Mezzo
Reel two (in/out)
Jacquard Five

- 4** Jacquard 4 Special
Nexus
Field 2
Heritage
Savane
Loom Three
Loom Four
Cura
Oceanic
Reel Three (in/out)
Reel Four (in/out)
Reflect
Spin Six

- 5** Silk
Synergy
Step
Step Melange
Blazer
Chili
Melange Nap
Chili
Norma
Re-wool

- 6** Go check
Swing
Chartres
Zori
Patio
Tack Two (in/out)
Tack Three (in/out)

- 7** Canvas 2
Select
Clara 2
Tack Five (in/out)
Hero 2

- 8** Capture
Fiord 2
Tonus 4
Divina 3
Lopi
Domino

- 9** Divina MD
Divina Melange 3
Hallindal 65
Steelcut Trio 3
Tack Four (in/out)

- 11** Arda
Ecriture
Zero

Faux Leather / Ecopiel

- 1** Valencia
- 2** Silvertex
- 3** Maglia
- 4** Dolce
- 8** Ultraleather
- 9** Brisa
Brisa Distressed
Fresco
Ultraleather Pro
Promessa

- 10** Tottori
Coast (in/out)

- 11** Reef Pro
Volar Bio

Leather / Piel

- L1** High grade cow leather.
Piel de vaca de 1ª categoría.
- L3** Polished full grain leather.
Plena flor pulida.
- L6** Aniline leather batique-effect.
Scandinavian cattle.
Piel anilina efecto batique.
Ganado escandinavo.

Certificates
Certificados

Fireproof polyurethane foam

Espuma de poliuretano ignifuga

UNE EN 1021:2006
BS 5852 part 2 crib 5
UNI 9175 Classe 1 IM
BKZ 5.2
California TB 117:2013
California TB 133*

*Contact our Customer Department
*Consultar con nuestro Departamento Comercial

Quality - Resistance
Calidad - Resistencia

UNE EN 16139:2013

Intellectual property Propiedad intelectual

All our collections are protected by international industrial design registries, designs patents, copyrights and intellectual Property laws. Unauthorized use of AW International Property is a criminal offence and can lead to prosecution.
Todas nuestras colecciones están protegidas por registros de diseño industrial, diseño de patente, copyright y derechos de propiedad intelectual en todo el mundo. El uso no autorizado de los diseños y propiedad intelectual de AW supone un delito que puede ser sometido a acción judicial.



RS0211

Upholstered ottoman. 1-seater.
Reposapiés tapizado. 1 plaza.

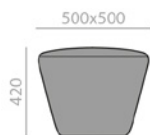

	COM cm. per unit	COL m2
1 units	190	3,7
10 units or more	190	

0,14 m3
 9,4 kg
 x1

€	COM	COL	1	2	3	4	5	6	7	8	9	10	11	L1	L2	L3	L6
	455	475	499	519	535	562	589	617	642	670	697	724	751	774	872	1.050	1.533

RS0212

Upholstered ottoman. 1-2 seaters.
Reposapiés tapizado. 1-2 plazas.

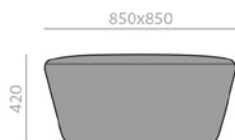

	COM cm. per unit	COL m2
1 units	220	4,5
10 units or more	220	

0,4 m3
 23 kg
 x1

€	COM	COL	1	2	3	4	5	6	7	8	9	10	11	L1	L2	L3	L6
	638	664	697	725	745	781	817	853	888	924	960	996	1.032	1.063	1.193	1.428	2.068

RS0213

Upholstered ottoman. 2-3 seaters.
Reposapiés tapizado. 2-3 plazas.



	COM cm. per unit	COL m2
1 units	400	7,8
10 units or more	400	

0,91 m3
 53 kg
 x1

€	COM	COL	1	2	3	4	5	6	7	8	9	10	11	L1	L2	L3	L6
	920	965	1.019	1.062	1.097	1.157	1.215	1.274	1.334	1.392	1.451	1.509	1.569	1.621	1.834	2.228	3.316

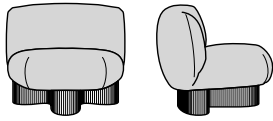

Description

Modular sofa with upholstered seat and backrest and BIO thermopolymer base available in various colors.

Descripción

Sofá modular con asiento y respaldo tapizado y base de termopolímero BIO disponible en diferentes colores.

Upholstery

The Bolete Lounge BIO collection supports following upholsteries of Andreu World Catalogue. For fabrics in our catalogue not specified in this box or customers own materials please contact our Customer Service Department.

Tapicería

La colección Bolete Lounge BIO admite las siguientes tapicerías del catálogo de Andreu World. Para las telas de nuestro catálogo no indicadas en este cuadro o telas cliente, consultar con nuestro Departamento Comercial.

Fabrics / Telas

- 1** Soft-fiber
- Jacquard One
- Jacquard Three
- Citadel
- Sand
- Era
- Gravity
- Rivet
- Urban
- Reel One (in/out)
- Spin One
- Spin Two
- Spin Three
- Spin Four
- Spin Five
- 2** Jacquard Two
- Solid & Stripes
- Loom One
- Circular One Pure Eco
- Tack One (in/out)

- 3** Jacquard Four
- Medley
- Revive 1
- Natte
- Main Line Flax
- Loom Two (in/out)
- Mezzo
- Reel two (in/out)
- Jacquard Five

- 4** Jacquard 4 Special
- Nexus
- Field 2
- Remix 3
- Heritage
- Savane
- Loom Three
- Loom Four
- Cura
- Oceanic
- Reel Three (in/out)
- Reel Four (in/out)
- Reflect
- Spin Six

- 5** Silk
- Synergy
- Step
- Step Melange
- Blazer
- Melange Nap
- Chili
- Noma
- Re-wool

- 6** Go check
- Swing
- Chartres
- Zori
- Patio
- Tack Two (in/out)
- Tack Three (in/out)

- 7** Canvas 2
- Select
- Clara 2
- Tack Five (in/out)
- Hero 2

- 8** Capture
- Fiord 2
- Tonus 4
- Divina 3
- Lopi
- Domino
- Atrium
- 9** Divina MD
- Divina Melange 3
- Hallingdal 65
- Steelcut Trio 3
- Tack Four (in/out)

- 11** Arda
- Ecriture
- Zero

Faux Leather / Ecopiel

- 1** Valencia
- 2** Silvertex
- 3** Maglia
- 4** Dolce
- 8** Ultraleather
- 9** Brisa
- Brisa Distressed
- Fresco
- Ultraleather Pro
- Promessa
- 10** Tottori
- Coast (in/out)
- 11** Reef Pro
- Volar Bio

Leather / Piel

- L1** High grade cow leather.
Piel de vaca de 1ª categoría.
- L3** Polished full grain leather.
Piel de vaca pulida.
- L6** Aniline leather batique-effect.
Scandinavian cattle.
Piel anilina efecto batique.
Ganado escandinavo.

Bio Thermo-polymer finish

Acabado de Termo-polímero Bio

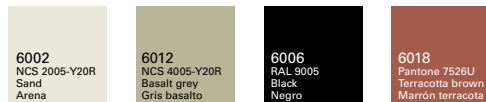

Certificates

Certificados

Fireproof polyurethane foam

Espuma de poliuretano ignífuga

UNE EN 1021:2006
BS 5852 part 2 crib 5
UNI 9175 Classe 1 IM
BKZ 5.2
California TB 117:2013
California TB 133*

*Contact our Customer Department
*Consultar con nuestro Departamento Comercial

Quality - Resistance

Calidad - Resistencia

UNE EN 16139:2013

Intellectual property Propiedad intelectual

All our collections are protected by international industrial design registries, designs patents, copyrights and intellectual Property laws. Unauthorized use of AW International Property is a criminal offence and can lead to prosecution.

Todas nuestras colecciones están protegidas por registros de diseño industrial, diseño de patente, copyright y derechos de propiedad intelectual todo el mundo. El uso no autorizado de los diseños y propiedad intelectual de AW supone un delito que puede ser sometido a acción judicial.



SF1726

Modular sofa with upholstered seat and backrest and BIO thermopolymer base available in various colors.

Sofá modular con asiento y respaldo tapizado y base de termopolímero BIO disponible en diferentes colores.

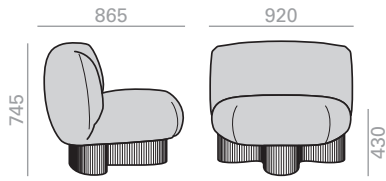

	COM cm. per unit	COL m2
1 units	250	5
10 units or more	250	

0,69 m3

23 kg

x1

€	COM	COL	1	2	3	4	5	6	7	8	9	10	11	L1	L2	L3	L6
	1.223	1.250	1.284	1.311	1.332	1.369	1.406	1.442	1.479	1.516	1.552	1.589	1.626	1.658	1.790	2.031	2.668

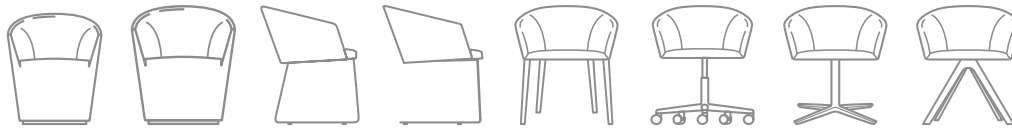

Description
Descripción

Armchairs with upholstered seat and backrest. Bases available: steel rod sled base, 4 steel tube legs or steel cantilever base with polished chrome, white or black finish, 4 solid beech wood legs, solid beech wood swivel base or 4-wheel aluminum swivel base with self-return system and polished aluminum, white or black finish, and 5-wheel swivel base with height adjustment and polished aluminum, white or black finish. Available versions of lounge chair with upholstered seat and backrest and 4-leg base in solid beech wood and versions with 4-blade aluminum central base, with self-return system and polished aluminum, white or black finish or swivel central base in solid beech wood, available with option of tilting system and satellite table in black melamine finish. Upholstered lounge chair version with wooden base and swivel option.

Sillones con asiento y respaldo tapizados. Bases disponibles: patin de varilla de acero, 4 patas de tubo de acero o cantiléver de pletina de acero y acabado cromo brillo, blanco o negro, 4 patas de madera maciza de haya, central giratoria de madera maciza de haya o central giratoria de aluminio de 4 aspas, con sistema de retorno y acabado aluminio pulido, blanco o negro y central de 5 ruedas giratoria, regulable en altura y acabado aluminio pulido, blanco o negro. Disponible versión de butaca con asiento y respaldo tapizado y base de 4 patas de madera maciza de haya y versiones de base central de aluminio de 4 aspas, con sistema de retorno y acabado aluminio pulido, blanco o negro o base central giratoria de madera maciza de haya, disponibles con opción de sistema basculante y mesa satélite en acabado melamina negra. Disponible butaca tapizada con zócalo de madera, y versión giratoria.

Upholstery
Tapicería

The Brandy collection supports following upholsteries of Andreu World Catalogue. For fabrics in our catalogue not specified in this box or customers own materials please contact our Customer Service Department.

La colección Brandy admite las siguientes tapicerías del catálogo de Andreu World. Para las telas de nuestro catálogo no indicadas en este cuadro o telas cliente, consultar con nuestro Departamento Comercial.

Fabrics / Telas

- 1 Jacquard One
- Jacquard Three
- Citadel
- Era
- Gravity
- Rivet
- Urban
- Spin One
- Spin Two
- Spin Three
- Spin Four
- Spin Five
- 2 Jacquard Two
- Circular One Pure Eco
- Tack One (in/out)

- 3 Jacquard Four
- Medley
- Revive 1
- Natte
- Main Line Flax
- Loom Two (in/out)
- Mezzo
- Reel two (in/out)
- Jacquard Five

- 4 Jacquard 4 Special
- Nexus
- Heritage
- Savane
- Loom Three
- Loom Four
- Cura
- Oceanic
- Reel Three (in/out)
- Reel Four (in/out)
- Reflect
- Spin Six

- 5 Silk
- Synergy
- Step
- Step Melange
- Blazer
- Melange Nap
- Chili
- Noma
- Re-wool

- 6 Go check
- Swing
- Chartres
- Zori
- Patio
- Tack Two (in/out)
- Tack Three (in/out)

- 7 Canvas 2
- Select
- Clara 2
- Tack Five (in/out)
- Hero 2

- 8 Capture
- Fiord 2
- Tonus 4
- Divina 3
- Lopi
- Domino

- 9 Divina MD
- Divina Melange 3
- Hallingdal 65
- Steelcut Trio 3
- Tack Four (in/out)

- 11 Arda
- Ecriture
- Zero

Faux Leather / Ecopiel

- 1 Valencia
- 2 Silvertex
- 3 Maglia
- 4 Dolce
- 8 Ultraleather
- 9 Brisa
- Brisa Distressed
- Fresco
- Ultraleather Pro
- Promessa
- 10 Tottori
- Coast (in/out)
- 11 Reef Pro
- Volar Bio

Leather / Piel

- L1 High grade cow leather.
- Piel de vaca de 1ª categoría.
- L3 Polished full grain leather.
- Plena flor pulida.
- L6 Aniline leather batique-effect.
- Scandinavian cattle.
- Piel anilina efecto batique.
- Ganado escandinavo.

Wood finish Beech
Acabado madera Haya

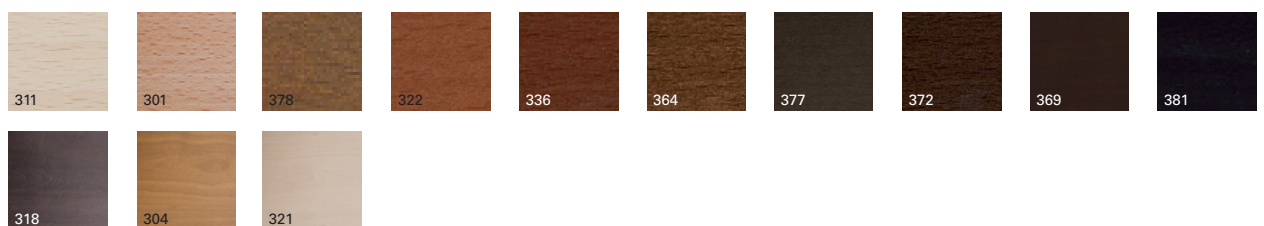

Premium finish and wood lacquers
Acabado premium y lacas madera



Eco Thermo-polymer finish
Acabado de Termo-polímero Eco

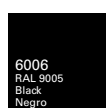

Aluminum finish
Acabado aluminio



Certificates
Certificados

Fireproof polyurethane foam
Espuma de poliuretano ignifuga

UNE EN 1021:2006
BS 5852 part 2 crib 5
UNI 9175 Classe 1 IM
BKZ 5.2
California TB 117:2013
California TB 133*

Quality - Resistance
Calidad - Resistencia

UNE EN 16139:2013

*Contact our Customer Department
*Consultar con nuestro Departamento Comercial

Intellectual property Propiedad intelectual

All our collections are protected by international industrial design registries, designs patents, copyrights and intellectual Property laws. Unauthorized use of AW International Property is a criminal offence and can lead to prosecution.
Todas nuestras colecciones están protegidas por registros de diseño industrial, diseño de patente, copyright y derechos de propiedad intelectual todo el mundo. El uso no autorizado de los diseños y propiedad intelectual de AW supone un delito que puede ser sometido a acción judicial.



BU2991

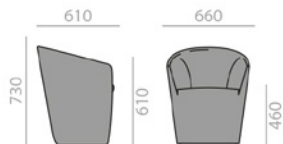

Lounge chair with upholstered seat and backrest and wooden baseboard.

Butaca con asiento y respaldo tapizado y zócalo de madera.

	COM cm. per unit	COL m2
1 units	260	5,25
10 units or more	250	

0,32 m3
 17,1 kg
 x1

€	COM	COL	1	2	3	4	5	6	7	8	9	10	11	L1	L2	L3	L6
	701	727	758	784	807	844	881	919	955	992	1.030	1.069	1.107	1.139	1.273	1.520	2.171

SERIE 600 Matte lacquered and premium upcharge
Incremento por lacado mate y premium | 9 |

SERIE 800 Bright lacquered upcharge
Incremento por lacado brillo | 12 |

BU3001

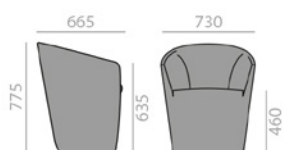

Lounge chair with upholstered seat and backrest and wooden baseboard. Optional swivel base.

Butaca con asiento y respaldo tapizado y zócalo de madera. Opción de base giratoria.

	COM cm. per unit	COL m2
1 units	300	6,25
10 units or more	280	

0,42 m3
 18,9 kg
 x1

€	COM	COL	1	2	3	4	5	6	7	8	9	10	11	L1	L2	L3	L6
	853	880	914	943	974	1.018	1.064	1.111	1.155	1.199	1.243	1.292	1.336	1.376	1.540	1.838	2.628

SERIE 600 Matte lacquered and premium upcharge
Incremento por lacado mate y premium | 9 |

SERIE 800 Bright lacquered upcharge
Incremento por lacado brillo | 12 |

Swivel base upcharge
Incremento por base giratoria | 191 |

SO2993

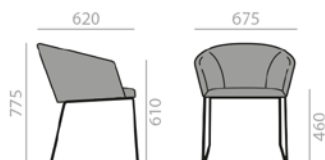

Armchair with upholstered seat and backrest, steel sled base finished in polished chrome, white or black.

Sillón con asiento y respaldo tapizado y base de patín de acero en acabado cromo brillo, blanco o negro.

	COM cm. per unit	COL m2
1 units	180	3,5
10 units or more	153	

0,33 m3
 14,3 kg
 x1

€	COM	COL	1	2	3	4	5	6	7	8	9	10	11	L1	L2	L3	L6
	527	542	561	577	592	615	638	662	684	709	734	755	780	800	886	1.045	1.466

SO2994

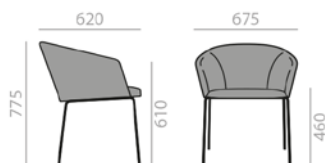

Armchair with upholstered seat and backrest and 4-legs steel base finished in polished chrome, white or black.

Sillón con asiento y respaldo tapizado y base de 4 patas de acero en acabado cromo brillo, blanco o negro.

	COM cm. per unit	COL m2
1 units	180	3,5
10 units or more	153	

0,34 m3
 12,3 kg
 x1

€	COM	COL	1	2	3	4	5	6	7	8	9	10	11	L1	L2	L3	L6
	535	553	572	588	602	627	651	675	699	723	748	771	796	818	904	1.068	1.498

SO2995

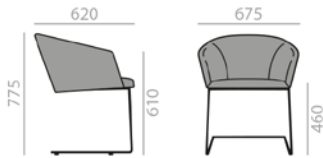

Armchair with upholstered seat and backrest, steel oval cantilever base finished in polished chrome, white or black.
Sillón con asiento y respaldo tapizado y base cantilever de pletina ovalada de acero en acabado cromo brillo, blanco o negro.

	COM cm. per unit	COL m2
1 units	180	3,5
10 units or more	153	

0,31 m3
 16,7 kg
 x1

€	COM	COL	1	2	3	4	5	6	7	8	9	10	11	L1	L2	L3	L6
	614	630	649	665	678	704	729	754	777	802	827	851	878	902	994	1.166	1.619

SO2996

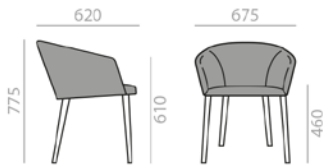

Armchair with upholstered seat and backrest and 4 solid beech wood legs.
Sillón con asiento y respaldo tapizado y base de 4 patas de madera maciza de haya.

	COM cm. per unit	COL m2
1 units	180	3,5
10 units or more	153	

0,33 m3
 10,7 kg
 x1

€	COM	COL	1	2	3	4	5	6	7	8	9	10	11	L1	L2	L3	L6
	563	580	600	617	629	652	673	696	718	739	762	784	805	825	905	1.055	1.467

SERIE 600	Matte lacquered and premium upcharge Incremento por lacado mate y premium	17	SERIE 800	Bright lacquered upcharge Incremento por lacado brillo	24
------------------	--	----	------------------	---	----

SO2997

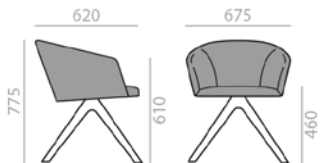

Armchair with solid beech wood central swivel base and upholstered seat and backrest.
Sillón con asiento y respaldo tapizado y base central giratoria de 4 aspas de madera maciza de haya.

	COM cm. per unit	COL m2
1 units	180	3,5
10 units or more	153	

0,35 m3
 15,2 kg
 x1

€	COM	COL	1	2	3	4	5	6	7	8	9	10	11	L1	L2	L3	L6
	737	753	771	787	798	819	839	859	878	900	920	943	965	984	1.064	1.210	1.605

SERIE 600	Matte lacquered and premium upcharge Incremento por lacado mate y premium	24	SERIE 800	Bright lacquered upcharge Incremento por lacado brillo	35
------------------	--	----	------------------	---	----

BU2998

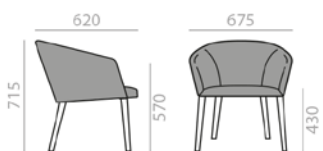

Lounge chair with upholstered seat and backrest and 4-legs solid beech wood frame.
Butaca con asiento y respaldo tapizado y estructura de 4 patas de madera maciza de haya.

	COM cm. per unit	COL m2
1 units	180	3,5
10 units or more	153	

0,3 m3
 11,2 kg
 x1

€	COM	COL	1	2	3	4	5	6	7	8	9	10	11	L1	L2	L3	L6
	561	576	596	613	625	646	669	690	712	733	754	776	797	817	895	1.042	1.446

SERIE 600	Matte lacquered and premium upcharge Incremento por lacado mate y premium	17	SERIE 800	Bright lacquered upcharge Incremento por lacado brillo	24
------------------	--	----	------------------	---	----

SO2999

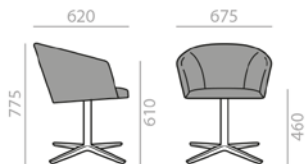

Armchair with upholstered seat and backrest and a 4-star aluminum swivel base, with self-return system, and finished in polished aluminum, white or black.

Sillón con asiento y respaldo tapizado y base central giratoria de aluminio de 4 aspas con sistema de retorno y acabado aluminio pulido, blanco o negro.

	COM cm. per unit	COL m2
1 units	180	3,5
10 units or more	153	

0,31 m3
12,4 kg
x1

€	COM	COL	1	2	3	4	5	6	7	8	9	10	11	L1	L2	L3	L6
	724	740	758	774	785	806	826	847	867	888	908	930	953	973	1.058	1.215	1.634

SO3000

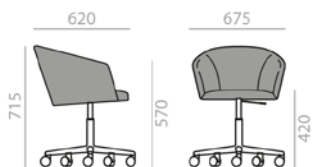

Armchair with upholstered seat and backrest and aluminum central base with 5 casters, swivel and pneumatic height adjustment. Finished in polished aluminum, white or black.

Sillón con asiento y respaldo tapizado y base central giratoria de aluminio de 5 ruedas, regulable en altura y acabado aluminio pulido, blanco o negro. Rangos de altura: asiento 420-540 mm./brazos 570-690 mm.

	COM cm. per unit	COL m2
1 units	180	3,5
10 units or more	153	

0,33 m3
17,1 kg
x1

€	COM	COL	1	2	3	4	5	6	7	8	9	10	11	L1	L2	L3	L6
	791	810	832	850	864	889	913	937	962	986	1.010	1.035	1.059	1.080	1.168	1.327	1.768

SO3002

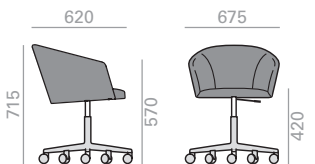

Armchair with upholstered seat and backrest and Eco thermo-polymer central base with 5 casters, swivel and pneumatic height adjustment, finished in black. Height ranges: seat 420-540 mm./arms 570-690 mm.

Sillón con asiento y respaldo tapizado y base central giratoria de termopolímero Eco de 5 ruedas, regulable en altura y acabado negro. Rangos de altura: asiento 420-540 mm./brazos 570-690 mm.

	COM cm. per unit	COL m2
1 units	180	3,5
10 units or more	153	

0,33 m3
15,8 kg
x1

€	COM	COL	1	2	3	4	5	6	7	8	9	10	11	L1	L2	L3	L6
	666	683	705	722	737	760	783	806	831	854	878	901	925	948	1.038	1.203	1.643

BU3015

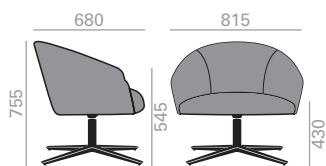

Lounge chair with upholstered seat and backrest and central 4-blade aluminum swivel base with self-return system in polished aluminum with white or black finish. Available options: Tilting system and satellite side table in black melamine finish.

Butaca con asiento y respaldo tapizado y base central giratoria de aluminio de 4 aspas con sistema de retorno y acabado aluminio pulido, blanco o negro. Opciones disponibles: Sistema basculante y mesa auxiliar satélite en acabado melamina negra.

	COM cm. per unit	COL m2
1 units	270	5,5
10 units or more	270	

0,53 m3
25 kg
x1

€	COM	COL	1	2	3	4	5	6	7	8	9	10	11	L1	L2	L3	L6
	764	787	816	840	858	890	921	954	986	1.017	1.049	1.080	1.112	1.140	1.254	1.463	2.015



Tilting mechanism upcharge
Incremento por sistema basculante

35

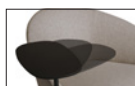

Satellite auxiliary table upcharge
Incremento mesa auxiliar satélite

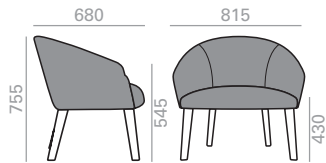

150

BU3016



 Lounge chair with upholstered seat and backrest and 4-legged base in solid beech wood.
Butaca con asiento y respaldo tapizado y base de 4 patas de madera maciza de haya.

	COM cm. per unit	COL m2
1 units	270	5,5
10 units or more	270	

 0,53 m3
 17,6 kg
 x1

COM	COL	1	2	3	4	5	6	7	8	9	10	11	L1	L2	L3	L6
€ 646	670	700	724	744	776	809	842	875	906	939	972	1.005	1.033	1.151	1.367	1.934

SERIE 600 Matte lacquered and premium upcharge
Incremento por lacado mate y premium | 17 |

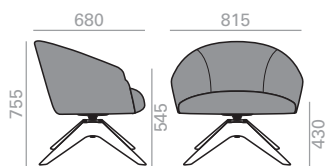

SERIE 800 Bright lacquered upcharge
Incremento por lacado brillo | 24 |

BU3017



 Lounge chair with upholstered seat and backrest and central swivel base with 4 solid beech wood blades. Available options: tilting s system and satellite side table in black melamine finish.
Butaca con asiento y respaldo tapizado y base central giratoria de 4 aspas de madera maciza de haya. Opciones disponibles: Sistema basculante y mesa auxiliar satélite en acabado melamina negra.

	COM cm. per unit	COL m2
1 units	270	5,5
10 units or more	270	

 0,53 m3
 22,2 kg
 x1

COM	COL	1	2	3	4	5	6	7	8	9	10	11	L1	L2	L3	L6
€ 902	925	954	977	995	1.027	1.059	1.089	1.121	1.152	1.183	1.215	1.246	1.274	1.387	1.592	2.137

SERIE 600 Matte lacquered and premium upcharge
Incremento por lacado mate y premium | 24 |

SERIE 800 Bright lacquered upcharge
Incremento por lacado brillo | 35 |



Tilting mechanism upcharge
Incremento por sistema basculante | 35 |



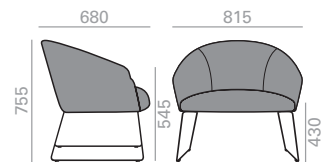

Satellite auxiliary table upcharge
Incremento mesa auxiliar satélite | 150 |

BU3018



Lounge chair with upholstered seat and backrest and steel sled base finished in polished chrome, white or black.
Butaca con asiento y respaldo tapizado y base de patín de acero en acabado cromo brillo, blanco o negro.

	COM cm. per unit	COL m2
1 units	270	5,5
10 units or more	270	

 0,53 m3
 26,5 kg
 x1

COM	COL	1	2	3	4	5	6	7	8	9	10	11	L1	L2	L3	L6
€ 546	570	599	623	641	673	705	735	767	799	830	862	894	921	1.034	1.247	1.816

For wooden legs. Para bases de madera.



Optional glides on page 482.
Opciones de tacos deslizantes en página 482.

Casters. Ruedas.



Standard.
Estándar.

Glides for sled bases/cantilever. Tacos para bases de patín/cantilever.

Use/Usó	Reference/Referencia		Material/Material	Price/Precio	
Hard floors. Suelos duros.	TS0531		Plastic (PE). Plástico (PE).	0 €	Standard. Estándar.
Wooden and delicated floors. Suelos de madera y delicados.	TS0538		Plastic (PE) with felt. Plástico (PE) con fieltro.	6 €	Set of 4 glides. Juego de 4 tacos.
Mats/carpet floors. Suelos de moqueta/ alfombra.	TS0537		No glide. Sin taco.	0 €	



The indicated price is for glides placed on chairs. To order loose parts, please ask to our Sales Department.

El precio indicado en Tarifa es para tacos colocados en las sillas. Para pedidos de tacos sueltos de repuesto, consultar con el Departamento Comercial.

Glies for 4 metal legs base. Tacos para bases de 4 patas metálicas.

Use/Usó	Reference/Referencia		Material/Material	Price/Precio	
Hard floors. Suelos duros.	TS0560		Plastic (PE). Plástico (PE).	0 €	Standard. Estándar.
Wooden and delicated floors. Suelos de madera y delicados.	TS0542		Plastic (PE) with felt. Plástico (PE) con fieltro.	3 €	Set of 4 glides. Juego de 4 tacos.
Mats/carpet floors. Suelos de moqueta/ alfombra.	TS0566		Metal. Metal.	3 €	Set of 4 glides. Juego de 4 tacos.

Glides for 4 star aluminum central base. Tacos para base central de aluminio de 4 aspas.

Use/Usó	Reference/Referencia		Material/Material	Price/Precio	
Hard floors. Suelos duros.	TS0544		Plastic (PE). Plástico (PE).	0 €	Standard. Estándar.
Wooden and delicated floors. Suelos de madera y delicados.	TS0556		Plastic (PE) with felt. Plástico (PE) con fieltro.	3 €	Set of 4 glides. Juego de 4 tacos.
Mats/carpet floors. Suelos de moqueta/ alfombra.	TS0557		No glide. Sin taco.	0 €	



Description
Descripción

Medium and high-backed armchairs with upholstered seat and backrest or the option of upholstered shell and walnut wood backrest. Medium-backed version with upholstered seat and backrest in technical fabric. The bases available are: central swivel base, with tilting system, in aluminum with 4 blades and a return system, central swivel base in aluminum with 5 height-adjustable wheels, in polished aluminum, white or black finish and central swivel base, with tilting system, in Eco Thermopolymer with 5 wheels, height-adjustable and with a black finish. Optional headrest cushion in high-backed versions.

Sillones de respaldo intermedio y alto con asiento y respaldo tapizado o carcasa tapizada y opción de respaldo en madera de nogal. Versión de respaldo intermedio con asiento tapizado y respaldo en tejido técnico. Las bases disponibles son: base central giratoria, con sistema basculante, de aluminio de 4 aspas con sistema de retorno, base central giratoria de aluminio de 5 ruedas regulable en altura, en acabado aluminio pulido, blanco o negro y base central giratoria, con sistema basculante, de termopolímero Eco de 5 ruedas, regulable en altura y acabado negro. Opción de cojín cabecero en versiones de respaldo alto.

Upholstery
Tapicería

The Calma collection supports following upholsteries of Andreu World Catalogue. For fabrics in our catalogue not specified in this box or customers own materials please contact our Customer Service Department.

La colección Calma admite las siguientes tapicerías del catálogo de Andreu World. Para las telas de nuestro catálogo no indicadas en este cuadro o telas cliente, consultar con nuestro Departamento Comercial.

Fabrics / Telas

- 1** Soft-fiber
Jacquard One
Jacquard Three
Citadel
Sand
Era
Gravity
Rivet
Urban
Spin One
Spin Two
Spin Three
Spin Four
Spin Five
- 2** Jacquard Two
Loom One
Circular One Pure Eco
Tack One (in/out)

- 3** Jacquard Four
Medley
Revive 1
Natte
Main Line Flax
Loom Two (in/out)
Mezzo
Reel two (in/out)
Jacquard Five

- 4** Jacquard 4 Special
Nexus
Field 2
Remix 3
Heritage
Savane
Loom Three
Loom Four
Cura
Oceanic
Reel Three (in/out)
Reel Four (in/out)
Reflect
Spin Six

- 5** Silk
Synergy
Step
Step Melange
Blazer
Melange Nap
Chili
Noma
Re-wool
- 6** Go check
Swing
Chartres
Zori
Patio
Tack Two (in/out)
Tack Three (in/out)

- 7** Canvas 2
Select
Clara 2
Tack Five (in/out)
Hero 2

- 8** Capture
Fiord 2
Tonus 4
Divina 3
Lopi
Domino
- 9** Divina MD
Divina Melange 3
Hallingdal 65
Steelcut Trio 3
Tack Four (in/out)

- 11** Arda
Ecriture
Zero

Faux Leather / Eco piel

- 1** Valencia
- 2** Silvertex
- 3** Maglia
- 4** Dolce
- 8** Ultraleather
- 9** Brisa
Brisa Distressed
Fresco
Ultraleather Pro
Promessa
- 10** Tottori
Coast (in/out)
- 11** Reef Pro
Volar Bio

Leather / Piel

- L1** High grade cow leather.
Piel de vaca de 1ª categoría.
- L3** Polished full grain leather.
Piel de vaca pulida.
- L6** Aniline leather batique-effect.
Scandinavian cattle.
Piel anilina efecto batique.
Ganado escandinavo.

Aluminum finish
Acabado aluminio



Eco Thermo-polymer finish
Acabado de Termo-polímero Eco

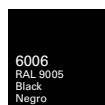

Wood finish Walnut
Acabado madera Nogal

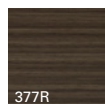

Technical mesh finish
Acabado tejido técnico



Certificates
Certificados

Fireproof polyurethane foam
Espuma de poliuretano ignifuga

UNE EN 1021:2006
BS 5852 part 2 crib 5
UNI 9175 Classe 1 IM
BKZ 5.2
California TB 117:2013
California TB 133*

*Contact our Customer Department
*Consultar con nuestro Departamento Comercial

Quality - Resistance
Calidad - Resistencia

UNE EN 16139:2013

Intellectual property Propiedad intelectual

All our collections are protected by international industrial design registries, designs patents, copyrights and intellectual Property laws. Unauthorized use of AW International Property is a criminal offence and can lead to prosecution.
Todas nuestras colecciones están protegidas por registros de diseño industrial, diseño de patente, copyright y derechos de propiedad intelectual todo el mundo. El uso no autorizado de los diseños y propiedad intelectual de AW supone un delito que puede ser sometido a acción judicial.



SO2285

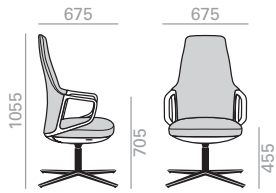

Intermediate backrest armchair with upholstered seat and backrest and 4-star aluminum central swivel base with return system available in polished aluminum, white or black finish. Backrest option in walnut wood.

Sillón de respaldo intermedio con asiento y respaldo tapizado y base central giratoria de aluminio de 4 espas con sistema de retorno disponible en acabado aluminio pulido, blanco o negro. Opción de respaldo en madera de nogal.

COM cm. per unit	COL m2
------------------	--------

Fully upholstered Carcasa tapizada		3
1 units	140	
10 units or more	140	

Walnut back Respaldo nogal		3
1 units	140	
10 units or more	70	

0,57 m3
23,9 kg
x1

COM	COL	1	2	3	4	5	6	7	8	9	10	11	L1	L2	L3	L6
€ 985	999	1.015	1.028	1.039	1.057	1.075	1.093	1.110	1.128	1.148	1.166	1.184	1.199	1.264	1.382	1.694



Walnut back upcharge
Incremento respaldo en nogal | 191 |

SO2286

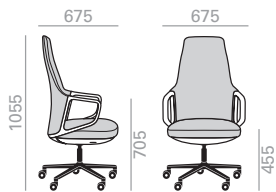

Medium back armchair with upholstered seat and backrest and central swivel base, with tilting system, in aluminum with 5 wheels, adjustable in height and polished aluminum finish, white or black. Backrest option in walnut wood.

Sillón de respaldo intermedio con asiento y respaldo tapizado y base central giratoria, con sistema basculante, de aluminio de 5 ruedas, regulable en altura y acabado aluminio pulido, blanco o negro. Opción de respaldo en madera de nogal.

COM cm. per unit	COL m2
------------------	--------

Fully upholstered Carcasa tapizada		3
1 units	140	
10 units or more	140	

Walnut back Respaldo nogal		3
1 units	140	
10 units or more	70	

0,57 m3
24,6 kg
x1

COM	COL	1	2	3	4	5	6	7	8	9	10	11	L1	L2	L3	L6
€ 955	969	985	999	1.009	1.027	1.045	1.063	1.081	1.099	1.118	1.136	1.154	1.169	1.234	1.352	1.664



Walnut back upcharge
Incremento respaldo en nogal | 192 |

SO2287

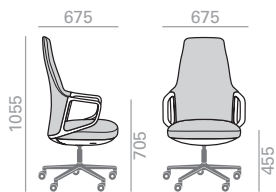

Medium back armchair with upholstered seat and backrest and central swivel base, with tilting system, made of Eco thermopolymer with 5 wheels, adjustable in height and black finish. Backrest option in walnut wood.

Sillón de respaldo intermedio con asiento y respaldo tapizado y base central giratoria, con sistema basculante, de termopolímero Eco de 5 ruedas, regulable en altura y acabado negro. Opción de respaldo en madera de nogal.

COM cm. per unit	COL m2
------------------	--------

Fully upholstered Carcasa tapizada		3
1 units	140	
10 units or more	140	

Walnut back Respaldo nogal		3
1 units	140	
10 units or more	70	

0,57 m3
23,6 kg
x1

COM	COL	1	2	3	4	5	6	7	8	9	10	11	L1	L2	L3	L6
€ 882	896	912	925	936	954	972	990	1.007	1.025	1.043	1.061	1.079	1.096	1.160	1.278	1.591



Walnut back upcharge
Incremento respaldo en nogal | 198 |

SO2288

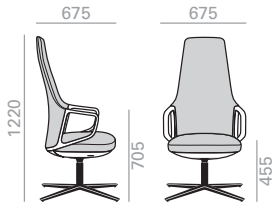

High-back armchair with upholstered seat and backrest and central 4-star aluminum swivel base with return system available in polished aluminum, white or black finish. Available options: backrest in walnut wood and headboard cushion.

Sillón de respaldo alto con asiento y respaldo tapizado y base central giratoria de aluminio de 4 espas con sistema de retorno disponible en acabado aluminio pulido, blanco o negro. Opciones disponibles: respaldo en madera de nogal y cojín cabecero.

COM cm. per unit	COL m2
------------------	--------

0,66 m3
24,5 kg
x1

Fully upholstered Carcasa tapizada		
1 units	160	3,25
10 units or more	160	

Headrest cushion Cojín cabecero		
1 units	50	1
10 units or more	50	

COM	COL	1	2	3	4	5	6	7	8	9	10	11	L1	L2	L3	L6
1.034	1.049	1.069	1.084	1.096	1.116	1.137	1.158	1.178	1.199	1.219	1.240	1.260	1.279	1.352	1.488	1.845



Headrest cushion upcharge
Incremento cojín cabecero

COM	COL	1	2	3	4	5	6	7	8	9	10	11	L1	L2	L3	L6
1.094	1.112	1.134	1.156	1.171	1.198	1.227	1.254	1.281	1.308	1.335	1.362	1.390	1.415	1.512	1.692	2.167



Walnut back upcharge
Incremento respaldo en nogal

245

SO2289



High-back armchair with upholstered seat and backrest and central swivel base, with tilting system, in aluminum with 5 wheels, adjustable table in height and polished aluminum finish, white or black. Available options: backrest in walnut wood and headboard cushion.

Sillón de respaldo alto con asiento y respaldo tapizado y base central giratoria, con sistema basculante, de aluminio de 5 ruedas, regulable en altura y acabado aluminio pulido, blanco o negro. Opciones disponibles: respaldo en madera de nogal y cojín cab

COM cm. per unit	COL m2
------------------	--------

0,66 m3
25,2 kg
x1

Fully upholstered Carcasa tapizada		
1 units	160	3,25
10 units or more	160	

Headrest cushion Cojín cabecero		
1 units	50	1
10 units or more	50	

COM	COL	1	2	3	4	5	6	7	8	9	10	11	L1	L2	L3	L6
1.006	1.022	1.040	1.055	1.067	1.088	1.109	1.130	1.149	1.170	1.191	1.212	1.231	1.251	1.324	1.460	1.816



Headrest cushion upcharge
Incremento cojín cabecero

COM	COL	1	2	3	4	5	6	7	8	9	10	11	L1	L2	L3	L6
1.066	1.085	1.105	1.127	1.142	1.170	1.199	1.226	1.252	1.279	1.307	1.334	1.361	1.387	1.484	1.664	2.138



Walnut back upcharge
Incremento respaldo en nogal

239

SO2290

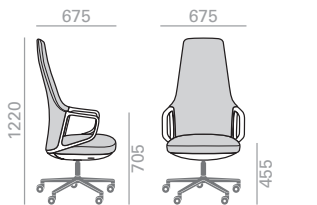

High-back armchair with upholstered seat and backrest and central swivel base, with tilting system, made of Eco thermopolymer with 5 wheels, adjustable in height and black finish. Available options: backrest in walnut wood and headboard cushion.

Sillón de respaldo alto con asiento y respaldo tapizado y base central giratoria, con sistema basculante, de termopolímero Eco de 5 ruedas, regulable en altura y acabado negro. Opciones disponibles: respaldo en madera de nogal y cojín cabecero.

COM cm. per unit	COL m2
------------------	--------

0,66 m3
24,3 kg
x1

Fully upholstered Carcasa tapizada		
1 units	160	3,25
10 units or more	160	

Headrest cushion Cojín cabecero		
1 units	50	1
10 units or more	50	

COM	COL	1	2	3	4	5	6	7	8	9	10	11	L1	L2	L3	L6
933	948	966	982	994	1.015	1.034	1.055	1.076	1.097	1.116	1.137	1.158	1.176	1.251	1.385	1.743



Headrest cushion upcharge
Incremento cojín cabecero

COM	COL	1	2	3	4	5	6	7	8	9	10	11	L1	L2	L3	L6
993	1.011	1.031	1.054	1.069	1.097	1.124	1.151	1.179	1.206	1.232	1.259	1.288	1.312	1.411	1.589	2.065



Walnut back upcharge
Incremento respaldo en nogal

245

SO2291

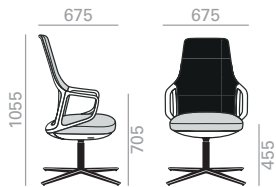

Medium back armchair with upholstered seat, backrest in technical fabric and central swivel aluminum base with 4 blades with return system available in polished aluminum, white or black finish.

Sillón de respaldo intermedio con asiento tapizado, respaldo de tejido técnico y base central giratoria de aluminio de 4 aspas con sistema de retorno disponible en acabado aluminio pulido, blanco o negro.

COM cm. per unit	COL m2
------------------	--------

Upholstered seat Asiento tapizado

1 units	70	1,5
10 units or more	70	

- 0,57 m3
- 23,6 kg
- x1

COM	COL	1	2	3	4	5	6	7	8	9	10	11	L1	L2	L3	L6
€ 1.085	1.093	1.100	1.107	1.112	1.121	1.130	1.139	1.148	1.157	1.166	1.175	1.184	1.193	1.224	1.284	1.440

SO2292

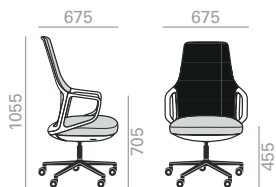

Medium back armchair with upholstered seat, backrest in technical fabric and central swivel base, with tilting system, in aluminum with 5 wheels, adjustable in height and polished aluminum finish, white or black.

Sillón de respaldo intermedio con asiento tapizado, respaldo de tejido técnico y base central giratoria, con sistema basculante, de aluminio de 5 ruedas, regulable en altura y acabado aluminio pulido, blanco o negro.

COM cm. per unit	COL m2
------------------	--------

Upholstered seat Asiento tapizado

1 units	70	1,5
10 units or more	70	

- 0,57 m3
- 25 kg
- x1

COM	COL	1	2	3	4	5	6	7	8	9	10	11	L1	L2	L3	L6
€ 1.055	1.063	1.070	1.078	1.082	1.091	1.100	1.109	1.118	1.127	1.136	1.145	1.154	1.163	1.194	1.254	1.410

SO2293

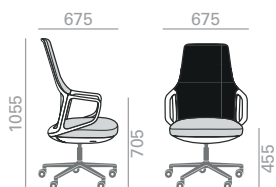

Armchair with intermediate backrest with upholstered seat, backrest in technical fabric and central swivel base, with tilting system, in Eco thermopolymer with 5 wheels, adjustable in height and black finish.

Sillón de respaldo intermedio con asiento tapizado, respaldo de tejido técnico y base central giratoria, con sistema basculante, de termopolímero Eco de 5 ruedas, regulable en altura y acabado negro.

COM cm. per unit	COL m2
------------------	--------

Upholstered seat Asiento tapizado

1 units	70	1,5
10 units or more	70	

- 0,57 m3
- 24 kg
- x1

COM	COL	1	2	3	4	5	6	7	8	9	10	11	L1	L2	L3	L6
€ 984	990	997	1.004	1.010	1.019	1.028	1.037	1.046	1.055	1.064	1.073	1.082	1.090	1.122	1.182	1.337

SO2294

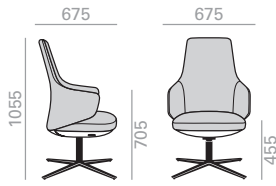

Mid-backed armchair with upholstered shell and central 4-wheel aluminum swivel base with return system, available in polished aluminum, white or black finish. Option of Walnut wood on the exterior of the backrest.

Sillón de respaldo intermedio con carcasa tapizada y base central giratoria de aluminio de 4 aspas con sistema de retorno, disponible en acabado aluminio pulido, blanco o negro. Opción de respaldo en madera de nogal.

COM cm. per unit	COL m2
------------------	--------

Fully upholstered Carcasa tapizada		3,25
1 units	152	
10 units or more	123	

Walnut back Respaldo nogal		1,75
1 units	81	
10 units or more	57	

0,17 m3
 23,9 kg
 x1

COM	COL	1	2	3	4	5	6	7	8	9	10	11	L1	L2	L3	L6
€ 916	930	948	963	973	993	1.012	1.031	1.051	1.070	1.090	1.107	1.127	1.145	1.213	1.340	1.675



Walnut back upcharge
 Incremento respaldo en nogal | 371 |

SO2295

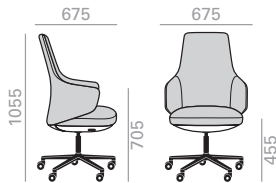

Mid-backed armchair with upholstered shell and central 5-wheeled aluminum swivel base with tilting system, height adjustable and finished in polished aluminum, white or black finish. Option of Walnut wood on the exterior of the backrest.

Sillón de respaldo intermedio con carcasa tapizada y base central giratoria, con sistema basculante, de aluminio de 5 ruedas, regulable en altura y acabado aluminio pulido, blanco o negro. Opción de respaldo en madera de nogal.

COM cm. per unit	COL m2
------------------	--------

Fully upholstered Carcasa tapizada		3,25
1 units	152	
10 units or more	123	

Walnut back Respaldo nogal		1,75
1 units	81	
10 units or more	57	

0,13 m3
 24,6 kg
 x1

COM	COL	1	2	3	4	5	6	7	8	9	10	11	L1	L2	L3	L6
€ 933	948	964	979	991	1.010	1.030	1.048	1.067	1.087	1.106	1.125	1.145	1.161	1.231	1.358	1.693



Walnut back upcharge
 Incremento respaldo en nogal | 371 |

SO2296

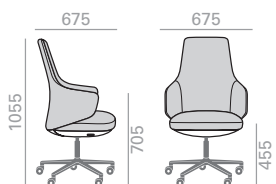

Mid-backed armchair with upholstered shell and central 5-wheeled thermopolymer swivel base with tilting system, height adjustable and finished in polished aluminum, white or black finish. Option of Walnut wood on the exterior of the backrest.

Sillón de respaldo intermedio con carcasa tapizada y base central giratoria, con sistema basculante, de termopolímero Eco de 5 ruedas, regulable en altura y acabado aluminio pulido, blanco o negro. Opción de respaldo en madera de nogal.

COM cm. per unit	COL m2
------------------	--------

Fully upholstered Carcasa tapizada		3,25
1 units	152	
10 units or more	123	

Walnut back Respaldo nogal		1,75
1 units	81	
10 units or more	57	

0,22 m3
 23,6 kg
 x1

COM	COL	1	2	3	4	5	6	7	8	9	10	11	L1	L2	L3	L6
€ 873	888	904	919	931	951	970	988	1.007	1.027	1.046	1.066	1.085	1.101	1.172	1.299	1.633



Walnut back upcharge
 Incremento respaldo en nogal | 371 |

SO2297

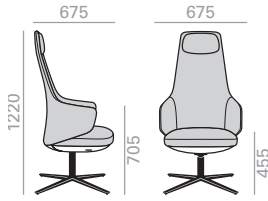

High-backed armchair with upholstered shell and central 4-wheel aluminum swivel base with return system, available in polished aluminum, white or black finish. Available options: Walnut wood on the exterior of the backrest and a head cushion.

Sillón de respaldo alto con carcasa tapizada y base central giratoria de aluminio de 4 aspas con sistema de retorno, disponible en acabado aluminio pulido, blanco o negro. Opciones disponibles: respaldo en madera de nogal y cojín cabecero.

COM cm. per unit	COL m2
------------------	--------

0,19 m3
24,5 kg
x1

Fully upholstered Carcasa tapizada		
1 units	167	3,5
10 units or more	167	

Walnut back Respaldo nogal		
1 units	96	2
10 units or more	69	

COM	COL	1	2	3	4	5	6	7	8	9	10	11	L1	L2	L3	L6
975	990	1.009	1.024	1.036	1.057	1.078	1.099	1.118	1.139	1.160	1.181	1.200	1.219	1.293	1.428	1.785



Headrest cushion upcharge
Incremento cojín cabecero

COM	COL	1	2	3	4	5	6	7	8	9	10	11	L1	L2	L3	L6
1.035	1.053	1.074	1.092	1.105	1.129	1.152	1.175	1.197	1.221	1.245	1.268	1.290	1.312	1.394	1.547	1.950



Walnut back upcharge
Incremento respaldo en nogal

434

SO2298

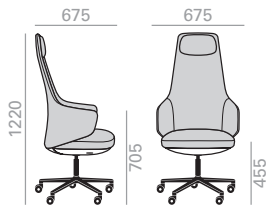

High-backed armchair with upholstered shell and central 5-wheeled aluminum swivel base with tilting system, height adjustable and finished in polished aluminum, white or black finish. Available options: Walnut wood on the exterior of the backrest and a head cushion.

Sillón de respaldo alto con carcasa tapizada y base central giratoria, con sistema basculante, de aluminio de 5 ruedas, regulable en altura y acabado aluminio pulido, blanco o negro. Opciones disponibles: respaldo en madera de nogal y cojín cabecero.

COM cm. per unit	COL m2
------------------	--------

0,22 m3
25,2 kg
x1

Fully upholstered Carcasa tapizada		
1 units	167	3,5
10 units or more	167	

Walnut back Respaldo nogal		
1 units	96	2
10 units or more	69	

COM	COL	1	2	3	4	5	6	7	8	9	10	11	L1	L2	L3	L6
994	1.009	1.027	1.043	1.055	1.076	1.097	1.116	1.137	1.158	1.179	1.199	1.219	1.237	1.312	1.446	1.804



Headrest cushion upcharge
Incremento cojín cabecero

COM	COL	1	2	3	4	5	6	7	8	9	10	11	L1	L2	L3	L6
1.054	1.072	1.092	1.111	1.124	1.148	1.171	1.192	1.216	1.240	1.264	1.286	1.309	1.330	1.413	1.565	1.969



Walnut back upcharge
Incremento respaldo en nogal

434

SO2299

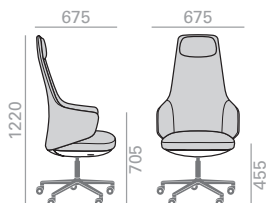

High-backed armchair with upholstered shell and central 5-wheeled thermopolymer swivel base with tilting system, height adjustable and finished in polished aluminum, white or black finish. Available options: Walnut wood on the exterior of the backrest and a head cushion.

Sillón de respaldo alto con carcasa tapizada y base central giratoria, con sistema basculante, de termopolímero Eco de 5 ruedas, regulable en altura y acabado negro. Opciones disponibles: respaldo en madera de nogal y cojín cabecero.

COM cm. per unit	COL m2
------------------	--------

0,19 m3
24,3 kg
x1

Fully upholstered Carcasa tapizada		
1 units	167	3,5
10 units or more	167	

Walnut back Respaldo nogal		
1 units	96	2
10 units or more	69	

COM	COL	1	2	3	4	5	6	7	8	9	10	11	L1	L2	L3	L6
933	948	966	982	994	1.015	1.034	1.055	1.076	1.097	1.116	1.137	1.158	1.176	1.251	1.385	1.743



Headrest cushion upcharge
Incremento cojín cabecero

COM	COL	1	2	3	4	5	6	7	8	9	10	11	L1	L2	L3	L6
993	1.011	1.031	1.050	1.063	1.087	1.108	1.131	1.155	1.179	1.201	1.224	1.248	1.269	1.352	1.504	1.908



Walnut back upcharge
Incremento respaldo en nogal

434

Glides for 4 star aluminum central base.

Tacos para base central de aluminio de 4 aspas.

Use/Usó	Reference/Referencia	Material/Material	Price/Precio
Hard floors. Suelos duros.	TS0544	Plastic (PE). Plástico (PE).	0 € Standard. Estándar.
Wooden and delicated floors. Suelos de madera y delicados.	TS0556	Plastic (PE) with felt. Plástico (PE) con fieltro.	3 € Set of 4 glides. Juego de 4 tacos.
Mats/carpet floors. Suelos de moqueta/ alfombra.	TS0557	No glide. Sin taco.	0 €

The indicated price is for glides placed on chairs. To order loose parts, please ask to our Sales Department.

El precio indicado en Tarifa es para tacos colocados en las sillas. Para pedidos de tacos sueltos de repuesto, consultar con el Departamento Comercial.



Description

Descripción

Chairs and armchairs with upholstered shell. Available in 3 back heights. The available base options are: aluminum swivel 4-star base with self-return and finished in polished aluminum white or black, aluminum central base with 5 casters, swivel and pneumatic height adjustment finished in polished aluminum, white or black and ECO thermo-polymer central base with 5 casters, swivel and pneumatic height adjustment, finished in black. Armchair versions with central swivel aluminum bases with 4 star base with return system in polished aluminum, white or black finish or central swivel base with 5 casters and height-adjustable finished in polished aluminum, white or black. Available options: tilting system and back in walnut wood. Additional options include: Tilting mechanism and back finished in walnut veneer.

Sillas y sillones con carcasa tapizada. Disponibles en 3 alturas diferentes de respaldo. Las bases disponibles son: base central giratoria de aluminio de 4 aspas con sistema de retorno en acabado aluminio pulido, blanco o negro, base central giratoria con 5 ruedas regulable en altura disponible en aluminio pulido, blanco o negro y base central giratoria de termopolímero ECO de 5 ruedas, regulable en altura y acabado negro. Versiones de butaca con bases central giratoria de aluminio de 4 aspas con sistema de retorno en acabado aluminio pulido, blanco o negro o base central giratoria con 5 ruedas regulable en altura en acabado aluminio pulido, blanco o negro. Opciones disponibles: sistema basculante y respaldo en madera de nogal.

Upholstery

Tapicería

The Capri Executive collection supports following upholsteries of Andreu World Catalogue. For fabrics in our catalogue not specified in this box or customers own materials please contact our Customer Service Department.

La colección Capri Executive admite las siguientes tapicerías del catálogo de Andreu World. Para las telas de nuestro catálogo no indicadas en este cuadro o telas cliente, consultar con nuestro Departamento Comercial.

Fabrics / Telas

- 1 Soft-fiber
- Jacquard One
- Jacquard Three
- Citadel
- Sand
- Era
- Gravity
- Rivet
- Urban
- Spin One
- Spin Two
- Spin Three
- Spin Four
- Spin Five

- 2 Jacquard Two
- Loom One
- Circular One Pure Eco
- Tack One (in/out)

- 3 Jacquard Four
- Medley
- Revive 1
- Natte
- Main Line Flax
- Loom Two (in/out)
- Mezzo
- Reel two (in/out)
- Jacquard Five

- 4 Jacquard 4 Special
- Nexus
- Field 2
- Remix 3
- Heritage
- Savane
- Loom Three
- Loom Four
- Cura
- Oceanic
- Reel Three (in/out)
- Reel Four (in/out)
- Reflect
- Spin Six

- 5 Silk
- Synergy
- Step
- Step Melange
- Blazer
- Melange Nap
- Chilli
- Noma
- Re-wool

- 6 Go check
- Swing
- Chartres
- Zori
- Patio
- Tack Two (in/out)
- Tack Three (in/out)

- 7 Canvas 2
- Select
- Clara 2
- Tack Five (in/out)
- Hero 2

- 8 Capture
- Fiord 2
- Tonus 4
- Divina 3
- Lopi
- Domino

- 9 Divina MD
- Divina Melange 3
- Hallingdal 65
- Steelcut Trio 3
- Tack Four (in/out)

- 11 Arda
- Ecriture
- Zero

Faux Leather / Ecopiel

- 1 Valencia
- 2 Silvertext
- 3 Maglia
- 4 Dolce
- 8 Ultraleather
- 9 Brisa
- Brisa Distressed
- Fresco
- Ultraleather Pro
- Promessa

- 10 Tottori
- Coast (in/out)

- 11 Reef Pro
- Volar Bio

Leather / Piel

- L1 High grade cow leather.
- Piel de vaca de 1ª categoría.
- L3 Polished full grain leather.
- Plena flor pulida.
- L6 Aniline leather batique-effect.
- Scandinavian cattle.
- Piel anilina efecto batique.
- Ganado escandinavo.

Wood finish Walnut

Acabado madera Nogal

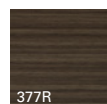

Eco Thermo-polymer finish

Acabado de Termo-polimero Eco

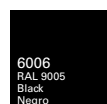

Aluminum finish

Acabado aluminio

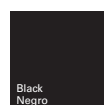
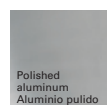

Certificates

Certificados

Fireproof polyurethane foam

Espuma de poliuretano ignifuga

UNE EN 1021:2006
BS 5852 part 2 crib 5
UNI 9175 Classe 1 IM
BKZ 5.2
California TB 117:2013
California TB 133*

*Contact our Customer Department
*Consultar con nuestro Departamento Comercial

Quality - Resistance

Calidad - Resistencia

UNE EN 16139:2013

Intellectual property Propiedad intelectual

All our collections are protected by international industrial design registries, designs patents, copyrights and intellectual Property laws. Unauthorized use of AW International Property is a criminal offence and can lead to prosecution.

Todas nuestras colecciones están protegidas por registros de diseño industrial, diseño de patente, copyright y derechos de propiedad intelectual todo el mundo. El uso no autorizado de los diseños y propiedad intelectual de AW supone un delito que puede ser sometido a acción judicial.



SI1563



Low back chair with upholstered shell and aluminum swivel 4-star base with self-return system and finished in polished aluminum, white or black. Additional options include: tilting mechanism and back finished in walnut veneer.

Silla de respaldo bajo con carcasa tapizada y base central giratoria de aluminio de 4 aspas con sistema de retorno disponible en acabado aluminio pulido, blanco o negro. Opciones disponibles: sistema basculante y respaldo en madera de nogal.

COM cm. per unit	COL m2
------------------	--------

0,47 m3
17,8 kg
x1

Fully upholstered Carcasa tapizada		
1 units	140	3
10 units or more	120	

Walnut back Respaldo nogal		
1 units	115	2,5
10 units or more	110	

COM	COL	1	2	3	4	5	6	7	8	9	10	11	L1	L2	L3	L6
€ 752	765	779	791	801	816	834	849	865	882	898	913	929	944	1.010	1.183	1.396



SI1564

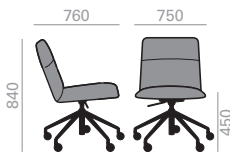

Low back chair with upholstered shell and aluminum central base with 5 casters, swivel and pneumatic height adjustment. Available in polished aluminum, white or black. Additional options include: tilting mechanism and back finished in walut veneer. Seat height range: 450-570 mm.

Silla de respaldo bajo con carcasa tapizada y base central giratoria de aluminio de 5 ruedas, regulable en altura y acabado aluminio pulido, blanco o negro. Opciones disponibles: sistema basculante y respaldo en madera de nogal. Rango de altura de asiento: 450-570 mm.

COM cm. per unit	COL m2
------------------	--------

0,42 m3
16,3 kg
x1

Fully upholstered Carcasa tapizada		
1 units	140	3
10 units or more	120	

Walnut back Respaldo nogal		
1 units	115	2,5
10 units or more	110	

COM	COL	1	2	3	4	5	6	7	8	9	10	11	L1	L2	L3	L6
€ 759	772	786	799	810	826	844	860	877	895	911	929	945	961	1.070	1.179	1.431

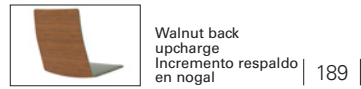

SI1565

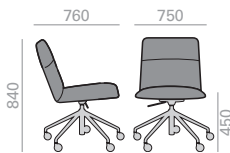

Low back chair with upholstered shell and Eco thermo-polymer central base with 5 casters, swivel and pneumatic height adjustment, finished in black. Additional options include: tilting mechanism and back finished in walnut veneer. Seat height range: 450-570 mm.

Silla de respaldo bajo con carcasa tapizada y base central giratoria de termopolimero Eco de 5 ruedas, regulable en altura y acabado negro. Opciones disponibles: sistema basculante y respaldo en madera de nogal. Rango de altura de asiento: 450-570 mm.

COM cm. per unit	COL m2
------------------	--------

0,44 m3
15,3 kg
x1

Fully upholstered Carcasa tapizada		
1 units	140	3
10 units or more	120	

Walnut back Respaldo nogal		
1 units	115	2,5
10 units or more	110	

COM	COL	1	2	3	4	5	6	7	8	9	10	11	L1	L2	L3	L6
€ 600	612	625	637	646	660	675	691	706	720	735	750	775	782	879	967	1.193

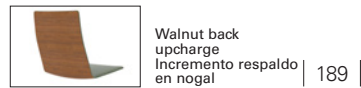

SI1566



Intermediate back chair with upholstered shell and aluminum swivel 4- star base with self-return system and finished in polished aluminum, white or black. Additional options include: tilting mechanism and back finished in walnut veneer.

Silla de respaldo intermedio con carcasa tapizada y base central giratoria de aluminio de 4 aspas con sistema de retorno disponible acabado aluminio pulido, blanco o negro. Opciones disponibles: sistema basculante y respaldo en madera de nogal.

COM cm. per unit	COL m2
------------------	--------

0,5 m3
20 kg
x1

Fully upholstered Carcasa tapizada		
1 units	150	3
10 units or more	130	

Walnut back Respaldo nogal		
1 units	125	2,5
10 units or more	120	

COM	COL	1	2	3	4	5	6	7	8	9	10	11	L1	L2	L3	L6
€ 795	807	823	837	846	863	881	898	915	932	948	965	982	998	1.138	1.257	1.495

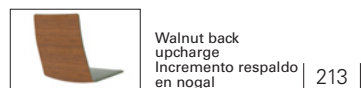

SI1567

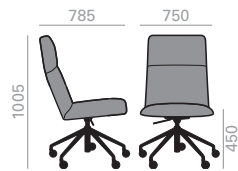

Intermediate back chair with upholstered shell and aluminum central base with 5 casters, swivel and pneumatic height adjustment. Finished in polished aluminum, white or black. Additional options include: tilting mechanism and back finished in walnut veneer. Seat height range: 450-570 mm.

Silla de respaldo intermedio con carcasa tapizada y base central giratoria de aluminio de 5 ruedas, regulable en altura y acabado aluminio pulido, blanco o negro. Opciones disponibles: sistema basculante y respaldo en madera de nogal. Rango de altura de asiento: 450-570 mm.

COM cm. per unit	COL m2
------------------	--------

0,51 m3
18,5 kg
x1

Fully upholstered Carcasa tapizada		
1 units	150	3
10 units or more	130	

Walnut back Respaldo nogal		
1 units	125	2,5
10 units or more	120	

COM	COL	1	2	3	4	5	6	7	8	9	10	11	L1	L2	L3	L6	
€	754	767	782	795	806	822	839	856	873	889	907	959	967	976	1.095	1.206	1.483

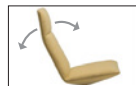

Tilting mechanism upcharge
Incremento por sistema basculante

35



Walnut back upcharge
Incremento respaldo en nogal

213

SI1568

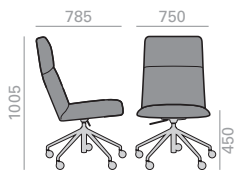

Intermediate back chair with upholstered shell and Eco thermo-polymer central base with 5 casters, swivel and pneumatic height adjustment, finished in black. Additional options include: tilting mechanism and back finished in walnut veneer. Seat height range: 450-570 mm.

Silla de respaldo intermedio con carcasa tapizada y base central giratoria de termopolímero Eco de 5 ruedas, regulable en altura y acabado negro. Opciones disponibles: sistema basculante y respaldo en madera de nogal. Rango de altura de asiento: 450-570 mm.

COM cm. per unit	COL m2
------------------	--------

0,76 m3
17,5 kg
x1

Fully upholstered Carcasa tapizada		
1 units	150	3
10 units or more	150	

Walnut back Respaldo nogal		
1 units	125	2,5
10 units or more	120	

COM	COL	1	2	3	4	5	6	7	8	9	10	11	L1	L2	L3	L6	
€	655	666	681	694	703	719	735	752	768	784	802	818	840	849	953	1.050	1.297

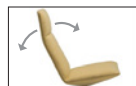

Tilting mechanism upcharge
Incremento por sistema basculante

35



Walnut back upcharge
Incremento respaldo en nogal

213

SI1569



High back chair with upholstered shell and aluminum swivel 4-star base with self-return system and finished in polished aluminum, white or black. Additional options include: tilting mechanism and back finished in walnut veneer.

Silla de respaldo alto con carcasa tapizada y base central giratoria de aluminio de 4 aspas con sistema de retorno disponible en acabado aluminio pulido, blanco o negro. Opciones disponibles: sistema basculante y respaldo en madera de nogal.

COM cm. per unit	COL m2
------------------	--------

0,6 m3
23,5 kg
x1

Fully upholstered Carcasa tapizada		
1 units	160	3,25
10 units or more	160	

Walnut back Respaldo nogal		
1 units	150	3
10 units or more	140	

COM	COL	1	2	3	4	5	6	7	8	9	10	11	L1	L2	L3	L6	
€	826	840	859	875	886	906	926	946	966	986	1.007	1.041	1.103	1.129	1.234	1.370	1.674

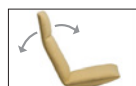

Tilting mechanism upcharge
Incremento por sistema basculante

35



Walnut back upcharge
Incremento respaldo en nogal

263

SI1570



High back chair with upholstered shell and aluminum central base with 5 casters, swivel and pneumatic height adjustment. Available in polished aluminum, white or black. Additional options include: tilting mechanism and back finished in walnut veneer. Seat height range: 450-570 mm.

Silla de respaldo alto con carcasa tapizada y base central giratoria de aluminio de 5 ruedas, regulable en altura y acabado aluminio pulido, blanco o negro. Opciones disponibles: sistema basculante y respaldo en madera de nogal. Rango de altura de asiento: 450-570 mm.

COM cm. per unit	COL m2
------------------	--------

0,76 m3
22 kg
x1

Fully upholstered Carcasa tapizada		
1 units	160	3,25
10 units or more	160	

Walnut back Respaldo nogal		
1 units	150	3
10 units or more	140	

COM	COL	1	2	3	4	5	6	7	8	9	10	11	L1	L2	L3	L6	
€	826	842	861	877	890	910	930	952	972	994	1.014	1.073	1.096	1.118	1.243	1.379	1.682

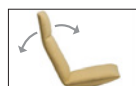

Tilting mechanism upcharge
Incremento por sistema basculante

35



Walnut back upcharge
Incremento respaldo en nogal

263

SI1571

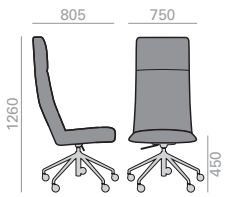

High back chair with upholstered shell and Eco thermo-polymer central base with 5 casters, swivel and pneumatic height adjustment, finished in black. Additional options include: tilting mechanism and back finished in walnut veneer. Seat height range: 450-570 mm.

Silla de respaldo alto con carcasa tapizada y base central giratoria de termopolímero Eco de 5 ruedas, regulable en altura y acabado negro. Opciones disponibles: sistema basculante y respaldo en madera de nogal. Rango de altura de asiento: 450-570 mm.

COM cm. per unit	COL m2
------------------	--------

0,76 m3
21 kg
x1

Fully upholstered Carcasa tapizada		
1 units	160	3,25
10 units or more	160	

Walnut back Respaldo nogal		
1 units	150	3
10 units or more	140	

COM	COL	1	2	3	4	5	6	7	8	9	10	11	L1	L2	L3	L6
€ 716	731	748	764	774	795	815	834	854	875	894	914	946	955	1.082	1.199	1.502

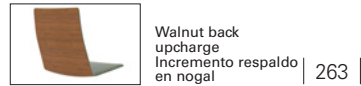

SO1573



Low back armchair with upholstered shell, aluminum arms with upholstered top face and aluminum swivel 4-star base with self-return system and finished in polished aluminum, white or black. Additional options include: tilting mechanism and back finished in walnut veneer.

Sillón de respaldo bajo con carcasa tapizada, brazos de aluminio con parte superior tapizada y base central giratoria de aluminio de 4 aspas con sistema de retorno disponible en acabado aluminio pulido, blanco o negro. Opciones disponibles: sistema basculante y res aldo en madera de nogal.

COM cm. per unit	COL m2
------------------	--------

0,47 m3
21,3 kg
x1

Fully upholstered Carcasa tapizada		
1 units	140	3
10 units or more	120	

Walnut back Respaldo nogal		
1 units	115	2,5
10 units or more	110	

COM	COL	1	2	3	4	5	6	7	8	9	10	11	L1	L2	L3	L6
€ 960	971	985	998	1.006	1.021	1.036	1.052	1.067	1.082	1.097	1.112	1.129	1.142	1.197	1.457	1.699

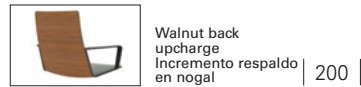

SO1575

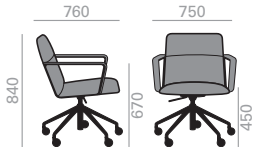

Low back armchair with upholstered shell, aluminum arms with upholstered top face and aluminum central base with 5 casters, swivel and pneumatic height adjustment. Available in polished aluminum, white or black. Additional options include tilting mechanism and back finished in walnut veneer. Height ranges: seat 450-570 mm./arms 670-790 mm.

Sillón de respaldo bajo con carcasa tapizada, brazos de aluminio con parte superior tapizada y base central giratoria de aluminio de 5 ruedas, regulable en altura y acabado aluminio pulido, blanco o negro. Opciones disponibles: sistema basculante y respaldo en madera de nogal. Rangos de altura: asiento 450-570 mm./brazos 670-790 mm.

COM cm. per unit	COL m2
------------------	--------

0,49 m3
19,8 kg
x1

Fully upholstered Carcasa tapizada		
1 units	140	3
10 units or more	120	

Walnut back Respaldo nogal		
1 units	115	2,5
10 units or more	110	

COM	COL	1	2	3	4	5	6	7	8	9	10	11	L1	L2	L3	L6
€ 959	971	985	998	1.007	1.022	1.039	1.054	1.071	1.086	1.102	1.118	1.133	1.149	1.206	1.455	1.658

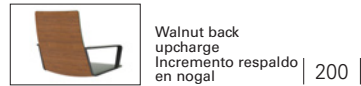

SO1577

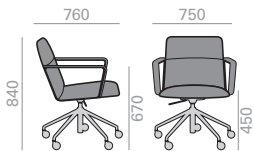

Low back armchair with upholstered shell, aluminum arms with upholstered top face and Eco thermo-polymer central base with 5 casters swivel and pneumatic height adjustment, finished in black. Additional options include: tilting mechanism and back finished in walnut veneer. Height ranges: seat 450-570 mm./arms 670-790 mm.

Sillón de respaldo bajo con carcasa tapizada, brazos de aluminio con parte superior tapizada y base central giratoria de termopolímero Eco de 5 ruedas, regulable en altura y acabado negro. Opciones disponibles: sistema basculante y respaldo en madera de nogal. Rangos de altura: asiento 450-570 mm./brazos 670-790 mm.

COM cm. per unit	COL m2
------------------	--------

0,49 m3
18,8 kg
x1

Fully upholstered Carcasa tapizada		
1 units	140	3
10 units or more	120	

Walnut back Respaldo nogal		
1 units	115	2,5
10 units or more	110	

COM	COL	1	2	3	4	5	6	7	8	9	10	11	L1	L2	L3	L6
€ 825	837	851	863	872	888	904	919	935	950	967	982	997	1.011	1.068	1.265	1.443

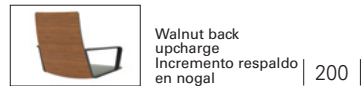

SO1579

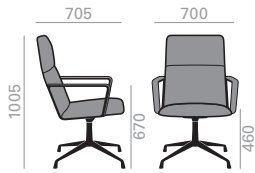

Intermediate back armchair with upholstered shell, aluminum arms with upholstered top face and aluminum swivel 4-star base with self-return system and finished in polished aluminum, white or black. Additional options include: tilting mechanism and back finished in walnut veneer.

Sillón de respaldo intermedio con carcasa tapizada, brazos de aluminio con parte superior tapizada y base central giratoria de aluminio de 4 aspas con sistema de retorno disponible en acabado aluminio pulido, blanco o negro. Opciones disponibles: sistema basculante respaldo en madera de nogal.

COM cm. per unit	COL m2
------------------	--------

0,55 m3
23,5 kg
x1

Fully upholstered Carcasa tapizada		3
1 units	150	
10 units or more	130	

Walnut back Respaldo nogal		2,5
1 units	125	
10 units or more	120	

COM	COL	1	2	3	4	5	6	7	8	9	10	11	L1	L2	L3	L6	
€	995	1.008	1.023	1.035	1.045	1.061	1.078	1.094	1.111	1.127	1.144	1.160	1.177	1.236	1.269	1.523	1.815

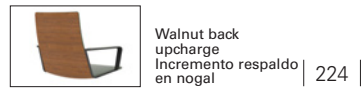

SO1581

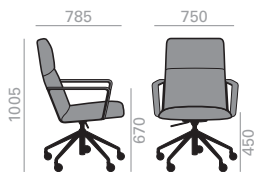

Intermediate back armchair with upholstered shell, aluminum arms with upholstered top face and aluminum central base with 5 casters, swivel and pneumatic height adjustment. Available in polished aluminum, white or black. Additional options include: tilting mechanism and back finished in walnut veneer. Height ranges: seat 450-570 mm./arms 670-790 mm.

Sillón de respaldo intermedio con carcasa tapizada, brazos de aluminio con parte superior tapizada y base central giratoria de aluminio de 5 ruedas, regulable en altura y acabado aluminio pulido, blanco o negro. Opciones disponibles: sistema basculante y respaldo en madera de nogal. Rangos de altura: asiento 450-570 mm./brazos 670-790 mm.

COM cm. per unit	COL m2
------------------	--------

0,61 m3
22 kg
x1

Fully upholstered Carcasa tapizada		3
1 units	150	
10 units or more	130	

Walnut back Respaldo nogal		2,5
1 units	125	
10 units or more	120	

COM	COL	1	2	3	4	5	6	7	8	9	10	11	L1	L2	L3	L6	
€	1.044	1.058	1.074	1.088	1.098	1.117	1.134	1.153	1.171	1.188	1.207	1.225	1.243	1.260	1.324	1.546	1.853

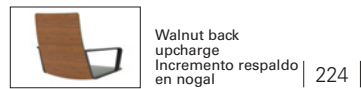

SO1583

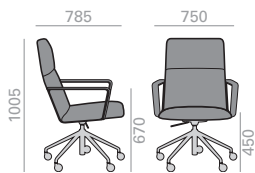

Intermediate back armchair with upholstered shell, aluminum arms with upholstered top face and Eco thermo-polymer central base with 5 casters, swivel and pneumatic height adjustment, finished in black. Additional options include: tilting mechanism and back finished in walnut veneer. Height ranges: seat 450-570 mm./arms 670-790 mm.

Sillón de respaldo intermedio con carcasa tapizada, brazos de aluminio con parte superior tapizada y base central giratoria de termopolímero ECO con 5 ruedas, regulable en altura y acabado en negro. Opciones disponibles: sistema basculante y respaldo en madera de nogal Rangos de altura: asiento 450-570 mm./brazos 670-790 mm.

COM cm. per unit	COL m2
------------------	--------

0,6 m3
21 kg
x1

Fully upholstered Carcasa tapizada		3
1 units	150	
10 units or more	130	

Walnut back Respaldo nogal		3
1 units	125	
10 units or more	120	

COM	COL	1	2	3	4	5	6	7	8	9	10	11	L1	L2	L3	L6	
€	881	893	908	922	931	949	966	983	1.001	1.018	1.034	1.051	1.069	1.085	1.147	1.345	1.613

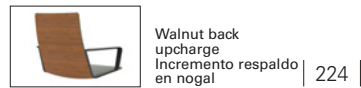

SO1585

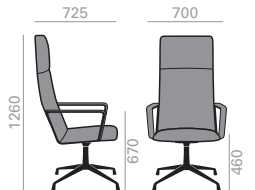

High back armchair with upholstered shell, aluminum arms with upholstered top face and aluminum swivel 4-star base with self-return system and finished in polished aluminum, white or black. Additional options include: tilting mechanism and back finished in walnut veneer.

Sillón de respaldo alto con carcasa tapizada, brazos de aluminio con parte superior tapizada y base central giratoria de aluminio de 4 aspas con sistema de retorno disponible en acabado aluminio pulido, blanco o negro. Opciones disponibles: sistema basculante y respaldo en madera de nogal.

COM cm. per unit	COL m2
------------------	--------

0,68 m3
27 kg
x1

Fully upholstered Carcasa tapizada		3,25
1 units	155	
10 units or more	155	

Walnut back Respaldo nogal		3
1 units	150	
10 units or more	140	

COM	COL	1	2	3	4	5	6	7	8	9	10	11	L1	L2	L3	L6	
€	1.085	1.100	1.118	1.133	1.144	1.165	1.184	1.205	1.224	1.245	1.264	1.283	1.304	1.375	1.558	1.712	2.035

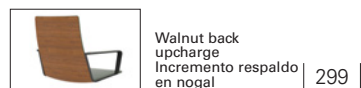

SO1587

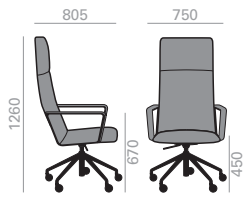

High back armchair with upholstered shell, aluminum arms with upholstered top face and aluminum central base with 5 casters, swivel and pneumatic height adjustment. Available in polished aluminum, white or black. Additional options include: tilting mechanism and back finished in walnut veneer. Height ranges: seat 450-570 mm./arms 670-790 mm.

Sillón de respaldo alto con carcasa tapizada, brazos de aluminio con parte superior tapizada y base central giratoria de aluminio de 5 ruedas, regulable en altura y acabado aluminio pulido, blanco o negro. Opciones disponibles: sistema basculante y respaldo en madera de nogal. Rangos de altura: asiento 450-570 mm./brazos 670-790 mm.

COM cm. per unit	COL m2
---------------------	-----------

0,66 m3
25,5 kg
x1

Fully upholstered Carcasa tapizada		3,25
1 units	155	
10 units or more	155	

Walnut back Respaldo nogal		3
1 units	150	
10 units or more	140	

COM	COL	1	2	3	4	5	6	7	8	9	10	11	L1	L2	L3	L6	
€	1.125	1.142	1.161	1.178	1.190	1.211	1.233	1.253	1.276	1.296	1.322	1.346	1.381	1.392	1.562	1.716	2.058

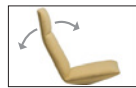

Tilting mechanism
upcharge
Incremento por
sistema basculante

35



Walnut back
upcharge
Incremento respaldo
en nogal

299

SO1589

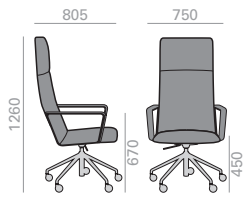

High back armchair with upholstered shell, aluminum arms with upholstered top face and Eco thermo-polymer central base with 5 caster, swivel and pneumatic height adjustment, finished in black. Additional options include: tilting mechanism and back finished in walnut veneer. Height ranges: seat 450-570 mm./arms 670-790 mm.

Sillón de respaldo alto con carcasa tapizada, brazos de aluminio con parte superior tapizada y base central giratoria de termopolímero Eco de 5 ruedas, regulable en altura y acabado negro. Opciones disponibles: sistema basculante y respaldo en madera de nogal. Rangos de altura: asiento 450-570 mm./brazos 670-790 mm.

COM cm. per unit	COL m2
---------------------	-----------

0,84 m3
24,5 kg
x1

Fully upholstered Carcasa tapizada		3,25
1 units	155	
10 units or more	155	

Walnut back Respaldo nogal		3
1 units	150	
10 units or more	140	

COM	COL	1	2	3	4	5	6	7	8	9	10	11	L1	L2	L3	L6	
€	949	966	983	999	1.011	1.030	1.050	1.071	1.091	1.112	1.131	1.161	1.200	1.212	1.358	1.492	1.777

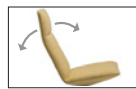

Tilting mechanism
upcharge
Incremento por
sistema basculante

35



Walnut back
upcharge
Incremento respaldo
en nogal

299

Glides for central base. Tacos para base central.

Use/Usu	Reference/Referencia	Material/Material	Price/Precio
Hard floors. Suelos duros.	TS0550	Plastic (PE). Plástico (PE).	0 € Standard. Estándar.
Wooden and delicated floors. Suelos de madera y delicados.	TS0551	Plastic (PE) with felt. Plástico (PE) con fieltro.	3 € Set of 4 glides. Juego de 4 tacos.
Mats/carpet floors. Suelos de moqueta/ alfombra.	TS0552	Metal. Metal.	3 €

The indicated price is for glides placed on chairs. To order loose parts, please ask to our Sales Department.
El precio indicado en Tarifa es para tacos colocados en las sillas. Para pedidos de tacos sueltos de repuesto, consultar con el Departamento Comercial.

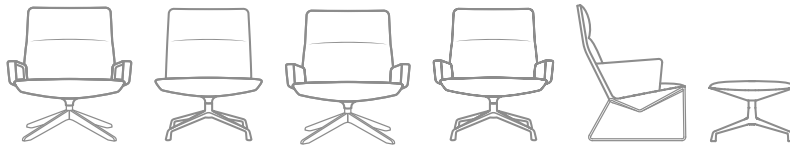

Description

Descripción

Lounge chair with upholstered shell. The available base options are: aluminum swivel 4-star base with self-return system finished in polished aluminum, white or black and available with tilting mechanism, steel sled base finished in polished chrome, white or black and 4-star solid beech wood central swivel base. Lounge chair versions with fully upholstered arms or aluminum arms with upholstered top face. Additional options include: upholstered ottoman with aluminum swivel four-star base with self-return system and finished in polished aluminum, white or black.

Butacas con carcasa tapizada. Las bases disponibles son: central giratoria de aluminio de 4 aspas con sistema de retorno en acabado aluminio pulido, blanco o negro y opción de sistema basculante, base de patín de varilla de acero en acabado cromo brillo, blanco o negro y base central giratoria de 4 aspas de madera maciza de haya. Versiones de butacas con brazos completamente tapizados o brazos de aluminio con parte superior tapizada. Disponible reposapiés con base central de aluminio de 4 aspas y acabado aluminio pulido, blanco o negro.

Upholstery

Tapicería

The Capri Lounge collection supports following upholsteries of Andreu World Catalogue. For fabrics in our catalogue not specified in this box or customers own materials please contact our Customer Service Department.

La colección Capri Lounge admite las siguientes tapicerías del catálogo de Andreu World. Para las telas de nuestro catálogo no indicadas en este cuadro o telas cliente, consultar con nuestro Departamento Comercial.

Fabrics / Telas

- 1 Soft-fiber
Jacquard One
Jacquard Three
Citadel
Sand
Era
Gravity
Rivet
Urban
Spin One
Spin Two
Spin Three
Spin Four
Spin Five
- 2 Jacquard Two
Loom One
Circular One Pure Eco
Tack One (in/out)

- 3 Jacquard Four
Medley
Revive 1
Natte
Main Line Flax
Loom Two (in/out)
Mezzo
Reel two (in/out)
Jacquard Five

- 4 Jacquard 4 Special
Nexus
Field 2
Remix 3
Heritage
Savane
Loom Three
Loom Four
Cura
Oceanic
Reel Three (in/out)
Reel Four (in/out)
Reflect
Spin Six

- 5 Silk
Synergy
Step
Step Melange
Blazer
Melange Nap
Chili
Norma
Re-wool

- 6 Go check
Swing
Chartres
Zori
Patio
Tack Two (in/out)
Tack Three (in/out)

- 7 Canvas 2
Select
Clara 2
Tack Four (in/out)
Hero 2

- 8 Capture
Fiord 2
Tonus 4
Divina 3
Lopi
Domino
- 9 Divina MD
Divina Melange 3
Hallingdal 65
Steelcut Trio 3
Tack Four (in/out)

- 11 Arda
Ecriture
Zero

Faux Leather / Ecopiel

- 1 Valencia
- 2 Silvertex
- 3 Maglia
- 4 Dolce
- 8 Ultraleather
- 9 Brisa
Brisa Distressed
Fresco
Ultraleather Pro
Promessa
- 10 Tottori
Coast (in/out)
- 11 Reef Pro
Volar Bio

Leather / Piel

- L1 High grade cow leather.
Piel de vaca de 1ª categoría.
- L3 Polished full grain leather.
Plena flor pulida.
- L6 Aniline leather batique-effect.
Scandinavian cattle.
Piel anilina efecto batique.
Ganado escandinavo.

**Wood finish Beech
Acabado madera Haya**

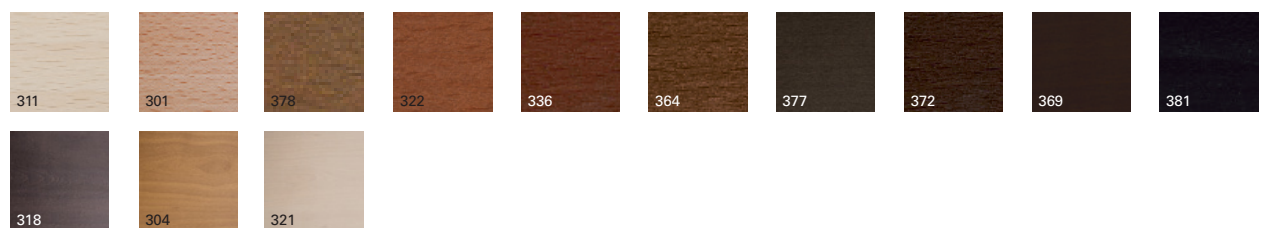

**Premium finish and wood lacquers
Acabado premium y lacas madera**



**Aluminum finish
Acabado aluminio**



Certificates

Certificados

Fireproof polyurethane foam

Espuma de poliuretano ignifuga

UNE EN 1021:2006
BS 5852 part 2 crib 5
UNI 9175 Classe 1 IM
BKZ 5.2
California TB 117:2013
California TB 133*

*Contact our Customer Department
*Consultar con nuestro Departamento Comercial

Quality - Resistance

Calidad - Resistencia

UNE EN 16139:2013

Intellectual property Propiedad intelectual

All our collections are protected by international industrial design registries, designs patents, copyrights and intellectual Property laws. Unauthorized use of AW International Property is a criminal offence and can lead to prosecution.

Todas nuestras colecciones están protegidas por registros de diseño industrial, diseño de patente, copyright y derechos de propiedad intelectual todo el mundo. El uso no autorizado de los diseños y propiedad intelectual de AW supone un delito que puede ser sometido a acción judicial.



BU1692



Lounge chair with upholstered shell and aluminum swivel 4-star base with self-return system and finished in polished aluminum, white or black. Additional options include: tilting mechanism.

Butaca con carcasa tapizada y base central giratoria de aluminio de 4 aspas con sistema de retorno disponible en acabado aluminio pulido, blanco o negro. Opciones disponibles: sistema basculante.

	COM cm. per unit	COL m2
1 units	215	5
10 units or more	185	

0,68 m3
 26,5 kg
 x1

COM	COL	1	2	3	4	5	6	7	8	9	10	11	L1	L2	L3	L6
€ 1.059	1.078	1.102	1.121	1.136	1.163	1.188	1.215	1.240	1.266	1.292	1.318	1.344	1.367	1.460	1.631	2.097

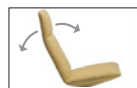

Tilting mechanism upcharge
 Incremento por sistema basculante

| 90 |

BU1693

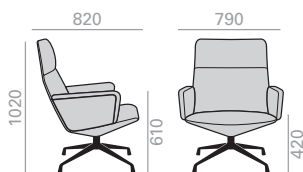

Lounge chair with upholstered shell and arms and aluminum swivel 4-star base with self-return system and finished in polished aluminum, white or black. Additional options include: tilting mechanism.

Butaca con carcasa y brazos tapizados y base central giratoria de aluminio de 4 aspas con sistema de retorno disponible en acabado aluminio pulido, blanco o negro. Opciones disponibles: sistema basculante.

	COM cm. per unit	COL m2
1 units	290	6,5
10 units or more	290	

0,69 m3
 28 kg
 x1

COM	COL	1	2	3	4	5	6	7	8	9	10	11	L1	L2	L3	L6
€ 1.478	1.508	1.546	1.576	1.601	1.641	1.682	1.722	1.762	1.804	1.845	1.885	1.928	1.969	2.128	2.425	3.203

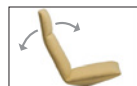

Tilting mechanism upcharge
 Incremento por sistema basculante

| 90 |

BU1694

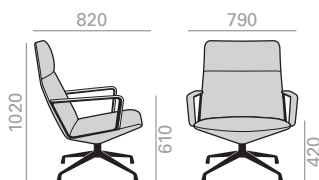

Lounge chair with upholstered shell, aluminum arms with upholstered top face and aluminum swivel 4-star base with self-return system and finished in polished aluminum, white or black. Additional options include: tilting mechanism.

Butaca con carcasa tapizada, brazos de aluminio con parte superior tapizada y base central giratoria de aluminio de 4 aspas con sistema de retorno disponible en acabado aluminio pulido, blanco o negro. Opciones disponibles: sistema basculante.

	COM cm. per unit	COL m2
1 units	230	5
10 units or more	210	

0,69 m3
 27 kg
 x1

COM	COL	1	2	3	4	5	6	7	8	9	10	11	L1	L2	L3	L6
€ 1.297	1.317	1.342	1.363	1.379	1.406	1.433	1.459	1.488	1.514	1.541	1.569	1.596	1.620	1.718	1.898	2.411

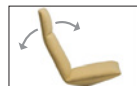

Tilting mechanism upcharge
 Incremento por sistema basculante

| 90 |

BU1695

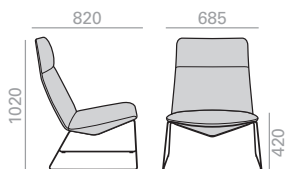

Lounge chair with upholstered shell and steel sled base finished in polished chrome, white or black.

Butaca con carcasa tapizada y base de patin de varilla de acero en acabado cromo brillo, blanco o negro.

	COM cm. per unit	COL m2
1 units	215	5
10 units or more	185	

0,62 m3
 25 kg
 x1

COM	COL	1	2	3	4	5	6	7	8	9	10	11	L1	L2	L3	L6
€ 1.016	1.036	1.061	1.081	1.097	1.125	1.152	1.178	1.206	1.234	1.261	1.287	1.315	1.339	1.438	1.616	2.089

BU1696

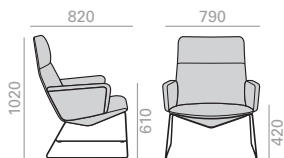

Lounge chair with upholstered shell and arms and steel sled base finished in polished chrome, white or black.

Butaca con carcasa y brazos tapizados y base de patín de varilla de acero en acabado cromo brillo, blanco o negro.

	COM cm. per unit	COL m2
1 units	290	6,5
10 units or more	290	

0,7 m3
 26,1 kg
 x1

€	COM	COL	1	2	3	4	5	6	7	8	9	10	11	L1	L2	L3	L6
€	1.416	1.447	1.484	1.514	1.539	1.579	1.620	1.660	1.701	1.741	1.781	1.822	1.865	1.903	2.066	2.357	3.133

BU1698

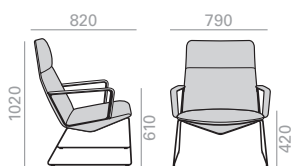

Lounge chair with upholstered shell, aluminum arms with upholstered top face and steel sled base finished in polished chrome, white or black.

Butaca con carcasa tapizada, brazos de aluminio con parte superior tapizada y base de patín de acero en acabado cromo bri lo, blanco o negro.

	COM cm. per unit	COL m2
1 units	230	5
10 units or more	210	

0,7 m3
 26,4 kg
 x1

€	COM	COL	1	2	3	4	5	6	7	8	9	10	11	L1	L2	L3	L6
€	1.193	1.213	1.237	1.257	1.273	1.299	1.325	1.352	1.380	1.406	1.433	1.459	1.485	1.509	1.606	1.780	2.260

BU1699

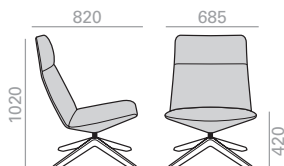

Lounge chair with upholstered shell and a 4-star solid beech wood central swivel base and self-return system. Additional options include: tilting mechanism.

Butaca con carcasa tapizada y base central giratoria de 4 aspas de madera maciza de haya con sistema de retorno. Opciones disponibles: sistema basculante.

	COM cm. per unit	COL m2
1 units	215	5
10 units or more	185	

0,61 m3
 25,4 kg
 x1

€	COM	COL	1	2	3	4	5	6	7	8	9	10	11	L1	L2	L3	L6
€	1.211	1.231	1.256	1.276	1.292	1.319	1.346	1.374	1.401	1.428	1.456	1.483	1.510	1.535	1.632	1.812	2.286

SERIE 600 Matte lacquered and premium upcharge
Incremento por lacado mate y premium | 24 |

SERIE 800 Bright lacquered upcharge
Incremento por lacado brillo | 35 |

Tilting mechanism upcharge
Incremento por sistema basculante | 90 |

BU1700

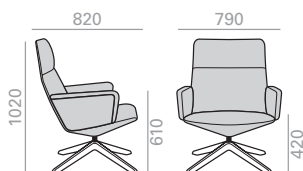

Lounge chair with upholstered shell and arms and a 4-star solid beech wood central swivel base and self-return system. Additional options include: tilting mechanism.

Butaca con carcasa y brazos tapizados y base central giratoria de 4 aspas de madera maciza de haya con sistema de retorno. Opciones disponibles: sistema basculante.

	COM cm. per unit	COL m2
1 units	290	6,5
10 units or more	290	

0,73 m3
 27 kg
 x1

€	COM	COL	1	2	3	4	5	6	7	8	9	10	11	L1	L2	L3	L6
€	1.573	1.602	1.640	1.671	1.695	1.735	1.776	1.816	1.857	1.897	1.938	1.980	2.020	2.057	2.208	2.497	3.265

SERIE 600 Matte lacquered and premium upcharge
Incremento por lacado mate y premium | 24 |

SERIE 800 Bright lacquered upcharge
Incremento por lacado brillo | 35 |

Tilting mechanism upcharge
Incremento por sistema basculante | 90 |

BU1701

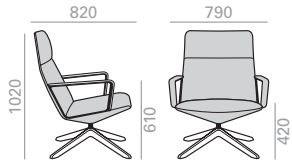

Lounge chair with upholstered shell, aluminum arms with upholstered top face and a 4-star solid beech wood central swivel base and self-return system. Additional options include: tilting mechanism.

Butaca con carcasa tapizada, brazos de aluminio con parte superior tapizada y base central giratoria de 4 aspas de madera maciza de haya con sistema de retorno. Opciones disponibles: sistema basculante.

	COM cm. per unit	COL m2
1 units	230	5
10 units or more	210	

0,75 m3
 26,8 kg
 x1

€	COM	COL	1	2	3	4	5	6	7	8	9	10	11	L1	L2	L3	L6
	1.398	1.419	1.444	1.465	1.482	1.510	1.538	1.566	1.594	1.622	1.650	1.678	1.706	1.730	1.836	2.042	2.586

SERIE 600 Matte lacquered and premium upcharge
 Incremento por lacado mate y premium | 24 |

SERIE 800 Bright lacquered upcharge
 Incremento por lacado brillo | 35 |

Tilting mechanism upcharge
 Incremento por sistema basculante | 90 |

BU1735



Lounge chair with upholstered shell and aluminum swivel 4-star base with self-return system and finished in polished aluminum, white or black. Additional options include: tilting mechanism.

Butaca con carcasa tapizada y base central giratoria de aluminio de 4 aspas con sistema de retorno disponible en acabado aluminio pulido, blanco o negro. Opciones disponibles: sistema basculante.

	COM cm. per unit	COL m2
1 units	170	3,5
10 units or more	160	

0,46 m3
 30 kg
 x1

€	COM	COL	1	2	3	4	5	6	7	8	9	10	11	L1	L2	L3	L6
	974	991	1.013	1.031	1.044	1.068	1.091	1.115	1.138	1.161	1.184	1.248	1.251	1.275	1.401	1.533	1.940

Tilting mechanism upcharge
 Incremento por sistema basculante | 90 |

BU1736

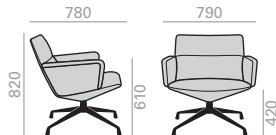

Lounge chair with upholstered shell and arms and aluminum swivel 4-star base with self-return system and finished in polished aluminum, white or black. Additional options include: tilting mechanism.

Butaca con carcasa y brazos tapizados y base central giratoria de aluminio de 4 aspas con sistema de retorno disponible en acabado aluminio pulido, blanco o negro. Opciones disponibles: sistema basculante.

	COM cm. per unit	COL m2
1 units	250	5
10 units or more	240	

0,56 m3
 31,5 kg
 x1

€	COM	COL	1	2	3	4	5	6	7	8	9	10	11	L1	L2	L3	L6
	1.400	1.430	1.465	1.495	1.517	1.556	1.594	1.633	1.671	1.710	1.748	1.788	1.827	1.860	2.002	2.311	3.131

Tilting mechanism upcharge
 Incremento por sistema basculante | 90 |

BU1737

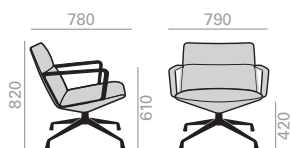

Lounge chair with upholstered shell, aluminum arms with upholstered top face and aluminum swivel 4-star base with self-return system and finished in polished aluminum, white or black. Additional options include: tilting mechanism.

Butaca con carcasa tapizada, brazos de aluminio con parte superior tapizada y base central giratoria de aluminio de 4 aspas con sistema de retorno disponible en acabado aluminio pulido, blanco o negro. Opciones disponibles: sistema basculante.

	COM cm. per unit	COL m2
1 units	180	3,75
10 units or more	170	

0,56 m3
 31 kg
 x1

€	COM	COL	1	2	3	4	5	6	7	8	9	10	11	L1	L2	L3	L6
	1.170	1.189	1.210	1.229	1.243	1.267	1.292	1.316	1.340	1.365	1.399	1.430	1.439	1.459	1.585	1.721	2.199

Tilting mechanism upcharge
 Incremento por sistema basculante | 90 |

BU1738

Lounge chair with upholstered shell and steel sled base finished in polished chrome, white or black.

Butaca con carcasa tapizada y base de patín de acero en acabado cromo brillo, blanco o negro.

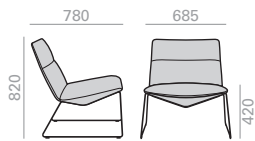

	COM cm. per unit	COL m2
1 units	170	3,5
10 units or more	160	

0,55 m3
 30 kg
 x1

COM	COL	1	2	3	4	5	6	7	8	9	10	11	L1	L2	L3	L6	
€	892	910	930	948	960	983	1.005	1.034	1.068	1.133	1.161	1.187	1.198	1.215	1.348	1.512	1.870

BU1739

Lounge chair with upholstered shell and arms and steel sled base finished in polished chrome, white or black.

Butaca con carcasa y brazos tapizados y base de patín de varilla de acero en acabado cromo brillo, blanco o negro.

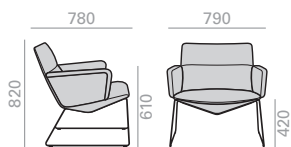

	COM cm. per unit	COL m2
1 units	250	5
10 units or more	240	

0,56 m3
 31,5 kg
 x1

COM	COL	1	2	3	4	5	6	7	8	9	10	11	L1	L2	L3	L6	
€	1.302	1.331	1.365	1.394	1.416	1.453	1.491	1.528	1.567	1.604	1.642	1.680	1.725	1.764	1.925	2.220	3.068

BU1740

Lounge chair with upholstered shell, aluminum arms with upholstered top face and steel sled base finished in polished chrome, white or black.

Butaca con carcasa tapizada, brazos de aluminio con parte superior tapizada y base de patín de varilla de acero en acabado cromo bri lo, blanco o negro.

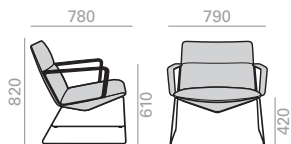

	COM cm. per unit	COL m2
1 units	180	3,75
10 units or more	170	

0,56 m3
 31 kg
 x1

COM	COL	1	2	3	4	5	6	7	8	9	10	11	L1	L2	L3	L6	
€	1.105	1.124	1.145	1.164	1.178	1.202	1.225	1.249	1.274	1.304	1.331	1.358	1.371	1.391	1.517	1.693	2.112

BU1741

Lounge chair with upholstered shell and a 4-star solid beech wood central swivel base and self-return system. Additional options include: tilting mechanism.

Butaca con carcasa tapizada y base central giratoria de 4 aspas de madera maciza de haya con sistema de retorno. Opciones disponibles: sistema basculante.

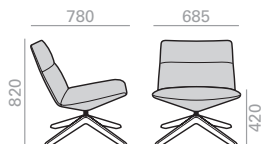

	COM cm. per unit	COL m2
1 units	170	3,5
10 units or more	1'6	

0,49 m3
 30 kg
 x1

COM	COL	1	2	3	4	5	6	7	8	9	10	11	L1	L2	L3	L6	
€	1.086	1.104	1.125	1.143	1.158	1.182	1.206	1.230	1.254	1.278	1.302	1.326	1.350	1.371	1.463	1.640	2.105

SERIE 600
 Matte lacquered and premium upcharge
 Incremento por lacado mate y premium | 24 |

SERIE 800
 Bright lacquered upcharge
 Incremento por lacado brillo | 35 |

Tilting mechanism upcharge
 Incremento por sistema basculante | 90 |

BU1742

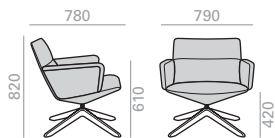

Lounge chair with upholstered shell and arms and a 4-star solid beech wood central swivel base and self-return system. Additional options include: tilting mechanism.

Butaca con carcasa y brazos tapizados y base central giratoria de 4 aspas de madera maciza de haya con sistema de retorno. Opciones disponibles: sistema basculante.

	COM cm. per unit	COL m2
1 units	250	5
10 units or more	240	

0,56 m3
31,5 kg
x1

COM	COL	1	2	3	4	5	6	7	8	9	10	11	L1	L2	L3	L6
€ 1.445	1.474	1.508	1.536	1.558	1.596	1.634	1.671	1.709	1.747	1.784	1.822	1.860	1.892	2.040	2.311	3.025

SERIE 600

Matte lacquered and premium upcharge
Incremento por lacado mate y premium

24

SERIE 800

Bright lacquered upcharge
Incremento por lacado brillo

35

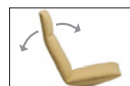

Tilting mechanism upcharge
Incremento por sistema basculante

90

BU1743

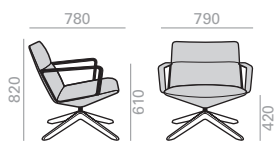

Lounge chair with upholstered shell, aluminum arms with upholstered top face and a 4-star solid beech wood central swivel base and self-return system. Additional options include: tilting mechanism.

Butaca con carcasa tapizada, brazos de aluminio con parte superior tapizada y base central giratoria de 4 aspas de madera maciza de haya con sistema de retorno. Opciones disponibles: sistema basculante.

	COM cm. per unit	COL m2
1 units	180	3,75
10 units or more	170	

0,56 m3
31 kg
x1

COM	COL	1	2	3	4	5	6	7	8	9	10	11	L1	L2	L3	L6
€ 1.286	1.305	1.329	1.348	1.363	1.390	1.415	1.442	1.467	1.492	1.519	1.545	1.571	1.594	1.693	1.884	2.390

SERIE 600

Matte lacquered and premium upcharge
Incremento por lacado mate y premium

24

SERIE 800

Bright lacquered upcharge
Incremento por lacado brillo

35

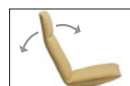

Tilting mechanism upcharge
Incremento por sistema basculante

90

RS1697



Upholstered ottoman with aluminum swivel 4-star base finished in polished aluminum, white or black.



Reposapiés tapizado con base central de aluminio de 4 aspas y acabado aluminio pulido, blanco o negro.

	COM cm. per unit	COL m2
1 units	110	2,5
10 units or more	110	

0,18 m3
12,7 kg
x1

COM	COL	1	2	3	4	5	6	7	8	9	10	11	L1	L2	L3	L6
€ 656	665	676	685	693	705	718	730	743	755	769	781	794	804	851	933	1.157

Glides for sled bases/cantilever. Tacos para bases de patín/cantilever.

Use/Usó	Reference/Referencia		Material/Material	Price/Precio	
Hard floors. Suelos duros.	TS0531		Plastic (PE). Plástico (PE).	0 €	Standard. Estándar.
Wooden and delicated floors. Suelos de madera y delicados.	TS0538		Plastic (PE) with felt. Plástico (PE) con fieltro.	6 €	Set of 4 glides. Juego de 4 tacos.
Mats/carpet floors. Suelos de moqueta/ alfombra.	TS0537		No glide. Sin taco.	0 €	

The indicated price is for glides placed on chairs. To order loose parts, please ask to our Sales Department.

El precio indicado en Tarifa es para tacos colocados en las sillas. Para pedidos de tacos sueltos de repuesto, consultar con el Departamento Comercial.

Glides for central base. Tacos para base central.

Use/Usó	Reference/Referencia		Material/Material	Price/Precio	
Hard floors. Suelos duros.	TS0550		Plastic (PE). Plástico (PE).	0 €	Standard. Estándar.
Wooden and delicated floors. Suelos de madera y delicados.	TS0551		Plastic (PE) with felt. Plástico (PE) con fieltro.	3 €	Set of 4 glides. Juego de 4 tacos.
Mats/carpet floors. Suelos de moqueta/ alfombra.	TS0552		Metal. Metal.	3 €	

For wooden legs. Para bases de madera.



Optional glides on page 482.

Opciones de tacos deslizantes en página 482.

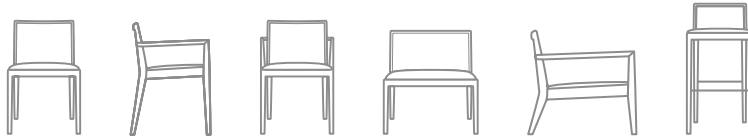

Description
Descripción

Side chairs, armchairs, lounge chairs and barstools with solid beech wood frame and upholstered seat and back. Offered in two different back heights.
Sillas, sillones, butacas y banquetas con asiento y respaldo tapizado y estructura y brazos en madera maciza de haya. Se ofrece con dos alturas diferentes de respaldo.

Upholstery
Tapicería

The Carlotta collection supports following upholsteries of Andreu World Catalogue. For fabrics in our catalogue not specified in this box or customers own materials please contact our Customer Service Department.

La colección Carlotta admite las siguientes tapicerías del catálogo de Andreu World. Para las telas de nuestro catálogo no indicadas en este cuadro o telas cliente, consultar con nuestro Departamento Comercial.

Fabrics / Telas

- 1** Soft-fiber
Jacquard One
Jacquard Three
Citadel
Sand
Era
Gravity
Rivet
Urban
Reel One (in/out)
Spin One
Spin Two
Spin Three
Spin Four
Spin Five
- 2** Jacquard Two
Solid & Stripes
Loom One
Circular One Pure Eco
Tack One (in/out)

- 3** Jacquard Four
Medley
Revive 1
Natte
Main Line Flax
Loom Two (in/out)
Mezzo
Reel two (in/out)
Jacquard Five
- 4** Jacquard 4 Special
Nexus
Field 2
Remix 3
Heritage
Savane
Loom Three
Loom Four
Cura
Oceanic
Reel Three (in/out)
Reel Four (in/out)
Reflect
Spin Six

- 5** Silk
Synergy
Step
Step Melange
Blazer
Melange Nap
Chili
Noma
Re-wool
- 6** Go check
Swing
Chartres
Zori
Patio
Tack Two (in/out)
Tack Three (in/out)
- 7** Canvas 2
Select
Clara 2
Tack Five (in/out)
Hero 2

- 8** Capture
Fiord 2
Tonus 4
Divina 3
Lopi
Domino
Atrium
- 9** Divina MD
Divina Melange 3
Hallingdal 65
Steelcut Trio 3
Tack Four (in/out)
- 11** Arda
Ecriture
Zero

Faux Leather / Ecopiel

- 1** Valencia
- 2** Silvertex
- 3** Maglia
- 4** Dolce
- 8** Ultraleather
- 9** Brisa
Brisa Distressed
Fresco
Ultraleather Pro
Promessa
- 10** Tottori
Coast (in/out)
- 11** Reef Pro
Volar Bio

Leather / Piel

- L1** High grade cow leather.
Piel de vaca de 1ª categoría.
- L3** Polished full grain leather.
Piena flor pulida.
- L6** Aniline leather batique-effect.
Scandinavian cattle.
Piel anilina efecto batique.
Ganado escandinavo.

Wood finish Beech
Acabado madera Haya

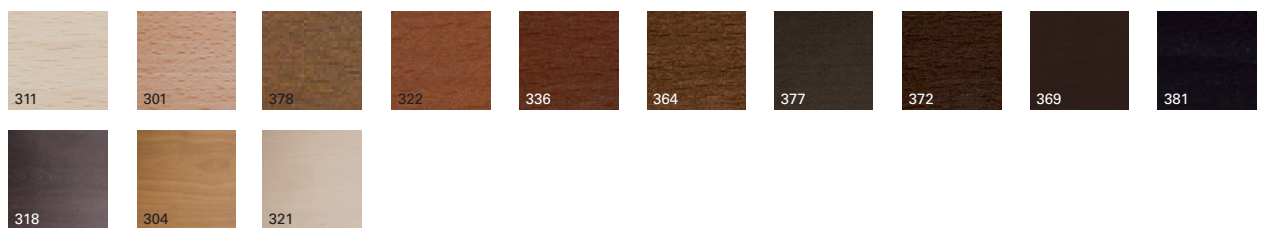

Premium finish and wood lacquers
Acabado premium y lacas madera



Certificates
Certificados

Fireproof polyurethane foam
Espuma de poliuretano ignifuga

UNE EN 1021:2006
BS 5852 part 2 crib 5
UNI 9175 Classe 1 IM
BKZ 5.2
California TB 117:2013
California TB 133*

*Contact our Customer Department
*Consultar con nuestro Departamento Comercial

Quality - Resistance
Calidad - Resistencia

UNE EN 16139:2013

Intellectual property Propiedad intelectual

All our collections are protected by international industrial design registries, designs patents, copyrights and intellectual Property laws. Unauthorized use of AW International Property is a criminal offence and can lead to prosecution.
Todas nuestras colecciones están protegidas por registros de diseño industrial, diseño de patente, copyright y derechos de propiedad intelectual todo el mundo. El uso no autorizado de los diseños y propiedad intelectual de AW supone un delito que puede ser sometido a acción judicial.



SI0915

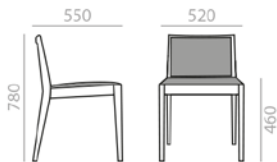

Chair with upholstered seat and backrest and solid beech wood frame.

Silla con asiento y respaldo tapizado y estructura de madera maciza de haya.

	COM cm. per unit	COL m2
1 units	100	2,25
10 units or more	75	

0,39 m3
 18,6 kg
 x2

€	COM	COL	1	2	3	4	5	6	7	8	9	10	11	L1	L2	L3	L6
	425	435	444	453	460	471	483	495	506	518	528	540	551	562	603	685	915

SERIE 600	Matte lacquered and premium upcharge Incremento por lacado mate y premium	20	SERIE 800	Bright lacquered upcharge Incremento por lacado brillo	30
------------------	--	----	------------------	---	----

SO0916

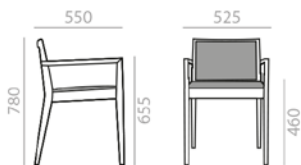

Armchair with upholstered seat and backrest and solid beech frame.

Sillón con asiento y respaldo tapizado y estructura de madera maciza de haya.

	COM cm. per unit	COL m2
1 units	100	2,25
10 units or more	75	

0,26 m3
 9,7 kg
 x1

€	COM	COL	1	2	3	4	5	6	7	8	9	10	11	L1	L2	L3	L6
	531	541	550	559	566	577	589	599	611	622	633	645	655	666	706	781	1.023

SERIE 600	Matte lacquered and premium upcharge Incremento por lacado mate y premium	24	SERIE 800	Bright lacquered upcharge Incremento por lacado brillo	35
------------------	--	----	------------------	---	----

SI0991

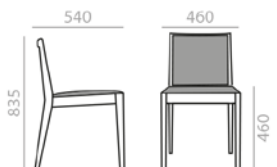

Chair with upholstered seat and backrest and solid beech wood frame. Small version.

Silla con asiento y respaldo tapizado y estructura de madera maciza de haya. Versión pequeña.

	COM cm. per unit	COL m2
1 units	110	2,25
10 units or more	78	

0,44 m3
 18 kg
 x2

€	COM	COL	1	2	3	4	5	6	7	8	9	10	11	L1	L2	L3	L6
	434	443	454	463	471	483	495	507	519	531	543	555	567	579	623	710	953

SERIE 600	Matte lacquered and premium upcharge Incremento por lacado mate y premium	20	SERIE 800	Bright lacquered upcharge Incremento por lacado brillo	30
------------------	--	----	------------------	---	----

SO0992

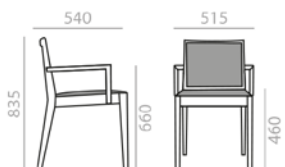

Armchair with upholstered seat and backrest and solid beech wood frame. Small version

Sillón con asiento y respaldo tapizado y estructura de madera maciza de haya. Versión pequeña.

	COM cm. per unit	COL m2
1 units	110	2,25
10 units or more	78	

0,26 m3
 9,5 kg
 x1

€	COM	COL	1	2	3	4	5	6	7	8	9	10	11	L1	L2	L3	L6
	594	603	614	623	630	642	654	666	678	690	702	714	726	737	780	859	1.110

SERIE 600	Matte lacquered and premium upcharge Incremento por lacado mate y premium	26	SERIE 800	Bright lacquered upcharge Incremento por lacado brillo	38
------------------	--	----	------------------	---	----

BU0926

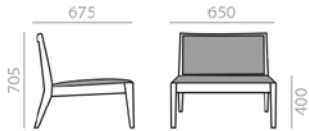

Lounge chair with upholstered seat and backrest and solid beech frame.
Butaca con asiento y respaldo tapizado y estructura de madera maciza de haya.

	COM cm. per unit	COL m2
1 units	111	2,25
10 units or more	111	

0,51 m3
 24 kg
 x2

€	COM	COL	1	2	3	4	5	6	7	8	9	10	11	L1	L2	L3	L6
	527	541	554	568	582	602	621	640	659	678	696	715	733	751	820	943	1.272

SERIE 600	Matte lacquered and premium upcharge Incremento por lacado mate y premium	24	SERIE 800	Bright lacquered upcharge Incremento por lacado brillo	35
------------------	--	----	------------------	---	----

BU0928

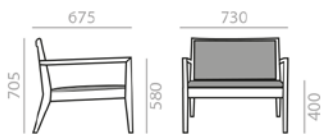

Lounge chair with arms. Upholstered seat and backrest and solid beech frame.
Butaca con brazos con asiento y respaldo tapizado y estructura de madera maciza de haya.

	COM cm. per unit	COL m2
1 units	111	2,25
10 units or more	111	

0,51 m3
 12,8 kg
 x1

€	COM	COL	1	2	3	4	5	6	7	8	9	10	11	L1	L2	L3	L6
	595	608	621	636	648	666	684	703	722	739	758	775	794	809	874	995	1.308

SERIE 600	Matte lacquered and premium upcharge Incremento por lacado mate y premium	27	SERIE 800	Bright lacquered upcharge Incremento por lacado brillo	41
------------------	--	----	------------------	---	----

BQ0923

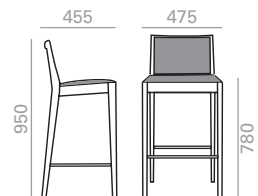

Barstool with upholstered seat and backrest and solid beech frame.
Banqueta alta con asiento y respaldo tapizado y estructura de madera maciza de haya.

	COM cm. per unit	COL m2
1 units	45	1
10 units or more	45	

0,25 m3
 10,7 kg
 x1

€	COM	COL	1	2	3	4	5	6	7	8	9	10	11	L1	L2	L3	L6
	568	572	577	582	586	592	598	605	611	618	624	632	638	645	668	716	851

SERIE 600	Matte lacquered and premium upcharge Incremento por lacado mate y premium	27	SERIE 800	Bright lacquered upcharge Incremento por lacado brillo	41
------------------	--	----	------------------	---	----

BQ0943

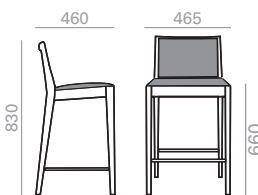

Counter stool with upholstered seat and backrest and solid beech wood frame.
Banqueta baja con asiento y respaldo tapizado y estructura de madera maciza de haya.

	COM cm. per unit	COL m2
1 units	45	1
10 units or more	45	

0,22 m3
 10,8 kg
 x1

€	COM	COL	1	2	3	4	5	6	7	8	9	10	11	L1	L2	L3	L6
	568	572	577	582	586	592	598	605	611	618	624	632	638	645	668	716	851

SERIE 600	Matte lacquered and premium upcharge Incremento por lacado mate y premium	27	SERIE 800	Bright lacquered upcharge Incremento por lacado brillo	41
------------------	--	----	------------------	---	----

For wooden legs. Para bases de madera.



Optional glides on page 482.

Opciones de tacos deslizantes en página 482.



Description
Descripción

Chairs and armchairs with oak board seat or upholstered seat and solid beech wood frame.
Sillas y sillones con asiento de tablero de roble o tablero tapizado y estructura en madera maciza de haya.

Upholstery
Tapicería

The Carola collection supports following upholsteries of Andreu World Catalogue. For fabrics in our catalogue not specified in this box or customers own materials please contact our Customer Service Department.

La colección Carola admite las siguientes tapicerías del catálogo de Andreu World. Para las telas de nuestro catálogo no indicadas en este cuadro o telas cliente, consultar con nuestro Departamento Comercial.

fabrics / telas

- 1 Soft-fiber
Jacquard One
Jacquard Three
Citadel
Sand
Era
Gravity
Rivet
Urban
Reel One (in/out)
Spin One
Spin Two
Spin Three
Spin Four
Spin Five
- 2 Jacquard Two
Solid & Stripes
Loom One
Circular One Pure Eco
Tack One (in/out)

- 3 Jacquard Four
Medley
Revive 1
Natte
Main Line Flax
Loom Two (in/out)
Mezzo
Reel two (in/out)
Jacquard Five
- 4 Jacquard 4 Special
Nexus
Field 2
Remix 3
Heritage
Savane
Loom Three
Loom Four
Cura
Oceanic
Reel Three (in/out)
Reel Four (in/out)
Reflect
Spin Six

- 5 Silk
Synergy
Step
Step Melange
Blazer
Melange Nap
Chili
Noma
Re-wool
- 6 Go check
Swing
Chartres
Zori
Patio
Tack Two (in/out)
Tack Three (in/out)
- 7 Canvas 2
Select
Clara 2
Tack Five (in/out)
Hero 2

- 8 Capture
Fiord 2
Tonus 4
Divina 3
Lopi
Domino
Atrium
- 9 Divina MD
Divina Melange 3
Hallingdal 65
Steelcut Trio 3
Tack Four (in/out)
- 11 Arda
Ecriture
Zero

faux Leather / Ecopiel

- 1 Valencia
- 2 Silvertex
- 3 Maglia
- 4 Dolce
- 8 Ultraleather
- 9 Brisa
Brisa Distressed
Fresco
Ultraleather Pro
Promessa
- 10 Tottori
Coast (in/out)
- 11 Reef Pro
Volar Bio

Leather / Piel

- L1 High grade cow leather.
Piel de vaca de 1ª categoría.
- L3 Polished full grain leather.
Plena flor pulida.
- L6 Aniline leather batique-effect.
Scandinavian cattle.
Piel anilina efecto batique.
Ganado escandinavo.

Wood finish Beech
Acabado madera Haya

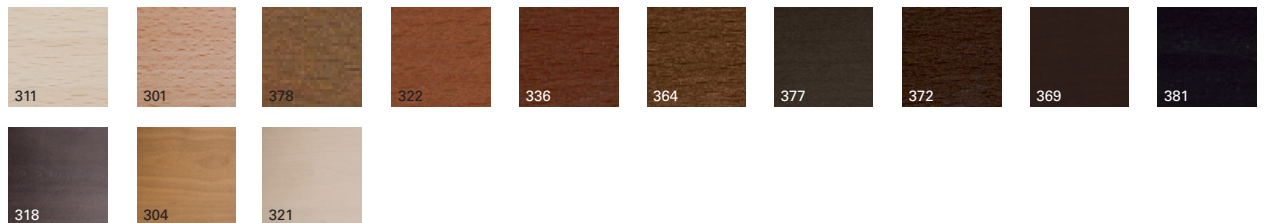

Premium finish and wood lacquers
Acabado premium y lacas madera



Certificates
Certificados

Fireproof polyurethane foam
Espuma de poliuretano ignífuga

UNE EN 1021:2006
BS 5852 part 2 crib 5
UNI 9175 Classe 1 IM
BKZ 5.2
California TB 117:2013
California TB 133*

*Contact our Customer Department
*Consultar con nuestro Departamento Comercial

Quality - Resistance
Calidad - Resistencia

UNE EN 16139:2013

Intellectual property Propiedad intelectual

All our collections are protected by international industrial design registries, designs patents, copyrights and intellectual Property laws. Unauthorized use of AW International Property is a criminal offence and can lead to prosecution.
Todas nuestras colecciones están protegidas por registros de diseño industrial, diseño de patente, copyright y derechos de propiedad intelectual todo el mundo. El uso no autorizado de los diseños y propiedad intelectual de AW supone un delito que puede ser sometido a acción judicial.



SI0905



Chair with solid beech wood backrest and frame and oak board seat.

Silla con asiento de tablero de roble y respaldo y estructura de madera maciza de haya.

0,26 m3

6,1 kg

x1

€ 581

SERIE 600 Matte lacquered and premium upcharge
Incremento por lacado mate y premium | 47 |

SERIE 800 Bright lacquered upcharge
Incremento por lacado brillo | 69 |

SI0906



Chair with solid beech wood backrest and frame and upholstered seat.

Silla con asiento tapizado y respaldo y estructura de madera maciza de haya.

	COM cm. per unit	COL m2
1 units	65	1,25
10 units or more	33	

0,26 m3

9,5 kg

x1

€	COM	COL	1	2	3	4	5	6	7	8	9	10	11	L1	L2	L3	L6
	520	523	527	531	534	539	543	549	553	558	563	568	572	576	594	627	742

SERIE 600 Matte lacquered and premium upcharge
Incremento por lacado mate y premium | 39 |

SERIE 800 Bright lacquered upcharge
Incremento por lacado brillo | 59 |

SO0902

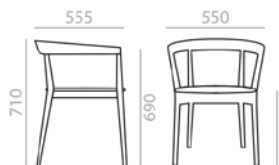

Armchair with solid beech wood backrest and frame and oak board seat.

Sillón con asiento de tablero de roble y respaldo y estructura de madera maciza de haya.

0,26 m3

8,9 kg

x1

€ 655

SERIE 600 Matte lacquered and premium upcharge
Incremento por lacado mate y premium | 47 |

SERIE 800 Bright lacquered upcharge
Incremento por lacado brillo | 69 |

SO0903



Armchair with solid beech wood backrest and frame and upholstered seat.

Sillón con asiento tapizado y respaldo y estructura de madera maciza de haya.

	COM cm. per unit	COL m2
1 units	65	1,25
10 units or more	33	

0,26 m3

10 kg

x1

€	COM	COL	1	2	3	4	5	6	7	8	9	10	11	L1	L2	L3	L6
	585	589	593	597	600	605	609	615	620	624	630	634	639	643	661	693	813

SERIE 600 Matte lacquered and premium upcharge
Incremento por lacado mate y premium | 39 |

SERIE 800 Bright lacquered upcharge
Incremento por lacado brillo | 59 |



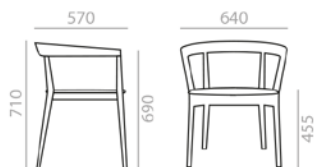

Measures +- 5 mm.
Medidas +- 5 mm.

SO0907



 Armchair with solid beech wood backrest and frame and oak board seat. Wider version.
Sillón con asiento de tablero de roble y respaldo y estructura de madera maciza de haya. Versión ancha.

 0,34 m3
 10,3 kg
 x1



€ 644

SERIE 600 | Matte lacquered and premium upcharge | Incremento por lacado mate y premium | 47 |

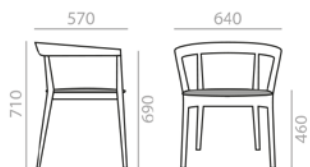

SERIE 800 | Bright lacquered upcharge | Incremento por lacado brillo | 69 |

SO0908



 Armchair with solid beech wood backrest and frame and upholstered seat. Wider version.
Sillón con asiento tapizado y respaldo y estructura de madera maciza de haya. Versión ancha.

	COM cm. per unit	COL m2
1 units	69	1,5
10 units or more	34	

 0,34 m3
 11 kg
 x1

€	COM	COL	1	2	3	4	5	6	7	8	9	10	11	L1	L2	L3	L6
	620	623	627	631	634	640	644	648	653	658	663	667	673	677	694	726	843

SERIE 600 | Matte lacquered and premium upcharge | Incremento por lacado mate y premium | 39 |

SERIE 800 | Bright lacquered upcharge | Incremento por lacado brillo | 59 |

For wooden legs. Para bases de madera.



Optional glides on page 482.
Opciones de tacos deslizantes en página 482.

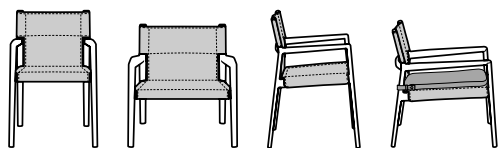

Description
Descripción

Armchair and lounge chair with seat and back upholstered in leather, available in various colors, and structure in solid ash wood. Back of backrest upholstered in fabric (Jacquard Four) in the same color as the leather. Optional seat cushion for the lounge chair version.

Sillón y butaca con asiento y respaldo tapizado en cuero, disponible en diferentes colores, y estructura de madera maciza de fresno. Trasera de respaldo tapizada en tela (Jacquard Four) al tono del cuero. Opción de cojín de asiento para la versión de butaca.

Wood finish Ash
Acabado madera
Fresno



Leather/fabric
(Jacquard Four) finish
Acabado de cuero/
tapicería

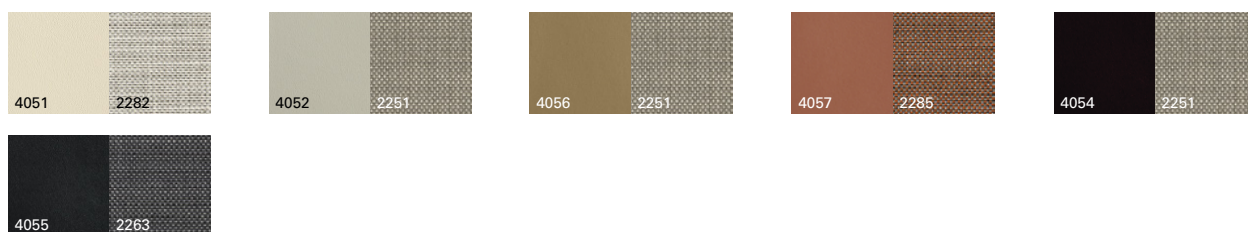

Certificates
Certificados

Fireproof
polyurethane
foam

Espuma de
poliuretano
ignífuga

UNE EN 1021:2006
BS 5852 part 2 crib 5
UNI 9175 Classe 1 IM
BKZ 5.2
California TB 117:2013
California TB 133*

*Contact our Customer Department
*Consultar con nuestro Departamento Comercial

Quality - Resistance
Calidad - Resistencia

UNE EN 16139:2013

Intellectual property Propiedad intelectual

All our collections are protected by international industrial design registries, designs patents, copyrights and intellectual Property laws. Unauthorized use of AW International Property is a criminal offence and can lead to prosecution.

Todas nuestras colecciones están protegidas por registros de diseño industrial, diseño de patente, copyright y derechos de propiedad intelectual en todo el mundo. El uso no autorizado de los diseños y propiedad intelectual de AW supone un delito que puede ser sometido a acción judicial.



SO2341

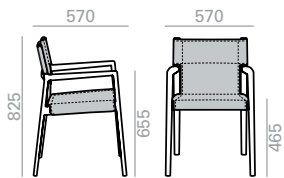

Armchair with seat and back upholstered in leather, available in various colors, and structure in solid ash wood. Back of backrest upholstered in fabric (Jacquard Four) in the same color as the leather.
Sillón con asiento y respaldo tapizado en cuero, disponible en diferentes colores, y estructura de madera maciza de fresno. Trasera de respaldo tapizada en tela (Jacquard Four) al tono del cuero.

0,32 m3
8,5 kg
x1

L2

€ 860

SERIE 600
Matte lacquered and premium upcharge
Incremento por lacado mate y premium

35

SO2343

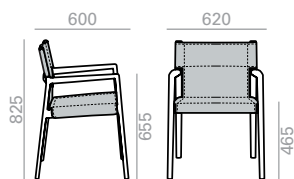

Armchair with seat and back upholstered in leather, available in various colors, and structure in solid ash wood. Wider version. Back of backrest upholstered in fabric (Jacquard Four) in the same color as the leather.

Sillón con asiento y respaldo tapizado en cuero, disponible en diferentes colores, y estructura de madera maciza de fresno. Versión ancha. Trasera de respaldo tapizada en tela (Jacquard Four) al tono del cuero.

0,37 m3
9,5 kg
x1

L2

€ 1.595

SERIE 600
Matte lacquered and premium upcharge
Incremento por lacado mate y premium

35

BU2342

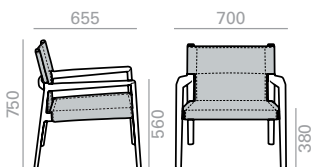

Lounge chair with seat and back upholstered in leather, available in various colors, and structure in solid ash wood. Back of backrest upholstered in fabric (Jacquard Four) in the same color as the leather.

Butaca con asiento y respaldo tapizado en cuero, disponible en diferentes colores, y estructura de madera maciza de fresno. Trasera de respaldo tapizada y opción de cojín tapizado en asiento disponibles en tela (Jacquard Four) al tono del cuero.

0,41 m3
10,5 kg
x1

L2

€ 967



3
181

SERIE 600
Matte lacquered and premium upcharge
Incremento por lacado mate y premium

47



Description Bench with top and legs available in oak finish.
Descripción Banco con sobre y patas disponible en madera de roble.

Upholstery The Closed Bench collection supports following upholsteries of Andreu World Catalogue. For fabrics in our catalogue not specified in this box or customers own materials please contact our Customer Service Department.
Tapicería La colección Closed Bench admite las siguientes tapicerías del catálogo de Andreu World. Para las telas de nuestro catálogo no indicadas en este cuadro o telas cliente, consultar con nuestro Departamento Comercial.

Fabrics / Telas

- | | | | |
|--|---|---|---|
| <p>1 Soft-fiber
Jacquard One
Jacquard Three
Citadel
Sand
Era
Gravity
Rivet
Urban
Reel One (in/out)
Spin One
Spin Two
Spin Three
Spin Four
Spin Five</p> <p>2 Jacquard Two
Solid & Stripes
Loom One
Circular One Pure Eco
Tack One (in/out)</p> | <p>3 Jacquard Four
Medley
Revive 1
Natte
Main Line Flax
Loom Two (in/out)
Mezzo
Reel two (in/out)
Jacquard Five</p> <p>4 Jacquard 4 Special
Nexus
Field 2
Remix 3
Heritage
Savane
Loom Three
Loom Four
Cura
Oceanic
Reel Three (in/out)
Reel Four (in/out)
Reflect
Spin Six</p> | <p>5 Silk
Synergy
Step
Step Melange
Blazer
Melange Nap
Chili
Noma
Re-wool</p> <p>6 Go check
Swing
Chartres
Zori
Patio
Tack Two (in/out)
Tack Three (in/out)</p> <p>7 Canvas 2
Select
Clara 2
Tack Five (in/out)
Hero 2</p> | <p>8 Capture
Fiord 2
Tonus 4
Divina 3
Lopi
Domino
Atrium</p> <p>9 Divina MD
Divina Melange 3
Hallingdal 65
Steelcut Trio 3
Tack Four (in/out)</p> <p>11 Arda
Ecriture
Zero</p> |
|--|---|---|---|

Faux Leather / Ecopiel

- 1** Valencia
2 Silvertex
3 Maglia
4 Dolce
8 Ultraleather
9 Brisa
Brisa Distressed
Fresco
Ultraleather Pro
Promessa
10 Tottori
Coast (in/out)
11 Reef Pro
Volar Bio

Leather / Piel

- L1** High grade cow leather.
Piel de vaca de 1ª categoría.
L3 Polished full grain leather.
Piel de vaca pulida.
L6 Aniline leather batique-effect.
Scandinavian cattle.
Piel anilina efecto batique.
Ganado escandinavo.

Wood finish Oak
Acabado madera
Roble



Premium finish and wood lacquers
Acabado premium y lacas madera



Certificates **Fireproof polyurethane foam** UNE EN 1021:2006
BS 5852 part 2 crib 5
UNI 9175 Classe 1 IM
BKZ 5.2
California TB 117:2013
California TB 133*
*Contact our Customer Department
*Consultar con nuestro Departamento Comercial

Quality - Resistance UNE EN 16139:2013
Calidad - Resistencia

Intellectual property Propiedad intelectual

All our collections are protected by international industrial design registries, designs patents, copyrights and intellectual Property laws. Unauthorized use of AW International Property is a criminal offence and can lead to prosecution.
 Todas nuestras colecciones están protegidas por registros de diseño industrial, diseño de patente, copyright y derechos de propiedad intelectual en todo el mundo. El uso no autorizado de los diseños y propiedad intelectual de AW supone un delito que puede ser sometido a acción judicial.



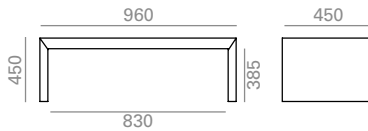

Finish Acabado	*Oak Roble
Reference Referencia	BC6300
Price Precio	1.183

	COM cm. per unit	COL m2
1 units	73	1,5
10 units or more	68	

0,32 m3
 20 kg
 x1
 1 box 1 bulto

SERIE 600	Matte lacquered and premium upcharge Incremento por lacado mate y premium	90
--------------	--	----

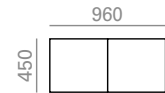

Optional cushions
Cojines opcionales

COM	COL	1	2	3	4	5	6	7	8	9	10	11	L1	L2	L3	L6	
€	136	145	155	164	171	182	193	206	217	228	239	250	261	272	313	387	614

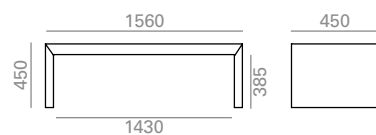

Finish Acabado	*Oak Roble
Reference Referencia	BC6301
Price Precio	1.590

	COM cm. per unit	COL m2
1 units	135	2,5
10 units or more	100	

0,5 m3
 26 kg
 x1
 1 box 1 bulto

SERIE 600	Matte lacquered and premium upcharge Incremento por lacado mate y premium	135
--------------	--	-----

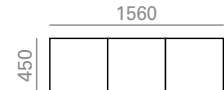

Optional cushions
Cojines opcionales

COM	COL	1	2	3	4	5	6	7	8	9	10	11	L1	L2	L3	L6	
€	218	234	253	269	281	302	324	344	365	387	407	428	449	467	543	682	1.047

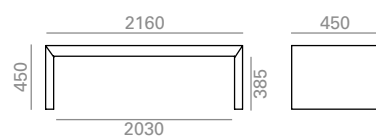

Finish Acabado	*Oak Roble
Reference Referencia	BC6302
Price Precio	1.937

	COM cm. per unit	COL m2
1 units	135	3
10 units or more	135	

0,68 m3
 32 kg
 x1
 1 box 1 bulto

SERIE 600	Matte lacquered and premium upcharge Incremento por lacado mate y premium	180
--------------	--	-----

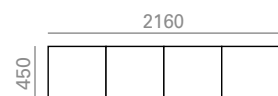

Optional cushions
Cojines opcionales

COM	COL	1	2	3	4	5	6	7	8	9	10	11	L1	L2	L3	L6	
€	256	271	290	306	319	339	361	382	402	423	445	466	486	505	581	718	1.083

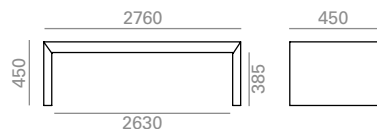

Finish Acabado	*Oak Roble
Reference Referencia	BC6303
Price Precio	2.357

	COM cm. per unit	COL m2
1 units	200	3,5
10 units or more	170	

0,86 m3
 46 kg
 x1
 1 box 1 bulto

SERIE 600 | Matte lacquered and premium upcharge
 Incremento por lacado mate y premium | 228 |

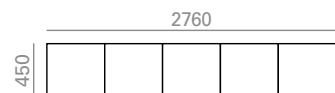

Optional cushions
Cojines opcionales

€	COM	COL	1	2	3	4	5	6	7	8	9	10	11	L1	L2	L3	L6
	269	293	319	344	360	392	422	453	483	515	547	577	608	635	747	949	1.488

For wooden legs. Para bases de madera.



Optional glides on page 482.
Opciones de tacos deslizantes en página 482.

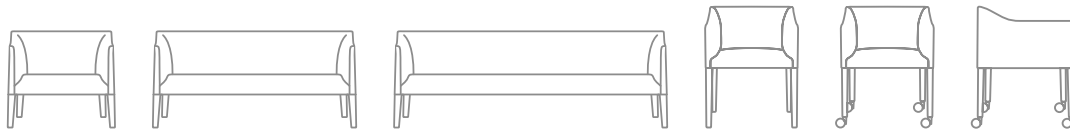

Description
Descripción

Armchairs, lounge chairs and 2 and 3-seater sofas with upholstered seat and back and 4 beech wood legs. Wide version of armchair with or without casters. Version of lounge chair and 2 and 3-seater sofas with upholstered seat and back and 4 injected aluminum legs finished in polished aluminum, matte white or matte black finishes.

Sillones, butacas y sofás de 2 y 3 plazas con asiento y respaldo tapizado y base de 4 patas de madera maciza de haya. Versión de sillón ancho con o sin ruedas. Versión de butaca y sofás de 2 y 3 plazas con asiento y respaldo tapizado y base de 4 patas de inyección de aluminio en acabado aluminio pulido, blanco o negro mate.

Upholstery
Tapicería

The Couvé collection supports following upholsteries of Andreu World Catalogue. For fabrics in our catalogue not specified in this box or customers own materials please contact our Customer Service Department.

La colección Couvé admite las siguientes tapicerías del catálogo de Andreu World. Para las telas de nuestro catálogo no indicadas en este cuadro o telas cliente, consultar con nuestro Departamento Comercial.

Fabrics / Telas

- 1** Soft-fiber
Jacquard One
Jacquard Three
Citadel
Sand
Era
Gravity
Rivet
Urban
Reel One (in/out)
Spin One
Spin Two
Spin Three
Spin Four
Spin Five
- 2** Jacquard Two
Solid & Stripes
Loom One
Circular One Pure Eco
Tack One (in/out)

- 3** Jacquard Four
Medley
Revive 1
Natte
Main Line Flax
Loom Two (in/out)
Mezzo
Reel two (in/out)
Jacquard Five
- 4** Jacquard 4 Special
Nexus
Field 2
Remix 3
Heritage
Savane
Loom Three
Loom Four
Cura
Oceanic
Reel Three (in/out)
Reel Four (in/out)
Reflect
Spin Six

- 5** Silk
Synergy
Step
Step Melange
Blazer
Melange Nap
Chili
Noma
Re-wool
- 6** Go check
Swing
Chartres
Zori
Patio
Tack Two (in/out)
Tack Three (in/out)
- 7** Canvas 2
Select
Clara 2
Tack Five (in/out)
Hero 2

- 8** Capture
Fiord 2
Tonus 4
Divina 3
Lopi
Domino
Atrium
- 9** Divina MD
Divina Melange 3
Hallingdal 65
Steelcut Trio 3
Tack Four (in/out)
- 11** Arda
Ecriture
Zero

Faux Leather / Ecopiel

- 1** Valencia
- 2** Silvertex
- 3** Maglia
- 4** Dolce
- 8** Ultraleather
- 9** Brisa
Brisa Distressed
Fresco
Ultraleather Pro
Promessa
- 10** Tottori
Coast (in/out)
- 11** Reef Pro
Volar Bio

Leather / Piel

- L1** High grade cow leather.
Piel de vaca de 1ª categoría.
- L3** Polished full grain leather.
Piena flor pulida.
- L6** Aniline leather batique-effect.
Scandinavian cattle.
Piel anilina efecto batique.
Ganado escandinavo.

Wood finish Beech
Acabado madera Haya



Premium finish and wood lacquers
Acabado premium y lacas madera



Aluminum finish
Acabado aluminio



Certificates
Certificados

Fireproof polyurethane foam
Espuma de poliuretano ignifuga

UNE EN 1021:2006
BS 5852 part 2 crib 5
UNI 9175 Classe 1 IM
BKZ 5.2
California TB 117:2013
California TB 133*

*Contact our Customer Department
*Consultar con nuestro Departamento Comercial

Quality - Resistance
Calidad - Resistencia

UNE EN 16139:2013

Intellectual property Propiedad intelectual

All our collections are protected by international industrial design registries, designs patents, copyrights and intellectual Property laws. Unauthorized use of AW International Property is a criminal offence and can lead to prosecution.
Todas nuestras colecciones están protegidas por registros de diseño industrial, diseño de patente, copyright y derechos de propiedad intelectual todo el mundo. El uso no autorizado de los diseños y propiedad intelectual de AW supone un delito que puede ser sometido a acción judicial.



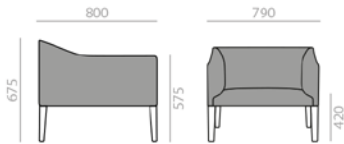

BU1264



 Lounge chair with upholstered seat and back and 4 solid beech wood legs.
Butaca con asiento y respaldo tapizado y base de 4 patas de madera maciza de haya.

	COM cm. per unit	COL m2
1 units	380	7,4
10 units or more	380	

 0,53 m3
 15,1 kg
 x1

€	COM	COL	1	2	3	4	5	6	7	8	9	10	11	L1	L2	L3	L6
	1.228	1.268	1.316	1.356	1.386	1.439	1.493	1.545	1.598	1.652	1.709	1.766	1.821	1.873	2.081	2.458	3.456

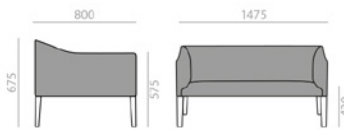

SERIE 600	Matte lacquered and premium upcharge Incremento por lacado mate y premium	17	SERIE 800	Bright lacquered upcharge Incremento por lacado brillo	24
------------------	--	----	------------------	---	----

SF1265



 2-seater sofa with upholstered seat and back and 4 solid beech wood legs.
Sofá de 2 plazas con asiento y respaldo tapizado y base de 4 patas de madera maciza de haya.

	COM cm. per unit	COL m2
1 units	500	9,8
10 units or more	500	

 0,91 m3
 23,9 kg
 x1

€	COM	COL	1	2	3	4	5	6	7	8	9	10	11	L1	L2	L3	L6
	1.708	1.761	1.827	1.880	1.922	1.993	2.065	2.136	2.208	2.283	2.361	2.437	2.518	2.587	2.867	3.381	4.740

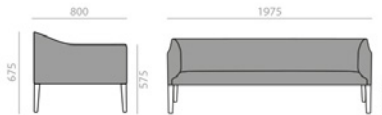

SERIE 600	Matte lacquered and premium upcharge Incremento por lacado mate y premium	24	SERIE 800	Bright lacquered upcharge Incremento por lacado brillo	35
------------------	--	----	------------------	---	----

SF1266



 3-seater sofa with upholstered seat and back and 4 solid beech wood legs.
Sofá de 3 plazas con asiento y respaldo tapizado y base de 4 patas de madera maciza de haya.

	COM cm. per unit	COL m2
1 units	560	11
10 units or more	560	

 1,18 m3
 30,4 kg
 x1

€	COM	COL	1	2	3	4	5	6	7	8	9	10	11	L1	L2	L3	L6
	1.904	1.959	2.028	2.083	2.127	2.202	2.276	2.350	2.425	2.499	2.580	2.663	2.745	2.818	3.112	3.647	5.075

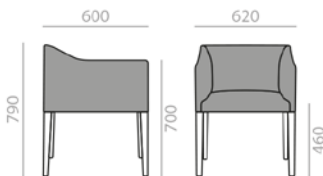

SERIE 600	Matte lacquered and premium upcharge Incremento por lacado mate y premium	32	SERIE 800	Bright lacquered upcharge Incremento por lacado brillo	47
------------------	--	----	------------------	---	----

SO1267



 Armchair with upholstered seat and backrest and 4 solid beech wood legs. Optional 4 casters.
Sillón con asiento y respaldo tapizado y base de 4 patas de madera maciza de haya. Opción de 4 ruedas.

	COM cm. per unit	COL m2
1 units	210	4,1
10 units or more	210	

 0,34 m3
 11,1 kg
 x1

€	COM	COL	1	2	3	4	5	6	7	8	9	10	11	L1	L2	L3	L6
	604	625	648	668	684	710	735	761	787	813	839	867	893	916	1.010	1.192	1.676

SERIE 600	Matte lacquered and premium upcharge Incremento por lacado mate y premium	17	SERIE 800	Bright lacquered upcharge Incremento por lacado brillo	24		Casters upcharge Incremento ruedas	90
------------------	--	----	------------------	---	----	--	---------------------------------------	----

SO1274

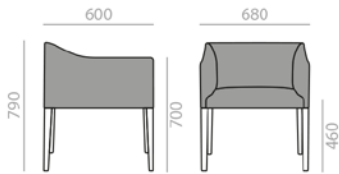

Armchair with upholstered seat and backrest and 4 solid beech wood legs. Wider version. Optional 4 casters.
Sillón con asiento y respaldo tapizado y base de 4 patas de madera maciza de haya. Versión ancha. Opción de 4 ruedas.

	COM cm. per unit	COL m2
1 units	260	5,1
10 units or more	260	

0,35 m3
12,4 kg
x1

€	COM	COL	1	2	3	4	5	6	7	8	9	10	11	L1	L2	L3	L6
	671	696	726	751	770	803	837	870	903	936	968	1.002	1.036	1.068	1.195	1.423	2.044

SERIE 600
Matte lacquered and premium upcharge
Incremento por lacado mate y premium | 17 |

SERIE 800
Bright lacquered upcharge
Incremento por lacado brillo | 24 |



Casters upcharge
Incremento ruedas | 90 |

BU1276

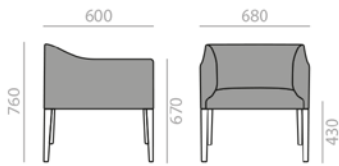

Lounge chair with upholstered seat and backrest and 4-legs solid beech wood frame.
Butaca con asiento y respaldo tapizado y base de 4 patas de madera maciza de haya.

	COM cm. per unit	COL m2
1 units	260	5,1
10 units or more	260	

0,37 m3
12,4 kg
x1

€	COM	COL	1	2	3	4	5	6	7	8	9	10	11	L1	L2	L3	L6
	639	665	695	721	740	773	807	840	874	907	941	976	1.011	1.042	1.170	1.403	2.029

SERIE 600
Matte lacquered and premium upcharge
Incremento por lacado mate y premium | 17 |

SERIE 800
Bright lacquered upcharge
Incremento por lacado brillo | 24 |

BU1277

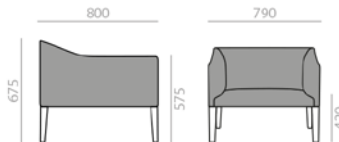

Lounge chair with upholstered seat and back and 4 injected aluminum legs base finished in polished aluminum, white or black.
Butaca con asiento y respaldo tapizado y base de 4 patas de inyección de aluminio en acabado aluminio pulido, blanco o negro.

	COM cm. per unit	COL m2
1 units	180	3,75
10 units or more	160	

0,48 m3
16,9 kg
x1

€	COM	COL	1	2	3	4	5	6	7	8	9	10	11	L1	L2	L3	L6
	1.405	1.447	1.497	1.538	1.570	1.626	1.681	1.737	1.791	1.847	1.902	1.958	2.013	2.062	2.261	2.628	3.653

SF1278

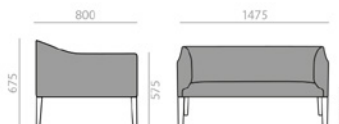

2-seater sofa with upholstered seat and back and 4 injected aluminum legs base finished in polished aluminum, white or black.
Sofá de 2 plazas con asiento y respaldo tapizado y base de 4 patas de inyección de aluminio en acabado aluminio pulido, blanco o negro.

	COM cm. per unit	COL m2
1 units	500	9,8
10 units or more	500	

0,88 m3
25,7 kg
x1

€	COM	COL	1	2	3	4	5	6	7	8	9	10	11	L1	L2	L3	L6
	1.633	1.681	1.740	1.788	1.825	1.889	1.953	2.017	2.081	2.149	2.220	2.291	2.361	2.423	2.679	3.142	4.371

SF1279

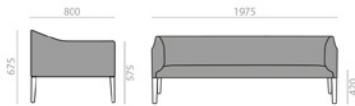

3-seater sofa with upholstered seat and back and 4 injected aluminum legs base finished in polished aluminum, white or black.

Sofá de 3 plazas con asiento y respaldo tapizado y base de 4 patas de inyección de aluminio en acabado aluminio pulido, blanco o negro.

	COM cm. per unit	COL m2
1 units	560	11
10 units or more	560	

1,17 m3
 32,2 kg
 x1

COM	COL	1	2	3	4	5	6	7	8	9	10	11	L1	L2	L3	L6
€ 2.101	2.160	2.232	2.290	2.336	2.413	2.492	2.569	2.648	2.725	2.803	2.881	2.959	3.029	3.310	3.826	5.280

Glides for central base. Tacos para base central.

Use/Usó	Reference/Referencia		Material/Material	Price/Precio	
Hard floors. Suelos duros.	TS0550		Plastic (PE). Plástico (PE).	0 €	Standard. Estándar.
Wooden and delicate floors. Suelos de madera y delicados.	TS0551		Plastic (PE) with felt. Plástico (PE) con fieltro.	3 €	Set of 4 glides. Juego de 4 tacos.
Mats/carpet floors. Suelos de moqueta/alfombra.	TS0552		Metal. Metal.	3 €	

The indicated price is for glides placed on chairs. To order loose parts, please ask to our Sales Department.

El precio indicado en Tarifa es para tacos colocados en las sillas. Para pedidos de tacos sueltos de repuesto, consultar con el Departamento Comercial.

For wooden legs. Para bases de madera.



Optional glides on page 482.

Opciones de tacos deslizantes en página 482.

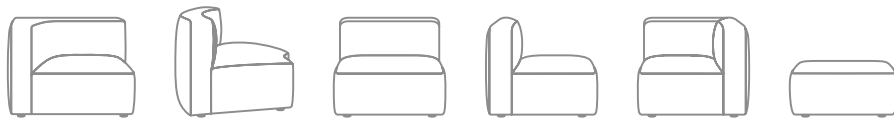

Description
Descripción

Upholstered modular sofa that adapts to any space due to its great versatility. Available in different widths and versions: corner sofa, chaise lounge and curved. Fully upholstered ottoman version. Linking device included. Customizable inner seam tape finish in different colors. Loosen cushions. Available in all our fabrics for indoor use. Oak or walnut occasional table. Additional options include: USB charging system.

Sofá modular tapizado que permite adaptarse a cualquier espacio por su gran versatilidad. Disponible en diferentes anchos y versiones: rinconero, chaise longue y curvo. Version de reposapiés tapizado. Sistema de unión incluido. Costura interior personalizable en diferentes colores. Cojines auxiliares. Disponibles en todos nuestros tejidos para uso interior. Opción de mesa auxiliar de roble o nogal. Opciones disponibles: sistema USB de carga.

Upholstery
Tapicería

The Dado collection supports following upholsteries of Andreu World Catalogue. For fabrics in our catalogue not specified in this box or customers own materials please contact our Customer Service Department.

La colección Dado admite las siguientes tapicerías del catálogo de Andreu World. Para las telas de nuestro catálogo no indicadas en este cuadro o telas cliente, consultar con nuestro Departamento Comercial.

Fabrics / Telas

- 1 Soft-fiber
- Jacquard One
- Jacquard Three
- Citadel
- Sand
- Era
- Gravity
- Rivet
- Urban
- Reel One (in/out)
- Spin One
- Spin Two
- Spin Three
- Spin Four
- Spin Five

- 3 Jacquard Four
- Medley
- Revive 1
- Natte
- Main Line Flax
- Loom Two (in/out)
- Mezzo
- Reel two (in/out)
- Jacquard Five

- 5 Silk
- Synergy
- Step
- Step Melange
- Blazer
- Melange Nap
- Chili
- Noma
- Re-wool

- 8 Capture
- Fiord 2
- Tonus 4
- Divina 3
- Lopi
- Domino
- Atrium

Faux Leather / Ecopiel

- 1 Valencia
- 2 Silvertex
- 3 Maglia
- 4 Dolce
- 8 Ultraleather
- 9 Brisa
- Brisa Distressed
- Fresco
- Ultraleather Pro
- Promessa
- 10 Tottori
- Coast (in/out)
- 11 Reef Pro
- Volar Bio

Leather / Piel

- L1 High grade cow leather.
- Piel de vaca de 1ª categoría.
- L3 Polished full grain leather.
- Plena flor pulida.
- L6 Aniline leather batique-effect.
- Scandinavian cattle.
- Piel anilina efecto batique.
- Ganado escandinavo.

- 4 Jacquard 4 Special
- Nexus
- Field 2
- Remix 3
- Heritage
- Savane
- Loom Three
- Loom Four
- Cura
- Oceanic
- Reel Three (in/out)
- Reel Four (in/out)
- Reflect
- Spin Six

- 6 Go check
- Swing
- Chartres
- Zori
- Patio
- Tack Two (in/out)
- Tack Three (in/out)
- 7 Canvas 2
- Select
- Clara 2
- Tack Five (in/out)
- Hero 2

- 9 Divina MD
- Divina Melange 3
- Hallingdal 65
- Steelcut Trio 3
- Tack Four (in/out)

- 11 Arda
- Ecriture
- Zero

Inner seam tape finish
Acabado cinta costura Interior

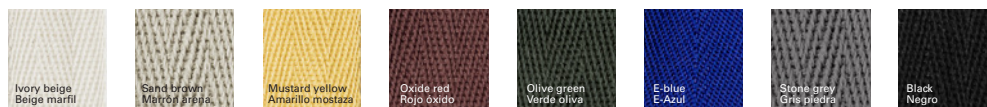

Certificates
Certificados

Fireproof polyurethane foam
Espuma de poliuretano ignifuga

UNE EN 1021:2006
BS 5852 part 2 crib 5
UNI 9175 Classe 1 IM
BKZ 5.2
California TB 117:2013
California TB 133*

*Contact our Customer Department
*Consultar con nuestro Departamento Comercial

Quality - Resistance
Calidad - Resistencia

UNE EN 16139:2013

Intellectual property Propiedad intelectual

All our collections are protected by international industrial design registries, designs patents, copyrights and intellectual Property laws. Unauthorized use of AW International Property is a criminal offence and can lead to prosecution.
Todas nuestras colecciones están protegidas por registros de diseño industrial, diseño de patente, copyright y derechos de propiedad intelectual en todo el mundo. El uso no autorizado de los diseños y propiedad intelectual de AW supone un delito que puede ser sometido a acción judicial.



BU0320

Lounge chair with upholstered seat and back.
Butaca con asiento y respaldo tapizado.

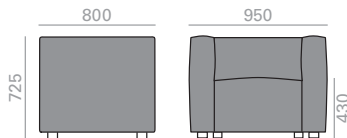

	COM cm. per unit	COL m2
1 units	530	10,5
10 units or more	520	

0,64 m3
 32,8 kg
 x1

€	COM	COL	1	2	3	4	5	6	7	8	9	10	11	L1	L2	L3	L6
	1.381	1.437	1.506	1.562	1.605	1.680	1.756	1.831	1.906	1.981	2.055	2.130	2.205	2.273	2.543	3.036	4.342



USB charging system upcharge
Incremento por sistema de USB de carga

| 195 |

SF0300

Sofa with upholstered seat and back.
Sofá con asiento y respaldo tapizado.

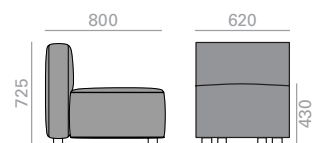

	COM cm. per unit	COL m2
1 units	270	5,5
10 units or more	230	

0,45 m3
 20,2 kg
 x1

€	COM	COL	1	2	3	4	5	6	7	8	9	10	11	L1	L2	L3	L6
	1.137	1.163	1.194	1.220	1.240	1.274	1.308	1.342	1.376	1.412	1.446	1.480	1.515	1.549	1.701	1.974	2.700

SF0301

Sofa with upholstered seat and back. Wider version.
Sofá con asiento y respaldo tapizado. Versión ancha.

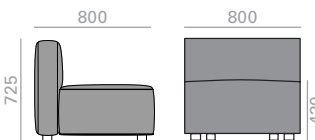

	COM cm. per unit	COL m2
1 units	270	5,5
10 units or more	250	

0,54 m3
 31,9 kg
 x1

€	COM	COL	1	2	3	4	5	6	7	8	9	10	11	L1	L2	L3	L6
	1.288	1.319	1.356	1.387	1.412	1.451	1.493	1.543	1.603	1.666	1.726	1.788	1.848	1.902	2.122	2.526	3.588

SF0302

Corner sofa (right side) with upholstered seat and back.
Sofá rinconero (lado derecho) con asiento y respaldo tapizado.

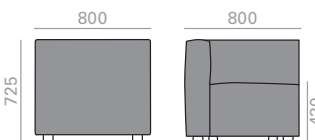

	COM cm. per unit	COL m2
1 units	370	7,5
10 units or more	360	

0,54 m3
 34,1 kg
 x1

€	COM	COL	1	2	3	4	5	6	7	8	9	10	11	L1	L2	L3	L6
	1.119	1.152	1.193	1.226	1.251	1.296	1.340	1.385	1.429	1.472	1.517	1.561	1.605	1.645	1.803	2.105	2.933



USB charging system upcharge
Incremento por sistema de USB de carga

| 195 |

SF0304

Corner sofa (left side) with upholstered seat and back.
Sofá rinconero (lado izquierdo) con asiento y respaldo tapizado.

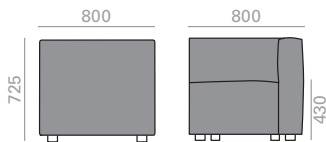

	COM cm. per unit	COL m2
1 units	370	7,5
10 units or more	360	

0,54 m3
 34,1 kg
 x1

€	COM	COL	1	2	3	4	5	6	7	8	9	10	11	L1	L2	L3	L6
	1.119	1.152	1.193	1.226	1.251	1.296	1.340	1.385	1.429	1.472	1.517	1.561	1.605	1.645	1.803	2.105	2.933



USB charging system upcharge
Incremento por sistema de USB de carga

| 195 |

SF0303

Corner sofa (right side) with upholstered seat and back.
Wider version.
Sofá rinconero (lado derecho) con asiento y respaldo tapizado. Versión ancha.

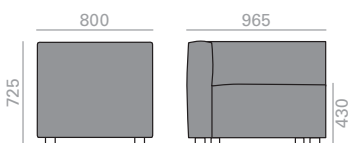

	COM cm. per unit	COL m2
1 units	420	8,5
10 units or more	410	

0,65 m3
 36,2 kg
 x1

€	COM	COL	1	2	3	4	5	6	7	8	9	10	11	L1	L2	L3	L6
	1.292	1.335	1.386	1.427	1.460	1.517	1.572	1.628	1.684	1.740	1.795	1.852	1.908	1.957	2.159	2.527	3.502



USB charging system upcharge
Incremento por sistema de USB de carga

| 195 |

SF0305

Corner sofa (left side) with upholstered seat and back.
Wider version.
Sofá rinconero (lado izquierdo) con asiento y respaldo tapizado. Versión ancha.

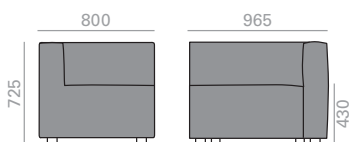

	COM cm. per unit	COL m2
1 units	420	8,5
10 units or more	410	

0,65 m3
 36,2 kg
 x1

€	COM	COL	1	2	3	4	5	6	7	8	9	10	11	L1	L2	L3	L6
	1.292	1.335	1.386	1.427	1.460	1.517	1.572	1.628	1.684	1.740	1.795	1.852	1.908	1.957	2.159	2.527	3.502



USB charging system upcharge
Incremento por sistema de USB de carga

| 195 |

SF0306

Corner sofa with chaise lounge (right side) and upholstered seat and back.
Sofá rinconero (lado derecho) con asiento y respaldo tapizado.

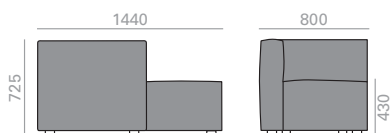

	COM cm. per unit	COL m2
1 units	420	8,5
10 units or more	410	

0,95 m3
 49,6 kg
 x1

€	COM	COL	1	2	3	4	5	6	7	8	9	10	11	L1	L2	L3	L6
	1.426	1.467	1.517	1.558	1.589	1.645	1.700	1.754	1.809	1.865	1.919	1.974	2.028	2.077	2.275	2.659	3.710

SF0309

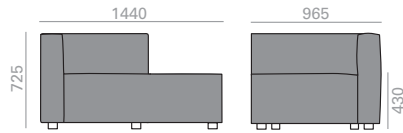

Corner sofa with chaise lounge (left side) and upholstered seat and back. Wider version.
Sofá rinconero (lado izquierdo) con asiento y respaldo tapizado. Versión ancha.

	COM cm. per unit	COL m2
1 units	440	8,75
10 units or more	430	

1,21 m3
 59 kg
 x1

COM	COL	1	2	3	4	5	6	7	8	9	10	11	L1	L2	L3	L6
€ 1.620	1.667	1.724	1.771	1.806	1.869	1.931	1.994	2.057	2.119	2.180	2.243	2.305	2.361	2.587	3.022	4.217

SF0307

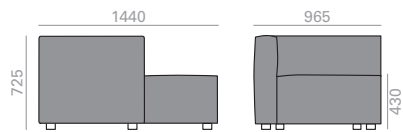

Corner sofa with chaise lounge (right side) and upholstered seat and back. Wider version.
Sofá rinconero (lado derecho) con asiento y respaldo tapizado. Versión ancha.

	COM cm. per unit	COL m2
1 units	440	8,75
10 units or more	430	

1,21 m3
 59 kg
 x1

COM	COL	1	2	3	4	5	6	7	8	9	10	11	L1	L2	L3	L6
€ 1.620	1.667	1.724	1.771	1.806	1.869	1.931	1.994	2.057	2.119	2.180	2.243	2.305	2.361	2.587	3.022	4.217

SF0308

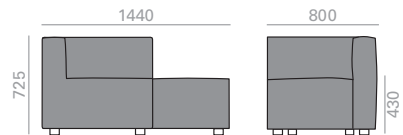

Corner sofa with chaise lounge (left side) and upholstered seat and back.
Sofá rinconero (lado izquierdo) con asiento y respaldo tapizado.

	COM cm. per unit	COL m2
1 units	420	8,5
10 units or more	410	

0,95 m3
 49,6 kg
 x1

COM	COL	1	2	3	4	5	6	7	8	9	10	11	L1	L2	L3	L6
€ 1.426	1.467	1.517	1.558	1.589	1.645	1.700	1.754	1.809	1.865	1.919	1.974	2.028	2.077	2.275	2.659	3.710

SF0360

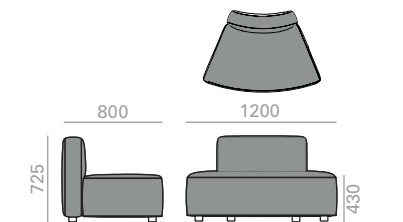

Curved modular sofa with upholstered seat and backrest. Open curved version.
Sofá modular curvo con asiento y respaldo tapizados. Versión curva abierta.

	COM cm. per unit	COL m2
1 units	360	7,25
10 units or more	320	

0,86 m3
 48,7 kg
 x1

COM	COL	1	2	3	4	5	6	7	8	9	10	11	L1	L2	L3	L6
€ 1.514	1.550	1.596	1.633	1.661	1.711	1.760	1.809	1.859	1.908	1.957	2.008	2.068	2.123	2.344	2.743	3.800

SF0361

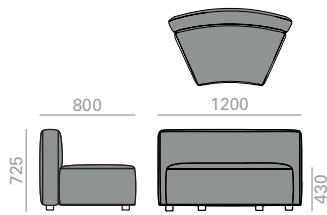

Curved modular sofa with upholstered seat and backrest. Closed curved version.
Sofá modular curvo con asiento y respaldo tapizados. Versión curva cerrada.

	COM cm. per unit	COL m2
1 units	420	8,5
10 units or more	390	

0,86 m3
 54,65 kg
 x1

€	COM	COL	1	2	3	4	5	6	7	8	9	10	11	L1	L2	L3	L6
	1.443	1.487	1.539	1.582	1.615	1.673	1.731	1.800	1.870	1.941	2.013	2.082	2.154	2.218	2.473	2.940	4.174

SF0362

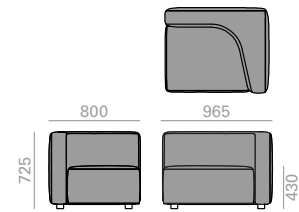

Modular corner sofa (left side) with upholstered seat and backrest.
Sofá modular rinconero con asiento y respaldo tapizado. Esquina lado izquierdo.

	COM cm. per unit	COL m2
1 units	390	7,75
10 units or more	380	

0,63 m3
 31,6 kg
 x1

€	COM	COL	1	2	3	4	5	6	7	8	9	10	11	L1	L2	L3	L6
	1.733	1.777	1.830	1.873	1.907	1.965	2.022	2.080	2.138	2.195	2.254	2.312	2.369	2.421	2.629	3.010	4.061



USB charging system upcharge
Incremento por sistema de USB de carga

| 195 |

SF0363

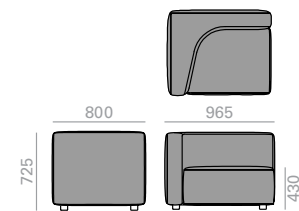

Modular corner sofa (right side) with upholstered seat and backrest.
Sofá modular rinconero con asiento y respaldo tapizado. Esquina lado derecho.

	COM cm. per unit	COL m2
1 units	390	7,75
10 units or more	380	

0,63 m3
 31,6 kg
 x1

€	COM	COL	1	2	3	4	5	6	7	8	9	10	11	L1	L2	L3	L6
	1.733	1.777	1.830	1.873	1.907	1.965	2.022	2.080	2.138	2.195	2.254	2.312	2.369	2.421	2.629	3.010	4.061



USB charging system upcharge
Incremento por sistema de USB de carga

| 195 |

RS0310

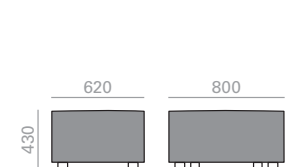

Upholstered ottoman.
Reposapiés tapizado.

	COM cm. per unit	COL m2
1 units	180	3,75
10 units or more	150	

0,25 m3
 10 kg
 x1

€	COM	COL	1	2	3	4	5	6	7	8	9	10	11	L1	L2	L3	L6
	668	683	703	720	731	752	774	795	816	837	858	879	900	920	1.003	1.164	1.592



Casters upcharge
Incremento ruedas

| 15 |

RS0364

Upholstered ottoman.
Reposapiés tapizado.

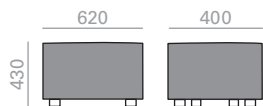

	COM cm. per unit	COL m2
1 units	120	2,5
10 units or more	110	

0,14 m3
 8,4 kg
 x1

€	COM	COL	1	2	3	4	5	6	7	8	9	10	11	L1	L2	L3	L6
	591	605	621	635	646	664	682	700	719	737	755	773	790	807	872	991	1.308

RS0365

Upholstered ottoman.
Reposapiés tapizado.

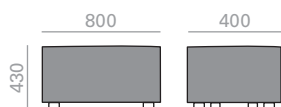

	COM cm. per unit	COL m2
1 units	140	3
10 units or more	120	

0,16 m3
 9,4 kg
 x1

€	COM	COL	1	2	3	4	5	6	7	8	9	10	11	L1	L2	L3	L6
	595	609	626	640	651	670	688	708	726	744	763	781	801	816	884	1.007	1.331

RS0366

Upholstered ottoman.
Reposapiés tapizado.

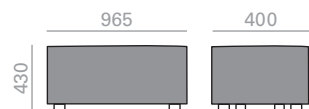

	COM cm. per unit	COL m2
1 units	160	3,25
10 units or more	140	

0,21 m3
 10,9 kg
 x1

€	COM	COL	1	2	3	4	5	6	7	8	9	10	11	L1	L2	L3	L6
	661	676	695	711	722	744	765	785	806	826	847	869	889	907	982	1.119	1.499

RS0367

Upholstered ottoman.
Reposapiés tapizado.

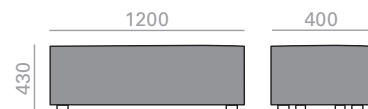

	COM cm. per unit	COL m2
1 units	180	3,75
10 units or more	160	

0,25 m3
 13,1 kg
 x1

€	COM	COL	1	2	3	4	5	6	7	8	9	10	11	L1	L2	L3	L6
	709	726	748	766	780	804	829	853	877	901	925	949	974	995	1.082	1.241	1.660

RS0368

Upholstered ottoman.
Reposapiés tapizado.

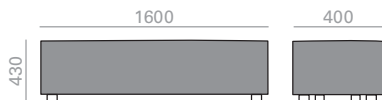

	COM cm. per unit	COL m2
1 units	220	4,5
10 units or more	210	

0,35 m3
 15 kg
 x1

€	COM	COL	1	2	3	4	5	6	7	8	9	10	11	L1	L2	L3	L6
	736	758	785	807	826	855	885	916	945	975	1.005	1.035	1.066	1.093	1.201	1.397	1.929

RS0311

Upholstered ottoman.
Reposapiés tapizado.

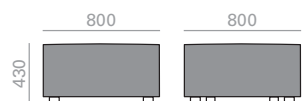

	COM cm. per unit	COL m2
1 units	180	3,75
10 units or more	170	

0,35 m3
 12,5 kg
 x1

€	COM	COL	1	2	3	4	5	6	7	8	9	10	11	L1	L2	L3	L6
	700	719	740	758	772	796	820	843	867	891	915	939	963	984	1.070	1.227	1.679



Casters upcharge
Incremento ruedas | 15 |

RS0312

Upholstered ottoman.
Reposapiés tapizado.

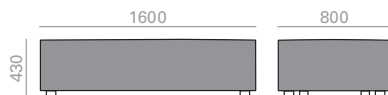

	COM cm. per unit	COL m2
1 units	330	6,5
10 units or more	290	

0,69 m3
 22,2 kg
 x1

€	COM	COL	1	2	3	4	5	6	7	8	9	10	11	L1	L2	L3	L6
	905	935	970	1.000	1.023	1.061	1.106	1.155	1.202	1.253	1.300	1.349	1.399	1.443	1.617	1.940	2.801



Casters upcharge
Incremento ruedas | 24 |

RS0313

Upholstered ottoman.
Reposapiés tapizado.



	COM cm. per unit	COL m2
1 units	150	3
10 units or more	140	

0,19 m3
 7,8 kg
 x1

€	COM	COL	1	2	3	4	5	6	7	8	9	10	11	L1	L2	L3	L6
	544	558	574	589	600	618	637	656	674	693	713	731	750	766	834	957	1.284



Casters upcharge
Incremento ruedas | 15 |

RS0314

Upholstered ottoman.
Reposapiés tapizado.

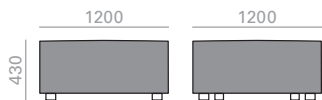

	COM cm. per unit	COL m2
1 units	380	7,75
10 units or more	300	

0,78 m3
 25,6 kg
 x1

€	COM	COL	1	2	3	4	5	6	7	8	9	10	11	L1	L2	L3	L6
	906	934	970	999	1.021	1.060	1.099	1.137	1.175	1.214	1.252	1.290	1.328	1.363	1.501	1.754	2.422



Casters upcharge
Incremento ruedas

| 24 |

RS0369

Upholstered curved ottoman.
Reposapiés curvo tapizado.

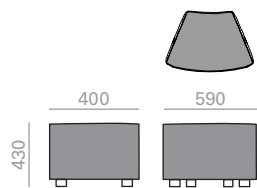

	COM cm. per unit	COL m2
1 units	110	2,25
10 units or more	90	

0,13 m3
 8,4 kg
 x1

€	COM	COL	1	2	3	4	5	6	7	8	9	10	11	L1	L2	L3	L6
	592	604	618	631	640	656	672	688	703	720	735	752	767	781	839	944	1.222

RS0370

Upholstered curved ottoman.
Reposapiés curvo tapizado.

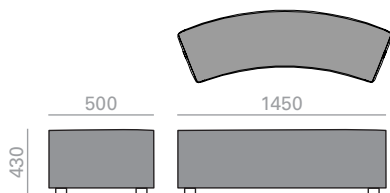

	COM cm. per unit	COL m2
1 units	210	5
10 units or more	180	

0,38 m3
 24 kg
 x1

€	COM	COL	1	2	3	4	5	6	7	8	9	10	11	L1	L2	L3	L6
	782	800	823	842	857	881	907	931	955	983	1.012	1.043	1.072	1.098	1.203	1.398	1.910

ME0315

Oak occasional table.
Mesa auxiliar de roble

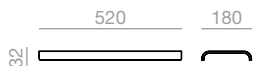

1 m3
 0,9 kg
 x1

€ 70

ME0316

Walnut occasional table.
Mesa auxiliar de nogal



1 m3
 0,9 kg
 x1

€ 72

CJ3010

Loose cushion
Cojín auxiliar

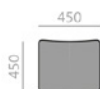

	COM cm. per unit	COL m2
1 units	65	1,5
10 units or more	650	

0,02 m3
 2 kg
 x1

€	COM	COL	1	2	3	4	5	6	7	8	9	10	11	L1	L2	L3	L6
	77	82	89	95	99	107	115	124	132	140	150	159	169	177	211	273	435

CJ3011

Loose cushion
Cojín auxiliar

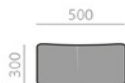

	COM cm. per unit	COL m2
1 units	45	1
10 units or more	450	

0,02 m3
 2 kg
 x1

€	COM	COL	1	2	3	4	5	6	7	8	9	10	11	L1	L2	L3	L6
	84	89	93	98	102	108	114	119	125	131	137	143	151	154	183	216	372

Examples of modular configurations Ejemplos de combinaciones modulares

Set 1 / Conjunto 1

2 Modules 2 Módulos
SF0303 + SF0305

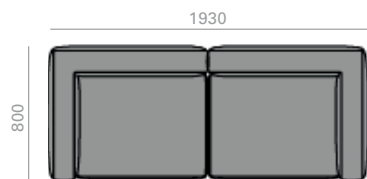

	COM cm. per unit	COL m2
1 units	840	17
10 units or more	820	

€	COM	COL	1	2	3	4	5	6	7	8	9	10	11	L1	L2	L3	L6
	2.584	2.670	2.772	2.854	2.920	3.034	3.144	3.256	3.368	3.480	3.590	3.704	3.816	3.914	4.318	5.054	7.004

Set 2 / Conjunto 2

2 Modules 2 Módulos
SF0302 + SF0304



	COM cm. per unit	COL m2
1 units	740	15
10 units or more	720	

€	COM	COL	1	2	3	4	5	6	7	8	9	10	11	L1	L2	L3	L6
	2.238	2.304	2.386	2.452	2.502	2.592	2.680	2.770	2.858	2.944	3.034	3.122	3.210	3.290	3.606	4.210	5.866

Set 3 / Conjunto 3

3 Modules 3 Módulos
SF0303 + SF0301 + SF0305



	COM cm. per unit	COL m2
1 units	1110	22,5
10 units or more	1070	

€	COM	COL	1	2	3	4	5	6	7	8	9	10	11	L1	L2	L3	L6
	3.872	3.989	4.128	4.241	4.332	4.485	4.637	4.799	4.971	5.146	5.316	5.492	5.664	5.816	6.440	7.580	10.592

Examples of modular configurations Ejemplos de combinaciones modulares

Set 4 / Conjunto 4

3 Modules 3 Módulos
SF0302 + SF0300 + SF0304



	COM cm. per unit	COL m2
1 units	1010	20,5
10 units or more	950	

	COM	COL	1	2	3	4	5	6	7	8	9	10	11	L1	L2	L3	L6
€	3.375	3.467	3.580	3.672	3.742	3.866	3.988	4.112	4.234	4.356	4.480	4.602	4.725	4.839	5.307	6.184	8.566

Set 5 / Conjunto 5

3 Modules 3 Módulos
SF0303 + SF0301 + RS0311



	COM cm. per unit	COL m2
1 units	870	17,75
10 units or more	830	

	COM	COL	1	2	3	4	5	6	7	8	9	10	11	L1	L2	L3	L6
€	3.280	3.373	3.482	3.572	3.644	3.764	3.885	4.014	4.154	4.297	4.436	4.579	4.719	4.843	5.351	6.280	8.769

Set 6 / Conjunto 6

3 Modules 3 Módulos
SF0302 + SF0300 + RS0310



	COM cm. per unit	COL m2
1 units	820	16,75
10 units or more	740	

	COM	COL	1	2	3	4	5	6	7	8	9	10	11	L1	L2	L3	L6
€	2.924	2.998	3.090	3.166	3.222	3.322	3.422	3.522	3.621	3.721	3.821	3.920	4.020	4.114	4.507	5.243	7.225

Examples of modular configurations Ejemplos de combinaciones modulares

Set 7 / Conjunto 7

3 Modules 3 Módulos
SF0307 + RS0311 + SF0305

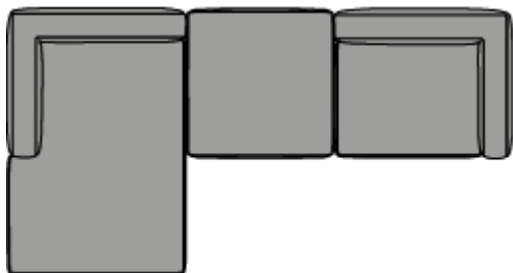

	COM cm. per unit	COL m2
1 units	1040	21
10 units or more	1010	

€	COM	COL	1	2	3	4	5	6	7	8	9	10	11	L1	L2	L3	L6
€	3.612	3.721	3.850	3.956	4.038	4.182	4.323	4.465	4.608	4.750	4.890	5.034	5.176	5.302	5.816	6.776	9.398

Set 8 / Conjunto 8

3 Modules 3 Módulos
SF0306 + RS0310 + SF0304

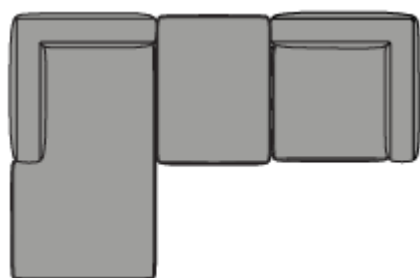

	COM cm. per unit	COL m2
1 units	970	19,75
10 units or more	920	

€	COM	COL	1	2	3	4	5	6	7	8	9	10	11	L1	L2	L3	L6
€	3.213	3.302	3.413	3.504	3.571	3.693	3.814	3.934	4.054	4.174	4.294	4.414	4.533	4.642	5.081	5.928	8.235

Set 9 / Conjunto 9

3 Modules 3 Módulos
SF0303 + SF0301 + SF0309

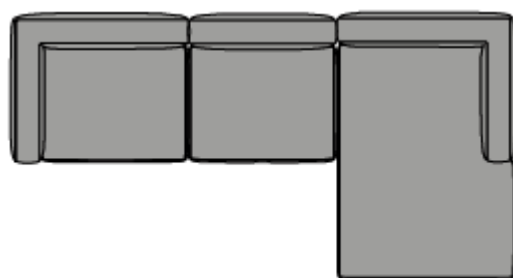

	COM cm. per unit	COL m2
1 units	1130	22,75
10 units or more	1090	

€	COM	COL	1	2	3	4	5	6	7	8	9	10	11	L1	L2	L3	L6
€	4.200	4.321	4.466	4.585	4.678	4.837	4.996	5.165	5.344	5.525	5.701	5.883	6.061	6.220	6.868	8.075	11.307

Examples of modular configurations Ejemplos de combinaciones modulares

Set 10 / Conjunto 10

3 Modules 3 Módulos
SF0302 + SF0300 + SF0308

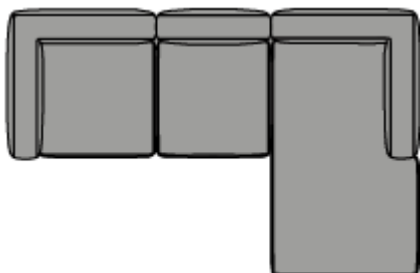

	COM cm. per unit	COL m2
1 units	1060	21,5
10 units or more	1000	

€	COM	COL	1	2	3	4	5	6	7	8	9	10	11	L1	L2	L3	L6
	3.682	3.782	3.904	4.004	4.080	4.215	4.348	4.481	4.614	4.749	4.882	5.015	5.148	5.271	5.779	6.738	9.343

Set 11 / Conjunto 11

4 Modules 4 Módulos
SF0307 + SF0301 + SF0301 + SF0309

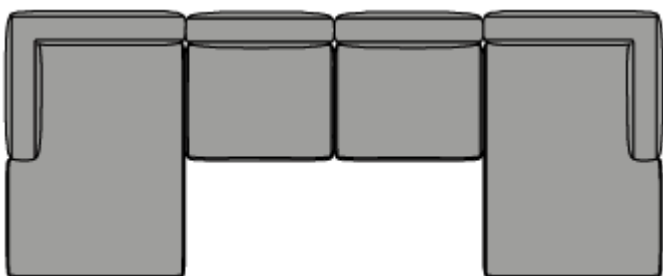

	COM cm. per unit	COL m2
1 units	1420	28,5
10 units or more	1360	

€	COM	COL	1	2	3	4	5	6	7	8	9	10	11	L1	L2	L3	L6
	5.816	5.972	6.160	6.316	6.436	6.640	6.848	7.074	7.320	7.570	7.812	8.062	8.306	8.526	9.418	11.096	15.610

Set 12 / Conjunto 12

4 Modules 4 Módulos
SF0306 + SF0300 + SF0300 + SF0308

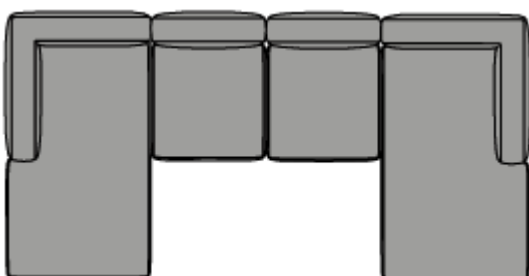

	COM cm. per unit	COL m2
1 units	1380	28
10 units or more	1280	

€	COM	COL	1	2	3	4	5	6	7	8	9	10	11	L1	L2	L3	L6
	5.126	5.260	5.422	5.556	5.658	5.838	6.016	6.192	6.370	6.554	6.730	6.908	7.086	7.252	7.952	9.266	12.820

Examples of modular configurations Ejemplos de combinaciones modulares

Set 13 / Conjunto 13

4 Modules 4 Módulos
SF0301 + SF0301 + SF0301 + SF0301



	COM cm. per unit	COL m2
1 units	1080	22
10 units or more	1000	

€	COM	COL	1	2	3	4	5	6	7	8	9	10	11	L1	L2	L3	L6
	5.152	5.276	5.424	5.548	5.648	5.804	5.972	6.172	6.412	6.664	6.904	7.152	7.392	7.608	8.488	10.104	14.352

Set 14 / Conjunto 14

4 Modules 4 Módulos
SF0300 + SF0300 + SF0300 + SF0300



	COM cm. per unit	COL m2
1 units	1080	22
10 units or more	920	

€	COM	COL	1	2	3	4	5	6	7	8	9	10	11	L1	L2	L3	L6
	4.548	4.652	4.776	4.880	4.960	5.096	5.232	5.368	5.504	5.648	5.784	5.920	6.060	6.196	6.804	7.896	10.800

Set 15 / Conjunto 15

4 Modules 4 Módulos
RS0311 + SF0301 + SF0301 + RS0311



	COM cm. per unit	COL m2
1 units	900	18,5
10 units or more	840	

€	COM	COL	1	2	3	4	5	6	7	8	9	10	11	L1	L2	L3	L6
	3.976	4.076	4.192	4.290	4.368	4.494	4.626	4.772	4.940	5.114	5.282	5.454	5.622	5.772	6.384	7.506	10.534

Examples of modular configurations Ejemplos de combinaciones modulares

Set 16 / Conjunto 16

4 Modules 4 Módulos

RS0310 + SF0300 + SF0300 + RS0310



	COM cm. per unit	COL m2
1 units	900	18,5
10 units or more	760	

€	COM	COL	1	2	3	4	5	6	7	8	9	10	11	L1	L2	L3	L6
	3.610	3.692	3.794	3.880	3.942	4.052	4.164	4.274	4.384	4.498	4.608	4.718	4.830	4.938	5.408	6.276	8.584

Set 17 / Conjunto 17

4 Modules 4 Módulos

SF0303 + SF0301 + RS0311 + SF0309

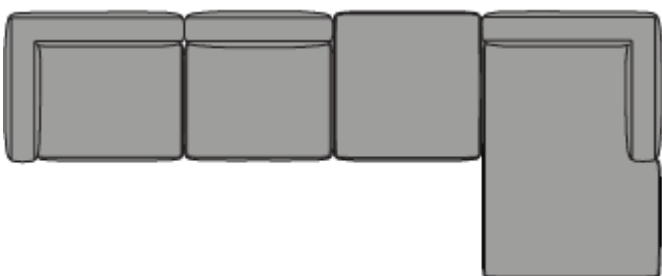

	COM cm. per unit	COL m2
1 units	1310	26,5
10 units or more	1260	

€	COM	COL	1	2	3	4	5	6	7	8	9	10	11	L1	L2	L3	L6
	4.900	5.040	5.206	5.343	5.450	5.633	5.816	6.008	6.211	6.416	6.616	6.822	7.024	7.204	7.938	9.302	12.986

Set 18 / Conjunto 18

4 Modules 4 Módulos

SF0302 + SF0300 + RS0310 + SF0308

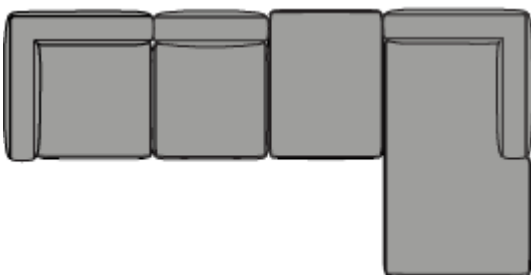

	COM cm. per unit	COL m2
1 units	1240	25,25
10 units or more	1150	

€	COM	COL	1	2	3	4	5	6	7	8	9	10	11	L1	L2	L3	L6
	4.350	4.465	4.607	4.724	4.811	4.967	5.122	5.276	5.430	5.586	5.740	5.894	6.048	6.191	6.782	7.902	10.935

Examples of modular configurations Ejemplos de combinaciones modulares

Set 19 / Conjunto 19

4 Modules 4 Módulos
SF0303 + SF0301 + RS0311 + SF0305



	COM cm. per unit	COL m2
1 units	1290	26,25
10 units or more	1240	

€	COM	COL	1	2	3	4	5	6	7	8	9	10	11	L1	L2	L3	L6
	4.572	4.708	4.868	4.999	5.104	5.281	5.457	5.642	5.838	6.037	6.231	6.431	6.627	6.800	7.510	8.807	12.271

Set 20 / Conjunto 20

4 Modules 4 Módulos
SF0302 + SF0300 + RS0310 + SF0304



	COM cm. per unit	COL m2
1 units	1190	24,25
10 units or more	1100	

€	COM	COL	1	2	3	4	5	6	7	8	9	10	11	L1	L2	L3	L6
	4.043	4.150	4.283	4.392	4.473	4.618	4.762	4.907	5.050	5.193	5.338	5.481	5.625	5.759	6.310	7.348	10.158

Set 21 / Conjunto 21

2 Modules 2 Módulos
SF0307 + SF0309



	COM cm. per unit	COL m2
1 units	880	17,5
10 units or more	860	

€	COM	COL	1	2	3	4	5	6	7	8	9	10	11	L1	L2	L3	L6
	3.240	3.334	3.448	3.542	3.612	3.738	3.862	3.988	4.114	4.238	4.360	4.486	4.610	4.722	5.174	6.044	8.434

Examples of modular configurations Ejemplos de combinaciones modulares

Set 22 / Conjunto 22

2 Modules 2 Módulos
SF0306 + SF0308

	COM cm. per unit	COL m2
1 units	840	17
10 units or more	820	



€	COM	COL	1	2	3	4	5	6	7	8	9	10	11	L1	L2	L3	L6
	2.852	2.934	3.034	3.116	3.178	3.290	3.400	3.508	3.618	3.730	3.838	3.948	4.056	4.154	4.550	5.318	7.420

Set 23 / Conjunto 23

5 Modules 5 Módulos
SF0303 + SF0301 + SF0302 + SF0301 + RS0311

	COM cm. per unit	COL m2
1 units	1510	30,75
10 units or more	1440	

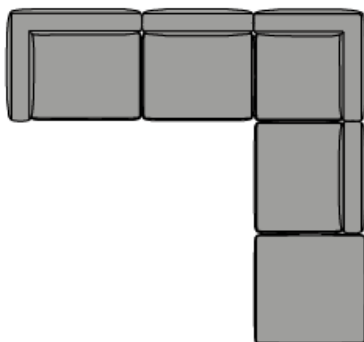

€	COM	COL	1	2	3	4	5	6	7	8	9	10	11	L1	L2	L3	L6
	5.687	5.844	6.031	6.185	6.307	6.511	6.718	6.942	7.186	7.435	7.679	7.928	8.172	8.390	9.276	10.911	15.290

Set 24 / Conjunto 24

5 Modules 5 Módulos
SF0302 + SF0300 + SF0302 + SF0300 + RS0310

	COM cm. per unit	COL m2
1 units	1460	29,75
10 units or more	1330	

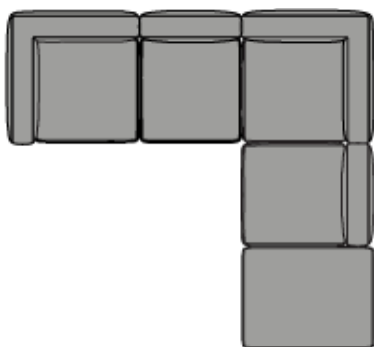

€	COM	COL	1	2	3	4	5	6	7	8	9	10	11	L1	L2	L3	L6
	5.180	5.313	5.477	5.612	5.713	5.892	6.070	6.249	6.426	6.605	6.784	6.961	7.140	7.308	8.011	9.322	12.858

Examples of modular configurations Ejemplos de combinaciones modulares

Set 25 / Conjunto 25

5 Modules 5 Módulos

SF0303 + SF0301 + SF0302 + SF0301 + SF0305

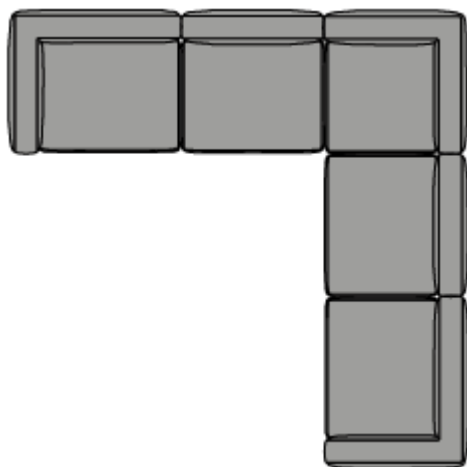

	COM cm. per unit	COL m2
1 units	1750	35,5
10 units or more	1680	

	COM	COL	1	2	3	4	5	6	7	8	9	10	11	L1	L2	L3	L6
€	6.279	6.460	6.677	6.854	6.995	7.232	7.470	7.727	8.003	8.284	8.559	8.841	9.117	9.363	10.365	12.211	17.113

Set 26 / Conjunto 26

5 Modules 5 Módulos

SF0302 + SF0300 + SF0302 + SF0300 + SF0304

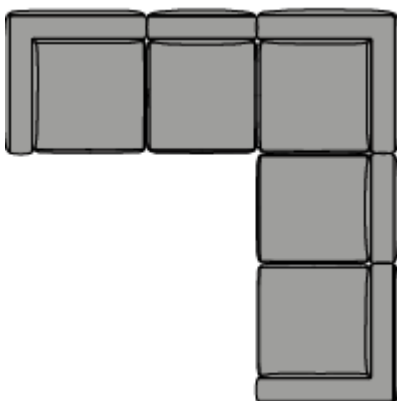

	COM cm. per unit	COL m2
1 units	1650	33,5
10 units or more	1540	

	COM	COL	1	2	3	4	5	6	7	8	9	10	11	L1	L2	L3	L6
€	5.631	5.782	5.967	6.118	6.233	6.436	6.636	6.839	7.039	7.240	7.443	7.643	7.845	8.033	8.811	10.263	14.199

Examples of modular configurations
Ejemplos de combinaciones modulares

Set 27 / Conjunto 27

8 Modules 8 Módulos

SF0303 + SF0301 + SF0302 + SF0301 + SF0301 +
SF0304 + SF0301 + SF0305

	COM cm. per unit	COL m2
1 units	2660	54
10 units or more	2540	

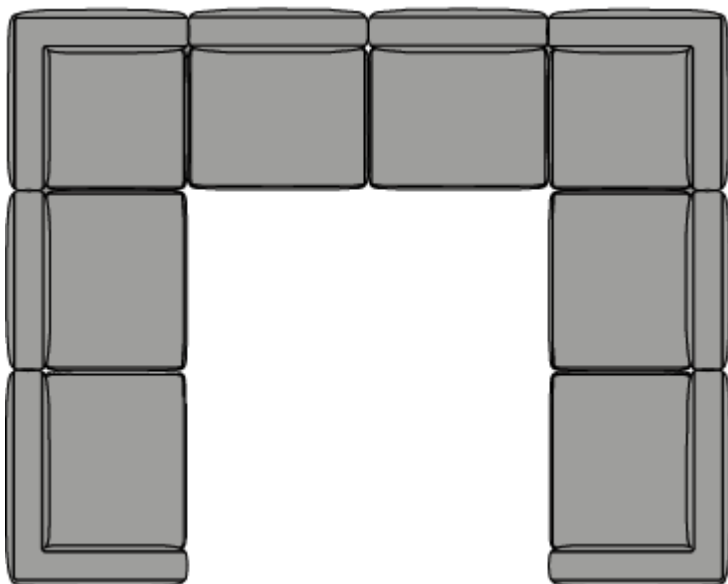

	COM	COL	1	2	3	4	5	6	7	8	9	10	11	L1	L2	L3	L6
€	9.974	10.250	10.582	10.854	11.070	11.430	11.796	12.198	12.638	13.088	13.528	13.978	14.418	14.812	16.412	19.368	27.222

Set 28 / Conjunto 28

8 Modules 8 Módulos

SF0302 + SF0300 + SF0302 + SF0300 + SF0300 +
SF0304 + SF0300 + SF0304

	COM cm. per unit	COL m2
1 units	2560	52
10 units or more	2360	

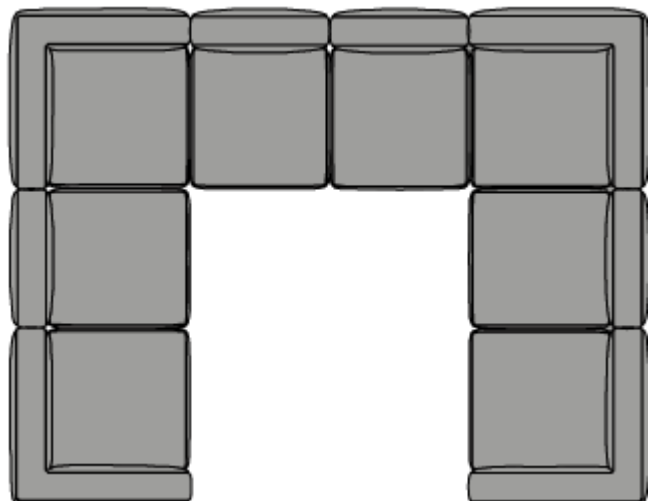

	COM	COL	1	2	3	4	5	6	7	8	9	10	11	L1	L2	L3	L6
€	9.024	9.260	9.548	9.784	9.964	10.280	10.592	10.908	11.220	11.536	11.852	12.164	12.480	12.776	14.016	16.316	22.532

Examples of modular configurations Ejemplos de combinaciones modulares

Set 29 / Conjunto 29

5 Modules 5 Módulos

SF0301 + RS0311 + SF0301 + SF0301 + SF0305

	COM cm. per unit	COL m2
1 units	1410	28,75
10 units or more	1330	

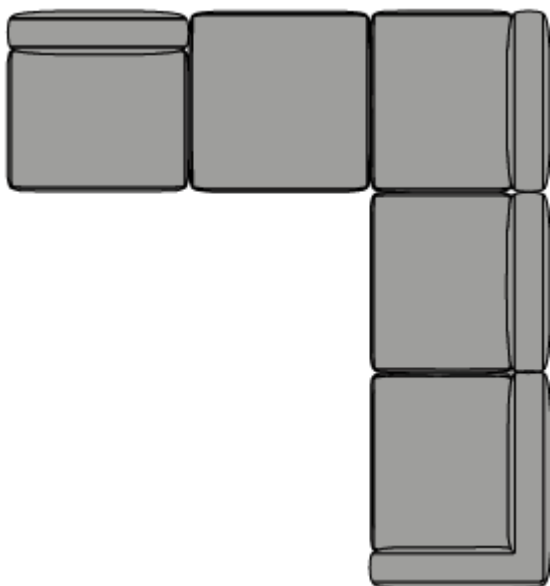

€	COM	COL	1	2	3	4	5	6	7	8	9	10	11	L1	L2	L3	L6
	5.856	6.011	6.194	6.346	6.468	6.666	6.871	7.100	7.360	7.629	7.888	8.155	8.415	8.647	9.595	11.332	15.945

Set 30 / Conjunto 30

5 Modules 5 Módulos

SF0300 + RS0310 + SF0301 + SF0300 + SF0304

	COM cm. per unit	COL m2
1 units	1360	27,75
10 units or more	1220	

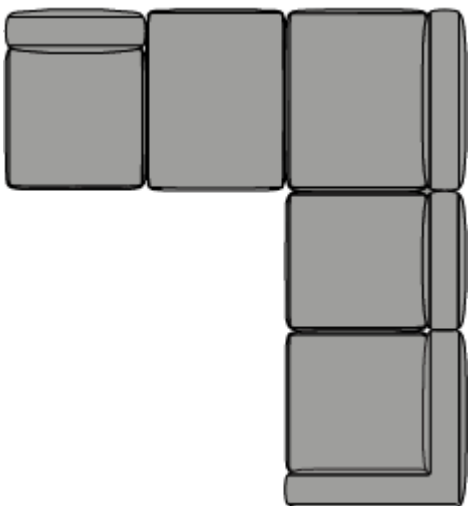

€	COM	COL	1	2	3	4	5	6	7	8	9	10	11	L1	L2	L3	L6
	5.349	5.480	5.640	5.773	5.874	6.047	6.223	6.407	6.600	6.799	6.993	7.188	7.383	7.565	8.330	9.743	13.513

Examples of modular configurations Ejemplos de combinaciones modulares

Set 31 / Conjunto 31

5 Modules 5 Módulos

SF0303 + SF0301 + RS0311 + SF0301 + SF0301

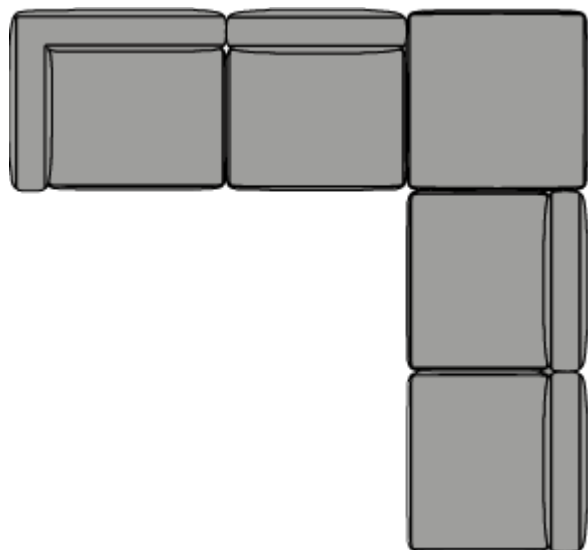

	COM cm. per unit	COL m2
1 units	1410	28,75
10 units or more	1330	

	COM	COL	1	2	3	4	5	6	7	8	9	10	11	L1	L2	L3	L6
€	5.856	6.011	6.194	6.346	6.468	6.666	6.871	7.100	7.360	7.629	7.888	8.155	8.415	8.647	9.595	11.332	15.945

Set 32 / Conjunto 32

5 Modules 5 Módulos

SF0302 + SF0300 + RS0311 + SF0300 + SF0300

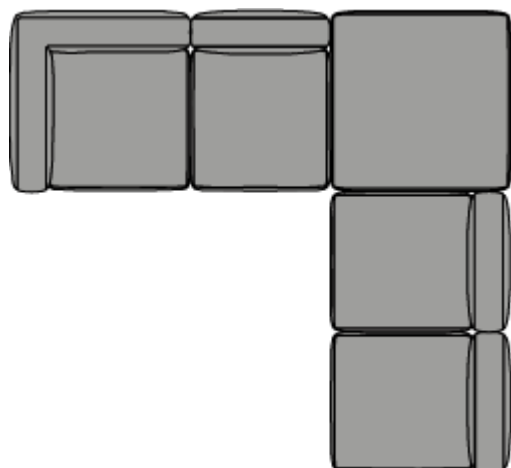

	COM cm. per unit	COL m2
1 units	1360	27,75
10 units or more	1220	

	COM	COL	1	2	3	4	5	6	7	8	9	10	11	L1	L2	L3	L6
€	5.230	5.360	5.515	5.644	5.743	5.914	6.084	6.254	6.424	6.599	6.770	6.940	7.113	7.276	7.976	9.254	12.712

Examples of modular configurations
Ejemplos de combinaciones modulares

Set 33 / Conjunto 33

6 Modules 6 Módulos
SF0303 + SF0301 + RS0311 + RS0311 + SF0301 + SF0305

	COM cm. per unit	COL m2
1 units	1740	35,5
10 units or more	1660	

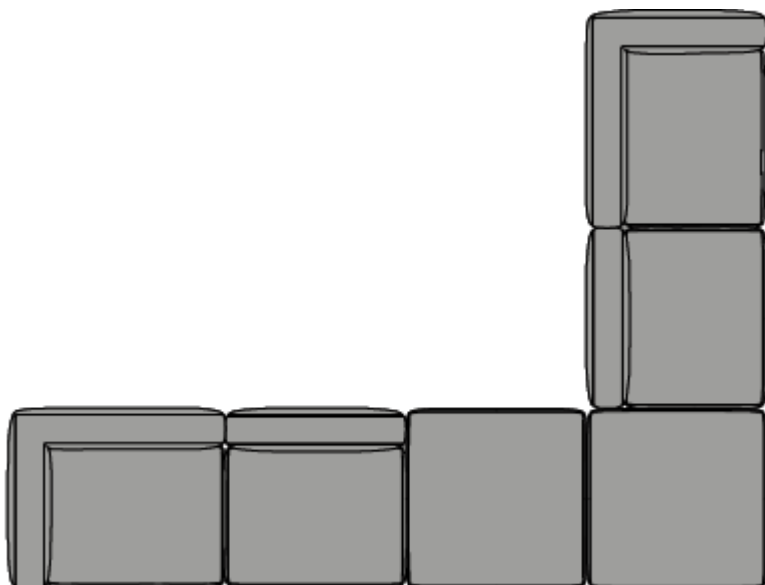

€	COM	COL	1	2	3	4	5	6	7	8	9	10	11	L1	L2	L3	L6
	6.560	6.746	6.964	7.144	7.288	7.528	7.770	8.028	8.308	8.594	8.872	9.158	9.438	9.686	10.702	12.560	17.538

Set 34 / Conjunto 34

6 Modules 6 Módulos
SF0302 + SF0301 + RS0311 + RS0311 + SF0301 + SF0304

	COM cm. per unit	COL m2
1 units	1640	33,5
10 units or more	1560	

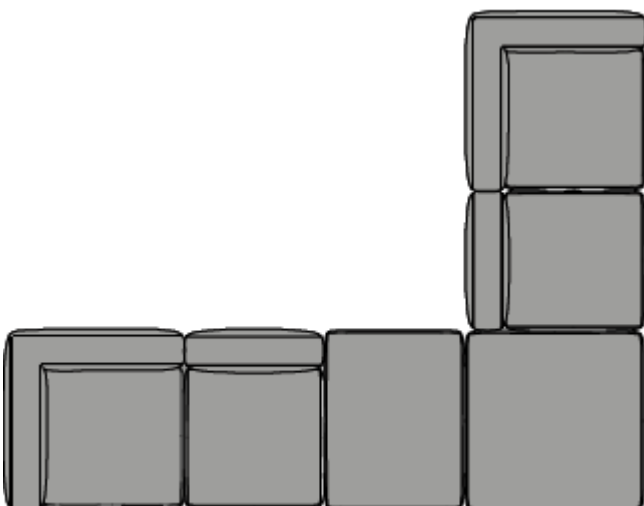

€	COM	COL	1	2	3	4	5	6	7	8	9	10	11	L1	L2	L3	L6
	6.214	6.380	6.578	6.742	6.870	7.086	7.306	7.542	7.798	8.058	8.316	8.576	8.832	9.062	9.990	11.716	16.400

Examples of modular configurations Ejemplos de combinaciones modulares

Set 35 / Conjunto 35

4 Modules 4 Módulos
SF0306 + SF0301 + SF0301 + SF0301

	COM cm. per unit	COL m2
1 units	1230	25
10 units or more	1160	

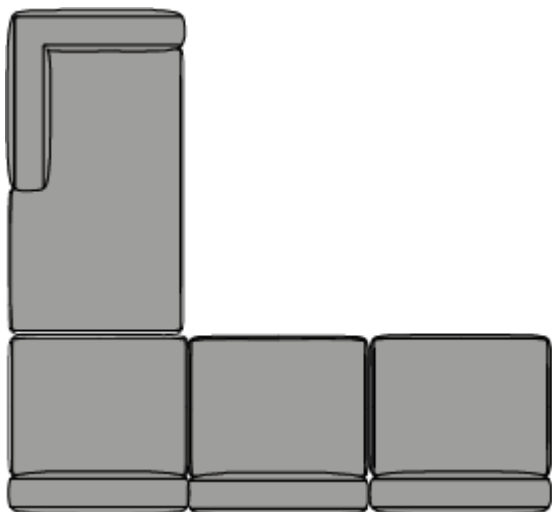

	COM	COL	1	2	3	4	5	6	7	8	9	10	11	L1	L2	L3	L6
€	5.290	5.424	5.585	5.719	5.825	5.998	6.179	6.383	6.618	6.863	7.097	7.338	7.572	7.783	8.641	10.237	14.474

Set 36 / Conjunto 36

4 Modules 4 Módulos
SF0306 + SF0301 + SF0300 + SF0300

	COM cm. per unit	COL m2
1 units	1230	25
10 units or more	1120	

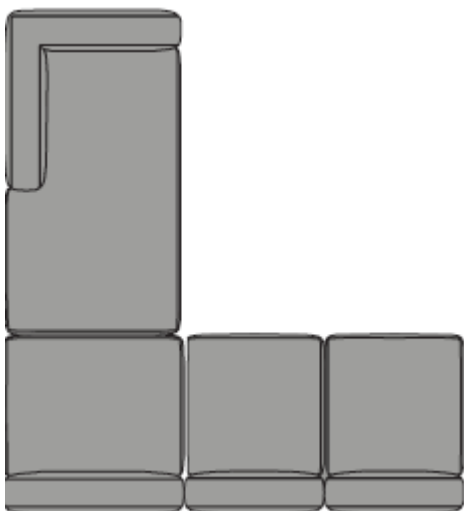

	COM	COL	1	2	3	4	5	6	7	8	9	10	11	L1	L2	L3	L6
€	4.988	5.112	5.261	5.385	5.481	5.644	5.809	5.981	6.164	6.355	6.537	6.722	6.906	7.077	7.799	9.133	12.698

Examples of modular configurations Ejemplos de combinaciones modulares

Set 37 / Conjunto 37

8 Modules 8 Módulos

BU0320 + BU0320 + BU0320 + BU0320 + BU0320 +
BU0320 + BU0320 + BU0320

	COM cm. per unit	COL m2
1 units	4240	84
10 units or more	4160	



	COM	COL	1	2	3	4	5	6	7	8	9	10	11	L1	L2	L3	L6
€	11.048	11.496	12.048	12.496	12.840	13.440	14.048	14.648	15.248	15.848	16.440	17.040	17.640	18.184	20.344	24.288	34.736

Set 38 / Conjunto 38

8 Modules 8 Módulos

SF0305 + SF0301 + SF0301 + SF0303 + SF0303 +
SF0301 + SF0301 + SF0305

	COM cm. per unit	COL m2
1 units	2760	56
10 units or more	2640	

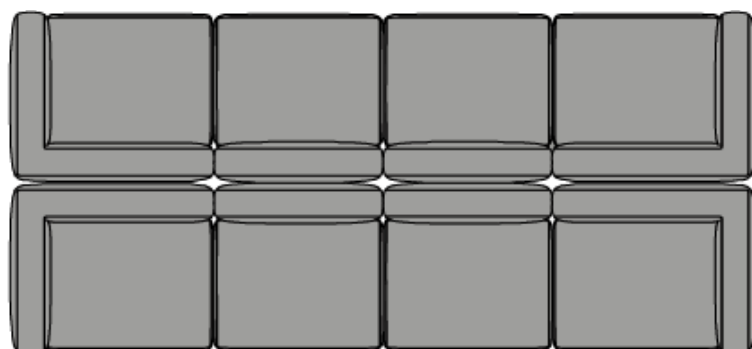

	COM	COL	1	2	3	4	5	6	7	8	9	10	11	L1	L2	L3	L6
€	10.320	10.616	10.968	11.256	11.488	11.872	12.260	12.684	13.148	13.624	14.084	14.560	15.024	15.436	17.124	20.212	28.360

Set 39 / Conjunto 39

8 Modules 8 Módulos

SF0304 + SF0300 + SF0300 + SF0302 + SF0302 +
SF0300 + SF0300 + SF0304

	COM cm. per unit	COL m2
1 units	2560	52
10 units or more	2360	

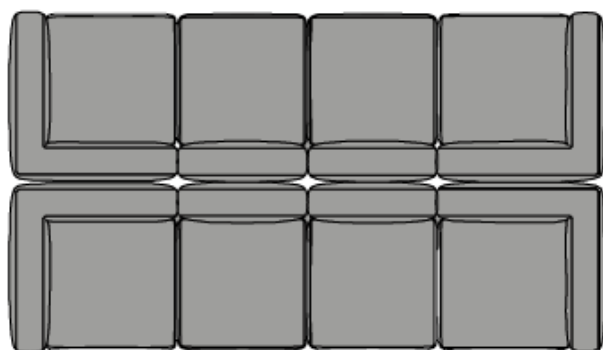

	COM	COL	1	2	3	4	5	6	7	8	9	10	11	L1	L2	L3	L6
€	9.024	9.260	9.548	9.784	9.964	10.280	10.592	10.908	11.220	11.536	11.852	12.164	12.480	12.776	14.016	16.316	22.532

Examples of modular configurations Ejemplos de combinaciones modulares

Set 40 / Conjunto 40

10 Modules 10 Módulos

SF0302 + SF0304 + SF0305 + SF0303 + SF0301 +
SF0301 + SF0303 + SF0305 + SF0304 + SF0302

	COM cm. per unit	COL m2
1 units	3700	75
10 units or more	3580	

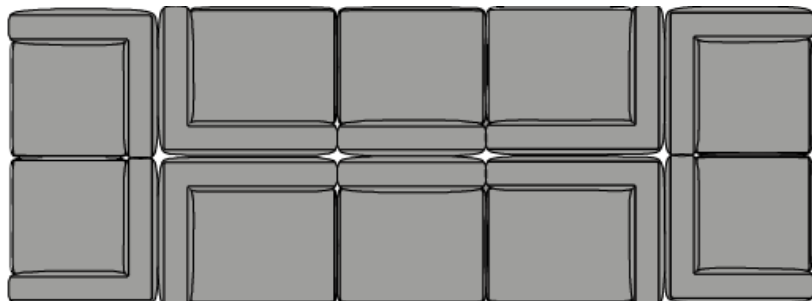

	COM	COL	1	2	3	4	5	6	7	8	9	10	11	L1	L2	L3	L6
€	12.220	12.586	13.028	13.386	13.668	14.154	14.634	15.138	15.658	16.180	16.700	17.228	17.748	18.212	20.092	23.580	32.916

Set 41 / Conjunto 41

10 Modules 10 Módulos

SF0302 + SF0304 + SF0304 + SF0302 + SF0300 +
SF0300 + SF0302 + SF0304 + SF0304 + SF0302

	COM cm. per unit	COL m2
1 units	3500	71
10 units or more	3340	

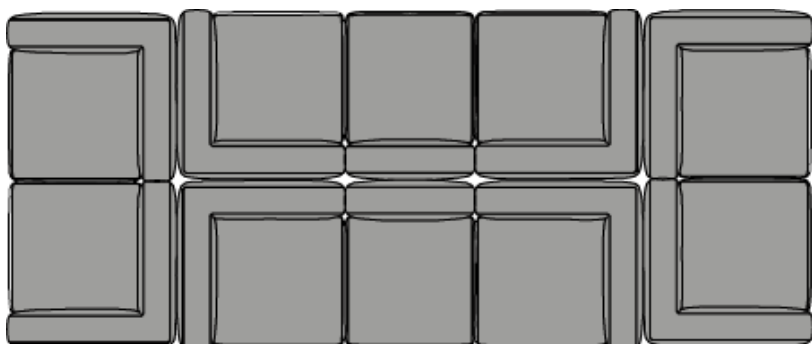

	COM	COL	1	2	3	4	5	6	7	8	9	10	11	L1	L2	L3	L6
€	11.226	11.542	11.932	12.248	12.488	12.916	13.336	13.764	14.184	14.600	15.028	15.448	15.870	16.258	17.826	20.788	28.864

Set 42 / Conjunto 42

6 Modules 6 Módulos

SF0302 + SF0304 + RS0311 + SF0301 + SF0305 +
SF0301

	COM cm. per unit	COL m2
1 units	1880	38,25
10 units or more	1800	

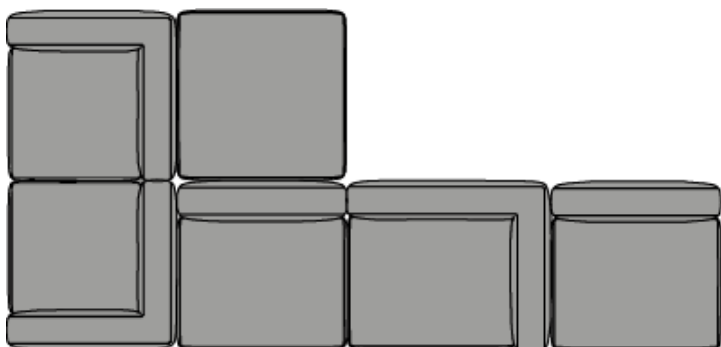

	COM	COL	1	2	3	4	5	6	7	8	9	10	11	L1	L2	L3	L6
€	6.806	6.996	7.224	7.411	7.558	7.807	8.058	8.327	8.615	8.907	9.196	9.489	9.777	10.035	11.079	13.016	18.223

Examples of modular configurations Ejemplos de combinaciones modulares

Set 43 / Conjunto 43

6 Modules 6 Módulos

SF0302 + SF0304 + RS0310 + SF0300 + SF0304 + SF0300

	COM cm. per unit	COL m2
1 units	1830	37,25
10 units or more	1690	

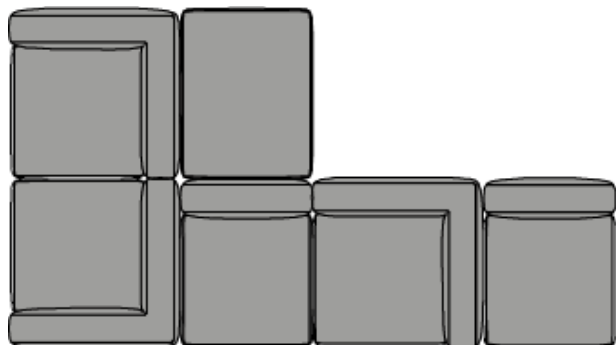

	COM	COL	1	2	3	4	5	6	7	8	9	10	11	L1	L2	L3	L6
€	6.299	6.465	6.670	6.838	6.964	7.188	7.410	7.634	7.855	8.077	8.301	8.522	8.745	8.953	9.814	11.427	15.791

Set 44 / Conjunto 44

4 Modules 4 Módulos

SF0303 + SF0305 + SF0305 + SF0303

	COM cm. per unit	COL m2
1 units	1680	34
10 units or more	1640	

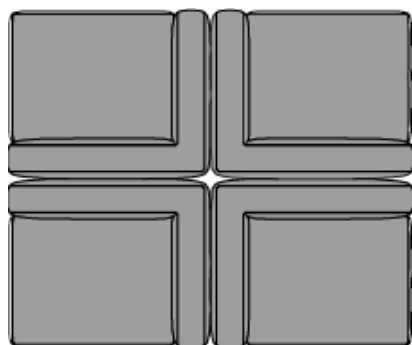

	COM	COL	1	2	3	4	5	6	7	8	9	10	11	L1	L2	L3	L6
€	5.168	5.340	5.544	5.708	5.840	6.068	6.288	6.512	6.736	6.960	7.180	7.408	7.632	7.828	8.636	10.108	14.008

Set 45 / Conjunto 45

4 Modules 4 Módulos

SF0304 + SF0304 + SF0302 + SF0302

	COM cm. per unit	COL m2
1 units	1480	30
10 units or more	1440	

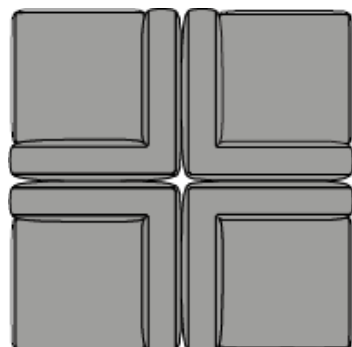

	COM	COL	1	2	3	4	5	6	7	8	9	10	11	L1	L2	L3	L6
€	4.476	4.608	4.772	4.904	5.004	5.184	5.360	5.540	5.716	5.888	6.068	6.244	6.420	6.580	7.212	8.420	11.732

Examples of modular configurations Ejemplos de combinaciones modulares

Set 46 / Conjunto 46

8 Modules 8 Módulos

SF0301 + SF0301 + SF0303 + SF0305 + SF0305 +
SF0303 + SF0301 + SF0301

	COM cm. per unit	COL m2
1 units	2760	56
10 units or more	2640	

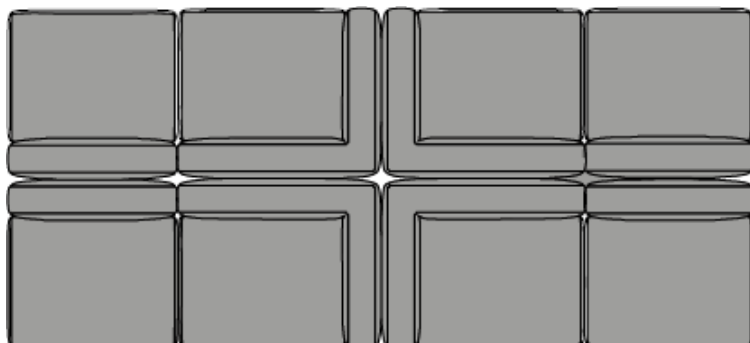

	COM	COL	1	2	3	4	5	6	7	8	9	10	11	L1	L2	L3	L6
€	10.320	10.616	10.968	11.256	11.488	11.872	12.260	12.684	13.148	13.624	14.084	14.560	15.024	15.436	17.124	20.212	28.360

Set 47 / Conjunto 47

8 Modules 8 Módulos

SF0300 + SF0300 + SF0304 + SF0304 + SF0302 +
SF0302 + SF0300 + SF0300

	COM cm. per unit	COL m2
1 units	2560	52
10 units or more	2360	

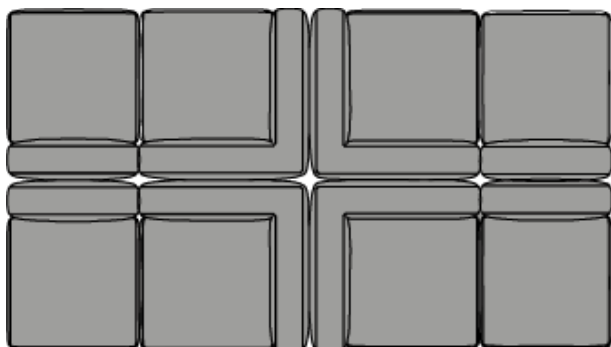

	COM	COL	1	2	3	4	5	6	7	8	9	10	11	L1	L2	L3	L6
€	9.024	9.260	9.548	9.784	9.964	10.280	10.592	10.908	11.220	11.536	11.852	12.164	12.480	12.776	14.016	16.316	22.532

Set 48 / Conjunto 48

10 Modules 10 Módulos

RS0311 + RS0311 + SF0301 + SF0301 + SF0301 +
SF0301 + SF0301 + SF0301 + RS0311 + RS0311

	COM cm. per unit	COL m2
1 units	2340	48
10 units or more	2180	

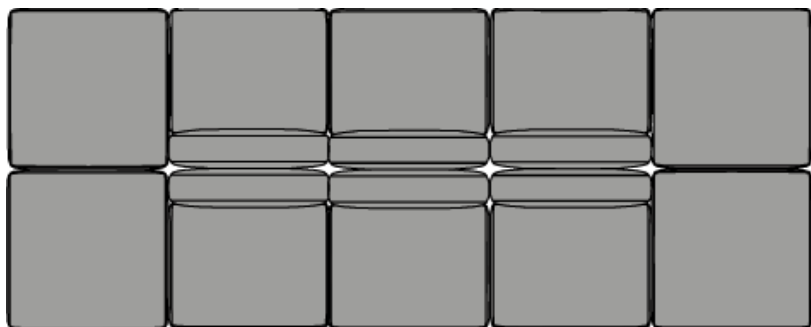

	COM	COL	1	2	3	4	5	6	7	8	9	10	11	L1	L2	L3	L6
€	10.528	10.790	11.096	11.354	11.560	11.890	12.238	12.630	13.086	13.560	14.016	14.484	14.940	15.348	17.012	20.064	28.244

Examples of modular configurations
Ejemplos de combinaciones modulares

Set 49 / Conjunto 49

10 Modules 10 Módulos

RS0310 + RS0310 + SF0300 + SF0300 + SF0300 + SF0300 + SF0300 + RS0310 + RS0310

	COM cm. per unit	COL m2
1 units	2340	48
10 units or more	1980	

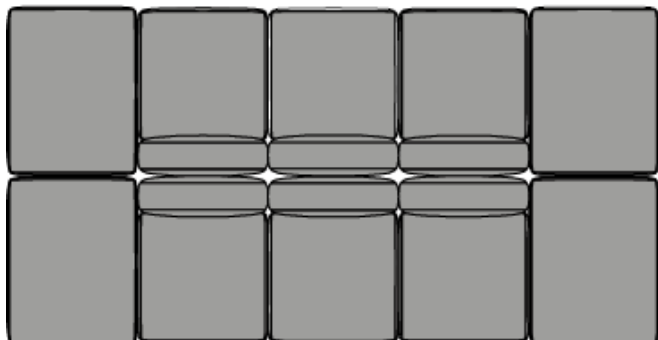

	COM	COL	1	2	3	4	5	6	7	8	9	10	11	L1	L2	L3	L6
€	9.494	9.710	9.976	10.200	10.364	10.652	10.944	11.232	11.520	11.820	12.108	12.396	12.690	12.974	14.218	16.500	22.568

Set 50 / Conjunto 50

8 Modules 8 Módulos

RS0311 + SF0302 + RS0311 + SF0301 + RS0311 + SF0301 + RS0311 + RS0311

	COM cm. per unit	COL m2
1 units	1810	37,25
10 units or more	1710	

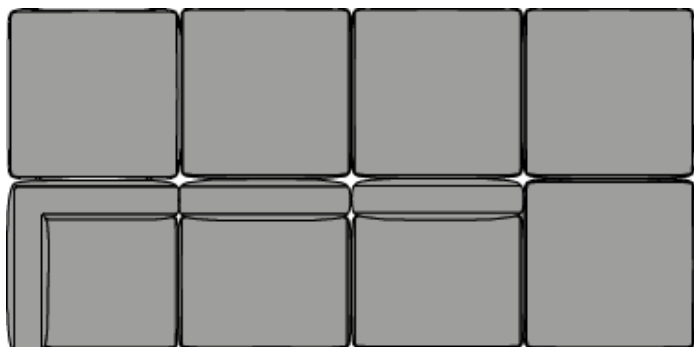

	COM	COL	1	2	3	4	5	6	7	8	9	10	11	L1	L2	L3	L6
€	7.195	7.385	7.605	7.790	7.935	8.178	8.426	8.686	8.970	9.259	9.544	9.832	10.116	10.369	11.397	13.292	18.504

Set 51 / Conjunto 51

8 Modules 8 Módulos

RS0311 + SF0302 + RS0310 + SF0300 + RS0310 + SF0300 + RS0310 + RS0310

	COM cm. per unit	COL m2
1 units	1810	37,25
10 units or more	1590	

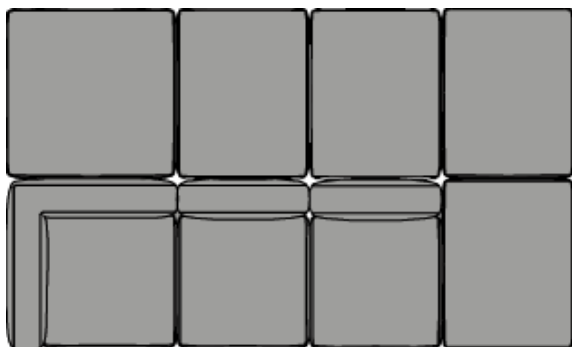

	COM	COL	1	2	3	4	5	6	7	8	9	10	11	L1	L2	L3	L6
€	6.765	6.929	7.133	7.304	7.427	7.648	7.872	8.092	8.312	8.535	8.756	8.976	9.198	9.407	10.287	11.936	16.380

Examples of modular configurations Ejemplos de combinaciones modulares

Set 52 / Conjunto 52

4 Modules 4 Módulos

RS0311 + RS0311 + RS0311 + RS0311

	COM cm. per unit	COL m2
1 units	720	15
10 units or more	680	

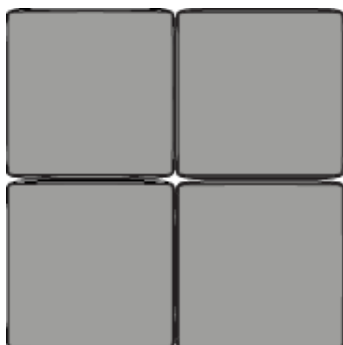

€	COM	COL	1	2	3	4	5	6	7	8	9	10	11	L1	L2	L3	L6
	2.800	2.876	2.960	3.032	3.088	3.184	3.280	3.372	3.468	3.564	3.660	3.756	3.852	3.936	4.280	4.908	6.716

Set 53 / Conjunto 53

6 Modules 6 Módulos

RS0311 + RS0311 + RS0311 + RS0311 + RS0311 + RS0311

	COM cm. per unit	COL m2
1 units	1080	22,5
10 units or more	1020	



€	COM	COL	1	2	3	4	5	6	7	8	9	10	11	L1	L2	L3	L6
	4.200	4.314	4.440	4.548	4.632	4.776	4.920	5.058	5.202	5.346	5.490	5.634	5.778	5.904	6.420	7.362	10.074

Set 54 / Conjunto 54

4 Modules 4 Módulos

RS0313 + RS0313 + RS0313 + RS0313

	COM cm. per unit	COL m2
1 units	600	12
10 units or more	560	



€	COM	COL	1	2	3	4	5	6	7	8	9	10	11	L1	L2	L3	L6
	2.176	2.232	2.296	2.356	2.400	2.472	2.548	2.624	2.696	2.772	2.852	2.924	3.000	3.064	3.336	3.828	5.136

Examples of modular configurations Ejemplos de combinaciones modulares

Set 55 / Conjunto 55

6 Modules 6 Módulos

RS0313 + RS0313 + RS0313 + RS0313 + RS0313 + RS0313



	COM cm. per unit	COL m2
1 units	900	18
10 units or more	840	

€	COM	COL	1	2	3	4	5	6	7	8	9	10	11	L1	L2	L3	L6
	3.264	3.348	3.444	3.534	3.600	3.708	3.822	3.936	4.044	4.158	4.278	4.386	4.500	4.596	5.004	5.742	7.704

Set 56 / Conjunto 56

2 Modules 2 Módulos

RS0314 + RS0314

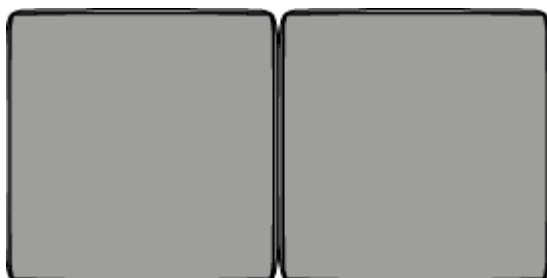

	COM cm. per unit	COL m2
1 units	760	15,5
10 units or more	600	

€	COM	COL	1	2	3	4	5	6	7	8	9	10	11	L1	L2	L3	L6
	1.812	1.868	1.940	1.998	2.042	2.120	2.198	2.274	2.350	2.428	2.504	2.580	2.656	2.726	3.002	3.508	4.844

Set 57 / Conjunto 57

3 Modules 3 Módulos

RS0314 + RS0314 + RS0314

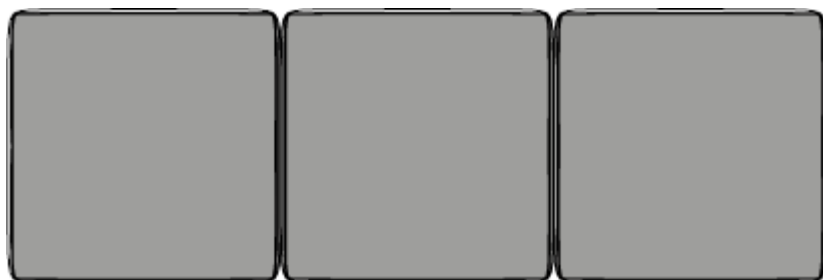

	COM cm. per unit	COL m2
1 units	1140	23,25
10 units or more	900	

€	COM	COL	1	2	3	4	5	6	7	8	9	10	11	L1	L2	L3	L6
	2.718	2.802	2.910	2.997	3.063	3.180	3.297	3.411	3.525	3.642	3.756	3.870	3.984	4.089	4.503	5.262	7.266

Examples of modular configurations Ejemplos de combinaciones modulares

Set 58 / Conjunto 58

2 Modules 2 Módulos
RS0312 + RS0312

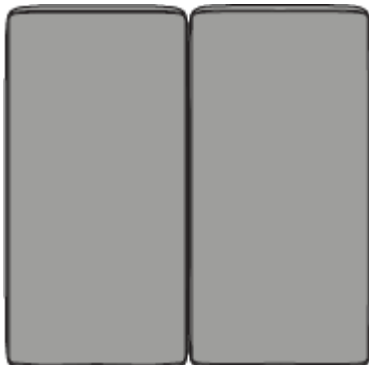

	COM cm. per unit	COL m2
1 units	660	13
10 units or more	580	

€	COM	COL	1	2	3	4	5	6	7	8	9	10	11	L1	L2	L3	L6
	1.810	1.870	1.940	2.000	2.046	2.122	2.212	2.310	2.404	2.506	2.600	2.698	2.798	2.886	3.234	3.880	5.602

Set 59 / Conjunto 59

2 Modules 2 Módulos
RS0312 + RS0312



	COM cm. per unit	COL m2
1 units	660	13
10 units or more	580	

€	COM	COL	1	2	3	4	5	6	7	8	9	10	11	L1	L2	L3	L6
	1.810	1.870	1.940	2.000	2.046	2.122	2.212	2.310	2.404	2.506	2.600	2.698	2.798	2.886	3.234	3.880	5.602

Set 60 / Conjunto 60

10 Modules 10 Módulos
SF0301 + SF0301 + SF0304 + SF0301 + SF0301 +
SF0301 + SF0301 + SF0302 + SF0301 + SF0301

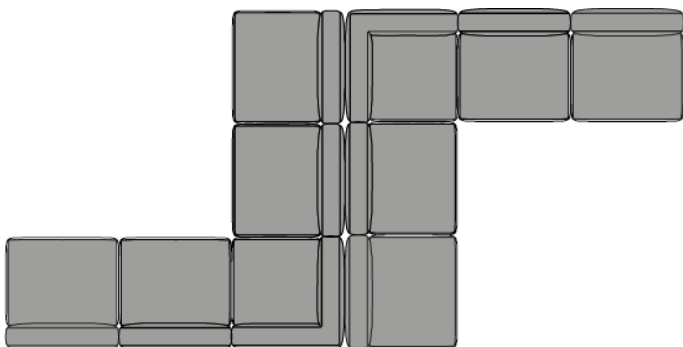

	COM cm. per unit	COL m2
1 units	2900	59
10 units or more	2720	

€	COM	COL	1	2	3	4	5	6	7	8	9	10	11	L1	L2	L3	L6
	12.542	12.856	13.234	13.548	13.798	14.200	14.624	15.114	15.682	16.272	16.842	17.426	17.994	18.506	20.582	24.418	34.570

Examples of modular configurations Ejemplos de combinaciones modulares

Set 61 / Conjunto 61

10 Modules 10 Módulos

SF0301 + SF0301 + SF0304 + SF0301 + SF0301 +
SF0301 + SF0301 + SF0302 + SF0301 + SF0301

	COM cm. per unit	COL m2
1 units	2900	59
10 units or more	2720	

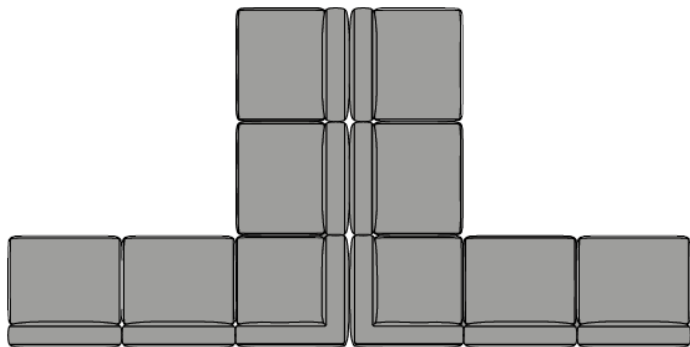

€	COM	COL	1	2	3	4	5	6	7	8	9	10	11	L1	L2	L3	L6
€	12.542	12.856	13.234	13.548	13.798	14.200	14.624	15.114	15.682	16.272	16.842	17.426	17.994	18.506	20.582	24.418	34.570

Set 62 / Conjunto 62

10 Modules 10 Módulos

SF0300 + SF0300 + SF0304 + SF0300 + SF0300 +
SF0300 + SF0300 + SF0302 + SF0300 + SF0300

	COM cm. per unit	COL m2
1 units	2900	59
10 units or more	2560	



€	COM	COL	1	2	3	4	5	6	7	8	9	10	11	L1	L2	L3	L6
€	11.334	11.608	11.938	12.212	12.422	12.784	13.144	13.506	13.866	14.240	14.602	14.962	15.330	15.682	17.214	20.002	27.466

Set 63 / Conjunto 63

5 Modules 5 Módulos

SF0363 + SF0301 + SF0361 + SF0301 + SF0362

	COM cm. per unit	COL m2
1 units	1740	35
10 units or more	1650	

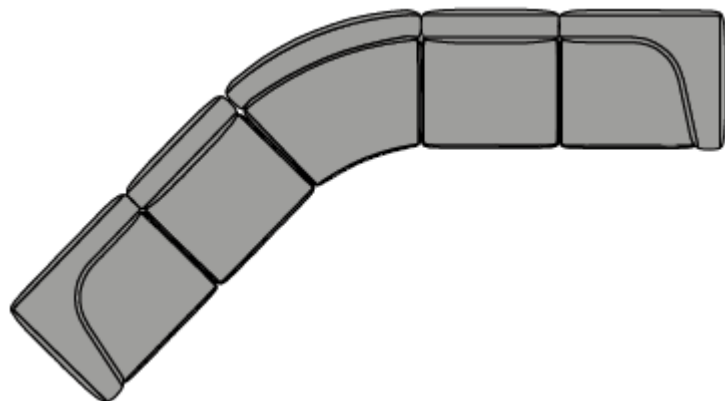

€	COM	COL	1	2	3	4	5	6	7	8	9	10	11	L1	L2	L3	L6
€	7.485	7.679	7.911	8.102	8.253	8.505	8.761	9.046	9.352	9.663	9.973	10.282	10.588	10.864	11.975	14.012	19.472

Examples of modular configurations
Ejemplos de combinaciones modulares

Set 64 / Conjunto 64

6 Modules 6 Módulos
SF0363 + SF0301 + SF0361 + SF0361 + SF0301 + SF0362

	COM cm. per unit	COL m2
1 units	2160	43,5
10 units or more	2040	

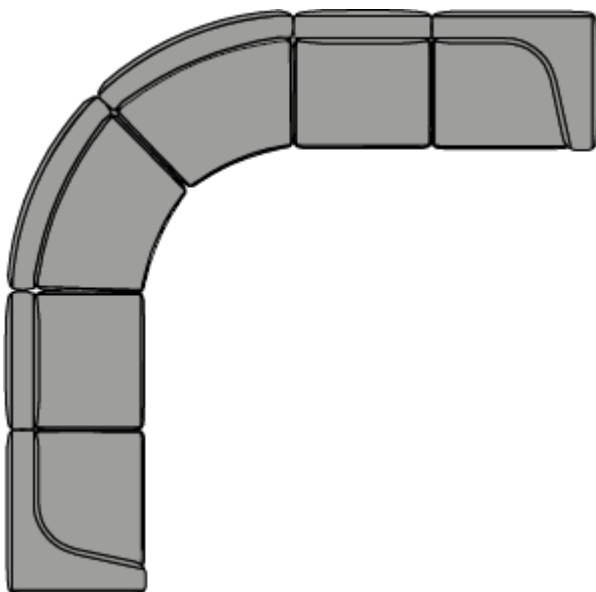

	COM	COL	1	2	3	4	5	6	7	8	9	10	11	L1	L2	L3	L6
€	8.928	9.166	9.450	9.684	9.868	10.178	10.492	10.846	11.222	11.604	11.986	12.364	12.742	13.082	14.448	16.952	23.646

Set 65 / Conjunto 65

7 Modules 7 Módulos
RS0365 + SF0301 + SF0301 + SF0360 + SF0301 + SF0301 + RS0365

	COM cm. per unit	COL m2
1 units	1720	35,25
10 units or more	1560	

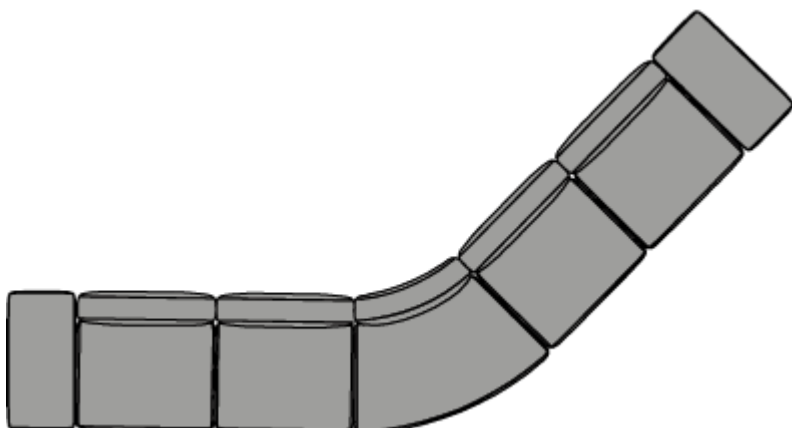

	COM	COL	1	2	3	4	5	6	7	8	9	10	11	L1	L2	L3	L6
€	7.856	8.044	8.272	8.461	8.611	8.855	9.108	9.397	9.723	10.060	10.387	10.722	11.062	11.363	12.600	14.861	20.814

Examples of modular configurations
Ejemplos de combinaciones modulares

Set 66 / Conjunto 66

7 Modules 7 Módulos

SF0363 + SF0300 + SF0361 + SF0300 + SF0360 +
SF0300 + SF0362

	COM cm. per unit	COL m2
1 units	2370	47,75
10 units or more	2160	

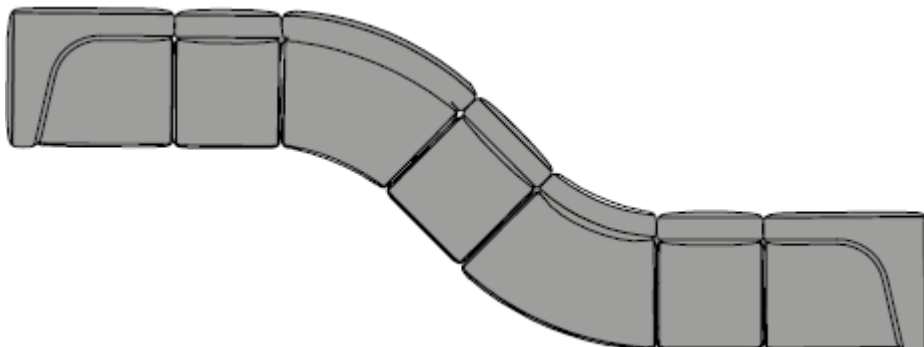

	COM	COL	1	2	3	4	5	6	7	8	9	10	11	L1	L2	L3	L6
€	9.834	10.080	10.377	10.621	10.810	11.136	11.459	11.795	12.133	12.475	12.816	13.154	13.505	13.830	15.178	17.625	24.196

Set 67 / Conjunto 67

8 Modules 8 Módulos

SF0363 + SF0301 + SF0361 + SF0301 + SF0301 +
SF0361 + SF0301 + SF0362

	COM cm. per unit	COL m2
1 units	2700	54,5
10 units or more	2540	

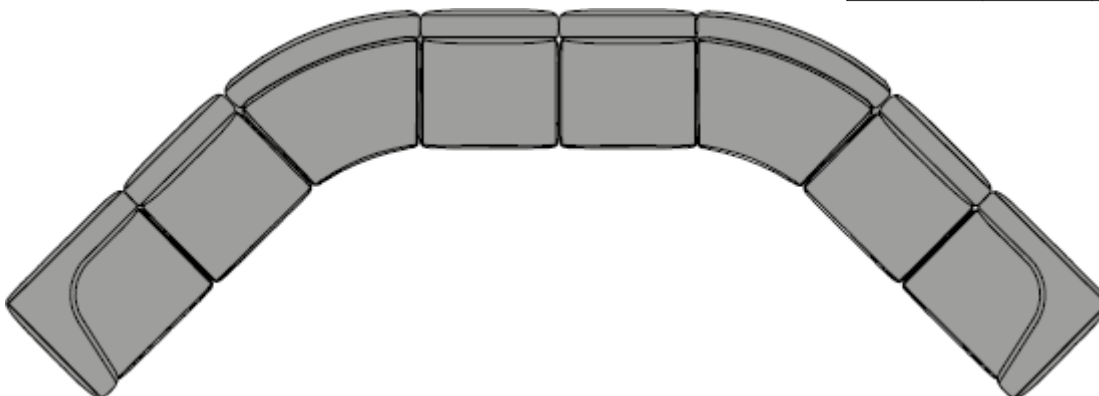

	COM	COL	1	2	3	4	5	6	7	8	9	10	11	L1	L2	L3	L6
€	11.504	11.804	12.162	12.458	12.692	13.080	13.478	13.932	14.428	14.936	15.438	15.940	16.438	16.886	18.692	22.004	30.822

Examples of modular configurations
Ejemplos de combinaciones modulares

Set 68 / Conjunto 68

10 Modules 10 Módulos

RS0366 + SF0363 + RS0370 + SF0361 + RS0370 +
SF0361 + RS0365 + SF0301 + RS0365 + SF0301

	COM cm. per unit	COL m2
1 units	2630	55
10 units or more	2400	

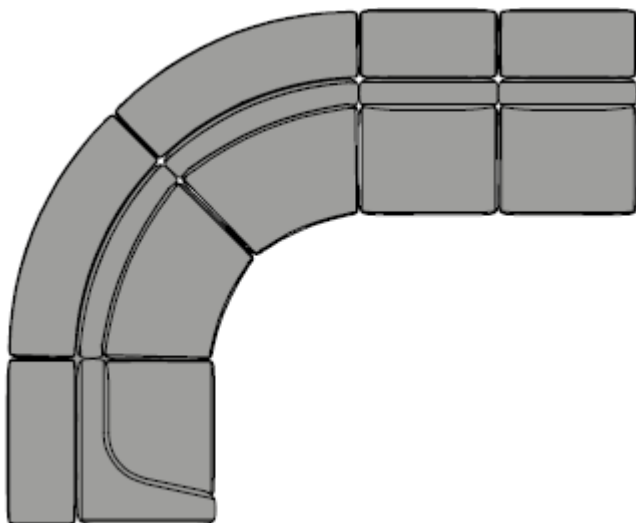

	COM	COL	1	2	3	4	5	6	7	8	9	10	11	L1	L2	L3	L6
€	10.610	10.883	11.213	11.486	11.699	12.059	12.425	12.829	13.252	13.689	14.129	14.569	15.008	15.396	16.975	19.871	27.566

Set 69 / Conjunto 69

6 Modules 6 Módulos

RS0365 + SF0361 + SF0361 + SF0360 + SF0360 +
SF0363

	COM cm. per unit	COL m2
1 units	2090	42,25
10 units or more	1920	

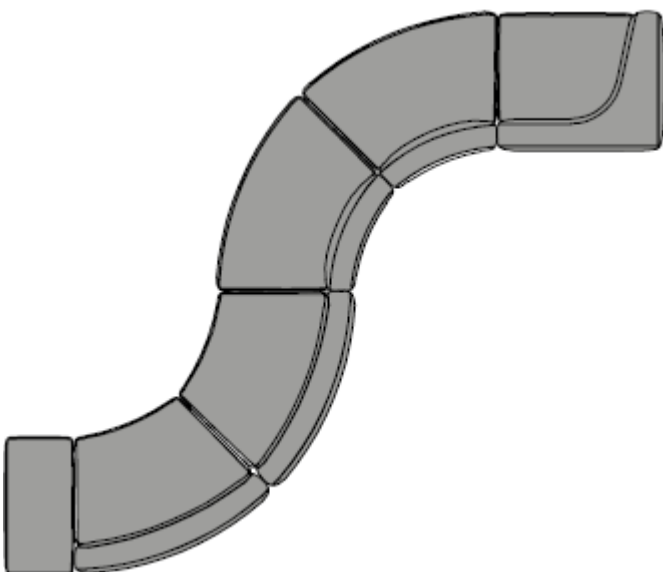

	COM	COL	1	2	3	4	5	6	7	8	9	10	11	L1	L2	L3	L6
€	8.242	8.460	8.726	8.943	9.110	9.403	9.692	10.006	10.322	10.637	10.957	11.273	11.614	11.919	13.147	15.383	21.340

Examples of modular configurations
Ejemplos de combinaciones modulares

Set 70 / Conjunto 70

11 Modules 11 Módulos

SF0301 + RS0365 + SF0301 + RS0365 + SF0360 +
RS0369 + SF0360 + RS0369 + SF0301 + RS0367 +
RS0365

	COM cm. per unit	COL m2
1 units	2350	48,25
10 units or more	2090	

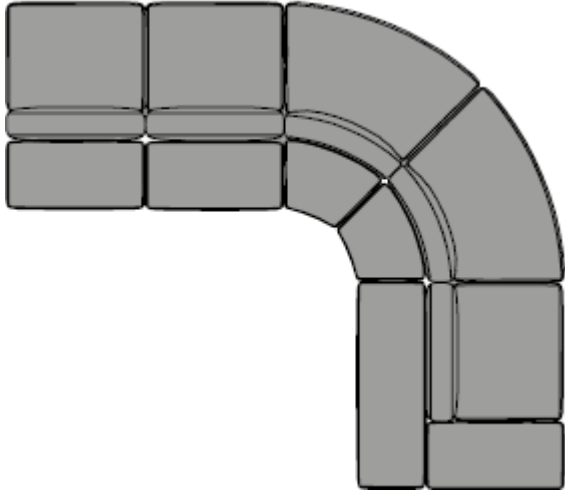

	COM	COL	1	2	3	4	5	6	7	8	9	10	11	L1	L2	L3	L6
€	10.570	10.818	11.122	11.375	11.571	11.901	12.236	12.600	12.988	13.387	13.776	14.176	14.591	14.957	16.466	19.214	26.461

Set 71 / Conjunto 71

4 Modules 4 Módulos

RS0366 + RS0370 + RS0370 + RS0366

	COM cm. per unit	COL m2
1 units	740	16,5
10 units or more	640	

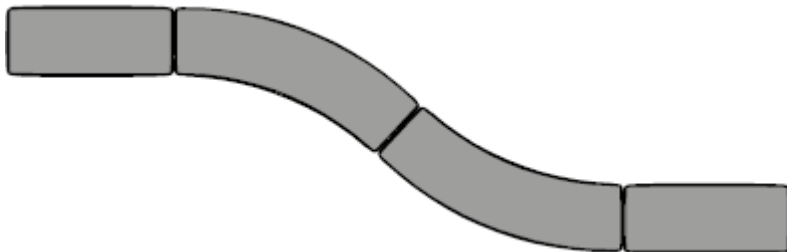

	COM	COL	1	2	3	4	5	6	7	8	9	10	11	L1	L2	L3	L6
€	2.886	2.952	3.036	3.106	3.158	3.250	3.344	3.432	3.522	3.618	3.718	3.824	3.922	4.010	4.370	5.034	6.818

**Examples of modular configurations
Ejemplos de combinaciones modulares**

Set 72 / Conjunto 72

3 Modules 3 Módulos
RS0370 + RS0370 + RS0370

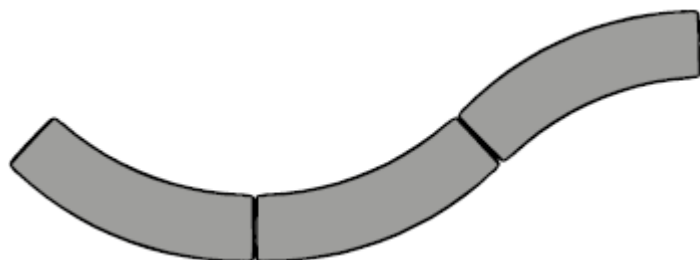

	COM cm. per unit	COL m2
1 units	630	15
10 units or more	540	

	COM	COL	1	2	3	4	5	6	7	8	9	10	11	L1	L2	L3	L6
€	2.346	2.400	2.469	2.526	2.571	2.643	2.721	2.793	2.865	2.949	3.036	3.129	3.216	3.294	3.609	4.194	5.730

Set 73 / Conjunto 73

10 Modules 10 Módulos
RS0368 + RS0369 + RS0369 + RS0369 + RS0369 +
RS0368 + RS0369 + RS0369 + RS0369 + RS0369

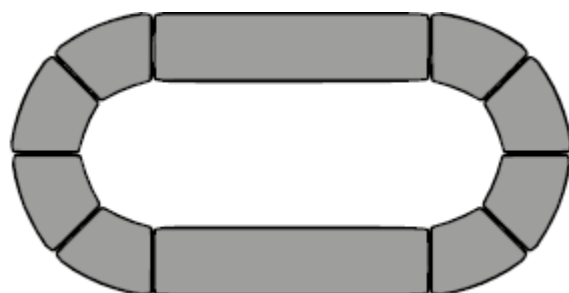

	COM cm. per unit	COL m2
1 units	1320	27
10 units or more	1140	

	COM	COL	1	2	3	4	5	6	7	8	9	10	11	L1	L2	L3	L6
€	6.208	6.348	6.514	6.662	6.772	6.958	7.146	7.336	7.514	7.710	7.890	8.086	8.268	8.434	9.114	10.346	13.634

Set 74 / Conjunto 74

10 Modules 10 Módulos
RS0368 + SF0301 + SF0363 + SF0362 + SF0301 +
RS0368 + SF0301 + SF0363 + SF0362 + SF0301

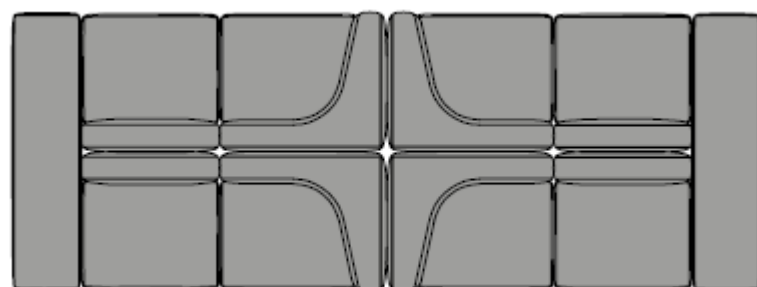

	COM cm. per unit	COL m2
1 units	3080	62
10 units or more	2940	

	COM	COL	1	2	3	4	5	6	7	8	9	10	11	L1	L2	L3	L6
€	13.556	13.900	14.314	14.654	14.928	15.374	15.830	16.324	16.854	17.394	17.930	18.470	19.000	19.478	21.406	24.938	34.454

Examples of modular configurations Ejemplos de combinaciones modulares

Set 75 / Conjunto 75

8 Modules 8 Módulos

RS0367 + RS0368 + RS0368 + RS0367 + SF0301 +
SF0301 + SF0301 + SF0301

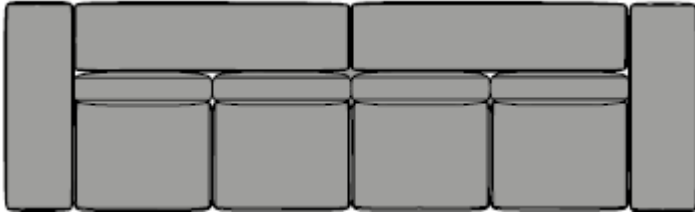

	COM cm. per unit	COL m2
1 units	1880	38,5
10 units or more	1740	

€	COM	COL	1	2	3	4	5	6	7	8	9	10	11	L1	L2	L3	L6
	8.042	8.244	8.490	8.694	8.860	9.122	9.400	9.710	10.056	10.416	10.764	11.120	11.472	11.784	13.054	15.380	21.530

Set 76 / Conjunto 76

8 Modules 8 Módulos

RS0366 + RS0365 + RS0365 + RS0366 + SF0363 +
SF0301 + SF0301 + SF0362

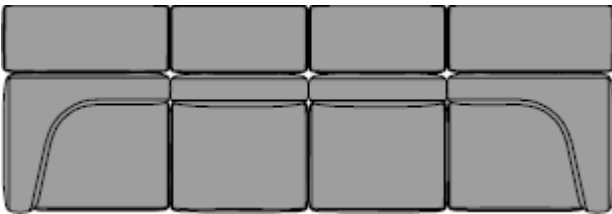

	COM cm. per unit	COL m2
1 units	1920	39
10 units or more	1780	

€	COM	COL	1	2	3	4	5	6	7	8	9	10	11	L1	L2	L3	L6
	8.554	8.762	9.014	9.222	9.384	9.660	9.936	10.232	10.546	10.862	11.180	11.500	11.814	12.092	13.234	15.324	20.958

Set 77 / Conjunto 77

10 Modules 10 Módulos

RS0365 + SF0301 + SF0301 + SF0301 + RS0311 +
RS0311 + SF0301 + SF0301 + SF0301 + RS0365



	COM cm. per unit	COL m2
1 units	2260	46,5
10 units or more	2080	

€	COM	COL	1	2	3	4	5	6	7	8	9	10	11	L1	L2	L3	L6
	10.318	10.570	10.868	11.118	11.318	11.638	11.974	12.360	12.804	13.266	13.712	14.168	14.616	15.012	16.640	19.624	27.548

Examples of modular configurations Ejemplos de combinaciones modulares

Set 78 / Conjunto 78

8 Modules 8 Módulos

RS0365 + SF0362 + SF0303 + RS0365 + RS0365 +
SF0362 + SF0303 + RS0365

	COM cm. per unit	COL m2
1 units	2180	44,5
10 units or more	2060	

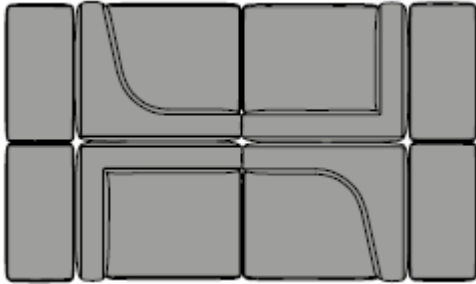

	COM	COL	1	2	3	4	5	6	7	8	9	10	11	L1	L2	L3	L6
€	8.430	8.660	8.936	9.160	9.338	9.644	9.940	10.248	10.548	10.846	11.150	11.452	11.758	12.020	13.112	15.102	20.450

Set 79 / Conjunto 79

4 Modules 4 Módulos

RS0368 + RS0368 + RS0368 + RS0368

	COM cm. per unit	COL m2
1 units	880	18
10 units or more	840	



	COM	COL	1	2	3	4	5	6	7	8	9	10	11	L1	L2	L3	L6
€	2.944	3.032	3.140	3.228	3.304	3.420	3.540	3.664	3.780	3.900	4.020	4.140	4.264	4.372	4.804	5.588	7.716

Set 80 / Conjunto 80

6 Modules 6 Módulos

RS0365 + RS0368 + RS0368 + RS0365 + RS0368 +
RS0368

	COM cm. per unit	COL m2
1 units	1160	24
10 units or more	1080	



	COM	COL	1	2	3	4	5	6	7	8	9	10	11	L1	L2	L3	L6
€	4.134	4.250	4.392	4.508	4.606	4.760	4.916	5.080	5.232	5.388	5.546	5.702	5.866	6.004	6.572	7.602	10.378

**Examples of modular configurations
Ejemplos de combinaciones modulares**

Set 81 / Conjunto 81

3 Modules 3 Módulos
RS0368 + RS0368 + RS0368

	COM cm. per unit	COL m2
1 units	660	13,5
10 units or more	630	



	COM	COL	1	2	3	4	5	6	7	8	9	10	11	L1	L2	L3	L6
€	2.208	2.274	2.355	2.421	2.478	2.565	2.655	2.748	2.835	2.925	3.015	3.105	3.198	3.279	3.603	4.191	5.787

Set 82 / Conjunto 82

12 Modules 12 Módulos
SF0361 + SF0361 + SF0361 + SF0360 + SF0360 +
SF0360 + SF0361 + SF0361 + SF0361 + SF0360 +
SF0360 + SF0360

	COM cm. per unit	COL m2
1 units	4680	94,5
10 units or more	4260	

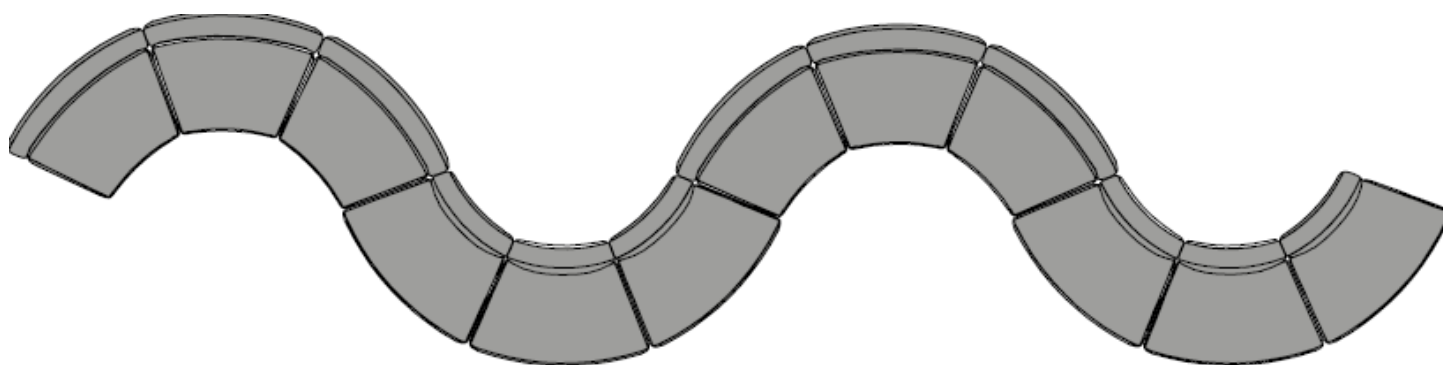

	COM	COL	1	2	3	4	5	6	7	8	9	10	11	L1	L2	L3	L6
€	17.742	18.222	18.810	19.290	19.656	20.304	20.946	21.654	22.374	23.094	23.820	24.540	25.332	26.046	28.902	34.098	47.844

Examples of modular configurations
Ejemplos de combinaciones modulares

Set 83 / Conjunto 83

15 Modules 15 Módulos

SF0301 + SF0360 + SF0360 + SF0301 + SF0301 +
SF0360 + SF0360 + SF0301 + SF0360 + SF0360 +
SF0301 + SF0301 + SF0360 + SF0360 + SET82

	COM cm. per unit	COL m2
1 units	4500	91
10 units or more	4060	

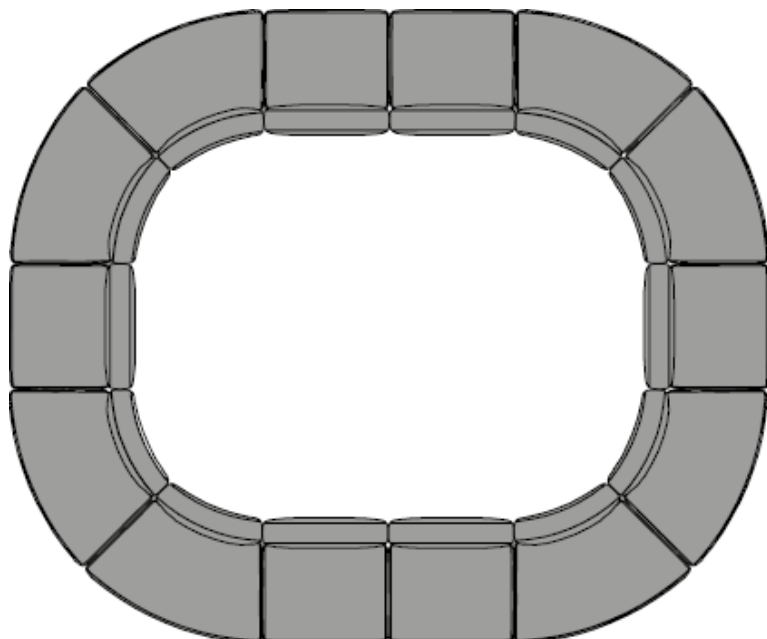

	COM	COL	1	2	3	4	5	6	7	8	9	10	11	L1	L2	L3	L6
€	19.840	20.314	20.904	21.386	21.760	22.394	23.038	23.730	24.490	25.260	26.012	26.792	27.632	28.396	31.484	37.100	51.928

Set 84 / Conjunto 84

8 Modules 8 Módulos

SF0360 + SF0360 + SF0360 + SF0360 + SF0360 +
SF0360 + SF0360 + SF0360

	COM cm. per unit	COL m2
1 units	2880	58
10 units or more	2560	

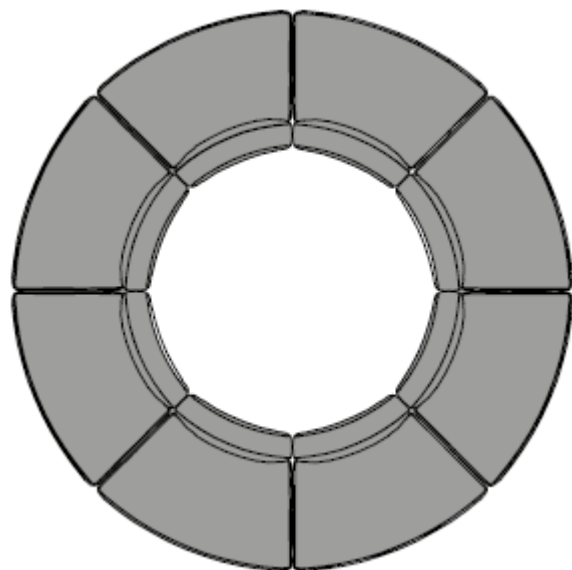

	COM	COL	1	2	3	4	5	6	7	8	9	10	11	L1	L2	L3	L6
€	12.112	12.400	12.768	13.064	13.288	13.688	14.080	14.472	14.872	15.264	15.656	16.064	16.544	16.984	18.752	21.944	30.400

Examples of modular configurations
Ejemplos de combinaciones modulares

Set 85 / Conjunto 85

8 Modules 8 Módulos

RS0370 + RS0370 + RS0370 + RS0370 + RS0370 +
RS0370 + RS0370 + RS0370

	COM cm. per unit	COL m2
1 units	1680	40
10 units or more	1440	

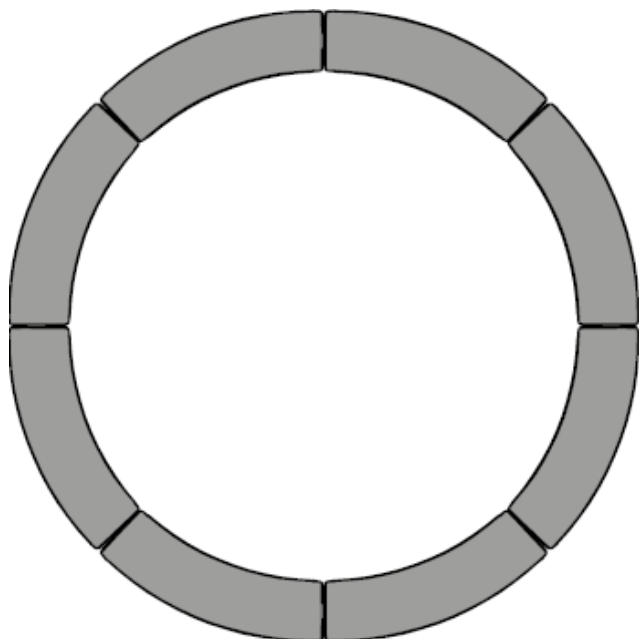

	COM	COL	1	2	3	4	5	6	7	8	9	10	11	L1	L2	L3	L6
€	6.256	6.400	6.584	6.736	6.856	7.048	7.256	7.448	7.640	7.864	8.096	8.344	8.576	8.784	9.624	11.184	15.280

Set 86 / Conjunto 86

12 Modules 12 Módulos

SF0363 + SF0301 + SF0301 + SF0361 + SF0361 +
SF0301 + SF0301 + SF0361 + SF0361 + SF0301 +
SF0301 + SF0362

	COM cm. per unit	COL m2
1 units	4080	82,5
10 units or more	3820	

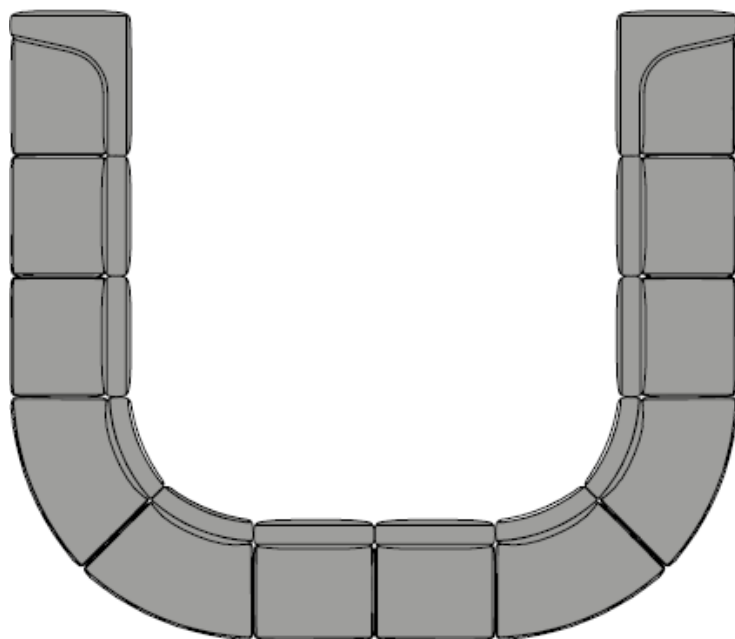

	COM	COL	1	2	3	4	5	6	7	8	9	10	11	L1	L2	L3	L6
€	16.966	17.416	17.952	18.396	18.746	19.328	19.926	20.618	21.374	22.150	22.916	23.680	24.442	25.126	27.882	32.936	46.346

Examples of modular configurations
Ejemplos de combinaciones modulares

Set 87 / Conjunto 87

13 Modules 13 Módulos

SF0301 + SF0361 + SF0301 + SF0361 + SF0301 +
SF0361 + SF0301 + SF0361 + SF0301 + SF0361 +
SF0301 + SF0361 + SF0301

	COM cm. per unit	COL m2
1 units	4410	89,5
10 units or more	4090	

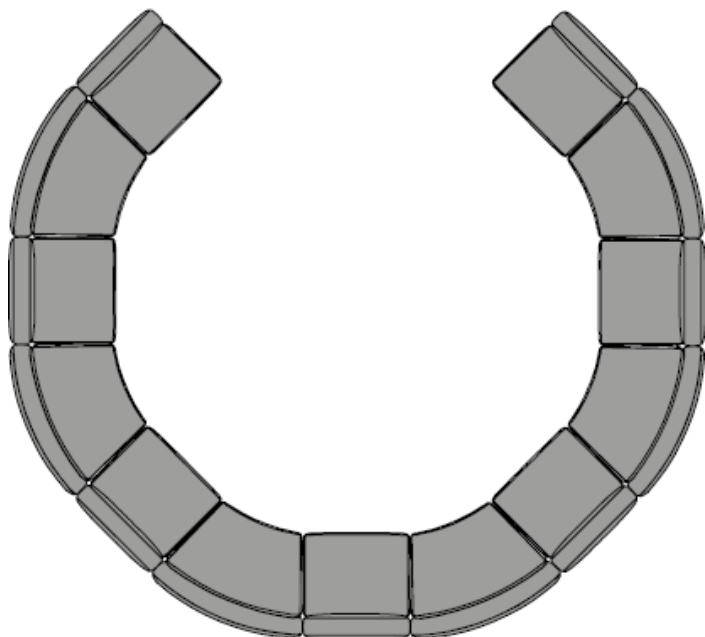

	COM	COL	1	2	3	4	5	6	7	8	9	10	11	L1	L2	L3	L6
€	17.674	18.155	18.726	19.201	19.574	20.195	20.837	21.601	22.441	23.308	24.160	25.008	25.860	26.622	29.692	35.322	50.160

Set 88 / Conjunto 88

27 Modules 27 Módulos

RS0366 + RS0365 + RS0365 + RS0370 + RS0370 + RS0365 + RS0365 +
RS0370 + RS0370 + RS0365 + RS0365 + RS0366 + SF0362 + SF0301 +
SF0301 + SF0361 + SF0361 + SF0301 + SF0301 + SF0361 + SF0361 +
SF0301 + SF0301 + SF0363 + RS0311 + RS0311 + RS0311

	COM cm. per unit	COL m2
1 units	6620	138,25
10 units or more	6050	

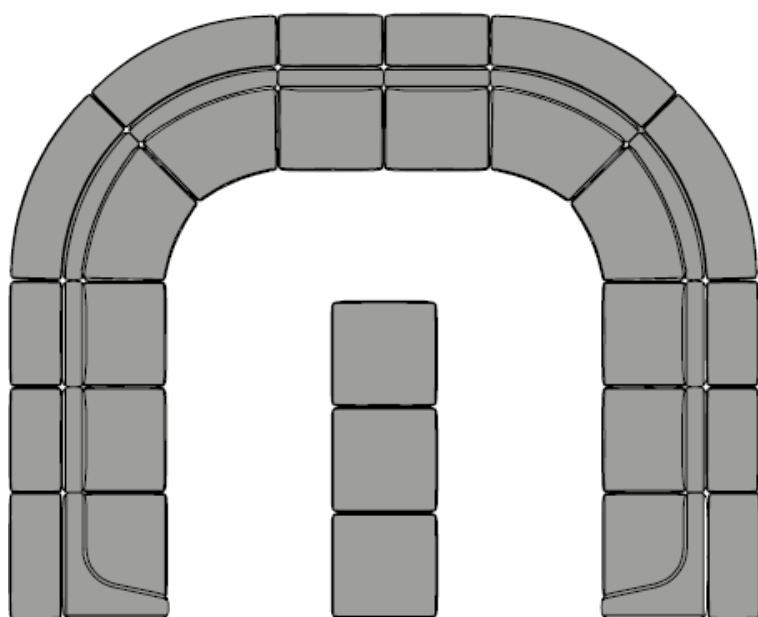

	COM	COL	1	2	3	4	5	6	7	8	9	10	11	L1	L2	L3	L6
€	27.086	27.779	28.610	29.300	29.840	30.748	31.672	32.689	33.763	34.871	35.981	37.093	38.203	39.180	43.172	50.489	70.007

Examples of modular configurations
Ejemplos de combinaciones modulares

Set 89 / Conjunto 89

14 Modules 14 Módulos

SF0363 + SF0301 + SF0301 + SF0360 + SF0360 +
SF0360 + SF0301 + SF0301 + SF0361 + SF0361 +
SF0361 + SF0301 + SF0301 + SF0362

	COM cm. per unit	COL m2
1 units	4740	95,75
10 units or more	4390	

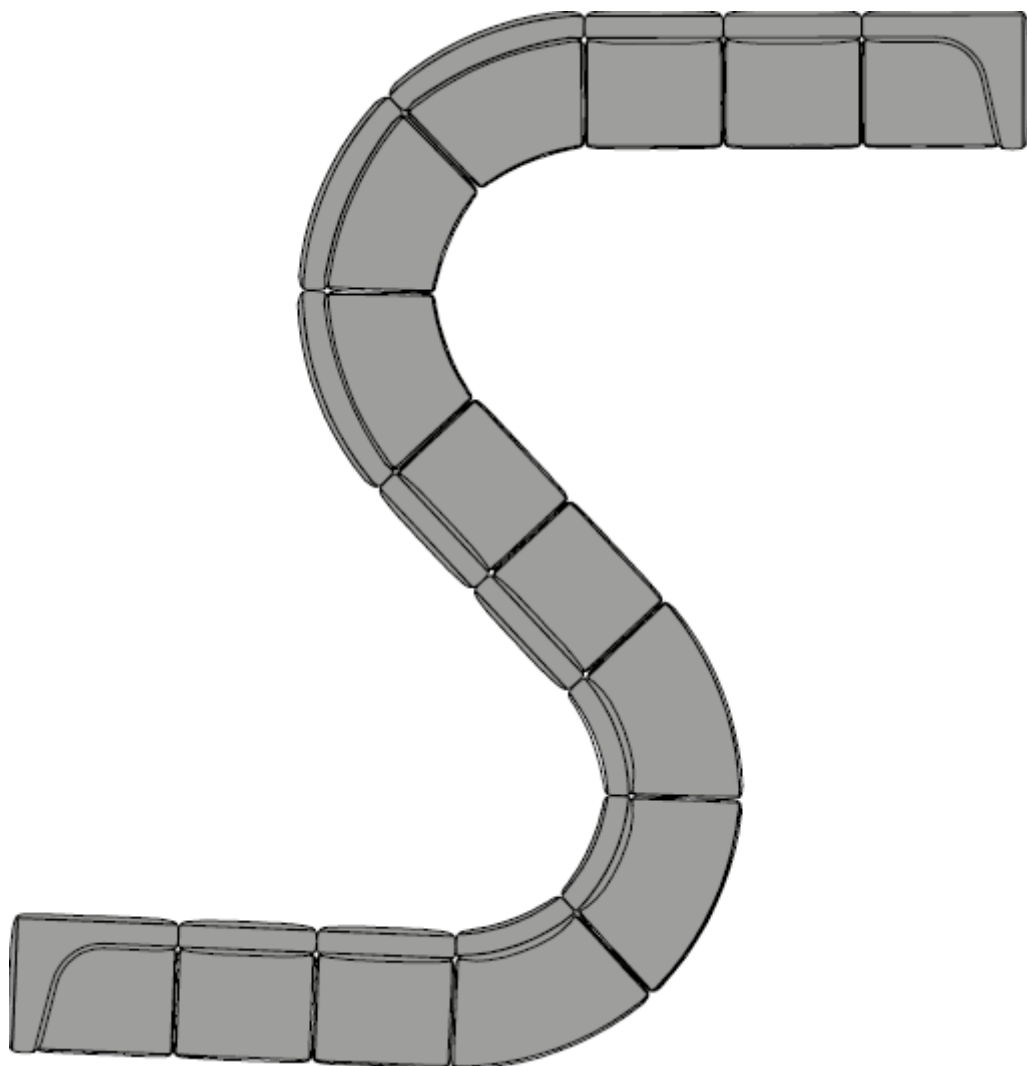

	COM	COL	1	2	3	4	5	6	7	8	9	10	11	L1	L2	L3	L6
€	20.065	20.579	21.201	21.713	22.114	22.788	23.475	24.245	25.081	25.933	26.774	27.622	28.492	29.277	32.441	38.225	53.572

Examples of modular configurations
Ejemplos de combinaciones modulares

Set 90 / Conjunto 90

10 Modules 10 Módulos

SF0301 + SF0301 + SF0301 + SF0301 + SF0361 +
SF0360 + SF0360 + SF0360 + SF0360 + SF0360

	COM cm. per unit	COL m2
1 units	3300	66,75
10 units or more	2990	

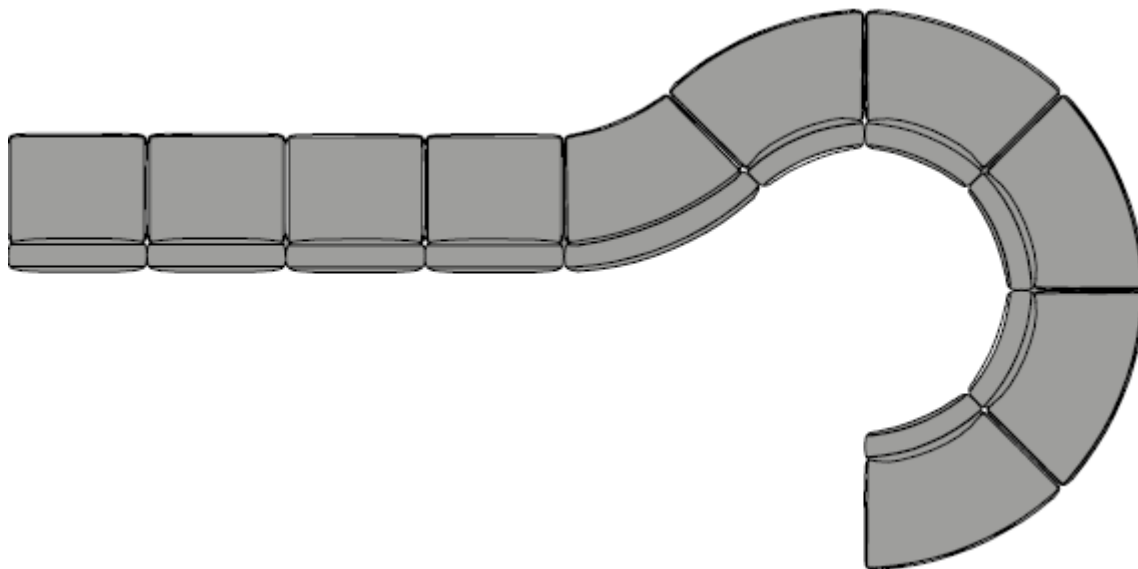

	COM	COL	1	2	3	4	5	6	7	8	9	10	11	L1	L2	L3	L6
€	14.165	14.513	14.943	15.295	15.568	16.032	16.503	17.017	17.577	18.145	18.702	19.274	19.886	20.441	22.681	26.759	37.526

Set 91 / Conjunto 91

10 Modules 10 Módulos

SF0300 + SF0300 + SF0300 + SF0360 + SF0360 +
SF0360 + SF0360 + SF0300 + SF0300 + SF0300

	COM cm. per unit	COL m2
1 units	3060	62
10 units or more	2660	

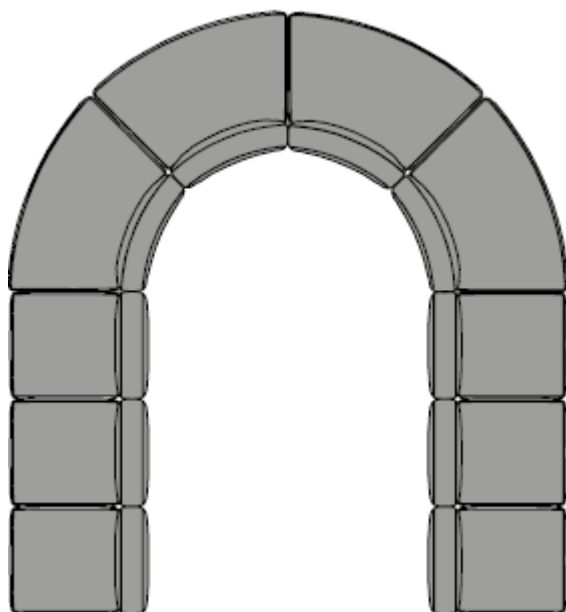

	COM	COL	1	2	3	4	5	6	7	8	9	10	11	L1	L2	L3	L6
€	12.878	13.178	13.548	13.852	14.084	14.488	14.888	15.288	15.692	16.104	16.504	16.912	17.362	17.786	19.582	22.816	31.400

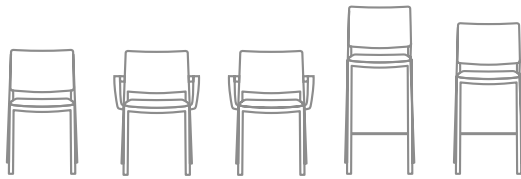

Description
Descripción

Stackable chairs and armchairs and barstools with seat and/or upholstered back or in beech board and frame and arms of solid beech.
Sillas y sillones apilables y banquetas con asiento y/o respaldo tapizado o en tablero de haya y estructura y brazos de madera maciza de haya.

Upholstery
Tapicería

The Duos collection supports following upholsteries of Andreu World Catalogue. For fabrics in our catalogue not specified in this box or customers own materials please contact our Customer Service Department.

La colección Duos admite las siguientes tapicerías del catálogo de Andreu World. Para las telas de nuestro catálogo no indicadas en este cuadro o telas cliente, consultar con nuestro Departamento Comercial.

Fabrics / Telas

- 1** Soft-fiber
- Jacquard One
- Jacquard Three
- Citadel
- Sand
- Era
- Gravity
- Rivet
- Urban
- Reel One (in/out)
- Spin One
- Spin Two
- Spin Three
- Spin Four
- Spin Five
- 2** Jacquard Two
- Solid & Stripes
- Loom One
- Circular One Pure Eco
- Tack One (in/out)

- 3** Jacquard Four
- Medley
- Revive 1
- Natte
- Main Line Flax
- Loom Two (in/out)
- Mezzo
- Reel two (in/out)
- Jacquard Five

- 4** Jacquard 4 Special
- Nexus
- Field 2
- Remix 3
- Heritage
- Savane
- Loom Three
- Loom Four
- Cura
- Oceanic
- Reel Three (in/out)
- Reel Four (in/out)
- Reflect
- Spin Six

- 5** Silk
- Synergy
- Step
- Step Melange
- Blazer
- Melange Nap
- Chili
- Noma
- Re-wool

- 6** Go check
- Swing
- Chartres
- Zori
- Patio
- Tack Two (in/out)
- Tack Three (in/out)

- 7** Canvas 2
- Select
- Clara 2
- Tack Five (in/out)
- Hero 2

- 8** Capture
- Fiord 2
- Tonus 4
- Divina 3
- Lopi
- Domino
- Atrium

- 9** Divina MD
- Divina Melange 3
- Hallingdal 65
- Steelcut Trio 3
- Tack Four (in/out)

- 11** Arda
- Ecriture
- Zero

Faux Leather / Ecopiel

- 1** Valencia
- 2** Silvertex
- 3** Maglia
- 4** Dolce
- 8** Ultraleather
- 9** Brisa
- Brisa Distressed
- Fresco
- Ultraleather Pro
- Promessa

- 10** Tottori
- Coast (in/out)

- 11** Reef Pro
- Volar Bio

Leather / Piel

- L1** High grade cow leather.
Piel de vaca de 1ª categoría.
- L3** Polished full grain leather.
Plena flor pulida.
- L6** Aniline leather batique-effect.
Scandinavian cattle.
Piel anilina efecto batique.
Ganado escandinavo.

Wood finish Beech
Acabado madera Haya



Certificates
Certificados

Fireproof polyurethane foam
Espuma de poliuretano ignifuga

UNE EN 1021:2006
BS 5852 part 2 crib 5
UNI 9175 Classe 1 IM
BKZ 5.2
California TB 117:2013
California TB 133*

*Contact our Customer Department
*Consultar con nuestro Departamento Comercial

Quality - Resistance
Calidad - Resistencia

UNE EN 16139:2013

Intellectual property Propiedad intelectual

All our collections are protected by international industrial design registries, designs patents, copyrights and intellectual Property laws. Unauthorized use of AW International Property is a criminal offence and can lead to prosecution.
Todas nuestras colecciones están protegidas por registros de diseño industrial, diseño de patente, copyright y derechos de propiedad intelectual en todo el mundo. El uso no autorizado de los diseños y propiedad intelectual de AW supone un delito que puede ser sometido a acción judicial.



SI2750

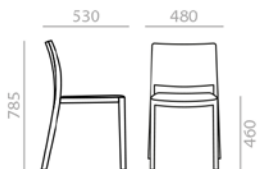

Stackable chair with beech plywood board seat and backrest and solid beech wood frame.

Silla apilable con asiento y respaldo de tablero de haya y estructura de madera maciza de haya.

- 0,35 m3
- 29,6 kg
- x4
- 8
- 12

€ 286

SO2751

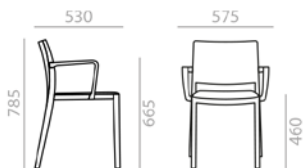

Stackable armchair with beech plywood board seat and backrest and solid beech wood frame.

Sillón apilable con asiento y respaldo de tablero de haya y estructura de madera maciza de haya.

- 0,33 m3
- 16 kg
- x2
- 6
- 6

€ 371

SI2752

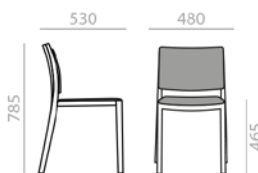

Stackable chair with upholstered seat and backrest and solid beech wood frame.

Silla apilable con asiento y respaldo tapizado y estructura de madera maciza de haya.

	COM cm. per unit	COL m2
1 units	56	1,25
10 units or more	50	

- 0,35 m3
- 36 kg
- x4
- 6
- 12

€	COM	COL	1	2	3	4	5	6	7	8	9	10	11	L1	L2	L3	L6
	444	448	453	458	462	468	474	480	486	492	498	504	510	527	546	591	723

SO2753

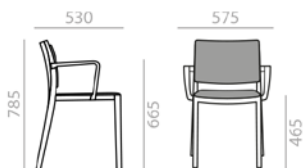

Stackable armchair with upholstered seat and backrest and solid beech wood frame.

Sillón apilable con asiento y respaldo tapizado y estructura de madera maciza de haya.

	COM cm. per unit	COL m2
1 units	56	1,25
10 units or more	50	

- 0,35 m3
- 19,2 kg
- x2
- 6
- 6

€	COM	COL	1	2	3	4	5	6	7	8	9	10	11	L1	L2	L3	L6
	567	571	577	583	587	593	600	606	613	619	626	632	639	645	678	716	848

SI2754

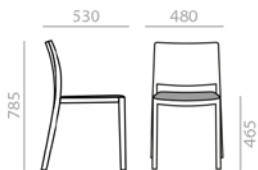

Stackable chair with upholstered seat, beech plywood backrest and solid beech wood frame.

Silla apilable con asiento tapizado, respaldo de tablero contrachapado de haya y estructura de madera maciza de haya.

	COM cm. per unit	COL m2
1 units	53	0,75
10 units or more	30	

- 0,35 m3
- 32,8 kg
- x4
- 6
- 12

€	COM	COL	1	2	3	4	5	6	7	8	9	10	11	L1	L2	L3	L6
	395	397	400	404	406	410	414	417	421	425	429	432	436	439	469	495	593

SO2755

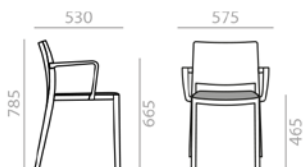

Stackable armchair with upholstered seat, beech plywood backrest and solid beech wood frame.

Sillón apilable con asiento tapizado, respaldo de tablero contrachapado de haya y estructura de madera maciza de haya.

	COM cm. per unit	COL m2
1 units	53	0,75
10 units or more	30	

0,35 m3

17,6 kg

x2

6

6

€	COM	COL	1	2	3	4	5	6	7	8	9	10	11	L1	L2	L3	L6
	476	479	482	486	488	492	496	499	503	507	511	514	518	521	537	579	665

BQ2756

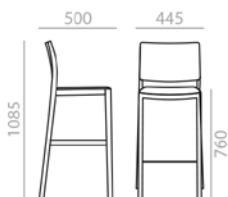

Barstool with beech plywood board seat and backrest and solid beech wood frame.

Banqueta alta con asiento y respaldo de tablero de haya y estructura de madera maciza de haya.

0,28 m3

8,3 kg

x1

€ 417

BQ2757

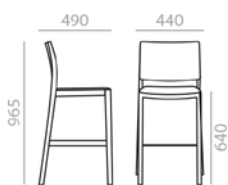

Counter stool with beech plywood board seat and backrest and solid beech wood frame.

Banqueta baja con asiento y respaldo de tablero de haya y estructura de madera maciza de haya.

0,24 m3

7,5 kg

x1

€ 417

BQ2760

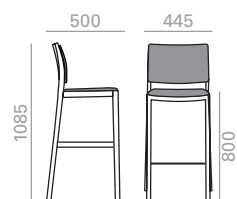

Barstool with upholstered seat and backrest and solid beech wood frame.

Banqueta alta con asiento y respaldo tapizado y estructura de madera maciza de haya.

	COM cm. per unit	COL m2
1 units	55	1
10 units or more	46	

0,28 m3

11 kg

x1

€	COM	COL	1	2	3	4	5	6	7	8	9	10	11	L1	L2	L3	L6
	566	571	575	580	583	588	594	600	606	611	616	622	628	632	652	690	811

BQ2761

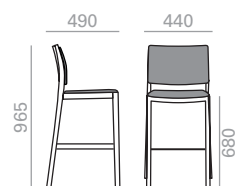

Counter stool with upholstered seat and backrest and solid beech wood frame.

Banqueta baja con asiento y respaldo tapizado y estructura de madera maciza de haya.

	COM cm. per unit	COL m2
1 units	55	1
10 units or more	46	

0,26 m3

9,1 kg

x1

€	COM	COL	1	2	3	4	5	6	7	8	9	10	11	L1	L2	L3	L6
	566	571	575	580	583	588	594	600	606	611	616	622	628	632	652	690	811

BQ2758

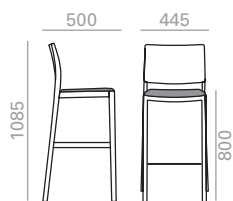

Barstool with upholstered seat, beech plywood backrest and solid beech wood frame.

Banqueta alta con asiento tapizado, respaldo de tablero contrachapado de haya y estructura de madera maciza de haya.

	COM cm. per unit	COL m2
1 units	55	1
10 units or more	30	

0,34 m3
11 kg
x1

€	COM	COL	1	2	3	4	5	6	7	8	9	10	11	L1	L2	L3	L6
	522	525	528	532	534	538	542	545	549	553	557	560	564	567	581	605	672

BQ2759

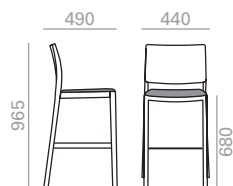

Counter stool with upholstered seat, beech plywood backrest and solid beech wood frame.

Banqueta baja con asiento tapizado, respaldo de tablero contrachapado de haya y estructura de madera maciza de haya.

	COM cm. per unit	COL m2
1 units	55	1
10 units or more	30	

0,26 m3
8,3 kg
x1

€	COM	COL	1	2	3	4	5	6	7	8	9	10	11	L1	L2	L3	L6
	522	525	528	532	534	538	542	545	549	553	557	560	564	567	581	605	672

For wooden legs. Para bases de madera.

SI2752, SO2753, SI2754, SO2755, BQ2760, BQ2761



Optional glides on page 482.

Opciones de tacos deslizantes en página 482.

SI2750, SO2751, BQ2756, BQ2757



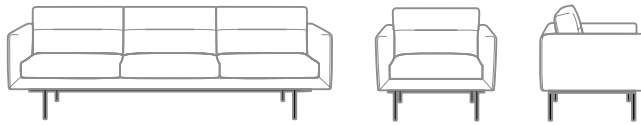

Description
Descripción

Lounge chair and 2-3-seater sofas with upholstered seat and back and 4 steel legs finished in polished chrome, white or black. Customizable inner seam tape finish in different colors. Additional options include: USB charging system.

Butaca y sofás de 2 o 3 plazas con asiento y respaldo tapizado y base de 4 patas de tubo de acero en acabado cromo brillo, blanco o negro. Costura interior personalizable en diferentes colores. Opciones disponibles: sistema USB de carga.

Upholstery
Tapicería

The Element collection supports following upholsteries of Andreu World Catalogue. For fabrics in our catalogue not specified in this box or customers own materials please contact our Customer Service Department.

La colección Element admite las siguientes tapicerías del catálogo de Andreu World. Para las telas de nuestro catálogo no indicadas en este cuadro o telas cliente, consultar con nuestro Departamento Comercial.

Fabrics / Telas

- 1 Soft-fiber
Jacquard One
Jacquard Three
Citadel
Sand
Era
Gravity
Rivet
Urban
Reel One (in/out)
Spin One
Spin Two
Spin Three
Spin Four
Spin Five
- 2 Jacquard Two
Solid & Stripes
Loom One
Circular One Pure Eco
Tack One (in/out)

- 3 Jacquard Four
Medley
Revive 1
Natte
Main Line Flax
Loom Two (in/out)
Mezzo
Reel two (in/out)
Jacquard Five
- 4 Jacquard 4 Special
Nexus
Field 2
Remix 3
Heritage
Savane
Loom Three
Loom Four
Cura
Oceanic
Reel Three (in/out)
Reel Four (in/out)
Reflect
Spin Six

- 5 Silk
Synergy
Step
Step Melange
Blazer
Melange Nap
Chili
Noma
Re-wool
- 6 Go check
Swing
Chartres
Zori
Patio
Tack Two (in/out)
Tack Three (in/out)
- 7 Canvas 2
Select
Clara 2
Tack Five (in/out)
Hero 2

- 8 Capture
Fiord 2
Tonus 4
Divina 3
Lopi
Domino
Atrium
- 9 Divina MD
Divina Melange 3
Hallingdal 65
Steelcut Trio 3
Tack Four (in/out)
- 11 Arda
Ecriture
Zero

Faux Leather / Ecopiel

- 1 Valencia
- 2 Silvertex
- 3 Maglia
- 4 Dolce
- 8 Ultraleather
- 9 Brisa
Brisa Distressed
Fresco
Ultraleather Pro
Promessa
- 10 Tottori
Coast (in/out)
- 11 Reef Pro
Volar Bio

Leather / Piel

- L1 High grade cow leather.
Piel de vaca de 1ª categoría.
- L3 Polished full grain leather.
Piena flor pulida.
- L6 Aniline leather batique-effect.
Scandinavian cattle.
Piel anilina efecto batique.
Ganado escandinavo.

Inner seam tape finish
Acabado cinta costura Interior

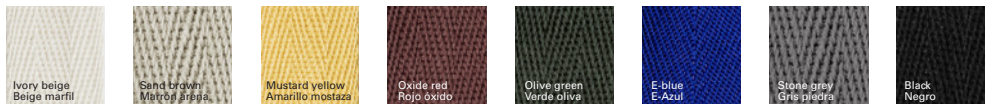

Steel finish
Acabado de acero



Certificates
Certificados

Fireproof polyurethane foam
Espuma de poliuretano ignifuga

UNE EN 1021:2006
BS 5852 part 2 crib 5
UNI 9175 Classe 1 IM
BKZ 5.2
California TB 117:2013
California TB 133*

*Contact our Customer Department
*Consultar con nuestro Departamento Comercial

Quality - Resistance
Calidad - Resistencia

UNE EN 16139:2013

Intellectual property Propiedad intelectual

All our collections are protected by international industrial design registries, designs patents, copyrights and intellectual Property laws. Unauthorized use of AW International Property is a criminal offence and can lead to prosecution.
Todas nuestras colecciones están protegidas por registros de diseño industrial, diseño de patente, copyright y derechos de propiedad intelectual todo el mundo. El uso no autorizado de los diseños y propiedad intelectual de AW supone un delito que puede ser sometido a acción judicial.



BU0725

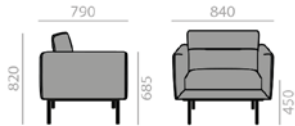

Lounge chair with upholstered seat and backrest and 4 steel legs finished in polished chrome, white or black.
Butaca con asiento y respaldo tapizado y base de 4 patas de tubo de acero en acabado cromo brillo, blanco o negro.

	COM cm. per unit	COL m2
1 units	550	10,8
10 units or more	550	

0,71 m3
 25 kg
 x1

€	COM	COL	1	2	3	4	5	6	7	8	9	10	11	L1	L2	L3	L6
	1.444	1.500	1.571	1.628	1.673	1.752	1.834	1.920	2.004	2.087	2.171	2.257	2.341	2.417	2.733	3.308	4.829



USB charging system upcharge
Incremento por sistema de USB de carga

| 195 |

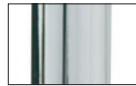

Polished chrome upcharge and steel colors
Incremento cromo brillo y resto de colores acero

| 87 |

BU0728

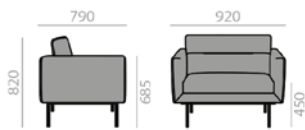

Lounge chair with upholstered seat and backrest and 4 steel legs finished in polished chrome, white or black.
Butaca con asiento y respaldo tapizado y base de 4 patas de tubo de acero en acabado cromo brillo, blanco o negro.

	COM cm. per unit	COL m2
1 units	750	14,7
10 units or more	750	

0,71 m3
 28,5 kg
 x1

€	COM	COL	1	2	3	4	5	6	7	8	9	10	11	L1	L2	L3	L6
	1.486	1.560	1.653	1.728	1.787	1.896	2.006	2.115	2.225	2.336	2.446	2.556	2.670	2.769	3.179	3.928	5.905



USB charging system upcharge
Incremento por sistema de USB de carga

| 195 |



Polished chrome upcharge and steel colors
Incremento cromo brillo y resto de colores acero

| 87 |

SF0726

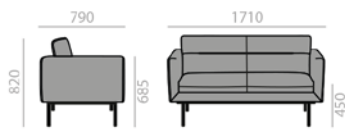

2-seater sofa with upholstered seat and backrest and 4 steel legs finished in polished chrome, white or black.
Sofá de 2 plazas con asiento y respaldo tapizado y base de 4 patas de tubo de acero en acabado cromo brillo, blanco o negro.

	COM cm. per unit	COL m2
1 units	980	19,2
10 units or more	980	

1,26 m3
 40,9 kg
 x1

€	COM	COL	1	2	3	4	5	6	7	8	9	10	11	L1	L2	L3	L6
	1.908	2.006	2.128	2.225	2.305	2.450	2.594	2.739	2.882	3.028	3.171	3.316	3.460	3.589	4.112	5.063	7.579



USB charging system upcharge
Incremento por sistema de USB de carga

| 195 |



Polished chrome upcharge and steel colors
Incremento cromo brillo y resto de colores acero

| 156 |

SF0727



3-seater sofa with upholstered seat and backrest and 4 steel legs finished in polished chrome, white or black.
Sofá de 3 plazas con asiento y respaldo tapizado y base de 4 patas de tubo de acero en acabado cromo brillo, blanco o negro.

	COM cm. per unit	COL m2
1 units	1200	23,5
10 units or more	1200	

1,92 m3
 56 kg
 x1

€	COM	COL	1	2	3	4	5	6	7	8	9	10	11	L1	L2	L3	L6
	2.258	2.377	2.522	2.637	2.729	2.887	3.043	3.210	3.401	3.590	3.783	4.081	4.264	4.422	5.074	6.264	9.573



USB charging system upcharge
Incremento por sistema de USB de carga

| 195 |



Polished chrome upcharge and steel colors
Incremento cromo brillo y resto de colores acero

| 300 |

Glides for 4 metal legs base. Tacos para bases de 4 patas metálicas.

Use/Usó	Reference/Referencia	Material/Material	Price/Precio
Hard floors. Suelos duros.	TS0422	Plastic (PE). Plástico (PE).	15 € Standard. Estándar.
Wooden and delicated floors. Suelos de madera y delicados.	TS0423	Plastic (PE) with felt. Plástico (PE) con fieltro.	12 € Set of 4 glides. Juego de 4 tacos.
Mats/carpet floors. Suelos de moqueta/ alfombra.	TS0424	Metal. Metal.	6 € Set of 4 glides. Juego de 4 tacos.

The indicated price is for glides placed on chairs. To order loose parts, please ask to our Sales Department.

El precio indicado en Tarifa es para tacos colocados en las sillas. Para pedidos de repuesto, consultar con el Departamento Comercial.

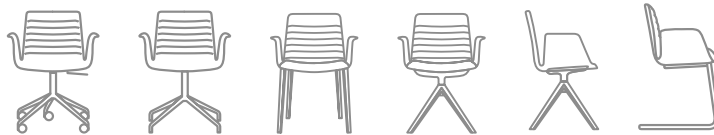

Description
Descripción

Armchairs with Eco thermopolymer seat and backrest available in different colors or Pure Eco thermopolymer (100% recycled content) available in sand color. The available bases are: cantilever, 4-legged or sled, finished in steel and polished chrome, white or black, 4-star central swivel base in solid beech and central swivel aluminum base with return system and height-adjustable version, finished in polished aluminum, black, or white, tilting mechanism version available. Available options: padded seat, padded seat and backrest, upholstered shell and upholstered with parallel seams. Flame retardant version available, for more information please contact the Sales Department.

Sillones con asiento y respaldo de termopolímero Eco disponible en diferentes colores o termopolímero Pure Eco (100% reciclado) disponible en color arena. Las bases disponibles son: cantiléver, 4 patas o patín, de acero y acabado cromo brillo, blanco o negro, 4 patas o base central giratoria de 4 aspas, en madera maciza de haya y base central giratoria de aluminio con sistema de retorno y versión regulable en altura, en acabado aluminio pulido, blanco o negro, disponible versión basculante. Opciones disponibles: asiento plafonado, asiento y respaldo plafonado, carcasa tapizada y tapizado con costuras paralelas. Versión ignífuga disponible, para más información rogamos contacten con el Departamento Comercial.

Upholstery
Tapicería

The Flex Armchair collection supports following upholsteries of Andreu World Catalogue. All upholstered versions are made with 100% recycled Pure Eco thermo-polymer. For fabrics in our catalogue not specified in this box or customers own materials please contact our Customer Service Department.

La colección Flex Armchair admite las siguientes tapicerías del catálogo de Andreu World. Todas las versiones tapizadas están hechas con termopolímero Pure Eco 100% reciclado. Para las telas de nuestro catálogo no indicadas en este cuadro o telas cliente,

Fabrics / Telas

- 1** Jacquard One
Jacquard Three
Sand
Era
Gravity
Rivet
Urban
Spin One
Spin Two
Spin Three
Spin Four
Spin Five
- 2** Jacquard Two
Circular One Pure Eco
Tack One (in/out)

- 3** Jacquard Four
Medley
Revive 1
Main Line Flax
Loom Two (in/out)
Mezzo
Reel two (in/out)
Jacquard Five

- 4** Jacquard 4 Special
Nexus
Heritage
Savane
Loom Three
Loom Four
Cura
Oceanic
Reel Three (in/out)
Reel Four (in/out)
Reflect
Spin Six

- 5** Silk
Synergy
Step
Step Melange
Blazer
Melange Nap
Chili
Noma
Re-wool

- 6** Go check
Swing
Chartres
Zori
Patio
Tack Two (in/out)
Tack Three (in/out)

- 7** Select
Clara 2
Tack Five (in/out)
Hero 2

- 8** Capture
Fiord 2
Tonus 4
Divina 3
Lopi
Domino
Atrium

- 9** Divina MD
Divina Melange 3
Hallingdal 65
Steelcut Trio 3
Tack Four (in/out)

- 11** Arda
Ecriture
Zero

Faux Leather / Ecopiel

- 1** Valencia
2 Silvertex
3 Maglia
- 8** Ultraleather
- 9** Fresco
Ultraleather Pro
Promessa
- 11** Volar Bio

Leather / Piel

- L1** High grade cow leather.
Piel de vaca de 1ª categoría.
- L3** Polished full grain leather.
Plena flor pulida.
- L6** Aniline leather batique-effect.
Scandinavian cattle.
Piel anilina efecto batique.
Ganado escandinavo.

Wood finish Beech
Acabado madera Haya

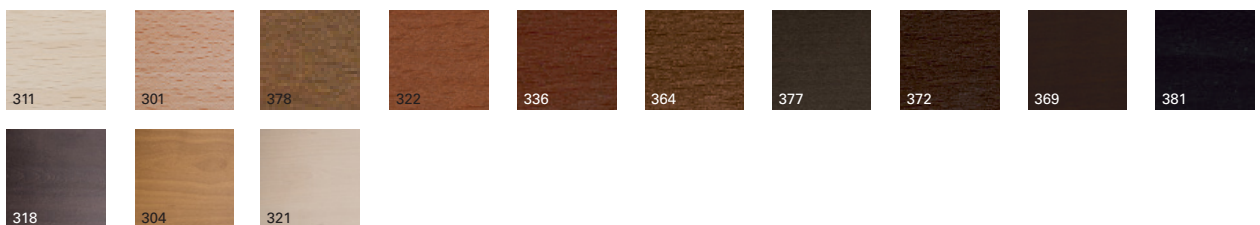

Eco Thermo-polymer finish
Acabado de Termo-polímero Eco

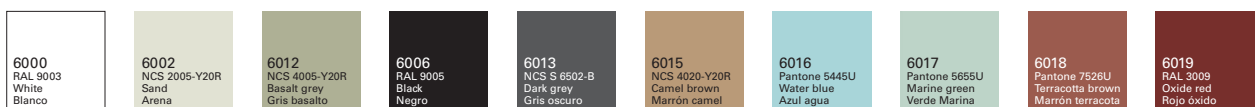

Pure Eco Thermo-polymer finish
Acabado de Termo-polímero Pure Eco



Premium finish and wood lacquers
Acabado premium y lacas madera



Aluminum finish
Acabado aluminio



Certificates
Certificados

Fireproof polyurethane foam

Espuma de poliuretano ignífuga

UNE EN 1021:2006
BS 5852 part 2 crib 5
UNI 9175 Classe 1 IM
BKZ 5.2
California TB 117:2013
California TB 133*

*Contact our Customer Department
*Consultar con nuestro Departamento Comercial

Quality - Resistance
Calidad - Resistencia

UNE EN 16139:2013

Intellectual property Propiedad intelectual

All our collections are protected by international industrial design registries, designs patents, copyrights and intellectual Property laws. Unauthorized use of AW International Property is a criminal offence and can lead to prosecution.
Todas nuestras colecciones están protegidas por registros de diseño industrial, diseño de patente, copyright y derechos de propiedad intelectual todo el mundo. El uso no autorizado de los diseños y propiedad intelectual de AW supone un delito que puede ser sometido a acción judicial.



SO1635

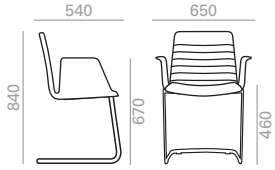

Armchair with Eco thermo-polymer shell available in several colors or Pure Eco thermo-polymer (100% recycled) available in sand color and tubular steel cantilever base finished in polished chrome, white or black. Available options: Upholstered seat pad, upholstered shell pad, fully upholstered shell and parallel stitching upholstery. Fire retardant version available, for further information contact our Sales Department. In upholstered versions the seat height increases 20 mm.

Sillón con carcasa de termopolímero Eco disponible en diferentes colores o termopolímero Pure Eco (100% reciclado) disponible en color arena y base cantiléver de tubo de acero en acabado blanco, negro o cromo brillo. Opciones disponibles: Asiento plafonado, asiento y respaldo plafonado, carcasa tapizada y tapizado con costuras paralelas. Versión ignífuga disponible, para más información rogamos contacte con el Departamento Comercial. En versiones tapizadas la altura de asiento aumenta 20 mm.

COM cm. per unit	COL m2
------------------	--------

0,32 m3
9,5 kg
x1

Fully upholstered Carcasa tapizada		
1 units	145	2,75
10 units or more	140	

Seat pad Asiento plafonado		
1 units	55	0,75
10 units or more	30	

Shell pad Asiento y respaldo plafonado		
1 units	120	2,25
10 units or more	110	

€ TP
261



Thermo-polymer shell
Carcasa termopolímero



Fully upholstered shell
Carcasa tapizada



Upholstered seat pad
Asiento plafonado



Upholstered shell pad
Asiento y respaldo plafonado

COM	COL	1	2	3	4	5	6	7	8	9	10	11	L1	L2	L3	L6
608	625	644	664	685	712	740	766	794	821	848	879	906	932	1.036	1.227	1.728

COM	COL	1	2	3	4	5	6	7	8	9	10	11	L1	L2	L3	L6
360	364	367	371	373	377	381	385	389	393	397	401	405	410	425	452	530

COM	COL	1	2	3	4	5	6	7	8	9	10	11	L1	L2	L3	L6
535	546	558	569	577	590	604	619	632	646	659	675	693	708	769	881	1.207

Parallel stitching upholstery upcharge (Seat and back)
Incremento tapizado con costuras paralelas (Asiento y respaldo) | 59 |



Parallel stitching upholstery upcharge (Seat)
Incremento tapizado con costuras paralelas (Asiento) | 30 |

SO1646

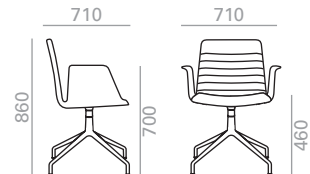

Armchair with Eco thermo-polymer shell available in several colors or Pure Eco thermo-polymer (100% recycled) available in sand color and a 4- star central aluminum swivel base with self-return system and finished in polished aluminum, white or black. Available options: Upholstered seat pad, upholstered shell pad, fully upholstered shell and parallel upholstery stitching. In upholstered versions the seat height increases 20 mm.

Sillón con carcasa de termopolímero Eco disponible en diferentes colores o termopolímero Pure Eco (100% reciclado) disponible en color arena y base central giratoria de aluminio de 4 aspas con sistema de retorno disponible en acabado aluminio pulido, blanco o negro. Opciones disponibles: Asiento plafonado, asiento y respaldo plafonado, carcasa tapizada y tapizado con costuras paralelas. En versiones tapizadas la altura de asiento aumenta 20 mm.

COM cm. per unit	COL m2
------------------	--------

0,35 m3
10,5 kg
x1

Fully upholstered Carcasa tapizada		
1 units	145	2,75
10 units or more	140	

Seat pad Asiento plafonado		
1 units	55	0,75
10 units or more	30	

Shell pad Asiento y respaldo plafonado		
1 units	120	2,25
10 units or more	110	

€ TP
378



Thermo-polymer shell
Carcasa termopolímero



Fully upholstered shell
Carcasa tapizada



Upholstered seat pad
Asiento plafonado



Upholstered shell pad
Asiento y respaldo plafonado

COM	COL	1	2	3	4	5	6	7	8	9	10	11	L1	L2	L3	L6
714	731	749	768	785	811	835	861	886	909	935	962	984	1.007	1.098	1.261	1.694

COM	COL	1	2	3	4	5	6	7	8	9	10	11	L1	L2	L3	L6
476	479	482	486	488	492	496	500	505	509	512	516	520	524	538	565	636

COM	COL	1	2	3	4	5	6	7	8	9	10	11	L1	L2	L3	L6
655	665	678	689	696	711	725	739	753	766	781	795	809	820	872	963	1.208

Tilting mechanism upcharge. Available only in fully upholstered shell.
Incremento por sistema basculante. Disponible solo en carcasa tapizada. | 42 |



Parallel stitching upholstery upcharge (Seat and back)
Incremento tapizado con costuras paralelas (Asiento y respaldo) | 59 |



Parallel stitching upholstery upcharge (Seat)
Incremento tapizado con costuras paralelas (Asiento) | 30 |

SO1661



Armchair with Eco thermo-polymer shell available in several colors or Pure Eco thermo-polymer (100% recycled) available in sand color and a central swivel base with 5 casters, height adjustment and finished in polished aluminum, white or black. Available options: Upholstered seat pad, upholstered shell pad, fully upholstered shell and parallel stitching upholstery. Fire retardant version available for further information contact our Sales Department. Height ranges: seat 430-530 mm./arms 615-715 mm. In upholstered versions the seat height increases 20 mm.

Sillón con carcasa de termopolímero Eco disponible en diferentes colores o termopolímero Pure Eco (100% reciclado) disponible en color arena y base central giratoria de aluminio con 5 ruedas, regulable en altura y acabado aluminio pulido, blanco o negro. Opciones disponibles: Asiento plafonado, asiento y respaldo plafonado, carcasa tapizada y tapizado con costuras paralelas. Rangos de altura: asiento 430-530 mm./brazos 615-715 mm. En versiones tapizadas la altura de asiento aumenta 20 mm.

COM cm. per unit	COL m2
---------------------	-----------

0,37 m3
12,5 kg
x1

Fully upholstered Carcasa tapizada		2,75
1 units	145	
10 units or more	140	

Seat pad Asiento plafonado		0,75
1 units	55	
10 units or more	30	

Shell pad Asiento y respaldo plafonado		2,25
1 units	120	
10 units or more	110	

TP	393
----	-----



Thermo-polymer shell
Carcasa termopolímero



Fully upholstered shell
Carcasa tapizada



Upholstered seat pad
Asiento plafonado



Upholstered shell pad
Asiento y respaldo plafonado

COM	COL	1	2	3	4	5	6	7	8	9	10	11	L1	L2	L3	L6
719	739	758	779	798	823	850	877	903	928	955	981	1.007	1.031	1.124	1.296	1.752
479	482	486	490	493	497	503	507	511	517	521	525	530	535	551	582	662
657	668	682	695	703	718	733	749	764	779	795	810	825	839	894	995	1.261

Tilting mechanism upcharge. Available only in fully upholstered shell. Incremento por sistema basculante. Disponible solo en carcasa tapizada. | 35 |



Parallel stitching upholstery upcharge (Seat and back) Incremento tapizado con costuras paralelas (Asiento y respaldo) | 59 |



Parallel stitching upholstery upcharge (Seat) Incremento tapizado con costuras paralelas (Asiento) | 30 |

SO1662

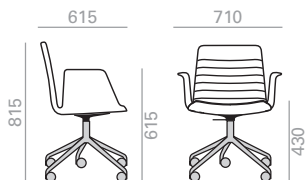

Armchair with Eco thermo-polymer shell available in several colors or Pure Eco thermo-polymer (100% recycled) available in sand color and Eco thermo-polymer central base with 5 casters, swivel and pneumatic height adjustment, finished in black. Available options: Upholstered seat pad, upholstered shell pad, fully upholstered shell and parallel upholstery stitching. Fire retardant version available, for further information contact our Sales Department. Height ranges: seat 430-530 mm./arms 615-715 mm. In upholstered versions the seat height increases 20 mm.

Sillón con carcasa de termopolímero Eco disponible en diferentes colores o termopolímero Pure Eco (100% reciclado) disponible en color arena y base central giratoria de termopolímero Eco de 5 ruedas, regulable en altura y acabado negro. Opciones disponibles: Asiento plafonado, asiento y respaldo plafonado, carcasa tapizada y tapizado con costuras paralelas. Rangos de altura: asiento 430-530 mm./brazos 615-715 mm. En versiones tapizadas la altura de asiento aumenta 20 mm.

COM cm. per unit	COL m2
---------------------	-----------

0,37 m3
9 kg
x1

Fully upholstered Carcasa tapizada		2,75
1 units	145	
10 units or more	140	

Seat pad Asiento plafonado		0,75
1 units	55	
10 units or more	30	

Shell pad Asiento y respaldo plafonado		2,25
1 units	120	
10 units or more	110	

TP	255
----	-----



Thermo-polymer shell
Carcasa termopolímero



Fully upholstered shell
Carcasa tapizada



Upholstered seat pad
Asiento plafonado



Upholstered shell pad
Asiento y respaldo plafonado

COM	COL	1	2	3	4	5	6	7	8	9	10	11	L1	L2	L3	L6
604	621	643	660	675	698	722	745	769	796	819	845	869	891	983	1.149	1.585
352	356	359	363	366	370	375	379	384	389	393	397	401	406	423	452	531
535	546	559	570	579	595	609	624	639	653	669	683	698	711	765	862	1.127

Tilting mechanism upcharge. Available only in fully upholstered shell. Incremento por sistema basculante. Disponible solo en carcasa tapizada. | 35 |



Parallel stitching upholstery upcharge (Seat and back) Incremento tapizado con costuras paralelas (Asiento y respaldo) | 59 |



Parallel stitching upholstery upcharge (Seat) Incremento tapizado con costuras paralelas (Asiento) | 30 |

SO1612

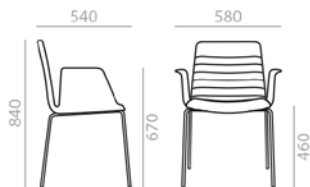

Armchair with Eco thermo-polymer shell available in several colors or Pure Eco thermo-polymer (100% recycled) available in sand color and 4 tubular steel legs and finished in black or polished chrome. Available options: Upholstered seat pad, upholstered shell pad, fully upholstered shell and parallel upholstery stitching. Fire retardant version available, for further information contact our Sales Department. In upholstered versions the seat height increases 20 mm.

Sillón con carcasa de termopolímero Eco disponible en diferentes colores o termopolímero Pure Eco (100% reciclado) disponible en color arena y base de 4 patas de tubo de acero en acabado negro o cromo brillo. Opciones disponibles: Asiento plafonado, asiento y respaldo plafonado, carcasa tapizada y tapizado con costuras paralelas. Versión ignífuga disponible, para más información rogamos contacten con el Departamento Comercial. En versiones tapizadas la altura de asiento aumenta 20 mm.

COM cm. per unit	COL m2
------------------	--------

0,36 m3
10,5 kg
x1

Fully upholstered Carcasa tapizada		2,75
1 units	145	
10 units or more	140	

Seat pad Asiento plafonado		0,75
1 units	55	
10 units or more	30	

Shell pad Asiento y respaldo plafonado		2,25
1 units	120	
10 units or more	110	

€ TP
226



Thermo-polymer shell
Carcasa termopolímero



Fully upholstered shell
Carcasa tapizada



Upholstered seat pad
Asiento plafonado



Upholstered shell pad
Asiento y respaldo plafonado

COM	COL	1	2	3	4	5	6	7	8	9	10	11	L1	L2	L3	L6
-----	-----	---	---	---	---	---	---	---	---	---	----	----	----	----	----	----

523	537	555	571	582	603	624	647	673	698	719	744	769	789	878	1.042	1.476
-----	-----	-----	-----	-----	-----	-----	-----	-----	-----	-----	-----	-----	-----	-----	-------	-------

COM	COL	1	2	3	4	5	6	7	8	9	10	11	L1	L2	L3	L6
-----	-----	---	---	---	---	---	---	---	---	---	----	----	----	----	----	----

291	294	297	300	302	307	309	313	318	322	324	329	333	335	349	374	439
-----	-----	-----	-----	-----	-----	-----	-----	-----	-----	-----	-----	-----	-----	-----	-----	-----

COM	COL	1	2	3	4	5	6	7	8	9	10	11	L1	L2	L3	L6
-----	-----	---	---	---	---	---	---	---	---	---	----	----	----	----	----	----

486	496	508	518	527	540	553	567	580	593	607	620	633	646	694	783	1.016
-----	-----	-----	-----	-----	-----	-----	-----	-----	-----	-----	-----	-----	-----	-----	-----	-------



Parallel stitching upholstery upcharge (Seat and back)
Incremento tapizado con costuras paralelas (Asiento y respaldo) | 59 |



Parallel stitching upholstery upcharge (Seat)
Incremento tapizado con costuras paralelas (Asiento) | 30 |

SO1636

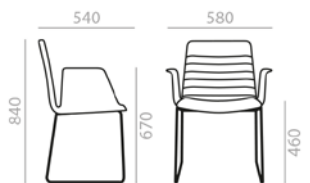

Armchair with Eco thermo-polymer shell available in several colors or Pure Eco thermo-polymer (100% recycled) available in sand color and a steel sled base and finished in polished chrome, white or black. Available options: Upholstered seat pad, upholstered shell pad, fully upholstered shell and parallel upholstery stitching. Fire retardant version available. In upholstered versions the seat height increases 20 mm.

Sillón con carcasa de termopolímero Eco disponible en diferentes colores o termopolímero Pure Eco (100% reciclado) disponible en color arena y base de patín de varilla de acero en acabado cromo brillo, blanco o negro. Opciones disponibles: Asiento plafonado, asiento y respaldo plafonado, carcasa tapizada y tapizado con costuras paralelas. Versión ignífuga disponible. En versiones tapizadas la altura de asiento aumenta 20 mm.

COM cm. per unit	COL m2
------------------	--------

0,35 m3
10,5 kg
x1

Fully upholstered Carcasa tapizada		2,75
1 units	145	
10 units or more	140	

Seat pad Asiento plafonado		0,75
1 units	55	
10 units or more	30	

Shell pad Asiento y respaldo plafonado		2,25
1 units	120	
10 units or more	110	

€ TP
230



Thermo-polymer shell
Carcasa termopolímero



Fully upholstered shell
Carcasa tapizada



Upholstered seat pad
Asiento plafonado



Upholstered shell pad
Asiento y respaldo plafonado

COM	COL	1	2	3	4	5	6	7	8	9	10	11	L1	L2	L3	L6
-----	-----	---	---	---	---	---	---	---	---	---	----	----	----	----	----	----

526	541	559	575	586	606	626	650	675	697	721	745	769	791	881	1.044	1.479
-----	-----	-----	-----	-----	-----	-----	-----	-----	-----	-----	-----	-----	-----	-----	-------	-------

COM	COL	1	2	3	4	5	6	7	8	9	10	11	L1	L2	L3	L6
-----	-----	---	---	---	---	---	---	---	---	---	----	----	----	----	----	----

296	298	301	305	306	310	314	317	321	325	328	332	336	339	352	377	441
-----	-----	-----	-----	-----	-----	-----	-----	-----	-----	-----	-----	-----	-----	-----	-----	-----

COM	COL	1	2	3	4	5	6	7	8	9	10	11	L1	L2	L3	L6
-----	-----	---	---	---	---	---	---	---	---	---	----	----	----	----	----	----

490	500	512	522	531	544	557	570	584	597	610	624	637	649	697	785	1.018
-----	-----	-----	-----	-----	-----	-----	-----	-----	-----	-----	-----	-----	-----	-----	-----	-------



Parallel stitching upholstery upcharge (Seat and back)
Incremento tapizado con costuras paralelas (Asiento y respaldo) | 59 |



Parallel stitching upholstery upcharge (Seat)
Incremento tapizado con costuras paralelas (Asiento) | 30 |

SO1613

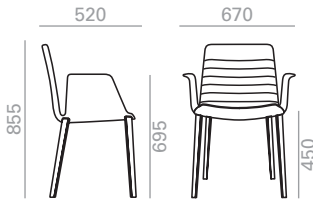

Armchair with Eco thermo-polymer shell available in several colors or Pure Eco thermo-polymer (100% recycled) available in sand color and 4-legs beech wood base. Available options: Upholstered seat pad, upholstered shell pad, fully upholstered shell and parallel upholstery stitching. Fire retardant version available, for further information contact our Sales Department. In upholstered versions the seat height increases 20 mm.

Sillón con carcasa de termopolímero Eco disponible en diferentes colores o termopolímero Pure Eco (100% reciclado) disponible en color arena y base de 4 patas de madera maciza de haya. Opciones disponibles: Asiento plafonado, asiento y respaldo plafonado, carcasa tapizada y tapizado con costuras paralelas. Versión ignífuga disponible, para más información rogamos contacten con el Departamento Comercial. En versiones tapizadas la altura de asiento aumenta 20 mm.

COM cm. per unit	COL m2
------------------	--------

0,32 m3
11,3 kg
x1

Fully upholstered Carcasa tapizada		
1 units	145	1,6
10 units or more	145	

Seat pad Asiento plafonado		
1 units	30	0,75
10 units or more	30	

Shell pad Asiento y respaldo plafonado		
1 units	110	1,25
10 units or more	110	

€ TP
292



Thermo-polymer shell
Carcasa termopolímero



Fully upholstered shell
Carcasa tapizada



Upholstered seat pad
Asiento plafonado



Upholstered shell pad
Asiento y respaldo plafonado

COM	COL	1	2	3	4	5	6	7	8	9	10	11	L1	L2	L3	L6
642	657	677	694	706	728	749	771	797	823	847	872	898	921	1.011	1.179	1.619
395	397	400	404	405	409	414	418	422	426	430	434	438	442	455	482	551
545	555	566	576	584	597	610	623	636	650	663	675	688	700	755	851	1.105

SERIE 600 Matte lacquered and premium upcharge Incremento por lacado mate y premium | 17 |

SERIE 800 Bright lacquered upcharge Incremento por lacado brillo | 24 |



Parallel stitching upholstery upcharge (Seat and back) Incremento tapizado con costuras paralelas (Asiento y respaldo) | 59 |



Parallel stitching upholstery upcharge (Seat) Incremento tapizado con costuras paralelas (Asiento) | 30 |

SO1647



Armchair with Eco thermo-polymer shell available in several colors or Pure Eco thermo-polymer (100% recycled) available in sand color and solid beech wood central swivel base. Available options: Upholstered seat pad, upholstered shell pad, fully upholstered shell and parallel upholstery stitching. Fire retardant version available, for further information contact our Sales Department. In upholstered versions the seat height increases 20 mm.

Sillón con carcasa de termopolímero Eco disponible en diferentes colores o termopolímero Pure Eco (100% reciclado) disponible en color arena y base central giratoria de 4 aspas de madera maciza de haya. Opciones disponibles: Asiento plafonado, asiento y respaldo plafonado, carcasa tapizada y tapizado con costuras paralelas. Versión ignífuga disponible, para más información rogamos contacten con el Departamento Comercial. En versiones tapizadas la altura de asiento aumenta 20 mm.

COM cm. per unit	COL m2
------------------	--------

0,35 m3
10,1 kg
x1

Fully upholstered Carcasa tapizada		
1 units	145	1,6
10 units or more	145	

Seat pad Asiento plafonado		
1 units	30	0,75
10 units or more	30	

Shell pad Asiento y respaldo plafonado		
1 units	110	1,25
10 units or more	100	

€ TP
406



Thermo-polymer shell
Carcasa termopolímero



Fully upholstered shell
Carcasa tapizada



Upholstered seat pad
Asiento plafonado



Upholstered shell pad
Asiento y respaldo plafonado

COM	COL	1	2	3	4	5	6	7	8	9	10	11	L1	L2	L3	L6
744	761	780	799	819	844	869	897	923	947	973	1.001	1.027	1.049	1.142	1.276	1.713
519	523	526	530	533	537	542	546	550	554	559	563	567	571	587	615	691
685	696	709	720	729	743	757	772	787	801	816	830	844	857	909	1.005	1.260

SERIE 600 Matte lacquered and premium upcharge Incremento por lacado mate y premium | 24 |

SERIE 800 Bright lacquered upcharge Incremento por lacado brillo | 35 |



Parallel stitching upholstery upcharge (Seat and back) Incremento tapizado con costuras paralelas (Asiento y respaldo) | 59 |



Parallel stitching upholstery upcharge (Seat) Incremento tapizado con costuras paralelas (Asiento) | 30 |

Glides for central base. Tacos para base central.

Use/Usó	Reference/Referencia	Material/Material	Price/Precio
Hard floors. Suelos duros.	TS0539	Plastic (PE). Plástico (PE).	0 € Standard. Estándar.
Wooden and delicate floors. Suelos de madera y delicados.	TS0533	Plastic (PE) with felt. Plástico (PE) con fieltro.	3 € Set of 4 glides. Juego de 4 tacos.
Mats/carpet floors. Suelos de moqueta/ alfombra.	TS0543	Metal. Metal.	3 €

The indicated price is for glides placed on chairs. To order loose parts, please ask to our Sales Department.

El precio indicado en Tarifa es para tacos colocados en las sillas. Para pedidos de tacos sueltos de repuesto, consultar con el Departamento Comercial.



Glides for sled bases/cantilever. Tacos para bases de patín/cantilever.

Use/Usó	Reference/Referencia	Material/Material	Price/Precio
Hard floors. Suelos duros.	TS0531	Plastic (PE). Plástico (PE).	0 € Standard. Estándar.
Wooden and delicate floors. Suelos de madera y delicados.	TS0538	Plastic (PE) with felt. Plástico (PE) con fieltro.	6 € Set of 4 glides. Juego de 4 tacos.
Mats/carpet floors. Suelos de moqueta/ alfombra.	TS0537	No glide. Sin taco.	0 €

Glides for 4 metal legs base. Tacos para bases de 4 patas metálicas.

Use/Usó	Reference/Referencia	Material/Material	Price/Precio
Hard floors. Suelos duros.	TS0558	Plastic (PE). Plástico (PE).	0 € Standard. Estándar.
Wooden and delicate floors. Suelos de madera y delicados.	TS0534	Plastic (PE) with felt. Plástico (PE) con fieltro.	4 € Set of 4 glides. Juego de 4 tacos.
Mats/carpet floors. Suelos de moqueta/ alfombra.	TS0559	Metal. Metal.	4 € Set of 4 glides. Juego de 4 tacos.

Glides for cantilever base. Tacos para base cantiléver.

Use/Usó	Reference/Referencia		Material/Material	Price/Precio	
Hard floors. Suelos duros.	TS0545		Plastic (PE). Plástico (PE).	0 €	Standard. Estándar.
Wooden and delicate floors. Suelos de madera y delicados.	TS0546		Plastic (PE) with felt. Plástico (PE) con fieltro.	6 €	Set of 4 glides. Juego de 4 tacos.
Mats/carpet floors. Suelos de moqueta/ alfombra.	TS0547		No glide. Sin taco.	0 €	

The indicated price is for glides placed on chairs. To order loose parts, please ask to our Sales Department.

El precio indicado en Tarifa es para tacos colocados en las sillas. Para pedidos de tacos sueltos de repuesto, consultar con el Departamento Comercial.

For wooden legs. Para bases de madera.



Optional glides on page 482.

Opciones de tacos deslizantes en página 482.

Casters. Ruedas.



Standard.
Estándar.



Description
Descripción

Chairs, armchairs and stools with Eco thermopolymer seat and backrest available in different colors or Pure Eco thermopolymer (100% recycled content) available in sand color and upholstered seat and backrest option. The bases available for chairs and armchairs are: steel sled or cantilever finished in polished chrome, white or black, 4 steel tube legs available in different colors, aluminum central swivel base with self-return system and height-adjustable version, or fixed central base with 4 casters, with or without arms, finished in polished aluminum, white or black, tilting mechanism version available. Chair version with 4-legged solid beech base. The available stool bases are: central swivel base with 4 legs or 4 steel tube legs finished in polished chrome, white or black or injected aluminum central swivel base finished in polished aluminum, white or black. The stools are offered in 2 different heights and widths. Stacking protector included in upholstered versions. Available options: padded seat, padded seat and backrest, upholstered shell and upholstered with parallel seams. Flame retardant version available, for more information please contact the Sales Department.

Sillas, sillones y banquetas con asiento y respaldo de termopolímero Eco disponible en diferentes colores o termopolímero Pure Eco (100% reciclado) disponible en color arena y opción de asiento y respaldo tapizado. Las bases disponibles de sillas y sillones son: patín de varilla o cantiléver en acero y acabado cromo brillo, blanco o negro, 4 patas de tubo de acero disponible en diferentes colores, base central giratoria de aluminio con sistema de retorno y versión regulable en altura, o base central fija de 4 ruedas, con o sin brazos, en acabado aluminio pulido, blanco o negro, disponible versión basculante. Versión de silla con base de 4 patas de madera maciza de haya. Las bases disponibles de banquetas son: base central giratoria de 4 patas o 4 patas de tubo en acero y acabado cromo brillo, blanco o negro o base central giratoria de aluminio inyectado en acabado aluminio pulido, blanco o negro. Las banquetas se ofrecen en 2 alturas y anchos diferentes. Incluido protector de apilado en las versiones tapizadas. Opciones disponibles: asiento plafonado, asiento y respaldo plafonado, carcasa tapizada y tapizado con costuras paralelas. Versión ignífuga disponible, para más información rogamos contacten con el Departamento Comercial.

Upholstery
Tapicería

The Flex Chair collection supports following upholsteries of Andreu World Catalogue. All upholstered versions are made with 100% recycled Pure Eco thermo-polymer. For fabrics in our catalogue not specified in this box or customers own materials please contact our Customer Service Department.

La colección Flex Chair admite las siguientes tapicerías del catálogo de Andreu World. Todas las versiones tapizadas están hechas con termopolímero Pure Eco 100% reciclado. Para las telas de nuestro catálogo no indicadas en este cuadro o telas cliente, consultar con nuestro Departamento Comercial.

Fabrics / Telas

- 1 Jacquard One
- Jacquard Three
- Sand
- Era
- Gravity
- Rivet
- Urban
- Spin One
- Spin Two
- Spin Three
- Spin Four
- Spin Five
- 2 Jacquard Two
- *Loom One
- Circular One Pure Eco
- Tack One (in/out)

- 3 Jacquard Four
- Medley
- Revive 1
- Main Line Flax
- Loom Two (in/out)
- Mezzo
- Reel two (in/out)
- Jacquard Five
- 4 Jacquard 4 Special
- Nexus
- *Remix 3
- Heritage
- Savane
- Loom Three
- Loom Four
- Cura
- Oceanic
- Reel Three (in/out)
- Reel Four (in/out)
- Reflect
- Spin Six

- 5 Silk
- Synergy
- Step
- Step Melange
- Blazer
- Melange Nap
- Chili
- Noma
- Re-wool
- 6 Go check
- Swing
- Chartres
- Savane
- Loom Three
- Loom Four
- Cura
- Oceanic
- Reel Three (in/out)
- Reel Four (in/out)
- Reflect
- Spin Six
- 7 Canvas 2
- Select
- Clara 2
- Tack Five (in/out)
- Hero 2

- 8 Capture
- Fiord 2
- Tonus 4
- Divina 3
- Lopi
- Domino
- Atrium
- 9 Divina MD
- Divina Melange 3
- Hallingdal 65
- Steelcut Trio 3
- Tack Four (in/out)
- 11 Arda
- Ecriture
- Zero

Faux Leather / Ecopiel

- 1 Valencia
- 2 Silvertex
- 3 Maglia
- 8 Ultraeather
- 9 Brisa
- Brisa Distressed
- Fresco
- Ultraeather Pro
- Promessa
- 10 Tottori
- Coast (in/out)
- 11 Reef Pro
- Volair Bio

Leather / Piel

- L1 High grade cow leather.
- Piel de vaca de 1ª categoría.
- L3 Polished full grain leather.
- Plena flor pulida.
- L6 Aniline leather batique-effect.
- Scandinavian cattle.
- Piel anilina efecto batique.
- Ganado escandinavo.

* Only available with parallel stitching upholstery.
Solo en tapizado con costuras paralelas.

Wood finish Beech
Acabado madera Haya

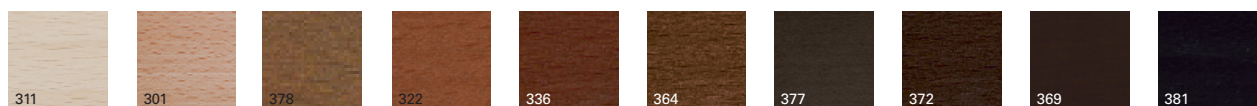

Aluminum finish
Acabado aluminio



Premium finish and wood lacquers
Acabado premium y lacas madera



Eco Thermo-polymer finish
Acabado de Termo-polímero Eco

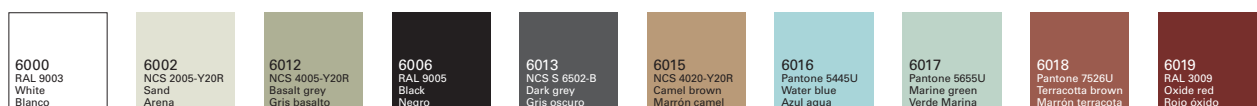

Steel finish
Acabado de acero



Pure Eco Thermo-polymer finish
Acabado de Termo-polímero Pure Eco



Certificates
Certificados

Fireproof polyurethane foam
Espuma de poliuretano ignífuga

UNE EN 1021:2006
BS 5852 part 2 crib 5
UNI 9175 Classe 1 IM
BKZ 5.2
California TB 117:2013
California TB 133*

*Contact our Customer Department
*Consultar con nuestro Departamento Comercial

Quality - Resistance
Calidad - Resistencia

UNE EN 16139:2013

Intellectual property Propiedad intelectual

All our collections are protected by international industrial design registries, designs patents, copyrights and intellectual Property laws. Unauthorized use of AW International Property is a criminal offence and can lead to prosecution.
Todas nuestras colecciones están protegidas por registros de diseño industrial, diseño de patente, copyright y derechos de propiedad intelectual en todo el mundo. El uso no autorizado de los diseños y propiedad intelectual de AW supone un delito que puede ser sometido a acción judicial.



SI1302

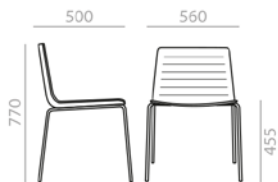

Stackable chair with Eco thermo-polymer shell available in several colors or Pure Eco thermo-polymer (100% recycled) available in sand color and 4 tubular steel legs available in several colors. The upholstered version includes a stacking protector. Available options: Upholstered seat pad, upholstered shell pad, fully upholstered shell and parallel stitching upholstery. Fire retardant version available. In upholstered versions the seat height increases 0.75 inches.

Silla apilable con carcasa de termopolímero Eco disponible en diferentes colores o termopolímero Pure Eco (100% reciclado) disponible en color arena y base de 4 patas de tubo de acero disponible en diferentes colores. Opciones disponibles: Asiento plafonado, asiento y respaldo plafonado, carcasa tapizada y tapizado con costuras paralelas. Versión ignífuga disponible. En versiones tapizadas la altura de asiento aumenta 20 mm.

COM cm. per unit	COL m2
------------------	--------

0,39 m3
33,2 kg
x4

Fully upholstered Carcasa tapizada

1 units	100	2,25
10 units or more	90	

Seat pad Asiento plafonado

1 units	50	1
10 units or more	25	

Shell pad Asiento y respaldo plafonado

1 units	70	1,5
10 units or more	65	

x10
x15

€



TP
178

Thermo-polymer shell
Carcasa termopolímero



Fully upholstered shell
Carcasa tapizada

COM	COL	1	2	3	4	5	6	7	8	9	10	11	L1	L2	L3	L6
307	317	328	338	345	358	370	383	396	408	421	434	449	461	524	613	860



Upholstered seat pad
Asiento plafonado

COM	COL	1	2	3	4	5	6	7	8	9	10	11	L1	L2	L3	L6
246	248	251	254	256	259	263	266	268	272	275	279	282	285	297	318	376



Upholstered shell pad
Asiento y respaldo plafonado

COM	COL	1	2	3	4	5	6	7	8	9	10	11	L1	L2	L3	L6
311	318	325	332	338	346	355	363	372	380	389	397	406	414	445	502	651



Parallel stitching upholstery upcharge (Seat and back)
Incremento tapizado con costuras paralelas (Asiento y respaldo) | 59 |



Parallel stitching upholstery upcharge (Seat)
Incremento tapizado con costuras paralelas (Asiento) | 30 |

SO1303



Stackable armchair with Eco thermo-polymer shell available in several colors or Pure Eco thermo-polymer (100% recycled) available in sand color and 4 tubular steel legs available in several colors. The upholstered version includes a stacking protector. Available options: Upholstered seat pad, upholstered shell pad, fully upholstered shell, parallel stitching upholstery and upholstered arms. Fire retardant version available. In upholstered versions the seat height increases 20 mm.

Sillón apilable con carcasa de termopolímero Eco disponible en diferentes colores o termopolímero Pure Eco (100% reciclado) disponible en color arena y base de 4 patas de tubo de acero disponible en diferentes colores. Opciones disponibles: Asiento plafonado, asiento y respaldo plafonado, carcasa tapizada, tapizado con costuras paralelas y brazos tapizados. Versión ignífuga disponible. En versiones tapizadas la altura de asiento aumenta 20 mm.

COM cm. per unit	COL m2
------------------	--------

0,37 m3
22,6 kg
x2

Fully upholstered Carcasa tapizada

1 units	100	2,25
10 units or more	90	

Seat pad Asiento plafonado

1 units	50	1
10 units or more	25	

Shell pad Asiento y respaldo plafonado

1 units	70	1,5
10 units or more	65	

x10
x15

€



TP
321

Thermo-polymer shell
Carcasa termopolímero



Fully upholstered shell
Carcasa tapizada

COM	COL	1	2	3	4	5	6	7	8	9	10	11	L1	L2	L3	L6
430	439	449	459	466	478	491	504	516	530	542	556	570	582	632	723	994



Upholstered seat pad
Asiento plafonado

COM	COL	1	2	3	4	5	6	7	8	9	10	11	L1	L2	L3	L6
399	402	405	408	411	413	416	420	423	428	430	433	437	440	451	474	536



Upholstered shell pad
Asiento y respaldo plafonado

COM	COL	1	2	3	4	5	6	7	8	9	10	11	L1	L2	L3	L6
464	471	478	485	491	499	508	516	526	535	543	552	560	569	600	660	823



Parallel stitching upholstery upcharge (Seat and back)
Incremento tapizado con costuras paralelas (Asiento y respaldo) | 59 |



Parallel stitching upholstery upcharge (Seat)
Incremento tapizado con costuras paralelas (Asiento) | 30 |



Upholstered arm upcharge
Incremento brazo tapizado | 42 |

SI1300

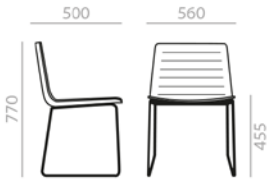

Stackable chair with Eco thermo-polymer shell available in several colors or Pure Eco thermo-polymer (100% recycled) available in sand color and a steel sled base finished in polished chrome, white or black. Available options: Upholstered seat pad, upholstered shell pad, fully upholstered hell and parallel stitching upholstery. Fire retardant version available, for further information contact our Sales Department. In upholstered versions the seat height increases 20 mm.

Silla apilable con carcasa de termopolímero Eco disponible en diferentes colores o termopolímero Pure Eco (100% reciclado) disponible en color arena y base de patín de varilla de acero en acabado cromo brillo, blanco o negro. Opciones disponibles: Asiento plafonado, asiento y respaldo plafonado, carcasa tapizada y tapizado con costuras paralelas. En versiones tapizadas la altura de asiento aumenta 20 mm.

COM cm. per unit	COL m2
------------------	--------

0,35 m3
35,6 kg
x4

Fully upholstered Carcasa tapizada		2,25
1 units	100	
10 units or more	90	

Seat pad Asiento plafonado		1
1 units	50	
10 units or more	25	

Shell pad Asiento y respaldo plafonado		1,5
1 units	70	
10 units or more	65	

10
20

€ TP
184



Thermo-polymer shell
Carcasa termopolímero



Fully upholstered shell
Carcasa tapizada



Upholstered seat pad
Asiento plafonado



Upholstered shell pad
Asiento y respaldo plafonado

COM	COL	1	2	3	4	5	6	7	8	9	10	11	L1	L2	L3	L6
338	348	359	369	377	391	403	417	430	444	458	473	490	502	559	659	927

COM	COL	1	2	3	4	5	6	7	8	9	10	11	L1	L2	L3	L6
251	252	255	258	260	263	266	270	272	275	279	282	285	287	299	319	374

COM	COL	1	2	3	4	5	6	7	8	9	10	11	L1	L2	L3	L6
316	323	330	337	342	350	358	367	376	384	392	400	408	417	446	502	649



Parallel stitching upholstery upcharge (Seat and back)
Incremento tapizado con costuras paralelas (Asiento y respaldo) | 59 |



Parallel stitching upholstery upcharge (Seat)
Incremento tapizado con costuras paralelas (Asiento) | 30 |

SO1301

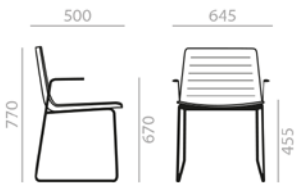

Stackable armchair with Eco thermo-polymer shell available in several colors or Pure Eco thermo-polymer (100% recycled) available in sand color and a steel sled base finished in polished chrome, white or black. The upholstered version includes a stacking protector. Available options: Upholstered seat pad, upholstered shell pad, fully upholstered shell, parallel stitching upholstery and upholstered arms. Fire retardant version available. In upholstered versions the seat height increases 20 mm.

Sillón apilable con carcasa de termopolímero Eco disponible en diferentes colores o termopolímero Pure Eco (100% reciclado) disponible en color arena y base de patín de varilla de acero en acabado cromo brillo, blanco o negro. Opciones disponibles: Asiento plafonado, asiento y respaldo plafonado, carcasa tapizada, tapizado con costuras paralelas y brazos tapizados. Incluido protector de apilado en la versión tapizada. Versión ignífuga disponible. En versiones tapizadas la altura de asiento aumenta 20 mm.

COM cm. per unit	COL m2
------------------	--------

0,32 m3
24,6 kg
x2

Fully upholstered Carcasa tapizada		2,25
1 units	100	
10 units or more	90	

Seat pad Asiento plafonado		1
1 units	50	
10 units or more	25	

Shell pad Asiento y respaldo plafonado		1,5
1 units	70	
10 units or more	65	

10
15

€ TP
289



Thermo-polymer shell
Carcasa termopolímero



Fully upholstered shell
Carcasa tapizada



Upholstered seat pad
Asiento plafonado



Upholstered shell pad
Asiento y respaldo plafonado

COM	COL	1	2	3	4	5	6	7	8	9	10	11	L1	L2	L3	L6
462	473	486	497	506	519	533	547	561	576	593	611	626	643	705	836	1.121

COM	COL	1	2	3	4	5	6	7	8	9	10	11	L1	L2	L3	L6
369	372	375	378	381	383	388	391	395	398	402	405	408	412	425	447	535

COM	COL	1	2	3	4	5	6	7	8	9	10	11	L1	L2	L3	L6
431	438	445	452	458	466	476	485	494	503	511	521	530	538	571	636	838



Parallel stitching upholstery upcharge (Seat and back)
Incremento tapizado con costuras paralelas (Asiento y respaldo) | 59 |



Parallel stitching upholstery upcharge (Seat)
Incremento tapizado con costuras paralelas (Asiento) | 30 |



Upholstered arm upcharge
Incremento brazo tapizado | 42 |

SI1359

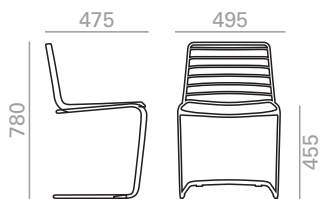

Chair with Eco thermo-polymer shell available in several colors or Pure Eco thermo-polymer (100% recycled) available in sand color and tubular steel cantilever base finished in polished chrome, white or black. Available options: Upholstered seat pad, upholstered shell pad, fully upholstered shell and parallel stitching upholstery. Fire retardant version available. In upholstered versions the seat height increases 20 mm.

Silla con carcasa de termopolímero Eco disponible en diferentes colores o termopolímero Pure Eco (100% reciclado) disponible en color arena y base cantiléver de tubo de acero en acabado cromo brillo, blanco o negro. Opciones disponibles: Asiento plafonado, asiento respaldo plafonado, carcasa tapizada y tapizado con costuras paralelas. Versión ignífuga disponible. En versiones tapizadas la altura de asiento aumenta 20 mm.

COM cm. per unit	COL m2
------------------	--------

0,25 m3
 44 kg
 x2

Fully upholstered Carcasa tapizada		
1 units	100	2,25
10 units or more	90	

Seat pad Asiento plafonado		
1 units	50	1
10 units or more	25	

Shell pad Asiento y respaldo plafonado		
1 units	70	1,5
10 units or more	65	

€ TP
325

Thermo-polymer shell
Carcasa termopolímero



Fully upholstered shell
Carcasa tapizada

COM	COL	1	2	3	4	5	6	7	8	9	10	11	L1	L2	L3	L6
453	464	477	488	498	513	528	544	558	574	589	604	619	634	688	789	1.054



Upholstered seat pad
Asiento plafonado

COM	COL	1	2	3	4	5	6	7	8	9	10	11	L1	L2	L3	L6
401	405	408	412	414	418	423	428	432	436	440	445	449	452	467	495	570



Upholstered shell pad
Asiento y respaldo plafonado

COM	COL	1	2	3	4	5	6	7	8	9	10	11	L1	L2	L3	L6
463	470	480	489	494	506	517	527	538	548	559	569	581	590	629	698	885



Parallel stitching upholstery upcharge (Seat and back)
Incremento tapizado con costuras paralelas (Asiento y respaldo) | 59 |



Parallel stitching upholstery upcharge (Seat)
Incremento tapizado con costuras paralelas (Asiento) | 30 |

SO1360

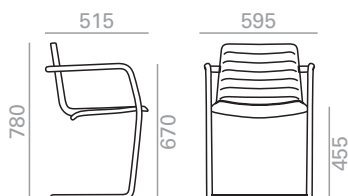

Armchair with Eco thermo-polymer shell available in several colors or Pure Eco thermo-polymer (100% recycled) available in sand color and tubular steel cantilever base finished in polished chrome, white or black. Available options: Upholstered seat pad, upholstered shell pad, fully upholstered shell, parallel stitching upholstery and upholstered arms. Fire retardant version available, for further information contact our Sales Department. In upholstered versions the seat height increases 20 mm.

Sillón con carcasa de termopolímero Eco disponible en diferentes colores o termopolímero Pure Eco (100% reciclado) disponible en color arena y base cantiléver de tubo de acero en acabado cromo brillo, blanco o negro. Opciones disponibles: Asiento plafonado, asiento y respaldo plafonado, carcasa tapizada, tapizado con costuras paralelas y brazos tapizados. Versión ignífuga disponible, para más información rogamos contacten con el Departamento Comercial. En versiones tapizadas la altura de asiento aumenta 20 mm.

COM cm. per unit	COL m2
------------------	--------

0,27 m3
 12,3 kg
 x1

Fully upholstered Carcasa tapizada		
1 units	100	2,25
10 units or more	90	

Seat pad Asiento plafonado		
1 units	50	1
10 units or more	25	

Shell pad Asiento y respaldo plafonado		
1 units	70	1,5
10 units or more	65	

€ TP
372

Thermo-polymer shell
Carcasa termopolímero



Fully upholstered shell
Carcasa tapizada

COM	COL	1	2	3	4	5	6	7	8	9	10	11	L1	L2	L3	L6
502	510	520	528	535	546	557	573	590	609	625	643	660	676	757	860	1.159



Upholstered seat pad
Asiento plafonado

COM	COL	1	2	3	4	5	6	7	8	9	10	11	L1	L2	L3	L6
450	453	454	457	458	461	465	468	471	474	476	479	482	485	501	533	632



Upholstered shell pad
Asiento y respaldo plafonado

COM	COL	1	2	3	4	5	6	7	8	9	10	11	L1	L2	L3	L6
539	546	553	560	565	574	582	590	599	607	616	626	636	644	681	755	976



Parallel stitching upholstery upcharge (Seat and back)
Incremento tapizado con costuras paralelas (Asiento y respaldo) | 59 |



Parallel stitching upholstery upcharge (Seat)
Incremento tapizado con costuras paralelas (Asiento) | 30 |



Upholstered arm upcharge
Incremento brazo tapizado | 42 |

SI1304

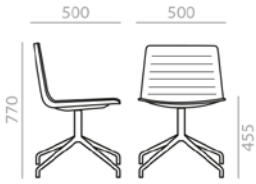

Chair with Eco thermo-polymer shell available in several colors or Pure Eco thermo-polymer (100% recycled) available in sand color and 4-star aluminum swivel central base and self-return system finished in polished aluminum, white or black. Optional 4 casters. Available options: Upholstered seat pad, upholstered shell pad, fully upholstered shell and parallel stitching upholstery. Fire retardant version available. In upholstered versions the seat height increases 20 mm.

Silla con carcasa de termopolímero Eco disponible en diferentes colores o termopolímero Pure Eco (100% reciclado) disponible en color arena y base central giratoria de aluminio de 4 aspas con sistema de retorno y acabado aluminio pulido, blanco o negro. Opciones disponibles: Asiento plafonado, asiento y respaldo plafonado, carcasa tapizada, tapizado con costuras paralelas y ruedas. Versión ignífuga disponible. En versiones tapizadas la altura de asiento aumenta 20 mm.

COM cm. per unit	COL m2
------------------	--------

0,24 m3
10 kg
x1

Fully upholstered Carcasa tapizada		
1 units	100	2,25
10 units or more	90	

Seat pad Asiento plafonado		
1 units	50	1
10 units or more	25	

Shell pad Asiento y respaldo plafonado		
1 units	70	1,5
10 units or more	65	

€ TP
372



Thermo-polymer shell
Carcasa termopolímero



Fully upholstered shell
Carcasa tapizada



Upholstered seat pad
Asiento plafonado



Upholstered shell pad
Asiento y respaldo plafonado

COM	COL	1	2	3	4	5	6	7	8	9	10	11	L1	L2	L3	L6
536	546	558	569	576	590	604	616	630	644	658	670	684	697	749	848	1.105
448	451	454	457	460	462	467	469	472	476	479	483	486	489	502	524	585
510	517	524	531	537	545	554	564	572	581	590	599	607	616	648	706	867



Optional casters.
(No swivel base).
Opción de ruedas.
(Base no giratoria).



Parallel stitching upholstery upcharge (Seat and back)
Incremento tapizado con costuras paralelas (Asiento y respaldo) | 59 |



Parallel stitching upholstery upcharge (Seat)
Incremento tapizado con costuras paralelas (Asiento) | 30 |

SO1305

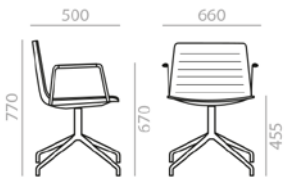

Armchair with Eco thermo-polymer shell available in several colors or Pure Eco thermo-polymer (100% recycled) available in sand color and 4-star aluminum swivel central base and self-return system finished in polished aluminum, white or black. Optional 4 casters. Available options: Upholstered seat pad, upholstered shell pad, fully upholstered shell, parallel stitching upholstery and upholstered arms. Fire retardant version available. In upholstered versions the seat height increases 20 mm.

Sillón con carcasa de termopolímero Eco disponible en diferentes colores o termopolímero Pure Eco (100% reciclado) disponible en color arena y base central giratoria de aluminio de 4 aspas con sistema de retorno y acabado aluminio pulido, blanco o negro. Opciones disponibles: Asiento plafonado, asiento y respaldo plafonado, carcasa tapizada, tapizado con costuras paralelas, brazos tapizados y ruedas. Versión ignífuga disponible. En versiones tapizadas la altura de asiento aumenta 20 mm.

COM cm. per unit	COL m2
------------------	--------

0,31 m3
11 kg
x1

Fully upholstered Carcasa tapizada		
1 units	100	2,25
10 units or more	90	

Seat pad Asiento plafonado		
1 units	50	1
10 units or more	25	

Shell pad Asiento y respaldo plafonado		
1 units	70	1,5
10 units or more	65	

€ TP
554



Thermo-polymer shell
Carcasa termopolímero



Fully upholstered shell
Carcasa tapizada



Upholstered seat pad
Asiento plafonado



Upholstered shell pad
Asiento y respaldo plafonado

COM	COL	1	2	3	4	5	6	7	8	9	10	11	L1	L2	L3	L6
729	738	749	759	766	779	792	803	816	829	842	853	866	877	923	1.006	1.238
663	665	668	671	673	676	680	683	687	690	694	696	700	703	715	737	795
704	711	718	725	729	738	748	756	764	773	781	790	798	805	836	892	1.040



Optional casters.
(No swivel base).
Opción de ruedas.
(Base no giratoria).



Parallel stitching upholstery upcharge (Seat and back)
Incremento tapizado con costuras paralelas (Asiento y respaldo) | 59 |



Parallel stitching upholstery upcharge (Seat)
Incremento tapizado con costuras paralelas (Asiento) | 30 |



Upholstered arm upcharge
Incremento brazo tapizado | 42 |

SI1306

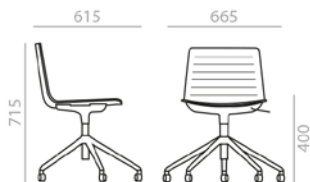

Chair with Eco thermo-polymer shell available in several colors or Pure Eco thermo-polymer (100% recycled) available in sand color and aluminum central swivel base with 5 casters, height adjustment and polished aluminum finish, white or black. Available options: Upholstered seat pad, upholstered shell pad, fully upholstered shell and parallel stitching upholstery. Fire retardant version available. Seat height range: 400-500 mm. In upholstered versions the seat height increases 20 mm.

Silla con carcasa de termopolímero Eco disponible en diferentes colores o termopolímero Pure Eco (100% reciclado) disponible en color arena y base central giratoria de aluminio con 5 ruedas, regulable en altura y acabado aluminio pulido, blanco o negro. Opciones disponibles: Asiento plafonado, asiento y respaldo plafonado, carcasa tapizada y tapizado con costuras paralelas. Versión ignífuga disponible. Rango de altura de asiento: 400-500 mm. En versiones tapizadas la altura de asiento aumenta 20 mm.

COM cm. per unit	COL m2
------------------	--------

0,29 m3
11 kg
x1

Fully upholstered Carcasa tapizada		2,25
1 units	100	
10 units or more	90	

Seat pad Asiento plafonado		1
1 units	50	
10 units or more	25	

Shell pad Asiento y respaldo plafonado		1,5
1 units	70	
10 units or more	65	

€ TP
367



Thermo-polymer shell
Carcasa termopolímero



Fully upholstered shell
Carcasa tapizada



Upholstered seat pad
Asiento plafonado



Upholstered shell pad
Asiento y respaldo plafonado

COM	COL	1	2	3	4	5	6	7	8	9	10	11	L1	L2	L3	L6
542	553	567	580	588	604	619	634	651	667	682	700	716	730	787	895	1.177
443	446	449	453	455	459	463	467	470	474	478	483	487	490	504	530	599
506	514	522	530	536	546	556	566	576	586	597	607	617	625	662	729	903



Parallel stitching upholstery upcharge (Seat and back)
Incremento tapizado con costuras paralelas (Asiento y respaldo) | 59



Parallel stitching upholstery upcharge (Seat)
Incremento tapizado con costuras paralelas (Asiento) | 30

SI1310

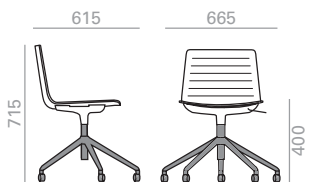

Chair with Eco thermo-polymer shell available in several colors or Pure Eco thermo-polymer (100% recycled) available in sand color and Eco thermo-polymer central base with 5 casters, swivel and pneumatic height adjustment, finished in black. Available options: Upholstered seat pad, upholstered shell pad, fully upholstered shell and parallel stitching upholstery. Fire retardant version available. In upholstered versions the seat height increases 20 mm.

Silla con carcasa de termopolímero Eco disponible en diferentes colores o termopolímero Pure Eco (100% reciclado) disponible en color arena y base central giratoria de termopolímero de 5 ruedas, regulable en altura y acabado negro. Opciones disponibles: Asiento plafonado, asiento y respaldo plafonado, carcasa tapizada y tapizado con costuras paralelas. Versión ignífuga disponible. En versiones tapizadas la altura de asiento aumenta 20 mm.

COM cm. per unit	COL m2
------------------	--------

0,32 m3
10 kg
x1

Fully upholstered Carcasa tapizada		2,25
1 units	100	
10 units or more	90	

Seat pad Asiento plafonado		1
1 units	50	
10 units or more	25	

Shell pad Asiento y respaldo plafonado		1,5
1 units	70	
10 units or more	65	

€ TP
231



Thermo-polymer shell
Carcasa termopolímero



Fully upholstered shell
Carcasa tapizada



Upholstered seat pad
Asiento plafonado



Upholstered shell pad
Asiento y respaldo plafonado

COM	COL	1	2	3	4	5	6	7	8	9	10	11	L1	L2	L3	L6
395	406	419	430	439	454	469	483	499	513	528	543	558	571	623	721	979
319	322	325	328	331	335	338	342	346	350	353	357	362	364	378	404	470
402	410	419	427	433	443	454	464	474	484	494	506	516	524	562	629	808



Parallel stitching upholstery upcharge (Seat and back)
Incremento tapizado con costuras paralelas (Asiento y respaldo) | 59



Parallel stitching upholstery upcharge (Seat)
Incremento tapizado con costuras paralelas (Asiento) | 30

SO1307

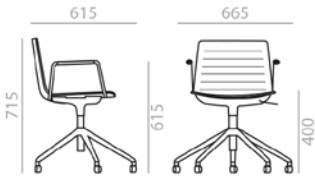

Armchair with Eco thermo-polymer shell available in several colors or Pure Eco thermo-polymer (100% recycled) available in sand color and aluminum central swivel base with 5 casters, height adjustment and polished aluminum finish, white or black. Available options: Upholstered seat pad, upholstered shell pad, fully upholstered shell, parallel stitching upholstery and upholstered arms. Fire retardant Height ranges: seat 400-500 mm./arms 615-715 mm. In upholstered versions the seat height increases 20 mm.

Sillón con carcasa de termopolímero Eco disponible en diferentes colores o termopolímero Pure Eco (100% reciclado) disponible en color arena y base central giratoria de aluminio con 5 ruedas, regulable en altura y acabado aluminio pulido, blanco o negro. Opciones disponibles: Asiento plafonado, asiento y respaldo plafonado, carcasa tapizada, tapizado con costuras paralelas y brazos tapizados. Versión ignífuga disponible. Rangos de altura: asiento 400-500 mm./brazos 615-715 mm. En versiones tapizadas la altura de asiento aumenta 20 mm.

COM cm. per unit	COL m2
------------------	--------

0,31 m3
11,5 kg
x1

Fully upholstered Carcasa tapizada		2,25
1 units	100	
10 units or more	90	

Seat pad Asiento plafonado		1
1 units	50	
10 units or more	25	

Shell pad Asiento y respaldo plafonado		1,5
1 units	70	
10 units or more	65	

€ TP
566



Thermo-polymer shell
Carcasa termopolímero



Fully upholstered shell
Carcasa tapizada



Upholstered seat pad
Asiento plafonado



Upholstered shell pad
Asiento y respaldo plafonado

COM	COL	1	2	3	4	5	6	7	8	9	10	11	L1	L2	L3	L6
730	740	752	763	771	785	798	812	826	841	856	869	883	897	949	1.044	1.294

COM	COL	1	2	3	4	5	6	7	8	9	10	11	L1	L2	L3	L6
673	675	678	682	684	688	692	694	699	703	705	710	714	716	730	755	821

COM	COL	1	2	3	4	5	6	7	8	9	10	11	L1	L2	L3	L6
736	743	751	759	765	774	784	793	803	813	822	832	841	851	885	950	1.118



Parallel stitching upholstery upcharge (Seat and back)
Incremento tapizado con costuras paralelas (Asiento y respaldo) | 59 |



Parallel stitching upholstery upcharge (Seat)
Incremento tapizado con costuras paralelas (Asiento) | 30 |



Upholstered arm upcharge
Incremento brazo tapizado | 42 |

SO1311

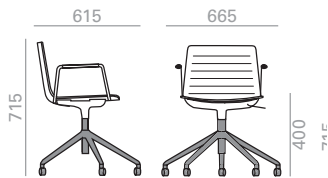

Armchair with Eco thermo-polymer shell available in several colors or Pure Eco thermo-polymer (100% recycled) available in sand color and Eco thermo-polymer central base with 5 casters, swivel and pneumatic height adjustment, finished in black. Available options: Upholstered seat pad, upholstered shell pad, fully upholstered shell and parallel stitching upholstery. Fire retardant version available. In upholstered versions the seat height increases 20 mm.

Sillón con carcasa de termopolímero Eco disponible en diferentes colores o termopolímero Pure Eco (100% reciclado) disponible en color arena y base central giratoria de termopolímero Eco de 5 ruedas, regulable en altura y acabado negro. Opciones disponibles: Asiento plafonado, asiento y respaldo plafonado, carcasa tapizada y tapizado con costuras paralelas. Versión ignífuga disponible. En versiones tapizadas la altura de asiento aumenta 20 mm.

COM cm. per unit	COL m2
------------------	--------

0,3 m3
10,5 kg
x1

Fully upholstered Carcasa tapizada		2,25
1 units	100	
10 units or more	90	

Seat pad Asiento plafonado		1
1 units	50	
10 units or more	25	

Shell pad Asiento y respaldo plafonado		1,5
1 units	70	
10 units or more	65	

€ TP
438



Thermo-polymer shell
Carcasa termopolímero



Fully upholstered shell
Carcasa tapizada



Upholstered seat pad
Asiento plafonado



Upholstered shell pad
Asiento y respaldo plafonado

COM	COL	1	2	3	4	5	6	7	8	9	10	11	L1	L2	L3	L6
583	594	608	621	629	645	661	679	698	716	736	755	773	788	853	974	1.296

COM	COL	1	2	3	4	5	6	7	8	9	10	11	L1	L2	L3	L6
527	531	534	538	541	545	549	554	558	562	566	570	575	579	593	621	695

COM	COL	1	2	3	4	5	6	7	8	9	10	11	L1	L2	L3	L6
610	618	628	636	644	655	666	678	689	699	710	721	733	743	784	857	1.052



Parallel stitching upholstery upcharge (Seat and back)
Incremento tapizado con costuras paralelas (Asiento y respaldo) | 59 |



Parallel stitching upholstery upcharge (Seat)
Incremento tapizado con costuras paralelas (Asiento) | 30 |



Upholstered arm upcharge
Incremento brazo tapizado | 42 |

BQ1308



Barstool 52. Barstool with Eco thermo-polymer shell available in several colors or Pure Eco thermo-polymer (100% recycled) available in sand color and 4 tubular steel legs and finished in polished chrome, white or black. Available options: Upholstered seat pad, upholstered shell pad, fully upholstered shell and parallel stitching upholstery. Fire retardant version available. In upholstered versions the seat height increases 20 mm.

Barstool 52. Banqueta alta con carcasa de termopolímero Eco disponible en diferentes colores o termopolímero Pure Eco (100% reciclado) disponible en color arena y base de 4 patas de tubo de acero en acabado cromo brillo, blanco o negro. Opciones disponibles: Asiento y respaldo plafonado, asiento y respaldo plafonado, carcasa tapizada y tapizado con costuras paralelas. Versión ignífuga disponible. En versiones tapizadas la altura de asiento aumenta 20 mm.

COM cm. per unit	COL m2
------------------	--------

0,33 m3
9,5 kg
x1

Fully upholstered Carcasa tapizada		
1 units	100	2,25
10 units or more	90	

Seat pad Asiento plafonado		
1 units	50	1
10 units or more	25	

Shell pad Asiento y respaldo plafonado		
1 units	70	1,5
10 units or more	65	

€ TP
251



Thermo-polymer shell
Carcasa termopolímero



Fully upholstered shell
Carcasa tapizada



Upholstered seat pad
Asiento plafonado



Upholstered shell pad
Asiento y respaldo plafonado

COM	COL	1	2	3	4	5	6	7	8	9	10	11	L1	L2	L3	L6
413	423	435	445	452	467	480	493	506	519	534	551	565	580	638	742	1.032
329	330	333	336	337	342	345	347	350	355	358	360	363	366	379	399	456
388	394	401	408	412	421	430	438	447	455	464	472	481	488	518	574	723



Parallel stitching upholstery upcharge (Seat and back)
Incremento tapizado con costuras paralelas (Asiento y respaldo) | 59 |



Parallel stitching upholstery upcharge (Seat)
Incremento tapizado con costuras paralelas (Asiento) | 30 |

BQ1309



Counter stool 52. Counter stool with Eco thermo-polymer shell available in several colors or Pure Eco thermo-polymer (100% recycled) available in sand color and 4 tubular steel legs and finished in polished chrome, white or black. Available options: Upholstered seat pad, upholstered shell pad, fully upholstered shell and parallel stitching upholstery. Fire retardant version available. In upholstered versions the seat height increases 20 mm.

Counter stool 52. Banqueta baja con carcasa de termopolímero Eco disponible en diferentes colores o termopolímero Pure Eco (100% reciclado) disponible en color arena y base de 4 patas de tubo de acero en acabado cromo brillo, blanco o negro. Opciones disponibles: Asiento y respaldo plafonado, asiento y respaldo plafonado, carcasa tapizada y tapizado con costuras paralelas. Versión ignífuga disponible. En versiones tapizadas la altura de asiento aumenta 20 mm.

COM cm. per unit	COL m2
------------------	--------

0,29 m3
8,5 kg
x1

Fully upholstered Carcasa tapizada		
1 units	100	2,25
10 units or more	90	

Seat pad Asiento plafonado		
1 units	50	1
10 units or more	25	

Shell pad Asiento y respaldo plafonado		
1 units	70	1,5
10 units or more	65	

€ TP
251



Thermo-polymer shell
Carcasa termopolímero



Fully upholstered shell
Carcasa tapizada



Upholstered seat pad
Asiento plafonado



Upholstered shell pad
Asiento y respaldo plafonado

COM	COL	1	2	3	4	5	6	7	8	9	10	11	L1	L2	L3	L6
413	423	435	445	452	467	480	493	506	519	534	551	565	580	638	742	1.032
329	330	333	336	337	342	345	347	350	355	358	360	363	366	379	399	456
388	394	401	408	412	421	430	438	447	455	464	472	481	488	518	574	723



Parallel stitching upholstery upcharge (Seat and back)
Incremento tapizado con costuras paralelas (Asiento y respaldo) | 59 |



Parallel stitching upholstery upcharge (Seat)
Incremento tapizado con costuras paralelas (Asiento) | 30 |

BQ1312

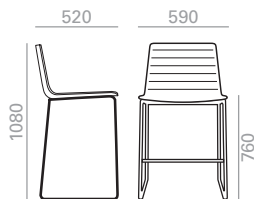

Barstool 52. Stackable barstool with Eco thermo-polymer shell available in several colors or Pure Eco thermo-polymer (100% recycled) available in sand color and a steel sled base and finished in polished chrome, white or black. The upholstered version includes a tacking protector. Available options: Upholstered seat pad, upholstered shell pad, fully upholstered shell and parallel stitching upholstery. Fire retardant version available. In upholstered versions the seat height increases 20 mm.

Barstool 52. Banqueta alta con carcasa de termopolímero Eco disponible en diferentes colores o termopolímero Pure Eco (100% reciclado) disponible en color arena y base de patín de varilla de acero en acabado cromo brillo, blanco o negro. Opciones disponibles: Asiento plafonado, asiento y respaldo plafonado, carcasa tapizada y tapizado con costuras paralelas. Incluido protector de apilado en la versión tapizada. Versión ignífuga disponible. En versiones tapizadas la altura de asiento aumenta 20 mm.

COM cm. per unit	COL m2
------------------	--------

0,35 m3
24 kg
x2

Fully upholstered Carcasa tapizada		
1 units	100	2,25
10 units or more	90	

Seat pad Asiento plafonado		
1 units	50	1
10 units or more	25	

Shell pad Asiento y respaldo plafonado		
1 units	70	1,5
10 units or more	65	



€ TP
259



Thermo-polymer shell
Carcasa termopolímero



Fully upholstered shell
Carcasa tapizada



Upholstered seat pad
Asiento plafonado



Upholstered shell pad
Asiento y respaldo plafonado

COM	COL	1	2	3	4	5	6	7	8	9	10	11	L1	L2	L3	L6
427	437	448	458	466	479	492	504	517	531	544	558	573	585	641	740	1.005
337	338	341	344	345	349	352	355	358	362	365	368	371	373	386	406	466
400	407	414	421	425	434	442	451	459	468	476	484	493	500	531	586	739



Parallel stitching upholstery upcharge (Seat and back)
Incremento tapizado con costuras paralelas (Asiento y respaldo) | 59



Parallel stitching upholstery upcharge (Seat)
Incremento tapizado con costuras paralelas (Asiento) | 30

BQ1313

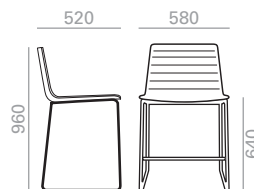

Counter stool 52. Stackable counter stool with Eco thermo-polymer shell available in several colors or Pure Eco thermo-polymer (100% recycled) available in sand color and a steel sled base and finished in polished chrome, white or black. Available options: Upholstered seat pad, upholstered shell pad, fully upholstered shell and parallel stitching upholstery. Fire retardant version available. In upholstered versions the seat height increases 20 mm.

Counter stool 52. Banqueta baja con carcasa de termopolímero Eco disponible en diferentes colores o termopolímero Pure Eco (100% reciclado) disponible en color arena y base de patín de varilla de acero en acabado cromo brillo, blanco o negro. Opciones disponibles: asiento plafonado, asiento y respaldo plafonado, carcasa tapizada y tapizado con costuras paralelas. Incluido protector de apilado en la versión tapizada. Versión ignífuga disponible. En versiones tapizadas la altura de asiento aumenta 20 mm.

COM cm. per unit	COL m2
------------------	--------

0,31 m3
15 kg
x2

Fully upholstered Carcasa tapizada		
1 units	100	2,25
10 units or more	90	

Seat pad Asiento plafonado		
1 units	50	1
10 units or more	25	

Shell pad Asiento y respaldo plafonado		
1 units	70	1,5
10 units or more	65	



€ TP
259



Thermo-polymer shell
Carcasa termopolímero



Fully upholstered shell
Carcasa tapizada



Upholstered seat pad
Asiento plafonado



Upholstered shell pad
Asiento y respaldo plafonado

COM	COL	1	2	3	4	5	6	7	8	9	10	11	L1	L2	L3	L6
427	437	448	458	466	479	492	504	517	531	544	558	573	585	641	740	1.005
337	338	341	344	345	349	352	355	358	362	365	368	371	373	386	406	466
400	407	414	421	425	434	442	451	459	468	476	484	493	500	531	586	739



Parallel stitching upholstery upcharge (Seat and back)
Incremento tapizado con costuras paralelas (Asiento y respaldo) | 59



Parallel stitching upholstery upcharge (Seat)
Incremento tapizado con costuras paralelas (Asiento) | 30

BQ1316

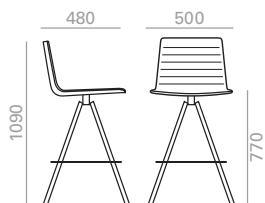

Barstool 52. Barstool with Eco thermo-polymer shell available in several colors or Pure Eco thermo-polymer (100% recycled) available in sand color and 4-legs steel swivel base and finished in polished chrome, white or black. Available options: Upholstered seat pad, upholstered shell pad, fully upholstered shell and parallel stitching upholstery. Fire retardant version available, for further information contact our Sales Department. In upholstered versions the seat height increases 20 mm.

Barstool 52. Banqueta alta con carcasa de termopolímero Eco disponible en diferentes colores o termopolímero Pure Eco (100% reciclado) disponible en color arena y base giratoria de 4 patas de acero y acabado cromo brillo, blanco o negro. Opciones disponibles: Asiento plafonado, asiento y respaldo plafonado, carcasa tapizada y tapizado con costuras paralelas. Versión ignífuga disponible, para más información rogamos contacten con el Departamento Comercial. En versiones tapizadas la altura de asiento aumenta 20 mm.

COM cm. per unit	COL m2
------------------	--------

0,29 m3
11,5 kg
x1

Fully upholstered Carcasa tapizada		
1 units	100	2,25
10 units or more	90	

Seat pad Asiento plafonado		
1 units	50	1
10 units or more	25	

Shell pad Asiento y respaldo plafonado		
1 units	70	1,5
10 units or more	65	

€ TP
340



Thermo-polymer shell
Carcasa termopolímero



Fully upholstered shell
Carcasa tapizada



Upholstered seat pad
Asiento plafonado



Upholstered shell pad
Asiento y respaldo plafonado

COM	COL	1	2	3	4	5	6	7	8	9	10	11	L1	L2	L3	L6
535	545	558	569	576	590	605	619	631	646	660	674	687	703	760	868	1.155

COM	COL	1	2	3	4	5	6	7	8	9	10	11	L1	L2	L3	L6
439	442	445	448	451	454	458	461	463	468	471	475	478	480	493	516	575

COM	COL	1	2	3	4	5	6	7	8	9	10	11	L1	L2	L3	L6
505	512	519	526	532	540	549	559	568	576	586	595	603	612	645	703	860

Parallel stitching upholstery upcharge (Seat and back)
Incremento tapizado con costuras paralelas (Asiento y respaldo) | 59 |



Parallel stitching upholstery upcharge (Seat)
Incremento tapizado con costuras paralelas (Asiento) | 30 |

BQ1317

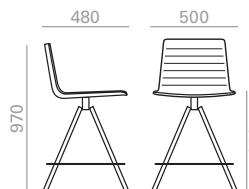

Counter stool 52. Counter stool with Eco thermo-polymer shell available in several colors or Pure Eco thermo-polymer (100% recycled) available in sand color and 4-legs steel swivel base and finished in polished chrome, white or black. Available options: Upholstered seat pad, upholstered shell pad, fully upholstered shell and parallel stitching upholstery. Fire retardant version available, for further information contact our Sales Department. In upholstered versions the seat height increases 20 mm.

Counter stool 52. Banqueta baja con carcasa de termopolímero Eco disponible en diferentes colores o termopolímero Pure Eco (100% reciclado) disponible en color arena y base giratoria de 4 patas de acero y acabado cromo brillo, blanco o negro. Opciones disponibles: asiento plafonado, asiento y respaldo plafonado, carcasa tapizada y tapizado con costuras paralelas. Versión ignífuga disponible, para más información rogamos contacten con el Departamento Comercial. En versiones tapizadas la altura de asiento aumenta 20 mm.

COM cm. per unit	COL m2
------------------	--------

0,28 m3
11 kg
x1

Fully upholstered Carcasa tapizada		
1 units	100	2,25
10 units or more	90	

Seat pad Asiento plafonado		
1 units	50	1
10 units or more	25	

Shell pad Asiento y respaldo plafonado		
1 units	70	1,5
10 units or more	65	

€ TP
340



Thermo-polymer shell
Carcasa termopolímero



Fully upholstered shell
Carcasa tapizada



Upholstered seat pad
Asiento plafonado



Upholstered shell pad
Asiento y respaldo plafonado

COM	COL	1	2	3	4	5	6	7	8	9	10	11	L1	L2	L3	L6
535	545	558	569	576	590	605	619	631	646	660	674	687	703	760	868	1.155

COM	COL	1	2	3	4	5	6	7	8	9	10	11	L1	L2	L3	L6
439	442	445	448	451	454	458	461	463	468	471	475	478	480	493	516	575

COM	COL	1	2	3	4	5	6	7	8	9	10	11	L1	L2	L3	L6
505	512	519	526	532	540	549	559	568	576	586	595	603	612	645	703	860

Parallel stitching upholstery upcharge (Seat and back)
Incremento tapizado con costuras paralelas (Asiento y respaldo) | 59 |



Parallel stitching upholstery upcharge (Seat)
Incremento tapizado con costuras paralelas (Asiento) | 30 |

BQ1325



Barstool 52. Barstool with Eco thermo-polymer shell available in several colors or Pure Eco thermo-polymer (100% recycled) available in sand color and injection swivel central base finished in polished aluminum, white or black. Available options: Upholstered seat pad, upholstered shell pad, fully upholstered shell and parallel stitching upholstery. Fire retardant version available, for further information contact our Sales Department. In upholstered versions the seat height increases 20 mm.

Barstool 52. Banqueta alta con carcasa de termopolímero Eco disponible en diferentes colores o termopolímero Pure Eco (100% reciclado) disponible en color arena y base central giratoria de inyección de aluminio en acabado aluminio pulido, blanco o negro. Opciones disponibles: Asiento plafonado, asiento y respaldo plafonado, carcasa tapizada y tapizado con costuras paralelas. Versión ignífuga disponible, para más información rogamos contacten con el Departamento Comercial. En versiones tapizadas la altura de asiento aumenta 20 mm.

COM cm. per unit	COL m2
------------------	--------

0,35 m3
14,3 kg
x1

Fully upholstered Carcasa tapizada		
1 units	100	2,25
10 units or more	90	

Seat pad Asiento plafonado		
1 units	50	1
10 units or more	25	

Shell pad Asiento y respaldo plafonado		
1 units	70	1,5
10 units or more	65	

€ TP
382

Thermo-polymer shell
Carcasa termopolímero



Fully upholstered shell
Carcasa tapizada

COM	COL	1	2	3	4	5	6	7	8	9	10	11	L1	L2	L3	L6
540	549	559	568	575	587	599	612	625	640	652	665	681	693	743	833	1.077



Upholstered seat pad
Asiento plafonado

COM	COL	1	2	3	4	5	6	7	8	9	10	11	L1	L2	L3	L6
446	449	450	453	454	457	461	464	466	469	472	475	478	480	491	511	560



Upholstered shell pad
Asiento y respaldo plafonado

COM	COL	1	2	3	4	5	6	7	8	9	10	11	L1	L2	L3	L6
521	527	534	541	545	552	561	569	576	585	592	600	609	616	647	714	889

Parallel stitching upholstery upcharge (Seat and back)
Incremento tapizado con costuras paralelas (Asiento y respaldo) | 59 |



Parallel stitching upholstery upcharge (Seat)
Incremento tapizado con costuras paralelas (Asiento) | 30 |

BQ1326



Counter stool 52. Counter stool with Eco thermo-polymer shell available in several colors or Pure Eco thermo-polymer (100% recycled) available in sand color and injection swivel central base finished in polished aluminum, white or black. Available options: Upholstered seat pad, upholstered shell pad, fully upholstered shell and parallel stitching upholstery. Fire retardant version available, for further information contact our Sales Department. In upholstered versions the seat height increases 20 mm.

Counter stool 52. Banqueta baja con carcasa de termopolímero Eco disponible en diferentes colores o termopolímero Pure Eco (100% reciclado) disponible en color arena y base central giratoria de inyección de aluminio en acabado aluminio pulido, blanco negro. Opciones disponibles: Asiento plafonado, asiento y respaldo plafonado, carcasa tapizada y tapizado con costuras paralelas. Versión ignífuga disponible, para más información rogamos contacten con el Departamento Comercial. En versiones tapizadas la altura de asiento aumenta 20 mm.

COM cm. per unit	COL m2
------------------	--------

0,3 m3
14,3 kg
x1

Fully upholstered Carcasa tapizada		
1 units	100	2,25
10 units or more	90	

Seat pad Asiento plafonado		
1 units	50	1
10 units or more	25	

Shell pad Asiento y respaldo plafonado		
1 units	70	1,5
10 units or more	65	

€ TP
382

Thermo-polymer shell
Carcasa termopolímero



Fully upholstered shell
Carcasa tapizada

COM	COL	1	2	3	4	5	6	7	8	9	10	11	L1	L2	L3	L6
540	549	559	568	575	587	599	612	625	640	652	665	681	693	743	833	1.077



Upholstered seat pad
Asiento plafonado

COM	COL	1	2	3	4	5	6	7	8	9	10	11	L1	L2	L3	L6
446	449	450	453	454	457	461	464	466	469	472	475	478	480	491	511	560



Upholstered shell pad
Asiento y respaldo plafonado

COM	COL	1	2	3	4	5	6	7	8	9	10	11	L1	L2	L3	L6
521	527	534	541	545	552	561	569	576	585	592	600	609	616	647	714	889

Parallel stitching upholstery upcharge (Seat and back)
Incremento tapizado con costuras paralelas (Asiento y respaldo) | 59 |



Parallel stitching upholstery upcharge (Seat)
Incremento tapizado con costuras paralelas (Asiento) | 30 |

BQ1327



Barstool 52. Barstool with Eco thermo-polymer shell available in several colors or Pure Eco thermo-polymer (100% recycled) available in sand color and injection swivel central base, adjustable height and finished in polished aluminum, white or black. Available options: Upholstered seat pad, upholstered shell pad, fully upholstered shell and parallel stitching upholstery. Fire retardant version available, for further information contact our Sales Department. Seat height range: 650-780 mm. In upholstered versions the seat height increases 20 mm.

Barstool 52. Banqueta alta con carcasa de termopolímero Eco disponible en diferentes colores o termopolímero Pure Eco (100% reciclado) disponible en color arena y base central giratoria de inyección de aluminio, regulable en altura y acabado aluminio pulido, blanco o negro. Opciones disponibles: Asiento plafonado, asiento y respaldo plafonado, carcasa tapizada y tapizado con costuras paralelas. Versión ignífuga disponible, para más información rogamos contacten con el Departamento Comercial. Rango de altura de asiento: 650-780 mm. En versiones tapizadas la altura de asiento aumenta 20 mm.

COM cm. per unit	COL m2
------------------	--------

0,3 m3
14,3 kg
x1

Fully upholstered Carcasa tapizada		2,25
1 units	100	
10 units or more	90	

Seat pad Asiento plafonado		1
1 units	50	
10 units or more	25	

Shell pad Asiento y respaldo plafonado		1,5
1 units	70	
10 units or more	65	

TP
389



Thermo-polymer shell
Carcasa termopolímero



Fully upholstered shell
Carcasa tapizada



Upholstered seat pad
Asiento plafonado



Upholstered shell pad
Asiento y respaldo plafonado

COM	COL	1	2	3	4	5	6	7	8	9	10	11	L1	L2	L3	L6
552	561	571	580	587	599	611	624	638	653	665	678	695	707	758	850	1.099

COM	COL	1	2	3	4	5	6	7	8	9	10	11	L1	L2	L3	L6
455	458	459	462	463	466	470	473	476	478	481	484	487	490	501	520	570

COM	COL	1	2	3	4	5	6	7	8	9	10	11	L1	L2	L3	L6
531	537	544	551	555	563	571	579	587	596	603	612	619	626	660	728	907

Parallel stitching upholstery upcharge (Seat and back)
Incremento tapizado con costuras paralelas (Asiento y respaldo) | 59 |



Parallel stitching upholstery upcharge (Seat)
Incremento tapizado con costuras paralelas (Asiento) | 30 |

BQ1330



Barstool 45. Barstool with Eco thermo-polymer shell available in several colors or Pure Eco thermo-polymer (100% recycled) available in sand color and 4 tubular steel legs and finished in polished chrome, white or black. Available options: Upholstered seat pad, upholstered shell pad, fully upholstered shell and parallel stitching upholstery. Fire retardant version available, for further information contact our Sales Department. In upholstered versions the seat height increases 20 mm.

Barstool 45. Banqueta alta con carcasa de termopolímero Eco disponible en diferentes colores o termopolímero Pure Eco (100% reciclado) disponible en color arena y base de 4 patas de tubo de acero en acabado cromo brillo, blanco o negro. Opciones disponibles: Asiento plafonado, asiento y respaldo plafonado, carcasa tapizada y tapizado con costuras paralelas. Versión ignífuga disponible, para más información rogamos contacten con el Departamento Comercial. En versiones tapizadas la altura de asiento aumenta 20 mm.

COM cm. per unit	COL m2
------------------	--------

0,32 m3
9,5 kg
x1

Fully upholstered Carcasa tapizada		2,25
1 units	100	
10 units or more	80	

Seat pad Asiento plafonado		1
1 units	50	
10 units or more	25	

Shell pad Asiento y respaldo plafonado		1,5
1 units	70	
10 units or more	65	

TP
225



Thermo-polymer shell
Carcasa termopolímero



Fully upholstered shell
Carcasa tapizada



Upholstered seat pad
Asiento plafonado



Upholstered shell pad
Asiento y respaldo plafonado

COM	COL	1	2	3	4	5	6	7	8	9	10	11	L1	L2	L3	L6
374	382	392	400	407	419	430	441	452	463	475	489	500	514	562	667	893

COM	COL	1	2	3	4	5	6	7	8	9	10	11	L1	L2	L3	L6
313	314	317	320	323	326	328	333	335	338	341	345	348	351	364	385	442

COM	COL	1	2	3	4	5	6	7	8	9	10	11	L1	L2	L3	L6
366	373	380	387	392	401	409	417	426	434	442	451	459	467	498	563	746

Parallel stitching upholstery upcharge (Seat and back)
Incremento tapizado con costuras paralelas (Asiento y respaldo) | 59 |



Parallel stitching upholstery upcharge (Seat)
Incremento tapizado con costuras paralelas (Asiento) | 30 |

BQ1331

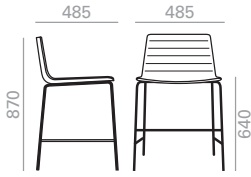

Counter stool 45. Counter stool with Eco thermo-polymer shell available in several colors or Pure Eco thermo-polymer (100% recycled) available in sand color and 4 tubular steel legs and finished in polished chrome, white or black. Available options: Upholstered seat pad, upholstered shell pad, fully upholstered shell and parallel stitching upholstery. Fire retardant version available, for further information contact our Sales Department. In upholstered versions the seat height increases 20 mm.

Counter stool 45. Banqueta baja con carcasa de termopolímero Eco disponible en diferentes colores o termopolímero Pure Eco (100% reciclado) disponible en color arena y base de 4 patas de tubo de acero en acabado cromo brillo, blanco o negro. Opciones disponibles: Asiento plafonado, asiento y respaldo plafonado, carcasa tapizada y tapizado con costuras paralelas. Versión ignífuga disponible, para más información rogamos contacten con el Departamento Comercial. En versiones tapizadas la altura de asiento aumenta 20 mm.

COM cm. per unit	COL m2
------------------	--------

0,27 m3
9,5 kg
x1

Fully upholstered Carcasa tapizada

1 units	100	2,25
10 units or more	80	

Seat pad Asiento plafonado

1 units	50	1
10 units or more	25	

Shell pad Asiento y respaldo plafonado

1 units	70	1,5
10 units or more	65	

€ TP
225



Thermo-polymer shell
Carcasa termopolímero



Fully upholstered shell
Carcasa tapizada



Upholstered seat pad
Asiento plafonado



Upholstered shell pad
Asiento y respaldo plafonado

COM	COL	1	2	3	4	5	6	7	8	9	10	11	L1	L2	L3	L6
374	382	392	400	407	419	430	441	452	463	475	489	500	514	562	667	893

COM	COL	1	2	3	4	5	6	7	8	9	10	11	L1	L2	L3	L6
313	314	317	320	323	326	328	333	335	338	341	345	348	351	364	385	442

COM	COL	1	2	3	4	5	6	7	8	9	10	11	L1	L2	L3	L6
366	373	380	387	392	401	409	417	426	434	442	451	459	467	498	563	746

Parallel stitching upholstery upcharge (Seat and back)
Incremento tapizado con costuras paralelas (Asiento y respaldo) | 59 |



Parallel stitching upholstery upcharge (Seat)
Incremento tapizado con costuras paralelas (Asiento) | 30 |



BQ1332



Barstool 45. Stackable barstool with Eco thermo-polymer shell available in several colors or Pure Eco thermo-polymer (100% recycled) available in sand color and a steel sled base and finished in polished chrome, white or black. The upholstered version includes a tacking protector. Available options: Upholstered seat pad, upholstered shell pad, fully upholstered shell and parallel stitching upholstery. Fire retardant version available, for further information contact our Sales Department. In upholstered versions the seat height increases 20 mm.

Barstool 45. Banqueta alta con carcasa de termopolímero Eco disponible en diferentes colores o termopolímero Pure Eco (100% reciclado) disponible en color arena y base de patín de varilla de acero en acabado cromo brillo, blanco o negro. Opciones disponibles: Asiento plafonado, asiento y respaldo plafonado, carcasa tapizada y tapizado con costuras paralelas. Incluido protector de apilado en la versión tapizada. Versión ignífuga disponible, para más información rogamos contacten con el Departamento Comercial. En versiones tapizadas la altura de asiento aumenta 20 mm.

COM cm. per unit	COL m2
------------------	--------

0,6 m3
24 kg
x2

Fully upholstered Carcasa tapizada

1 units	100	2,25
10 units or more	80	

Seat pad Asiento plafonado

1 units	50	1
10 units or more	25	

Shell pad Asiento y respaldo plafonado

1 units	70	1,5
10 units or more	65	

€ TP
260



Thermo-polymer shell
Carcasa termopolímero



Fully upholstered shell
Carcasa tapizada



Upholstered seat pad
Asiento plafonado



Upholstered shell pad
Asiento y respaldo plafonado

COM	COL	1	2	3	4	5	6	7	8	9	10	11	L1	L2	L3	L6
377	384	392	399	405	416	429	444	455	468	482	494	508	519	565	653	889

COM	COL	1	2	3	4	5	6	7	8	9	10	11	L1	L2	L3	L6
325	328	329	332	333	336	340	343	345	348	351	353	356	359	369	388	446

COM	COL	1	2	3	4	5	6	7	8	9	10	11	L1	L2	L3	L6
383	389	396	402	407	414	421	430	437	445	452	459	468	473	507	569	753

Parallel stitching upholstery upcharge (Seat and back)
Incremento tapizado con costuras paralelas (Asiento y respaldo) | 59 |



Parallel stitching upholstery upcharge (Seat)
Incremento tapizado con costuras paralelas (Asiento) | 30 |



BQ1333

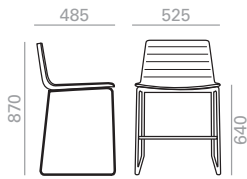

Counter stool 45. Stackable counter stool with Eco thermo-polymer shell available in several colors or Pure Eco thermo-polymer (100% recycled) available in sand color and a steel sled base and finished in polished chrome, white or black. The upholstered version includes a stacking protector. Available options: Upholstered seat pad, upholstered shell pad, fully upholstered shell and parallel stitching upholstery. Fire retardant version available, for further information contact our Sales Department. In upholstered versions the seat height increases 20 mm.

Counter stool 45. Banqueta baja con carcasa de termopolímero Eco disponible en diferentes colores o termopolímero Pure Eco (100% reciclado) disponible en color arena y base de patin de varilla de acero en acabado cromo brillo, blanco o negro. Opciones disponibles: asiento plafonado, asiento y respaldo plafonado, carcasa tapizada y tapizado con costuras paralelas. Incluido protector de apilado en la versión tapizada. Versión ignífuga disponible, para más información rogamos contacten con el Departamento Comercial. En versiones tapizadas la altura de asiento aumenta 20 mm.

COM cm. per unit	COL m2
------------------	--------

0,29 m3

15 kg

x2

8

Fully upholstered Carcasa tapizada		
1 units	100	2,25
10 units or more	80	

Seat pad Asiento plafonado		
1 units	50	1
10 units or more	25	

Shell pad Asiento y respaldo plafonado		
1 units	70	1,5
10 units or more	65	

€ TP
260

Thermo-polymer shell
Carcasa termopolímero



Fully upholstered shell
Carcasa tapizada

COM	COL	1	2	3	4	5	6	7	8	9	10	11	L1	L2	L3	L6
377	384	392	399	405	416	429	444	455	468	482	494	508	519	565	653	889



Upholstered seat pad
Asiento plafonado

COM	COL	1	2	3	4	5	6	7	8	9	10	11	L1	L2	L3	L6
325	328	329	332	333	336	340	343	345	348	351	353	356	359	369	388	446



Upholstered shell pad
Asiento y respaldo plafonado

COM	COL	1	2	3	4	5	6	7	8	9	10	11	L1	L2	L3	L6
383	389	396	402	407	414	421	430	437	445	452	459	468	473	507	569	753

Parallel stitching upholstery upcharge (Seat and back)
Incremento tapizado con costuras paralelas (Asiento y respaldo) | 59 |



Parallel stitching upholstery upcharge (Seat)
Incremento tapizado con costuras paralelas (Asiento) | 30 |

BQ1334

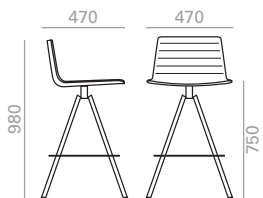

Barstool 45. Barstool with Eco thermo-polymer shell available in several colors or Pure Eco thermo-polymer (100% recycled) available in sand color and 4-legs steel swivel base and finished in polished chrome, white or black. Available options: Upholstered seat pad, upholstered shell pad, fully upholstered shell and parallel stitching upholstery. Fire retardant version available, for further information contact our Sales Department. In upholstered versions the seat height increases 20 mm.

Barstool 45. Banqueta alta con carcasa de termopolímero Eco disponible en diferentes colores o termopolímero Pure Eco (100% reciclado) disponible en color arena y base giratoria de 4 patas de acero y acabado cromo brillo, blanco o negro. Opciones disponibles: Asiento plafonado, asiento y respaldo plafonado, carcasa tapizada y tapizado con costuras paralelas. Versión ignífuga disponible, para más información rogamos contacten con el Departamento Comercial. En versiones tapizadas la altura de asiento aumenta 20 mm.

COM cm. per unit	COL m2
------------------	--------

0,27 m3

9,1 kg

x1

Fully upholstered Carcasa tapizada		
1 units	100	2,25
10 units or more	80	

Seat pad Asiento plafonado		
1 units	50	1
10 units or more	25	

Shell pad Asiento y respaldo plafonado		
1 units	70	1,5
10 units or more	65	

€ TP
306

Thermo-polymer shell
Carcasa termopolímero



Fully upholstered shell
Carcasa tapizada

COM	COL	1	2	3	4	5	6	7	8	9	10	11	L1	L2	L3	L6
490	500	510	520	527	538	551	562	573	586	597	609	623	637	687	781	1.061



Upholstered seat pad
Asiento plafonado

COM	COL	1	2	3	4	5	6	7	8	9	10	11	L1	L2	L3	L6
374	375	378	381	382	386	389	392	395	398	402	405	408	410	422	443	501



Upholstered shell pad
Asiento y respaldo plafonado

COM	COL	1	2	3	4	5	6	7	8	9	10	11	L1	L2	L3	L6
435	441	448	455	459	468	476	485	493	500	509	517	526	533	562	624	793

Parallel stitching upholstery upcharge (Seat and back)
Incremento tapizado con costuras paralelas (Asiento y respaldo) | 59 |



Parallel stitching upholstery upcharge (Seat)
Incremento tapizado con costuras paralelas (Asiento) | 30 |

BQ1335

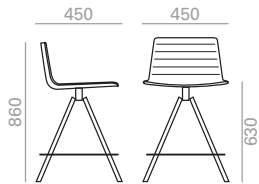

Counter stool 45. Counter stool with Eco thermo-polymer shell available in several colors or Pure Eco thermo-polymer (100% recycled) available in sand color and 4-legs steel swivel base and finished in polished chrome, white or black. Available options: Upholstered seat pad, upholstered shell pad, fully upholstered shell and parallel stitching upholstery. Fire retardant version available, for further information contact our Sales Department. In upholstered versions the seat height increases 20 mm.

Counter stool 45. Banqueta baja con carcasa de termopolímero Eco disponible en diferentes colores o termopolímero Pure Eco (100% reciclado) disponible en color arena y base giratoria de 4 patas de acero y acabado cromo brillo, blanco o negro. Opciones disponibles: asiento plafonado, asiento y respaldo plafonado, carcasa tapizada y tapizado con costuras paralelas. Versión ignífuga disponible, para más información rogamos contacten con el Departamento Comercial. En versiones tapizadas la altura de asiento aumenta 20 mm.

COM cm. per unit	COL m2
------------------	--------

0,23 m3
8,5 kg
x1

Fully upholstered Carcasa tapizada		
1 units	100	2,25
10 units or more	80	

Seat pad Asiento plafonado		
1 units	50	1
10 units or more	25	

Shell pad Asiento y respaldo plafonado		
1 units	70	1,5
10 units or more	65	



TP
306

Thermo-polymer shell
Carcasa termopolímero



Fully upholstered shell
Carcasa tapizada

COM	COL	1	2	3	4	5	6	7	8	9	10	11	L1	L2	L3	L6
490	500	510	520	527	538	551	562	573	586	597	609	623	637	687	781	1.061



Upholstered seat pad
Asiento plafonado

COM	COL	1	2	3	4	5	6	7	8	9	10	11	L1	L2	L3	L6
374	375	378	381	382	386	389	392	395	398	402	405	408	410	422	443	501



Upholstered shell pad
Asiento y respaldo plafonado

COM	COL	1	2	3	4	5	6	7	8	9	10	11	L1	L2	L3	L6
435	441	448	455	459	468	476	485	493	500	509	517	526	533	562	624	793



Parallel stitching upholstery upcharge (Seat and back)
Incremento tapizado con costuras paralelas (Asiento y respaldo) | 59



Parallel stitching upholstery upcharge (Seat)
Incremento tapizado con costuras paralelas (Asiento) | 30

BQ1315



Barstool 45. Barstool with Eco thermo-polymer shell available in several colors or Pure Eco thermo-polymer (100% recycled) available in sand color and injection swivel central base finished in polished aluminum, white or black. Available options: Upholstered seat pad, upholstered shell pad, fully upholstered shell and parallel stitching upholstery. Fire retardant version available. In upholstered versions the seat height increases 20 mm.

Barstool 45. Banqueta alta con carcasa de termopolímero Eco disponible en diferentes colores o termopolímero Pure Eco (100% reciclado) disponible en color arena y base central giratoria de inyección de aluminio en acabado aluminio pulido, blanco o negro. Opciones disponibles: Asiento plafonado, asiento y respaldo plafonado, carcasa tapizada y tapizado con costuras paralelas. Versión ignífuga disponible. En versiones tapizadas la altura de asiento aumenta 20 mm.

COM cm. per unit	COL m2
------------------	--------

0,26 m3
12,2 kg
x1

Fully upholstered Carcasa tapizada		
1 units	100	2,25
10 units or more	80	

Seat pad Asiento plafonado		
1 units	50	1
10 units or more	25	

Shell pad Asiento y respaldo plafonado		
1 units	70	1,5
10 units or more	65	



TP
329

Thermo-polymer shell
Carcasa termopolímero



Fully upholstered shell
Carcasa tapizada

COM	COL	1	2	3	4	5	6	7	8	9	10	11	L1	L2	L3	L6
497	505	514	523	529	540	551	564	578	592	605	619	634	644	694	783	1.019



Upholstered seat pad
Asiento plafonado

COM	COL	1	2	3	4	5	6	7	8	9	10	11	L1	L2	L3	L6
401	404	405	408	409	412	416	419	422	425	428	430	433	436	447	467	518



Upholstered shell pad
Asiento y respaldo plafonado

COM	COL	1	2	3	4	5	6	7	8	9	10	11	L1	L2	L3	L6
445	450	457	464	468	475	483	490	497	506	513	521	528	535	563	613	788



Parallel stitching upholstery upcharge (Seat and back)
Incremento tapizado con costuras paralelas (Asiento y respaldo) | 59



Parallel stitching upholstery upcharge (Seat)
Incremento tapizado con costuras paralelas (Asiento) | 30

BQ1318



Counter stool 45. Counter stool with Eco thermo-polymer shell available in several colors or Pure Eco thermo-polymer (100% recycled) available in sand color and injection swivel central base finished in polished aluminum, white or black. Available options: Upholstered seat pad, upholstered shell pad, fully upholstered shell and parallel stitching upholstery. Fire retardant version available, for further information contact our Sales Department. In upholstered versions the seat height increases 20 mm.

Counter stool 45. Banqueta baja con carcasa de termopolímero Eco disponible en diferentes colores o termopolímero Pure Eco (100% reciclado) disponible en color arena y base central giratoria de inyección de aluminio en acabado aluminio pulido, blanco negro. Opciones disponibles: Asiento plafonado, asiento y respaldo plafonado, carcasa tapizada y tapizado con costuras paralelas. Versión ignífuga disponible, para más información rogamos contacten con el Departamento Comercial. En versiones tapizadas la altura de asiento aumenta 20 mm.

COM cm. per unit	COL m2
------------------	--------

0,23 m3
12,2 kg
x1

Fully upholstered Carcasa tapizada		2,25
1 units	100	
10 units or more	80	

Seat pad Asiento plafonado		1
1 units	50	
10 units or more	25	

Shell pad Asiento y respaldo plafonado		1,5
1 units	70	
10 units or more	65	

€  TP
329

Thermo-polymer shell
Carcasa termopolímero



Fully upholstered shell
Carcasa tapizada

COM	COL	1	2	3	4	5	6	7	8	9	10	11	L1	L2	L3	L6
497	505	514	523	529	540	551	564	578	592	605	619	634	644	694	783	1.019



Upholstered seat pad
Asiento plafonado

COM	COL	1	2	3	4	5	6	7	8	9	10	11	L1	L2	L3	L6
401	404	405	408	409	412	416	419	422	425	428	430	433	436	447	467	518



Upholstered shell pad
Asiento y respaldo plafonado

COM	COL	1	2	3	4	5	6	7	8	9	10	11	L1	L2	L3	L6
445	450	457	464	468	475	483	490	497	506	513	521	528	535	563	613	788

 Parallel stitching upholstery upcharge (Seat and back)
Incremento tapizado con costuras paralelas (Asiento y respaldo) | 59 |

 Parallel stitching upholstery upcharge (Seat)
Incremento tapizado con costuras paralelas (Asiento) | 30 |

BQ1319



Barstool 45. Barstool with Eco thermo-polymer shell available in several colors or Pure Eco thermo-polymer (100% recycled) available in sand color and injection swivel central base, adjustable height and finished in polished aluminum, white or black. Available options: Upholstered seat pad, upholstered shell pad, fully upholstered shell and parallel stitching upholstery. Fire retardant version available, for further information contact our Sales Department. Seat height range: 630-760 mm. In upholstered versions the seat height increases 20 mm.

Barstool 45. Banqueta alta con carcasa de termopolímero Eco disponible en diferentes colores o termopolímero Pure Eco (100% reciclado) disponible en color arena y base central giratoria de inyección de aluminio, regulable en altura y acabado aluminio pulido, blanco negro. Opciones disponibles: Asiento plafonado, asiento y respaldo plafonado, carcasa tapizada y tapizado con costuras paralelas. Versión ignífuga disponible, para más información rogamos contacten con el Departamento Comercial. Rango de altura de asiento: 630-760 mm. En versiones tapizadas la altura de asiento aumenta 20 mm.

COM cm. per unit	COL m2
------------------	--------

0,23 m3
12,2 kg
x1

Fully upholstered Carcasa tapizada		2,25
1 units	100	
10 units or more	80	

Seat pad Asiento plafonado		1
1 units	50	
10 units or more	25	

Shell pad Asiento y respaldo plafonado		1,5
1 units	70	
10 units or more	65	

€  TP
335

Thermo-polymer shell
Carcasa termopolímero



Fully upholstered shell
Carcasa tapizada

COM	COL	1	2	3	4	5	6	7	8	9	10	11	L1	L2	L3	L6
503	511	520	529	535	546	557	571	583	599	612	624	640	651	699	790	1.026



Upholstered seat pad
Asiento plafonado

COM	COL	1	2	3	4	5	6	7	8	9	10	11	L1	L2	L3	L6
411	414	415	418	419	422	426	429	432	435	438	441	443	446	458	478	529



Upholstered shell pad
Asiento y respaldo plafonado

COM	COL	1	2	3	4	5	6	7	8	9	10	11	L1	L2	L3	L6
456	462	469	476	480	487	496	503	511	518	526	533	542	549	575	627	797

 Parallel stitching upholstery upcharge (Seat and back)
Incremento tapizado con costuras paralelas (Asiento y respaldo) | 59 |

 Parallel stitching upholstery upcharge (Seat)
Incremento tapizado con costuras paralelas (Asiento) | 30 |

BQ1336



Barstool 45. Barstool with Eco thermo-polymer shell available in several colors or Pure Eco thermo-polymer (100% recycled) available in sand color and 4-legs solid beech wood base. Available options: Upholstered seat pad, upholstered shell pad, fully upholstered hell and parallel stitching upholstery. Fire retardant version available, for further information contact our Sales Department. In upholstered versions the seat height increases 20 mm.

Barstool 45. Banqueta alta con carcasa de termopolímero Eco disponible en diferentes colores o termopolímero Pure Eco (100% reciclado) disponible en color arena y base de 4 patas de madera maciza de haya. Opciones disponibles: Asiento plafonado, asiento y respaldo plafonado, carcasa tapizada y tapizado con costuras paralelas. Versión ignífuga disponible, para más información rogamos contacten con el Departamento Comercial. En versiones tapizadas la altura de asiento aumenta 20 mm.

COM cm. per unit	COL m2
------------------	--------

0,28 m3

10 kg

x1

Fully upholstered Carcasa tapizada		2,25
1 units	100	
10 units or more	80	

Seat pad Asiento plafonado		1
1 units	50	
10 units or more	25	

Shell pad Asiento y respaldo plafonado		1,5
1 units	70	
10 units or more	65	

€ TP
434

Thermo-polymer shell
Carcasa termopolímero



Fully upholstered shell
Carcasa tapizada

COM	COL	1	2	3	4	5	6	7	8	9	10	11	L1	L2	L3	L6
622	631	639	647	653	663	674	684	694	705	714	724	736	746	790	873	1.097



Upholstered seat pad
Asiento plafonado

COM	COL	1	2	3	4	5	6	7	8	9	10	11	L1	L2	L3	L6
521	524	525	528	529	532	536	538	541	544	546	549	552	555	565	584	635



Upholstered shell pad
Asiento y respaldo plafonado

COM	COL	1	2	3	4	5	6	7	8	9	10	11	L1	L2	L3	L6
585	590	597	604	608	616	623	631	637	646	654	660	668	675	703	758	904

SERIE 600 | Matte lacquered and premium upcharge
Incremento por lacado mate y premium | 47 |

SERIE 800 | Bright lacquered upcharge
Incremento por lacado brillo | 69 |



Parallel stitching upholstery upcharge
(Seat and back)
Incremento tapizado con costuras paralelas (Asiento y respaldo) | 59 |



Parallel stitching upholstery upcharge
(Seat)
Incremento tapizado con costuras paralelas (Asiento) | 30 |

BQ1337

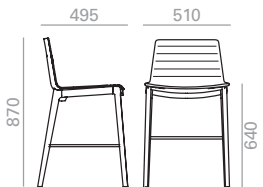

Counter stool 45. Counter stool with Eco thermo-polymer shell available in several colors or Pure Eco thermo-polymer (100% recycled) available in sand color and 4-legs solid beech wood base. Available options: Upholstered seat pad, upholstered shell pad, fully upholstered shell and parallel stitching upholstery. Fire retardant version available, for further information contact our Sales Department. In upholstered versions the seat height increases 20 mm.

Counter stool 45. Banqueta baja con carcasa de termopolímero Eco disponible en diferentes colores o termopolímero Pure Eco (100% reciclado) disponible en color arena y base de 4 patas de madera maciza de haya. Opciones disponibles: Asiento plafonado, asiento y respaldo plafonado, carcasa tapizada y tapizado con costuras paralelas. Versión ignífuga disponible, para más información rogamos contacten con el Departamento Comercial. En versiones tapizadas la altura de asiento aumenta 20 mm.

COM cm. per unit	COL m2
------------------	--------

0,23 m3

7,5 kg

x1

Fully upholstered Carcasa tapizada		2,25
1 units	100	
10 units or more	80	

Seat pad Asiento plafonado		1
1 units	50	
10 units or more	25	

Shell pad Asiento y respaldo plafonado		1,5
1 units	70	
10 units or more	65	

€ TP
434

Thermo-polymer shell
Carcasa termopolímero



Fully upholstered shell
Carcasa tapizada

COM	COL	1	2	3	4	5	6	7	8	9	10	11	L1	L2	L3	L6
622	631	639	647	653	663	674	684	694	705	714	724	736	746	790	873	1.097



Upholstered seat pad
Asiento plafonado

COM	COL	1	2	3	4	5	6	7	8	9	10	11	L1	L2	L3	L6
521	524	525	528	529	532	536	538	541	544	546	549	552	555	565	584	635



Upholstered shell pad
Asiento y respaldo plafonado

COM	COL	1	2	3	4	5	6	7	8	9	10	11	L1	L2	L3	L6
585	590	597	604	608	616	623	631	637	646	654	660	668	675	703	758	904

SERIE 600 | Matte lacquered and premium upcharge
Incremento por lacado mate y premium | 47 |

SERIE 800 | Bright lacquered upcharge
Incremento por lacado brillo | 69 |



Parallel stitching upholstery upcharge
(Seat and back)
Incremento tapizado con costuras paralelas (Asiento y respaldo) | 59 |



Parallel stitching upholstery upcharge
(Seat)
Incremento tapizado con costuras paralelas (Asiento) | 30 |

SI1314

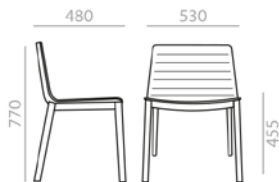

Chair with Eco thermo-polymer shell available in several colors or Pure Eco thermo-polymer (100% recycled) available in sand color and a 4-legs solid beech wood base. Available options: Upholstered seat pad, upholstered shell pad, fully upholstered shell and parallel stitching upholstery. Fire retardant version available, for further information contact our Sales Department. In upholstered versions the seat height increases 20 mm.

Silla con carcasa de termopolímero Eco disponible en diferentes colores o termopolímero Pure Eco (100% reciclado) disponible en color arena y base de 4 patas de madera maciza de haya. Opciones disponibles: Asiento plafonado, asiento y respaldo plafonado, carcasa tapizada y tapizado con costuras paralelas. Versión ignífuga disponible, para más información rogamos contacten con el Departamento Comercial. En versiones tapizadas la altura de asiento aumenta 20 mm.

COM cm. per unit	COL m2
------------------	--------

0,35 m3
 14,5 kg
 x2

Fully upholstered Carcasa tapizada		
1 units	100	2,25
10 units or more	90	

Seat pad Asiento plafonado		
1 units	50	1
10 units or more	25	

Shell pad Asiento y respaldo plafonado		
1 units	70	1,5
10 units or more	65	

€ TP
283

Thermo-polymer shell
Carcasa termopolímero



Fully upholstered shell
Carcasa tapizada

COM	COL	1	2	3	4	5	6	7	8	9	10	11	L1	L2	L3	L6
452	461	472	482	489	501	514	527	539	552	565	576	589	600	645	728	965



Upholstered seat pad
Asiento plafonado

COM	COL	1	2	3	4	5	6	7	8	9	10	11	L1	L2	L3	L6
371	372	375	378	379	383	386	389	392	396	399	402	405	408	419	440	494



Upholstered shell pad
Asiento y respaldo plafonado

COM	COL	1	2	3	4	5	6	7	8	9	10	11	L1	L2	L3	L6
432	438	445	452	456	465	473	482	490	497	506	514	523	530	559	614	759

SERIE 600
Matte lacquered and premium upcharge
Incremento por lacado mate y premium | 32

SERIE 800
Bright lacquered upcharge
Incremento por lacado brillo | 47

Parallel stitching upholstery upcharge
(Seat and back)
Incremento tapizado con costuras paralelas (Asiento y respaldo) | 59

Parallel stitching upholstery upcharge
(Seat)
Incremento tapizado con costuras paralelas (Asiento) | 30

Flex Chair accessories / Accesorios Flex Chair

0,01 m3
 3,2 kg
 1

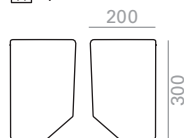

Removable right and left desk accessory for SI-1300, SI-1302 chairs with panic latch rotation. HPL finished in polished chrome, black or white surface 4-leg frames with writing supports can be stacked up to 4 units deep.

Pala de escritura derecha e izquierda desmontable para sillas SI-1300, SI-1302 con rotación antipánico. Tablero HPL acabado en cromo brillo, blanco o negro. Las estructuras de 4 patas con pala apilan hasta un máximo de 4 unidades.

DR-0802
Right Derecha € 97

DL-0803
Left Izquierda € 97

0,0029 m3
 0,2 kg
 1

LD0807
4 legs frame Estructura 4 patas € 15
SI1302

0,0043 m3
 0,3 kg
 1

LD0809
4 legs frame Estructura 4 patas € 16
SO1303

LD0808
Sled base frame Estructura de patín € 15
SI1300

LD0810
Sled base frame Estructura de patín € 16
SO1301

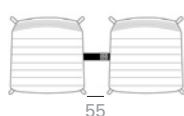

Removable thermo-polymer linking device of available for chairs.

Sistema de unión de Termopolímero desmontable válido para sillas. Se puede ocultar debajo del asiento.

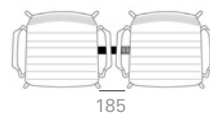

Removable thermo-polymer linking device of available for armchairs.

Sistema de unión de Termopolímero desmontable válido para sillones. Se puede ocultar debajo del asiento.

0,0018 m3
 0,1 kg
 1

ND0845
€ 11

0,0029 m3
 0,2 kg
 1

LD0858
Sled base frame Estructura de patín € 17
SI1300



Numbering device. Consult with Customer Department to customize the project.

Pieza de numeración para el sistema de unión que permite identificar las sillas. Consultar con el Departamento Comercial para personalizar el proyecto.

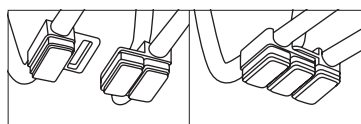

Sliding glide with union system.
Sistema de taco deslizante con sistema de unión incorporado.

Glides for sled bases/cantilever. Tacos para bases de patín/cantilever.

Use/Usó	Reference/Referencia	Material/Material	Price/Precio
Hard floors. Suelos duros.	TS0531	Plastic (PE). Plástico (PE).	0 € Standard. Estándar.
Wooden and delicate floors. Suelos de madera y delicados.	TS0538	Plastic (PE) with felt. Plástico (PE) con fieltro.	6 € Set of 4 glides. Juego de 4 tacos.
Mats/carpet floors. Suelos de moqueta/ alfombra.	TS0537	No glide. Sin taco.	0 €

The indicated price is for glides placed on chairs. To order loose parts, please ask to our Sales Department.

El precio indicado en Tarifa es para tacos colocados en las sillas. Para pedidos de tacos sueltos de repuesto, consultar con el Departamento Comercial.

Glides for central base. Tacos para base central.

Use/Usó	Reference/Referencia	Material/Material	Price/Precio
Hard floors. Suelos duros.	TS0539	Plastic (PE). Plástico (PE).	0 € Standard. Estándar.
Wooden and delicate floors. Suelos de madera y delicados.	TS0533	Plastic (PE) with felt. Plástico (PE) con fieltro.	3 € Set of 4 glides. Juego de 4 tacos.
Mats/carpet floors. Suelos de moqueta/ alfombra.	TS0543	Metal. Metal.	3 €

Glides for 4 metal legs base. Tacos para bases de 4 patas metálicas.

Use/Usó	Reference/Referencia	Material/Material	Price/Precio
Hard floors. Suelos duros.	TS0558	Plastic (PE). Plástico (PE).	0 € Standard. Estándar.
Wooden and delicate floors. Suelos de madera y delicados.	TS0534	Plastic (PE) with felt. Plástico (PE) con fieltro.	4 € Set of 4 glides. Juego de 4 tacos.
Mats/carpet floors. Suelos de moqueta/ alfombra.	TS0559	Metal. Metal.	4 € Set of 4 glides. Juego de 4 tacos.



Glides for 4 steel legs with swivel base. Tacos para base giratoria de 4 patas de acero.

Use/Usó	Reference/Referencia		Material/Material	Price/Precio	
Hard floors and mats/ carpet floors. Suelos duros y moqueta/alfombra.	TS0416		Plastic (PE). Plástico (PE).	0 €	Standard. Estándar.
Wooden and delicated floors. Suelos de madera y delicados.	TS0417		Plastic (PE) with felt. Plástico (PE) con fieltro.	12 €	Set of 4 glides. Juego de 4 tacos.

The indicated price is for glides placed on chairs. To order loose parts, please ask to our Sales Department.

El precio indicado en Tarifa es para tacos colocados en las sillas. Para pedidos de tacos sueltos de repuesto, consultar con el Departamento Comercial.

Glides for cantilever base. Tacos para base cantiléver.

Use/Usó	Reference/Referencia		Material/Material	Price/Precio	
Hard floors. Suelos duros.	TS0545		Plastic (PE). Plástico (PE).	0 €	Standard. Estándar.
Wooden and delicated floors. Suelos de madera y delicados.	TS0546		Plastic (PE) with felt. Plástico (PE) con fieltro.	6 €	Set of 4 glides. Juego de 4 tacos.
Mats/carpet floors. Suelos de moqueta/ alfombra.	TS0547		No glide. Sin taco.	0 €	

For wooden legs. Para bases de madera.



Optional glides on page 482.

Opciones de tacos deslizantes en página 482.

Casters. Ruedas.



Standard.
Estándar.

CA5004

Metallic trolley for transport stackable seating.
Carro metálico para transportar asientos apilables.

 0,39 m3

 14 kg

 x1



€ 216

Flex Chair stackability



SI1300 AU SOL
10 unités
560 x 850 x 1260 mm.

Tapissé
5 unités
560 x 562 x 950 mm.

SUR CHARRIOT
20 unités
560 x 850 x 1260 mm.

Tapissé
10 unités
560 x 562 x 950 mm.



SO1301 AU SOL
10 unités
640 x 850 x 1260 mm.

Tapissé
5 unités
640 x 620 x 950 mm.

SUR CHARRIOT
15 unités
560 x 850 x 1260 mm.

Tapissé
8 unités
640 x 620 x 950 mm.



SI1302 AU SOL
10 unités
560 x 850 x 1260 mm.

Tapissé
5 unités
560 x 620 x 950 mm.

SUR CHARRIOT
15 unités
560 x 850 x 1260 mm.

Tapissé
8 unités
560 x 620 x 950 mm.



SO1303 AU SOL
10 unités
640 x 850 x 1260 mm.

Tapissé
5 unités
640 x 620 x 950 mm.

SUR CHARRIOT
15 unités
560 x 850 x 1260 mm.

Tapissé
8 unités
640 x 620 x 950 mm.



BQ1312 AU SOL
8 unités
600 x 730 x 1275 mm.

Tapissé
4 unités
600 x 640 x 1205 mm.



BQ1313 AU SOL
8 unités
590 x 730 x 1145 mm.

Tapissé
4 unités
590 x 640 x 1075 mm.



Description
Descripción

Chairs, armchairs and stools with Eco thermopolymer seat and backrest available in different colors or Pure Eco thermopolymer (100% recycled content) available in sand color and upholstered seat and backrest option. The available bases for chairs and armchairs are: steel rod sled or cantilever finished in polished chrome, white or black, 4 steel tube legs available in different colors, central swivel aluminum base with self-return system and height-adjustable version, or fixed central base with 4 casters, with or without arms, finished in polished aluminum, white or black, tilting mechanism version available. Chair version with 4-legged solid beech base. The available stool bases are: central swivel base with 4 legs or 4 steel tube legs and polished chrome, white or black finish, injected aluminum central swivel base in polished aluminum, white or black finish or base with 4 solid beech legs. The stools are offered in 2 different heights and widths. Stacking protector included in upholstered versions. Available options: padded seat, padded seat and backrest, upholstered shell and upholstered with parallel seams. Flame retardant version available, for more information please contact the Sales Department.

Sillas, sillones y banquetas con asiento y respaldo de termopolímero Eco disponible en diferentes colores o termopolímero Pure Eco (100% reciclado) disponible en color arena y opción de asiento y respaldo tapizado. Las bases disponibles de sillas y sillones son: patín de varilla o cantiléver en acero y acabado cromo brillo, blanco o negro, 4 patas de tubo de acero disponible en diferentes colores, base central giratoria de aluminio con sistema de retorno y versión regulable en altura, o base central fija de 4 ruedas, con o sin brazos, en acabado aluminio pulido, blanco o negro, disponible versión basculante. Versión de silla con base de 4 patas de madera maciza de haya. Las bases disponibles de banquetas son: base central giratoria de 4 patas o 4 patas de tubo en acero y acabado cromo brillo, blanco o negro, base central giratoria de aluminio inyectado en acabado aluminio pulido, blanco o negro o base de 4 patas de madera maciza de haya. Las banquetas se ofrecen en 2 alturas y anchos diferentes. Incluido protector de apliado en las versiones tapizadas. Opciones disponibles: asiento plafonado, asiento y respaldo plafonado, carcasa tapizada y tapizado con costuras paralelas. Versión ignífuga disponible, para más información rogamos contacten con el Departamento Comercial.

Upholstery
Tapicería

The Flex High Back collection supports following upholsteries of Andreu World Catalogue. All upholstered versions are made with 100% recycled Pure Eco thermo-polymer. For fabrics in our catalogue not specified in this box or customers own materials please contact our Customer Service Department.

La colección Flex High Back admite las siguientes tapicerías del catálogo de Andreu World. Todas las versiones tapizadas están hechas con termopolímero Pure Eco 100% reciclado. Para las telas de nuestro catálogo no indicadas en este cuadro o telas cliente

Fabrics / Telas

- 1 Jacquard One
- Jacquard Three
- Sand
- Era
- Main Line Flux
- Loom Two (in/out)
- Mezzo
- Reel two (in/out)
- Jacquard Five
- Spin One
- Spin Two
- Spin Three
- Spin Four
- Spin Five

- 3 Jacquard Four
- Medley
- Revive 1
- Main Line Flux
- Loom Two (in/out)
- Mezzo
- Reel two (in/out)
- Jacquard Five

- 4 Jacquard 4 Special
- Nexus
- *Remix 3
- Heritage
- Savane
- Loom Three
- Loom Four
- Cura
- Oceanic
- Reel Three (in/out)
- Reel Four (in/out)
- Reflect
- Spin Six

- 5 Silk
- Synergy
- Step
- Step Melange
- Blazer
- Melange Nap
- Chili
- Noma
- Re-wool

- 6 Go check
- Swing
- Chartres
- Zori
- Patio
- Tack Two (in/out)
- Tack Three (in/out)

- 7 Canvas 2
- Select
- Clara 2
- Tack Five (in/out)
- Hero 2

- 8 Capture
- Fiord 2
- Tonus 4
- Divina 3
- Lopi
- Domino
- Atrium
- 9 Divina MD
- Divina Melange 3
- Hallingdal 65
- Steelcut Trio 3
- Tack Four (in/out)

- 11 Arda
- Ecriture
- Zero

Faux Leather / Ecopiel

- 1 Valencia
- 2 Silvertex
- 3 Maglia

8 Ultraleather

- 9 Brisa
- Brisa Distressed
- Fresco
- Ultraleather Pro
- Promessa

10 Tottori

- Coast (in/out)

11 Reef Pro

- Voliar Bio

Leather / Piel

- L1 High grade cow leather.
- Piel de vaca de 1ª categoría.

- L3 Polished full grain leather.
- Plena flor pulida.

- L6 Aniline leather batique-effect.
- Scandinavian cattle.
- Piel anilina efecto batique.
- Ganado escandinavo.

* Only available with parallel stitching upholstery. Solo en tapizado con costuras paralelas.

Wood finish Beech
Acabado madera Haya



Premium finish and wood lacquers
Acabado premium y lacas madera



Eco Thermo-polymer finish
Acabado de Termo-polímero Eco

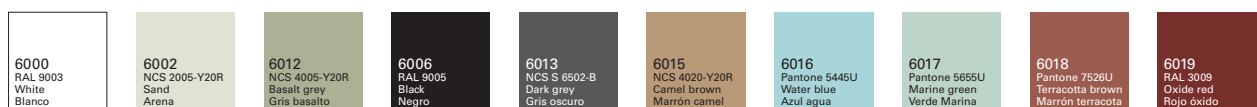

Steel finish
Acabado de acero



Pure Eco Thermo-polymer finish
Acabado de Termo-polímero Pure Eco

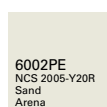

Certificates
Certificados

Fireproof polyurethane foam
Espuma de poliuretano ignífuga

UNE EN 1021:2006
BS 5852 part 2 crib 5
UNI 9175 Classe 1 IM
BKZ 5.2
California TB 117:2013
California TB 133*

*Contact our Customer Department
*Consultar con nuestro Departamento Comercial

Quality - Resistance
Calidad - Resistencia

UNE EN 16139:2013

Intellectual property Propiedad intelectual

All our collections are protected by international industrial design registries, designs patents, copyrights and intellectual Property laws. Unauthorized use of AW International Property is a criminal offence and can lead to prosecution. Todas nuestras colecciones están protegidas por registros de diseño industrial, diseño de patente, copyright y derechos de propiedad intelectual en todo el mundo. El uso no autorizado de los diseños y propiedad intelectual de AW supone un delito que puede ser sometido a acción judicial.



SI1600



Stackable chair with Eco thermo-polymer shell available in several colors or Pure Eco thermo-polymer (100% recycled) available in sand color and 4 tubular steel legs available in several colors. Optional fully upholstered shell or parallel upholstery stitching. Optional upholstered seat pad. The upholstered version includes a stacking protector. Fire retardant version available, for further information contact our Sales Department. In upholstered versions the seat height increases 20 mm.

Silla apilable con carcasa de termopolímero Eco disponible en diferentes colores o termopolímero Pure Eco (100% reciclado) disponible en color arena y base de 4 patas de tubo de acero disponible en diferentes colores. Opciones disponibles: asiento plafonado, asiento y respaldo plafonado, carcasa tapizada y tapizado con costuras paralelas. Incluido protector de apilado en la versión tapizada. Verión ignífuga disponible, para más información rogamos contacten con el Departamento Comercial. En versiones tapizadas la altura de asiento aumenta 20 mm.

COM cm. per unit	COL m2
------------------	--------

0,4 m3
28,8 kg
x4

Fully upholstered Carcasa tapizada

1 units	110	2,25
10 units or more	90	

Seat pad Asiento plafonado

1 units	50	1
10 units or more	25	

Shell pad Asiento y respaldo plafonado

1 units	70	1,5
10 units or more	60	

10
15

€



TP
178

Thermo-polymer shell
Carcasa termopolímero



COM	COL	1	2	3	4	5	6	7	8	9	10	11	L1	L2	L3	L6
307	317	328	338	345	358	370	383	396	408	421	434	449	461	524	613	860

Fully upholstered shell
Carcasa tapizada



COM	COL	1	2	3	4	5	6	7	8	9	10	11	L1	L2	L3	L6
246	248	251	254	256	259	263	266	268	272	275	279	282	285	297	318	376

Upholstered seat pad
Asiento plafonado



COM	COL	1	2	3	4	5	6	7	8	9	10	11	L1	L2	L3	L6
311	318	325	332	338	346	355	363	372	380	389	397	406	414	445	502	651

Upholstered shell pad
Asiento y respaldo plafonado



Parallel stitching upholstery upcharge (Seat and back)
Incremento tapizado con costuras paralelas (Asiento y respaldo) | 59 |



Parallel stitching upholstery upcharge (Seat)
Incremento tapizado con costuras paralelas (Asiento) | 30 |

SO1610

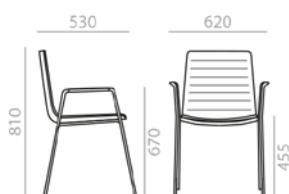

Stackable armchair with Eco thermo-polymer shell available in several colors or Pure Eco thermo-polymer (100% recycled) available in sand color and 4 tubular steel legs available in several colors. The upholstered version includes a stacking protector. Available options: Upholstered seat pad, upholstered shell pad, fully upholstered shell, parallel stitching upholstery and upholstered arms. Fire retardant version available, for further information contact our Sales Department. In upholstered versions the seat height increases 20 mm.

Sillón apilable con carcasa de termopolímero Eco disponible en diferentes colores o termopolímero Pure Eco (100% reciclado) disponible en color arena y base de 4 patas de tubo de acero disponible en diferentes colores. Opciones disponibles: asiento plafonado, asiento y respaldo plafonado, carcasa tapizada, tapizado con costuras paralelas y brazos tapizados. Incluido protector de apilado en la versión tapizada. Versión ignífuga disponible, para más información rogamos contacten con el Departamento Comercial. En versiones tapizadas la altura de asiento aumenta 20 mm.

COM cm. per unit	COL m2
------------------	--------

0,34 m3
22,5 kg
x2

Fully upholstered Carcasa tapizada

1 units	110	2,25
10 units or more	90	

Seat pad Asiento plafonado

1 units	50	1
10 units or more	25	

Shell pad Asiento y respaldo plafonado

1 units	70	1,5
10 units or more	60	

10
15

€



TP
321

Thermo-polymer shell
Carcasa termopolímero



COM	COL	1	2	3	4	5	6	7	8	9	10	11	L1	L2	L3	L6
430	439	449	459	466	478	491	504	516	530	542	556	570	582	632	723	994

Fully upholstered shell
Carcasa tapizada



COM	COL	1	2	3	4	5	6	7	8	9	10	11	L1	L2	L3	L6
399	402	405	408	411	413	416	420	423	428	430	433	437	440	451	474	536

Upholstered seat pad
Asiento plafonado



COM	COL	1	2	3	4	5	6	7	8	9	10	11	L1	L2	L3	L6
464	471	478	485	491	499	508	516	526	535	543	552	560	569	600	660	823

Upholstered shell pad
Asiento y respaldo plafonado



Parallel stitching upholstery upcharge (Seat and back)
Incremento tapizado con costuras paralelas (Asiento y respaldo) | 59 |



Parallel stitching upholstery upcharge (Seat)
Incremento tapizado con costuras paralelas (Asiento) | 30 |



Upholstered arm upcharge
Incremento brazo tapizado | 42 |

SI1621

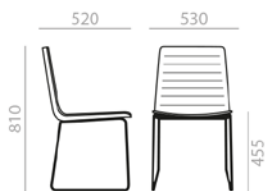

Stackable chair with Eco thermo-polymer shell available in several colors or Pure Eco thermo-polymer (100% recycled) available in sand color and a steel sled base finished in polished chrome, white or black. Optional fully upholstered shell or parallel upholstery stitching. Optional upholstered seat pad. The upholstered version includes a stacking protector. Fire retardant version available, for further information contact our Sales Department. In upholstered versions the seat height increases 20 mm.

Silla apilable con carcasa de termopolímero Eco disponible en diferentes colores o termopolímero Pure Eco (100% reciclado) disponible en color arena y base de patín de varilla de acero en acabado cromo brillo, blanco o negro. Opciones disponibles: asiento plafonado asiento y respaldo plafonado, carcasa tapizada y tapizado con costuras paralelas. Incluido protector de apilado en la versión tapizada. Versión ignífuga disponible, para más información rogamos contacten con el Departamento Comercial. En versiones tapizadas la altura de asiento aumenta 20 mm.

COM cm. per unit	COL m2
------------------	--------

0,37 m3
32,4 kg
x4

Fully upholstered Carcasa tapizada		2,25
1 units	110	
10 units or more	90	

Seat pad Asiento plafonado		1
1 units	50	
10 units or more	25	

Shell pad Asiento y respaldo plafonado		1,5
1 units	70	
10 units or more	60	

10
20

€ TP
184



Thermo-polymer shell
Carcasa termopolímero



Fully upholstered shell
Carcasa tapizada



Upholstered seat pad
Asiento plafonado



Upholstered shell pad
Asiento y respaldo plafonado

COM	COL	1	2	3	4	5	6	7	8	9	10	11	L1	L2	L3	L6
338	348	359	369	377	391	403	417	430	444	458	473	490	502	559	659	927

COM	COL	1	2	3	4	5	6	7	8	9	10	11	L1	L2	L3	L6
251	252	255	258	260	263	266	270	272	275	279	282	285	287	299	319	374

COM	COL	1	2	3	4	5	6	7	8	9	10	11	L1	L2	L3	L6
316	323	330	337	342	350	358	367	376	384	392	400	408	417	446	502	649

Parallel stitching upholstery upcharge (Seat and back)
Incremento tapizado con costuras paralelas (Asiento y respaldo) | 59 |



Parallel stitching upholstery upcharge (Seat)
Incremento tapizado con costuras paralelas (Asiento) | 30 |



SO1622

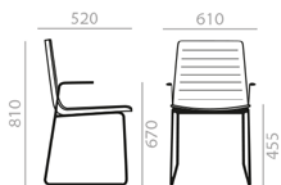

Stackable armchair with Eco thermo-polymer shell available in several colors or Pure Eco thermo-polymer (100% recycled) available in sand color and a steel sled base finished in polished chrome, white or black. Available options: Upholstered seat pad, upholstered shell pad, fully upholstered shell, parallel stitching upholstery and upholstered arms. Fire retardant version available, for further information contact our Sales Department. In upholstered versions the seat height increases 20 mm.

Sillón apilable con carcasa de termopolímero Eco disponible en diferentes colores o termopolímero Pure Eco (100% reciclado) disponible en color arena y base de patín de varilla de acero en acabado cromo brillo, blanco o negro. Opciones disponibles: asiento plafonado, asiento y respaldo plafonado, carcasa tapizada, tapizado con costuras paralelas y brazos tapizados. Incluido protector de apilado en la versión tapizada. Versión ignífuga disponible, para más información rogamos contacten con el Departamento Comercial. En versiones tapizadas la altura de asiento aumenta 20 mm.

COM cm. per unit	COL m2
------------------	--------

0,33 m3
24,4 kg
x2

Fully upholstered Carcasa tapizada		2,25
1 units	110	
10 units or more	90	

Seat pad Asiento plafonado		1
1 units	50	
10 units or more	25	

Shell pad Asiento y respaldo plafonado		1,5
1 units	70	
10 units or more	60	

10
15

€ TP
289



Thermo-polymer shell
Carcasa termopolímero



Fully upholstered shell
Carcasa tapizada



Upholstered seat pad
Asiento plafonado



Upholstered shell pad
Asiento y respaldo plafonado

COM	COL	1	2	3	4	5	6	7	8	9	10	11	L1	L2	L3	L6
462	473	486	497	506	519	533	547	561	576	593	611	626	643	705	836	1.121

COM	COL	1	2	3	4	5	6	7	8	9	10	11	L1	L2	L3	L6
369	372	375	378	381	383	388	391	395	398	402	405	408	412	425	447	535

COM	COL	1	2	3	4	5	6	7	8	9	10	11	L1	L2	L3	L6
431	438	445	452	458	466	476	485	494	503	511	521	530	538	571	636	838

Parallel stitching upholstery upcharge (Seat and back)
Incremento tapizado con costuras paralelas (Asiento y respaldo) | 59 |



Parallel stitching upholstery upcharge (Seat)
Incremento tapizado con costuras paralelas (Asiento) | 30 |



Upholstered arm upcharge
Incremento brazo tapizado | 42 |

SI1622



Chair with Eco thermo-polymer shell available in several colors or Pure Eco thermo-polymer (100% recycled) available in sand color and tubular steel cantilever base finished in polished chrome, white or black. Available options: Upholstered seat pad, upholstered shell pad, fully upholstered shell and parallel stitching upholstery. Fire retardant version available, for further information contact our Sales Department. In upholstered versions the seat height increases 20 mm.

Silla con carcasa de termopolímero Eco disponible en diferentes colores o termopolímero Pure Eco (100% reciclado) disponible en color arena y base cantiléver de tubo de acero en acabado cromo brillo, blanco o negro. Opciones disponibles: asiento plafonado, carcasa tapizada, tapizado con costuras paralelas y ruedas. Versión ignífuga disponible, para más información rogamos contacten con el Departamento Comercial. En versiones tapizadas la altura de asiento aumenta 20 mm.

COM cm. per unit	COL m2
------------------	--------

0,24 m3
22,4 kg
x2

Fully upholstered Carcasa tapizada		
1 units	110	2,25
10 units or more	90	

Seat pad Asiento plafonado		
1 units	50	1
10 units or more	25	

Shell pad Asiento y respaldo plafonado		
1 units	70	1,5
10 units or more	60	

€ TP
325



Thermo-polymer shell
Carcasa termopolímero



Fully upholstered shell
Carcasa tapizada



Upholstered seat pad
Asiento plafonado



Upholstered shell pad
Asiento y respaldo plafonado

COM	COL	1	2	3	4	5	6	7	8	9	10	11	L1	L2	L3	L6
453	464	477	488	498	513	528	544	558	574	589	604	619	634	688	789	1.054
401	405	408	412	414	418	423	428	432	436	440	445	449	452	467	495	570
463	470	480	489	494	506	517	527	538	548	559	569	581	590	629	698	885



Parallel stitching upholstery upcharge (Seat and back)
Incremento tapizado con costuras paralelas (Asiento y respaldo) | 59 |



Parallel stitching upholstery upcharge (Seat)
Incremento tapizado con costuras paralelas (Asiento) | 30 |

SO1633

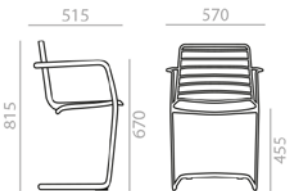

Armchair with thermo-polymer seat and backrest available in several colors and tubular steel cantilever base finished in polished chrome, white or black. Available options: Upholstered seat pad, upholstered shell pad, fully upholstered shell, parallel stitching upholstery and upholstered arms. Fire retardant version available, for further information contact our Sales Department. In upholstered versions the seat height increases 20 mm.

Sillón con carcasa de termopolímero disponible en varios colores y base cantiléver de tubo de acero en acabado cromo brillo, blanco o negro. Opciones disponibles: asiento plafonado, asiento y respaldo plafonado, carcasa tapizada, tapizado con costuras paralelas y brazos tapizados. Versión ignífuga disponible, para más información rogamos contacten con el Departamento Comercial. En versiones tapizadas la altura de asiento aumenta 20 mm.

COM cm. per unit	COL m2
------------------	--------

0,27 m3
15 kg
x1

Fully upholstered Carcasa tapizada		
1 units	110	2,25
10 units or more	90	

Seat pad Asiento plafonado		
1 units	50	1
10 units or more	25	

Shell pad Asiento y respaldo plafonado		
1 units	70	1,5
10 units or more	60	

€ TP
372



Thermo-polymer shell
Carcasa termopolímero



Fully upholstered shell
Carcasa tapizada



Upholstered seat pad
Asiento plafonado



Upholstered shell pad
Asiento y respaldo plafonado

COM	COL	1	2	3	4	5	6	7	8	9	10	11	L1	L2	L3	L6
502	510	520	528	535	546	557	573	590	609	625	643	660	676	757	860	1.159
450	453	454	457	458	461	465	468	471	474	476	479	482	485	501	533	632
539	546	553	560	565	574	582	590	599	607	616	626	636	644	681	755	976



Parallel stitching upholstery upcharge (Seat and back)
Incremento tapizado con costuras paralelas (Asiento y respaldo) | 59 |



Parallel stitching upholstery upcharge (Seat)
Incremento tapizado con costuras paralelas (Asiento) | 30 |



Upholstered arm upcharge
Incremento brazo tapizado | 42 |

SI1638



Chair with Eco thermo-polymer shell available in several colors or Pure Eco thermo-polymer (100% recycled) available in sand color and 4-star aluminum swivel central base and self-return system in polished aluminum finish but also available in other aluminum colors. Available options: Upholstered seat pad, upholstered shell pad and fully upholstered shell, parallel stitching upholstery. Fire retardant version available, for further information contact our Sales Department. In upholstered versions the seat height increases 20 mm.

Silla con carcasa de termopolímero Eco disponible en diferentes colores o termopolímero Pure Eco (100% reciclado) disponible en color arena y base central giratoria de aluminio de 4 aspas con sistema de retorno y acabado aluminio pulido y otros colores de aluminio. Opciones disponibles: asiento plafonado, asiento y respaldo plafonado, carcasa tapizada, tapizado con costuras paralelas y ruedas. Versión ignífuga disponible, para más información rogamos contacten con el Departamento Comercial. En versiones tapizadas la altura de asiento aumenta 20 mm.

COM cm. per unit	COL m2
------------------	--------

0,26 m3
12,2 kg
x1

Fully upholstered Carcasa tapizada		
1 units	110	2,25
10 units or more	90	

Seat pad Asiento plafonado		
1 units	50	1
10 units or more	25	

Shell pad Asiento y respaldo plafonado		
1 units	70	1,5
10 units or more	60	

€ TP
372



Thermo-polymer shell
Carcasa termopolímero



Fully upholstered shell
Carcasa tapizada



Upholstered seat pad
Asiento plafonado



Upholstered shell pad
Asiento y respaldo plafonado

COM	COL	1	2	3	4	5	6	7	8	9	10	11	L1	L2	L3	L6
536	546	558	569	576	590	604	616	630	644	658	670	684	697	749	848	1.105
448	451	454	457	460	462	467	469	472	476	479	483	486	489	502	524	585
510	517	524	531	537	545	554	564	572	581	590	599	607	616	648	706	867



Optional casters.
(No swivel base).
Opción de ruedas.
(Base no giratoria).



Parallel stitching upholstery upcharge (Seat and back)
Incremento tapizado con costuras paralelas (Asiento y respaldo) | 59 |



Parallel stitching upholstery upcharge (Seat)
Incremento tapizado con costuras paralelas (Asiento) | 30 |

SO1644

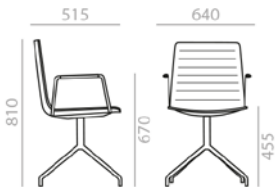

Armchair with Eco thermo-polymer shell available in several colors or Pure Eco thermo-polymer (100% recycled) available in sand color and 4-star aluminum swivel central base and self-return system in polished aluminum finish but also available in other aluminum colors. Available options: Upholstered seat pad, upholstered shell pad, fully upholstered shell, parallel stitching upholstery and upholstered arms. Fire retardant version available, for further information contact our Sales Department. In upholstered versions the seat height increases 20 mm.

Sillón con carcasa de termopolímero Eco disponible en diferentes colores o termopolímero Pure Eco (100% reciclado) disponible en color arena y base central giratoria de aluminio de 4 aspas con sistema de retorno y acabado aluminio pulido y otros colores de aluminio. Opciones disponibles: asiento plafonado, asiento y respaldo plafonado, carcasa tapizada, tapizado con costuras paralelas, brazos tapizados y ruedas. Versión ignífuga disponible, para más información rogamos contacten con el Departamento Comercial. En versiones tapizadas la altura de asiento aumenta 20 mm.

COM cm. per unit	COL m2
------------------	--------

0,29 m3
10 kg
x1

Fully upholstered Carcasa tapizada		
1 units	110	2,25
10 units or more	90	

Seat pad Asiento plafonado		
1 units	50	1
10 units or more	25	

Shell pad Asiento y respaldo plafonado		
1 units	70	1,5
10 units or more	60	

€ TP
554



Thermo-polymer shell
Carcasa termopolímero



Fully upholstered shell
Carcasa tapizada



Upholstered seat pad
Asiento plafonado



Upholstered shell pad
Asiento y respaldo plafonado

COM	COL	1	2	3	4	5	6	7	8	9	10	11	L1	L2	L3	L6
729	738	749	759	766	779	792	803	816	829	842	853	866	877	923	1.006	1.238
663	665	668	671	673	676	680	683	687	690	694	696	700	703	715	737	795
704	711	718	725	729	738	748	756	764	773	781	790	798	805	836	892	1.040



Optional casters.
(No swivel base).
Opción de ruedas.
(Base no giratoria).



Parallel stitching upholstery upcharge (Seat and back)
Incremento tapizado con costuras paralelas (Asiento y respaldo) | 59 |



Parallel stitching upholstery upcharge (Seat)
Incremento tapizado con costuras paralelas (Asiento) | 30 |



Upholstered arm upcharge
Incremento brazo tapizado | 42 |

SI1656



Chair with Eco thermo-polymer shell available in several colors or Pure Eco thermo-polymer (100% recycled) available in sand color and aluminum central swivel base with 5 casters, height adjustment and polished aluminum finish, white or black. Available options: Upholstered seat pad, upholstered sell pad, fully upholstered shell and parallel stitching upholstery. Fire retardant version available, for further information contact our Sales Department. Seat height range: 400-500 mm. In upholstered versions the seat height increases 20 mm.

Silla con carcasa de termopolímero Eco disponible en diferentes colores o termopolímero Pure Eco (100% reciclado) disponible en color arena y base central giratoria de aluminio con 5 ruedas, regulable en altura y acabado aluminio pulido, blanco o negro. Opciones disponibles: Asiento plafonado, asiento y respaldo plafonado, carcasa tapizada y tapizado con costuras paralelas. Versión ignífuga disponible, para más información rogamos contacten con el Departamento Comercial. Rango de altura de asiento: 400-500 mm. En versiones tapizadas la altura de asiento aumenta 20 mm.

COM cm. per unit	COL m2
------------------	--------

0,33 m3
10,5 kg
x1

Fully upholstered Carcasa tapizada		2,25
1 units	110	
10 units or more	90	

Seat pad Asiento plafonado		1
1 units	50	
10 units or more	25	

Shell pad Asiento y respaldo plafonado		1,5
1 units	70	
10 units or more	60	

€ TP
367



Thermo-polymer shell
Carcasa termopolímero



Fully upholstered shell
Carcasa tapizada



Upholstered seat pad
Asiento plafonado



Upholstered shell pad
Asiento y respaldo plafonado

COM	COL	1	2	3	4	5	6	7	8	9	10	11	L1	L2	L3	L6
542	553	567	580	588	604	619	634	651	667	682	700	716	730	787	895	1.177
443	446	449	453	455	459	463	467	470	474	478	483	487	490	504	530	599
506	514	522	530	536	546	556	566	576	586	597	607	617	625	662	729	903



Parallel stitching upholstery upcharge (Seat and back)
Incremento tapizado con costuras paralelas (Asiento y respaldo) | 59



Parallel stitching upholstery upcharge (Seat)
Incremento tapizado con costuras paralelas (Asiento) | 30

SI1663

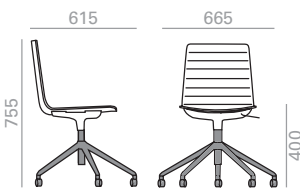

Chair with Eco thermo-polymer shell available in several colors or Pure Eco thermo-polymer (100% recycled) available in sand color and Eco thermo-polymer central base with 5 casters, swivel and pneumatic height adjustment, finished in black. Available options: Upholstered seat pad, upholstered shell pad, fully upholstered shell and parallel stitching upholstery. Fire retardant version available, for further information contact our Sales Department. In upholstered versions the seat height increases 20 mm.

Silla con carcasa de termopolímero Eco disponible en diferentes colores o termopolímero Pure Eco (100% reciclado) disponible en color arena y base central giratoria de termopolímero Eco de 5 ruedas, regulable en altura y acabado negro. Opciones disponibles: asiento plafonado, asiento y respaldo plafonado, carcasa tapizada y tapizado con costuras paralelas. Versión ignífuga disponible, para más información rogamos contacten con el Departamento Comercial. En versiones tapizadas la altura de asiento aumenta 20 mm.

COM cm. per unit	COL m2
------------------	--------

0,32 m3
9,5 kg
x1

Fully upholstered Carcasa tapizada		2,25
1 units	110	
10 units or more	90	

Seat pad Asiento plafonado		1
1 units	50	
10 units or more	25	

Shell pad Asiento y respaldo plafonado		1,5
1 units	70	
10 units or more	65	

€ TP
231



Thermo-polymer shell
Carcasa termopolímero



Fully upholstered shell
Carcasa tapizada



Upholstered seat pad
Asiento plafonado



Upholstered shell pad
Asiento y respaldo plafonado

COM	COL	1	2	3	4	5	6	7	8	9	10	11	L1	L2	L3	L6
395	406	419	430	439	454	469	483	499	513	528	543	558	571	623	721	979
319	322	325	328	331	335	338	342	346	350	353	357	362	364	378	404	470
403	410	419	426	432	442	452	460	470	480	489	499	508	517	551	614	779



Parallel stitching upholstery upcharge (Seat and back)
Incremento tapizado con costuras paralelas (Asiento y respaldo) | 59



Parallel stitching upholstery upcharge (Seat)
Incremento tapizado con costuras paralelas (Asiento) | 30

SO1659

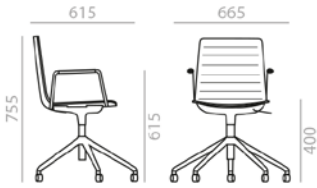

Armchair with Eco thermo-polymer shell available in several colors or Pure Eco thermo-polymer (100% recycled) available in sand color and aluminum central swivel base with 5 casters, height adjustment and polished aluminum finish, white or black. Available options: Upholstered seat pad, upholstered shell pad, fully upholstered shell, parallel stitching upholstery and upholstered arms. Fire retardant version available, for further information contact our Sales Department. Height ranges: seat 400-500 mm./arms 615-715 mm. In upholstered versions the seat height increases 20 mm.

Sillón con carcasa de termopolímero Eco disponible en diferentes colores o termopolímero Pure Eco (100% reciclado) disponible en color arena y base central giratoria de aluminio con 5 ruedas, regulable en altura y acabado aluminio pulido, blanco o negro. Opciones disponibles: asiento plafonado, asiento y respaldo plafonado, carcasa tapizada y tapizado con costuras paralelas. Versión ignífuga disponible, para más información rogamos contacten con el Departamento Comercial. Rangos de altura: asiento 400-500 mm./brazos 615-715 mm. En versiones tapizadas la altura de asiento aumenta 20 mm.

COM cm. per unit	COL m2
------------------	--------

0,32 m3
12,2 kg
x1

Fully upholstered Carcasa tapizada		2,25
1 units	110	
10 units or more	90	

Seat pad Asiento plafonado		1
1 units	50	
10 units or more	25	

Shell pad Asiento y respaldo plafonado		1,5
1 units	70	
10 units or more	60	

TP
566



COM	COL	1	2	3	4	5	6	7	8	9	10	11	L1	L2	L3	L6
730	740	752	763	771	785	798	812	826	841	856	869	883	897	949	1.044	1.294
673	675	678	682	684	688	692	694	699	703	705	710	714	716	730	755	821
736	743	751	759	765	774	784	793	803	813	822	832	841	851	885	950	1.118

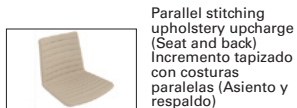

59



30



42

SO1664

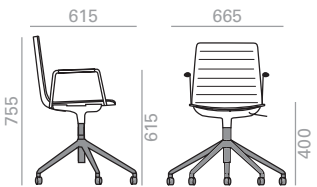

Armchair with Eco thermo-polymer shell available in several colors or Pure Eco thermo-polymer (100% recycled) available in sand color and Eco thermo-polymer central base with 5 casters, swivel and pneumatic height adjustment, finished in black. Available options: Upholstered seat pad, upholstered shell pad, fully upholstered shell, parallel stitching upholstery and upholstered arms. Fire retardant version available, for further information contact our Sales Department. In upholstered versions the seat height increases 20 mm.

Sillón con carcasa de termopolímero Eco disponible en diferentes colores o termopolímero Pure Eco (100% reciclado) disponible en color arena y base central giratoria de termopolímero Eco de 5 ruedas, regulable en altura y acabado negro. Opciones disponibles: asiento plafonado, asiento y respaldo plafonado, carcasa tapizada, tapizado con costuras paralelas y brazos tapizados. Versión ignífuga disponible, para más información rogamos contacten con el Departamento Comercial. En versiones tapizadas la altura de asiento aumenta 20 mm.

COM cm. per unit	COL m2
------------------	--------

0,32 m3
9,5 kg
x1

Fully upholstered Carcasa tapizada		2,25
1 units	110	
10 units or more	90	

Seat pad Asiento plafonado		1
1 units	50	
10 units or more	25	

Shell pad Asiento y respaldo plafonado		1,5
1 units	70	
10 units or more	65	

TP
438



COM	COL	1	2	3	4	5	6	7	8	9	10	11	L1	L2	L3	L6
583	594	608	621	629	645	661	679	698	716	736	755	773	788	853	974	1.296
527	531	534	538	541	545	549	554	558	562	566	570	575	579	593	621	695
611	620	628	636	642	652	663	673	683	694	704	714	726	734	771	839	1.020

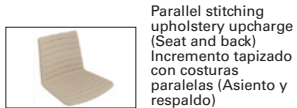

59



30



42

BQ1665



Barstool with Eco thermo-polymer shell available in several colors or Pure Eco thermo-polymer (100% recycled) available in sand color and 4 tubular steel legs and finished in polished chrome, white or black. Available options: Upholstered seat pad, upholstered shell pad, fully upholstered shell and parallel stitching upholstery. Fire retardant version available, for further information contact our Sales Department. In upholstered versions the seat height increases 20 mm.

Banqueta alta con carcasa de termopolímero Eco disponible en diferentes colores o termopolímero Pure Eco (100% reciclado) disponible en color arena y base de 4 patas de tubo de acero en acabado cromo brillo, blanco o negro. Opciones disponibles: asiento plafonado, asiento y respaldo plafonado, carcasa tapizada y tapizado con costuras paralelas. Versión ignífuga disponible, para más información rogamos contacten con el Departamento Comercial. En versiones tapizadas la altura de asiento aumenta 20 mm.

COM cm. per unit	COL m2
------------------	--------

0,33 m3
9,5 kg
x1

Fully upholstered Carcasa tapizada		2,25
1 units	110	
10 units or more	90	

Seat pad Asiento plafonado		1
1 units	50	
10 units or more	25	

Shell pad Asiento y respaldo plafonado		1,5
1 units	70	
10 units or more	60	

€ TP
251



Thermo-polymer shell
Carcasa termopolímero



Fully upholstered shell
Carcasa tapizada



Upholstered seat pad
Asiento plafonado



Upholstered shell pad
Asiento y respaldo plafonado

COM	COL	1	2	3	4	5	6	7	8	9	10	11	L1	L2	L3	L6
-----	-----	---	---	---	---	---	---	---	---	---	----	----	----	----	----	----

413	423	435	445	452	467	480	493	506	519	534	551	565	580	638	742	1.032
-----	-----	-----	-----	-----	-----	-----	-----	-----	-----	-----	-----	-----	-----	-----	-----	-------

COM	COL	1	2	3	4	5	6	7	8	9	10	11	L1	L2	L3	L6
-----	-----	---	---	---	---	---	---	---	---	---	----	----	----	----	----	----

329	330	333	336	337	342	345	347	350	355	358	360	363	366	379	399	456
-----	-----	-----	-----	-----	-----	-----	-----	-----	-----	-----	-----	-----	-----	-----	-----	-----

COM	COL	1	2	3	4	5	6	7	8	9	10	11	L1	L2	L3	L6
-----	-----	---	---	---	---	---	---	---	---	---	----	----	----	----	----	----

388	394	401	408	412	421	430	438	447	455	464	472	481	488	518	574	723
-----	-----	-----	-----	-----	-----	-----	-----	-----	-----	-----	-----	-----	-----	-----	-----	-----

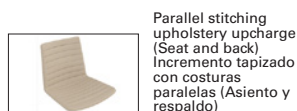

Parallel stitching upholstery upcharge (Seat and back)
Incremento tapizado con costuras paralelas (Asiento y respaldo) | 59 |



Parallel stitching upholstery upcharge (Seat)
Incremento tapizado con costuras paralelas (Asiento) | 30 |

BQ1671



Counter stool with Eco thermo-polymer shell available in several colors or Pure Eco thermo-polymer (100% recycled) available in sand color and 4 tubular steel legs and finished in polished chrome, white or black. Available options: Upholstered seat pad, upholstered shell pad, fully upholstered shell, parallel stitching upholstery and upholstered arms. Fire retardant version available, for further information contact our Sales Department. In upholstered versions the seat height increases 20 mm.

Banqueta baja con carcasa de termopolímero Eco disponible en diferentes colores o termopolímero Pure Eco (100% reciclado) disponible en color arena y base de 4 patas de tubo de acero en acabado cromo brillo, blanco o negro. Opciones disponibles: asiento plafonado, asiento y respaldo plafonado, carcasa tapizada y tapizado con costuras paralelas. Versión ignífuga disponible, para más información rogamos contacten con el Departamento Comercial. En versiones tapizadas la altura de asiento aumenta 20 mm.

COM cm. per unit	COL m2
------------------	--------

0,28 m3
9,5 kg
x1

Fully upholstered Carcasa tapizada		2,25
1 units	110	
10 units or more	90	

Seat pad Asiento plafonado		1
1 units	50	
10 units or more	25	

Shell pad Asiento y respaldo plafonado		1,5
1 units	70	
10 units or more	60	

€ TP
251



Thermo-polymer shell
Carcasa termopolímero



Fully upholstered shell
Carcasa tapizada



Upholstered seat pad
Asiento plafonado



Upholstered shell pad
Asiento y respaldo plafonado

COM	COL	1	2	3	4	5	6	7	8	9	10	11	L1	L2	L3	L6
-----	-----	---	---	---	---	---	---	---	---	---	----	----	----	----	----	----

413	423	435	445	452	467	480	493	506	519	534	551	565	580	638	742	1.032
-----	-----	-----	-----	-----	-----	-----	-----	-----	-----	-----	-----	-----	-----	-----	-----	-------

COM	COL	1	2	3	4	5	6	7	8	9	10	11	L1	L2	L3	L6
-----	-----	---	---	---	---	---	---	---	---	---	----	----	----	----	----	----

329	330	333	336	337	342	345	347	350	355	358	360	363	366	379	399	456
-----	-----	-----	-----	-----	-----	-----	-----	-----	-----	-----	-----	-----	-----	-----	-----	-----

COM	COL	1	2	3	4	5	6	7	8	9	10	11	L1	L2	L3	L6
-----	-----	---	---	---	---	---	---	---	---	---	----	----	----	----	----	----

388	394	401	408	412	421	430	438	447	455	464	472	481	488	518	574	723
-----	-----	-----	-----	-----	-----	-----	-----	-----	-----	-----	-----	-----	-----	-----	-----	-----



Parallel stitching upholstery upcharge (Seat and back)
Incremento tapizado con costuras paralelas (Asiento y respaldo) | 59 |



Parallel stitching upholstery upcharge (Seat)
Incremento tapizado con costuras paralelas (Asiento) | 30 |

BQ1677

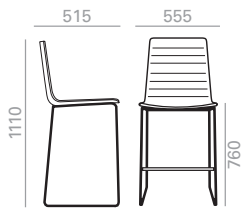

Stackable barstool with Eco thermo-polymer shell available in several colors or Pure Eco thermo-polymer (100% recycled) available in sand color and a steel sled base and finished in polished chrome, white or black. Available options: Upholstered seat pad, upholst red shell pad, fully upholstered shell and parallel stitching upholstery. Fire retardant version available, for further information contact our Sales Department. In upholstered versions the seat height increases 20 mm.

Banqueta alta con carcasa de termopolímero Eco disponible en diferentes colores o termopolímero Pure Eco (100% reciclado) disponible en color arena y base de patín de varilla de acero en acabado cromo brillo, blanco o negro. Opciones disponibles: asiento plafonado asiento y respaldo plafonado, carcasa tapizada y tapizado con costuras paralelas. Incluido protector de apilado en la versión tapizada. Versión ignífuga disponible, para más información rogamos contacten con el Departamento Comercial. En versiones tapizadas la altura de asiento aumenta 20 mm.

COM cm. per unit	COL m2
------------------	--------

0,38 m3

11,5 kg

x1

8

Fully upholstered Carcasa tapizada

1 units	110	2,25
10 units or more	90	

Seat pad Asiento plafonado

1 units	50	1
10 units or more	25	

Shell pad Asiento y respaldo plafonado

1 units	70	1,5
10 units or more	60	

€ TP
259



Thermo-polymer shell
Carcasa termopolímero



Fully upholstered shell
Carcasa tapizada



Upholstered seat pad
Asiento plafonado



Upholstered shell pad
Asiento y respaldo plafonado

COM	COL	1	2	3	4	5	6	7	8	9	10	11	L1	L2	L3	L6
427	437	448	458	466	479	492	504	517	531	544	558	573	585	641	740	1.005

COM	COL	1	2	3	4	5	6	7	8	9	10	11	L1	L2	L3	L6
337	338	341	344	345	349	352	355	358	362	365	368	371	373	386	406	466

COM	COL	1	2	3	4	5	6	7	8	9	10	11	L1	L2	L3	L6
400	407	414	421	425	434	442	451	459	468	476	484	493	500	531	586	739

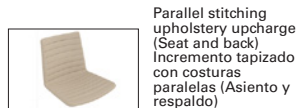

Parallel stitching upholstery upcharge (Seat and back)
Incremento tapizado con costuras paralelas (Asiento y respaldo) | 59



Parallel stitching upholstery upcharge (Seat)
Incremento tapizado con costuras paralelas (Asiento) | 30

BQ1683



Stackable counter stool with Eco thermo-polymer shell available in several colors or Pure Eco thermo-polymer (100% recycled) available in sand color and a steel sled base and finished in polished chrome, white or black. Available options: Upholstered seat pad, upholstered shell pad, fully upholstered shell and parallel stitching upholstery. Fire retardant version available, for further information contact our Sales Department. In upholstered versions the seat height increases 20 mm.

Banqueta baja con carcasa de termopolímero Eco disponible en diferentes colores o termopolímero Pure Eco (100% reciclado) disponible en color arena y base de patín de varilla de acero en acabado cromo brillo, blanco o negro. Opciones disponibles: asiento plafonado, asiento y respaldo plafonado, carcasa tapizada y tapizado con costuras paralelas. Incluido protector de apilado en la versión tapizada. Versión ignífuga disponible, para más información rogamos contacten con el Departamento Comercial. En versiones tapizadas la altura de asiento aumenta 20 mm.

COM cm. per unit	COL m2
------------------	--------

0,33 m3

11,5 kg

x1

8

Fully upholstered Carcasa tapizada

1 units	110	2,25
10 units or more	90	

Seat pad Asiento plafonado

1 units	50	1
10 units or more	25	

Shell pad Asiento y respaldo plafonado

1 units	70	1,5
10 units or more	60	

€ TP
259



Thermo-polymer shell
Carcasa termopolímero



Fully upholstered shell
Carcasa tapizada



Upholstered seat pad
Asiento plafonado



Upholstered shell pad
Asiento y respaldo plafonado

COM	COL	1	2	3	4	5	6	7	8	9	10	11	L1	L2	L3	L6
427	437	448	458	466	479	492	504	517	531	544	558	573	585	641	740	1.005

COM	COL	1	2	3	4	5	6	7	8	9	10	11	L1	L2	L3	L6
337	338	341	344	345	349	352	355	358	362	365	368	371	373	386	406	466

COM	COL	1	2	3	4	5	6	7	8	9	10	11	L1	L2	L3	L6
400	407	414	421	425	434	442	451	459	468	476	484	493	500	531	586	739



Parallel stitching upholstery upcharge (Seat and back)
Incremento tapizado con costuras paralelas (Asiento y respaldo) | 59



Parallel stitching upholstery upcharge (Seat)
Incremento tapizado con costuras paralelas (Asiento) | 30

BQ1668

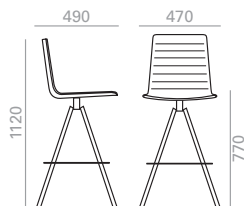

Barstool with Eco thermo-polymer shell available in several colors or Pure Eco thermo-polymer (100% recycled) available in sand color or, available in various colors and 4-legs steel swivel base and finished in polished chrome, white or black. Available options: Upholstered seat pad, upholstered shell pad, fully upholstered shell and parallel stitching upholstery. Fire retardant version available for further information contact our Sales Department. In upholstered versions the seat height increases 20 mm.

Banqueta alta con carcasa de termopolímero Eco disponible en diferentes colores o termopolímero Pure Eco (100% reciclado) disponible en color arena y base giratoria de 4 patas de acero y acabado cromo brillo, blanco o negro. Opciones disponibles: asiento plafonado, asiento y respaldo plafonado, carcasa tapizada y tapizado con costuras paralelas. Versión ignífuga disponible, para más información rogamos contacten con el Departamento Comercial. En versiones tapizadas la altura de asiento aumenta 20 mm.

COM cm. per unit	COL m2
------------------	--------

0,32 m3
12 kg
x1

Fully upholstered Carcasa tapizada		
1 units	110	2,25
10 units or more	90	

Seat pad Asiento plafonado		
1 units	50	1
10 units or more	25	

Shell pad Asiento y respaldo plafonado		
1 units	70	1,5
10 units or more	60	

€ TP
340

Thermo-polymer shell
Carcasa termopolímero



Fully upholstered shell
Carcasa tapizada

COM	COL	1	2	3	4	5	6	7	8	9	10	11	L1	L2	L3	L6
-----	-----	---	---	---	---	---	---	---	---	---	----	----	----	----	----	----

535	545	558	569	576	590	605	619	631	646	660	674	687	703	760	868	1.155
-----	-----	-----	-----	-----	-----	-----	-----	-----	-----	-----	-----	-----	-----	-----	-----	-------



Upholstered seat pad
Asiento plafonado

COM	COL	1	2	3	4	5	6	7	8	9	10	11	L1	L2	L3	L6
-----	-----	---	---	---	---	---	---	---	---	---	----	----	----	----	----	----

439	442	445	448	451	454	458	461	463	468	471	475	478	480	493	516	575
-----	-----	-----	-----	-----	-----	-----	-----	-----	-----	-----	-----	-----	-----	-----	-----	-----



Upholstered shell pad
Asiento y respaldo plafonado

COM	COL	1	2	3	4	5	6	7	8	9	10	11	L1	L2	L3	L6
-----	-----	---	---	---	---	---	---	---	---	---	----	----	----	----	----	----

505	512	519	526	532	540	549	559	568	576	586	595	603	612	645	703	860
-----	-----	-----	-----	-----	-----	-----	-----	-----	-----	-----	-----	-----	-----	-----	-----	-----

Parallel stitching upholstery upcharge (Seat and back)
Incremento tapizado con costuras paralelas (Asiento y respaldo) | 59 |



Parallel stitching upholstery upcharge (Seat)
Incremento tapizado con costuras paralelas (Asiento) | 30 |

BQ1674

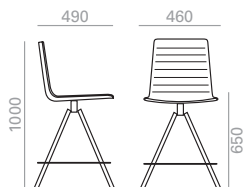

Counter stool with Eco thermo-polymer shell available in several colors or Pure Eco thermo-polymer (100% recycled) available in sand color and 4-legs steel swivel base and finished in polished chrome, white or black. Available options: Upholstered seat pad, upholstered shell pad, fully upholstered shell and parallel stitching upholstery. Fire retardant version available, for further information contact our Sales Department. In upholstered versions the seat height increases 20 mm.

Banqueta baja con carcasa de termopolímero Eco disponible en diferentes colores o termopolímero Pure Eco (100% reciclado) disponible en color arena y base giratoria de 4 patas de acero y acabado cromo brillo, blanco o negro. Opciones disponibles: asiento plafonado, asiento y respaldo plafonado, carcasa tapizada y tapizado con costuras paralelas. Versión ignífuga disponible, para más información rogamos contacten con el Departamento Comercial. En versiones tapizadas la altura de asiento aumenta 20 mm.

COM cm. per unit	COL m2
------------------	--------

0,26 m3
11,5 kg
x1

Fully upholstered Carcasa tapizada		
1 units	110	2,25
10 units or more	90	

Seat pad Asiento plafonado		
1 units	50	1
10 units or more	25	

Shell pad Asiento y respaldo plafonado		
1 units	70	1,5
10 units or more	60	

€ TP
340

Thermo-polymer shell
Carcasa termopolímero



Fully upholstered shell
Carcasa tapizada

COM	COL	1	2	3	4	5	6	7	8	9	10	11	L1	L2	L3	L6
-----	-----	---	---	---	---	---	---	---	---	---	----	----	----	----	----	----

535	545	558	569	576	590	605	619	631	646	660	674	687	703	760	868	1.155
-----	-----	-----	-----	-----	-----	-----	-----	-----	-----	-----	-----	-----	-----	-----	-----	-------



Upholstered seat pad
Asiento plafonado

COM	COL	1	2	3	4	5	6	7	8	9	10	11	L1	L2	L3	L6
-----	-----	---	---	---	---	---	---	---	---	---	----	----	----	----	----	----

439	442	445	448	451	454	458	461	463	468	471	475	478	480	493	516	575
-----	-----	-----	-----	-----	-----	-----	-----	-----	-----	-----	-----	-----	-----	-----	-----	-----



Upholstered shell pad
Asiento y respaldo plafonado

COM	COL	1	2	3	4	5	6	7	8	9	10	11	L1	L2	L3	L6
-----	-----	---	---	---	---	---	---	---	---	---	----	----	----	----	----	----

505	512	519	526	532	540	549	559	568	576	586	595	603	612	645	703	860
-----	-----	-----	-----	-----	-----	-----	-----	-----	-----	-----	-----	-----	-----	-----	-----	-----

Parallel stitching upholstery upcharge (Seat and back)
Incremento tapizado con costuras paralelas (Asiento y respaldo) | 59 |



Parallel stitching upholstery upcharge (Seat)
Incremento tapizado con costuras paralelas (Asiento) | 30 |

BQ1678



Barstool with Eco thermo-polymer shell available in several colors or Pure Eco thermo-polymer (100% recycled) available in sand color and injection swivel central base finished in polished aluminum, white or black. Available options: Upholstered seat pad, upholst red shell pad, fully upholstered shell and parallel stitching upholstery. Fire retardant version available, for further information contact our Sales Department. In upholstered versions the seat height increases 20 mm.

Banqueta alta con carcasa de termopolímero Eco disponible en diferentes colores o termopolímero Pure Eco (100% reciclado) disponible en color arena y base central giratoria de inyección de aluminio en acabado aluminio pulido, blanco o negro. Opciones disponibles: asiento plafonado, asiento y respaldo plafonado, carcasa tapizada y tapizado con costuras paralelas. Versión ignífuga disponible, para más información rogamos contacten con el Departamento Comercial. En versiones tapizadas la altura de asiento aumenta 20 mm.

COM cm. per unit	COL m2
------------------	--------

0,37 m3
14,6 kg
x1

Fully upholstered Carcasa tapizada		2,25
1 units	110	
10 units or more	90	

Seat pad Asiento plafonado		1
1 units	50	
10 units or more	25	

Shell pad Asiento y respaldo plafonado		1,5
1 units	70	
10 units or more	65	

€



TP

382

Thermo-polymer shell
Carcasa termopolímero



Fully upholstered shell
Carcasa tapizada

COM	COL	1	2	3	4	5	6	7	8	9	10	11	L1	L2	L3	L6
540	549	559	568	575	587	599	612	625	640	652	665	681	693	743	833	1.077



Upholstered seat pad
Asiento plafonado

COM	COL	1	2	3	4	5	6	7	8	9	10	11	L1	L2	L3	L6
446	449	450	453	454	457	461	464	466	469	472	475	478	480	491	511	560



Upholstered shell pad
Asiento y respaldo plafonado

COM	COL	1	2	3	4	5	6	7	8	9	10	11	L1	L2	L3	L6
521	527	534	541	545	552	561	569	576	585	592	600	609	616	647	714	889



Parallel stitching upholstery upcharge (Seat and back)
Incremento tapizado con costuras paralelas (Asiento y respaldo) | 59 |



Parallel stitching upholstery upcharge (Seat)
Incremento tapizado con costuras paralelas (Asiento) | 30 |

BQ1679



Counter stool with Eco thermo-polymer shell available in several colors or Pure Eco thermo-polymer (100% recycled) available in sand color and injection swivel central base finished in polished aluminum, white or black. Available options: Upholstered seat pad, upholstered shell pad, fully upholstered shell and parallel stitching upholstery. Fire retardant version available, for further information contact our Sales Department. In upholstered versions the seat height increases 20 mm.

Banqueta baja con carcasa de termopolímero Eco disponible en diferentes colores o termopolímero Pure Eco (100% reciclado) disponible en color arena y base central giratoria de inyección de aluminio en acabado aluminio pulido, blanco negro. Opciones disponibles: Asiento plafonado, asiento y respaldo plafonado, carcasa tapizada y tapizado con costuras paralelas. Versión ignífuga disponible, para más información rogamos contacten con el Departamento Comercial. En versiones tapizadas la altura de asiento aumenta 20 mm.

COM cm. per unit	COL m2
------------------	--------

0,32 m3
14,6 kg
x1

Fully upholstered Carcasa tapizada		2,25
1 units	110	
10 units or more	90	

Seat pad Asiento plafonado		1
1 units	50	
10 units or more	25	

Shell pad Asiento y respaldo plafonado		1,5
1 units	70	
10 units or more	65	

€



TP

382

Thermo-polymer shell
Carcasa termopolímero



Fully upholstered shell
Carcasa tapizada

COM	COL	1	2	3	4	5	6	7	8	9	10	11	L1	L2	L3	L6
540	549	559	568	575	587	599	612	625	640	652	665	681	693	743	833	1.077



Upholstered seat pad
Asiento plafonado

COM	COL	1	2	3	4	5	6	7	8	9	10	11	L1	L2	L3	L6
446	449	450	453	454	457	461	464	466	469	472	475	478	480	491	511	560



Upholstered shell pad
Asiento y respaldo plafonado

COM	COL	1	2	3	4	5	6	7	8	9	10	11	L1	L2	L3	L6
521	527	534	541	545	552	561	569	576	585	592	600	609	616	647	714	889



Parallel stitching upholstery upcharge (Seat and back)
Incremento tapizado con costuras paralelas (Asiento y respaldo) | 59 |



Parallel stitching upholstery upcharge (Seat)
Incremento tapizado con costuras paralelas (Asiento) | 30 |

BQ1680



Barstool with Eco thermo-polymer shell available in several colors or Pure Eco thermo-polymer (100% recycled) available in sand color or and injection swivel central base, adjustable height and finished in polished aluminum, white or black. Available options: Upholstered seat pad, upholstered shell pad, fully upholstered shell and parallel stitching upholstery. Fire retardant version available, for further information contact our Sales Department. Seat height range: 640-770 mm. In upholstered versions the seat height increases 20 mm.

Banqueta alta con carcasa de termopolímero Eco disponible en diferentes colores o termopolímero Pure Eco (100% reciclado) disponible en color arena y base central giratoria de inyección de aluminio, regulable en altura y acabado aluminio pulido, blanco o negro. Opciones disponibles: asiento plafonado, asiento y respaldo plafonado, carcasa tapizada y tapizado con costuras paralelas. Versión ignífuga disponible, para más información rogamos contacten con el Departamento Comercial. Rango de altura de asiento: 640-770 mm. En versiones tapizadas la altura de asiento aumenta 20 mm.

COM cm. per unit	COL m2
------------------	--------

0,32 m3
14,6 kg
x1

Fully upholstered Carcasa tapizada		
1 units	110	2,25
10 units or more	90	

Seat pad Asiento plafonado		
1 units	50	1
10 units or more	25	

Shell pad Asiento y respaldo plafonado		
1 units	70	1,5
10 units or more	65	

€ TP
389



Thermo-polymer shell
Carcasa termopolímero



Fully upholstered shell
Carcasa tapizada



Upholstered seat pad
Asiento plafonado



Upholstered shell pad
Asiento y respaldo plafonado

COM	COL	1	2	3	4	5	6	7	8	9	10	11	L1	L2	L3	L6
552	561	571	580	587	599	611	624	638	653	665	678	695	707	758	850	1.099

COM	COL	1	2	3	4	5	6	7	8	9	10	11	L1	L2	L3	L6
455	458	459	462	463	466	470	473	476	478	481	484	487	490	501	520	570

COM	COL	1	2	3	4	5	6	7	8	9	10	11	L1	L2	L3	L6
532	538	544	550	554	561	570	577	584	591	599	606	616	624	660	728	907



Parallel stitching upholstery upcharge (Seat and back)
Incremento tapizado con costuras paralelas (Asiento y respaldo) | 59 |



Parallel stitching upholstery upcharge (Seat)
Incremento tapizado con costuras paralelas (Asiento) | 30 |

SI1601



Chair with Eco thermo-polymer shell available in several colors or Pure Eco thermo-polymer (100% recycled) available in sand color and a 4-legs solid beech wood base. Available options: Upholstered seat pad, upholstered shell pad, fully upholstered shell and parallel stitching upholstery. Fire retardant version available, for further information contact our Sales Department. In upholstered versions the seat height increases 20 mm.

Silla con carcasa de termopolímero Eco disponible en diferentes colores o termopolímero Pure Eco (100% reciclado) disponible en color arena y base de 4 patas de madera maciza de haya. Opciones disponibles: asiento plafonado, asiento y respaldo plafonado, carcasa tapizada y tapizado con costuras paralelas. Versión ignífuga disponible, para más información rogamos contacten con el Departamento Comercial. Incluido protector de apilado en la versión tapizada. En versiones tapizadas la altura de asiento aumenta 20 mm.

COM cm. per unit	COL m2
------------------	--------

0,31 m3
15 kg
x2

Fully upholstered Carcasa tapizada		
1 units	110	2,25
10 units or more	90	

Seat pad Asiento plafonado		
1 units	50	1
10 units or more	25	

Shell pad Asiento y respaldo plafonado		
1 units	70	1,5
10 units or more	60	

€ TP
283



Thermo-polymer shell
Carcasa termopolímero



Fully upholstered shell
Carcasa tapizada



Upholstered seat pad
Asiento plafonado



Upholstered shell pad
Asiento y respaldo plafonado

COM	COL	1	2	3	4	5	6	7	8	9	10	11	L1	L2	L3	L6
452	461	472	482	489	501	514	527	539	552	565	576	589	600	645	728	965

COM	COL	1	2	3	4	5	6	7	8	9	10	11	L1	L2	L3	L6
371	372	375	378	379	383	386	389	392	396	399	402	405	408	419	440	494

COM	COL	1	2	3	4	5	6	7	8	9	10	11	L1	L2	L3	L6
432	438	445	452	456	465	473	482	490	497	506	514	523	530	559	614	759

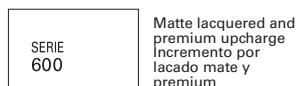

SERIE 600
Matte lacquered and premium upcharge
Incremento por lacado mate y premium | 32 |



SERIE 800
Bright lacquered upcharge
Incremento por lacado brillo | 47 |



Parallel stitching upholstery upcharge (Seat and back)
Incremento tapizado con costuras paralelas (Asiento y respaldo) | 59 |



Parallel stitching upholstery upcharge (Seat)
Incremento tapizado con costuras paralelas (Asiento) | 30 |

BQ1666

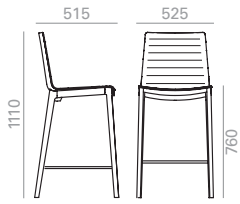

Barstool with Eco thermo-polymer shell available in several colors or Pure Eco thermo-polymer (100% recycled) available in sand col or and 4- legs solid beech wood base. Available options: Upholstered seat pad, upholstered shell pad, fully upholstered shell and parallel stitching upholstery. Fire retardant version available, for further information contact our Sales Department. In upholstered versions the seat height increases 20 mm.

Banqueta alta con carcasa de termopolímero Eco disponible en diferentes colores o termopolímero Pure Eco (100% reciclado) disponible en color arena y base de 4 patas de madera maciza de haya. Opciones disponibles: asiento plafonado, asiento y respaldo plafonado, carcasa tapizada y tapizado con costuras paralelas. Versión ignífuga disponible, para más información rogamos contacten con el Departamento Comercial. En versiones tapizadas la altura de asiento aumenta 20 mm.

COM cm. per unit	COL m2
------------------	--------

0,36 m3
11 kg
x1

Fully upholstered Carcasa tapizada		2,25
1 units	110	
10 units or more	90	

Seat pad Asiento plafonado		1
1 units	50	
10 units or more	25	

Shell pad Asiento y respaldo plafonado		1,5
1 units	70	
10 units or more	60	

€ TP
434



Thermo-polymer shell
Carcasa termopolímero



Fully upholstered shell
Carcasa tapizada



Upholstered seat pad
Asiento plafonado



Upholstered shell pad
Asiento y respaldo plafonado

COM	COL	1	2	3	4	5	6	7	8	9	10	11	L1	L2	L3	L6
622	631	639	647	653	663	674	684	694	705	714	724	736	746	790	873	1.097
521	524	525	528	529	532	536	538	541	544	546	549	552	555	565	584	635
585	590	597	604	608	616	623	631	637	646	654	660	668	675	703	758	904

SERIE 600 Matte lacquered and premium upcharge Incremento por lacado mate y premium | 47 |

SERIE 800 Bright lacquered upcharge Incremento por lacado brillo | 69 |



Parallel stitching upholstery upcharge (Seat and back) Incremento tapizado con costuras paralelas (Asiento y respaldo) | 59 |



Parallel stitching upholstery upcharge (Seat) Incremento tapizado con costuras paralelas (Asiento) | 30 |

BQ1672

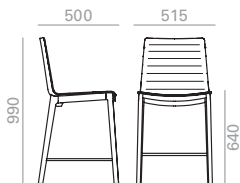

Counter stool with Eco thermo-polymer shell available in several colors or Pure Eco thermo-polymer (100% recycled) available in sand color and 4-legs solid beech wood base. Available options: Upholstered seat pad, upholstered shell pad, fully upholstered shell and parallel stitching upholstery. Fire retardant version available, for further information contact our Sales Department. In upholstered versions the seat height increases 20 mm.

Banqueta baja con carcasa de termopolímero Eco disponible en diferentes colores o termopolímero Pure Eco (100% reciclado) disponible en color arena y base de 4 patas de madera maciza de haya. Opciones disponibles: asiento plafonado, asiento y respaldo plafonado, carcasa tapizada y tapizado con costuras paralelas. Versión ignífuga disponible, para más información rogamos contacten con el Departamento Comercial. En versiones tapizadas la altura de asiento aumenta 20 mm.

COM cm. per unit	COL m2
------------------	--------

0,28 m3
10 kg
x1

Fully upholstered Carcasa tapizada		2,25
1 units	110	
10 units or more	90	

Seat pad Asiento plafonado		1
1 units	50	
10 units or more	25	

Shell pad Asiento y respaldo plafonado		1,5
1 units	70	
10 units or more	60	

€ TP
434



Thermo-polymer shell
Carcasa termopolímero



Fully upholstered shell
Carcasa tapizada



Upholstered seat pad
Asiento plafonado



Upholstered shell pad
Asiento y respaldo plafonado

COM	COL	1	2	3	4	5	6	7	8	9	10	11	L1	L2	L3	L6
622	631	639	647	653	663	674	684	694	705	714	724	736	746	790	873	1.097
521	524	525	528	529	532	536	538	541	544	546	549	552	555	565	584	635
585	590	597	604	608	616	623	631	637	646	654	660	668	675	703	758	904

SERIE 600 Matte lacquered and premium upcharge Incremento por lacado mate y premium | 47 |

SERIE 800 Bright lacquered upcharge Incremento por lacado brillo | 69 |



Parallel stitching upholstery upcharge (Seat and back) Incremento tapizado con costuras paralelas (Asiento y respaldo) | 59 |



Parallel stitching upholstery upcharge (Seat) Incremento tapizado con costuras paralelas (Asiento) | 30 |

Flex High Back accesories / Accesorios Flex High Back

0,01 m³

3,2 kg

1

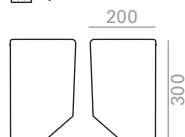

Removable right and left desk accessory for SI-1600 y SI-1621 chairs with panic latch rotation. HPL finished in polished chrome, black or white surface 4-leg frames with writing supports can be stacked up to 4 units deep.

Pala de escritura derecha e izquierda desmontable para sillas SI-1600 y SI-1621 con rotación antipánico. Tablero HPL acabado cromo brillo, blanco o negro. Las estructuras de 4 patas con pala apilan hasta un máximo de 4 unidades.

DR-0802

Right Derecha € 97

DL-0803

Left Izquierda € 97

0,0029 m³

0,2 kg

1

LD0807

4 legs frame Estructura 4 patas € 15
SI1600

LD0808

Sled base frame Estructura de patín € 15
SI1621

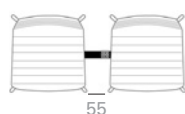

Removable thermo-polymer linking device of available for chairs.

Sistema de unión de Termopolímero desmontable válido para sillas. Se puede ocultar debajo del asiento.

0,0043 m³

0,3 kg

1

LD0809

4 legs frame Estructura 4 patas € 16
SO1610

LD0810

Sled base frame Estructura de patín € 16
SO1632

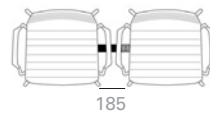

Removable thermo-polymer linking device of available for armchairs.

Sistema de unión de Termopolímero desmontable válido para sillones. Se puede ocultar debajo del asiento.

0,0018 m³

0,1 kg

1

ND0845

€ 11



Numbering device. Consult with Customer Department to customize the project.

Pieza de numeración para el sistema de unión que permite identificar las sillas. Consultar con el Departamento Comercial para personalizar el proyecto.

0,0029 m³

0,2 kg

1

LD0858

Sled base frame Estructura de patín € 17
SI1621

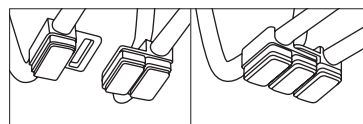

Sliding glide with union system.

Sistema de taco deslizante con sistema de unión incorporado.

Glides for sled bases/cantilever. Tacos para bases de patín/cantilever.

Use/Usó	Reference/Referencia	Material/Material	Price/Precio
Hard floors. Suelos duros.	TS0531	Plastic (PE). Plástico (PE).	0 € Standard. Estándar.
Wooden and delicate floors. Suelos de madera y delicados.	TS0538	Plastic (PE) with felt. Plástico (PE) con fieltro.	6 € Set of 4 glides. Juego de 4 tacos.
Mats/carpet floors. Suelos de moqueta/alfombra.	TS0537	No glide. Sin taco.	0 €

The indicated price is for glides placed on chairs. To order loose parts, please ask to our Sales Department.

El precio indicado en Tarifa es para tacos colocados en las sillas. Para pedidos de tacos sueltos de repuesto, consultar con el Departamento Comercial.

Glides for central base. Tacos para base central.

Use/Usó	Reference/Referencia		Material/Material	Price/Precio	
Hard floors. Suelos duros.	TS0539		Plastic (PE). Plástico (PE).	0 €	Standard. Estándar.
Wooden and delicate floors. Suelos de madera y delicados.	TS0533		Plastic (PE) with felt. Plástico (PE) con fieltro.	3 €	Set of 4 glides. Juego de 4 tacos.
Mats/carpet floors. Suelos de moqueta/ alfombra.	TS0543		Metal. Metal.	3 €	



The indicated price is for glides placed on chairs. To order loose parts, please ask to our Sales Department.

El precio indicado en Tarifa es para tacos colocados en las sillas. Para pedidos de tacos sueltos de repuesto, consultar con el Departamento Comercial.

Glides for 4 metal legs base. Tacos para bases de 4 patas metálicas.

Use/Usó	Reference/Referencia		Material/Material	Price/Precio	
Hard floors. Suelos duros.	TS0558		Plastic (PE). Plástico (PE).	0 €	Standard. Estándar.
Wooden and delicate floors. Suelos de madera y delicados.	TS0534		Plastic (PE) with felt. Plástico (PE) con fieltro.	4 €	Set of 4 glides. Juego de 4 tacos.
Mats/carpet floors. Suelos de moqueta/ alfombra.	TS0559		Metal. Metal.	4 €	Set of 4 glides. Juego de 4 tacos.

Glides for cantilever base. Tacos para base cantiléver.

Use/Usó	Reference/Referencia		Material/Material	Price/Precio	
Hard floors. Suelos duros.	TS0545		Plastic (PE). Plástico (PE).	0 €	Standard. Estándar.
Wooden and delicate floors. Suelos de madera y delicados.	TS0546		Plastic (PE) with felt. Plástico (PE) con fieltro.	6 €	Set of 4 glides. Juego de 4 tacos.
Mats/carpet floors. Suelos de moqueta/ alfombra.	TS0547		No glide. Sin taco.	0 €	

Glides for 4 steel legs with swivel base. Tacos para base giratoria de 4 patas de acero.

Use/Usó	Reference/Referencia		Material/Material	Price/Precio	
Hard floors and mats/ carpet floors. Suelos duros y moqueta/alfombra.	TS0416		Plastic (PE). Plástico (PE).	0 €	Standard. Estándar.
Wooden and delicated floors. Suelos de madera y delicados.	TS0417		Plastic (PE) with felt. Plástico (PE) con fieltro.	12 €	Set of 4 glides. Juego de 4 tacos.

For wooden legs. Para bases de madera.



Optional glides on page 482.
Opciones de tacos deslizantes en página 482.



Casters. Ruedas.



Standard.
Estándar.

CA5004

Metallic trolley for transport stackable seating.
Carro metálico para transportar asientos apilables.

 0,39 m³
 14 kg
 x1

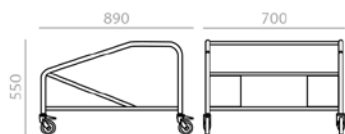

€ 216

Flex High Back stackability



SI1621 AU SOL
10 unités
520 x 865 x 1300 mm.

Tapissé
5 unités
520 x 635 x 990 mm.

SUR CHARRIOT
20 unités
560 x 850 x 1260 mm.

Tapissé
10 unités
520 x 635 x 990 mm.



SO1632 AU SOL
10 unités
620 x 880 x 1300 mm.

Tapissé
5 unités
620 x 635 x 990 mm.

SUR CHARRIOT
15 unités
560 x 850 x 1260 mm.

Tapissé
8 unités
620 x 635 x 990 mm.



SI1600 AU SOL
10 unités
520 x 865 x 1300 mm.

Tapissé
5 unités
520 x 635 x 990 mm.

SUR CHARRIOT
15 unités
560 x 850 x 1260 mm.

Tapissé
8 unités
520 x 635 x 990 mm.



SO1610 AU SOL
10 unités
660 x 880 x 1300 mm.

Tapissé
5 unités
620 x 650 x 990 mm.

SUR CHARRIOT
15 unités
560 x 850 x 1260 mm.

Tapissé
8 unités
620 x 650 x 990 mm.



BQ1677 AU SOL
8 unités
565 x 725 x 1315 mm.

Tapissé
4 unités
565 x 635 x 1245 mm.



BQ1683 AU SOL
8 unités
555 x 725 x 1185 mm.

Tapissé
4 unités
555 x 635 x 1115 mm.



Description
Descripción

Stackable chairs and armchairs with Eco thermopolymer seat and backrest available in different colors or Pure Eco thermopolymer (100% recycled content) available in sand color. The available bases are: 4-legged tube or sled base in steel finished in polished chrome, white or black, or a steel cantilever finished in a black or polished chrome, central swivel aluminum base with self-return system and height-adjustable version, finished in polished aluminum, black or white, tilting mechanism version available. Available options: padded seat, padded seat and backrest, upholstered shell and upholstered with parallel seams. Flame retardant version available, for more information please contact the Sales Department.

Sillas y sillones apilables con asiento y respaldo de termopolímero Eco disponible en diferentes colores o termopolímero Pure Eco (100% reciclado) disponible en color arena. Las bases disponibles son: base de 4 patas de tubo o patín en acero y acabado cromo brillo, blanco o negro o cantiléver de acero en acabado negro o cromo brillo, base central giratoria de aluminio con sistema de retorno y versión regulable en altura, en acabado aluminio pulido, blanco negro, disponible versión basculante. Opciones disponibles: asiento plafonado, asiento y respaldo plafonado, carcasa tapizada y tapizado con costuras paralelas. Versión ignífuga disponible, para más información rogamos contacten con el Departamento Comercial.

Upholstery
Tapicería

The Flex Corporate collection supports following upholsteries of Andreu World Catalogue. All upholstered versions are made with 100% recycled Pure Eco thermo-polymer. For fabrics in our catalogue not specified in this box or customers own materials please contact our Customer Service Department.

La colección Flex Corporate admite las siguientes tapicerías del catálogo de Andreu World. Todas las versiones tapizadas están hechas con termopolímero Pure Eco 100% reciclado. Para las telas de nuestro catálogo no indicadas en este cuadro o telas cliente

Fabrics / Telas

- 1 Jacquard One
Jacquard Three
Sand
Era
Gravity
Rivet
Urban
Spin One
Spin Two
Spin Three
Spin Four
Spin Five

- 2 Jacquard Two
*Loom One
Circular One Pure Eco
Tack One (in/out)

- 3 Jacquard Four
Medley
Revive 1
Main Line Flax
Loom Two (in/out)
Mezzo
Reel two (in/out)
Jacquard Five

- 4 Jacquard 4 Special
Nexus
*Remix 3
Heritage
Savane
Loom Three
Loom Four
Cura
Oceanic
Reel Three (in/out)
Reel Four (in/out)
Reflect
Spin Six

- 5 Silk
Synergy
Step
Step Melange
Blazer
Melange Nap
Chili
Noma
Re-wool

- 6 Go check
Swing
Chartres
Zori
Patio
Tack Two (in/out)
Tack Three (in/out)

- 7 Canvas 2
Select
Clara 2
Tack Five (in/out)
Hero 2

- 8 Capture
Fiord 2
Tonus 4
Divina 3
Lopi
Domino
Atrium

- 9 Divina MD
Divina Melange 3
Hallingdal 65
Steelcut Trio 3
Tack Four (in/out)

- 11 Arda
Ecriture
Zero

Faux Leather / Ecopiel

- 1 Valencia
2 Silvertex
3 Maglia

- 8 Ultraleather

- 9 Brisa
Brisa Distressed
Fresco
Ultraleather Pro
Promessa

- 10 Tottori
Coast (in/out)

- 11 Reef Pro
Volar Bio

Leather / Piel

- L1 High grade cow leather.
Piel de vaca de 1ª categoría.

- L3 Polished full grain leather.
Plena flor pulida.

- L6 Aniline leather batique-effect.
Scandinavian cattle.
Piel anilina efecto batique.
Ganado escandinavo.

* Only available with parallel stitching upholstery.
Solo en tapizado con costuras paralelas.

Aluminum finish
Acabado aluminio



Steel finish
Acabado de acero



Eco Thermo-polymer finish
Acabado de Termo-polímero Eco

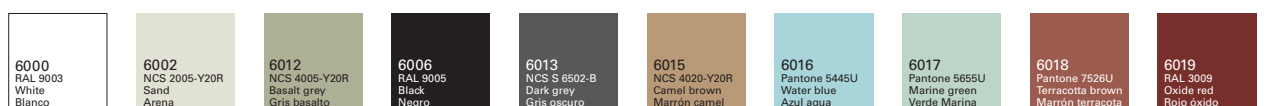

Pure Eco Thermo-polymer finish
Acabado de Termo-polímero Pure Eco



Certificates
Certificados

Fireproof polyurethane foam

Espuma de poliuretano ignífuga

UNE EN 1021:2006
BS 5852 part 2 crib 5
UNI 9175 Classe 1 IM
BKZ 5.2
California TB 117:2013
California TB 133*

*Contact our Customer Department
*Consultar con nuestro Departamento Comercial

Quality - Resistance
Calidad - Resistencia

UNE EN 16139:2013

Intellectual property Propiedad intelectual

All our collections are protected by international industrial design registries, designs patents, copyrights and intellectual Property laws. Unauthorized use of AW International Property is a criminal offence and can lead to prosecution.

Todas nuestras colecciones están protegidas por registros de diseño industrial, diseño de patente, copyright y derechos de propiedad intelectual todo el mundo. El uso no autorizado de los diseños y propiedad intelectual de AW supone un delito que puede ser sometido a acción judicial.



SI1603

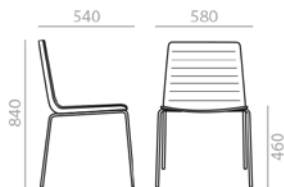

Stackable chair Eco thermo-polymer shell available in several colors or Pure Eco thermo-polymer (100% recycled) available in sand color and 4 tubular steel legs and finished in black or polished chrome. Available options: Upholstered seat pad, upholstered shell pad fully upholstered shell and parallel stitching upholstery. Fire retardant version available, for further information contact our Sale Department. In upholstered versions the seat height increases 20 mm.

Silla apilable con carcasa de termopolímero y base de 4 patas de tubo de acero en acabado negro o cromo brillo. Opciones disponibles: Asiento plafonado, asiento y respaldo plafonado, carcasa tapizada y tapizado con costuras paralelas. Incluido protector de apilado en la versión tapizada. Versión ignífuga disponible, para más información rogamos contacten con el Departamento Comercial. En versiones tapizadas la altura de asiento aumenta 20 mm.

COM cm. per unit	COL m2
------------------	--------

0,37 m3
17 kg
x2

Fully upholstered Carcasa tapizada		
1 units	130	3
10 units or more	120	

Seat pad Asiento plafonado		
1 units	55	1
10 units or more	28	

Shell pad Asiento y respaldo plafonado		
1 units	80	2
10 units or more	80	

10
15

€ TP
190



Thermo-polymer shell
Carcasa termopolímero



Fully upholstered shell
Carcasa tapizada



Upholstered seat pad
Asiento plafonado



Upholstered shell pad
Asiento y respaldo plafonado

COM	COL	1	2	3	4	5	6	7	8	9	10	11	L1	L2	L3	L6
370	384	399	412	423	441	457	475	493	510	528	548	568	584	656	786	1.128
281	284	287	291	293	297	301	305	310	314	318	321	325	329	344	370	441
345	352	362	370	376	387	398	408	419	429	440	451	461	471	509	579	763

Parallel stitching upholstery upcharge (Seat and back)
Incremento tapizado con costuras paralelas (Asiento y respaldo) | 59 |



Parallel stitching upholstery upcharge (Seat)
Incremento tapizado con costuras paralelas (Asiento) | 30 |

SO1611

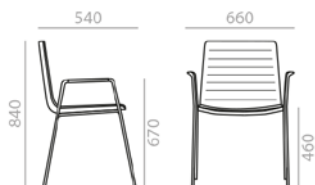

Stackable Armchair with Eco thermo-polymer shell available in several colors or Pure Eco thermo-polymer (100% recycled) available in sand color and 4 tubular steel legs and finished in black or polished chrome. Available options: Upholstered seat pad, upholstered shell pad, fully upholstered shell and parallel stitching upholstery and upholstered arms. Fire retardant version available, for further information contact our Sales Department. In upholstered versions the seat height increases 20 mm.

Sillón apilable con carcasa de termopolímero y base de 4 patas de tubo de acero en acabado negro o cromo brillo. Opciones disponibles: Asiento plafonado, asiento y respaldo plafonado, carcasa tapizada, tapizado con costuras paralelas y brazos tapizados. Incluido protector de apilado en la versión tapizada. Versión ignífuga disponible, para más información rogamos contacten con el Departamento Comercial. En versiones tapizadas la altura de asiento aumenta 20 mm.

COM cm. per unit	COL m2
------------------	--------

0,4 m3
29,4 kg
x2

Fully upholstered Carcasa tapizada		
1 units	130	3
10 units or more	120	

Seat pad Asiento plafonado		
1 units	55	1
10 units or more	28	

Shell pad Asiento y respaldo plafonado		
1 units	80	2
10 units or more	80	

10
15

€ TP
337



Thermo-polymer shell
Carcasa termopolímero



Fully upholstered shell
Carcasa tapizada



Upholstered seat pad
Asiento plafonado



Upholstered shell pad
Asiento y respaldo plafonado

COM	COL	1	2	3	4	5	6	7	8	9	10	11	L1	L2	L3	L6
534	547	563	578	588	605	624	641	660	678	699	720	743	762	866	1.001	1.364
438	442	445	449	451	456	460	465	469	473	477	481	486	488	504	532	606
507	515	525	533	541	552	563	573	585	596	607	619	630	640	680	753	948

Parallel stitching upholstery upcharge (Seat and back)
Incremento tapizado con costuras paralelas (Asiento y respaldo) | 59 |



Parallel stitching upholstery upcharge (Seat)
Incremento tapizado con costuras paralelas (Asiento) | 30 |



Upholstered arm upcharge
Incremento brazo tapizado | 42 |

SI1623

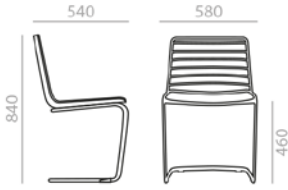

Chair with Eco thermo-polymer shell available in several colors or Pure Eco thermo-polymer (100% recycled) available in sand color and tubular steel cantilever base finished in polished chrome, white or black. Available options: Upholstered seat pad, upholstered shell pad, fully upholstered shell and parallel stitching upholstery. Fire retardant version available, for further information contact or Sales Department. In upholstered versions the seat height increases 20 mm.

Silla con carcasa de termopolímero y base cantiléver de tubo de acero en acabado negro o cromo brillo. Opciones disponibles: Asiento plafonado, asiento y respaldo plafonado, carcasa tapizada y tapizado con costuras paralelas. Versión ignífuga disponible, para más información rogamos contacten con el Departamento Comercial. En versiones tapizadas la altura de asiento aumenta 20 mm.

COM cm. per unit	COL m2
------------------	--------

0,27 m3
24,4 kg
x2

Fully upholstered Carcasa tapizada		
1 units	130	3
10 units or more	120	

Seat pad Asiento plafonado		
1 units	55	1
10 units or more	28	

Shell pad Asiento y respaldo plafonado		
1 units	80	2
10 units or more	80	

€ TP
332



Thermo-polymer shell
Carcasa termopolímero



Fully upholstered shell
Carcasa tapizada



Upholstered seat pad
Asiento plafonado



Upholstered shell pad
Asiento y respaldo plafonado

COM	COL	1	2	3	4	5	6	7	8	9	10	11	L1	L2	L3	L6
453	466	483	497	508	527	545	563	583	606	628	651	673	694	774	921	1.331
COM	COL	1	2	3	4	5	6	7	8	9	10	11	L1	L2	L3	L6
401	404	408	412	415	421	425	429	435	439	445	449	454	459	476	508	592
COM	COL	1	2	3	4	5	6	7	8	9	10	11	L1	L2	L3	L6
497	508	519	530	537	551	563	577	590	604	618	630	644	655	704	791	1.021

Parallel stitching upholstery upcharge (Seat and back)
Incremento tapizado con costuras paralelas (Asiento y respaldo) | 59 |



Parallel stitching upholstery upcharge (Seat)
Incremento tapizado con costuras paralelas (Asiento) | 30 |

SO1634

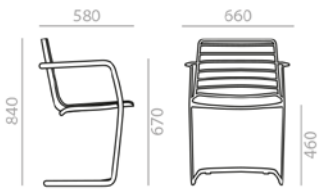

Armchair with Eco thermo-polymer shell available in several colors or Pure Eco thermo-polymer (100% recycled) available in sand color fully upholstered seat and backrest and tubular steel cantilever base finished in polished chrome, white or black. Available options: Upholstered seat pad, upholstered shell pad, fully upholstered shell, parallel stitching upholstery and upholstered arms. Fire retardant version available, for further information contact our Sales Department. In upholstered versions the seat height increases 20 mm.

Sillón con carcasa de termopolímero y base cantiléver de tubo de acero en acabado negro o cromo brillo. Opciones disponibles: Asiento plafonado, asiento y respaldo plafonado, carcasa tapizada, tapizado con costuras paralelas y brazos tapizados. Versión ignífuga disponible, para más información rogamos contacten con el Departamento Comercial. En versiones tapizadas la altura de asiento aumenta 20 mm.

COM cm. per unit	COL m2
------------------	--------

0,35 m3
15 kg
x1

Fully upholstered Carcasa tapizada		
1 units	130	3
10 units or more	120	

Seat pad Asiento plafonado		
1 units	55	1
10 units or more	28	

Shell pad Asiento y respaldo plafonado		
1 units	80	2
10 units or more	80	

€ TP
370



Thermo-polymer shell
Carcasa termopolímero



Fully upholstered shell
Carcasa tapizada



Upholstered seat pad
Asiento plafonado



Upholstered shell pad
Asiento y respaldo plafonado

COM	COL	1	2	3	4	5	6	7	8	9	10	11	L1	L2	L3	L6
504	514	527	538	545	560	578	595	615	631	650	668	687	703	770	892	1.213
COM	COL	1	2	3	4	5	6	7	8	9	10	11	L1	L2	L3	L6
449	452	455	458	461	463	468	470	475	477	482	484	489	492	507	534	608
COM	COL	1	2	3	4	5	6	7	8	9	10	11	L1	L2	L3	L6
547	554	563	572	577	587	597	607	617	627	638	651	662	672	715	793	998

Parallel stitching upholstery upcharge (Seat and back)
Incremento tapizado con costuras paralelas (Asiento y respaldo) | 59 |



Parallel stitching upholstery upcharge (Seat)
Incremento tapizado con costuras paralelas (Asiento) | 30 |



Upholstered arm upcharge
Incremento brazo tapizado | 42 |

SI1639



Chair with Eco thermo-polymer shell available in several colors or Pure Eco thermo-polymer (100% recycled) available in sand color and a 4-star central aluminum swivel base with self-return system and finished in polished aluminum, white or black. Available options: Upholstered seat pad, upholstered shell pad, fully upholstered shell and parallel stitching upholstery. Fire retardant version available, or further information contact our Sales Department. In upholstered versions the seat height increases 20 mm.

Silla con carcasa de termopolímero y base central giratoria de aluminio de 4 aspas con sistema de retorno disponible en acabado aluminio pulido, blanco o negro. Opciones disponibles: Asiento plafonado, asiento y respaldo plafonado, carcasa tapizada y tapizado con costuras paralelas. Versión ignífuga disponible, para más información rogamos contacten con el Departamento Comercial. En versiones tapizadas la altura de asiento aumenta 20 mm.

COM cm. per unit	COL m2
------------------	--------

0,27 m3
9,5 kg
x1

Fully upholstered Carcasa tapizada		
1 units	130	3
10 units or more	120	

Seat pad Asiento plafonado		
1 units	55	1
10 units or more	28	

Shell pad Asiento y respaldo plafonado		
1 units	80	2
10 units or more	80	

€ TP
371



Thermo-polymer shell
Carcasa termopolímero



Fully upholstered shell
Carcasa tapizada



Upholstered seat pad
Asiento plafonado



Upholstered shell pad
Asiento y respaldo plafonado

COM	COL	1	2	3	4	5	6	7	8	9	10	11	L1	L2	L3	L6
542	556	570	584	598	619	637	658	675	696	714	735	754	770	841	966	1.301
473	477	480	484	486	490	494	498	503	507	511	515	520	524	539	566	640
542	550	560	568	575	586	597	608	619	630	643	654	665	674	714	787	981



Optional casters.
(No swivel base).
Opción de ruedas.
(Base no giratoria).



Parallel stitching
upholstery upcharge
(Seat and back)
Incremento tapizado
con costuras
paralelas (Asiento y
respaldo)

59

SO1645

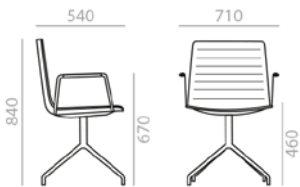

Armchair with Eco thermo-polymer shell available in several colors or Pure Eco thermo-polymer (100% recycled) available in sand color and a 4-star central aluminum swivel base with self-return system and finished in polished aluminum, white or black. Available options: Upholstered seat pad, upholstered shell pad, fully upholstered shell, parallel stitching upholstery and upholstered arms. Fire retardant version available, for further information contact our Sales Department. In upholstered versions the seat height increases 20 mm.

Sillón con carcasa de termopolímero y base central giratoria de aluminio de 4 aspas con sistema de retorno disponible en acabado aluminio pulido, blanco o negro. Opciones disponibles: Asiento plafonado, asiento y respaldo plafonado, carcasa tapizada, tapizado con costuras paralelas y brazos tapizados. Versión ignífuga disponible, para más información rogamos contacten con el Departamento Comercial. En versiones tapizadas la altura de asiento aumenta 20 mm.

COM cm. per unit	COL m2
------------------	--------

0,34 m3
10,5 kg
x1

Fully upholstered Carcasa tapizada		
1 units	130	3
10 units or more	120	

Seat pad Asiento plafonado		
1 units	55	1
10 units or more	28	

Shell pad Asiento y respaldo plafonado		
1 units	80	2
10 units or more	80	

€ TP
563



Thermo-polymer shell
Carcasa termopolímero



Fully upholstered shell
Carcasa tapizada



Upholstered seat pad
Asiento plafonado



Upholstered shell pad
Asiento y respaldo plafonado

COM	COL	1	2	3	4	5	6	7	8	9	10	11	L1	L2	L3	L6
759	771	786	798	808	825	842	858	874	890	907	924	941	955	1.014	1.131	1.443
666	669	672	676	678	682	686	690	693	697	702	706	710	713	727	754	822
741	750	758	767	772	784	793	805	815	826	836	847	857	867	905	975	1.159



Optional casters.
(No swivel base).
Opción de ruedas.
(Base no giratoria).



Parallel stitching
upholstery upcharge
(Seat and back)
Incremento tapizado
con costuras
paralelas (Asiento y
respaldo)

59



Parallel stitching
upholstery upcharge
(Seat)
Incremento tapizado
con costuras
paralelas (Asiento)

30

SI1657

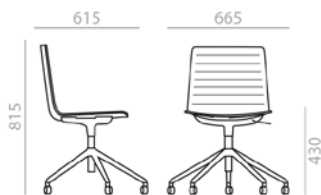

Chair with aluminum central swivel base with 5 casters, height adjustment and polished aluminum finish, white or black. Thermo-polymer shell available in several colors or Pure ECO thermo-polymer (100% recycled) available in sand color. Available options: Upholstered seat pad, upholstered shell pad, fully upholstered shell and parallel stitching upholstery. Fire retardant version available, for further information contact our Sales Department. Seat height range: 430-530 mm. In upholstered versions the seat height increases 20 mm.

Silla con carcasa de termopolímero Eco disponible en diferentes colores o termopolímero Pure Eco (100% reciclado) disponible en color arena y base central giratoria de aluminio con 5 ruedas, regulable en altura y acabado aluminio pulido, blanco o negro. Opciones disponibles: Asiento plafonado, asiento y respaldo plafonado, carcasa tapizada y tapizado con costuras paralelas. Versión ignífuga disponible, para más información rogamos contacten con el Departamento Comercial. Rango de altura de asiento: 430-530 mm. En versiones tapizadas la altura de asiento aumenta 20 mm.

COM cm. per unit	COL m2
------------------	--------

0,34 m3
11 kg
x1

Fully upholstered Carcasa tapizada		
1 units	130	3
10 units or more	120	

Seat pad Asiento plafonado		
1 units	55	1
10 units or more	28	

Shell pad Asiento y respaldo plafonado		
1 units	80	2
10 units or more	80	

TP
392



Thermo-polymer shell Carcasa termopolímero



Fully upholstered shell Carcasa tapizada



Upholstered seat pad Asiento plafonado



Upholstered shell pad Asiento y respaldo plafonado

COM	COL	1	2	3	4	5	6	7	8	9	10	11	L1	L2	L3	L6
562	576	594	609	621	640	661	681	700	720	739	759	780	797	868	999	1.355

COM	COL	1	2	3	4	5	6	7	8	9	10	11	L1	L2	L3	L6
483	486	490	494	497	503	507	513	517	522	527	532	536	541	559	591	677

COM	COL	1	2	3	4	5	6	7	8	9	10	11	L1	L2	L3	L6
534	543	554	564	571	584	596	608	620	633	644	657	670	681	725	806	1.021

Parallel stitching upholstery upcharge (Seat and back) Incremento tapizado con costuras paralelas (Asiento y respaldo) | 59 |



Parallel stitching upholstery upcharge (Seat) Incremento tapizado con costuras paralelas (Asiento) | 30 |



SI1669

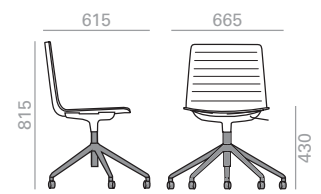

Chair with Eco thermo-polymer shell available in several colors or Pure Eco thermo-polymer (100% recycled) available in sand color and Eco thermo-polymer central base with 5 casters, swivel and pneumatic height adjustment, finished in black. Available options: Upholstered seat pad, upholstered shell pad, fully upholstered shell and parallel stitching upholstery. Fire retardant version available, for further information contact our Sales Department. Seat height range: 430-530 mm. In upholstered versions the seat height increases 20 mm.

Silla con carcasa de termopolímero Eco disponible en diferentes colores o termopolímero Pure Eco (100% reciclado) disponible en color arena y base central giratoria de termopolímero Eco de 5 ruedas, regulable en altura y acabado negro. Opciones disponibles: Asiento plafonado, asiento y respaldo plafonado, carcasa tapizada y tapizado con costuras paralelas. Versión ignífuga disponible, para más información rogamos contacten con el Departamento Comercial. Rango de altura de asiento: 430-530 mm. En versiones tapizadas la altura de asiento aumenta 20 mm.

COM cm. per unit	COL m2
------------------	--------

0,33 m3
10 kg
x1

Fully upholstered Carcasa tapizada		
1 units	130	3
10 units or more	120	

Seat pad Asiento plafonado		
1 units	55	1
10 units or more	28	

Shell pad Asiento y respaldo plafonado		
1 units	80	2
10 units or more	80	

TP
255



Thermo-polymer shell Carcasa termopolímero



Fully upholstered shell Carcasa tapizada



Upholstered seat pad Asiento plafonado



Upholstered shell pad Asiento y respaldo plafonado

COM	COL	1	2	3	4	5	6	7	8	9	10	11	L1	L2	L3	L6
423	438	455	470	482	500	519	539	559	578	599	619	639	656	730	863	1.216

COM	COL	1	2	3	4	5	6	7	8	9	10	11	L1	L2	L3	L6
357	360	364	368	371	377	381	387	391	396	401	406	411	415	433	466	550

COM	COL	1	2	3	4	5	6	7	8	9	10	11	L1	L2	L3	L6
432	442	453	463	470	483	496	508	521	534	547	560	572	584	631	714	937

Parallel stitching upholstery upcharge (Seat and back) Incremento tapizado con costuras paralelas (Asiento y respaldo) | 59 |



Parallel stitching upholstery upcharge (Seat) Incremento tapizado con costuras paralelas (Asiento) | 30 |



SO1660



Armchair with Eco thermo-polymer shell available in several colors or Pure Eco thermo-polymer (100% recycled) available in sand color and aluminum central swivel base with 5 casters, height adjustment and polished aluminum finish, white or black. Available options: Upholstered seat pad, upholstered shell pad, fully upholstered shell, parallel stitching upholstery and upholstered arms. Fire retardant version available, for further information contact our Sales Department. Height ranges: seat 430-530 mm./arms 615-715 mm. In upholstered versions the seat height increases 20 mm.

Sillón con carcasa de termopolímero Eco disponible en diferentes colores o termopolímero Pure Eco (100% reciclado) disponible en color arena y base central giratoria de aluminio con 5 ruedas, regulable en altura y acabado aluminio pulido, blanco o negro. Opciones disponibles: Asiento plafonado, asiento y respaldo plafonado, carcasa tapizada, tapizado con costuras paralelas y brazos tapizados. Versión ignífuga disponible, para más información rogamos contacten con el Departamento Comercial. Rangos de altura: asiento 430-530 mm./brazos 615-715 mm. En versiones tapizadas la altura de asiento aumenta 20 mm.

COM cm. per unit	COL m2
------------------	--------

0,37 m3
17 kg
x1

Fully upholstered Carcasa tapizada		
1 units	130	3
10 units or more	120	

Seat pad Asiento plafonado		
1 units	55	1
10 units or more	28	

Shell pad Asiento y respaldo plafonado		
1 units	80	2
10 units or more	80	

€ TP
570



Thermo-polymer shell Carcasa termopolímero



Fully upholstered shell Carcasa tapizada



Upholstered seat pad Asiento plafonado



Upholstered shell pad Asiento y respaldo plafonado

COM	COL	1	2	3	4	5	6	7	8	9	10	11	L1	L2	L3	L6
766	778	795	809	820	838	856	874	893	911	929	947	965	980	1.047	1.165	1.487
670	674	677	681	684	688	692	697	701	705	709	713	718	722	737	767	843
724	732	742	750	758	769	780	791	803	814	825	836	848	858	898	973	1.170



Parallel stitching upholstery upcharge (Seat and back) Incremento tapizado con costuras paralelas (Asiento y respaldo) | 59 |



Parallel stitching upholstery upcharge (Seat) Incremento tapizado con costuras paralelas (Asiento) | 30 |



Upholstered arm upcharge Incremento brazo tapizado | 42 |

SO1670

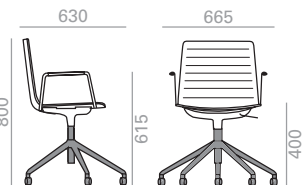

Armchair with Eco thermo-polymer shell available in several colors or Pure Eco thermo-polymer (100% recycled) available in sand color and Eco thermo-polymer central base with 5 casters, swivel and pneumatic height adjustment, finished in black. Available options: Upholstered seat pad, upholstered shell pad, fully upholstered shell, parallel stitching upholstery and upholstered arms. Fire retardant version available, for further information contact our Sales Department. Height ranges: seat 430-530 mm./arms 615-715 mm. In upholstered versions the seat height increases 20 mm.

Sillón con carcasa de termopolímero Eco disponible en diferentes colores o termopolímero Pure Eco (100% reciclado) disponible en color arena y base central giratoria de termopolímero Eco de 5 ruedas, regulable en altura y acabado negro. Opciones disponibles: Asiento plafonado, asiento y respaldo plafonado, carcasa tapizada, tapizado con costuras paralelas y brazos tapizados. Versión ignífuga disponible, para más información rogamos contacten con el Departamento Comercial. Rangos de altura: asiento 430-530 mm./brazos 615-715 mm. En versiones tapizadas la altura de asiento aumenta 20 mm.

COM cm. per unit	COL m2
------------------	--------

0,41 m3
16 kg
x1

Fully upholstered Carcasa tapizada		
1 units	130	3
10 units or more	120	

Seat pad Asiento plafonado		
1 units	55	1
10 units or more	28	

Shell pad Asiento y respaldo plafonado		
1 units	80	2
10 units or more	80	

€ TP
443



Thermo-polymer shell Carcasa termopolímero



Fully upholstered shell Carcasa tapizada



Upholstered seat pad Asiento plafonado



Upholstered shell pad Asiento y respaldo plafonado

COM	COL	1	2	3	4	5	6	7	8	9	10	11	L1	L2	L3	L6
626	642	660	675	688	707	728	748	769	790	810	831	850	868	942	1.077	1.432
544	548	552	556	559	565	569	574	580	584	590	594	600	604	622	656	744
618	628	639	649	657	670	684	697	709	723	736	749	763	774	822	908	1.137



Parallel stitching upholstery upcharge (Seat and back) Incremento tapizado con costuras paralelas (Asiento y respaldo) | 59 |



Parallel stitching upholstery upcharge (Seat) Incremento tapizado con costuras paralelas (Asiento) | 30 |



Upholstered arm upcharge Incremento brazo tapizado | 42 |

Glides for central base. Tacos para base central.

Use/Usó	Reference/Referencia		Material/Material	Price/Precio	
Hard floors. Suelos duros.	TS0539		Plastic (PE). Plástico (PE).	0 €	Standard. Estándar.
Wooden and delicated floors. Suelos de madera y delicados.	TS0533		Plastic (PE) with felt. Plástico (PE) con fieltro.	3 €	Set of 4 glides. Juego de 4 tacos.
Mats/carpet floors. Suelos de moqueta/ alfombra.	TS0543		Metal. Metal.	3 €	

The indicated price is for glides placed on chairs. To order loose parts, please ask to our Sales Department.

El precio indicado en Tarifa es para tacos colocados en las sillas. Para pedidos de tacos sueltos de repuesto, consultar con el Departamento Comercial.



Glides for 4 metal legs base. Tacos para bases de 4 patas metálicas.

Use/Usó	Reference/Referencia		Material/Material	Price/Precio	
Hard floors. Suelos duros.	TS0558		Plastic (PE). Plástico (PE).	0 €	Standard. Estándar.
Wooden and delicated floors. Suelos de madera y delicados.	TS0534		Plastic (PE) with felt. Plástico (PE) con fieltro.	4 €	Set of 4 glides. Juego de 4 tacos.
Mats/carpet floors. Suelos de moqueta/ alfombra.	TS0559		Metal. Metal.	4 €	Set of 4 glides. Juego de 4 tacos.

Glides for sled bases/cantilever. Tacos para bases de patín/cantilever.

Use/Usó	Reference/Referencia		Material/Material	Price/Precio	
Hard floors. Suelos duros.	TS0531		Plastic (PE). Plástico (PE).	0 €	Standard. Estándar.
Wooden and delicated floors. Suelos de madera y delicados.	TS0538		Plastic (PE) with felt. Plástico (PE) con fieltro.	6 €	Set of 4 glides. Juego de 4 tacos.
Mats/carpet floors. Suelos de moqueta/ alfombra.	TS0537		No glide. Sin taco.	0 €	

Glides for cantilever base. Tacos para base cantiléver.

Use/Usó	Reference/Referencia		Material/Material	Price/Precio	
Hard floors. Suelos duros.	TS0545		Plastic (PE). Plástico (PE).	0 €	Standard. Estándar.
Wooden and delicate floors. Suelos de madera y delicados.	TS0546		Plastic (PE) with felt. Plástico (PE) con fieltro.	6 €	Set of 4 glides. Juego de 4 tacos.
Mats/carpet floors. Suelos de moqueta/ alfombra.	TS0547		No glide. Sin taco.	0 €	

The indicated price is for glides placed on chairs. To order loose parts, please ask to our Sales Department.

El precio indicado en Tarifa es para tacos colocados en las sillas. Para pedidos de tacos sueltos de repuesto, consultar con el Departamento Comercial.

Flex Corporate stackability



SI1603 AU SOL
10 unités
730 x 1200 x 1750 mm.

Tapissé
5 unités
580 x 660 x 1020 mm.

SUR CHARRIOT
15 unités
560 x 850 x 1260 mm.

Tapissé
8 unités
580 x 660 x 1020 mm.



SO1611 AU SOL
10 unités
730 x 1200 x 1750 mm.

Tapissé
5 unités
660 x 660 x 1020 mm.

SUR CHARRIOT
15 unités
560 x 850 x 1260 mm.

Tapissé
8 unités
660 x 660 x 1020 mm.

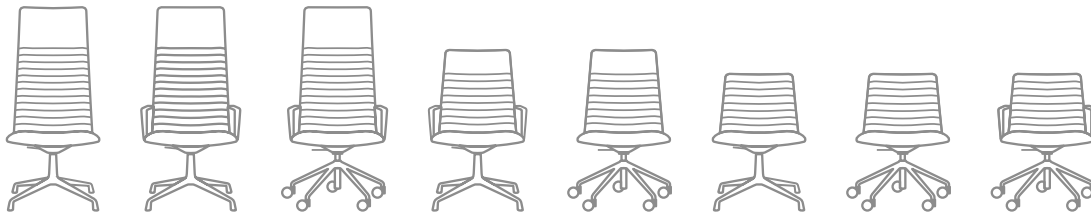

Description

Descripción

Chairs and armchairs with upholstered shell and aluminum swivel four-star base with self-return system and finished in polished aluminum, white or black or height-adjustable central swivel base with 5 casters finished in polished aluminum, white or black. Available in 3 back heights. Lounge chair versions with aluminum swivel four-star base with self-return or height adjustable central swivel base with 5 casters and self-return. Both base options are finished in polished aluminum, white or black. The lounge chair is available in 2 back heights. Additional options include: parallel upholstery stitching, tilt mechanism and back finished in walnut veneer.

Sillas y sillones con carcasa tapizada y bases central giratoria de aluminio de 4 aspas con sistema de retorno en acabado aluminio pulido, blanco o negro o base central giratoria con 5 ruedas regulable en altura disponible en aluminio pulido, blanco o negro. Disponibles en 3 alturas diferentes de respaldo. Versiones de butaca con bases central giratoria de aluminio de 4 aspas con sistema de retorno en acabado aluminio pulido, blanco o negro o base central giratoria con 5 ruedas regulable en altura en acabado aluminio pulido, blanco o negro. Disponibles en 2 alturas diferentes de respaldo. Opción de tapizado con costuras paralelas. Opción de sistema basculante. Opción de respaldo en madera de nogal.

Upholstery

Tapicería

The Flex Executive collection supports following upholsteries of Andreu World Catalogue. For fabrics in our catalogue not specified in this box or customers own materials please contact our Customer Service Department.

La colección Flex Executive admite las siguientes tapicerías del catálogo de Andreu World. Para las telas de nuestro catálogo no indicadas en este cuadro o telas cliente, consultar con nuestro Departamento Comercial.

Fabrics / Telas

1 Jacquard One
Jacquard Three
Sand
Era
Gravity
Rivet
Urban
Spin One
Spin Two
Spin Three
Spin Four
Spin Five

2 Jacquard Two
*Loom One
Circular One Pure Eco
Tack One (in/out)

3 Jacquard Four
Medley
Revive 1
Main Line Flax
Loom Two (in/out)
Mezzo
Reel two (in/out)
Jacquard Five

4 Jacquard 4 Special
Nexus
*Remix 3
Heritage
Savane
Loom Three
Loom Four
Cura
Oceanic
Reel Three (in/out)
Reel Four (in/out)
Reflect
Spin Six

5 Silk
Synergy
Step
Step Melange
Blazer
Melange Nap
Chili
Noma
Re-wool

6 Go check
Swing
Chartres
Zori
Patio
Tack Two (in/out)
Tack Three (in/out)

7 Canvas 2
Select
Clara 2
Tack Five (in/out)
Hero 2

8 Capture
Fiord 2
Tonus 4
Divina 3
Lopi
Domino
Atrium

9 Divina MD
Divina Melange 3
Hallingdal 65
Steelcut Trio 3
Tack Four (in/out)

11 Arda
Ecriture
Zero

Faux Leather / Ecopiel

1 Valencia
2 Silvertex
3 Maglia

8 Ultraleather

9 Brisa
Brisa Distressed
Fresco
Ultraleather Pro
Promessa

10 Tottori
Coast (in/out)

11 Reef Pro
Volar Bio

Leather / Piel

***L1** High grade cow leather.
Piel de vaca de 1ª categoría.
Not available / No disponible
(4226, 4236, 4075)

***L3** Polished full grain leather.
Plena flor pulida.
Not available / No disponible
(1800, 4830)

L6 Aniline leather batique-effect.
Scandinavian cattle.
Piel anilina efecto batique.
Ganado escandinavo.

* Only available with parallel stitching upholstery.
Solo en tapizado con costuras paralelas.

Aluminum finish

Acabado aluminio



Eco Thermo-polymer finish

Acabado de Termo-polimero Eco

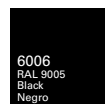

Wood finish Walnut

Acabado madera Nogal

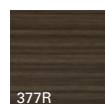

Certificates

Certificados

Fireproof polyurethane foam

Espuma de poliuretano ignifuga

UNE EN 1021:2006
BS 5852 part 2 crib 5
UNI 9175 Classe 1 IM
BKZ 5.2

California TB 117:2013
California TB 133*

*Contact our Customer Department

*Consultar con nuestro Departamento Comercial

Quality - Resistance

Calidad - Resistencia

UNE EN 16139:2013

Intellectual property Propiedad intelectual

All our collections are protected by international industrial design registries, designs patents, copyrights and intellectual Property laws. Unauthorized use of AW International Property is a criminal offence and can lead to prosecution.

Todas nuestras colecciones están protegidas por registros de diseño industrial, diseño de patente, copyright y derechos de propiedad intelectual todo el mundo. El uso no autorizado de los diseños y propiedad intelectual de AW supone un delito que puede ser sometido a acción judicial.



SI1838

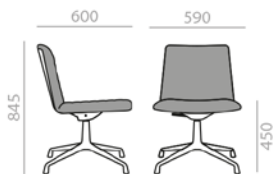

Low back chair with upholstered shell and aluminum swivel 4-star base with self-return and finished in polished aluminum, white or black. Additional options include: parallel upholstery stitching, tilting mechanism and back finished in walnut veneer.

Silla de respaldo bajo con carcasa tapizada y base central giratoria de aluminio de 4 aspas con sistema de retorno en acabado aluminio pulido, blanco o negro. Opción de tapizado con costuras paralelas. Opción de sistema basculante. Opción de respaldo en madera de nogal.

COM cm. per unit	COL m2
------------------	--------

0,33 m3
12,8 kg
x1

Fully upholstered Carcasa tapizada		2,7
1 units	115	
10 units or more	95	

Walnut back Respaldo nogal		2,75
1 units	130	
10 units or more	90	

COM	COL	1	2	3	4	5	6	7	8	9	10	11	L1	L2	L3	L6
€ 631	640	651	661	668	681	692	705	718	729	742	754	768	780	827	914	1.147

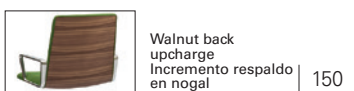
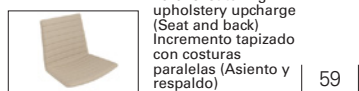

SO1844

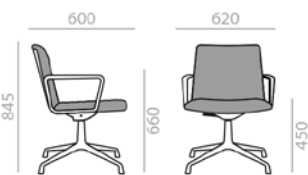

Low back armchair with upholstered shell and aluminum swivel 4-star base with self-return and finished in polished aluminum, white or black. Additional options include: parallel upholstery stitching, tilting mechanism and back finished in walnut veneer.

Sillón de respaldo bajo con carcasa tapizada y base central giratoria de aluminio de 4 aspas con sistema de retorno en acabado aluminio pulido, blanco o negro. Opción de tapizado con costuras paralelas. Opción de sistema basculante. Opción de respaldo en madera de nogal.

COM cm. per unit	COL m2
------------------	--------

0,33 m3
15,9 kg
x1

Fully upholstered Carcasa tapizada		2,7
1 units	115	
10 units or more	95	

Walnut back Respaldo nogal		2,75
1 units	130	
10 units or more	90	

COM	COL	1	2	3	4	5	6	7	8	9	10	11	L1	L2	L3	L6
€ 891	903	914	925	933	947	961	974	988	1.002	1.015	1.030	1.042	1.055	1.105	1.199	1.468

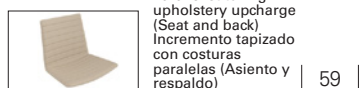

SI1856

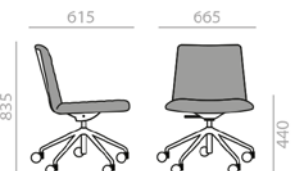

Low back chair with upholstered shell and height adjustable central swivel base with 5 casters finished in polished aluminum, white or black. Additional options include: parallel upholstery stitching, tilting mechanism and back finished in walnut veneer. Height ranges: seat 440-540 mm.

Silla de respaldo bajo con carcasa tapizada y base central giratoria con 5 ruedas regulable en altura en acabado aluminio pulido, blanco o negro. Opción de tapizado con costuras paralelas. Opción de sistema basculante. Opción de respaldo en madera de nogal. Rango de altura de asiento: 440-540 mm.

COM cm. per unit	COL m2
------------------	--------

0,33 m3
13,5 kg
x1

Fully upholstered Carcasa tapizada		2,7
1 units	115	
10 units or more	95	

Walnut back Respaldo nogal		2,75
1 units	130	
10 units or more	90	

COM	COL	1	2	3	4	5	6	7	8	9	10	11	L1	L2	L3	L6
€ 651	663	674	685	692	706	719	733	746	760	773	787	801	812	862	950	1.184

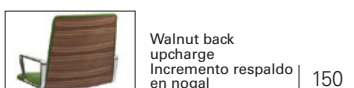
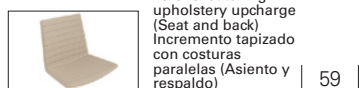

SI1862

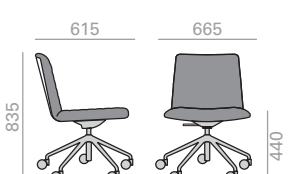

Low back chair with upholstered shell and Eco thermo-polymer central base with 5 casters, swivel and pneumatic height adjustment, finished in black. Available options: Parallel upholstery stitching, tilting mechanism and back finished in walnut veneer. Height ranges: seat 440-540 mm.

Silla de respaldo bajo con carcasa tapizada y base central giratoria de termopolímero Eco de 5 ruedas, regulable en altura y acabado negro. Opciones disponibles: Tapizado con costuras paralelas, sistema basculante y respaldo en madera de nogal. Rango de altura de asiento: 440-540 mm.

COM cm. per unit	COL m2
------------------	--------

0,36 m3
14,5 kg
x1

Fully upholstered Carcasa tapizada		2,7
1 units	115	
10 units or more	95	

Walnut back Respaldo nogal		2,75
1 units	130	
10 units or more	90	

COM	COL	1	2	3	4	5	6	7	8	9	10	11	L1	L2	L3	L6
€ 554	564	575	585	592	605	618	630	646	668	693	714	738	754	838	923	1.082

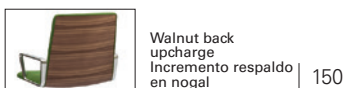
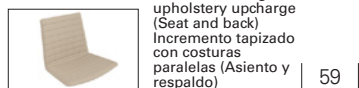

SO1859

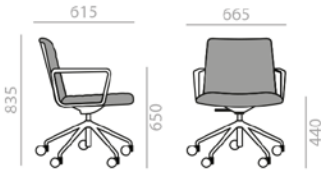

Low back armchair with upholstered shell and height adjustable central swivel base with 5 casters finished in polished aluminum, white or black. Additional options include: parallel upholstery stitching, tilting mechanism and back finished in walnut veneer. Height ranges: seat 440-540 mm./arms 650-750 mm.

Sillón de respaldo bajo con carcasa tapizada y base central giratoria con 5 ruedas regulable en altura en acabado aluminio pulido, blanco negro. Opción de tapizado con costuras paralelas. Opción de sistema basculante. Opción de respaldo en madera de nogal. Rangos de altura: asiento 440-540 mm./brazos 650-750 mm.

COM cm. per unit	COL m2
------------------	--------

0,36 m3
16,7 kg
x1

Fully upholstered Carcasa tapizada		2,7
1 units	115	
10 units or more	95	

Walnut back Respaldo nogal		2,75
1 units	130	
10 units or more	90	

COM	COL	1	2	3	4	5	6	7	8	9	10	11	L1	L2	L3	L6
€ 891	901	914	925	934	948	962	977	990	1.004	1.018	1.032	1.047	1.059	1.111	1.205	1.478



Tilting mechanism upcharge
Incremento por sistema basculante

35



Parallel stitching upholstery upcharge (Seat and back)
Incremento tapizado con costuras paralelas (Asiento y respaldo)

59



Upholstered arm upcharge
Incremento brazo tapizado

42



Walnut back upcharge
Incremento respaldo en nogal

150

SO1863

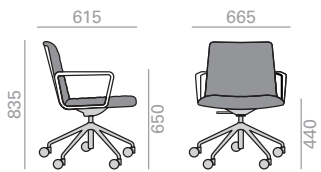

Low back armchair with upholstered shell and Eco thermo-polymer central base with 5 casters, swivel and pneumatic height adjustment, finished in black. Available options: Parallel upholstery stitching, tilting mechanism and back finished in walnut veneer. Height ranges: seat 440-540 mm./arms 650-750 mm.

Sillón de respaldo bajo con carcasa tapizada y base central giratoria de termopolímero Eco de 5 ruedas, regulable en altura y acabado negro. Opciones disponibles: Tapizado con costuras paralelas, sistema basculante y respaldo en madera de nogal. Rangos de altura: asiento 440-540 mm./brazos 650-750 mm.

COM cm. per unit	COL m2
------------------	--------

0,33 m3
15,7 kg
x1

Fully upholstered Carcasa tapizada		2,7
1 units	115	
10 units or more	95	

Walnut back Respaldo nogal		2,75
1 units	130	
10 units or more	2'75	

COM	COL	1	2	3	4	5	6	7	8	9	10	11	L1	L2	L3	L6
€ 784	794	808	820	829	845	860	875	890	906	921	936	952	965	1.021	1.250	1.423



Tilting mechanism upcharge
Incremento por sistema basculante

35



Parallel stitching upholstery upcharge (Seat and back)
Incremento tapizado con costuras paralelas (Asiento y respaldo)

59



Upholstered arm upcharge
Incremento brazo tapizado

42



Walnut back upcharge
Incremento respaldo en nogal

150

SI1839

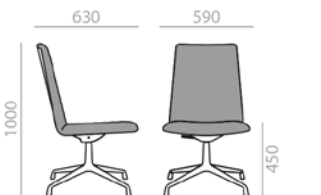

Intermediate back chair with upholstered shell and aluminum swivel 4- star base with self-return and finished in polished aluminum, white or black. Additional options include: parallel upholstery stitching, tilting mechanism and back finished in walnut veneer.

Silla de respaldo intermedio con carcasa tapizada y base central giratoria de aluminio de 4 aspas con sistema de retorno en acabado aluminio pulido, blanco o negro. Opción de tapizado con costuras paralelas. Opción de sistema basculante. Opción de respaldo en madera de nogal.

COM cm. per unit	COL m2
------------------	--------

0,43 m3
16,4 kg
x1

Fully upholstered Carcasa tapizada		3
1 units	150	
10 units or more	120	

Walnut back Respaldo nogal		3
1 units	140	
10 units or more	100	

COM	COL	1	2	3	4	5	6	7	8	9	10	11	L1	L2	L3	L6
€ 661	672	685	696	705	720	735	750	768	784	802	818	835	848	909	1.022	1.325



Tilting mechanism upcharge
Incremento por sistema basculante

35



Parallel stitching upholstery upcharge (Seat and back)
Incremento tapizado con costuras paralelas (Asiento y respaldos)

59



Walnut back upcharge
Incremento respaldo en nogal

155

SO1845

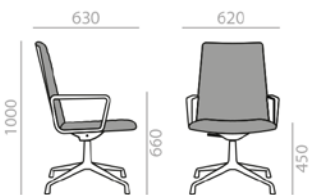

Intermediate back armchair with upholstered shell and aluminum swivel 4- star base with self-return and finished in polished aluminum white or black. Additional options include: parallel upholstery stitching, tilting mechanism and back finished in walnut veneer.

Sillón de respaldo intermedio con carcasa tapizada y base central giratoria de aluminio de 4 aspas con sistema de retorno en acabado aluminio pulido, blanco o negro. Opción de tapizado con costuras paralelas. Opción de sistema basculante. Opción de respaldo en madera de nogal.

COM cm. per unit	COL m2
------------------	--------

0,44 m3
19,5 kg
x1

Fully upholstered Carcasa tapizada		3
1 units	150	
10 units or more	120	

Walnut back Respaldo nogal		3
1 units	140	
10 units or more	100	

COM	COL	1	2	3	4	5	6	7	8	9	10	11	L1	L2	L3	L6
€ 923	936	951	964	975	992	1.008	1.025	1.042	1.060	1.077	1.094	1.111	1.126	1.188	1.314	1.667



Tilting mechanism upcharge
Incremento por sistema basculante

35



Parallel stitching upholstery upcharge (Seat and back)
Incremento tapizado con costuras paralelas (Asiento y respaldo)

59



Upholstered arm upcharge
Incremento brazo tapizado

42



Walnut back upcharge
Incremento respaldo en nogal

155

SI1857

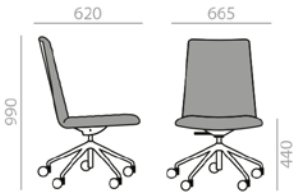

Intermediate back chair with upholstered shell and height adjustable central swivel base with 5 casters finished in polished aluminum white or black. Additional options include: parallel upholstery stitching, tilting mechanism and back finished in walnut veneer. Height ranges: seat 440-540 mm.

Silla de respaldo intermedio con carcasa tapizada y base central giratoria con 5 ruedas regulables en altura en acabado aluminio pulido, blanco o negro. Opción de tapizado con costuras paralelas. Opción de sistema basculante. Opción de respaldo en madera de nogal. Rango de altura de asiento: 440-540 mm.

COM cm. per unit	COL m2
------------------	--------

0,45 m3
18 kg
x1

Fully upholstered Carcasa tapizada		3
1 units	150	
10 units or more	120	

Walnut back Respaldo nogal		3
1 units	140	
10 units or more	100	

COM	COL	1	2	3	4	5	6	7	8	9	10	11	L1	L2	L3	L6
€ 703	716	730	743	752	769	785	802	819	835	851	868	885	899	959	1.068	1.366



35



59



155

SI1864

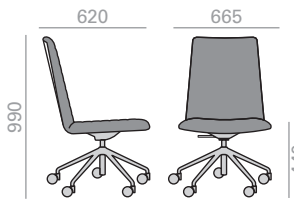

Intermediate back chair with upholstered shell and Eco thermo-polymer central base with 5 casters, swivel and pneumatic height adjustment, finished in black. Available options: Parallel upholstery stitching, tilting mechanism and back finished in walnut veneer. Height ranges: seat 440-540 mm.

Silla de respaldo intermedio con carcasa tapizada y base central giratoria de termopolímero Eco de 5 ruedas, regulable en altura y acabado negro. Opciones disponibles: Tapizado con costuras paralelas, sistema basculante y respaldo en madera de nogal. Rango de altura de asiento: 440-540 mm.

COM cm. per unit	COL m2
------------------	--------

0,42 m3
17 kg
x1

Fully upholstered Carcasa tapizada		3
1 units	150	
10 units or more	120	

Walnut back Respaldo nogal		3
1 units	140	
10 units or more	100	

COM	COL	1	2	3	4	5	6	7	8	9	10	11	L1	L2	L3	L6
€ 599	610	624	637	645	662	677	693	708	727	751	775	802	819	909	1.003	1.232



35



59



155

SO1860

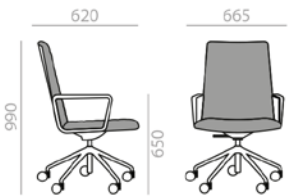

Intermediate back armchair with upholstered shell and height adjustable central swivel base with 5 casters finished in polished aluminum, white or black. Additional options include: parallel upholstery stitching, tilting mechanism and back finished in walnut veneer. Height ranges: seat 440-540 mm./arms 650-750 mm.

Sillón de respaldo intermedio con carcasa tapizada y base central giratoria con 5 ruedas regulable en altura en acabado aluminio pulido, blanco negro. Opción de tapizado con costuras paralelas. Opción de sistema basculante. Opción de respaldo en madera de nogal. Rangos de altura: asiento 440-540 mm./brazos 650-750 mm.

COM cm. per unit	COL m2
------------------	--------

0,45 m3
19 kg
x1

Fully upholstered Carcasa tapizada		3
1 units	150	
10 units or more	120	

Walnut back Respaldo nogal		3
1 units	140	
10 units or more	100	

COM	COL	1	2	3	4	5	6	7	8	9	10	11	L1	L2	L3	L6
€ 922	936	951	965	975	993	1.011	1.029	1.049	1.068	1.089	1.109	1.128	1.147	1.218	1.349	1.708



35



59



42



155

SO1865

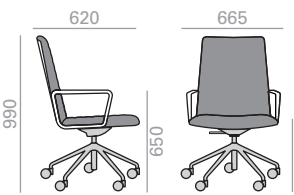

Intermediate back armchair with upholstered shell and Eco thermo-polymer central base with 5 casters, swivel and pneumatic height adjustment, finished in black. Available options: Parallel upholstery stitching, tilting mechanism and back finished in walnut veneer. Height ranges: seat 440-540 mm./arms 650-750 mm.

Sillón de respaldo intermedio con carcasa tapizada y base central giratoria de termopolímero Eco de 5 ruedas, regulable en altura y acabado negro. Opciones disponibles: Tapizado con costuras paralelas, sistema basculante y respaldo en madera de nogal. Rangos de altura: asiento 440-540 mm./brazos 650-750 mm.

COM cm. per unit	COL m2
------------------	--------

0,44 m3
18 kg
x1

Fully upholstered Carcasa tapizada		3
1 units	150	
10 units or more	120	

Walnut back Respaldo nogal		3
1 units	140	
10 units or more	100	

COM	COL	1	2	3	4	5	6	7	8	9	10	11	L1	L2	L3	L6
€ 832	845	862	877	888	906	925	944	963	981	1.001	1.019	1.037	1.054	1.122	1.327	1.590



35



59



42



155

SI1840



High back chair with upholstered shell and aluminum swivel 4-star base with self-return and finished in polished aluminum, white or black. Additional options include: parallel upholstery stitching, tilting mechanism and back finished in walnut veneer.

Silla de respaldo alto con carcasa tapizada y base central giratoria de aluminio de 4 aspas con sistema de retorno en acabado aluminio pulido, blanco o negro. Opción de tapizado con costuras paralelas. Opción de sistema basculante. Opción de respaldo en madera de nogal.

COM cm. per unit	COL m2
------------------	--------

0,58 m3
20,5 kg
x1

Fully upholstered Carcasa tapizada		4
1 units	160	
10 units or more	155	

Walnut back Respaldo nogal		3
1 units	140	
10 units or more	110	

COM	COL	1	2	3	4	5	6	7	8	9	10	11	L1	L2	L3	L6	
€	763	779	797	812	825	845	866	886	905	926	946	967	987	1.005	1.079	1.218	1.612



35



59



165

SO1846



High back armchair with upholstered shell and aluminum swivel 4-star base with self-return and finished in polished aluminum, white or black. Additional options include: parallel upholstery stitching, tilting mechanism and back finished in walnut veneer.

Sillón de respaldo alto con carcasa tapizada y base central giratoria de aluminio de 4 aspas con sistema de retorno en acabado aluminio pulido, blanco o negro. Opción de tapizado con costuras paralelas. Opción de sistema basculante. Opción de respaldo en madera de nogal.

COM cm. per unit	COL m2
------------------	--------

0,58 m3
23,7 kg
x1

Fully upholstered Carcasa tapizada		4
1 units	160	
10 units or more	155	

Walnut back Respaldo nogal		3
1 units	140	
10 units or more	110	

COM	COL	1	2	3	4	5	6	7	8	9	10	11	L1	L2	L3	L6	
€	1.005	1.020	1.040	1.057	1.070	1.091	1.112	1.133	1.154	1.177	1.198	1.219	1.240	1.260	1.337	1.495	1.930



35



59



42



165

BU1841



High back lounge chair with upholstered shell and aluminum swivel 4-star base with self-return and finished in polished aluminum, white or black. Additional options include: parallel upholstery stitching, tilting mechanism and back finished in walnut veneer.

Butaca de respaldo alto con carcasa tapizada y base central giratoria de aluminio de 4 aspas con sistema de retorno en acabado aluminio pulido, blanco o negro. Opción de tapizado con costuras paralelas. Opción de sistema basculante. Opción de respaldo en madera de nogal.

COM cm. per unit	COL m2
------------------	--------

0,56 m3
20,2 kg
x1

Fully upholstered Carcasa tapizada		4
1 units	160	
10 units or more	155	

Walnut back Respaldo nogal		3
1 units	140	
10 units or more	110	

COM	COL	1	2	3	4	5	6	7	8	9	10	11	L1	L2	L3	L6	
€	730	745	762	777	789	808	826	846	865	885	904	925	945	963	1.035	1.175	1.545



35



59



165

BU1847

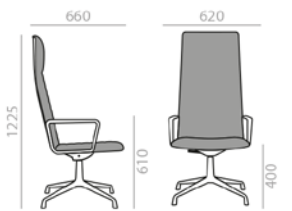

High back lounge chair with arms, upholstered shell and aluminum swivel 4-star base with self-return and finished in polished aluminum, white or black. Additional options include: parallel upholstery stitching, tilting mechanism and back finished in walnut veneer.

Butaca de respaldo alto con carcasa tapizada y base central giratoria de aluminio de 4 aspas con sistema de retorno en acabado aluminio pulido, blanco o negro. Opción de tapizado con costuras paralelas. Opción de sistema basculante. Opción de respaldo en madera de nogal.

COM cm. per unit	COL m2
------------------	--------

0,55 m3
23,4 kg
x1

Fully upholstered Carcasa tapizada		4
1 units	160	
10 units or more	155	

Walnut back Respaldo nogal		3
1 units	140	
10 units or more	110	

COM	COL	1	2	3	4	5	6	7	8	9	10	11	L1	L2	L3	L6	
€	927	942	960	976	987	1.007	1.027	1.046	1.066	1.086	1.106	1.126	1.146	1.164	1.236	1.368	1.758



35



59



42



165

SI1858



High back chair with upholstered shell and height adjustable central swivel base with 5 casters finished in polished aluminum, white or black. Additional options include: parallel upholstery stitching, tilting mechanism and back finished in walnut veneer. Height ranges: seat 440-540 mm.

Silla de respaldo alto con carcasa tapizada y base central giratoria con 5 ruedas regulable en altura en acabado aluminio pulido, blanco o negro. Opción de tapizado con costuras paralelas. Opción de sistema basculante. Opción de respaldo en madera de nogal. Rango de altura de asiento: 440-540 mm.

COM cm. per unit	COL m2
------------------	--------

0,58 m3
19 kg
x1

Fully upholstered Carcasa tapizada		4
1 units	160	
10 units or more	155	

Walnut back Respaldo nogal		3
1 units	140	
10 units or more	110	

COM	COL	1	2	3	4	5	6	7	8	9	10	11	L1	L2	L3	L6
€ 770	785	805	822	835	856	877	899	920	943	964	985	1.007	1.026	1.104	1.246	1.625

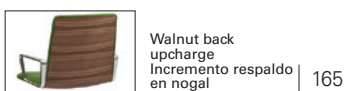
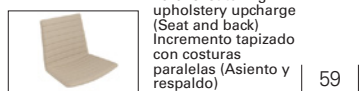

SI1866

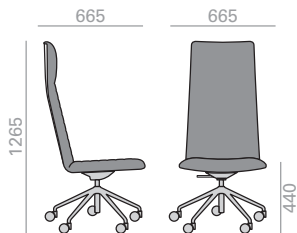

High back chair with upholstered shell and Eco thermo-polymer central base with 5 casters, swivel and pneumatic height adjustment, finished in black. Available options: Parallel upholstery stitching, tilting mechanism and back finished in walnut veneer. Height ranges: seat 440-540 mm.

Silla de respaldo alto con carcasa tapizada y base central giratoria de termopolímero Eco de 5 ruedas, regulable en altura y acabado negro. Opciones disponibles: Tapizado con costuras paralelas, sistema basculante y respaldo en madera de nogal. Rango de altura de asiento: 440-540 mm.

COM cm. per unit	COL m2
------------------	--------

0,57 m3
18 kg
x1

Fully upholstered Carcasa tapizada		4
1 units	160	
10 units or more	155	

Walnut back Respaldo nogal		3
1 units	140	
10 units or more	110	

COM	COL	1	2	3	4	5	6	7	8	9	10	11	L1	L2	L3	L6
€ 652	668	686	701	714	734	753	775	794	815	843	872	903	925	1.032	1.146	1.455

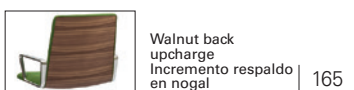
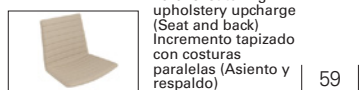

SO1861

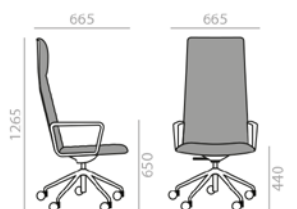

High back armchair with upholstered shell and height adjustable central swivel base with 5 casters finished in polished aluminum, white or black. Additional options include: parallel upholstery stitching, tilting mechanism and back finished in walnut veneer. Height ranges: seat 440-540 mm./arms 650-750 mm.

Sillón de respaldo alto con carcasa tapizada y base central giratoria con 5 ruedas regulable en altura en acabado aluminio pulido, blanco negro. Opción de tapizado con costuras paralelas. Opción de sistema basculante. Opción de respaldo en madera de nogal. Rangos de altura: asiento 440-540 mm./brazos 650-750 mm.

COM cm. per unit	COL m2
------------------	--------

0,58 m3
19 kg
x1

Fully upholstered Carcasa tapizada		4
1 units	160	
10 units or more	155	

Walnut back Respaldo nogal		3
1 units	140	
10 units or more	110	

COM	COL	1	2	3	4	5	6	7	8	9	10	11	L1	L2	L3	L6
€ 991	1.007	1.027	1.044	1.056	1.079	1.101	1.125	1.151	1.175	1.199	1.224	1.249	1.271	1.361	1.522	1.961

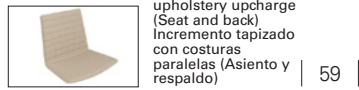

SO1867

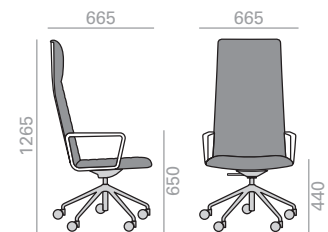

High back armchair with upholstered shell and Eco thermo-polymer central base with 5 casters, swivel and pneumatic height adjustment finished in black. Available options: Parallel upholstery stitching, tilting mechanism and back finished in walnut veneer. Height ranges: seat 440-540 mm./arms 650-750 mm.

Sillón de respaldo alto con carcasa tapizada y base central giratoria de termopolímero Eco de 5 ruedas, regulable en altura y acabado negro. Opciones disponibles: Tapizado con costuras paralelas, sistema basculante y respaldo en madera de nogal. Rangos de altura: asiento 440-540 mm./brazos 650-750 mm.

COM cm. per unit	COL m2
------------------	--------

0,64 m3
18 kg
x1

Fully upholstered Carcasa tapizada		4
1 units	160	
10 units or more	155	

Walnut back Respaldo nogal		3
1 units	140	
10 units or more	110	

COM	COL	1	2	3	4	5	6	7	8	9	10	11	L1	L2	L3	L6
€ 894	911	932	950	963	987	1.010	1.034	1.056	1.080	1.111	1.146	1.185	1.204	1.340	1.471	1.817

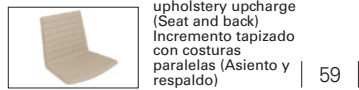

BU1892



Low back lounge chair with upholstered shell and aluminum swivel 4-star base with self-return and finished in polished aluminum, white or black. Additional options include: parallel upholstery stitching, tilting mechanism and back finished in walnut veneer.

Butaca de respaldo bajo con carcasa tapizada y base central giratoria de aluminio de 4 aspas con sistema de retorno en acabado aluminio pulido, blanco o negro. Opción de tapizado con costuras paralelas. Opción de sistema basculante. Opción de respaldo en madera de nogal.

COM cm. per unit	COL m2
------------------	--------

0,39 m3
22 kg
x1

Fully upholstered Carcasa tapizada		3
1 units	140	
10 units or more	120	

Walnut back Respaldo nogal		3
1 units	135	
10 units or more	135	

COM	COL	1	2	3	4	5	6	7	8	9	10	11	L1	L2	L3	L6
€ 738	751	766	779	788	805	822	839	856	873	889	906	922	937	997	1.109	1.433

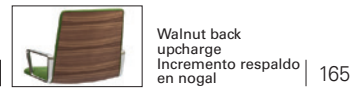
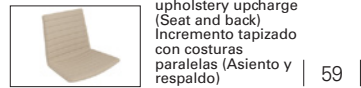

BU1893



Low back lounge chair with arms, upholstered shell and aluminum swivel 4-star base with self-return and finished in polished aluminum, white or black. Additional options include: parallel upholstery stitching, tilting mechanism and back finished in walnut veneer.

Butaca de respaldo bajo con carcasa tapizada y base central giratoria de aluminio de 4 aspas con sistema de retorno en acabado aluminio pulido, blanco o negro. Opción de tapizado con costuras paralelas. Opción de sistema basculante. Opción de respaldo en madera de nogal.

COM cm. per unit	COL m2
------------------	--------

0,43 m3
18,2 kg
x1

Fully upholstered Carcasa tapizada		3
1 units	140	
10 units or more	120	

Walnut back Respaldo nogal		3
1 units	135	
10 units or more	135	

COM	COL	1	2	3	4	5	6	7	8	9	10	11	L1	L2	L3	L6
€ 961	976	991	1.005	1.015	1.033	1.051	1.068	1.087	1.108	1.128	1.149	1.168	1.187	1.261	1.404	1.779

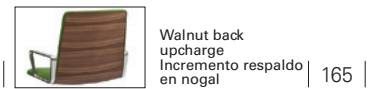
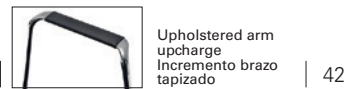
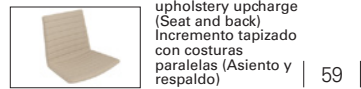

BU1894

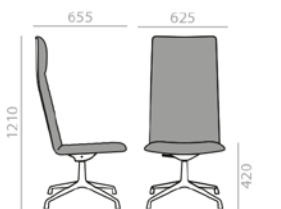

High back lounge chair with upholstered shell and aluminum swivel 4-star base with self-return and finished in polished aluminum, white or black. Additional options include: parallel upholstery stitching, tilting mechanism and back finished in walnut veneer.

Butaca de respaldo alto con carcasa tapizada y base central giratoria de aluminio de 4 aspas con sistema de retorno en acabado aluminio pulido, blanco o negro. Opción de tapizado con costuras paralelas. Opción de sistema basculante. Opción de respaldo en madera de nogal.

COM cm. per unit	COL m2
------------------	--------

0,57 m3
20,3 kg
x1

Fully upholstered Carcasa tapizada		4
1 units	200	
10 units or more	169	

Walnut back Respaldo nogal		3,75
1 units	180	
10 units or more	180	

COM	COL	1	2	3	4	5	6	7	8	9	10	11	L1	L2	L3	L6
€ 835	852	873	891	904	928	950	973	996	1.019	1.043	1.065	1.087	1.109	1.196	1.356	1.787

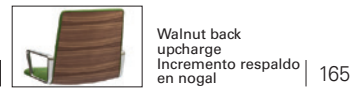
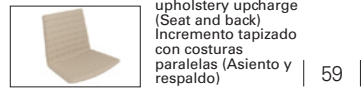

BU1895



High back lounge chair with arms, upholstered shell and aluminum swivel 4-star base with self-return and finished in polished aluminum, white or black. Additional options include: parallel upholstery stitching, tilting mechanism and back finished in walnut veneer.

Butaca de respaldo alto con brazos, carcasa tapizada y base central giratoria de aluminio de 4 aspas con sistema de retorno en acabado aluminio pulido, blanco o negro. Opción de tapizado con costuras paralelas. Opción de sistema basculante. Opción de respaldo en madera de nogal.

COM cm. per unit	COL m2
------------------	--------

0,63 m3
23,5 kg
x1



Fully upholstered Carcasa tapizada		4
1 units	200	
10 units or more	169	

Walnut back Respaldo nogal		3,75
1 units	180	
10 units or more	180	

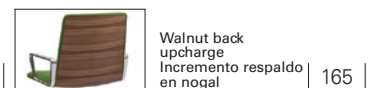
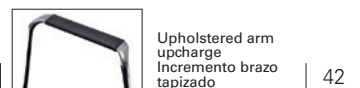
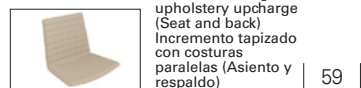
COM	COL	1	2	3	4	5	6	7	8	9	10	11	L1	L2	L3	L6
€ 1.068	1.087	1.108	1.126	1.141	1.165	1.191	1.218	1.245	1.273	1.300	1.326	1.355	1.380	1.479	1.659	2.142



Glides for central base. Tacos para base central.

Use/Uso	Reference/Referencia		Material/Material	Price/Precio	
Hard floors. Suelos duros.	TS0550		Plastic (PE). Plástico (PE).	0 €	Standard. Estándar.
Wooden and delicate floors. Suelos de madera y delicados.	TS0551		Plastic (PE) with felt. Plástico (PE) con fieltro.	3 €	Set of 4 glides. Juego de 4 tacos.
Mats/carpet floors. Suelos de moqueta/ alfombra.	TS0552		Metal. Metal.	3 €	

The indicated price is for glides placed on chairs. To order loose parts, please ask to our Sales Department.

El precio indicado en Tarifa es para tacos colocados en las sillas. Para pedidos de tacos sueltos de repuesto, consultar con el Departamento Comercial.

Casters. Ruedas.



Standard.
Estándar.

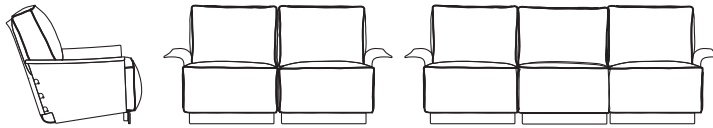

Description
Descripción

1 to 4-seater sofas with upholstered seat and backrest and board frame, with oak interior and walnut exterior. Edge piping available in the same color as the upholstery, or in white, black, sand or brown.

Sofás de 1 a 4 plazas con asiento y respaldo tapizado y estructura de tablero, con el interior de roble y exterior de nogal. Ribete perimetral disponible al tono de la tapicería, o en color blanco, negro, arena y marrón.

Upholstery
Tapicería

The Forest Club Sofa collection supports following upholsteries of Andreu World Catalogue. For fabrics in our catalogue not specified in this box or customers own materials please contact our Customer Service Department.

La colección Forest Club Sofa admite las siguientes tapicerías del catálogo de Andreu World. Para las telas de nuestro catálogo no indicadas en este cuadro o telas cliente, consultar con nuestro Departamento Comercial.

Fabrics / Telas

- 1 Soft-fiber
- Jacquard One
- Jacquard Three
- Citadel
- Sand
- Era
- Gravity
- Rivet
- Urban
- Reel One (in/out)
- Spin One
- Spin Two
- Spin Three
- Spin Four
- Spin Five
- 2 Jacquard Two
- Solid & Stripes
- Loom One
- Circular One Pure Eco
- Tack One (in/out)

- 3 Jacquard Four
- Medley
- Revive 1
- Natte
- Main Line Flax
- Loom Two (in/out)
- Mezzo
- Reel two (in/out)
- Jacquard Five
- 4 Jacquard 4 Special
- Nexus
- Field 2
- Remix 3
- Heritage
- Savane
- Loom Three
- Loom Four
- Cura
- Oceanic
- Reel Three (in/out)
- Reel Four (in/out)
- Reflect
- Spin Six

- 5 Silk
- Synergy
- Step
- Step Melange
- Blazer
- Melange Nap
- Chili
- Noma
- Re-wool
- 6 Go check
- Swing
- Chartres
- Zori
- Patio
- Tack Two (in/out)
- Tack Three (in/out)
- 7 Canvas 2
- Select
- Clara 2
- Tack Five (in/out)
- Hero 2

- 8 Capture
- Fiord 2
- Tonus 4
- Divina 3
- Lopi
- Domino
- Atrium
- 9 Divina MD
- Divina Melange 3
- Hallingdal 65
- Steelcut Trio 3
- Tack Four (in/out)
- 11 Arda
- Ecriture
- Zero

Faux Leather / Ecopiel

- 1 Valencia
- 2 Silvertex
- 3 Maglia
- 4 Dolce
- 8 Ultraleather
- 9 Brisa
- Brisa Distressed
- Fresco
- Ultraleather Pro
- Promessa
- 10 Tottori
- Coast (in/out)
- 11 Reef Pro
- Volar Bio

Leather / Piel

- L1 High grade cow leather.
- Piel de vaca de 1ª categoría.
- L3 Polished full grain leather.
- Plena flor pulida.
- L6 Aniline leather batique-effect.
- Scandinavian cattle.
- Piel anilina efecto batique.
- Ganado escandinavo.

Wood finish Oak
Acabado madera
Roble

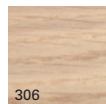

Wood finish Walnut
Acabado madera
Nogal

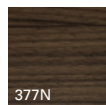

Piping finish
Acabado ribete



Certificates
Certificados

Fireproof polyurethane foam
Espuma de poliuretano ignifuga

UNE EN 1021:2006
BS 5852 part 2 crib 5
UNI 9175 Classe 1 IM
BKZ 5.2
California TB 117:2013
California TB 133*

*Contact our Customer Department
*Consultar con nuestro Departamento Comercial

Quality - Resistance
Calidad - Resistencia

UNE EN 16139:2013

Intellectual property Propiedad intelectual

All our collections are protected by international industrial design registries, designs patents, copyrights and intellectual Property laws. Unauthorized use of AW International Property is a criminal offence and can lead to prosecution.
Todas nuestras colecciones están protegidas por registros de diseño industrial, diseño de patente, copyright y derechos de propiedad intelectual todo el mundo. El uso no autorizado de los diseños y propiedad intelectual de AW supone un delito que puede ser sometido a acción judicial.



SF3030

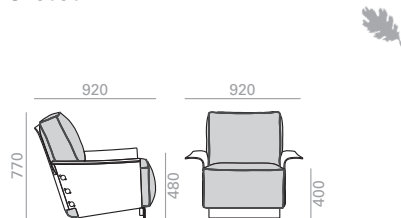

Lounge chair with upholstered seat and backrest and board frame, with oak interior and walnut exterior. Edge piping available in the same color as the upholstery, or in white, black, sand or brown.

Sofá de 1 plaza con asiento y respaldo tapizado y estructura de tablero, con el interior de roble y exterior de nogal. Ribete perimetral disponible al tono de la tapicería, o en color blanco, negro, arena y marrón.

	COM cm. per unit	COL m2
1 units	245	5
10 units or more	245	

0,75 m3
22,5 kg
x1

€	COM	COL	1	2	3	4	5	6	7	8	9	10	11	L1	L2	L3	L6
	1.672	1.694	1.721	1.743	1.760	1.790	1.819	1.849	1.879	1.908	1.938	1.967	1.995	2.022	2.129	2.322	2.836

SERIE 600 | Matte lacquered and premium upcharge | Incremento por lacado mate y premium | 27 |

SF3031

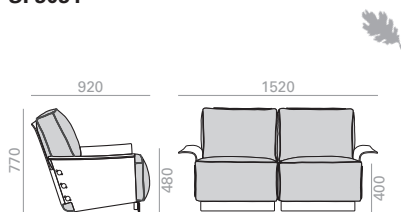

2-seater sofa with upholstered seat and backrest constructed in board with oak interior and walnut exterior. Edge piping available in the same color as the upholstery, or in white, black, sand or brown.

Sofá de 2 plazas con asiento y respaldo tapizado y estructura de tablero, con el interior de roble y exterior de nogal. Ribete perimetral disponible al tono de la tapicería, o en color blanco, negro, arena y marrón.

	COM cm. per unit	COL m2
1 units	500	10
10 units or more	500	

1,22 m3
42 kg
x1

€	COM	COL	1	2	3	4	5	6	7	8	9	10	11	L1	L2	L3	L6
	2.461	2.507	2.564	2.610	2.646	2.707	2.769	2.831	2.892	2.954	3.016	3.077	3.139	3.195	3.417	3.823	4.896

SERIE 600 | Matte lacquered and premium upcharge | Incremento por lacado mate y premium | 36 |

SF3032

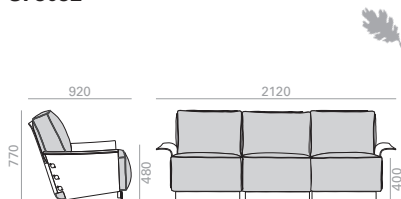

3-seater sofa with upholstered seat and backrest constructed in board with oak interior and walnut exterior. Edge piping available in the same color as the upholstery, or in white, black, sand or brown.

Sofá de 3 plazas con asiento y respaldo tapizado y estructura de tablero, con el interior de roble y exterior de nogal. Ribete perimetral disponible al tono de la tapicería, o en color blanco, negro, arena y marrón.

	COM cm. per unit	COL m2
1 units	760	15,25
10 units or more	760	

1,68 m3
62 kg
x1

€	COM	COL	1	2	3	4	5	6	7	8	9	10	11	L1	L2	L3	L6
	3.250	3.320	3.406	3.475	3.529	3.623	3.716	3.808	3.901	3.994	4.088	4.181	4.274	4.356	4.692	5.304	6.924

SERIE 600 | Matte lacquered and premium upcharge | Incremento por lacado mate y premium | 45 |

SF3033

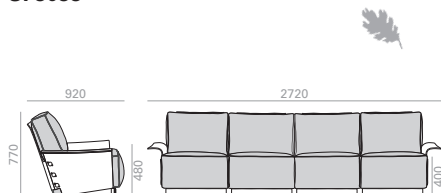

4-seater sofa with upholstered seat and backrest constructed in board with oak interior and walnut exterior. Edge piping available in the same color as the upholstery, or in white, black, sand or brown.

Sofá de 4 plazas con asiento y respaldo tapizado y estructura de tablero, con el interior de roble y exterior de nogal. Ribete perimetral disponible al tono de la tapicería, o en color blanco, negro, arena y marrón.

	COM cm. per unit	COL m2
1 units	980	19,5
10 units or more	980	

2,15 m3
81 kg
x1

€	COM	COL	1	2	3	4	5	6	7	8	9	10	11	L1	L2	L3	L6
	4.057	4.141	4.245	4.329	4.393	4.506	4.618	4.731	4.843	4.956	5.069	5.181	5.294	5.393	5.799	6.539	8.935

SERIE 600 | Matte lacquered and premium upcharge | Incremento por lacado mate y premium | 72 |

For wooden legs. Para bases de madera.



Optional glides on page 482.

Opciones de tacos deslizantes en página 482.



Description
Descripción

Armchairs with upholstered shell. The available base options are: 4-star aluminum central swivel base with self-return or central swivel base with 5 casters, all in polished aluminum finish, white or black, 4 legs steel tubular or steel oval cantilever base finished in polished chrome, white or black and 4 legs thermo-polymer injection base finished in black or dark brown.

Sillones con carcasa tapizada. Las bases disponibles son: base central giratoria de aluminio de 4 aspas con sistema de retorno o base central giratoria de aluminio con 5 ruedas regulable en altura, en acabado aluminio pulido, blanco o negro, base de 4 patas de tubo de acero o cantiláver de pletina ovalada de acero en acabado cromo brillo, blanco o negro y base de 4 patas de inyección de termopolímero en acabado negro y marrón oscuro.

Upholstery
Tapicería

The Gala collection supports following upholsteries of Andreu World Catalogue. All upholstered versions are made with 100% recycled Pure Eco thermo-polymer. For fabrics in our catalogue not specified in this box or customers own materials please contact our Customer Service Department.

La colección Gala admite las siguientes tapicerías del catálogo de Andreu World. Todas las versiones tapizadas están hechas con termopolímero Pure Eco 100% reciclado. Para las telas de nuestro catálogo no indicadas en este cuadro o telas cliente, consulta

Fabrics / Telas

- 1 Jacquard One
- Jacquard Three
- Sand
- Era
- Gravity
- Rivet
- Urban
- Spin One
- Spin Two
- Spin Three
- Spin Four
- Spin Five

- 2 Jacquard Two
- Circular One Pure Eco
- Tack One (in/out)

- 3 Jacquard Four
- Medley
- Revive 1
- Main Line Flax
- Loom Two (in/out)
- Mezzo
- Reel two (in/out)
- Jacquard Five

- 4 Jacquard 4 Special
- Nexus
- Heritage
- Savane
- Loom Three
- Loom Four
- Cura
- Oceanic
- Reel Three (in/out)
- Reel Four (in/out)
- Reflect
- Spin Six

- 5 Silk
- Synergy
- Step
- Step Melange
- Blazer
- Melange Nap
- Chili
- Noma
- Re-wool

- 6 Go check
- Swing
- Chartres
- Zori
- Patio
- Tack Two (in/out)
- Tack Three (in/out)

- 7 Select
- Clara 2
- Tack Five (in/out)
- Hero 2

- 8 Capture
- Fiord 2
- Tonus 4
- Divina 3
- Lopi
- Domino
- Atrium

- 9 Divina MD
- Divina Melange 3
- Hallingdal 65
- Steelcut Trio 3
- Tack Four (in/out)

- 11 Arda
- Ecriture
- Zero

Faux Leather / Ecopiel

- 1 Valencia
- 2 Silvertex
- 3 Maglia
- 8 Ultraleather
- 9 Fresco
- Ultraleather Pro
- Promessa
- 11 Volar Bio

Leather / Piel

- L1 High grade cow leather. Piel de vaca de 1ª categoría.
- L3 Polished full grain leather. Plena flor pulida.
- L6 Aniline leather batique-effect. Scandinavian cattle. Piel anilina efecto batique. Ganado escandinavo.

ECO Thermo-polymer injection finish
Acabado inyección de termopolímero ECO

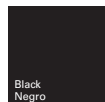

Aluminum finish
Acabado aluminio



Steel finish
Acabado de acero



Certificates
Certificados

Fireproof polyurethane foam
Espuma de poliuretano ignifuga

UNE EN 1021:2006
BS 5852 part 2 crib 5
UNI 9175 Classe 1 IM
BKZ 5.2
California TB 117:2013
California TB 133*

*Contact our Customer Department
*Consultar con nuestro Departamento Comercial

Quality - Resistance
Calidad - Resistencia

UNE EN 16139:2013

Intellectual property Propiedad intelectual

All our collections are protected by international industrial design registries, designs patents, copyrights and intellectual Property laws. Unauthorized use of AW International Property is a criminal offence and can lead to prosecution.
Todas nuestras colecciones están protegidas por registros de diseño industrial, diseño de patente, copyright y derechos de propiedad intelectual todo el mundo. El uso no autorizado de los diseños y propiedad intelectual de AW supone un delito que puede ser sometido a acción judicial.



SO0718

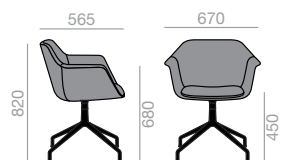

Armchair with upholstered shell and 4-star central aluminum swivel base with self-return system and finished in polished aluminum, white or black.

Sillón con carcasa tapizada y base central giratoria de aluminio de 4 aspas con sistema de retorno y acabado aluminio pulido, blanco o negro.

	COM cm. per unit	COL m2
1 units	170	3,5
10 units or more	130	

0,35 m3
12,5 kg
x1

€	COM	COL	1	2	3	4	5	6	7	8	9	10	11	L1	L2	L3	L6
	572	587	607	624	637	658	680	701	722	745	766	788	810	831	919	1.074	1.490

SO0719

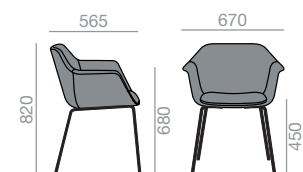

Armchair with upholstered shell and 4-legs steel base finished in polished chrome, white or black.

Sillón con carcasa tapizada y base de 4 patas de acero en acabado cromo brillo, blanco o negro.

	COM cm. per unit	COL m2
1 units	170	3,5
10 units or more	130	

0,35 m3
11,5 kg
x1

€	COM	COL	1	2	3	4	5	6	7	8	9	10	11	L1	L2	L3	L6
	404	419	437	452	465	484	505	535	557	579	601	624	645	664	743	887	1.269

SO0720

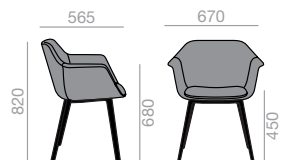

Armchair with upholstered shell and 4-legs thermo-polymer injection base finished in black.

Sillón con carcasa tapizada y base de 4 patas de inyección de termopolímero en acabado negro.

	COM cm. per unit	COL m2
1 units	170	3,5
10 units or more	130	

0,35 m3
0 kg
x0

€	COM	COL	1	2	3	4	5	6	7	8	9	10	11	L1	L2	L3	L6
	353	368	386	401	414	433	454	474	494	514	535	554	575	593	668	830	1.205

SO0721

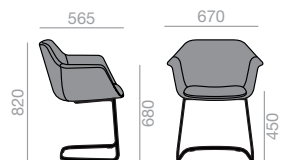

Armchair with upholstered shell and steel oval cantilever base finished in polished chrome, white or black.

Silla con carcasa tapizada y base cantiléver de pletina ovalada de acero en acabado cromo brillo, blanco o negro.

	COM cm. per unit	COL m2
1 units	170	3,5
10 units or more	130	

0,33 m3
13 kg
x1

€	COM	COL	1	2	3	4	5	6	7	8	9	10	11	L1	L2	L3	L6
	493	508	526	541	557	582	606	632	659	685	713	740	767	790	888	1.092	1.548

SO0722

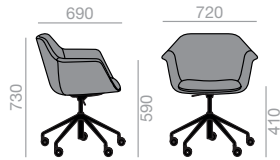

Armchair with upholstered shell and aluminum central base with 5 casters, swivel and pneumatic height adjustment. Available in polished aluminum, white or black. Height ranges: seat 410-510 mm./arms 590-690 mm. In upholstered versions the seat height increases 20 mm.

Sillón con carcasa tapizada y base central giratoria de aluminio de 5 ruedas, regulable en altura y acabado aluminio pulido blanco o negro. Rangos de altura: asiento 410-510 mm./brazos 590-690 mm.

	COM cm. per unit	COL m2
1 units	170	3,5
10 units or more	130	

0,34 m3
 13,5 kg
 x1

€	COM	COL	1	2	3	4	5	6	7	8	9	10	11	L1	L2	L3	L6
	595	613	636	654	670	694	719	745	770	794	820	845	869	892	982	1.149	1.603

SO0723

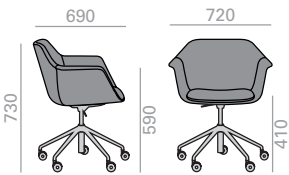

Armchair with upholstered shell and Eco thermo-polymer central base with 5 casters, swivel and pneumatic height adjustment, finished in black. Height ranges: seat 410-510 mm./arms 590-690 mm. In upholstered versions the seat height increases 20 mm.

Sillón con carcasa tapizada y base central giratoria de termopolímero Eco de 5 ruedas, regulable en altura y acabado negro. Rangos de altura: asiento 410-510 mm./brazos 590-690 mm.

	COM cm. per unit	COL m2
1 units	170	3,5
10 units or more	130	

0,35 m3
 12,5 kg
 x1

€	COM	COL	1	2	3	4	5	6	7	8	9	10	11	L1	L2	L3	L6
	483	502	523	541	556	578	602	627	649	675	699	724	749	772	865	1.033	1.475

Glides for cantilever base. Tacos para base cantiléver.

Use/Usó	Reference/Referencia		Material/Material	Price/Precio
Hard floors. Suelos duros.	TS0545		Plastic (PE). Plástico (PE).	0 € Standard. Estándar.
Wooden and delicate floors. Suelos de madera y delicados.	TS0546		Plastic (PE) with felt. Plástico (PE) con fieltro.	6 € Set of 4 glides. Juego de 4 tacos.
Mats/carpet floors. Suelos de moqueta/ alfombra.	TS0547		No glide. Sin taco.	0 €

The indicated price is for glides placed on chairs. To order loose parts, please ask to our Sales Department.
 El precio indicado en Tarifa es para tacos colocados en las sillas. Para pedidos de tacos sueltos de repuesto, consultar con el Departamento Comercial.

Glides for central base. Tacos para base central.

Use/Usó	Reference/Referencia		Material/Material	Price/Precio	
Hard floors. Suelos duros.	TS0539		Plastic (PE). Plástico (PE).	0 €	Standard. Estándar.
Wooden and delicated floors. Suelos de madera y delicados.	TS0533		Plastic (PE) with felt. Plástico (PE) con fieltro.	3 €	Set of 4 glides. Juego de 4 tacos.
Mats/carpet floors. Suelos de moqueta/ alfombra.	TS0543		Metal. Metal.	3 €	

Glides for 4 metal legs base. Tacos para bases de 4 patas metálicas.

Use/Usó	Reference/Referencia		Material/Material	Price/Precio	
Hard floors. Suelos duros.	TS0558		Plastic (PE). Plástico (PE).	0 €	Standard. Estándar.
Wooden and delicated floors. Suelos de madera y delicados.	TS0534		Plastic (PE) with felt. Plástico (PE) con fieltro.	4 €	Set of 4 glides. Juego de 4 tacos.
Mats/carpet floors. Suelos de moqueta/ alfombra.	TS0559		Metal. Metal.	4 €	Set of 4 glides. Juego de 4 tacos.

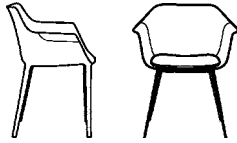

Description
Descripción

Armchair with shell and 4-legged base in Pure Eco 100% recycled thermo-polymer available in different colors. Option of upholstered seat cushion.
Sillón con carcasa y base de 4 patas de termopolímero Pure Eco 100% reciclado disponible en diferentes colores. Opción de cojín tapizado en asiento.

Upholstery
Tapicería

The Gala Pure Eco collection supports following upholsteries of Andreu World Catalogue. For fabrics in our catalogue not specified in this box or customers own materials please contact our Customer Service Department.

La colección Gala Pure Eco admite las siguientes tapicerías del catálogo de Andreu World. Para las telas de nuestro catálogo no indicadas en este cuadro o telas cliente, consulta con nuestro Departamento Comercial.

Fabrics / Telas

- 1** Jacquard One
Jacquard Three
Sand
Era
Gravity
Rivet
Urban
Spin One
Spin Two
Spin Three
Spin Four
Spin Five

- 2** Jacquard Two
Circular One Pure Eco
Tack One (in/out)

- 3** Jacquard Four
Medley
Revive 1
Main Line Flax
Loom Two (in/out)
Mezzo
Reel two (in/out)
Jacquard Five

- 4** Jacquard 4 Special
Nexus
Heritage
Savane
Loom Three
Loom Four
Cura
Oceanic
Reel Three (in/out)
Reel Four (in/out)
Reflect
Spin Six

- 5** Silk
Synergy
Step
Step Melange
Blazer
Melange Nap
Chili
Noma
Re-wool

- 6** Go check
Swing
Chartres
Zori
Patio
Tack Two (in/out)
Tack Three (in/out)

- 7** Select
Clara 2
Tack Five (in/out)
Hero 2

- 8** Capture
Fiord 2
Tonus 4
Divina 3
Lopi
Domino
Atrium

- 9** Divina MD
Divina Melange 3
Hallingdal 65
Steelcut Trio 3
Tack Four (in/out)

- 11** Arda
Ecriture
Zero

Faux Leather / Ecopiel

- 1** Valencia
2 Silvertex
3 Maglia

- 8** Ultraleather

- 9** Fresco
Ultraleather Pro
Promessa

- 11** Volar Bio

Leather / Piel

- L1** High grade cow leather.
Piel de vaca de 1ª categoría.

- L3** Polished full grain leather.
Plena flor pulida.

- L6** Aniline leather batique-effect.
Scandinavian cattle.
Piel anilina efecto batique.
Ganado escandinavo.

Pure Eco Thermo-polymer finish
Acabado de Termo-polímero Pure Eco

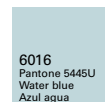
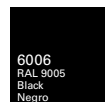
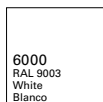

Certificates
Certificados

Fireproof polyurethane foam

Espuma de poliuretano ignífuga

UNE EN 1021:2006
BS 5852 part 2 crib 5
UNI 9175 Classe 1 IM
BKZ 5.2
California TB 117:2013
California TB 133*

*Contact our Customer Department
*Consultar con nuestro Departamento Comercial

Quality - Resistance
Calidad - Resistencia

UNE EN 16139:2013

Intellectual property Propiedad intelectual

All our collections are protected by international industrial design registries, designs patents, copyrights and intellectual Property laws. Unauthorized use of AW International Property is a criminal offence and can lead to prosecution.

Todas nuestras colecciones están protegidas por registros de diseño industrial, diseño de patente, copyright y derechos de propiedad intelectual en todo el mundo. El uso no autorizado de los diseños y propiedad intelectual de AW supone un delito que puede ser sometido a acción judicial.



S00724

Armchair with shell and 4-legged base in Pure Eco thermopolymer available in various colors. Option of upholstered seat cushion.

Sillón con carcasa y base de 4 patas de termopolímero Pure Eco disponible en diferentes colores. Opción de cojín tapizado en asiento.

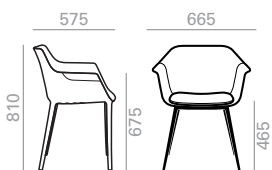

COM cm. per unit	COL m2
------------------	--------

0,52 m3

42 kg

x6

Seat pad Asiento plafonado

1 units	50	1
10 units or more	35	

€ 120



Upholstered cushion
Cojín tapizado

COM	COL	1	2	3	4	5	6	7	8	9	10	11	L1	L2	L3	L6
192	195	198	204	208	215	223	229	237	243	251	258	265	272	297	343	467

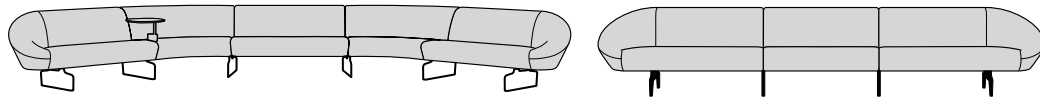

Description
Descripción

Modular system that can be adapted to any space due to its great versatility. Upholstered seat and backrest and aluminum leg base in polished aluminum or black finish. Available in different shapes: straight or with the edges curved 90 or 45 degrees. 2 and 3 seater sofa version. Available options: legs in solid ash wood, USB charging system, satellite side table in oak or Compacto HPL black finish and USB system on satellite table. Minimum combination of 2 end segment modules. For combinations not indicated in our Price List, please consult our Sales Department.

Sistema modular que permite adaptarse a cualquier espacio por su gran versatilidad. Asiento y respaldo tapizado y base de patas de aluminio en acabado aluminio pulido o negro. Disponible en diferentes formas: rectos o final de segmento y curvos de 90 y 45 grados. Versión de sofá de 2 y 3 plazas. Opciones disponibles: patas de madera maciza de fresno, sistema USB de carga, mesa auxiliar satélite en acabado roble o Compacto HPL negro y sistema USB en mesa satélite. Combinación mínima de 2 módulos de final de segmento. Para combinaciones no indicadas en nuestra Lista de Precios, consultar con nuestro Departamento Comercial.

Upholstery
Tapicería

The Giro Soft collection supports following upholsteries of Andreu World Catalogue. For fabrics in our catalogue not specified in this box or customers own materials please contact our Customer Service Department.

La colección Giro Soft admite las siguientes tapicerías del catálogo de Andreu World. Para las telas de nuestro catálogo no indicadas en este cuadro o telas cliente, consultar con nuestro Departamento Comercial.

Fabrics / Telas

- 1 Soft-fiber
- Jacquard One
- Jacquard Three
- Citadel
- Sand
- Era
- Gravity
- Rivet
- Urban
- Reel One (in/out)
- Spin One
- Spin Two
- Spin Three
- Spin Four
- Spin Five
- 2 Jacquard Two
- Solid & Stripes
- Loom One
- Circular One Pure Eco
- Tack One (in/out)

- 3 Jacquard Four
- Medley
- Revive 1
- Natte
- Main Line Flax
- Loom Two (in/out)
- Mezzo
- Reel two (in/out)
- Jacquard Five
- 4 Jacquard 4 Special
- Nexus
- Field 2
- Remix 3
- Heritage
- Savane
- Loom Three
- Loom Four
- Cura
- Oceanic
- Reel Three (in/out)
- Reel Four (in/out)
- Reflect
- Spin Six

- 5 Silk
- Synergy
- Step
- Step Melange
- Blazer
- Melange Nap
- Chilli
- Noma
- Re-wood
- 6 Go check
- Swing
- Chartres
- Zori
- Patio
- Tack Two (in/out)
- Tack Three (in/out)
- 7 Canvas 2
- Select
- Clara 2
- Tack Five (in/out)
- Hero 2

- 8 Capture
- Fiord 2
- Tonus 4
- Divina 3
- Lopi
- Domino
- Atrium
- 9 Divina MD
- Divina Melange 3
- Hallingdal 65
- Steelcut Trio 3
- Tack Four (in/out)
- 11 Arda
- Ecriture
- Zero

Faux Leather / Ecopiel

- 1 Valencia
- 2 Silvertex
- 3 Maglia
- 4 Dolce
- 8 Ultraleather
- 9 Brisa
- Brisa Distressed
- Fresco
- Ultraleather Pro
- Promessa
- 10 Tottori
- Coast (in/out)
- 11 Reef Pro
- Volar Bio

Leather / Piel

- L1 High grade cow leather.
- Piel de vaca de 1ª categoría.
- L3 Polished full grain leather.
- Plena flor pulida.
- L6 Aniline leather batique-effect.
- Scandinavian cattle.
- Piel anilina efecto batique.
- Ganado escandinavo.

Wood finish Oak
Acabado madera
Roble



Wood finish Ash
Acabado madera
Fresno



Premium finish and wood lacquers
Acabado premium y lacas madera



Compacto HPL finish
Acabado Compacto HPL

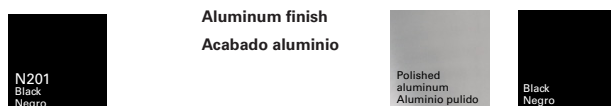

Aluminum finish
Acabado aluminio

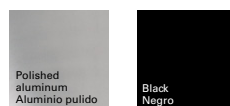

Certificates
Certificados

Fireproof polyurethane foam
Espuma de poliuretano ignifuga

UNE EN 1021:2006
BS 5852 part 2 crib 5
UNI 9175 Classe 1 IM
BKZ 5.2
California TB 117:2013
California TB 133*

*Contact our Customer Department
*Consultar con nuestro Departamento Comercial

Quality - Resistance
Calidad - Resistencia

UNE EN 16139:2013

Intellectual property Propiedad intelectual

All our collections are protected by international industrial design registries, designs patents, copyrights and intellectual Property laws. Unauthorized use of AW International Property is a criminal offence and can lead to prosecution.



SF0292

Module with upholstered seat and back and base with aluminum legs finished in polished aluminum or black.
Módulo con asiento y respaldo tapizado y base de patas de aluminio en acabado aluminio pulido o negro.

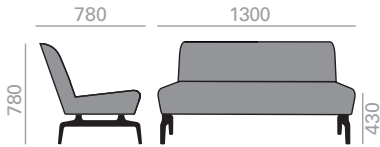

	COM cm. per unit	COL m2
1 units	300	6
10 units or more	300	

0,64 m3
26,3 kg
x1

€	COM	COL	1	2	3	4	5	6	7	8	9	10	11	L1	L2	L3	L6
	1.302	1.334	1.371	1.402	1.426	1.468	1.510	1.550	1.592	1.634	1.676	1.716	1.758	1.795	1.945	2.218	2.980



Satellite auxiliary table upcharge
Incremento mesa auxiliar satélite

| 331 |



Table with USB charging system upcharge
Incremento mesa con sistema USB de carga

| 471 |



Wooden legs upcharge
Incremento por patas de madera

| 90 |

SF0294

Corner module (left side) with upholstered seat and back and base with aluminum legs finished in polished aluminum or black.
Módulo rinconero (lado izquierdo) con asiento y respaldo tapizado y base de patas de aluminio en acabado aluminio pulido o negro.

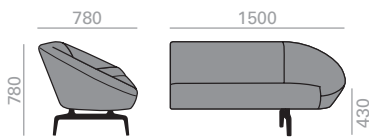

	COM cm. per unit	COL m2
1 units	400	8
10 units or more	400	

0,99 m3
26,7 kg
x1

€	COM	COL	1	2	3	4	5	6	7	8	9	10	11	L1	L2	L3	L6
	1.581	1.620	1.667	1.706	1.734	1.785	1.838	1.889	1.940	1.991	2.042	2.093	2.144	2.189	2.374	2.764	3.862



USB charging system upcharge
Incremento por sistema de USB de carga

| 206 |



Satellite auxiliary table upcharge
Incremento mesa auxiliar satélite

| 331 |



Table with USB charging system upcharge
Incremento mesa con sistema USB de carga

| 471 |

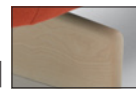

Wooden legs upcharge
Incremento por patas de madera

| 90 |

SF0295

Corner module (right side) with upholstered seat and back and base with aluminum legs finished in polished aluminum or black.
Módulo rinconero (lado derecho) con asiento y respaldo tapizado y base de patas de aluminio en acabado aluminio pulido o negro.

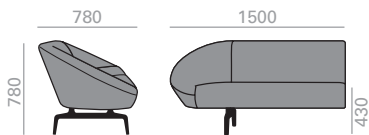

	COM cm. per unit	COL m2
1 units	400	8
10 units or more	400	

0,99 m3
26,7 kg
x1

€	COM	COL	1	2	3	4	5	6	7	8	9	10	11	L1	L2	L3	L6
	1.581	1.620	1.667	1.706	1.734	1.785	1.838	1.889	1.940	1.991	2.042	2.093	2.144	2.189	2.374	2.764	3.862



USB charging system upcharge
Incremento por sistema de USB de carga

| 206 |



Satellite auxiliary table upcharge
Incremento mesa auxiliar satélite

| 331 |



Table with USB charging system upcharge
Incremento mesa con sistema USB de carga

| 471 |



Wooden legs upcharge
Incremento por patas de madera

| 90 |

SF0296

Curved module with upholstered seat and back and base with aluminum legs finished in polished aluminum or black. 90° open curved version.
Módulo con asiento y respaldo tapizado y base de patas de aluminio en acabado aluminio pulido o negro. Versión curva abierta 90°.

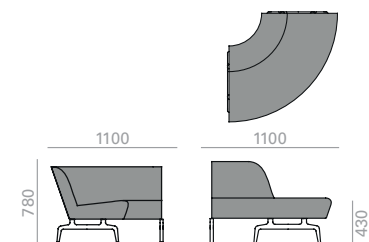

	COM cm. per unit	COL m2
1 units	400	8
10 units or more	400	

1,08 m3
24 kg
x1

€	COM	COL	1	2	3	4	5	6	7	8	9	10	11	L1	L2	L3	L6
	1.407	1.445	1.494	1.533	1.564	1.615	1.668	1.719	1.776	1.835	1.894	1.953	2.012	2.064	2.277	2.665	3.689



Satellite auxiliary table upcharge
Incremento mesa auxiliar satélite

| 331 |



Table with USB charging system upcharge
Incremento mesa con sistema USB de carga

| 471 |



Wooden legs upcharge
Incremento por patas de madera

| 90 |

SF0297

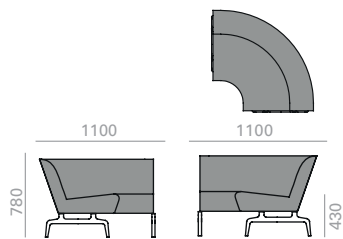

Curved module with upholstered seat and back and base with aluminum legs finished in polished aluminum or black. 90° closed curved version.

Módulo con asiento y respaldo tapizado y base de patas de aluminio en acabado aluminio pulido o negro. Versión curva cerrada 90°.

	COM cm. per unit	COL m2
1 units	400	8
10 units or more	400	

1,04 m3
25 kg
x1

€	COM	COL	1	2	3	4	5	6	7	8	9	10	11	L1	L2	L3	L6
	1.407	1.445	1.494	1.533	1.564	1.615	1.668	1.719	1.776	1.835	1.894	1.953	2.012	2.064	2.277	2.665	3.689



Satellite auxiliary table upcharge
Incremento mesa auxiliar satélite

| 331 |



Table with USB charging system upcharge
Incremento mesa con sistema USB de carga

| 471 |



Wooden legs upcharge
Incremento por patas de madera

| 90 |

SF0298

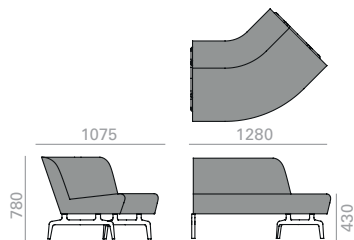

Curved module with upholstered seat and back and base with aluminum legs finished in polished aluminum or black. 45° open curved version.

Módulo con asiento y respaldo tapizado y base de patas de aluminio en acabado aluminio pulido o negro. Versión curva abierta 45°.

	COM cm. per unit	COL m2
1 units	400	8
10 units or more	400	

0,87 m3
24,6 kg
x1

€	COM	COL	1	2	3	4	5	6	7	8	9	10	11	L1	L2	L3	L6
	1.404	1.444	1.494	1.534	1.566	1.620	1.673	1.728	1.782	1.835	1.889	1.944	1.997	2.045	2.242	2.711	3.776



Satellite auxiliary table upcharge
Incremento mesa auxiliar satélite

| 331 |



Table with USB charging system upcharge
Incremento mesa con sistema USB de carga

| 471 |



Wooden legs upcharge
Incremento por patas de madera

| 90 |

SF0299

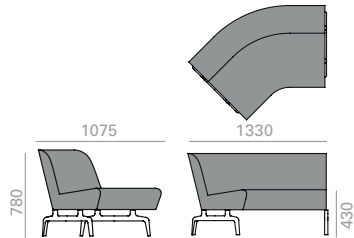

Curved module with upholstered seat and back and base with aluminum legs finished in polished aluminum or black. 45° closed curved version.

Módulo con asiento y respaldo tapizado y base de patas de aluminio en acabado aluminio pulido o negro. Versión curva cerrada 45°.

	COM cm. per unit	COL m2
1 units	400	8
10 units or more	400	

0,82 m3
22,6 kg
x1

€	COM	COL	1	2	3	4	5	6	7	8	9	10	11	L1	L2	L3	L6
	1.404	1.444	1.494	1.534	1.566	1.619	1.673	1.728	1.781	1.835	1.889	1.942	1.997	2.045	2.242	2.711	3.776



Satellite auxiliary table upcharge
Incremento mesa auxiliar satélite

| 331 |



Table with USB charging system upcharge
Incremento mesa con sistema USB de carga

| 471 |



Wooden legs upcharge
Incremento por patas de madera

| 90 |

SF0317

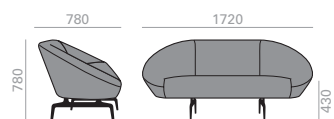

2-seater sofa with upholstered seat and backrest with aluminum leg base in polished black finish.

Sofá de 2 plazas con asiento y respaldo tapizado y base de patas de aluminio en acabado aluminio pulido o negro.

	COM cm. per unit	COL m2
1 units	450	9
10 units or more	450	

1,49 m3
39 kg
x1

€	COM	COL	1	2	3	4	5	6	7	8	9	10	11	L1	L2	L3	L6
	1.835	1.882	1.941	1.989	2.025	2.089	2.153	2.218	2.282	2.346	2.408	2.472	2.536	2.593	2.824	3.244	4.355



USB charging system upcharge
Incremento por sistema de USB de carga

| 206 |



Wooden legs upcharge
Incremento por patas madera

| 90 |

SF0318

3-seater sofa with upholstered seat and backrest with aluminum leg base in polished black finish.

Sofá de 3 plazas con asiento y respaldo tapizado y base de patas de aluminio en acabado aluminio pulido o negro.

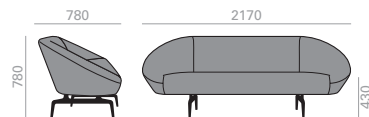

	COM cm. per unit	COL m2
1 units	530	10,5
10 units or more	530	

1,19 m3
 51 kg
 x1

COM	COL	1	2	3	4	5	6	7	8	9	10	11	L1	L2	L3	L6
€ 1.977	2.033	2.102	2.158	2.202	2.277	2.350	2.425	2.500	2.575	2.650	2.725	2.800	2.866	3.136	3.629	4.932



USB charging system upcharge
 Incremento por sistema de USB de carga



Wooden legs upcharge
 Incremento por patas madera

| 90 |

Glides for central base. Tacos para base central.

Use/Usó	Reference/Referencia	Material/Material	Price/Precio
Hard floors. Suelos duros.	TS0550	Plastic (PE). Plástico (PE).	0 € Standard. Estándar.
Wooden and delicate floors. Suelos de madera y delicados.	TS0551	Plastic (PE) with felt. Plástico (PE) con fieltro.	3 € Set of 4 glides. Juego de 4 tacos.
Mats/carpet floors. Suelos de moqueta/alfombra.	TS0552	Metal. Metal.	3 €

The indicated price is for glides placed on chairs. To order loose parts, please ask to our Sales Department.

El precio indicado en Tarifa es para tacos colocados en las sillas. Para pedidos de tacos sueltos de repuesto, consultar con el Departamento Comercial.

For wooden legs. Para bases de madera.



Optional glides on page 482.
 Opciones de tacos deslizantes en página 482.

Examples of modular configurations Ejemplos de combinaciones modulares

Set 1 / Conjunto 1

2 Modules 2 Módulos
SF0295 + SF0294

	COM cm. per unit	COL m2
1 units	800	16
10 units or more	800	

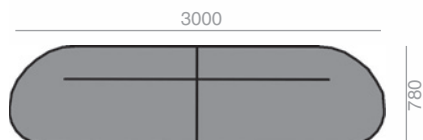

€	COM	COL	1	2	3	4	5	6	7	8	9	10	11	L1	L2	L3	L6
	3.162	3.240	3.334	3.412	3.468	3.570	3.676	3.778	3.880	3.982	4.084	4.186	4.288	4.378	4.748	5.528	7.724

Set 2 / Conjunto 2

3 Modules 3 Módulos
SF0295 + SF0292 + SF0294

	COM cm. per unit	COL m2
1 units	1100	22
10 units or more	1100	

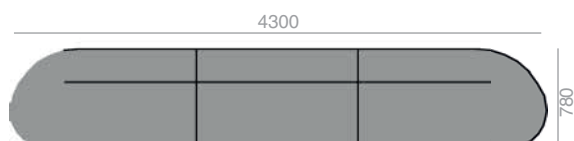

€	COM	COL	1	2	3	4	5	6	7	8	9	10	11	L1	L2	L3	L6
	4.464	4.574	4.705	4.814	4.894	5.038	5.186	5.328	5.472	5.616	5.760	5.902	6.046	6.173	6.693	7.746	10.704

Set 3 / Conjunto 3

4 Modules 4 Módulos
SF0295 + SF0292 + SF0292 + SF0294

	COM cm. per unit	COL m2
1 units	1400	28
10 units or more	1400	

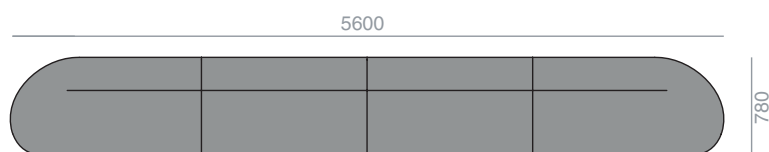

€	COM	COL	1	2	3	4	5	6	7	8	9	10	11	L1	L2	L3	L6
	5.766	5.908	6.076	6.216	6.320	6.506	6.696	6.878	7.064	7.250	7.436	7.618	7.804	7.968	8.638	9.964	13.684

Examples of modular configurations
Ejemplos de combinaciones modulares

Set 4 / Conjunto 4

3 Modules 3 Módulos
SF0295 + SF0299 + SF0294

	COM cm. per unit	COL m2
1 units	1200	24
10 units or more	1200	

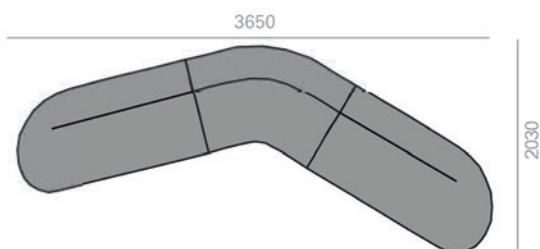

€	COM	COL	1	2	3	4	5	6	7	8	9	10	11	L1	L2	L3	L6
	4.566	4.684	4.828	4.946	5.034	5.189	5.349	5.506	5.661	5.817	5.973	6.128	6.285	6.423	6.990	8.239	11.500

Set 5 / Conjunto 5

4 Modules 4 Módulos
SF0295 + SF0292 + SF0299 + SF0294

	COM cm. per unit	COL m2
1 units	1500	30
10 units or more	1500	

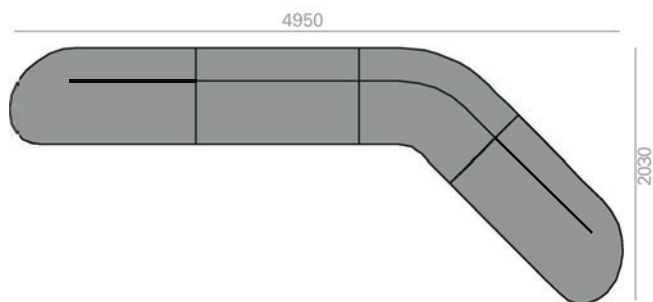

€	COM	COL	1	2	3	4	5	6	7	8	9	10	11	L1	L2	L3	L6
	5.868	6.018	6.199	6.348	6.460	6.657	6.859	7.056	7.253	7.451	7.649	7.844	8.043	8.218	8.935	10.457	14.480

Set 6 / Conjunto 6

4 Modules 4 Módulos
SF0295 + SF0299 + SF0292 + SF0294

	COM cm. per unit	COL m2
1 units	1500	30
10 units or more	1500	

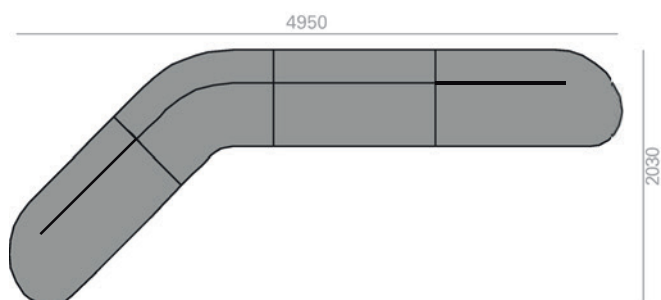

€	COM	COL	1	2	3	4	5	6	7	8	9	10	11	L1	L2	L3	L6
	5.868	6.018	6.199	6.348	6.460	6.657	6.859	7.056	7.253	7.451	7.649	7.844	8.043	8.218	8.935	10.457	14.480

Examples of modular configurations
Ejemplos de combinaciones modulares

Set 7 / Conjunto 7

5 Modules 5 Módulos

SF0295 + SF0292 + SF0299 + SF0292 + SF0294

	COM cm. per unit	COL m2
1 units	1800	36
10 units or more	1800	

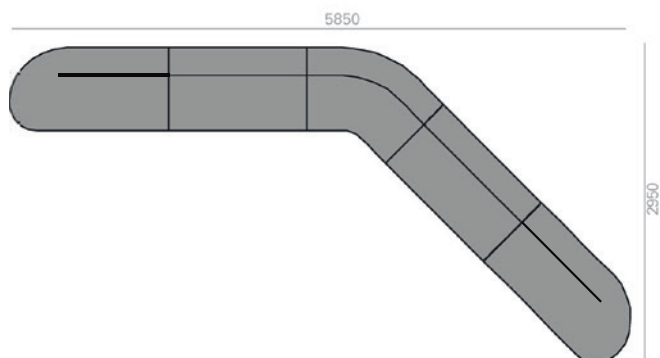

€	COM	COL	1	2	3	4	5	6	7	8	9	10	11	L1	L2	L3	L6
	7.170	7.352	7.570	7.750	7.886	8.125	8.369	8.606	8.845	9.085	9.325	9.560	9.801	10.013	10.880	12.675	17.460

Set 8 / Conjunto 8

4 Modules 4 Módulos

SF0295 + SF0299 + SF0299 + SF0294

	COM cm. per unit	COL m2
1 units	1600	32
10 units or more	1600	

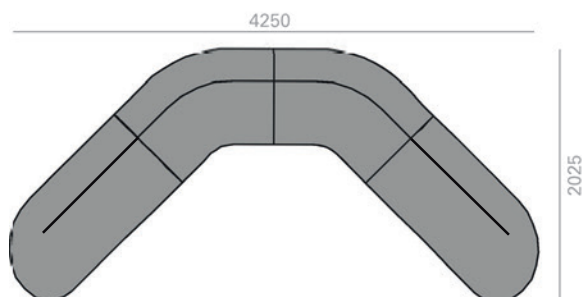

€	COM	COL	1	2	3	4	5	6	7	8	9	10	11	L1	L2	L3	L6
	5.970	6.128	6.322	6.480	6.600	6.808	7.022	7.234	7.442	7.652	7.862	8.070	8.282	8.468	9.232	10.950	15.276

Set 9 / Conjunto 9

5 Modules 5 Módulos

SF0295 + SF0299 + SF0292 + SF0299 + SF0294

	COM cm. per unit	COL m2
1 units	1900	38
10 units or more	1900	

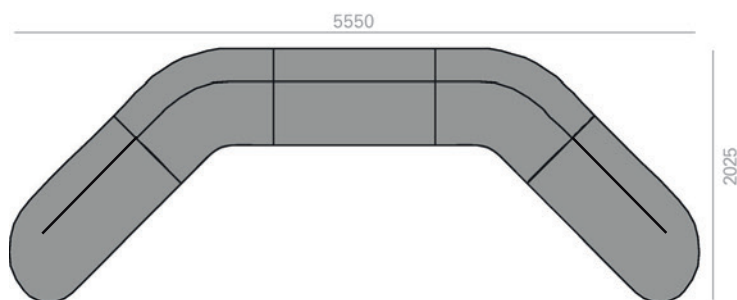

€	COM	COL	1	2	3	4	5	6	7	8	9	10	11	L1	L2	L3	L6
	7.272	7.462	7.693	7.882	8.026	8.276	8.532	8.784	9.034	9.286	9.538	9.786	10.040	10.263	11.177	13.168	18.256

Examples of modular configurations
Ejemplos de combinaciones modulares

Set 10 / Conjunto 10

7 Modules 7 Módulos
SF0295 + SF0292 + SF0299 + SF0292 + SF0299 +
SF0292 + SF0294

	COM cm. per unit	COL m2
1 units	2500	50
10 units or more	2500	

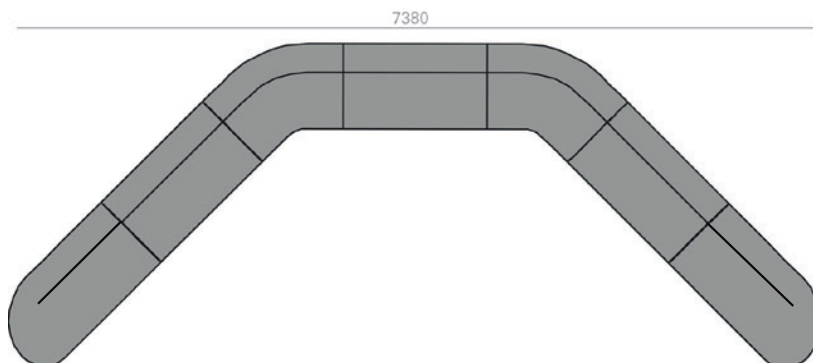

	COM	COL	1	2	3	4	5	6	7	8	9	10	11	L1	L2	L3	L6
€	9.876	10.130	10.435	10.686	10.878	11.212	11.552	11.884	12.218	12.554	12.890	13.218	13.556	13.853	15.067	17.604	24.216

Set 11 / Conjunto 11

3 Modules 3 Módulos
SF0295 + SF0298 + SF0294

	COM cm. per unit	COL m2
1 units	1200	24
10 units or more	1200	

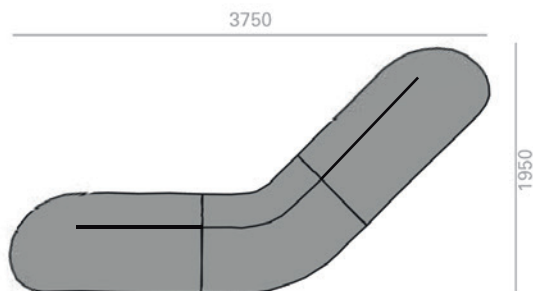

	COM	COL	1	2	3	4	5	6	7	8	9	10	11	L1	L2	L3	L6
€	4.566	4.684	4.828	4.946	5.034	5.190	5.349	5.506	5.662	5.817	5.973	6.130	6.285	6.423	6.990	8.239	11.500

Set 12 / Conjunto 12

4 Modules 4 Módulos
SF0295 + SF0292 + SF0298 + SF0294

	COM cm. per unit	COL m2
1 units	1500	30
10 units or more	1500	

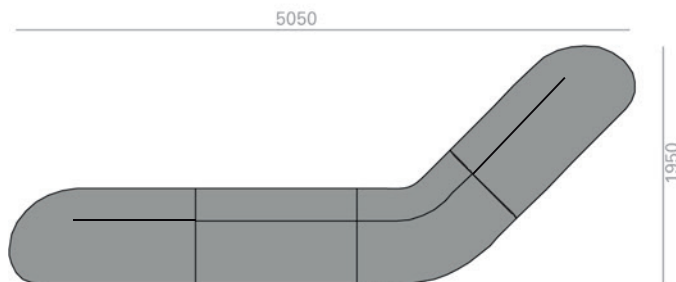

	COM	COL	1	2	3	4	5	6	7	8	9	10	11	L1	L2	L3	L6
€	5.868	6.018	6.199	6.348	6.460	6.658	6.859	7.056	7.254	7.451	7.649	7.846	8.043	8.218	8.935	10.457	14.480

Examples of modular configurations
Ejemplos de combinaciones modulares

Set 13 / Conjunto 13

4 Modules 4 Módulos
SF0295 + SF0298 + SF0292 + SF0294

	COM cm. per unit	COL m2
1 units	1500	30
10 units or more	1500	

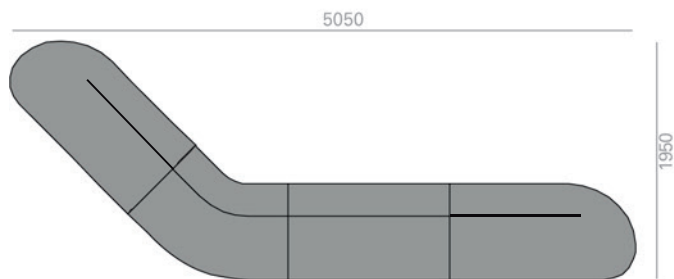

	COM	COL	1	2	3	4	5	6	7	8	9	10	11	L1	L2	L3	L6
€	5.868	6.018	6.199	6.348	6.460	6.658	6.859	7.056	7.254	7.451	7.649	7.846	8.043	8.218	8.935	10.457	14.480

Set 14 / Conjunto 14

5 Modules 5 Módulos
SF0295 + SF0292 + SF0298 + SF0294

	COM cm. per unit	COL m2
1 units	1800	36
10 units or more	1800	

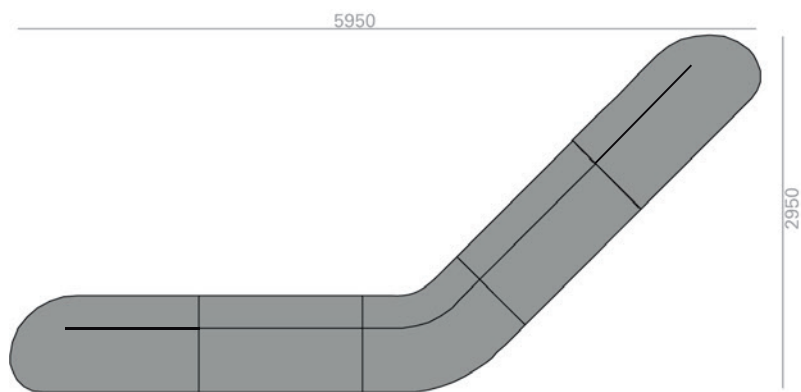

	COM	COL	1	2	3	4	5	6	7	8	9	10	11	L1	L2	L3	L6
€	7.170	7.352	7.570	7.750	7.886	8.126	8.369	8.606	8.846	9.085	9.325	9.562	9.801	10.013	10.880	12.675	17.460

Set 15 / Conjunto 15

4 Modules 4 Módulos
SF0295 + SF0298 + SF0298 + SF0294

	COM cm. per unit	COL m2
1 units	1600	32
10 units or more	1600	

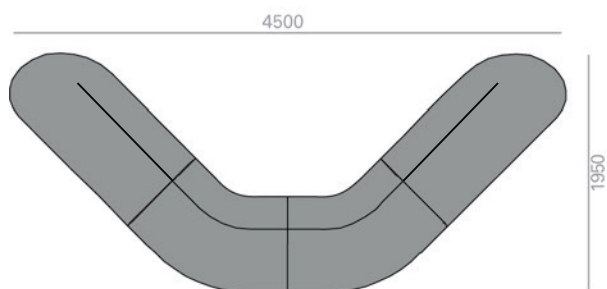

	COM	COL	1	2	3	4	5	6	7	8	9	10	11	L1	L2	L3	L6
€	5.970	6.128	6.322	6.480	6.600	6.810	7.022	7.234	7.444	7.652	7.862	8.074	8.282	8.468	9.232	10.950	15.276

Examples of modular configurations
Ejemplos de combinaciones modulares

Set 16 / Conjunto 16

5 Modules 5 Módulos
SF0295 + SF0298 + SF0292 + SF0298 + SF0294

	COM cm. per unit	COL m2
1 units	1900	38
10 units or more	1900	

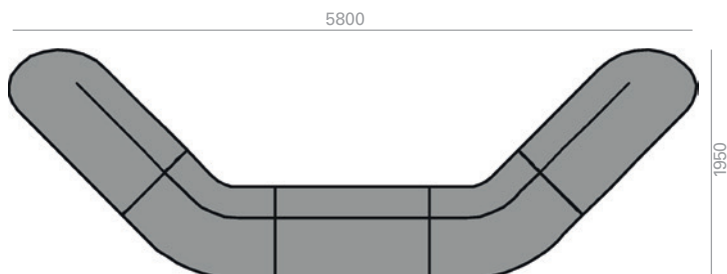

€	COM	COL	1	2	3	4	5	6	7	8	9	10	11	L1	L2	L3	L6
	7.272	7.462	7.693	7.882	8.026	8.278	8.532	8.784	9.036	9.286	9.538	9.790	10.040	10.263	11.177	13.168	18.256

Set 17 / Conjunto 17

7 Modules 7 Módulos
SF0295 + SF0292 + SF0298 + SF0292 + SF0298 + SF0292 + SF0294

	COM cm. per unit	COL m2
1 units	2500	50
10 units or more	2500	

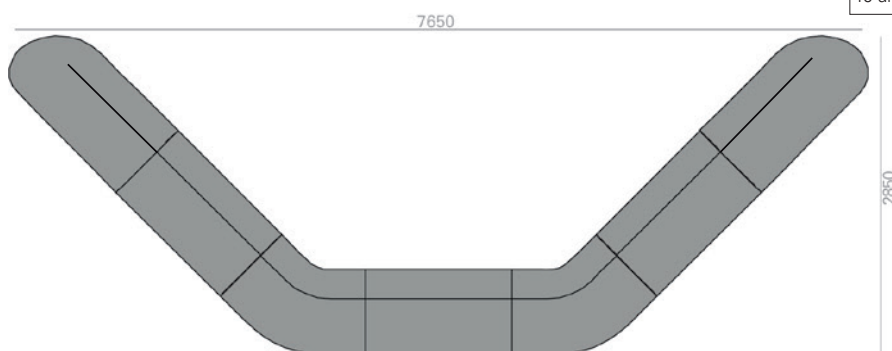

€	COM	COL	1	2	3	4	5	6	7	8	9	10	11	L1	L2	L3	L6
	9.876	10.130	10.435	10.686	10.878	11.214	11.552	11.884	12.220	12.554	12.890	13.222	13.556	13.853	15.067	17.604	24.216

Set 18 / Conjunto 18

3 Modules 3 Módulos
SF0295 + SF0297 + SF0294

	COM cm. per unit	COL m2
1 units	1200	24
10 units or more	1200	

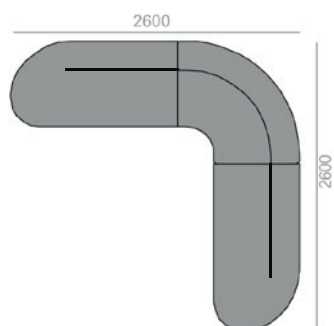

€	COM	COL	1	2	3	4	5	6	7	8	9	10	11	L1	L2	L3	L6
	4.569	4.685	4.828	4.945	5.032	5.185	5.344	5.497	5.656	5.817	5.978	6.139	6.300	6.442	7.025	8.193	11.413

Examples of modular configurations
Ejemplos de combinaciones modulares

Set 19 / Conjunto 19

5 Modules 5 Módulos

SF0295 + SF0292 + SF0297 + SF0292 + SF0294

	COM cm. per unit	COL m2
1 units	1800	36
10 units or more	1800	

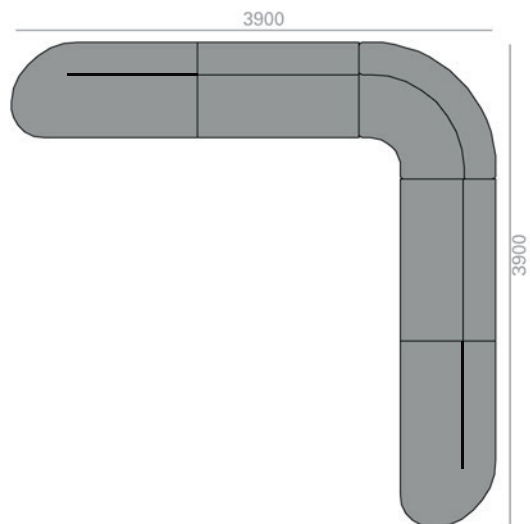

€	COM	COL	1	2	3	4	5	6	7	8	9	10	11	L1	L2	L3	L6
	7.173	7.353	7.570	7.749	7.884	8.121	8.364	8.597	8.840	9.085	9.330	9.571	9.816	10.032	10.915	12.629	17.373

Set 20 / Conjunto 20

6 Modules 6 Módulos

SF0295 + SF0297 + SF0292 + SF0292 + SF0297 + SF0294

	COM cm. per unit	COL m2
1 units	2200	44
10 units or more	2200	

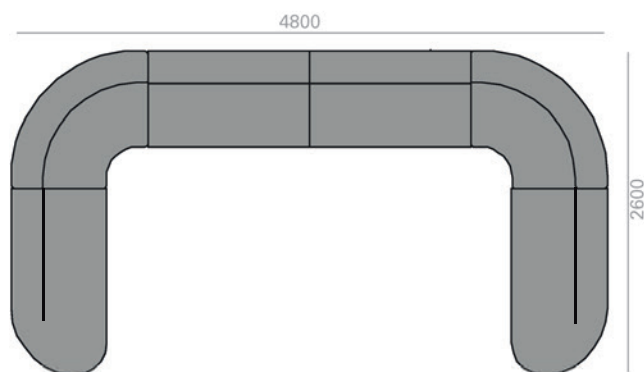

€	COM	COL	1	2	3	4	5	6	7	8	9	10	11	L1	L2	L3	L6
	8.580	8.798	9.064	9.282	9.448	9.736	10.032	10.316	10.616	10.920	11.224	11.524	11.828	12.096	13.192	15.294	21.062

Examples of modular configurations
Ejemplos de combinaciones modulares

Set 21 / Conjunto 21

8 Modules 8 Módulos

SF0295 + SF0292 + SF0297 + SF0292 + SF0292 +
SF0297 + SF0292 + SF0294

	COM cm. per unit	COL m2
1 units	2800	56
10 units or more	2800	

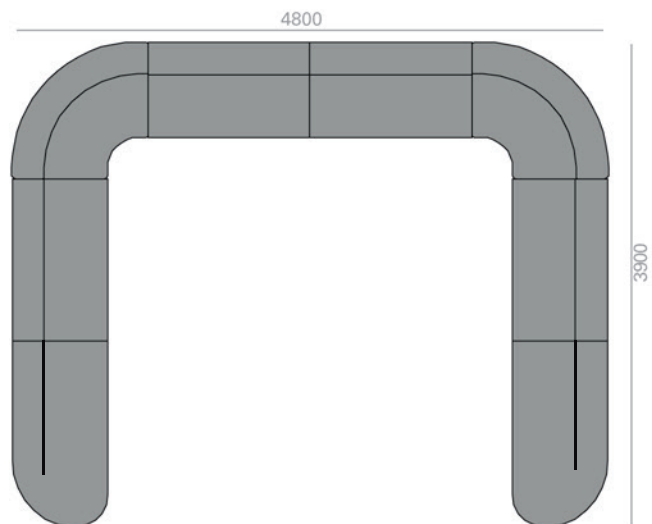

COM	COL	1	2	3	4	5	6	7	8	9	10	11	L1	L2	L3	L6	
€	11.184	11.466	11.806	12.086	12.300	12.672	13.052	13.416	13.800	14.188	14.576	14.956	15.344	15.686	17.082	19.730	27.022

Set 22 / Conjunto 22

3 Modules 3 Módulos

SF0295 + SF0296 + SF0294

	COM cm. per unit	COL m2
1 units	1200	24
10 units or more	1200	

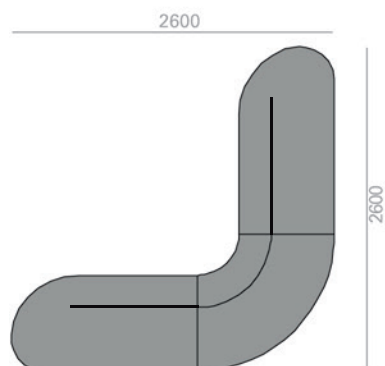

COM	COL	1	2	3	4	5	6	7	8	9	10	11	L1	L2	L3	L6	
€	4.569	4.685	4.828	4.945	5.032	5.185	5.344	5.497	5.656	5.817	5.978	6.139	6.300	6.442	7.025	8.193	11.413

Examples of modular configurations
Ejemplos de combinaciones modulares

Set 23 / Conjunto 23

5 Modules 5 Módulos

SF0295 + SF0292 + SF0296 + SF0292 + SF0294

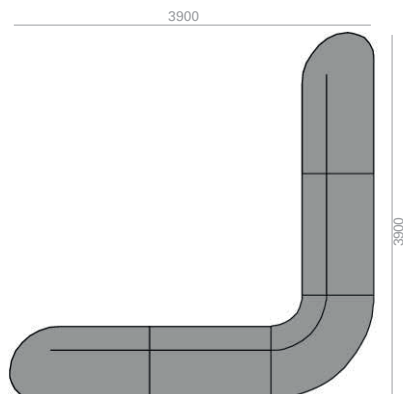

	COM cm. per unit	COL m2
1 units	1800	36
10 units or more	1800	

€	COM	COL	1	2	3	4	5	6	7	8	9	10	11	L1	L2	L3	L6
	7.173	7.353	7.570	7.749	7.884	8.121	8.364	8.597	8.840	9.085	9.330	9.571	9.816	10.032	10.915	12.629	17.373

Set 24 / Conjunto 24

4 Modules 4 Módulos

SF0295 + SF0299 + SF0299 + SF0294

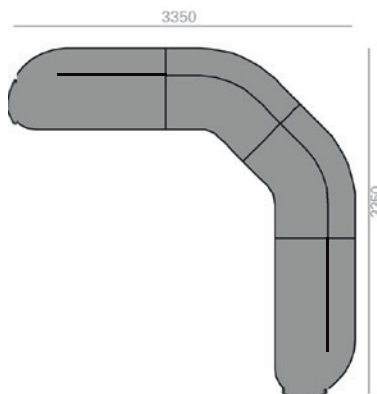

	COM cm. per unit	COL m2
1 units	1600	32
10 units or more	1600	

€	COM	COL	1	2	3	4	5	6	7	8	9	10	11	L1	L2	L3	L6
	5.970	6.128	6.322	6.480	6.600	6.808	7.022	7.234	7.442	7.652	7.862	8.070	8.282	8.468	9.232	10.950	15.276

Set 25 / Conjunto 25

6 Modules 6 Módulos

SF0295 + SF0292 + SF0299 + SF0299 + SF0292 + SF0294

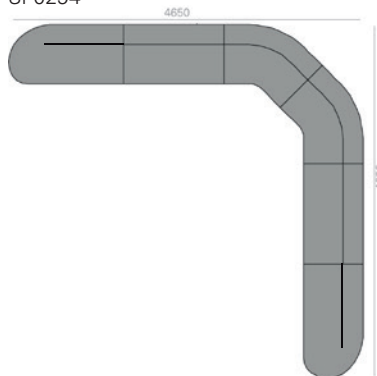

	COM cm. per unit	COL m2
1 units	2200	44
10 units or more	2200	

€	COM	COL	1	2	3	4	5	6	7	8	9	10	11	L1	L2	L3	L6
	8.574	8.796	9.064	9.284	9.452	9.744	10.042	10.334	10.626	10.920	11.214	11.502	11.798	12.058	13.122	15.386	21.236

Examples of modular configurations
Ejemplos de combinaciones modulares

Set 26 / Conjunto 26

6 Modules 6 Módulos

SF0295 + SF0299 + SF0299 + SF0299 + SF0299 + SF0294

	COM cm. per unit	COL m2
1 units	2400	48
10 units or more	2400	

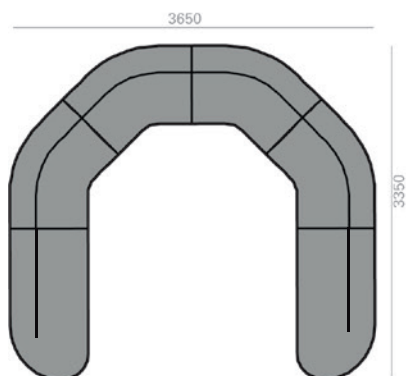

€	COM	COL	1	2	3	4	5	6	7	8	9	10	11	L1	L2	L3	L6
	8.778	9.016	9.310	9.548	9.732	10.046	10.368	10.690	11.004	11.322	11.640	11.954	12.276	12.558	13.716	16.372	22.828

Set 27 / Conjunto 27

7 Modules 7 Módulos

SF0295 + SF0299 + SF0299 + SF0292 + SF0299 + SF0299 + SF0294

	COM cm. per unit	COL m2
1 units	2700	54
10 units or more	2700	

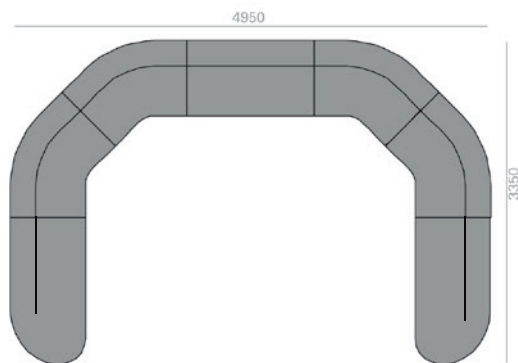

€	COM	COL	1	2	3	4	5	6	7	8	9	10	11	L1	L2	L3	L6
	10.080	10.350	10.681	10.950	11.158	11.514	11.878	12.240	12.596	12.956	13.316	13.670	14.034	14.353	15.661	18.590	25.808

Set 28 / Conjunto 28

9 Modules 9 Módulos

SF0295 + SF0292 + SF0299 + SF0299 + SF0292 + SF0299 + SF0299 + SF0292 + SF0294

	COM cm. per unit	COL m2
1 units	3300	66
10 units or more	3300	

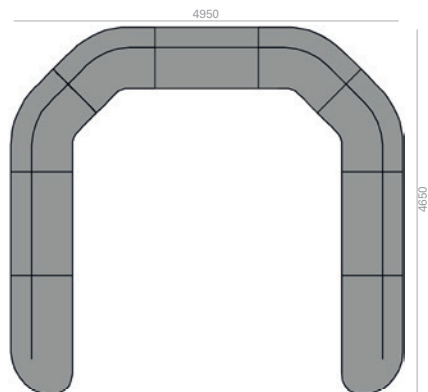

€	COM	COL	1	2	3	4	5	6	7	8	9	10	11	L1	L2	L3	L6
	12.684	13.018	13.423	13.754	14.010	14.450	14.898	15.340	15.780	16.224	16.668	17.102	17.550	17.943	19.551	23.026	31.768

Examples of modular configurations Ejemplos de combinaciones modulares

Set 29 / Conjunto 29

4 Modules 4 Módulos
SF0294 + SF0298 + SF0298 + SF0295

	COM cm. per unit	COL m2
1 units	1600	32
10 units or more	1600	

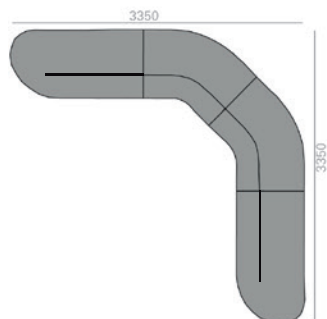

€	COM	COL	1	2	3	4	5	6	7	8	9	10	11	L1	L2	L3	L6
	5.970	6.128	6.322	6.480	6.600	6.810	7.022	7.234	7.444	7.652	7.862	8.074	8.282	8.468	9.232	10.950	15.276

Set 30 / Conjunto 30

6 Modules 6 Módulos
SF0294 + SF0292 + SF0298 + SF0298 + SF0292 + SF0295

	COM cm. per unit	COL m2
1 units	2200	44
10 units or more	2200	

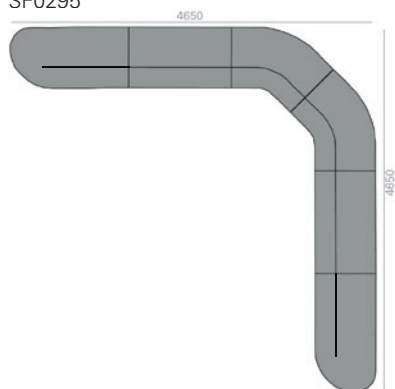

€	COM	COL	1	2	3	4	5	6	7	8	9	10	11	L1	L2	L3	L6
	8.574	8.796	9.064	9.284	9.452	9.746	10.042	10.334	10.628	10.920	11.214	11.506	11.798	12.058	13.122	15.386	21.236

Set 31 / Conjunto 31

5 Modules 5 Módulos
SF0295 + SF0298 + SF0298 + SF0298 + SF0294

	COM cm. per unit	COL m2
1 units	2000	40
10 units or more	2000	

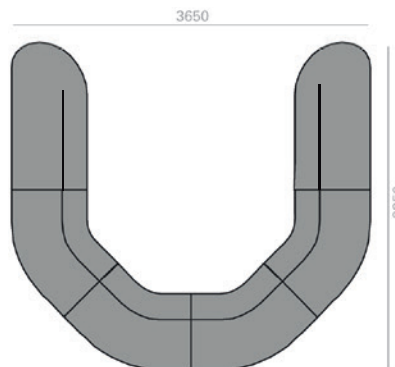

€	COM	COL	1	2	3	4	5	6	7	8	9	10	11	L1	L2	L3	L6
	7.374	7.572	7.816	8.014	8.166	8.430	8.695	8.962	9.226	9.487	9.751	10.018	10.279	10.513	11.474	13.661	19.052

Examples of modular configurations
Ejemplos de combinaciones modulares

Set 32 / Conjunto 32

9 Modules 9 Módulos

SF0295 + SF0292 + SF0298 + SF0298 + SF0292 +
SF0298 + SF0298 + SF0292 + SF0294

	COM cm. per unit	COL m2
1 units	3300	66
10 units or more	3300	

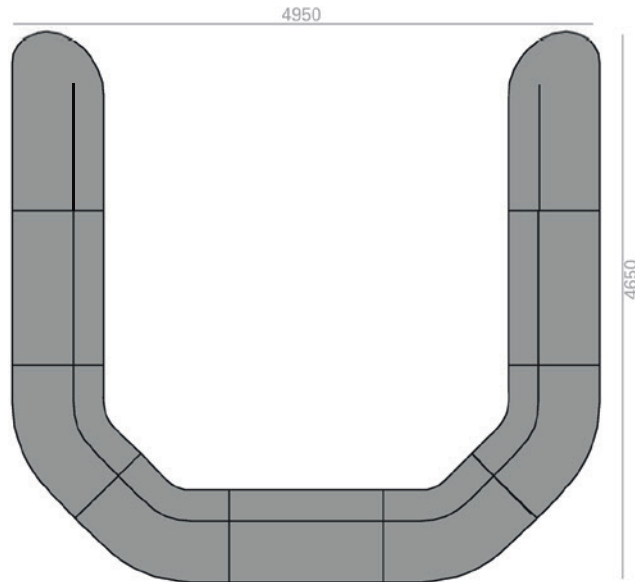

	COM	COL	1	2	3	4	5	6	7	8	9	10	11	L1	L2	L3	L6
€	12.684	13.018	13.423	13.754	14.010	14.454	14.898	15.340	15.784	16.224	16.668	17.110	17.550	17.943	19.551	23.026	31.768

Set 33 / Conjunto 33

10 Modules 10 Módulos

SF0295 + SF0297 + SF0292 + SF0297 + SF0296 +
SF0296 + SF0297 + SF0292 + SF0297 + SF0294

	COM cm. per unit	COL m2
1 units	3800	76
10 units or more	3800	

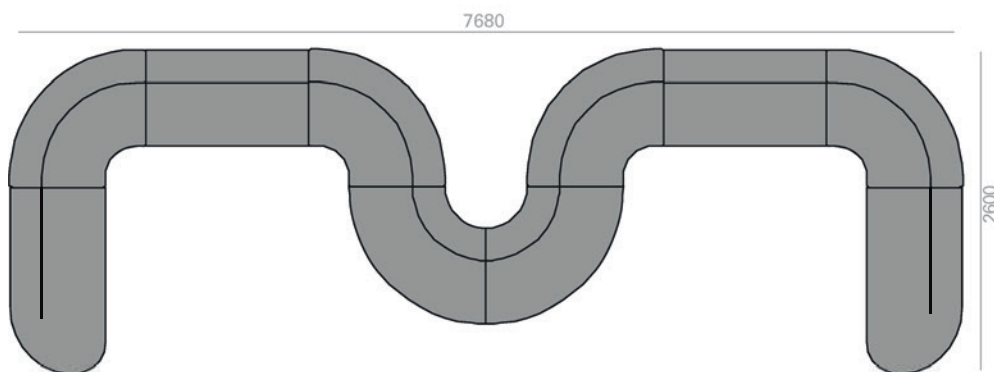

	COM	COL	1	2	3	4	5	6	7	8	9	10	11	L1	L2	L3	L6
€	14.208	14.578	15.040	15.414	15.704	16.196	16.704	17.192	17.720	18.260	18.800	19.336	19.876	20.352	22.300	25.954	35.818

Examples of modular configurations
Ejemplos de combinaciones modulares

Set 34 / Conjunto 34

11 Modules 11 Módulos

SF0295 + SF0296 + SF0296 + SF0292 + SF0297 +
SF0292 + SF0297 + SF0292 + SF0296 + SF0296 +
SF0294

	COM cm. per unit	COL m2
1 units	4100	82
10 units or more	4100	

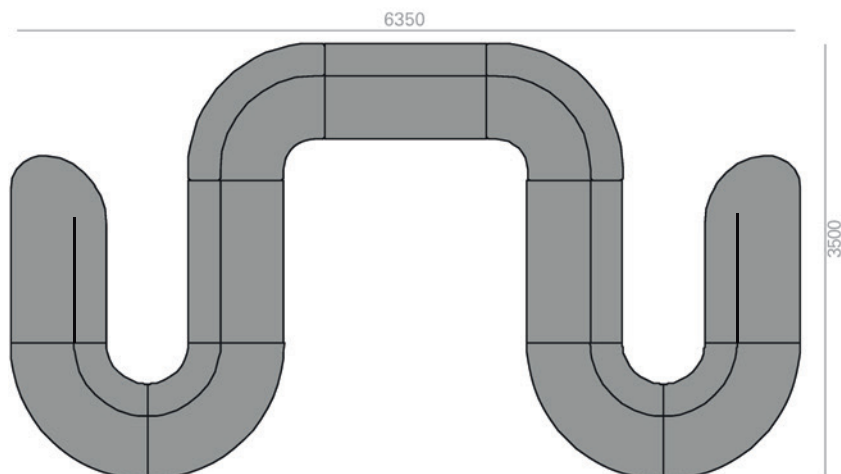

COM	COL	1	2	3	4	5	6	7	8	9	10	11	L1	L2	L3	L6
€ 15.510	15.912	16.411	16.816	17.130	17.664	18.214	18.742	19.312	19.894	20.476	21.052	21.634	22.147	24.245	28.172	38.798

Set 35 / Conjunto 35

11 Modules 11 Módulos

SF0295 + SF0297 + SF0296 + SF0296 + SF0297 +
SF0292 + SF0297 + SF0296 + SF0296 + SF0297 +
SF0294

	COM cm. per unit	COL m2
1 units	4300	86
10 units or more	4300	

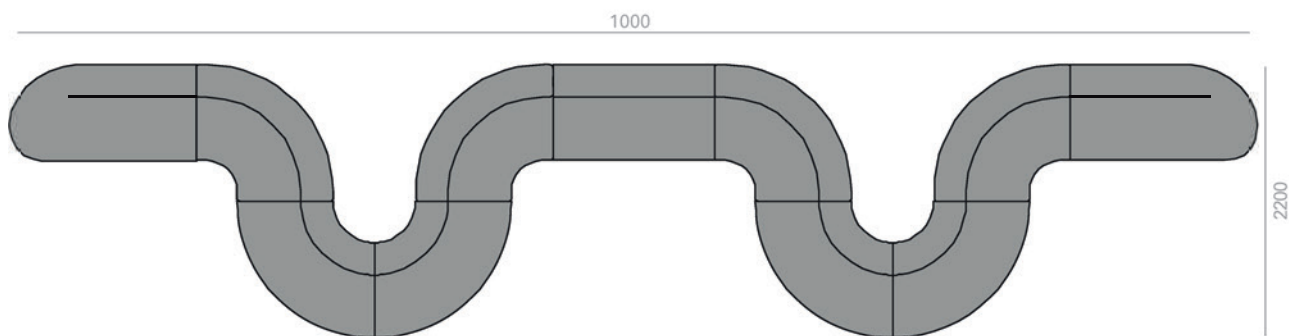

COM	COL	1	2	3	4	5	6	7	8	9	10	11	L1	L2	L3	L6
€ 15.720	16.134	16.657	17.078	17.406	17.958	18.530	19.080	19.680	20.296	20.912	21.526	22.142	22.685	24.909	29.066	40.216

Examples of modular configurations
Ejemplos de combinaciones modulares

Set 36 / Conjunto 36

9 Modules 9 Módulos

SF0295 + SF0296 + SF0299 + SF0299 + SF0296 +
SF0299 + SF0299 + SF0296 + SF0294

	COM cm. per unit	COL m2
1 units	3600	72
10 units or more	3600	

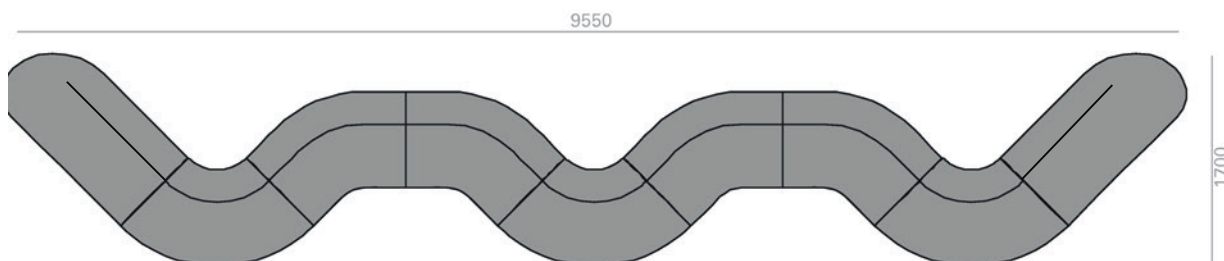

	COM	COL	1	2	3	4	5	6	7	8	9	10	11	L1	L2	L3	L6
€	12.999	13.351	13.792	14.147	14.424	14.891	15.372	15.847	16.332	16.827	17.322	17.813	18.312	18.750	20.547	24.367	33.895

Set 37 / Conjunto 37

10 Modules 10 Módulos

SF0295 + SF0298 + SF0299 + SF0299 + SF0298 +
SF0298 + SF0299 + SF0299 + SF0298 + SF0294

	COM cm. per unit	COL m2
1 units	4000	80
10 units or more	4000	

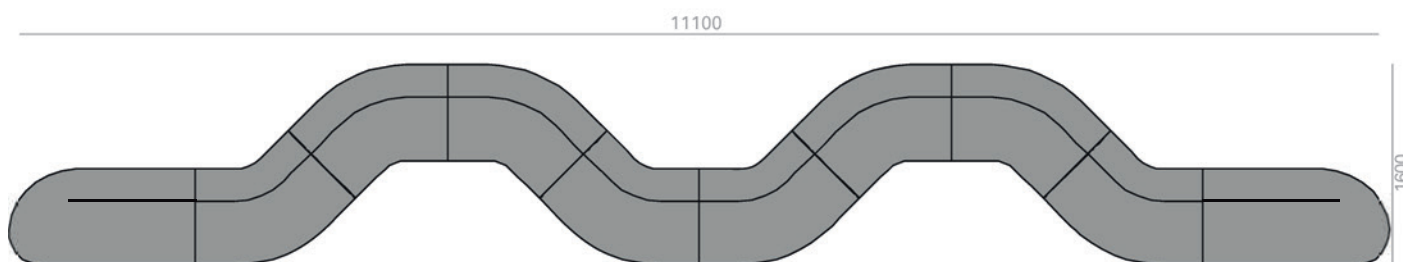

	COM	COL	1	2	3	4	5	6	7	8	9	10	11	L1	L2	L3	L6
€	14.394	14.792	15.286	15.684	15.996	16.526	17.060	17.602	18.132	18.662	19.196	19.730	20.264	20.738	22.684	27.216	37.932

Examples of modular configurations
Ejemplos de combinaciones modulares

Set 38 / Conjunto 38

7 Modules 7 Módulos

SF0295 + SF0297 + SF0296 + SF0297 + SF0296 +
SF0297 + SF0294

	COM cm. per unit	COL m2
1 units	2800	56
10 units or more	2800	

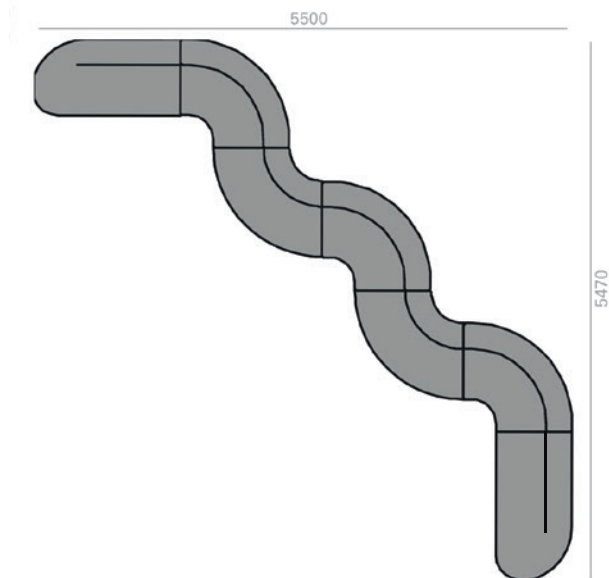

COM	COL	1	2	3	4	5	6	7	8	9	10	11	L1	L2	L3	L6
€ 10.197	10.465	10.804	11.077	11.288	11.645	12.016	12.373	12.760	13.157	13.554	13.951	14.348	14.698	16.133	18.853	26.169

Set 39 / Conjunto 39

6 Modules 6 Módulos

SF0295 + SF0298 + SF0299 + SF0298 + SF0299 +
SF0294

	COM cm. per unit	COL m2
1 units	2400	48
10 units or more	2400	

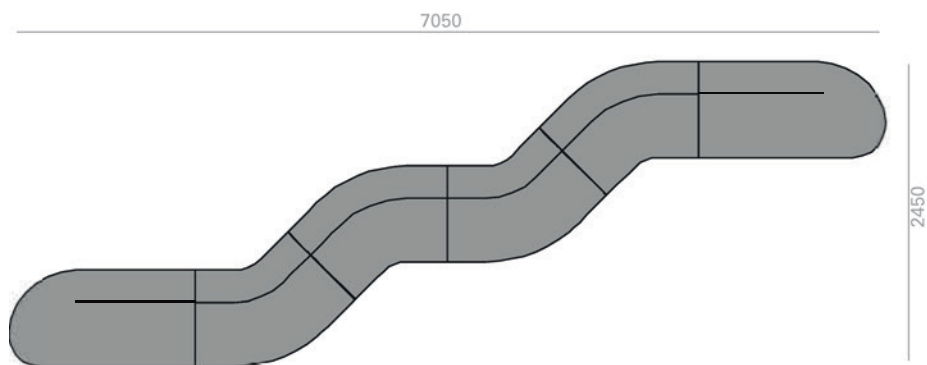

COM	COL	1	2	3	4	5	6	7	8	9	10	11	L1	L2	L3	L6
€ 8.778	9.016	9.310	9.548	9.732	10.048	10.368	10.690	11.006	11.322	11.640	11.958	12.276	12.558	13.716	16.372	22.828

Examples of modular configurations
Ejemplos de combinaciones modulares

Set 40 / Conjunto 40

4 Modules 4 Módulos
SF0296 + SF0296 + SF0296 + SF0296

	COM cm. per unit	COL m2
1 units	1600	32
10 units or more	1600	

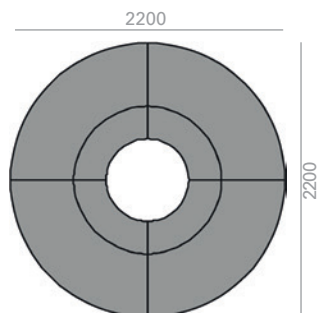

€	COM	COL	1	2	3	4	5	6	7	8	9	10	11	L1	L2	L3	L6
	5.628	5.780	5.976	6.132	6.256	6.460	6.672	6.876	7.104	7.340	7.576	7.812	8.048	8.256	9.108	10.660	14.756

Set 41 / Conjunto 41

6 Modules 6 Módulos
SF0292 + SF0296 + SF0296 + SF0292 + SF0296 + SF0296

	COM cm. per unit	COL m2
1 units	2200	44
10 units or more	2200	

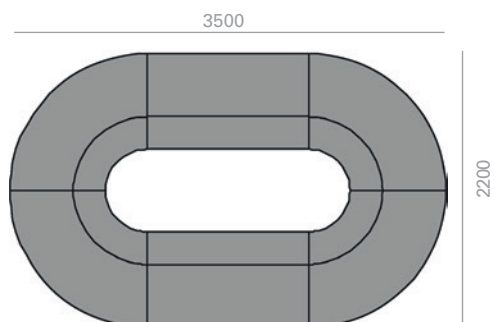

€	COM	COL	1	2	3	4	5	6	7	8	9	10	11	L1	L2	L3	L6
	8.232	8.448	8.718	8.936	9.108	9.396	9.692	9.976	10.288	10.608	10.928	11.244	11.564	11.846	12.998	15.096	20.716

Set 42 / Conjunto 42

8 Modules 8 Módulos
SF0292 + SF0292 + SF0296 + SF0296 + SF0292 + SF0296 + SF0296 + SF0296

	COM cm. per unit	COL m2
1 units	2800	56
10 units or more	2800	

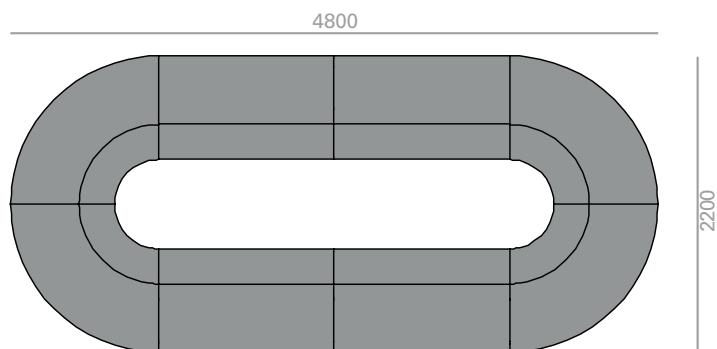

€	COM	COL	1	2	3	4	5	6	7	8	9	10	11	L1	L2	L3	L6
	10.836	11.116	11.460	11.740	11.960	12.332	12.712	13.076	13.472	13.876	14.280	14.676	15.080	15.436	16.888	19.532	26.676

Examples of modular configurations
Ejemplos de combinaciones modulares

Set 43 / Conjunto 43

8 Modules 8 Módulos

SF0298 + SF0298 + SF0298 + SF0298 + SF0298 +
SF0298 + SF0298 + SF0298

	COM cm. per unit	COL m2
1 units	3200	64
10 units or more	3200	

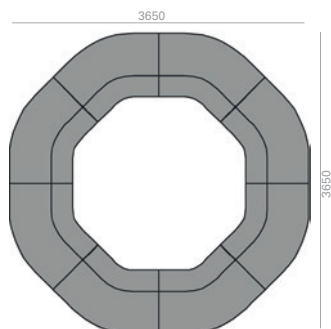

	COM	COL	1	2	3	4	5	6	7	8	9	10	11	L1	L2	L3	L6
€	11.232	11.552	11.952	12.272	12.528	12.960	13.384	13.824	14.256	14.680	15.112	15.552	15.976	16.360	17.936	21.688	30.208

Set 44 / Conjunto 44

4 Modules 4 Módulos

SF0294 + SF0296 + SF0296 + SF0295

	COM cm. per unit	COL m2
1 units	1600	32
10 units or more	1600	

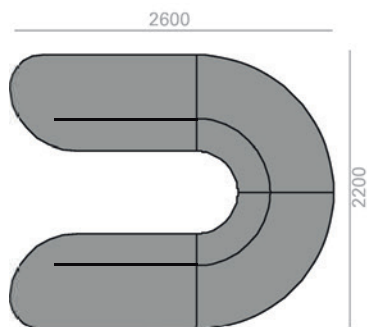

	COM	COL	1	2	3	4	5	6	7	8	9	10	11	L1	L2	L3	L6
€	5.976	6.130	6.322	6.478	6.596	6.800	7.012	7.216	7.432	7.652	7.872	8.092	8.312	8.506	9.302	10.858	15.102

Set 45 / Conjunto 45

6 Modules 6 Módulos

SF0294 + SF0292 + SF0296 + SF0296 + SF0292 +
SF0295

	COM cm. per unit	COL m2
1 units	2200	44
10 units or more	2200	

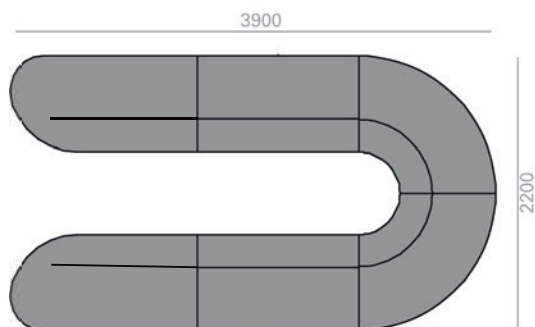

	COM	COL	1	2	3	4	5	6	7	8	9	10	11	L1	L2	L3	L6
€	8.580	8.798	9.064	9.282	9.448	9.736	10.032	10.316	10.616	10.920	11.224	11.524	11.828	12.096	13.192	15.294	21.062

Examples of modular configurations
Ejemplos de combinaciones modulares

Set 46 / Conjunto 46

8 Modules 8 Módulos

SF0294 + SF0292 + SF0292 + SF0296 + SF0296 + SF0292 + SF0292 + SF0295

	COM cm. per unit	COL m2
1 units	2800	56
10 units or more	2800	

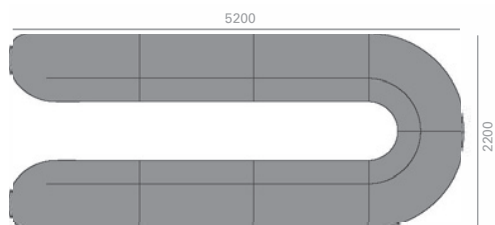

	COM	COL	1	2	3	4	5	6	7	8	9	10	11	L1	L2	L3	L6
€	11.184	11.466	11.806	12.086	12.300	12.672	13.052	13.416	13.800	14.188	14.576	14.956	15.344	15.686	17.082	19.730	27.022

Set 47 / Conjunto 47

13 Modules 13 Módulos

SF0295 + SF0297 + SF0292 + SF0299 + SF0299 + SF0292 + SF0292 + SF0292 + SF0299 + SF0299 + SF0292 + SF0297 + SF0294

	COM cm. per unit	COL m2
1 units	4700	94
10 units or more	4700	

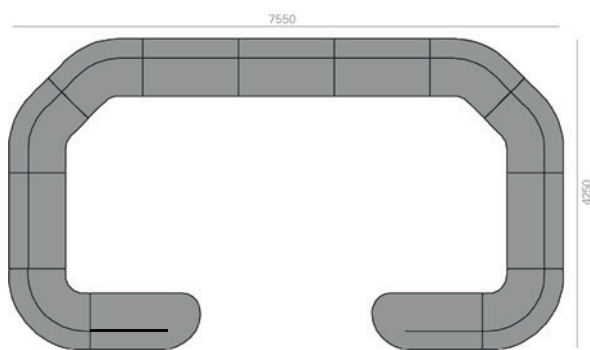

	COM	COL	1	2	3	4	5	6	7	8	9	10	11	L1	L2	L3	L6
€	18.102	18.576	19.153	19.624	19.990	20.616	21.254	21.878	22.516	23.162	23.808	24.440	25.090	25.661	27.995	32.792	45.106

Set 48 / Conjunto 48

12 Modules 12 Módulos

SF0295 + SF0299 + SF0299 + SF0299 + SF0299 + SF0296 + SF0296 + SF0299 + SF0299 + SF0299 + SF0299 + SF0294

	COM cm. per unit	COL m2
1 units	4800	96
10 units or more	4800	

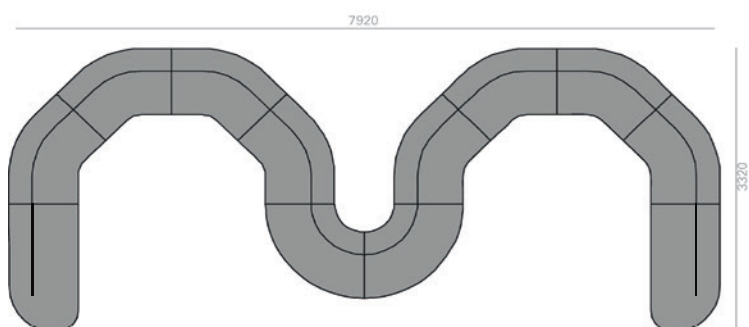

	COM	COL	1	2	3	4	5	6	7	8	9	10	11	L1	L2	L3	L6
€	17.208	17.682	18.274	18.750	19.124	19.752	20.396	21.040	21.680	22.332	22.984	23.628	24.288	24.866	27.238	32.546	45.310

Examples of modular configurations
Ejemplos de combinaciones modulares

Set 49 / Conjunto 49

16 Modules 16 Módulos

SF0296 + SF0296 + SF0299 + SF0299 + SF0296 +
SF0296 + SF0299 + SF0299 + SF0296 + SF0296 +
SF0299 + SF0299 + SF0296 + SF0296 + SF0299 +
SF0299

	COM cm. per unit	COL m2
1 units	6400	128
10 units or more	6400	

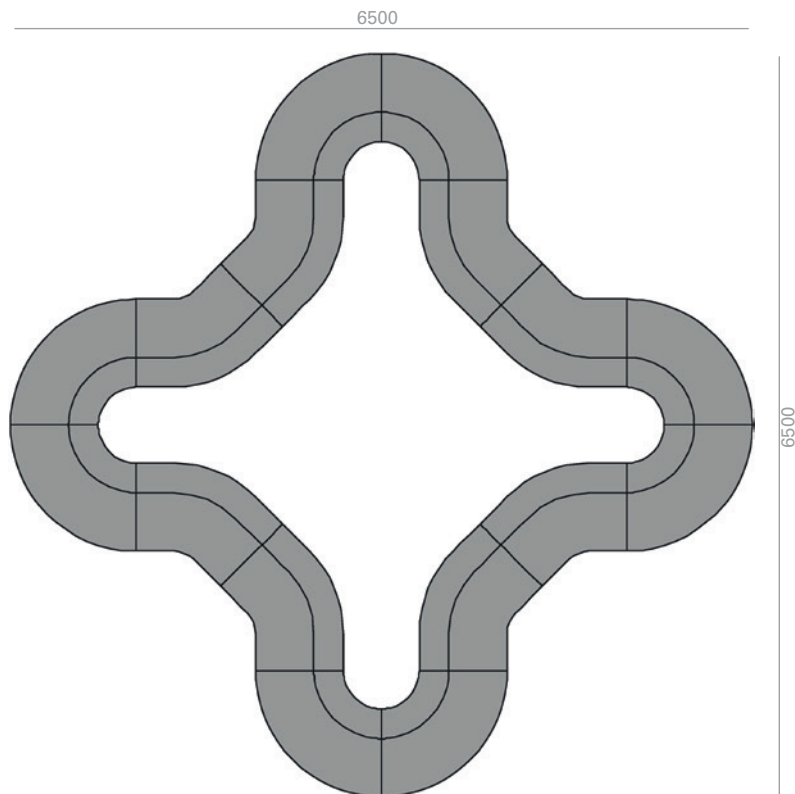

	COM	COL	1	2	3	4	5	6	7	8	9	10	11	L1	L2	L3	L6
€	22.488	23.112	23.904	24.536	25.040	25.872	26.728	27.576	28.456	29.360	30.264	31.160	32.072	32.872	36.152	43.008	59.720

Examples of modular configurations
Ejemplos de combinaciones modulares

Set 50 / Conjunto 50

13 Modules 13 Módulos

SF0295 + SF0299 + SF0292 + SF0299 + SF0292 +
SF0299 + SF0292 + SF0299 + SF0292 + SF0299 +
SF0292 + SF0299 + SF0294

	COM cm. per unit	COL m2
1 units	4700	94
10 units or more	4700	

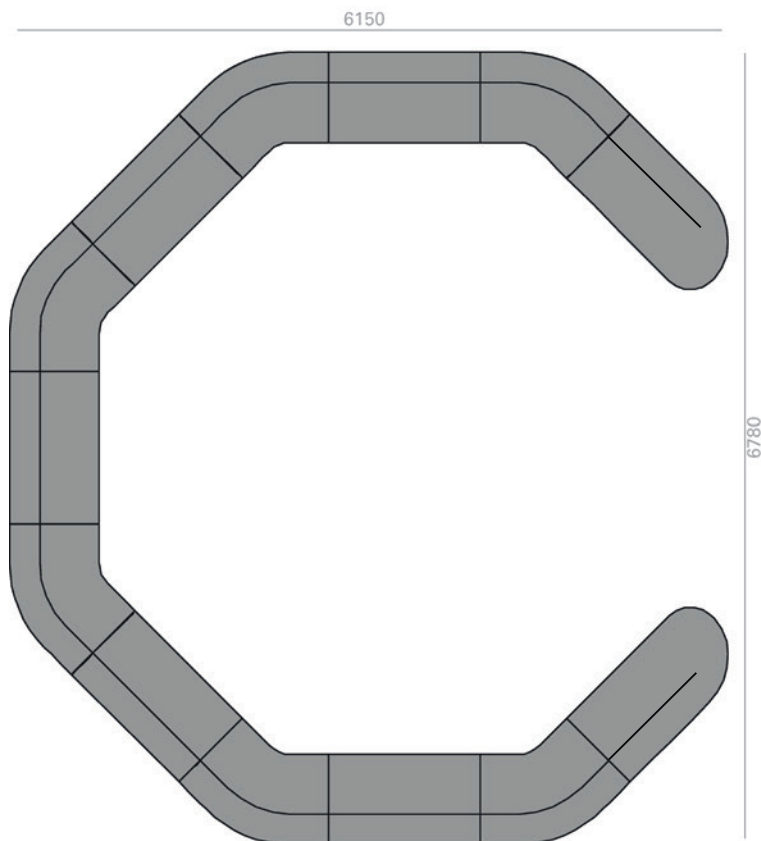

	COM	COL	1	2	3	4	5	6	7	8	9	10	11	L1	L2	L3	L6
€	18.096	18.574	19.153	19.626	19.994	20.624	21.264	21.896	22.526	23.162	23.798	24.418	25.060	25.623	27.925	32.884	45.280

Examples of modular configurations
Ejemplos de combinaciones modulares

Set 51 / Conjunto 51

13 Modules 13 Módulos

SF0294 + SF0298 + SF0292 + SF0298 + SF0292 +
SF0298 + SF0292 + SF0298 + SF0292 + SF0298 +
SF0292 + SF0298 + SF0295

	COM cm. per unit	COL m2
1 units	4700	94
10 units or more	4700	

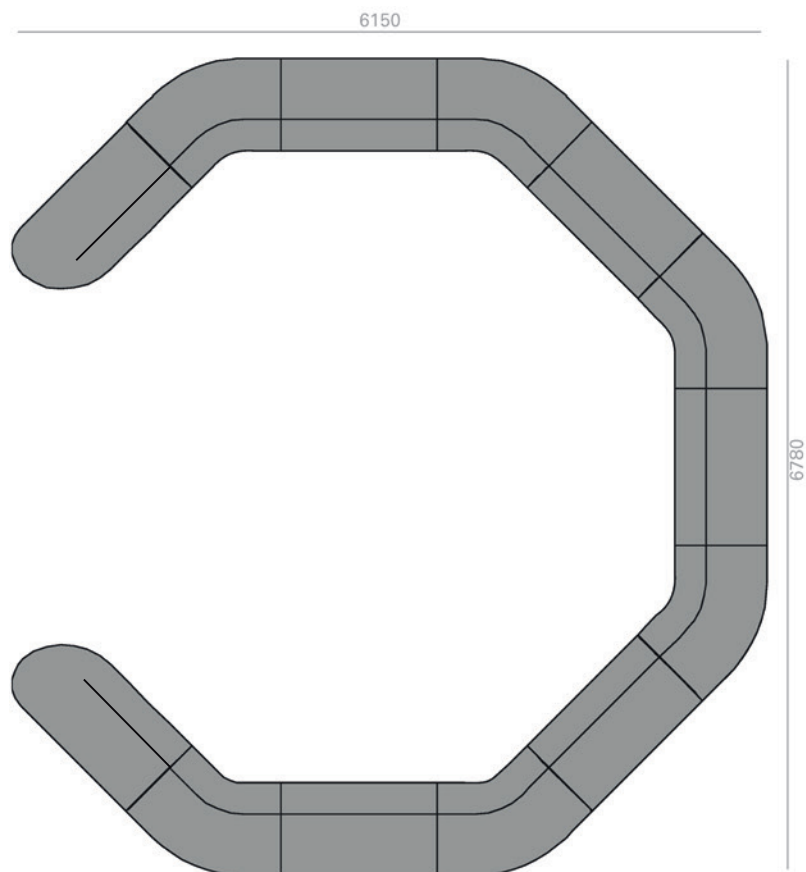

	COM	COL	1	2	3	4	5	6	7	8	9	10	11	L1	L2	L3	L6
€	18.096	18.574	19.153	19.626	19.994	20.630	21.264	21.896	22.532	23.162	23.798	24.430	25.060	25.623	27.925	32.884	45.280

Examples of modular configurations
Ejemplos de combinaciones modulares

Set 52 / Conjunto 52

14 Modules 14 Módulos

SF0298 + SF0298 + SF0298 + SF0298 + SF0298 +
SF0298 + SF0297 + SF0298 + SF0298 + SF0298 +
SF0298 + SF0298 + SF0298 + SF0297

	COM cm. per unit	COL m ²
1 units	5600	112
10 units or more	5600	

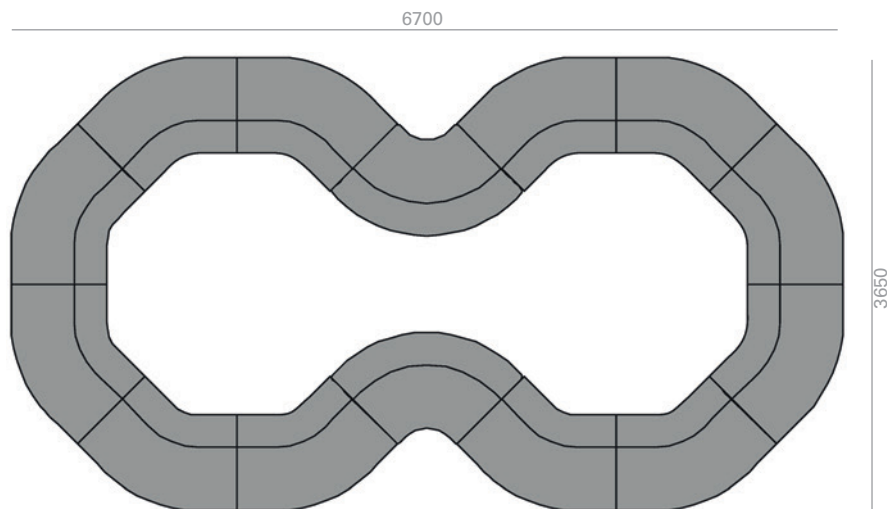

	COM	COL	1	2	3	4	5	6	7	8	9	10	11	L1	L2	L3	L6
€	19.662	20.218	20.916	21.474	21.920	22.670	23.412	24.174	24.936	25.690	26.456	27.234	27.988	28.668	31.458	37.862	52.690

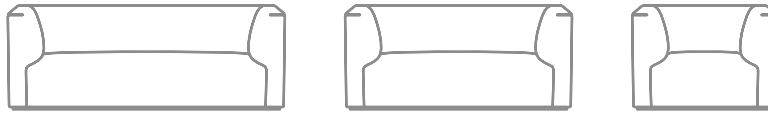

Description
Descripción

Lounge chair and 2- and 3-seater sofas with upholstered seat and backrest and steel plinth base finished in polished chrome, white and black. Piping options are: coordinating with upholstery, white, black or sand color. Additional options include: USB charging system.

Butaca y sofás de 2 y 3 plazas con asiento y respaldo tapizado y base de zócalo de acero en acabado cromo brillo, blanco o negro. Ribete perimetral disponible en tapicería al tono, o en color blanco, negro o arena. Opciones disponibles: sistema USB de carga.

Upholstery
Tapicería

The Grand Raglan collection supports following upholsteries of Andreu World Catalogue. For fabrics in our catalogue not specified in this box or customers own materials please contact our Customer Service Department.

La colección Grand Raglan admite las siguientes tapicerías del catálogo de Andreu World. Para las telas de nuestro catálogo no indicadas en este cuadro o telas cliente, consultar con nuestro Departamento Comercial.

Fabrics / Telas

- 1** Soft-fiber
Jacquard One
Jacquard Three
Citadel
Sand
Era
Gravity
Rivet
Urban
Reel One (in/out)
Spin One
Spin Two
Spin Three
Spin Four
Spin Five
- 2** Jacquard Two
Solid & Stripes
Loom One
Circular One Pure Eco
Tack One (in/out)

- 3** Jacquard Four
Medley
Revive 1
Natte
Main Line Flax
Loom Two (in/out)
Mezzo
Reel two (in/out)
Jacquard Five
- 4** Jacquard 4 Special
Nexus
Field 2
Remix 3
Heritage
Savane
Loom Three
Loom Four
Cura
Oceanic
Reel Three (in/out)
Reel Four (in/out)
Reflect
Spin Six

- 5** Silk
Synergy
Step
Step Melange
Blazer
Melange Nap
Chili
Noma
Re-wool
- 6** Go check
Swing
Chartres
Zori
Patio
Savane
Tack Two (in/out)
Tack Three (in/out)
- 7** Canvas 2
Select
Clara 2
Tack Five (in/out)
Hero 2

- 8** Capture
Fiord 2
Tonus 4
Divina 3
Lopi
Domino
Atrium
- 9** Divina MD
Divina Melange 3
Hallingdal 65
Steelcut Trio 3
Tack Four (in/out)
- 11** Arda
Ecriture
Zero

Faux Leather / Ecopiel

- 1** Valencia
- 2** Silvertex
- 3** Maglia
- 4** Dolce
- 8** Ultraleather
- 9** Brisa
Brisa Distressed
Fresco
Ultraleather Pro
Promessa
- 10** Tottori
Coast (in/out)
- 11** Reef Pro
Volar Bio

Leather / Piel

- L1** High grade cow leather.
Piel de vaca de 1ª categoría.
- L3** Polished full grain leather.
Piel de vaca pulida.
- L6** Aniline leather batique-effect.
Scandinavian cattle.
Piel anilina efecto batique.
Ganado escandinavo.

Piping finish
Acabado ribete



Steel finish
Acabado de acero



Certificates
Certificados

Fireproof polyurethane foam
Espuma de poliuretano ignífuga

UNE EN 1021:2006
BS 5852 part 2 crib 5
UNI 9175 Classe 1 IM
BKZ 5.2
California TB 117:2013
California TB 133*

*Contact our Customer Department
*Consultar con nuestro Departamento Comercial

Quality - Resistance
Calidad - Resistencia

UNE EN 16139:2013

Intellectual property Propiedad intelectual

All our collections are protected by international industrial design registries, designs patents, copyrights and intellectual Property laws. Unauthorized use of AW International Property is a criminal offence and can lead to prosecution.

Todas nuestras colecciones están protegidas por registros de diseño industrial, diseño de patente, copyright y derechos de propiedad intelectual en todo el mundo. El uso no autorizado de los diseños y propiedad intelectual de AW supone un delito que puede ser sometido a acción judicial.



BU2114

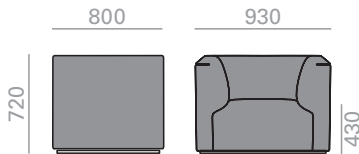

Lounge chair with upholstered seat and backrest and steel plinth base finished in polished chrome, white and black. Piping options are: coordinating with upholstery, white, black or sand color. Optional swivel base.

Butaca con asiento y respaldo tapizado y base de zócalo de acero en acabado cromo brillo, blanco o negro. Ribete perimetral disponible en tapicería al tono, o en color blanco, negro o arena. Opción de base giratoria.

	COM cm. per unit	COL m2
1 units	648	9,4
10 units or more	648	

0,66 m3
35,4 kg
x1

COM	COL	1	2	3	4	5	6	7	8	9	10	11	L1	L2	L3	L6
€ 1.565	1.630	1.712	1.777	1.828	1.917	2.004	2.092	2.180	2.268	2.355	2.444	2.531	2.610	2.926	3.537	5.200

Swivel base upcharge
Incremento por base giratoria | 311 |

SF2115

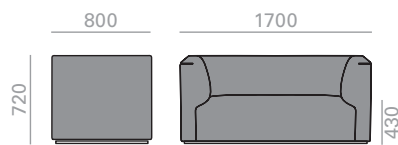

2-seater sofa with upholstered seat and backrest and steel plinth base finished in polished chrome, white and black. Piping options are: coordinating with upholstery, white, black or sand color.

Sofá de 2 plazas con asiento y respaldo tapizado y base de zócalo de acero en acabado cromo brillo, blanco o negro. Ribete perimetral disponible en tapicería al tono, o en color blanco, negro o arena.

	COM cm. per unit	COL m2
1 units	900	10,8
10 units or more	900	

1,06 m3
62,8 kg
x1

COM	COL	1	2	3	4	5	6	7	8	9	10	11	L1	L2	L3	L6
€ 2.049	2.138	2.250	2.339	2.409	2.528	2.648	2.768	2.889	3.025	3.165	3.301	3.441	3.565	4.065	4.978	7.587

USB charging system upcharge
Incremento por sistema de USB de carga | 195 |

SF2116

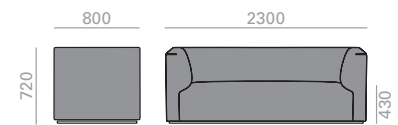

3-seater sofa with upholstered seat and backrest and steel plinth base finished in polished chrome, white and black. Piping options are: coordinating with upholstery, white, black or sand color.

Sofá de 3 plazas con asiento y respaldo tapizado y base de zócalo de acero en acabado cromo brillo, blanco o negro. Ribete perimetral disponible en tapicería al tono, o en color blanco, negro o arena.

	COM cm. per unit	COL m2
1 units	1026	14,7
10 units or more	1026	

1,57 m3
83,1 kg
x1

COM	COL	1	2	3	4	5	6	7	8	9	10	11	L1	L2	L3	L6
€ 2.332	2.434	2.559	2.660	2.739	2.874	3.010	3.146	3.288	3.447	3.607	3.765	3.923	4.066	4.640	5.686	8.636

USB charging system upcharge
Incremento por sistema de USB de carga | 195 |

CJ3010

Loose cushion
Cojin auxiliar

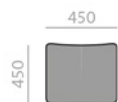

	COM cm. per unit	COL m2
1 units	65	1,5
10 units or more	650	

0,02 m3
2 kg
x1

COM	COL	1	2	3	4	5	6	7	8	9	10	11	L1	L2	L3	L6
€ 77	82	89	95	99	107	115	124	132	140	150	159	169	177	211	273	435

CJ3011

Loose cushion
Cojín auxiliar

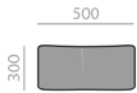

	COM cm. per unit	COL m2
1 units	45	1
10 units or more	450	

0,02 m3
 2 kg
 x1

€	COM	COL	1	2	3	4	5	6	7	8	9	10	11	L1	L2	L3	L6
	84	89	93	98	102	108	114	119	125	131	137	143	151	154	183	216	372

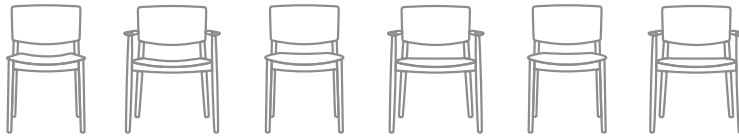

Description
Descripción

Stackable side chairs and armchairs with beech wood frame upholstered seat and back or oak wood board options available.
Sillas apilables y sillones con asiento y respaldo de tablero de roble o tablero tapizado y estructura y brazos de madera maciza de haya.

Upholstery
Tapicería

The Happy collection supports following upholsteries of Andreu World Catalogue. For fabrics in our catalogue not specified in this box or customers own materials please contact our Customer Service Department.
La colección Happy admite las siguientes tapicerías del catálogo de Andreu World. Para las telas de nuestro catálogo no indicadas en este cuadro o telas cliente, consultar con nuestro Departamento Comercial.

Fabrics / Telas

- 1** Soft-fiber
Jacquard One
Jacquard Three
Citadel
Sand
Era
Gravity
Rivet
Urban
Reel One (in/out)
Spin One
Spin Two
Spin Three
Spin Four
Spin Five
- 2** Jacquard Two
Solid & Stripes
Loom One
Circular One Pure Eco
Tack One (in/out)

- 3** Jacquard Four
Medley
Revive 1
Natte
Main Line Flax
Loom Two (in/out)
Mezzo
Reel two (in/out)
Jacquard Five
- 4** Jacquard 4 Special
Nexus
Field 2
Remix 3
Heritage
Savane
Loom Three
Loom Four
Cura
Oceanic
Reel Three (in/out)
Reel Four (in/out)
Reflect
Spin Six

- 5** Silk
Synergy
Step
Step Melange
Blazer
Melange Nap
Chili
Noma
Re-wool
- 6** Go check
Swing
Chartres
Zori
Patio
Tack Two (in/out)
Tack Three (in/out)
- 7** Canvas 2
Select
Clara 2
Tack Five (in/out)
Hero 2

- 8** Capture
Fiord 2
Tonus 4
Divina 3
Lopi
Domino
Atrium
- 9** Divina MD
Divina Melange 3
Hallingdal 65
Steelcut Trio 3
Tack Four (in/out)
- 11** Arda
Ecriture
Zero

Faux Leather / Ecopiel

- 1** Valencia
2 Silvertex
3 Maglia
4 Dolce
8 Ultraleather
9 Brisa
Brisa Distressed
Fresco
Ultraleather Pro
Promessa
- 10** Tottori
Coast (in/out)
- 11** Reef Pro
Volar Bio

Leather / Piel

- L1** High grade cow leather.
Piel de vaca de 1ª categoría.
- L3** Polished full grain leather.
Plena flor pulida.
- L6** Aniline leather batique-effect.
Scandinavian cattle.
Piel anilina efecto batique.
Ganado escandinavo.

Wood finish Beech
Acabado madera Haya



Premium finish and wood lacquers
Acabado premium y lacas madera



Certificates
Certificados

Fireproof polyurethane foam
Espuma de poliuretano ignifuga

UNE EN 1021:2006
BS 5852 part 2 crib 5
UNI 9175 Classe 1 IM
BKZ 5.2
California TB 117:2013
California TB 133*

*Contact our Customer Department
*Consultar con nuestro Departamento Comercial

Quality - Resistance
Calidad - Resistencia

UNE EN 16139:2013

Intellectual property Propiedad intelectual

All our collections are protected by international industrial design registries, designs patents, copyrights and intellectual Property laws. Unauthorized use of AW International Property is a criminal offence and can lead to prosecution.
Todas nuestras colecciones están protegidas por registros de diseño industrial, diseño de patente, copyright y derechos de propiedad intelectual todo el mundo. El uso no autorizado de los diseños y propiedad intelectual de AW supone un delito que puede ser sometido a acción judicial.



SI0376

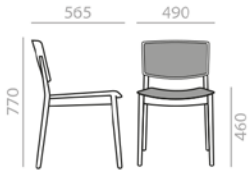

Stackable chair with upholstered seat and backrest and solid beech wood frame.
Silla apilable con asiento y respaldo tapizado y estructura de madera maciza de haya.

	COM cm. per unit	COL m2
1 units	65	1,5
10 units or more	50	

0,32 m3
18,2 kg
x2
4
8

€	COM	COL	1	2	3	4	5	6	7	8	9	10	11	L1	L2	L3	L6
	407	412	419	426	430	436	444	452	459	467	474	482	490	497	523	573	738

SERIE 600 | Matte lacquered and premium upcharge
Incremento por lacado mate y premium | 27 |

SO0379

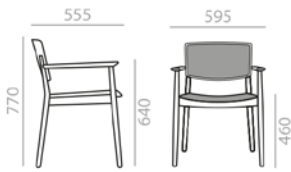

Armchair with upholstered seat and backrest and solid beech wood frame.
Sillón con asiento y respaldo tapizado y estructura de madera maciza de haya.

	COM cm. per unit	COL m2
1 units	65	1,5
10 units or more	50	

0,27 m3
11,1 kg
x1

€	COM	COL	1	2	3	4	5	6	7	8	9	10	11	L1	L2	L3	L6
	498	503	510	517	521	529	535	543	551	559	566	574	582	589	617	667	803

SERIE 600 | Matte lacquered and premium upcharge
Incremento por lacado mate y premium | 32 |

SI0377

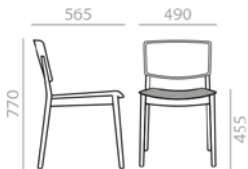

Stackable chair with upholstered seat, oak board backrest and solid beech wood frame.
Silla apilable con asiento tapizado, respaldo de tablero de roble y estructura de madera maciza de haya.

	COM cm. per unit	COL m2
1 units	65	1,5
10 units or more	33	

0,32 m3
17,6 kg
x2
4
8

€	COM	COL	1	2	3	4	5	6	7	8	9	10	11	L1	L2	L3	L6
	396	400	404	408	411	416	422	426	431	436	442	446	451	455	473	507	595

SERIE 600 | Matte lacquered and premium upcharge
Incremento por lacado mate y premium | 27 |

SO0378



Armchair with upholstered seat, oak board backrest and solid beech wood frame.
Sillón con asiento tapizado, respaldo de tablero de roble y estructura de madera maciza de haya.

	COM cm. per unit	COL m2
1 units	65	1,5
10 units or more	33	

0,27 m3
10,8 kg
x1

€	COM	COL	1	2	3	4	5	6	7	8	9	10	11	L1	L2	L3	L6
	484	488	492	496	500	504	509	515	520	524	530	535	540	544	563	597	686

SERIE 600 | Matte lacquered and premium upcharge
Incremento por lacado mate y premium | 32 |

SI0374

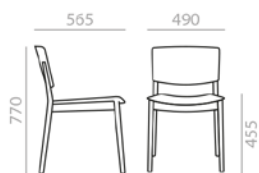

 Stackable chair with oak board seat and backrest and solid beech wood frame.

Silla apilable con asiento y respaldo de tablero de roble y estructura de madera maciza de haya.

 0,32 m3

 16 kg

 x2

 4

 8

€ 468

SERIE
600

Matte lacquered and premium upcharge
Incremento por lacado mate y premium

| 32 |

SO0375



 Armchair with oak board seat and backrest and solid beech wood frame.

Sillón con asiento y respaldo de tablero de roble y estructura de madera maciza de haya.

 0,27 m3

 10 kg

 x1

€ 561

SERIE
600

Matte lacquered and premium upcharge
Incremento por lacado mate y premium

| 35 |

For wooden legs. Para bases de madera.



Optional glides on page 482.

Opciones de tacos deslizantes en página 482.

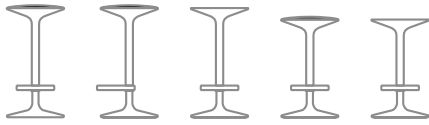

Description
Descripción

Barstools with upholstered seat, oak or walnut wood and injection swivel central base finished in different colors. Available a height adjustable version.
Banquetas con asiento tapizado, de madera de roble o nogal y base central giratoria de inyección de aluminio en diferentes colores. Disponible una versión regulable en altura.

Upholstery
Tapicería

The Hula collection supports following upholsteries of Andreu World Catalogue. For fabrics in our catalogue not specified in this box or customers own materials please contact our Customer Service Department.

La colección Hula admite las siguientes tapicerías del catálogo de Andreu World. Para las telas de nuestro catálogo no indicadas en este cuadro o telas cliente, consultar con nuestro Departamento Comercial.

Fabrics / Telas

- 1 Jacquard One
- Jacquard Three
- Citadel
- Sand
- Era
- Gravity
- Rivet
- Urban
- Reel One (in/out)
- Spin One
- Spin Two
- Spin Three
- Spin Four
- Spin Five
- 2 Jacquard Two
- Solid & Stripes
- Loom One
- Circular One Pure Eco
- Tack One (in/out)

- 3 Jacquard Four
- Medley
- Revive 1
- Natte
- Main Line Flax
- Loom Two (in/out)
- Mezzo
- Reel two (in/out)
- Jacquard Five

- 4 Jacquard 4 Special
- Nexus
- Field 2
- Remix 3
- Heritage
- Savane
- Loom Three
- Loom Four
- Cura
- Oceanic
- Reel Three (in/out)
- Reel Four (in/out)
- Reflect
- Spin Six

- 5 Silk
- Synergy
- Step
- Step Melange
- Blazer
- Melange Nap
- Chili
- Noma
- Re-wool

- 6 Go check
- Swing
- Chartres
- Zori
- Patio
- Tack Two (in/out)
- Tack Three (in/out)

- 7 Canvas 2
- Select
- Clara 2
- Tack Five (in/out)
- Hero 2

- 8 Capture
- Fiord 2
- Tonus 4
- Divina 3
- Lopi
- Domino
- Atrium

- 9 Divina MD
- Divina Melange 3
- Hallingdal 65
- Steelcut Trio 3
- Tack Four (in/out)

- 11 Arda
- Ecriture
- Zero

Faux Leather / Ecopiel

- 1 Valencia
- 2 Silvertex
- 3 Maglia
- 4 Dolce
- 8 Ultraleather
- 9 Brisa
- Brisa Distressed
- Fresco
- Ultraleather Pro
- Promessa

- 10 Tottori
- Coast (in/out)

- 11 Reef Pro
- Volar Bio

Leather / Piel

- L1 High grade cow leather.
Piel de vaca de 1ª categoría.
- L3 Polished full grain leather.
Plena flor pulida.
- L6 Aniline leather batique-effect.
Scandinavian cattle.
Piel anilina efecto batique.
Ganado escandinavo.

Wood finish Oak
Acabado madera
Roble



Premium finish and wood lacquers
Acabado premium y lacas madera



Wood finish Walnut
Acabado madera
Nogal

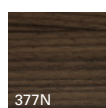

Aluminum finish
Acabado aluminio



Certificates
Certificados

Fireproof polyurethane foam

Espuma de poliuretano ignifuga

UNE EN 1021:2006
BS 5852 part 2 crib 5
UNI 9175 Classe 1 IM
BKZ 5.2
California TB 117:2013
California TB 133*

*Contact our Customer Department
*Consultar con nuestro Departamento Comercial

Quality - Resistance
Calidad - Resistencia

UNE EN 16139:2013

Intellectual property Propiedad intelectual

All our collections are protected by international industrial design registries, designs patents, copyrights and intellectual Property laws. Unauthorized use of AW International Property is a criminal offence and can lead to prosecution.
Todas nuestras colecciones están protegidas por registros de diseño industrial, diseño de patente, copyright y derechos de propiedad intelectual todo el mundo. El uso no autorizado de los diseños y propiedad intelectual de AW supone un delito que puede ser sometido a acción judicial.



BQ2795

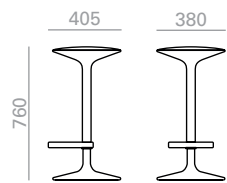

Hula 38. Barstool with upholstered seat, oak or walnut wood and injection swivel central base finished in different colors. In upholstered versions the seat height increases 20 mm.

Hula 38. Banqueta alta con asiento tapizado, de madera de roble o nogal y base central giratoria de inyección de aluminio disponible en diferentes colores. En versiones tapizadas la altura de asiento aumenta 20 mm.

COM cm. per unit	COL m2
------------------	--------

0,15 m3
10,6 kg
x1

Seat pad Asiento plafonado

1 units	50	1
10 units or more	25	

€



Oak
Roble

503



Walnut
Nogal

503

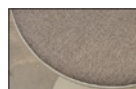

Upholstered seat
Asiento tapizado

COM	COL	1	2	3	4	5	6	7	8	9	10	11	L1	L2	L3	L6
429	432	433	436	437	440	443	447	466	468	471	479	487	495	523	580	721



Matte lacquered and premium upcharge
Incremento por lacado mate y premium

36

BQ2796

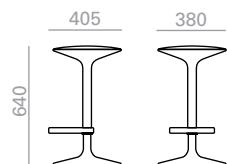

Hula 38. Counter stool with upholstered seat, oak or walnut wood and injection swivel central base finished in different colors. In upholstered versions the seat height increases 20 mm.

Hula 38. Banqueta baja con asiento tapizado, de madera de roble o nogal y base central giratoria de inyección de aluminio disponible en diferentes colores. En versiones tapizadas la altura de asiento aumenta 20 mm.

COM cm. per unit	COL m2
------------------	--------

0,13 m3
10,6 kg
x1

Seat pad Asiento plafonado

1 units	50	1
10 units or more	25	

€



Oak
Roble

503



Walnut
Nogal

503



Upholstered seat
Asiento tapizado

COM	COL	1	2	3	4	5	6	7	8	9	10	11	L1	L2	L3	L6
429	432	433	436	437	440	443	447	466	468	471	479	487	495	523	580	721



Matte lacquered and premium upcharge
Incremento por lacado mate y premium

36

BQ2797

Hula 38. Barstool with upholstered seat, oak or walnut wood and injection swivel central base, adjustable height, and finished in different colors.

Hula 38. Banqueta alta con asiento tapizado, de madera de roble o nogal y base central giratoria de inyección de aluminio, regulable en altura, disponible en diferentes colores.

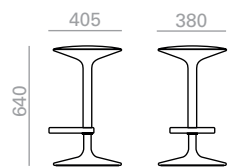

COM cm. per unit	COL m2
------------------	--------

0,13 m3
10,6 kg
x1

Seat pad Asiento plafonado

1 units	50	1
10 units or more	25	



COM	COL	1	2	3	4	5	6	7	8	9	10	11	L1	L2	L3	L6
429	432	433	436	437	440	447	455	475	477	480	489	497	505	533	592	735

SERIE 600
Matte lacquered and premium upcharge
Incremento por lacado mate y premium | 36 |

BQ2965

Hula 46. Barstool with upholstered shell and injection swivel central base finished in different colors.

Hula 46. Banqueta alta con carcasa tapizada y base central giratoria de inyección de aluminio disponible en diferentes colores.

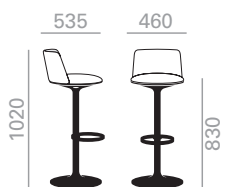

COM cm. per unit	COL m2
------------------	--------

0,29 m3
9,2 kg
x1

1 units	80	1,75
10 units or more	65	

€

COM	COL	1	2	3	4	5	6	7	8	9	10	11	L1	L2	L3	L6
470	475	482	487	493	499	506	514	520	528	535	543	550	556	581	629	753

BQ2966

Hula 46. Counter stool with upholstered shell and injection swivel central base finished in different colors.

Hula 46. Banqueta baja con carcasa tapizada y base central giratoria de inyección de aluminio disponible en diferentes colores.



COM cm. per unit	COL m2
------------------	--------

0,23 m3
9,2 kg
x1

1 units	80	1,75
10 units or more	65	

€

COM	COL	1	2	3	4	5	6	7	8	9	10	11	L1	L2	L3	L6
470	475	482	487	493	499	506	514	520	528	535	543	550	556	581	629	753

BQ2967

Hula 46. Barstool with upholstered shell and injection swivel central base, adjustable height and finished in different colors. Seat height range: 680-810 mm.

Hula 46. Banqueta alta con carcasa tapizada y base central giratoria de inyección de aluminio, regulable en altura y disponible en diferentes colores. Rango de altura de asiento: 680-810 mm.

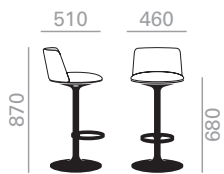

	COM cm. per unit	COL m2
1 units	80	1,75
10 units or more	65	

0,23 m3
9,2 kg
x1

€	COM	COL	1	2	3	4	5	6	7	8	9	10	11	L1	L2	L3	L6
	481	486	493	500	504	510	518	525	533	540	548	554	562	569	596	644	771

BQ2968

Hula 46. Barstool with upholstered shell and injection swivel central base finished in different colors.

Hula 46. Banqueta alta con carcasa tapizada y base central giratoria de inyección de aluminio disponible en diferentes colores.

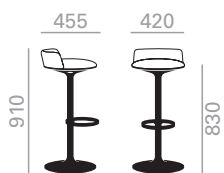

	COM cm. per unit	COL m2
1 units	70	0
10 units or more	55	

0,23 m3
9 kg
x1

€	COM	COL	1	2	3	4	5	6	7	8	9	10	11	L1	L2	L3	L6
	462	466	471	476	479	486	492	498	504	509	516	521	528	533	555	594	699

BQ2969

Hula 46. Counter stool with upholstered shell and injection swivel central base finished in different colors.

Hula 46. Banqueta baja con carcasa tapizada y base central giratoria de inyección de aluminio disponible en diferentes colores.

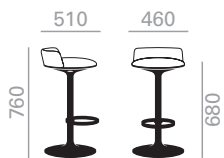

	COM cm. per unit	COL m2
1 units	70	1,25
10 units or more	55	

0,17 m3
9 kg
x1

€	COM	COL	1	2	3	4	5	6	7	8	9	10	11	L1	L2	L3	L6
	462	466	471	476	479	486	492	498	504	509	516	521	528	533	555	594	699

BQ2970

Hula 46. Barstool with upholstered shell and injection swivel central base, adjustable height and finished in different colors. Seat height range: 680-810 mm.

Hula 46. Banqueta alta con carcasa tapizada y base central giratoria de inyección de aluminio, regulable en altura y disponible en diferentes colores. Rango de altura de asiento: 680-810 mm.

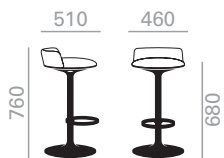

	COM cm. per unit	COL m2
1 units	70	1,25
10 units or more	55	

0,17 m3
9 kg
x1

€	COM	COL	1	2	3	4	5	6	7	8	9	10	11	L1	L2	L3	L6
	478	482	487	492	496	502	508	515	520	527	534	539	546	551	574	614	722

BQ2971

Hula 46. Barstool with upholstered seat or oak wood and injection swivel central base finished in different colors. In upholstered versions the seat height increases 20 mm.

Hula 46. Banqueta alta con asiento tapizado o de madera de roble y base central giratoria de inyección de aluminio disponible en diferentes colores. En versiones tapizadas la altura de asiento aumenta 20 mm.

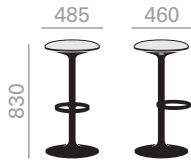

COM cm. per unit	COL m2
------------------	--------

0,22 m3
8,7 kg
x1

Seat pad Asiento plafonado		
1 units	70	0,8
10 units or more	35	



COM	COL	1	2	3	4	5	6	7	8	9	10	11	L1	L2	L3	L6
475	478	481	485	486	491	495	499	503	507	511	515	519	522	540	577	668

SERIE 600	Matte lacquered and premium upcharge Incremento por lacado mate y premium	36
-----------	--	----

BQ2972

Hula 46. Counter stool with upholstered seat or oak wood and injection swivel central base finished in different colors. In upholstered versions the seat height increases 20 mm.

Hula 46. Banqueta baja con asiento tapizado o de madera de roble y base central giratoria de inyección de aluminio disponible en diferentes colores. En versiones tapizadas la altura de asiento aumenta 20 mm.

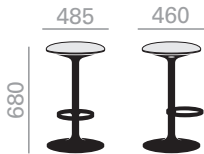

COM cm. per unit	COL m2
------------------	--------

0,14 m3
8,7 kg
x1

Seat pad Asiento plafonado		
1 units	70	0,8
10 units or more	35	



COM	COL	1	2	3	4	5	6	7	8	9	10	11	L1	L2	L3	L6
475	478	481	485	486	491	495	499	503	507	511	515	519	522	540	577	668

SERIE 600	Matte lacquered and premium upcharge Incremento por lacado mate y premium	36
-----------	--	----

BQ2973

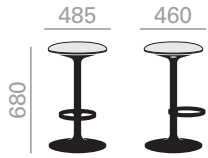

Hula 46. Barstool with upholstered seat or oak wood and injection swivel central base, adjustable height, and finished in different colors. Seat height range: 26.75-32 inches. In upholstered versions the seat height increases 0.75 inches.

Hula 46. Banqueta alta con asiento tapizado o de madera de roble y base central giratoria de inyección de aluminio, regulable en altura, disponible en diferentes colores. Rango de altura de asiento: 680-810 mm. En versiones tapizadas la altura de asiento aumenta 20 mm.

COM cm. per unit	COL m2
------------------	--------

0,14 m3
8,7 kg
x1

Seat pad Asiento plafonado

1 units	70	0,8
10 units or more	35	



563

€
Oak
Roble



Upholstered seat
Asiento tapizado

COM	COL	1	2	3	4	5	6	7	8	9	10	11	L1	L2	L3	L6
464	466	471	478	482	487	494	500	504	509	515	520	526	529	551	589	681

SERIE
600

Matte lacquered and premium upcharge
Incremento por lacado mate y premium

36

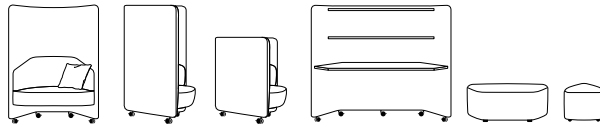

Description

Descripción

2 and 3 seater armchairs and sofas with upholstered panel and base on wheels in black finish. Available in 2 upholstered panel heights. Available options: fixed or cushioned upholstered backrest, USB charging system in the seat and 4-leg aluminum base in polished aluminum, white or black finish. Table version for 1 and 2 seats with upholstered panel, base on wheels in black finish and melamine top with the option of oak or lacquered finish. Available in 2 upholstered panel heights. Available options: low and/or high shelf depending on the versions in melamine, oak and lacquered finishes and different connectivity systems on the table top. Upholstered footrest version with wheels and 4-leg base option in black finish, available in 3 sizes.

Butacas y sofás de 2 y 3 plazas con panel tapizado y base de ruedas en acabado negro. Disponible en 2 alturas de panel tapizado. Opciones disponibles: respaldo tapizado fijo o de cojines, sistema de USB de carga en asiento y base de 4 patas de aluminio en acabado aluminio pulido, blanco o negro. Versión de mesa de 1 y 2 plazas con panel tapizado, base de ruedas en acabado negro y sobre de melamina con opción de acabado roble o lacado. Disponible en 2 alturas de panel tapizado. Opciones disponibles: estante bajo y/o alto según versiones en acabado melamina, roble y lacado y diferentes sistemas de conectividad en el sobre de mesa. Versión de reposapiés tapizado con ruedas y opción de base de 4 patas en acabado negro, disponible en 3 tamaños. Versión de butaca con panel tapizado y protección inferior de ecopiel al tono de la tapicería, tablero de escritura disponible en diferentes acabados y base de ruedas en acabado negro. Disponible en 2 alturas. Opción de cojín lumbar.

Upholstery

Tapicería

The In Out Office collection supports following upholsteries of Andreu World Catalogue. For fabrics in our catalogue not specified in this box or customers own materials please contact our Customer Service Department.

La colección In Out Office admite las siguientes tapicerías del catálogo de Andreu World. Para las telas de nuestro catálogo no indicadas en este cuadro o telas cliente, consultar con nuestro Departamento Comercial.

Fabrics / Telas

- 1 Soft-fiber
- Jacquard One
- Jacquard Three
- Citadel
- Sand
- Era
- Gravity
- Rivet
- Urban
- Reel One (in/out)
- Spin One
- Spin Two
- Spin Three
- Spin Four
- Spin Five
- 2 Jacquard Two
- Solid & Stripes
- Loom One
- Circular One Pure Eco
- Tack One (in/out)

- 3 Jacquard Four
- Medley
- Revive 1
- Natte
- Main Line Flax
- Loom Two (in/out)
- Mezzo
- Reel two (in/out)
- Jacquard Five

- 4 Jacquard 4 Special
- Nexus
- Field 2
- Remix 3
- Heritage
- Savane
- Loom Three
- Loom Four
- Cura
- Oceanic
- Reel Three (in/out)
- Reel Four (in/out)
- Reflect
- Spin Six

- 5 Silk
- Synergy
- Step
- Step Melange
- Blazer
- Melange Nap
- Chili
- Noma
- Re-wool

- 6 Go check
- Swing
- Chartres
- Zori
- Patio
- Tack Two (in/out)
- Tack Three (in/out)

- 7 Canvas 2
- Select
- Clara 2
- Tack Five (in/out)
- Hero 2

- 8 Capture
- Fiord 2
- Tonus 4
- Divina 3
- Lopi
- Domino
- Atrium
- 9 Divina MD
- Divina Melange 3
- Hallingdal 65
- Steelcut Trio 3
- Tack Four (in/out)

- 11 Arda
- Ecriture
- Zero

Faux Leather / Ecopiel

- 1 Valencia
- 2 Silvertex
- 3 Maglia
- 4 Dolce
- 8 Ultraleather
- 9 Brisa
- Brisa Distressed
- Fresco
- Ultraleather Pro
- Promessa
- 10 Tottori
- Coast (in/out)
- 11 Reef Pro
- Volar Bio

Leather / Piel

- L1 High grade cow leather.
- Piel de vaca de 1ª categoría.
- L3 Polished full grain leather.
- Plena flor pulida.
- L6 Aniline leather batique-effect.
- Scandinavian cattle.
- Piel anilina efecto batique.
- Ganado escandinavo.

Wood finish Oak

Acabado madera Roble



Premium finish and wood lacquers

Acabado premium y lacas madera



Melamine finish

Acabado melamina

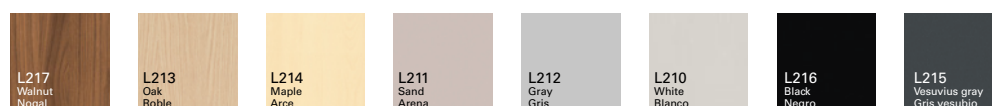

Aluminum finish

Acabado aluminio



Certificates

Certificados

Fireproof polyurethane foam

Espuma de poliuretano ignifuga

UNE EN 1021:2006
BS 5852 part 2 crib 5
UNI 9175 Classe 1 IM
BKZ 5.2
California TB 117:2013
California TB 133*

*Contact our Customer Department
*Consultar con nuestro Departamento Comercial

Quality - Resistance
Calidad - Resistencia

UNE EN 16139:2013

Intellectual property Propiedad intelectual

All our collections are protected by international industrial design registries, designs patents, copyrights and intellectual Property laws. Unauthorized use of AW International Property is a criminal offence and can lead to prosecution.

Todas nuestras colecciones están protegidas por registros de diseño industrial, diseño de patente, copyright y derechos de propiedad intelectual todo el mundo. El uso no autorizado de los diseños y propiedad intelectual de AW supone un delito que puede ser sometido a acción judicial.



BU2250

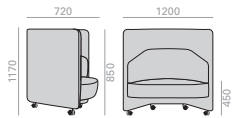

Low-back lounge chair with upholstered panel and base on wheels in a black or white finish. Available options: fixed or cushioned upholstered backrest, USB charging system in the seat and 4-leg aluminum base in polished aluminum, white or black finish.

Butaca de panel bajo tapizado y base de ruedas en acabado negro o blanco. Opciones disponibles: respaldo tapizado fijo o de cojines, sistema de USB de carga en asiento y base de 4 patas de aluminio en acabado aluminio pulido, blanco o negro.

COM cm. per unit	COL m2
------------------	--------

1,59 m3
 42 kg
 x1

Backless module Módulo sin respaldo

1 units	555	11,25
10 units or more	555	

Module with cushions Módulo con cojines

1 units	615	13,5
10 units or more	615	

Module with fixed backrest Módulo con respaldo fijo

1 units	705	14
10 units or more	705	



Backless module
Módulo sin respaldo

COM	COL	1	2	3	4	5	6	7	8	9	10	11	L1	L2	L3	L6
1.782	1.836	1.901	1.955	1.996	2.067	2.139	2.209	2.281	2.352	2.422	2.494	2.566	2.628	2.885	3.354	4.594



Module with cushions
Módulo con cojines

COM	COL	1	2	3	4	5	6	7	8	9	10	11	L1	L2	L3	L6
1.841	1.910	1.985	2.098	2.186	2.336	2.489	2.638	2.790	2.940	3.091	3.243	3.394	3.527	4.072	5.067	7.697



Module with fixed backrest
Módulo con respaldo fijo

COM	COL	1	2	3	4	5	6	7	8	9	10	11	L1	L2	L3	L6
1.848	1.970	2.117	2.237	2.331	2.492	2.652	2.812	2.974	3.134	3.294	3.456	3.616	3.759	4.338	5.397	8.194



USB charging system upcharge
Incremento por sistema de USB de carga

195



Optional 4-legs base
Opción base de 4 patas

BU2251

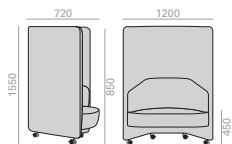

High-back lounge chair with upholstered panel and base on wheels in a black or white finish. Available options: fixed or cushioned upholstered backrest, USB charging system in the seat and 4-leg aluminum base in polished aluminum, white or black finish.

Butaca de panel alto tapizado y base de ruedas en acabado negro o blanco. Opciones disponibles: respaldo tapizado fijo o de cojines, sistema de USB de carga en asiento y base de 4 patas de aluminio en acabado aluminio pulido, blanco o negro.

COM cm. per unit	COL m2
------------------	--------

2,14 m3
 42 kg
 x1

Backless module Módulo sin respaldo

1 units	715	14,25
10 units or more	715	

Module with cushions Módulo con cojines

1 units	775	13,5
10 units or more	775	

Module with fixed backrest Módulo con respaldo fijo

1 units	865	17,25
10 units or more	865	



Backless module
Módulo sin respaldo

COM	COL	1	2	3	4	5	6	7	8	9	10	11	L1	L2	L3	L6
1.882	1.951	2.036	2.104	2.157	2.249	2.340	2.433	2.524	2.615	2.707	2.799	2.891	2.972	3.303	3.906	5.503



Module with cushions
Módulo con cojines

COM	COL	1	2	3	4	5	6	7	8	9	10	11	L1	L2	L3	L6
1.941	2.025	2.120	2.263	2.373	2.565	2.756	2.949	3.140	3.331	3.523	3.717	3.909	4.078	4.771	6.032	9.372



Module with fixed backrest
Módulo con respaldo fijo

COM	COL	1	2	3	4	5	6	7	8	9	10	11	L1	L2	L3	L6
1.948	2.085	2.252	2.401	2.519	2.721	2.921	3.124	3.325	3.525	3.728	3.928	4.131	4.310	5.037	6.363	9.872



USB charging system upcharge
Incremento por sistema de USB de carga

195



Optional 4-legs base
Opción base de 4 patas

SF2252

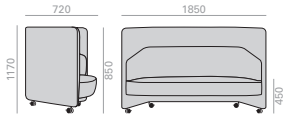

Low-back 2-seater sofa with upholstered panel and caster base in black or white finish. Available options: fixed or cushioned upholstered backrest, USB charging system in the seat and 4-leg aluminum base in polished aluminum, white or black finish.

Sofá de 2 plazas de panel bajo tapizado y base de ruedas en acabado negro o blanco. Opciones disponibles: respaldo tapizado fijo o de cojines, sistema de USB de carga en asiento y base de 4 patas de aluminio en acabado aluminio pulido, blanco o negro.

COM cm. per unit	COL m2
------------------	--------

2,24 m3
59 kg
x1

Backless module Módulo sin respaldo

1 units	640	12,75
10 units or more	640	

Module with cushions Módulo con cojines

1 units	760	27
10 units or more	760	

Module with fixed backrest Módulo con respaldo fijo

1 units	820	16'5
10 units or more	820	



Backless module
Módulo sin respaldo

COM	COL	1	2	3	4	5	6	7	8	9	10	11	L1	L2	L3	L6
2.312	2.375	2.454	2.517	2.566	2.651	2.735	2.820	2.905	2.989	3.074	3.158	3.243	3.318	3.623	4.180	5.654



Module with cushions
Módulo con cojines

COM	COL	1	2	3	4	5	6	7	8	9	10	11	L1	L2	L3	L6
2.389	2.529	2.631	2.772	2.881	3.071	3.260	3.449	3.639	3.827	4.017	4.206	4.395	4.564	5.246	6.492	9.789



Module with fixed backrest
Módulo con respaldo fijo

COM	COL	1	2	3	4	5	6	7	8	9	10	11	L1	L2	L3	L6
2.389	2.513	2.611	2.755	2.868	3.062	3.255	3.451	3.645	3.838	4.032	4.226	4.420	4.592	5.292	6.569	9.948



USB charging system upcharge
Incremento por sistema de USB de carga

195



Optional 4-legs base
Opción base de 4 patas

SF2253

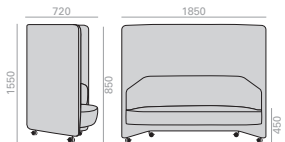

2-seater high-back sofa with upholstered panel and caster base in black or white finish. Available options: fixed or cushioned upholstered backrest, USB charging system in the seat and 4-leg aluminum base in polished aluminum, white or black finish.

Sofá de 2 plazas de panel alto tapizado y base de ruedas en acabado negro o blanco. Opciones disponibles: respaldo tapizado fijo o de cojines, sistema de USB de carga en asiento y base de 4 patas de aluminio en acabado aluminio pulido, blanco o negro.

COM cm. per unit	COL m2
------------------	--------

3 m3
66 kg
x1

Backless module Módulo sin respaldo

1 units	800	16
10 units or more	800	

Module with cushions Módulo con cojines

1 units	920	27
10 units or more	920	

Module with fixed backrest Módulo con respaldo fijo

1 units	980	19'5
10 units or more	980	



Backless module
Módulo sin respaldo

COM	COL	1	2	3	4	5	6	7	8	9	10	11	L1	L2	L3	L6
2.455	2.534	2.632	2.711	2.772	2.878	2.985	3.089	3.195	3.302	3.408	3.512	3.618	3.712	4.094	4.791	6.632



Module with cushions
Módulo con cojines

COM	COL	1	2	3	4	5	6	7	8	9	10	11	L1	L2	L3	L6
2.532	2.688	2.809	2.982	3.115	3.347	3.580	3.811	4.041	4.274	4.506	4.737	4.969	5.174	6.011	7.536	11.569



Module with fixed backrest
Módulo con respaldo fijo

COM	COL	1	2	3	4	5	6	7	8	9	10	11	L1	L2	L3	L6
2.557	2.715	2.837	3.012	3.146	3.380	3.616	3.849	4.047	4.285	4.522	4.757	4.993	5.204	6.059	7.616	11.734



USB charging system upcharge
Incremento por sistema de USB de carga

195



Optional 4-legs base
Opción base de 4 patas

SF2254

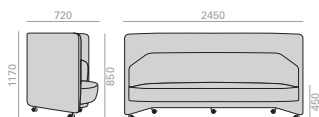

Low-back 3-seater sofa with upholstered panel and caster base in black or white finish. Available options: fixed or cushioned upholstered backrest, USB charging system in the seat and 4-leg aluminum base in polished aluminum, white or black finish.

Sofá de 3 plazas de panel bajo tapizado y base de ruedas en acabado negro o blanco. Opciones disponibles: respaldo tapizado fijo o de cojines, sistema de USB de carga en asiento y base de 4 patas de aluminio en acabado aluminio pulido, blanco o negro.

COM cm. per unit	COL m2
------------------	--------

3,07 m3
78 kg
x1

Backless module Módulo sin respaldo

1 units	980	19,5
10 units or more	980	

Module with cushions Módulo con cojines

1 units	1160	40,5
10 units or more	1160	

Module with fixed backrest Módulo con respaldo fijo

1 units	1280	25'5
10 units or more	1280	



Backless module
Módulo sin respaldo

COM	COL	1	2	3	4	5	6	7	8	9	10	11	L1	L2	L3	L6
-----	-----	---	---	---	---	---	---	---	---	---	----	----	----	----	----	----

2.838	2.935	3.055	3.151	3.228	3.357	3.486	3.615	3.745	3.875	4.005	4.134	4.263	4.378	4.846	5.700	7.955
-------	-------	-------	-------	-------	-------	-------	-------	-------	-------	-------	-------	-------	-------	-------	-------	-------



Module with cushions
Módulo con cojines

COM	COL	1	2	3	4	5	6	7	8	9	10	11	L1	L2	L3	L6
-----	-----	---	---	---	---	---	---	---	---	---	----	----	----	----	----	----

2.946	3.135	3.321	3.536	3.705	3.994	4.283	4.570	4.860	5.150	5.440	5.728	6.017	6.273	7.318	9.223	14.257
-------	-------	-------	-------	-------	-------	-------	-------	-------	-------	-------	-------	-------	-------	-------	-------	--------



Module with fixed backrest
Módulo con respaldo fijo

COM	COL	1	2	3	4	5	6	7	8	9	10	11	L1	L2	L3	L6
-----	-----	---	---	---	---	---	---	---	---	---	----	----	----	----	----	----

2.930	3.104	3.230	3.453	3.628	3.926	4.224	4.524	4.823	5.123	5.422	5.722	6.020	6.286	7.366	9.337	14.546
-------	-------	-------	-------	-------	-------	-------	-------	-------	-------	-------	-------	-------	-------	-------	-------	--------



USB charging system upcharge
Incremento por sistema de USB de carga

195



Optional 4-legs base
Opción base de 4 patas

SF2255

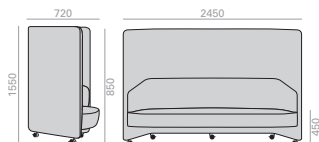

3-seater high-back sofa with upholstered panel and caster base in black or white finish. Available options: fixed or cushioned upholstered backrest, USB charging system in the seat and 4-leg aluminum base in polished aluminum, white or black finish.

Sofá de 3 plazas de panel alto tapizado y base de ruedas en acabado negro o blanco. Opciones disponibles: respaldo tapizado fijo o de cojines, sistema de USB de carga en asiento y base de 4 patas de aluminio en acabado aluminio pulido, blanco o negro.

COM cm. per unit	COL m2
------------------	--------

3,94 m3
94 kg
x1

Backless module Módulo sin respaldo

1 units	1220	24,25
10 units or more	1220	

Module with cushions Módulo con cojines

1 units	1400	40,5
10 units or more	1400	

Module with fixed backrest Módulo con respaldo fijo

1 units	1520	30'25
10 units or more	1520	



Backless module
Módulo sin respaldo

COM	COL	1	2	3	4	5	6	7	8	9	10	11	L1	L2	L3	L6
-----	-----	---	---	---	---	---	---	---	---	---	----	----	----	----	----	----

3.012	3.134	3.283	3.403	3.497	3.658	3.818	3.980	4.142	4.303	4.465	4.625	4.786	4.929	5.512	6.574	9.382
-------	-------	-------	-------	-------	-------	-------	-------	-------	-------	-------	-------	-------	-------	-------	-------	-------



Module with cushions
Módulo con cojines

COM	COL	1	2	3	4	5	6	7	8	9	10	11	L1	L2	L3	L6
-----	-----	---	---	---	---	---	---	---	---	---	----	----	----	----	----	----

3.120	3.365	3.551	3.812	4.019	4.373	4.726	5.080	5.434	5.788	6.142	6.494	6.848	7.163	8.440	10.769	16.930
-------	-------	-------	-------	-------	-------	-------	-------	-------	-------	-------	-------	-------	-------	-------	--------	--------



Module with fixed backrest
Módulo con respaldo fijo

COM	COL	1	2	3	4	5	6	7	8	9	10	11	L1	L2	L3	L6
-----	-----	---	---	---	---	---	---	---	---	---	----	----	----	----	----	----

3.120	3.303	3.458	3.728	3.939	4.301	4.663	5.026	5.390	5.752	6.116	6.477	6.840	7.161	8.472	10.860	17.176
-------	-------	-------	-------	-------	-------	-------	-------	-------	-------	-------	-------	-------	-------	-------	--------	--------



USB charging system upcharge
Incremento por sistema de USB de carga

195



Optional 4-legs base
Opción base de 4 patas

BU2265

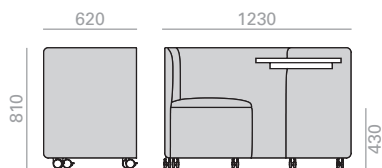

Upholstered low panel lounge chair with eco leather lower protection in the same tone as the upholstery, writing surface, left side, available in several finishes and wheel base in black finish. Lumbar cushion option.

Butaca de panel bajo tapizado con protección inferior de ecopiel al tono de la tapicería, tablero de escritura, lado izquierdo, disponible en diferentes acabados y base de ruedas en acabado negro. Opción de cojín lumbar.

	COM cm. per unit	COL m2
1 units	400	8
10 units or more	400	

0,72 m3
39 kg
x1

Loose cushion Cojín auxiliar

1 units	50	1
10 units or more	50	

COM	COL	1	2	3	4	5	6	7	8	9	10	11	L1	L2	L3	L6
1.604	1.643	1.691	1.730	1.760	1.812	1.864	1.915	1.967	2.019	2.072	2.122	2.175	2.221	2.407	2.749	3.652



Loose cushion
Cojín auxiliar

COM	COL	1	2	3	4	5	6	7	8	9	10	11	L1	L2	L3	L6
1.690	1.734	1.786	1.830	1.865	1.924	1.982	2.040	2.099	2.157	2.217	2.273	2.333	2.386	2.595	2.980	3.998

BU2266

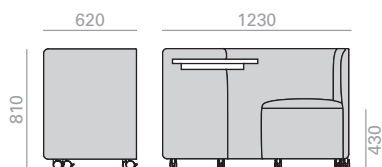

Upholstered low panel lounge chair with eco leather lower protection in the same tone as the upholstery, writing surface, right side, available in several finishes and wheel base in black finish. Lumbar cushion option.

Butaca de panel bajo tapizado con protección inferior de ecopiel al tono de la tapicería, tablero de escritura, lado derecho, disponible en diferentes acabados y base de ruedas en acabado negro. Opción de cojín lumbar.

	COM cm. per unit	COL m2
1 units	400	8
10 units or more	400	

0,72 m3
39 kg
x1

Loose cushion Cojín auxiliar

1 units	50	1
10 units or more	50	

COM	COL	1	2	3	4	5	6	7	8	9	10	11	L1	L2	L3	L6
1.604	1.643	1.691	1.730	1.760	1.812	1.864	1.915	1.967	2.019	2.072	2.122	2.175	2.221	2.407	2.749	3.652



Loose cushion
Cojín auxiliar

COM	COL	1	2	3	4	5	6	7	8	9	10	11	L1	L2	L3	L6
1.690	1.734	1.786	1.830	1.865	1.924	1.982	2.040	2.099	2.157	2.217	2.273	2.333	2.386	2.595	2.980	3.998

BU2267

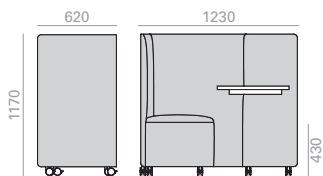

Upholstered high panel lounge chair with eco leather lower protection in the same tone as the upholstery, writing surface, left side, available in several finishes and wheel base in black finish. Lumbar cushion option.

Butaca de panel alto tapizado con protección inferior de ecopiel al tono de la tapicería, tablero de escritura, lado izquierdo, disponible en diferentes acabados y base de ruedas en acabado negro. Opción de cojín lumbar.

	COM cm. per unit	COL m2
1 units	600	8
10 units or more	600	

1,03 m3
43 kg
x1

Loose cushion Cojín auxiliar

	COM cm. per unit	COL m2
1 units	50	1
10 units or more	50	

COM	COL	1	2	3	4	5	6	7	8	9	10	11	L1	L2	L3	L6
1.767	1.825	1.897	1.955	2.000	2.079	2.157	2.234	2.312	2.390	2.467	2.545	2.622	2.691	2.973	3.485	4.839



Loose cushion
Cojín auxiliar

COM	COL	1	2	3	4	5	6	7	8	9	10	11	L1	L2	L3	L6
1.853	1.916	1.992	2.055	2.105	2.191	2.275	2.359	2.444	2.528	2.612	2.696	2.780	2.856	3.161	3.716	5.185

BU2268

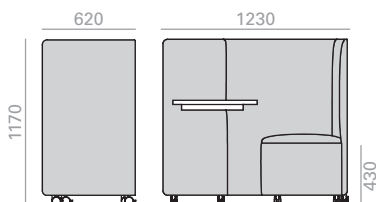

Upholstered low panel lounge chair with eco leather lower protection in the same tone as the upholstery, writing surface, right side, available in several finishes and wheel base in black finish. Lumbar cushion option.

Butaca de panel alto tapizado con protección inferior de ecopiel al tono de la tapicería, tablero de escritura, lado derecho, disponible en diferentes acabados y base de ruedas en acabado negro. Opción de cojín lumbar.

	COM cm. per unit	COL m2
1 units	600	8
10 units or more	600	

1,03 m3
43 kg
x1

Loose cushion Cojín auxiliar

	COM cm. per unit	COL m2
1 units	50	1
10 units or more	50	

COM	COL	1	2	3	4	5	6	7	8	9	10	11	L1	L2	L3	L6
1.767	1.825	1.897	1.955	2.000	2.079	2.157	2.234	2.312	2.390	2.467	2.545	2.622	2.691	2.973	3.485	4.839

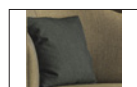

Loose cushion
Cojín auxiliar

COM	COL	1	2	3	4	5	6	7	8	9	10	11	L1	L2	L3	L6
1.853	1.916	1.992	2.055	2.105	2.191	2.275	2.359	2.444	2.528	2.612	2.696	2.780	2.856	3.161	3.716	5.185

RS2262

Upholstered footrest with wheels. 4-legged base option in black finish.

Reposapiés tapizado con ruedas. Opción de base de 4 patas en acabado negro.

	COM cm. per unit	COL m2
1 units	110	2,25
10 units or more	110	

0,15 m3
 9,3 kg
 x1

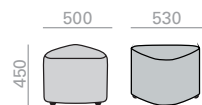

€	COM	COL	1	2	3	4	5	6	7	8	9	10	11	L1	L2	L3	L6
	725	736	748	758	766	779	793	807	821	834	848	861	875	887	934	1.024	1.258



Optional 4-legs base
Opción base de 4 patas

RS2264

Upholstered footrest with wheels. 4-legged base option in black finish.

Reposapiés tapizado con ruedas. Opción de base de 4 patas en acabado negro.

	COM cm. per unit	COL m2
1 units	155	3,25
10 units or more	155	

0,2 m3
 11,3 kg
 x1

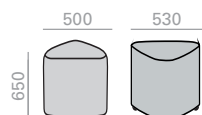

€	COM	COL	1	2	3	4	5	6	7	8	9	10	11	L1	L2	L3	L6
	842	857	875	891	901	922	942	961	982	1.001	1.021	1.042	1.061	1.079	1.151	1.281	1.627



Optional 4-legs base
Opción base de 4 patas

RS2263

Upholstered footrest with wheels. 4-legged base option in black finish.

Reposapiés tapizado con ruedas. Opción de base de 4 patas en acabado negro.

	COM cm. per unit	COL m2
1 units	260	5,25
10 units or more	260	

0,3 m3
 12,4 kg
 x1

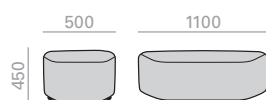

€	COM	COL	1	2	3	4	5	6	7	8	9	10	11	L1	L2	L3	L6
	779	790	801	812	819	833	846	860	873	887	900	913	927	939	988	1.076	1.310



Optional 4-legs base
Opción base de 4 patas

ME2258

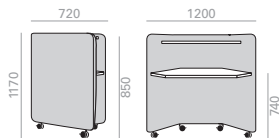

Low-back 2-seater table with upholstered panel, melamine top and base on wheels in black or white finish. Available options: low shelf in melamine, oak and lacquered finishes, 4-legged aluminum base in polished aluminum, white or black finishes and connectivity systems.

Mesa de respaldo bajo con panel tapizado, sobre de melamina y base de ruedas en acabado negro o blanco. Opciones disponibles: estante bajo en acabado melamina, roble y lacado, base de 4 patas de aluminio en acabado aluminio pulido, blanco o negro y sistemas de conectividad.

	COM cm. per unit	COL m2
1 units	555	11,25
10 units or more	555	

1,54 m3
42 kg
x1

COM	COL	1	2	3	4	5	6	7	8	9	10	11	L1	L2	L3	L6
€ 2.069	2.135	2.216	2.281	2.332	2.419	2.506	2.594	2.681	2.768	2.855	2.942	3.029	3.108	3.423	3.997	5.518



Optional 4-legs base
Opción base de 4 patas



Lacquered top upcharge
Incremento sobre lacado

| 86



Oak top upcharge
Incremento sobre roble

| 323



Melamine shelf upcharge (1 unit)
Incremento estante melamina (1 ud.)

| 209



Lacquered shelf upcharge (1 unit)
Incremento estante lacado (1 ud.)

| 279



Oak shelf upcharge (1 unit)
Incremento estante roble (1 ud.)

| 324

PS-IN SURFACE			PS-UNDER TOP		
	Grommet Tülle			PS0804 USB	
				PS0735 Power box	
€		€	€		€
123		177	750		518
					250

ME2259

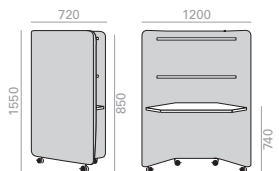

High back table with upholstered panel, melamine top and base on wheels in black or white finish. Available options: low and/or high shelf in melamine, oak and lacquered finishes, 4-legged aluminum base in polished aluminum, white or black finishes and connectivity systems.

Mesa de respaldo alto con panel tapizado, sobre de melamina y base de ruedas en acabado negro o blanco. Opciones disponibles: estante bajo y/o alto en acabado melamina, roble y lacado, base de 4 patas de aluminio en acabado aluminio pulido, blanco o negro y sistemas de conectividad.

	COM cm. per unit	COL m2
1 units	715	14,25
10 units or more	715	

2,06 m3
42 kg
x1

COM	COL	1	2	3	4	5	6	7	8	9	10	11	L1	L2	L3	L6
€ 1.960	2.008	2.068	2.116	2.155	2.219	2.285	2.365	2.444	2.524	2.603	2.682	2.762	2.834	3.121	3.644	5.031



Optional 4-legs base
Opción base de 4 patas



Lacquered top upcharge
Incremento sobre lacado

| 84



Oak top upcharge
Incremento sobre roble

| 321



Melamine shelf upcharge (1 unit)
Incremento estante melamina (1 ud.)

| 204



Lacquered shelf upcharge (1 unit)
Incremento estante lacado (1 ud.)

| 276



Oak shelf upcharge (1 unit)
Incremento estante roble (1 ud.)

| 321

PS-IN SURFACE			PS-UNDER TOP		
	Grommet Tülle			PS0804 USB	
				PS0735 Power box	
€		€	€		€
123		177	750		518
					250

ME2260

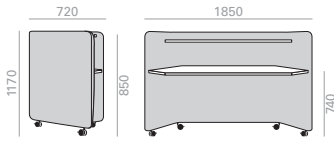

Low-back 2-seater table with upholstered panel, melamine top and base on wheels in black or white finish. Available options: low shelf in melamine, oak and lacquered finishes, 4-legged aluminum base in polished aluminum, white or black finishes and connectivity systems.

Mesa de 2 plazas de respaldo bajo con panel tapizado, sobre de melamina y base de ruedas en acabado negro o blanco. Opciones disponibles: estante bajo en acabado melamina, roble y lacado, base de 4 patas de aluminio en acabado aluminio pulido, blanco o negro y sistemas de conectividad.

	COM cm. per unit	COL m2
1 units	640	12,75
10 units or more	640	

2,34 m3
 64 kg
 x1

COM	COL	1	2	3	4	5	6	7	8	9	10	11	L1	L2	L3	L6
€ 2.348	2.413	2.494	2.560	2.610	2.697	2.784	2.873	2.960	3.047	3.134	3.221	3.308	3.385	3.702	4.276	5.795



Optional 4-legs base
Opción base de 4 patas



Lacquered top upcharge
Incremento sobre lacado | 167



Oak top upcharge
Incremento sobre roble | 704



Melamine shelf upcharge (1 unit)
Incremento estante melamina (1 ud.) | 287



Lacquered shelf upcharge (1 unit)
Incremento estante lacado (1 ud.) | 489



Oak shelf upcharge (1 unit)
Incremento estante roble (1 ud.) | 288

PS-IN SURFACE			PS-UNDER TOP		
	Grommet Tülle		PS0804 USB		PS0735 Power box
€	123	€	177	€	750
					PS0787 Power box Steckerbox
				€	518
					Cable organizer Kabelorganisor
				€	250

ME2261

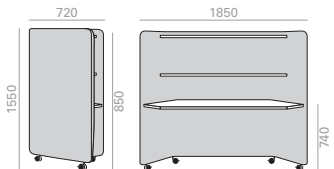

2-seater high-back table with upholstered panel, melamine top and base on wheels in black or white finish. Available options: low and/or high shelf in melamine, oak and lacquered finishes, 4-legged aluminum base in polished aluminum, white or black finishes and connectivity systems.

Mesa de 2 plazas de respaldo alto con panel tapizado, sobre de melamina y base de ruedas en acabado negro o blanco. Opciones disponibles: estante bajo y/o alto en acabado melamina, roble y lacado, base de 4 patas de aluminio en acabado aluminio pulido, blanco o negro y sistemas de conectividad.

	COM cm. per unit	COL m2
1 units	800	16
10 units or more	800	

3 m3
 76 kg
 x1

COM	COL	1	2	3	4	5	6	7	8	9	10	11	L1	L2	L3	L6
€ 2.235	2.285	2.345	2.394	2.431	2.497	2.561	2.627	2.699	2.778	2.857	2.937	3.016	3.087	3.375	3.899	5.284



Optional 4-legs base
Opción base de 4 patas



Lacquered top upcharge
Incremento sobre lacado | 168



Oak top upcharge
Incremento sobre roble | 705



Melamine shelf upcharge (1 unit)
Incremento estante melamina (1 ud.) | 288



Lacquered shelf upcharge (1 unit)
Incremento estante lacado (1 ud.) | 396



Oak shelf upcharge (1 unit)
Incremento estante roble (1 ud.) | 489

PS-IN SURFACE			PS-UNDER TOP		
	Grommet Tülle		PS0804 USB		PS0735 Power box
€	123	€	177	€	750
					PS0787 Power box Steckerbox
				€	518
					Cable organizer Kabelorganisor
				€	250

**IN-SURFACE GROMMET
PASACABLES DENTRO DEL SOBRE**

Grommet. Available in two finishes: black or white.
Pasacables. Disponible en dos acabados: negro o blanco.

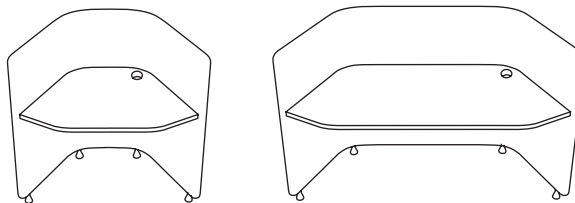
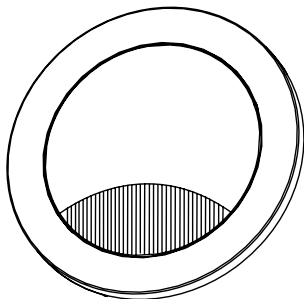

1 GROMMET DISTRIBUTION DISTRIBUCIÓN DE PASACABLES

By default the system position is placed the right side of the table. If more than one system is required or a new position, please contact the Customer Department.

Por defecto la posición del sistema irá en el lado derecho de la mesa. Si se solicita más de un sistema o cambiar el posicionado, consultar con el Departamento Comercial.

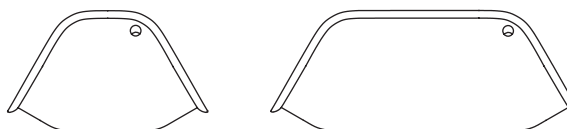

**UNDER-TOP CABLE ORGANIZER
ORGANIZADOR DE CABLES DEBAJO DEL SOBRE**

Cable organizer made of fabric to the tone of the upholstery.
Organizador de cables realizado en tejido al tono de la tapicería.

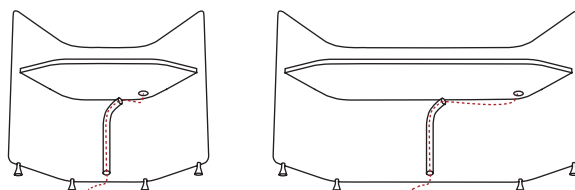
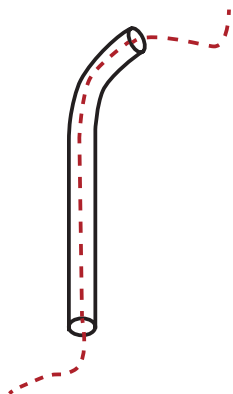

1 WIRING MANAGEMENT GESTIÓN DEL CABLEADO

The cables of the electrical panels installed by the customer will pass through an organizer of fabric cables to the tone of the upholstery of the upholstered panel. The cable organizer is grayed at the bottom of the envelope.

Los cables de los aparatos eléctricos que instale el cliente pasarán a través de un organizador de cables de tela al tono de la tapicería del panel tapizado. El organizador de cables se encanCHA en la parte inferior del sobre.

**IN-SURFACE POWER BOXES
CAJA DE CONEXIONES DENTRO DEL SOBRE**

It is a data dynamo with 2 amp dual charging USB. Available in two finish: black or white.

Dínamo de datos con 2 amp de carga dual USB. Disponible en dos acabados: negro o blanco.

PS0804

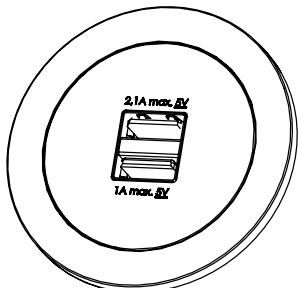

2 x USB
Charger

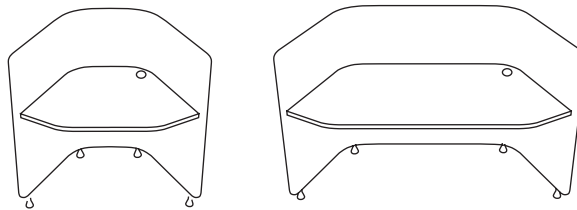

1 POWER BOXES DISTRIBUTION DISTRIBUCIÓN DE SISTEMAS

By default the system position is placed the right side of the table. If more than one system is required or a new position, please contact the Customer Department.

Por defecto la posición del sistema irá en el lado derecho de la mesa. Si se solicita más de un sistema o cambiar el posicionado, consultar con el Departamento Comercial.

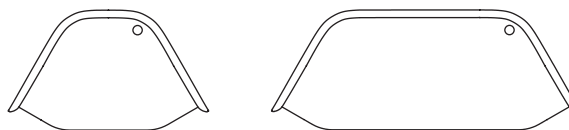

**IN-SURFACE POWER BOXES
CAJA DE CONEXIONES DENTRO DEL SOBRE**

Aluminum power box mounted in the table top with a folding protective lid. It is served in anodized silver, black or white, for other finishing, contact the Customer Department. There are two power system sizes available and data slots can be customized according to the below diagram.

Caja de conexiones de aluminio integrada dentro de la superficie del sobre con tapa abatible. Se sirve en color anodizado plata, negro o blanco, para otros acabados consultar al Departamento Comercial.

PS0735

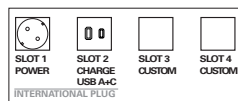

CHOOSE DATA PORT FOR DATA CUSTOM PORT SLOTS

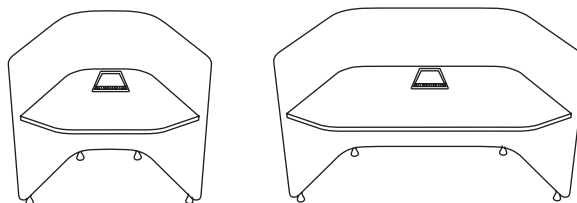
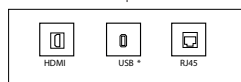

1 POWER BOXES DISTRIBUTION DISTRIBUCIÓN DE SISTEMAS

By default the system position is placed the central of the table. If more than one system is required or a new position, please contact the Customer Department.

Por defecto la posición del sistema irá en el centro de la mesa. Si se solicita más de un sistema o cambiar el posicionado, consultar con el Departamento Comercial.

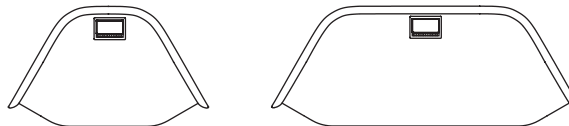

**UNDER-TOP POWER BOXES
CAJA DE CONEXIONES DEBAJO DEL SOBRE**

Power box mounted under the table top. Available in black or white color (silver or black in USA), for other finishing, contact the Customer Department. There are two power system sizes available and data slots can be customized according to the below diagram.

Regleta de conexiones bajo la superficie del sobre. Se sirve en color negro o blanco (plata o negro en USA). Para otros acabados consultar al departamento comercial. Se ofrecen formatos de caja de dos tamaños de caja diferentes y con opciones de conectividad configurable.

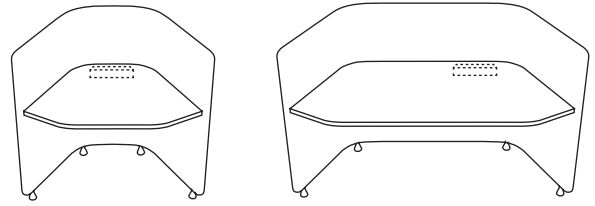

PS0787

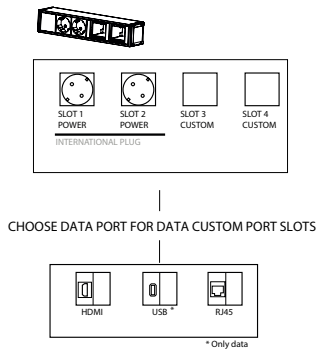

1 POWER BOXES DISTRIBUTION DISTRIBUCIÓN DE SISTEMAS

By default the system position is placed the right side of the table. If more than one system is required or a new position, please contact the Customer Department.

Por defecto la posición del sistema irá en el lado derecho de la mesa. Si se solicita más de un sistema o cambiar el posicionado, consultar con el Departamento Comercial.

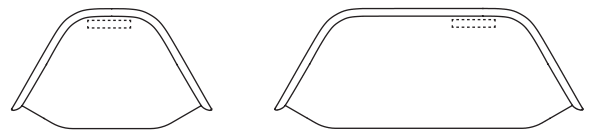

Glides for 4 metal legs base. Tacos para bases de 4 patas metálicas.

Use/Usu	Reference/Referencia		Material/Material	Price/Precio	
Hard floors. Suelos duros.	TS0422		Plastic (PE). Plástico (PE).	15 €	Standard. Estándar.
inout_ts0423.jpg Suelos de madera y delicados.	TS0423		Plastic (PE) with felt. Plástico (PE) con fieltro.	12 €	Set of 4 glides. Juego de 4 tacos.
inout_ts0424.jpg Suelos de moqueta/ alfombra.	TS0424		Metal. Metal.	6 €	Set of 4 glides. Juego de 4 tacos.

The indicated price is for glides placed on chairs. To order loose parts, please ask to our Sales Department.
El precio indicado en Tarifa es para tacos colocados en las sillas. Para pedidos de repuesto, consultar con el Departamento Comercial.

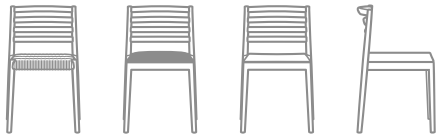

Description
Descripción

Stacking chair with oak board seat, upholstered or with woven cord seat that matches wood tone and solid beech wood backrest and frame.
Silla apilable con asiento de tablero de roble, tapizado o tejido a mano con cordón de alta calidad, y respaldo y estructura de madera maciza de haya.

Upholstery
Tapicería

The Lake collection supports following upholsteries of Andreu World Catalogue. For fabrics in our catalogue not specified in this box or customers own materials please contact our Customer Service Department.
La colección Lake admite las siguientes tapicerías del catálogo de Andreu World. Para las telas de nuestro catálogo no indicadas en este cuadro o telas cliente, consultar con nuestro Departamento Comercial.

Fabrics / Telas

- 1** Soft-fiber
Jacquard One
Jacquard Three
Citadel
Sand
Era
Gravity
Rivet
Urban
Reel One (in/out)
Spin One
Spin Two
Spin Three
Spin Four
Spin Five
- 2** Jacquard Two
Solid & Stripes
Loom One
Circular One Pure Eco
Tack One (in/out)

- 3** Jacquard Four
Medley
Revive 1
Natte
Main Line Flax
Loom Two (in/out)
Mezzo
Reel two (in/out)
Jacquard Five
- 4** Jacquard 4 Special
Nexus
Field 2
Remix 3
Heritage
Savane
Loom Three
Loom Four
Cura
Oceanic
Reel Three (in/out)
Reel Four (in/out)
Reflect
Spin Six

- 5** Silk
Synergy
Step
Step Melange
Blazer
Melange Nap
Chili
Noma
Re-wool
- 6** Go check
Swing
Chartres
Zori
Patio
Tack Two (in/out)
Tack Three (in/out)
- 7** Canvas 2
Select
Clara 2
Tack Five (in/out)
Hero 2

- 8** Capture
Fiord 2
Tonus 4
Divina 3
Lopi
Domino
Atrium
- 9** Divina MD
Divina Melange 3
Hallingdal 65
Steelcut Trio 3
Tack Four (in/out)
- 11** Arda
Ecriture
Zero

Faux Leather / Ecopiel

- 1** Valencia
- 2** Silvertex
- 3** Maglia
- 4** Dolce
- 8** Ultraleather
- 9** Brisa
Brisa Distressed
Fresco
Ultraleather Pro
Promessa
- 10** Tottori
Coast (in/out)
- 11** Reef Pro
Volar Bio

Leather / Piel

- L1** High grade cow leather.
Piel de vaca de 1ª categoría.
- L3** Polished full grain leather.
Piena flor pulida.
- L6** Aniline leather batique-effect.
Scandinavian cattle.
Piel anilina efecto batique.
Ganado escandinavo.

Wood finish Beech
Acabado madera Haya



Woven cord finish
Acabado de cordón

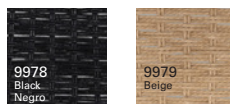

Certificates
Certificados

Fireproof polyurethane foam
Espuma de poliuretano ignífuga

UNE EN 1021:2006
BS 5852 part 2 crib 5
UNI 9175 Classe 1 IM
BKZ 5.2
California TB 117:2013
California TB 133*

*Contact our Customer Department
*Consultar con nuestro Departamento Comercial

Quality - Resistance
Calidad - Resistencia

UNE EN 16139:2013

Intellectual property Propiedad intelectual

All our collections are protected by international industrial design registries, designs patents, copyrights and intellectual Property laws. Unauthorized use of AW International Property is a criminal offence and can lead to prosecution.
Todas nuestras colecciones están protegidas por registros de diseño industrial, diseño de patente, copyright y derechos de propiedad intelectual todo el mundo. El uso no autorizado de los diseños y propiedad intelectual de AW supone un delito que puede ser sometido a acción judicial.



SI0652

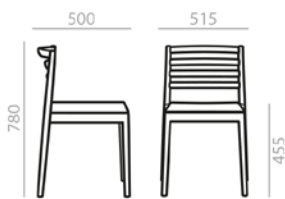

Stackable chair with oak board seat and solid beech wood backrest and frame. Minimum order per color: 4 units.
Silla apilable con asiento de tablero de roble y respaldo y estructura de madera maciza de haya. Pedido mínimo por color: 4 unidades.

- 0,35 m3
- 30 kg
- x4
- 6
- 10

€ 298

SI0653

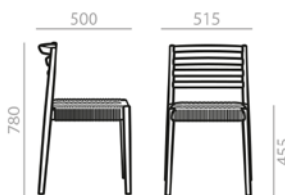

Stackable chair with woven cord seat that matches wood tone and solid beech wood backrest and frame. Minimum order per color: 4 units.
Silla apilable con asiento tejido a mano con cordón de alta calidad al tono de la madera y estructura y respaldo de madera maciza de haya. Pedido mínimo por color: 4 unidades.

- 0,35 m3
- 28 kg
- x4
- 6
- 10

€ 381

SI0654

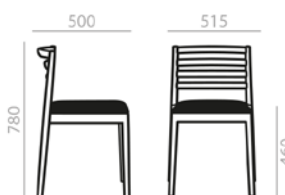

Stackable chair with upholstered seat and solid beech wood backrest and frame. Minimum order per color: 4 units.
Silla apilable con asiento tapizado y respaldo y estructura de madera maciza de haya. Pedido mínimo por color: 4 unidades.

	COM cm. per unit	COL m2
1 units	58	1
10 units or more	29	

- 0,29 m3
- 16,6 kg
- x2
- 4
- 6

€	COM	COL	1	2	3	4	5	6	7	8	9	10	11	L1	L2	L3	L6
	400	403	406	409	412	416	419	423	427	430	434	438	441	445	458	483	791

For wooden legs. Para bases de madera.

SI0654



Optional glides on page 482.
Opciones de tacos deslizantes en página 482.

SI0652, SI0653



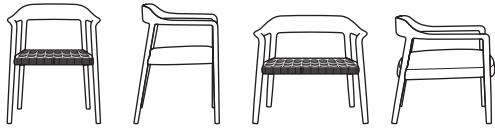

Description
Descripción

Chair, armchair and lounge chair available with seat either upholstered or hand-woven with high quality cord and 4-legged frame in solid ash wood.
Silla, sillón y butaca disponible con asiento tapizado o tejido a mano con cordón de alta calidad y estructura de 4 patas de madera maciza de fresno.

Upholstery
Tapicería

The Liceo collection supports following upholsteries of Andreu World Catalogue. For fabrics in our catalogue not specified in this box or customers own materials please contact our Customer Service Department.
La colección Liceo admite las siguientes tapicerías del catálogo de Andreu World. Para las telas de nuestro catálogo no indicadas en este cuadro o telas cliente, consultar con nuestro Departamento Comercial.

Fabrics / Telas

- 1** Soft-fiber
Jacquard One
Jacquard Three
Citadel
Sand
Era
Gravity
Rivet
Urban
Reel One (in/out)
Spin One
Spin Two
Spin Three
Spin Four
Spin Five
- 2** Jacquard Two
Solid & Stripes
Loom One
Circular One Pure Eco
Tack One (in/out)

- 3** Jacquard Four
Medley
Revive 1
Natte
Main Line Flax
Loom Two (in/out)
Mezzo
Reel two (in/out)
Jacquard Five

- 4** Jacquard 4 Special
Nexus
Field 2
Remix 3
Heritage
Savane
Loom Three
Loom Four
Cura
Oceanic
Reel Three (in/out)
Reel Four (in/out)
Reflect
Spin Six

- 5** Silk
Synergy
Step
Step Melange
Blazer
Melange Nap
Chili
Noma
Re-wool

- 6** Go check
Swing
Chartres
Zori
Patio
Tack Two (in/out)
Tack Three (in/out)

- 7** Canvas 2
Select
Clara 2
Tack Five (in/out)
Hero 2

- 8** Capture
Fiord 2
Tonus 4
Divina 3
Lopi
Domino
Atrium
- 9** Divina MD
Divina Melange 3
Hallingdal 65
Steelcut Trio 3
Tack Four (in/out)

- 11** Arda
Ecriture
Zero

Faux Leather / Ecopiel

- 1** Valencia
- 2** Silvertex
- 3** Maglia
- 4** Dolce
- 8** Ultraleather
- 9** Brisa
Brisa Distressed
Fresco
Ultraleather Pro
Promessa
- 10** Tottori
Coast (in/out)
- 11** Reef Pro
Volar Bio

Leather / Piel

- L1** High grade cow leather.
Piel de vaca de 1ª categoría.
- L3** Polished full grain leather.
Piel de vaca pulida.
- L6** Aniline leather batique-effect.
Scandinavian cattle.
Piel anilina efecto batique.
Ganado escandinavo.

Wood finish Ash
Acabado madera
Fresno



Premium finish and wood lacquers
Acabado premium y lacas madera



Woven cord finish
Acabado de cordón

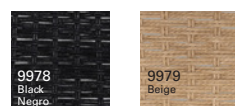

Certificates
Certificados

Fireproof polyurethane foam

Espuma de poliuretano ignifuga

UNE EN 1021:2006
BS 5852 part 2 crib 5
UNI 9175 Classe 1 IM
BKZ 5.2
California TB 117:2013
California TB 133*

*Contact our Customer Department
*Consultar con nuestro Departamento Comercial

Quality - Resistance
Calidad - Resistencia

UNE EN 16139:2013

Intellectual property Propiedad intelectual

All our collections are protected by international industrial design registries, designs patents, copyrights and intellectual Property laws. Unauthorized use of AW International Property is a criminal offence and can lead to prosecution.
Todas nuestras colecciones están protegidas por registros de diseño industrial, diseño de patente, copyright y derechos de propiedad intelectual todo el mundo. El uso no autorizado de los diseños y propiedad intelectual de AW supone un delito que puede ser sometido a acción judicial.



SO1545

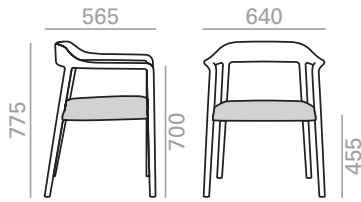

Chair with upholstered seat and backrest and solid ash wood frame.

Silla con asiento tapizado y respaldo y estructura de madera maciza de fresno.

	COM cm. per unit	COL m2
1 units	80	1,75
10 units or more	80	

0,34 m3
11,4 kg
x1

€	COM	COL	1	2	3	4	5	6	7	8	9	10	11	L1	L2	L3	L6
	614	621	630	639	644	653	663	673	683	693	703	713	721	731	765	830	1.001

SERIE 600 | Matte lacquered and premium upcharge | Incremento por lacado mate y premium | 39 |

SO1546

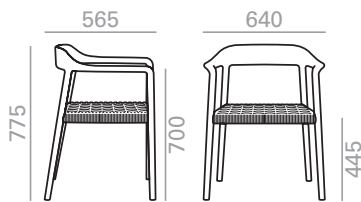

Armchair with seat hand-woven in high quality cord seat that matches wood tone and and 4-legged frame in solid ash wood.

Sillón con asiento tejido a mano con cordón de alta calidad al tono de la madera y estructura y respaldo de madera maciza de fresno.

0,34 m3
11,2 kg
x1

€ 899

SERIE 600 | Matte lacquered and premium upcharge | Incremento por lacado mate y premium | 47 |

BU1547

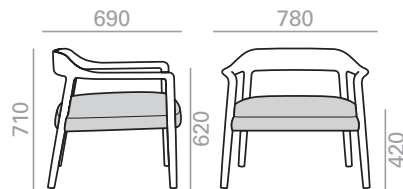

Lounge chair with upholstered seat and backrest and a solid ash wood frame.

Butaca con asiento tapizado y respaldo y estructura de madera maciza de fresno.

	COM cm. per unit	COL m2
1 units	90	2
10 units or more	90	

0,46 m3
13,25 kg
x1

€	COM	COL	1	2	3	4	5	6	7	8	9	10	11	L1	L2	L3	L6
	756	764	774	783	790	800	812	824	834	846	858	868	880	890	929	1.004	1.199

SERIE 600 | Matte lacquered and premium upcharge | Incremento por lacado mate y premium | 39 |

BU1548

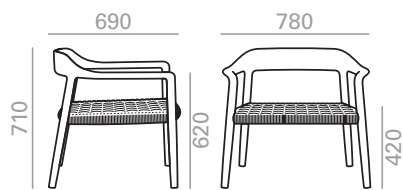

Lounge chair with seat hand-woven in high quality cord seat that matches wood tone and and 4-legged frame in solid ash wood.

Butaca con asiento tejido a mano con cordón de alta calidad al tono de la madera y estructura y respaldo de madera maciza de fresno.

0,46 m3
15,25 kg
x1

€ 1.109

SERIE 600 | Matte lacquered and premium upcharge | Incremento por lacado mate y premium | 47 |



Description
Descripción

Stackable chairs, armchairs and lounge chairs with oak board shell or upholstered shell and steel rod sled base polished chrome, white or black finish. Stools with 4-legged solid beech base, steel rod sled base or 4-legged steel swivel base, in polished chrome, white or black finish. The stools are offered in 2 different heights. Available options: padded seat or padded seat and backrest, upholstered with parallel seams and upholstered armrests in armchairs.

Sillas, sillones y butacas apilables con carcasa de tablero de roble o carcasa tapizada y base de de patín de varilla de acero en acabado cromo brillo, blanco o negro. Banquetas con base de 4 patas de madera maciza de haya, base de patín de varilla de acero o base giratoria de 4 patas de acero, en acabado cromo brillo, blanco o negro. Las banquetas se ofrecen en 2 alturas diferentes. Opciones disponibles: asiento plafonado o asiento y respaldo plafonado, tapizado con costuras paralelas y brazos tapizados en sillones.

Upholstery
Tapicería

The Lineal collection supports following upholsteries of Andreu World Catalogue. For fabrics in our catalogue not specified in this box or customers own materials please contact our Customer Service Department.

La colección Lineal admite las siguientes tapicerías del catálogo de Andreu World. Para las telas de nuestro catálogo no indicadas en este cuadro o telas cliente, consultar con nuestro Departamento Comercial.

Fabrics / Telas

- 1 Jacquard One
Jacquard Three
Citadel
Era
Gravity
Rivet
Urban
Spin One
Spin Two
Spin Three
Spin Four
Spin Five
- 2 Jacquard Two
Circular One Pure Eco
Tack One (in/out)

- 3 Jacquard Four
Medley
Revive 1
Natte
Main Line Flax
Loom Two (in/out)
Mezzo
Reel two (in/out)
Jacquard Five

- 4 Jacquard 4 Special
Nexus
Heritage
Savane
Loom Three
Loom Four
Cura
Oceanic
Reel Three (in/out)
Reel Four (in/out)
Reflect
Spin Six

- 5 Silk
Synergy
Step
Step Melange
Blazer
Melange Nap
Chili
Noma
Re-wool

- 6 Go check
Swing
Chartres
Zori
Patio
Tack Two (in/out)
Tack Three (in/out)

- 7 Canvas 2
Select
Clara 2
Tack Five (in/out)
Hero 2

- 8 Capture
Fiord 2
Tonus 4
Divina 3
Lopi
Domino

- 9 Divina MD
Divina Melange 3
Hallingdal 65
Steelcut Trio 3
Tack Four (in/out)

- 11 Arda
Ecriture
Zero

Faux Leather / Ecopiel

- 1 Valencia
- 2 Silvertex
- 3 Maglia
- 4 Dolce
- 8 Ultraleather
- 9 Brisa
Brisa Distressed
Fresco
Ultraleather Pro
Promessa

- 10 Tottori
Coast (in/out)

- 11 Reef Pro
Volar Bio

Leather / Piel

- L1 High grade cow leather.
Piel de vaca de 1ª categoría.
- L3 Polished full grain leather.
Plena flor pulida.
- L6 Aniline leather batique-effect.
Scandinavian cattle.
Piel anilina efecto batique.
Ganado escandinavo.

Hide Leather / Cuero

- L2 Chrome tanned split leather.
Base in polyurethane resin
emulsion in water. Cellulose
nitric varnish.
Costra cocida al cromo. Base
de emulsiones de resinas
poliuretánicas en agua. Barniz
nitro celulósico.

Wood finish Beech
Acabado madera Haya



Premium finish and wood lacquers
Acabado premium y lacas madera



Wood finish Oak
Acabado madera Roble

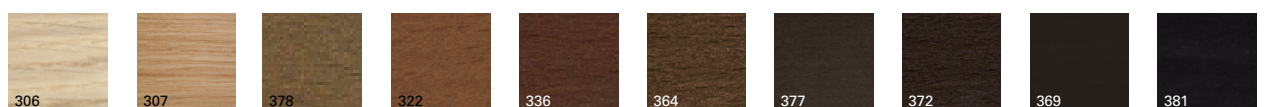

Premium finish and wood lacquers
Acabado premium y lacas madera



Leather finish
Acabado de cuero

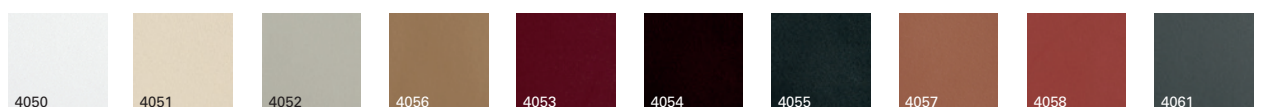

Certificates
Certificados

Fireproof polyurethane foam
Espuma de poliuretano ignifuga

UNE EN 1021:2006
BS 5852 part 2 crib 5
UNI 9175 Classe 1 IM
BKZ 5.2
California TB 117:2013
California TB 133*

*Contact our Customer Department
*Consultar con nuestro Departamento Comercial

Quality - Resistance
Calidad - Resistencia

UNE EN 16139:2013

Intellectual property Propiedad intelectual

All our collections are protected by international industrial design registries, designs patents, copyrights and intellectual Property laws. Unauthorized use of AW International Property is a criminal offence and can lead to prosecution. Todas nuestras colecciones están protegidas por registros de diseño industrial, diseño de patente, copyright y derechos de propiedad intelectual todo el mundo. El uso no autorizado de los diseños y propiedad intelectual de AW supone un delito que puede ser sometido a acción judicial.



SI0582

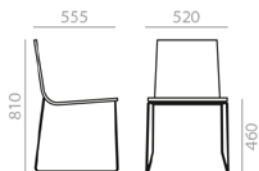

Stackable chair with oak board seat and backrest and steel sled base finished in polished chrome, white or black. Optional fully upholstered shell or parallel upholstery stitching. Optional upholstered seat pad or upholstered shell pad. In upholstered versions the seat height increases 20 mm. (L2) Hide Leather.

Silla apilable con carcasa de tablero de roble y base de patín de varilla de acero en acabado cromo brillo, blanco o negro. Opción d carcasa tapizada con posibilidad de tapizado con costuras paralelas. Opción de asiento plafonado o asiento y respaldo plafonado. En versiones tapizadas la altura de asiento aumenta 20 mm. (L2) Cuero.

COM cm. per unit	COL m2
------------------	--------

0,3 m3
20,8 kg
x2

Fully upholstered Carcasa tapizada		2,25
1 units	110	
10 units or more	90	

8
14

Seat pad Asiento plafonado		1,25
1 units	55	
10 units or more	28	

Shell pad Asiento y respaldo plafonado		1,75
1 units	95	
10 units or more	48	

€



321

Oak
Roble



COM	COL	1	2	3	4	5	6	7	8	9	10	11	L1	L2	L3	L6
318	326	335	344	349	361	370	380	394	407	420	433	446	457	506	591	818

Fully upholstered shell
Carcasa tapizada



COM	COL	1	2	3	4	5	6	7	8	9	10	11	L1	L2	L3	L6
380	381	384	387	389	392	395	399	402	404	409	411	414	418	429	450	515

Upholstered seat pad
Asiento plafonado



COM	COL	1	2	3	4	5	6	7	8	9	10	11	L1	L2	L3	L6
437	441	445	449	453	459	464	468	473	478	484	489	494	500	518	553	643

Upholstered shell pad
Asiento y respaldo plafonado



Matte lacquered and premium upcharge
Incremento por lacado mate y premium

17



Parallel stitching upholstery upcharge (Seat and back)
Incremento tapizado con costuras paralelas (Asiento y respaldo)

59



Parallel stitching upholstery upcharge (Seat)
Incremento tapizado con costuras paralelas (Asiento)

30

SO0583

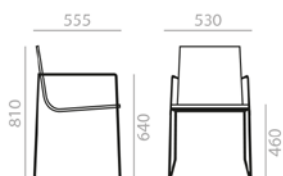

Stackable armchair with oak board seat and backrest and steel sled base finished in polished chrome, white or black. Optional fully upholstered shell or parallel upholstery stitching. Optional upholstered seat pad or upholstered shell pad. In upholstered versions the seat height increases 20 mm. (L2) Hide Leather.

Sillón apilable con carcasa de tablero de roble y base de patín de varilla de acero en acabado cromo brillo, blanco o negro. Opción de carcasa tapizada con posibilidad de tapizado con costuras paralelas. Opción de asiento plafonado o asiento y respaldo plafonado. En versiones tapizadas la altura de asiento aumenta 20 mm. (L2) Cuero.

COM cm. per unit	COL m2
------------------	--------

0,35 m3
24,8 kg
x2

Fully upholstered Carcasa tapizada		2,25
1 units	110	
10 units or more	90	

8
14

Seat pad Asiento plafonado		1,25
1 units	55	
10 units or more	28	

Shell pad Asiento y respaldo plafonado		1,75
1 units	95	
10 units or more	48	

€



382

Oak
Roble



COM	COL	1	2	3	4	5	6	7	8	9	10	11	L1	L2	L3	L6
392	401	411	420	427	439	451	463	478	493	508	523	538	553	604	703	963

Fully upholstered shell
Carcasa tapizada



COM	COL	1	2	3	4	5	6	7	8	9	10	11	L1	L2	L3	L6
445	448	451	454	457	460	464	467	470	474	477	481	484	487	500	522	593

Upholstered seat pad
Asiento plafonado



COM	COL	1	2	3	4	5	6	7	8	9	10	11	L1	L2	L3	L6
484	488	492	496	500	505	511	516	522	527	532	538	543	547	567	606	719

Upholstered shell pad
Asiento y respaldo plafonado



Matte lacquered and premium upcharge
Incremento por lacado mate y premium

17



Parallel stitching upholstery upcharge (Seat and back)
Incremento tapizado con costuras paralelas (Asiento y respaldo)

59



Parallel stitching upholstery upcharge (Seat)
Incremento tapizado con costuras paralelas (Asiento)

30



Upholstered arm upcharge
Incremento brazo tapizado

61

SI0760



Chair with oak board seat and backrest and 4-legs solid beech wood base. Optional fully upholstered shell or parallel upholstery stitching. Optional upholstered seat pad or upholstered shell pad. In upholstered versions the seat height increases 20 mm. (L2) Hide Leather.

Silla con carcasa de tablero de roble y base de 4 patas de madera maciza de haya. Opción de carcasa tapizada con posibilidad de tapizado con costuras paralelas. Opción de asiento plafonado o asiento y respaldo plafonado. En versiones tapizadas la altura de asiento aumenta 20 mm. (L2) Cuero.

COM cm. per unit	COL m2
------------------	--------

0,35 m3
16 kg
x2

Fully upholstered Carcasa tapizada		
1 units	110	2,25
10 units or more	90	

Seat pad Asiento plafonado		
1 units	55	1,25
10 units or more	28	

Shell pad Asiento y respaldo plafonado		
1 units	95	1,75
10 units or more	48	

€ 404

Oak Roble

COM	COL	1	2	3	4	5	6	7	8	9	10	11	L1	L2	L3	L6
459	468	479	490	496	510	522	534	550	566	585	601	620	635	718	826	1.119

Fully upholstered shell Carcasa tapizada

COM	COL	1	2	3	4	5	6	7	8	9	10	11	L1	L2	L3	L6
484	487	490	493	496	498	503	505	510	512	517	521	524	526	539	563	626

Upholstered seat pad Asiento plafonado

COM	COL	1	2	3	4	5	6	7	8	9	10	11	L1	L2	L3	L6
494	498	502	506	510	515	520	524	530	535	540	545	551	556	574	609	713

Upholstered shell pad Asiento y respaldo plafonado

SERIE 600	Matte lacquered and premium upcharge Incremento por lacado mate y premium	39	SERIE 800	Bright lacquered upcharge Incremento por lacado brillo	39		Parallel stitching upholstery upcharge (Seat and back) Incremento tapizado con costuras paralelas (Asiento y respaldo)	59		Parallel stitching upholstery upcharge (Seat) Incremento tapizado con costuras paralelas (Asiento)	30
-----------	---	----	-----------	--	----	--	--	----	--	--	----

SO0761

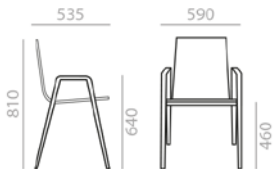

Armchair with oak board seat and backrest and 4-legs solid beech wood base. Optional fully upholstered shell or parallel upholstery stitching. Optional upholstered seat pad or upholstered shell pad. In upholstered versions the seat height increases 20 mm. (L2) Hide Leather.

Sillón con carcasa de tablero de roble y base de 4 patas de madera maciza de haya. Opción de carcasa tapizada con posibilidad de tapizado con costuras paralelas. Opción de asiento plafonado o asiento y respaldo plafonado. En versiones tapizadas la altura de asiento aumenta 20 mm. (L2) Cuero.

COM cm. per unit	COL m2
------------------	--------

0,29 m3
10,1 kg
x1

Fully upholstered Carcasa tapizada		
1 units	110	2,25
10 units or more	90	

Seat pad Asiento plafonado		
1 units	55	1,25
10 units or more	28	

Shell pad Asiento y respaldo plafonado		
1 units	95	1,75
10 units or more	48	

€ 479

Oak Roble

COM	COL	1	2	3	4	5	6	7	8	9	10	11	L1	L2	L3	L6
507	516	527	536	544	556	568	581	593	605	622	639	655	669	751	853	1.130

Fully upholstered shell Carcasa tapizada

COM	COL	1	2	3	4	5	6	7	8	9	10	11	L1	L2	L3	L6
562	565	568	571	574	577	581	585	588	592	595	599	603	606	619	643	707

Upholstered seat pad Asiento plafonado

COM	COL	1	2	3	4	5	6	7	8	9	10	11	L1	L2	L3	L6
561	565	569	573	577	582	588	593	599	604	609	613	619	624	643	678	793

Upholstered shell pad Asiento y respaldo plafonado

SERIE 600	Matte lacquered and premium upcharge Incremento por lacado mate y premium	47	SERIE 800	Bright lacquered upcharge Incremento por lacado brillo	47		Parallel stitching upholstery upcharge (Seat and back) Incremento tapizado con costuras paralelas (Asiento y respaldo)	59		Parallel stitching upholstery upcharge (Seat) Incremento tapizado con costuras paralelas (Asiento)	30
-----------	---	----	-----------	--	----	--	--	----	--	--	----

BQ0590

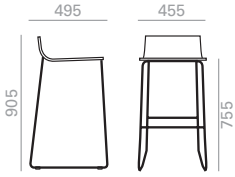

Barstool with oak board seat and backrest and steel sled base finished in polished chrome, white or black. Optional fully upholstered shell or parallel upholstery stitching. Optional upholstered seat pad or upholstered shell pad. In upholstered versions the seat height increases 20 mm. (L2) Hide Leather.

Banqueta alta con carcasa de tablero de roble y base de patin de varilla de acero en acabado cromo brillo, blanco o negro. Opción de carcasa tapizada con posibilidad de tapizado con costuras paralelas. Opción de asiento plafonado o asiento y respaldo plafonado. En versiones tapizadas la altura de asiento aumenta 20 mm. (L2) Cuero.

COM cm. per unit	COL m2
------------------	--------

0,26 m3
8,5 kg
x1

Fully upholstered Carcasa tapizada		2
1 units	70	
10 units or more	60	

Seat pad Asiento plafonado		0,75
1 units	60	
10 units or more	30	

Shell pad Asiento y respaldo plafonado		1,5
1 units	60	
10 units or more	30	

€



325

Oak Roble



Upholstered seat Asiento tapizado

COM	COL	1	2	3	4	5	6	7	8	9	10	11	L1	L2	L3	L6
348	353	357	361	366	371	377	383	388	394	400	406	410	416	438	481	599



Upholstered seat pad Asiento plafonado

COM	COL	1	2	3	4	5	6	7	8	9	10	11	L1	L2	L3	L6
393	396	399	403	405	409	413	417	420	425	429	433	436	440	455	480	550



Upholstered shell pad Asiento y respaldo plafonado

COM	COL	1	2	3	4	5	6	7	8	9	10	11	L1	L2	L3	L6
413	415	418	421	423	426	430	433	437	440	444	446	450	453	465	488	546



Matte lacquered and premium upcharge Incremento por lacado mate y premium

12



Parallel stitching upholstery upcharge (Seat and back) Incremento tapizado con costuras paralelas (Asiento y respaldo)

59



Parallel stitching upholstery upcharge (Seat) Incremento tapizado con costuras paralelas (Asiento)

30

BQ0600

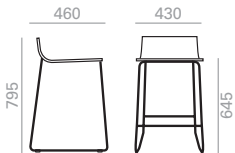

Counter stool with oak board seat and backrest and steel sled base finished in polished chrome, white or black. Optional fully upholstered shell or parallel upholstery stitching. Optional upholstered seat pad or upholstered shell pad. In upholstered versions the seat height increases 20 mm. (L2) Hide Leather.

Banqueta baja con carcasa de tablero de roble y base de patin de varilla de acero en acabado cromo brillo, blanco o negro. Opción de carcasa tapizada con posibilidad de tapizado con costuras paralelas. Opción de asiento y respaldo plafonado. En versiones tapizadas la altura de asiento aumenta 20 mm. (L2) Cuero.

COM cm. per unit	COL m2
------------------	--------

0,19 m3
8,5 kg
x1

Fully upholstered Carcasa tapizada		2
1 units	70	
10 units or more	60	

Seat pad Asiento plafonado		0,75
1 units	60	
10 units or more	30	

Shell pad Asiento y respaldo plafonado		1,25
1 units	60	
10 units or more	30	

€



325

Oak Roble



Fully upholstered shell Carcasa tapizada

COM	COL	1	2	3	4	5	6	7	8	9	10	11	L1	L2	L3	L6
348	353	357	361	366	371	377	383	388	394	400	406	410	416	438	481	599



Upholstered seat pad Asiento plafonado

COM	COL	1	2	3	4	5	6	7	8	9	10	11	L1	L2	L3	L6
393	396	399	403	405	409	413	417	420	425	429	433	436	440	455	480	550



Upholstered shell pad Asiento y respaldo plafonado

COM	COL	1	2	3	4	5	6	7	8	9	10	11	L1	L2	L3	L6
413	415	418	421	423	426	430	433	437	440	444	446	450	453	465	488	546



Matte lacquered and premium upcharge Incremento por lacado mate y premium

12



Parallel stitching upholstery upcharge (Seat and back) Incremento tapizado con costuras paralelas (Asiento y respaldo)

59



Parallel stitching upholstery upcharge (Seat) Incremento tapizado con costuras paralelas (Asiento)

30



Measures +- 5 mm. Medidas +- 5 mm.

BQ0638



Barstool with oak board seat and backrest and 4-legs solid beech wood base. Optional fully upholstered shell or parallel upholstery stitching. Optional upholstered seat pad or upholstered shell pad. In upholstered versions the seat height increases 20 mm. (L2) Hide Leather.

Banqueta alta con carcasa de tablero de roble y base de 4 patas de madera maciza de haya. Opción de carcasa tapizada con posibilidad de tapizado con costuras paralelas. Opción de asiento plafonado o asiento y respaldo plafonado. En versiones tapizadas la altura de asiento aumenta 20 mm. (L2) Cuero.

COM cm. per unit	COL m2
------------------	--------

0,28 m3
9 kg
x1

Fully upholstered Carcasa tapizada		2,25
1 units	70	
10 units or more	63	

Seat pad Asiento plafonado		0,75
1 units	60	
10 units or more	30	

Shell pad Asiento y respaldo plafonado		1,25
1 units	75	
10 units or more	40	

€



Oak Roble

561



Fully upholstered shell Carcasa tapizada

COM	COL	1	2	3	4	5	6	7	8	9	10	11	L1	L2	L3	L6
564	570	577	583	589	596	604	612	619	628	635	644	651	658	687	743	930



Upholstered seat pad Asiento plafonado

COM	COL	1	2	3	4	5	6	7	8	9	10	11	L1	L2	L3	L6
629	632	635	639	641	645	649	653	657	662	666	670	674	677	692	719	791



Upholstered shell pad Asiento y respaldo plafonado

COM	COL	1	2	3	4	5	6	7	8	9	10	11	L1	L2	L3	L6
627	630	634	638	641	645	651	655	659	665	669	675	679	683	700	731	814



Matte lacquered and premium upcharge Incremento por lacado mate y premium

54



Bright lacquered upcharge Incremento por lacado brillo

54



Parallel stitching upholstery upcharge (Seat and back) Incremento tapizado con costuras paralelas (Asiento y respaldo)

59



Parallel stitching upholstery upcharge (Seat) Incremento tapizado con costuras paralelas (Asiento)

30

BQ0639

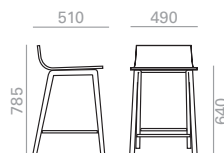

Counter stool with oak board seat and backrest and 4-legs solid beech wood base. Optional fully upholstered shell or parallel upholstery stitching. Optional upholstered seat pad or upholstered shell pad. In upholstered versions the seat height increases 20 mm. (L2) Hide Leather.

Banqueta baja con carcasa de tablero de roble y base de 4 patas de madera maciza de haya. Opción de carcasa tapizada con posibilidad de tapizado con costuras paralelas. Opción de asiento plafonado o asiento y respaldo plafonado. En versiones tapizadas la altura de asiento aumenta 20 mm. (L2) Cuero.

COM cm. per unit	COL m2
------------------	--------

0,25 m3
8 kg
x1

Fully upholstered Carcasa tapizada		2,25
1 units	70	
10 units or more	63	

Seat pad Asiento plafonado		0,75
1 units	60	
10 units or more	30	

Shell pad Asiento y respaldo plafonado		1,25
1 units	75	
10 units or more	40	

€



Oak Roble

561



Fully upholstered shell Carcasa tapizada

COM	COL	1	2	3	4	5	6	7	8	9	10	11	L1	L2	L3	L6
564	570	577	583	589	596	604	612	619	628	635	644	651	658	687	743	930



Upholstered seat pad Asiento plafonado

COM	COL	1	2	3	4	5	6	7	8	9	10	11	L1	L2	L3	L6
629	632	635	639	641	645	649	653	657	662	666	670	674	677	692	719	791



Upholstered shell pad Asiento y respaldo plafonado

COM	COL	1	2	3	4	5	6	7	8	9	10	11	L1	L2	L3	L6
627	630	634	638	641	645	651	655	659	665	669	675	679	683	700	731	814



Matte lacquered and premium upcharge Incremento por lacado mate y premium

54



Bright lacquered upcharge Incremento por lacado brillo

54



Parallel stitching upholstery upcharge (Seat and back) Incremento tapizado con costuras paralelas (Asiento y respaldo)

59



Parallel stitching upholstery upcharge (Seat) Incremento tapizado con costuras paralelas (Asiento)

30



Measures +- 5 mm. Medidas +- 5 mm.

BQ0642

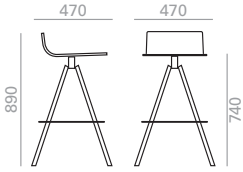

Barstool with oak plywood shell and 4-legs steel swivel base finished in polished chrome, white or black. Optional fully upholstered shell or parallel upholstery stitching. Optional upholstered seat pad or upholstered shell pad. In upholstered versions the seat height increases 20 mm. (L2) Hide Leather.

Banqueta alta con carcasa de tablero de roble y base giratoria de 4 patas de acero y acabado cromo brillo, blanco o negro. Opción de carcasa tapizada con posibilidad de tapizado con costuras paralelas. Opción de Asiento plafonado. En versiones tapizadas la altura de asiento aumenta 20 mm. (L2) Cuero.

COM cm. per unit	COL m2
------------------	--------

0,24 m3
8,3 kg
x1

Fully upholstered Carcasa tapizada		
1 units	70	2,25
10 units or more	63	

Seat pad Asiento plafonado		
1 units	60	0,75
10 units or more	30	

Shell pad Asiento y respaldo plafonado		
1 units	75	1,25
10 units or more	40	

€



458

Oak Roble



Fully upholstered shell Carcasa tapizada

COM	COL	1	2	3	4	5	6	7	8	9	10	11	L1	L2	L3	L6
472	479	486	493	499	507	517	525	534	544	556	564	575	584	623	695	888



Upholstered seat pad Asiento plafonado

COM	COL	1	2	3	4	5	6	7	8	9	10	11	L1	L2	L3	L6
521	525	528	532	535	539	544	548	552	558	562	566	571	575	590	620	699



Upholstered shell pad Asiento y respaldo plafonado

COM	COL	1	2	3	4	5	6	7	8	9	10	11	L1	L2	L3	L6
554	558	562	566	569	575	580	586	591	596	601	607	612	617	636	671	764



Matte lacquered and premium upcharge Incremento por lacado mate y premium

12



Parallel stitching upholstery upcharge (Seat and back) Incremento tapizado con costuras paralelas (Asiento y respaldo)

59



Parallel stitching upholstery upcharge (Seat) Incremento tapizado con costuras paralelas (Asiento)

30

BQ0647

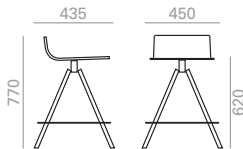

Counter stool with oak plywood shell and 4-legs steel swivel base finished in polished chrome, white or black. Optional fully upholstered shell or parallel upholstery stitching. Optional upholstered seat pad or upholstered shell pad. In upholstered versions the seat height increases 20 mm. (L2) Hide Leather.

Banqueta baja con carcasa de tablero de roble y base giratoria de 4 patas de acero y acabado cromo brillo, blanco o negro. Opción de carcasa tapizada con posibilidad de tapizado con costuras paralelas. Opción de asiento plafonado. En versiones tapizadas la altura de asiento aumenta 20 mm. (L2) Cuero.

COM cm. per unit	COL m2
------------------	--------

0,17 m3
7,8 kg
x1

Fully upholstered Carcasa tapizada		
1 units	70	2
10 units or more	63	

Seat pad Asiento plafonado		
1 units	60	0,75
10 units or more	30	

Shell pad Asiento y respaldo plafonado		
1 units	75	1,25
10 units or more	40	

€



458

Oak Roble



Fully upholstered shell Carcasa tapizada

COM	COL	1	2	3	4	5	6	7	8	9	10	11	L1	L2	L3	L6
472	479	486	493	499	507	517	525	534	544	556	564	575	584	623	695	888



Upholstered seat pad Asiento plafonado

COM	COL	1	2	3	4	5	6	7	8	9	10	11	L1	L2	L3	L6
521	525	528	532	535	539	544	548	552	558	562	566	571	575	590	620	699



Upholstered shell pad Asiento y respaldo plafonado

COM	COL	1	2	3	4	5	6	7	8	9	10	11	L1	L2	L3	L6
554	558	562	566	569	575	580	586	591	596	601	607	612	617	636	671	764



Matte lacquered and premium upcharge Incremento por lacado mate y premium

12



Parallel stitching upholstery upcharge (Seat and back) Incremento tapizado con costuras paralelas (Asiento y respaldo)

59



Parallel stitching upholstery upcharge (Seat) Incremento tapizado con costuras paralelas (Asiento)

30



Glides for sled bases/cantilever. Tacos para bases de patín/cantilever.

Use/Usó	Reference/Referencia	Material/Material	Price/Precio
Hard floors. Suelos duros.	TS0531	Plastic (PE). Plástico (PE).	0 € Standard. Estándar.
Wooden and delicate floors. Suelos de madera y delicados.	TS0538	Plastic (PE) with felt. Plástico (PE) con fieltro.	6 € Set of 4 glides. Juego de 4 tacos.
Mats/carpet floors. Suelos de moqueta/alfombra.	TS0537	No glide. Sin taco.	0 €

The indicated price is for glides placed on chairs. To order loose parts, please ask to our Sales Department.

El precio indicado en Tarifa es para tacos colocados en las sillas. Para pedidos de tacos sueltos de repuesto, consultar con el Departamento Comercial.

Glides for 4 steel legs with swivel base. Tacos para base giratoria de 4 patas de acero.

Use/Usó	Reference/Referencia	Material/Material	Price/Precio
Hard floors and mats/ carpet floors. Suelos duros y moqueta/alfombra.	TS0416	Plastic (PE). Plástico (PE).	0 € Standard. Estándar.
Wooden and delicate floors. Suelos de madera y delicados.	TS0417	Plastic (PE) with felt. Plástico (PE) con fieltro.	12 € Set of 4 glides. Juego de 4 tacos.

The indicated price is for glides placed on chairs. To order loose parts, please ask to our Sales Department.

El precio indicado en Tarifa es para tacos colocados en las sillas. Para pedidos de tacos sueltos de repuesto, consultar con el Departamento Comercial.

For wooden legs. Para bases de madera.



Optional glides on page 482.

Opciones de tacos deslizantes en página 482.

Lineal stackability



SI0582 AU SOL
8 unités
530 x 765 x 985 mm.

Tapissé
8 unités
530 x 835 x 1055 mm.

SUR CHARRIOT
14 unités
560 x 850 x 1260 mm.

Tapissé
14 unités
530 x 835 x 1055 mm.



SO0583 AU SOL
8 unités
540 x 765 x 985 mm.

Tapissé
8 unités
540 x 835 x 1055 mm.

SUR CHARRIOT
14 unités
560 x 850 x 1260 mm.

Tapissé
14 unités
540 x 835 x 1055 mm.

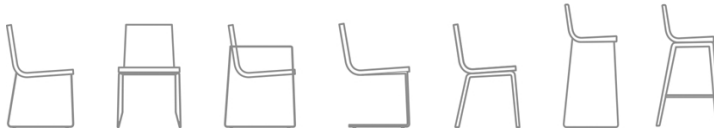

Description
Descripción

Chairs, armchairs and lounge chairs with or without arms, stackable and with upholstered shell. Steel rod sled base in polished chrome, white or black finish. Chair and armchair versions with cantilever base made of oval steel bar and white or black polished chrome finish, 4 solid beech legs and aluminum central swivelbase with 5 casters, height-adjustable and polished aluminum, white or black finish. Armchair version with upholstered seat, backrest and armrests and steel rod sled base and polished chrome, white or black finish or with a 4-star aluminum central swivel base with return system and polished aluminum, white or black finish. Stool versions with 4-legged solid beech base, steel rod sled base and polished chrome, white or black finish or with a swivel base with 4 steel legs and polished chrome, white or black finish. They are offered in 2 different heights.

Sillas, sillones y butacas con o sin brazos, apilables y con carcasa tapizada. Base de patín de varilla de acero en acabado cromo brillo, blanco o negro. Versiones de silla y sillón con base cantiléver de pletina ovalada de acero y acabado cromo brillo blanco o negro, 4 patas de madera maciza de haya y de base central giratoria de aluminio con 5 ruedas, regulable en altura y acabado aluminio pulido, blanco o negro. Versión de sillón con asiento, respaldo y brazos tapizados y base de patín de varilla de acero y acabado cromo brillo, blanco o negro o de base central giratoria de aluminio de 4 aspas con sistema de retorno y acabado aluminio pulido, blanco o negro. Versiones de banqueta con base de 4 patas de madera maciza de haya, base de patín de varilla de acero y acabado cromo brillo, blanco o negro o de base giratoria de 4 patas de acero y acabado cromo brillo, blanco o negro. Las banquetas se ofrecen en 2 alturas diferentes.

Upholstery
Tapicería

The Lineal Comfort collection supports following upholsteries of Andreu World Catalogue. For fabrics in our catalogue not specified in this box or customers own materials please contact our Customer Service Department.

La colección Lineal Comfort admite las siguientes tapicerías del catálogo de Andreu World. Para las telas de nuestro catálogo no indicadas en este cuadro o telas cliente, consultar con nuestro Departamento Comercial.

Fabrics / Telas

- 1 Jacquard One
- Jacquard Three
- Era
- Gravity
- Rivet
- Urban
- Spin One
- Spin Two
- Spin Three
- Spin Four
- Spin Five
- 2 Jacquard Two
- Loom One
- Circular One Pure Eco
- Tack One (in/out)

- 3 Jacquard Four
- Medley
- Revive 1
- Natte
- Main Line Flax
- Loom Two (in/out)
- Mezzo
- Reel two (in/out)
- Jacquard Five

- 4 Jacquard 4 Special
- Nexus
- Heritage
- Savane
- Loom Three
- Loom Four
- Cura
- Oceanic
- Reel Three (in/out)
- Reel Four (in/out)
- Reflect
- Spin Six

- 5 Silk
- Synergy
- Step
- Step Melange
- Blazer
- Melange Nap
- Chili
- Noma
- Re-wool

- 6 Go check
- Swing
- Chartres
- Zori
- Patio
- Tack Two (in/out)
- Tack Three (in/out)

- 7 Canvas 2
- Select
- Clara 2
- Tack Five (in/out)
- Hero 2

- 8 Capture
- Fiord 2
- Tonus 4
- Divina 3
- Lopi
- Domino
- 9 Divina MD
- Divina Melange 3
- Hallingdal 65
- Steelcut Trio 3
- Tack Four (in/out)

- 11 Arda
- Ecriture
- Zero

Faux Leather / Ecopiel

- 1 Valencia
- 2 Silvertex
- 3 Maglia
- 4 Dolce
- 8 Ultraleather

- 9 Brisa
- Brisa Distressed
- Fresco
- Ultraleather Pro
- Promessa

- 10 Tottori
- Coast (in/out)

- 11 Reef Pro
- Volar Bio

Leather / Piel

- L1 High grade cow leather. Piel de vaca de 1ª categoría.
- L3 Polished full grain leather. Piel de vaca pulida.
- L6 Aniline leather batique-effect. Scandinavian cattle. Piel anilina efecto batique. Ganado escandinavo.

Wood finish Beech
Acabado madera Haya



Premium finish and wood lacquers
Acabado premium y lacas madera

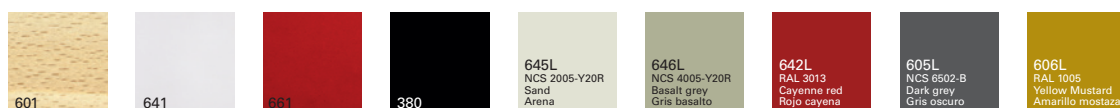

Steel finish
Acabado de acero



Certificates
Certificados

Fireproof polyurethane foam

Espuma de poliuretano ignifuga

UNE EN 1021:2006
BS 5852 part 2 crib 5
UNI 9175 Classe 1 IM
BKZ 5.2
California TB 117:2013
California TB 133*

*Contact our Customer Department
*Consultar con nuestro Departamento Comercial

Quality - Resistance
Calidad - Resistencia

UNE EN 16139:2013

Intellectual property Propiedad intelectual

All our collections are protected by international industrial design registries, designs patents, copyrights and intellectual Property laws. Unauthorized use of AW International Property is a criminal offence and can lead to prosecution.
Todas nuestras colecciones están protegidas por registros de diseño industrial, diseño de patente, copyright y derechos de propiedad intelectual todo el mundo. El uso no autorizado de los diseños y propiedad intelectual de AW supone un delito que puede ser sometido a acción judicial.



SI0594

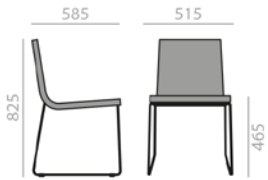

Stackable chair with upholstered seat and backrest and steel sled base finished in polished chrome, white or black.
Silla apilable con carcasa tapizada y base de patín de varilla de acero en acabado cromo brillo, blanco o negro.

	COM cm. per unit	COL m2
1 units	200	3,75
10 units or more	100	

- 0,31 m3
- 28,4 kg
- x2
- 6
- 10

€	COM	COL	1	2	3	4	5	6	7	8	9	10	11	L1	L2	L3	L6
	394	406	419	431	441	458	477	495	512	517	533	549	568	582	644	758	1.060

SO0595

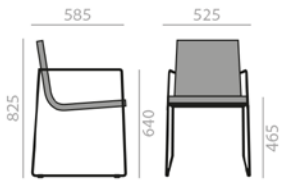

Stackable armchair with upholstered seat and backrest and steel sled base finished in polished chrome, white or black. Optional: Upholstered arms.
Sillón apilable con carcasa tapizada y base de patín de varilla de acero en acabado cromo brillo, blanco o negro. Opción de brazos tapizados.

	COM cm. per unit	COL m2
1 units	200	3,75
10 units or more	100	

- 0,34 m3
- 32,4 kg
- x2
- 6
- 10

€	COM	COL	1	2	3	4	5	6	7	8	9	10	11	L1	L2	L3	L6
	459	470	483	494	503	518	532	546	562	576	594	609	624	632	686	795	1.084

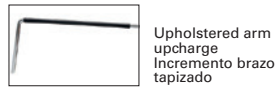

SI0567

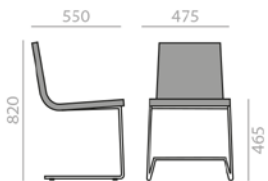

Chair with upholstered seat and backrest and steel oval plate cantilever base finished in polished chrome, white or black.
Silla con carcasa tapizada y base cantilever de pletina ovalada de acero en acabado cromo brillo, blanco o negro.

	COM cm. per unit	COL m2
1 units	200	3,75
10 units or more	100	

- 0,31 m3
- 31,6 kg
- x2

€	COM	COL	1	2	3	4	5	6	7	8	9	10	11	L1	L2	L3	L6
	453	465	479	491	500	515	532	547	562	578	593	609	624	639	694	797	1.066

SO0568

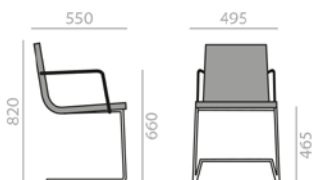

Armchair with upholstered seat and backrest and steel oval plate cantilever base finished in polished chrome, white or black. Option I: Upholstered arms.
Sillón con carcasa tapizada y base cantilever de pletina ovalada de acero en acabado cromo brillo, blanco o negro. Opción de brazos tapizados.

	COM cm. per unit	COL m2
1 units	200	3,75
10 units or more	100	

- 0,3 m3
- 35,6 kg
- x2

€	COM	COL	1	2	3	4	5	6	7	8	9	10	11	L1	L2	L3	L6
	545	556	569	580	589	604	618	634	648	663	677	693	707	721	777	883	1.166



SI0606

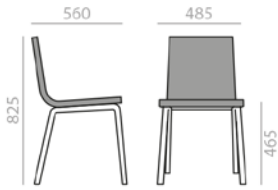

Chair with upholstered seat and backrest and 4-legs solid beech wood base.
Silla con carcasa tapizada y base de 4 patas de madera maciza de haya.

	COM cm. per unit	COL m2
1 units	200	3,75
10 units or more	100	

0,35 m3
 24,4 kg
 x2

COM	COL	1	2	3	4	5	6	7	8	9	10	11	L1	L2	L3	L6
€ 464	475	488	499	508	524	538	553	569	583	597	613	628	641	698	799	1.065

SERIE 600	Matte lacquered and premium upcharge Incremento por lacado mate y premium	32	SERIE 800	Bright lacquered upcharge Incremento por lacado brillo	47
-----------	--	----	-----------	---	----

SO0607

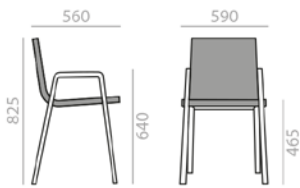

Armchair with upholstered seat and backrest and 4-legs solid beech wood base.
Sillón con carcasa tapizada y base de 4 patas de madera maciza de haya.

	COM cm. per unit	COL m2
1 units	200	3,75
10 units or more	100	

0,29 m3
 14,2 kg
 x1

COM	COL	1	2	3	4	5	6	7	8	9	10	11	L1	L2	L3	L6
€ 513	524	537	548	556	570	584	600	614	627	641	657	671	683	736	831	1.090

SERIE 600	Matte lacquered and premium upcharge Incremento por lacado mate y premium	39	SERIE 800	Bright lacquered upcharge Incremento por lacado brillo	59
-----------	--	----	-----------	---	----

BU0596

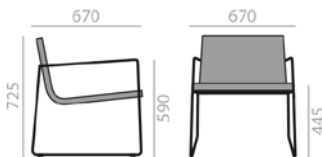

Stackable lounge chair with arms, upholstered seat and backrest and steel sled base finished in polished chrome, white or black. Optional: Upholstered arms.
Butaca con brazos y apilable con carcasa tapizada y base de patín de varilla de acero en acabado cromo brillo, blanco o negro. Opción de brazos tapizados.

	COM cm. per unit	COL m2
1 units	200	5
10 units or more	135	

0,46 m3
 40,2 kg
 x2

6
 6

COM	COL	1	2	3	4	5	6	7	8	9	10	11	L1	L2	L3	L6
€ 566	579	597	612	624	644	667	689	710	734	754	777	798	818	897	1.009	1.378

	Upholstered arm upcharge Incremento brazo tapizado	61
--	---	----

BU0597

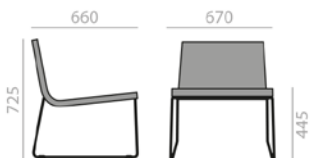

Stackable lounge chair, upholstered seat and backrest and steel sled base finished in polished chrome, white or black.
Butaca apilable con carcasa tapizada y base de patín de varilla de acero en acabado cromo brillo, blanco o negro.

	COM cm. per unit	COL m2
1 units	200	5
10 units or more	135	

0,44 m3
 37,2 kg
 x2

6
 6

COM	COL	1	2	3	4	5	6	7	8	9	10	11	L1	L2	L3	L6
€ 532	548	565	581	592	612	630	650	670	690	709	729	749	766	843	982	1.354

BQ0599

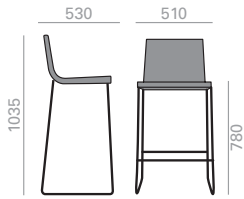

Barstool with upholstered seat and backrest and steel sled base finished in polished chrome, white or black.
 Banqueta alta con carcasa tapizada y base de patín de varilla de acero en acabado cromo brillo, blanco o negro.

	COM cm. per unit	COL m2
1 units	170	3,25
10 units or more	85	

0,32 m3
 12,5 kg
 x1

€	COM	COL	1	2	3	4	5	6	7	8	9	10	11	L1	L2	L3	L6
	391	400	409	417	426	438	451	463	476	481	501	503	514	524	571	654	872

BQ0604

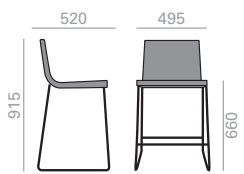

Counter stool with upholstered seat and backrest and steel sled base finished in polished chrome, white or black.
 Banqueta baja con carcasa tapizada y base de patín de varilla de acero en acabado cromo brillo, blanco o negro.

	COM cm. per unit	COL m2
1 units	170	3,25
10 units or more	85	

0,28 m3
 9,9 kg
 x1

€	COM	COL	1	2	3	4	5	6	7	8	9	10	11	L1	L2	L3	L6
	391	400	409	417	426	438	451	463	476	481	501	503	514	524	571	654	872

BQ0608

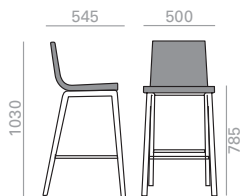

Barstool with upholstered seat and backrest and 4-legs solid beech wood base.
 Banqueta alta con carcasa tapizada y base de 4 patas de madera maciza de haya.

	COM cm. per unit	COL m2
1 units	170	3,25
10 units or more	85	

0,33 m3
 10,2 kg
 x1

€	COM	COL	1	2	3	4	5	6	7	8	9	10	11	L1	L2	L3	L6
	588	597	607	617	624	635	646	658	670	682	693	704	717	726	770	846	1.049

SERIE 600 | Matte lacquered and premium upcharge | Incremento por lacado mate y premium | 47 |

SERIE 800 | Bright lacquered upcharge | Incremento por lacado brillo | 69 |

BQ0609

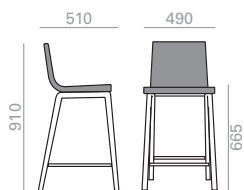

Counter stool with upholstered seat and backrest and 4-legs solid beech wood base.
 Banqueta baja con carcasa tapizada y base de 4 patas de madera maciza de haya.

	COM cm. per unit	COL m2
1 units	170	3,25
10 units or more	85	

0,27 m3
 9,2 kg
 x1

€	COM	COL	1	2	3	4	5	6	7	8	9	10	11	L1	L2	L3	L6
	588	597	607	617	624	635	646	658	670	682	693	704	717	726	770	846	1.049

SERIE 600 | Matte lacquered and premium upcharge | Incremento por lacado mate y premium | 47 |

SERIE 800 | Bright lacquered upcharge | Incremento por lacado brillo | 69 |



Haya
Beech

Measures +- 5 mm.
Medidas +- 5 mm.

BQ0635

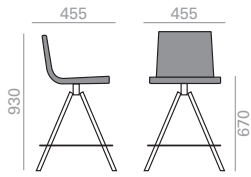

Low barstool with upholstered shell and 4-legs steel tube swivel base finished in polished chrome, white or black.
Banqueta baja con carcasa tapizada y base giratoria de 4 patas de acero y acabado cromo brillo, blanco o negro.

	COM cm. per unit	COL m2
1 units	170	3,25
10 units or more	85	

0,21 m3
 10,4 kg
 x1

€	COM	COL	1	2	3	4	5	6	7	8	9	10	11	L1	L2	L3	L6
	534	544	555	565	574	586	599	612	627	639	652	665	678	691	738	832	1.085

BQ0634

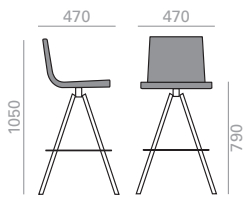

Barstool with upholstered shell and 4-legs steel tube swivel base finished in polished chrome, white or black.
Banqueta alta con carcasa tapizada y base giratoria de 4 patas de acero y acabado cromo brillo, blanco o negro.

	COM cm. per unit	COL m2
1 units	170	3,25
10 units or more	85	

0,32 m3
 10,9 kg
 x1

€	COM	COL	1	2	3	4	5	6	7	8	9	10	11	L1	L2	L3	L6
	534	544	555	565	574	586	599	612	627	639	652	665	678	691	738	832	1.085

BQ0640

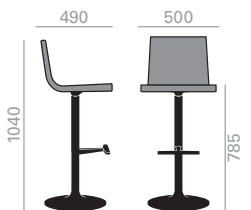

Barstool with upholstered shell and injection swivel central base finished in polished aluminum, white or black.
Banqueta alta con carcasa tapizada y base central giratoria de inyección de aluminio en acabado aluminio pulido, blanco o negro.

	COM cm. per unit	COL m2
1 units	170	3,25
10 units or more	85	

0,35 m3
 12,9 kg
 x1

€	COM	COL	1	2	3	4	5	6	7	8	9	10	11	L1	L2	L3	L6
	549	560	572	583	592	606	620	634	648	662	676	690	704	718	767	860	1.107

BQ0641



Counter stool with upholstered shell and injection swivel central base finished in polished aluminum, white or black.
Banqueta baja con carcasa tapizada y base central giratoria de inyección de aluminio en acabado aluminio pulido, blanco o negro.

	COM cm. per unit	COL m2
1 units	170	3,25
10 units or more	85	

0,25 m3
 12,9 kg
 x1

€	COM	COL	1	2	3	4	5	6	7	8	9	10	11	L1	L2	L3	L6
	549	560	572	583	592	606	620	634	648	662	676	690	704	718	767	860	1.107

BQ0645

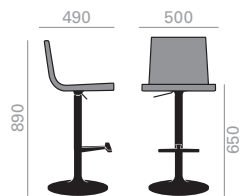

Barstool with upholstered shell and injection swivel central base, adjustable height and finished in polished aluminum, white or black. Seat height range: 650-780 mm.

Banqueta alta con carcasa tapizada y base central giratoria de inyección de aluminio, regulable en altura y acabado aluminio pulido, blanco o negro. Rango de altura de asiento: 650-780 mm.

	COM cm. per unit	COL m2
1 units	170	3,25
10 units or more	85	

0,25 m3
12,9 kg
x1

COM	COL	1	2	3	4	5	6	7	8	9	10	11	L1	L2	L3	L6
€ 547	556	567	576	584	600	613	628	643	657	672	681	687	715	745	840	1.088

Glides for 4 star aluminum central base. Tacos para base central de aluminio de 4 aspas.

Use/Usu	Reference/Referencia	Material/Material	Price/Precio
Hard floors. Suelos duros.	TS0544	Plastic (PE). Plástico (PE).	0 € Standard. Estándar.
Wooden and delicate floors. Suelos de madera y delicados.	TS0556	Plastic (PE) with felt. Plástico (PE) con fieltro.	3 € Set of 4 glides. Juego de 4 tacos.
Mats/carpet floors. Suelos de moqueta/alfombra.	TS0557	No glide. Sin taco.	0 €

The indicated price is for glides placed on chairs. To order loose parts, please ask to our Sales Department.

El precio indicado en Tarifa es para tacos colocados en las sillas. Para pedidos de tacos sueltos de repuesto, consultar con el Departamento Comercial.

Glides for 4 steel legs with swivel base. Tacos para base giratoria de 4 patas de acero.

Use/Usu	Reference/Referencia	Material/Material	Price/Precio
Hard floors and mats/ carpet floors. Suelos duros y moqueta/alfombra.	TS0416	Plastic (PE). Plástico (PE).	0 € Standard. Estándar.
Wooden and delicate floors. Suelos de madera y delicados.	TS0417	Plastic (PE) with felt. Plástico (PE) con fieltro.	12 € Set of 4 glides. Juego de 4 tacos.

Casters. Ruedas.



Standard.
Estándar.

Glides for sled bases/cantilever. Tacos para bases de patín/cantilever.

Use/Usó	Reference/Referencia	Material/Material	Price/Precio
Hard floors. Suelos duros.	TS0531	Plastic (PE). Plástico (PE).	0 € Standard. Estándar.
Wooden and delicated floors. Suelos de madera y delicados.	TS0538	Plastic (PE) with felt. Plástico (PE) con fieltro.	6 € Set of 4 glides. Juego de 4 tacos.
Mats/carpet floors. Suelos de moqueta/ alfombra.	TS0537	No glide. Sin taco.	0 €

The indicated price is for glides placed on chairs. To order loose parts, please ask to our Sales Department.

El precio indicado en Tarifa es para tacos colocados en las sillas. Para pedidos de tacos sueltos de repuesto, consultar con el Departamento Comercial.

For wooden legs. Para bases de madera.



Optional glides on page 482.

Opciones de tacos deslizantes en página 482.

Lineal stackability

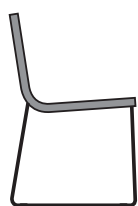

SI0594 AU SOL
6 unités
525 x 835 x 1125 mm.

SUR CHARRIOT
10 unités
560 x 850 x 1260 mm.

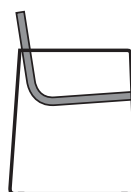

SO0595 AU SOL
6 unités
535 x 835 x 1125 mm.

SUR CHARRIOT
10 unités
560 x 850 x 1260 mm.



BU0597 AU SOL
6 unités
680 x 910 x 1025 mm.

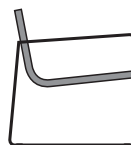

BU0596 AU SOL
6 unités
680 x 910 x 1025 mm.

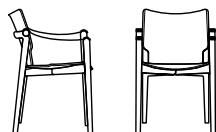

Description
Descripción

Armchair with seat and backrest in oak plywood with solid ash wood structure. Leather armrests available in natural or black finish with metal fastening system in black finish. Option of upholstered seat and back.

Sillón con asiento y respaldo de tablero de roble y estructura de madera maciza de fresno. Brazos de cuero disponible en acabado natural o negro con sistema metálico de fijación en acabado negro. Opción de asiento y respaldo tapizado.

Upholstery
Tapicería

The Luba collection supports following upholsteries of Andreu World Catalogue. For fabrics in our catalogue not specified in this box or customers own materials please contact our Customer Service Department.

La colección Luba admite las siguientes tapicerías del catálogo de Andreu World. Para las telas de nuestro catálogo no indicadas en este cuadro o telas cliente, consultar con nuestro Departamento Comercial.

Fabrics / Telas

- 1** Soft-fiber
Jacquard One
Jacquard Three
Citadel
Sand
Era
Gravity
Rivet
Urban
Reel One (in/out)
Spin One
Spin Two
Spin Three
Spin Four
Spin Five
- 2** Jacquard Two
Solid & Stripes
Loom One
Circular One Pure Eco
Tack One (in/out)

- 3** Jacquard Four
Medley
Revive 1
Natte
Main Line Flax
Loom Two (in/out)
Mezzo
Reel two (in/out)
Jacquard Five
- 4** Jacquard 4 Special
Nexus
Field 2
Remix 3
Heritage
Savane
Loom Three
Loom Four
Cura
Oceanic
Reel Three (in/out)
Reel Four (in/out)
Reflect
Spin Six

- 5** Silk
Synergy
Step
Step Melange
Blazer
Melange Nap
Chili
Noma
Re-wool
- 6** Go check
Swing
Chartres
Zori
Patio
Tack Two (in/out)
Tack Three (in/out)
- 7** Canvas 2
Select
Clara 2
Tack Five (in/out)
Hero 2

- 8** Capture
Fiord 2
Tonus 4
Divina 3
Lopi
Domino
Atrium
- 9** Divina MD
Divina Melange 3
Hallingdal 65
Steelcut Trio 3
Tack Four (in/out)
- 11** Arda
Ecriture
Zero

Faux Leather / Ecopiel

- 1** Valencia
- 2** Silvertex
- 3** Maglia
- 4** Dolce
- 8** Ultraleather
- 9** Brisa
Brisa Distressed
Fresco
Ultraleather Pro
Promessa
- 10** Tottori
Coast (in/out)
- 11** Reef Pro
Volar Bio

Leather / Piel

- L1** High grade cow leather.
Piel de vaca de 1ª categoría.
- L3** Polished full grain leather.
Piena flor pulida.
- L6** Aniline leather batique-effect.
Scandinavian cattle.
Piel anilina efecto batique.
Ganado escandinavo.

Wood finish Ash
Acabado madera
Fresno



Leather finish
Acabado de cuero

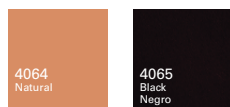

Fixing system finish
Acabado sistema de fijación

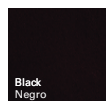

Certificates
Certificados

Fireproof polyurethane foam
Espuma de poliuretano ignífuga

UNE EN 1021:2006
BS 5852 part 2 crib 5
UNI 9175 Classe 1 IM
BKZ 5.2
California TB 117:2013
California TB 133*

*Contact our Customer Department
*Consultar con nuestro Departamento Comercial

Quality - Resistance
Calidad - Resistencia

UNE EN 16139:2013

Intellectual property Propiedad intelectual

All our collections are protected by international industrial design registries, designs patents, copyrights and intellectual Property laws. Unauthorized use of AW International Property is a criminal offence and can lead to prosecution.
Todas nuestras colecciones están protegidas por registros de diseño industrial, diseño de patente, copyright y derechos de propiedad intelectual todo el mundo. El uso no autorizado de los diseños y propiedad intelectual de AW supone un delito que puede ser sometido a acción judicial.



SO0260

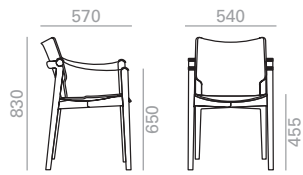

Armchair with seat and backrest in oak plywood with solid ash wood structure. Leather armrests available in natural or black finish with metal fastening system in black finish. Option of upholstered seat and back.

Sillón con asiento y respaldo de tablero de roble y estructura de madera maciza de fresno. Brazos de cuero disponible en acabado natural o negro con sistema metálico de fijación en acabado negro. Opción de asiento y respaldo tapizado.

	COM cm. per unit	COL m2
1 units	100	2
10 units or more	100	

0,39 m3
21 kg
x2

€ 591



Upholstered seat and back
Asiento y respaldo tapizado

COM	COL	1	2	3	4	5	6	7	8	9	10	11	L1	L2	L3	L6
670	682	697	709	719	736	752	767	784	800	816	833	849	864	922	1.028	1.312

SERIE
600

Matte lacquered and premium upcharge
Incremento por lacado mate y premium

39

For wooden legs. Para bases de madera.



Optional glides on page 482.

Opciones de tacos deslizantes en página 482.



Description
Descripción

Stools with seat and 4-legged oak frame with optional upholstered seat. Wide version available. Aluminum leg and footrest connection system in black finish.
Banquetas con asiento y estructura de 4 patas de roble y opción de asiento tapizado. Disponible versión ancha. Sistema de unión de patas y reposapiés de aluminio en acabado negro.

Upholstery
Tapicería

The Maksim collection supports following upholsteries of Andreu World Catalogue. For fabrics in our catalogue not specified in this box or customers own materials please contact our Customer Service Department.
La colección Maksim admite las siguientes tapicerías del catálogo de Andreu World. Para las telas de nuestro catálogo no indicadas en este cuadro o telas cliente, consultar con nuestro Departamento Comercial.

Fabrics / Telas

- 1** Soft-fiber
Jacquard One
Jacquard Three
Citadel
Sand
Era
Gravity
Rivet
Urban
Reel One (in/out)
Spin One
Spin Two
Spin Three
Spin Four
Spin Five
- 2** Jacquard Two
Solid & Stripes
Loom One
Circular One Pure Eco
Tack One (in/out)

- 3** Jacquard Four
Medley
Revive 1
Natte
Main Line Flax
Loom Two (in/out)
Mezzo
Reel two (in/out)
Jacquard Five
- 4** Jacquard 4 Special
Nexus
Field 2
Remix 3
Heritage
Savane
Loom Three
Loom Four
Cura
Oceanic
Reel Three (in/out)
Reel Four (in/out)
Reflect
Spin Six

- 5** Silk
Synergy
Step
Step Melange
Blazer
Melange Nap
Chili
Noma
Re-wool
- 6** Go check
Swing
Chartres
Zori
Patio
Tack Two (in/out)
Tack Three (in/out)
- 7** Canvas 2
Select
Clara 2
Tack Five (in/out)
Hero 2

- 8** Capture
Fiord 2
Tonus 4
Divina 3
Lopi
Domino
Atrium
- 9** Divina MD
Divina Melange 3
Hallingdal 65
Steelcut Trio 3
Tack Four (in/out)
- 11** Arda
Ecriture
Zero

Faux Leather / Ecopiel

- 1** Valencia
2 Silvertex
3 Maglia
4 Dolce
8 Ultraleather
9 Brisa
Brisa Distressed
Fresco
Ultraleather Pro
Promessa
- 10** Tottori
Coast (in/out)
- 11** Reef Pro
Volar Bio

Leather / Piel

- L1** High grade cow leather.
Piel de vaca de 1ª categoría.
- L3** Polished full grain leather.
Plena flor pulida.
- L6** Aniline leather batique-effect.
Scandinavian cattle.
Piel anilina efecto batique.
Ganado escandinavo.

Wood finish Oak
Acabado madera
Roble



Aluminum finish
Acabado aluminio

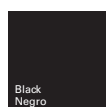

Certificates
Certificados

Fireproof polyurethane foam
Espuma de poliuretano ignifuga

UNE EN 1021:2006
BS 5852 part 2 crib 5
UNI 9175 Classe 1 IM
BKZ 5.2
California TB 117:2013
California TB 133*

*Contact our Customer Department
*Consultar con nuestro Departamento Comercial

Quality - Resistance
Calidad - Resistencia

UNE EN 16139:2013

Intellectual property Propiedad intelectual

All our collections are protected by international industrial design registries, designs patents, copyrights and intellectual Property laws. Unauthorized use of AW International Property is a criminal offence and can lead to prosecution.
Todas nuestras colecciones están protegidas por registros de diseño industrial, diseño de patente, copyright y derechos de propiedad intelectual todo el mundo. El uso no autorizado de los diseños y propiedad intelectual de AW supone un delito que puede ser sometido a acción judicial.



BQ0932



High stool with seat and 4-legged oak structure. Aluminum leg and footrest joining system in black finish. Option of upholstered seat.

Banqueta alta con asiento y estructura de 4 patas de roble. Sistema de unión de patas y reposapiés de aluminio en acabado negro. Opción de asiento tapizado.



	COM cm. per unit	COL m2
1 units	55	1,25
10 units or more	27	

0,17 m3
 13,8 kg
 x1

€ 543

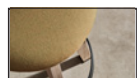

Upholstered seat
Asiento tapizado

COM	COL	1	2	3	4	5	6	7	8	9	10	11	L1	L2	L3	L6
578	579	582	585	587	590	594	597	600	603	606	609	613	615	627	648	704



Matte lacquered and premium upcharge
Incremento por lacado mate y premium

54

BQ0933



Low stool with seat and 4-legged oak structure. Aluminum leg and footrest joining system in black finish. Option of upholstered seat.

Banqueta baja con asiento y estructura de 4 patas de roble. Sistema de unión de patas y reposapiés de aluminio en acabado negro. Opción de asiento tapizado.



	COM cm. per unit	COL m2
1 units	70	1,5
10 units or more	35	

0,13 m3
 13,2 kg
 x1

€ 543

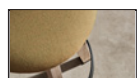

Upholstered seat
Asiento tapizado

COM	COL	1	2	3	4	5	6	7	8	9	10	11	L1	L2	L3	L6
578	579	582	585	587	590	594	597	600	603	606	609	613	615	627	648	704



Matte lacquered and premium upcharge
Incremento por lacado mate y premium

54

BQ0934



High stool with seat and 4-legged oak structure. Aluminum leg and footrest joining system in black finish. Wide version. Option of upholstered seat.

Banqueta alta con asiento y estructura de 4 patas de roble. Sistema de unión de patas y reposapiés de aluminio en acabado negro. Versión ancha. Opción de asiento tapizado.



	COM cm. per unit	COL m2
1 units	55	1,25
10 units or more	27	

0,22 m3
 14,6 kg
 x1

€ 584



Upholstered seat
Asiento tapizado

COM	COL	1	2	3	4	5	6	7	8	9	10	11	L1	L2	L3	L6
619	624	627	631	633	637	642	646	651	655	661	666	670	673	690	719	797



Matte lacquered and premium upcharge
Incremento por lacado mate y premium

54



Roble
Oak

Measures +- 5 mm.
Medidas +- 5 mm.

BQ0935



Low stool with seat and 4-legged oak structure. Aluminum leg and footrest joining system in black finish. Wide version. Option of upholstered seat.

Banqueta baja con asiento y estructura de 4 patas de roble. Sistema de unión de patas y reposapiés de aluminio en acabado negro. Ver sión ancha. Opción de asiento tapizado.



	COM cm. per unit	COL m2
1 units	70	1,5
10 units or more	35	

0,19 m3
 14,1 kg
 x1

€ 584

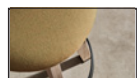

Upholstered seat
Asiento tapizado

COM	COL	1	2	3	4	5	6	7	8	9	10	11	L1	L2	L3	L6
619	624	627	631	633	637	642	646	651	655	661	666	670	673	690	719	797

SERIE
600

Matte lacquered and premium upcharge
Incremento por lacado mate y premium

54 |

For wooden legs. Para bases de madera.



Optional glides on page 482.

Opciones de tacos deslizantes en página 482.

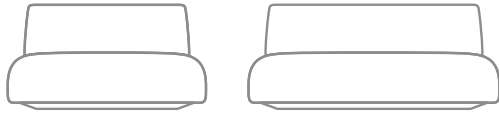

Description
Descripción

1-seater, 2-seater and 3-seater sofas with upholstered seat and back made of flexible foam and thermo-polymer base.
Sofás tapizados de 1, 2, y 3 plazas con asiento y respaldo en espuma flexible y zócalo de termopolímero.

Upholstery
Tapicería

The Manfred collection supports following upholsteries of Andreu World Catalogue. For fabrics in our catalogue not specified in this box or customers own materials please contact our Customer Service Department.

La colección Manfred admite las siguientes tapicerías del catálogo de Andreu World. Para las telas de nuestro catálogo no indicadas en este cuadro o telas cliente, consultar con nuestro Departamento Comercial.

Fabrics / Telas

- 1** Soft-fiber
Jacquard One
Jacquard Three
Citadel
Sand
Era
Gravity
Rivet
Urban
Reel One (in/out)
Spin One
Spin Two
Spin Three
Spin Four
Spin Five
- 2** Jacquard Two
Solid & Stripes
Loom One
Circular One Pure Eco
Tack One (in/out)

- 3** Jacquard Four
Medley
Revive 1
Natte
Main Line Flax
Loom Two (in/out)
Mezzo
Reel two (in/out)
Jacquard Five

- 4** Jacquard 4 Special
Nexus
Field 2
Remix 3
Heritage
Savane
Loom Three
Loom Four
Cura
Oceanic
Reel Three (in/out)
Reel Four (in/out)
Reflect
Spin Six

- 5** Silk
Synergy
Step
Step Melange
Blazer
Melange Nap
Chili
Noma
Re-wool

- 6** Go check
Swing
Chartres
Zori
Patio
Tack Two (in/out)
Tack Three (in/out)

- 7** Canvas 2
Select
Clara 2
Tack Five (in/out)
Hero 2

- 8** Capture
Fiord 2
Tonus 4
Divina 3
Lopi
Domino
Atrium
- 9** Divina MD
Divina Melange 3
Hallingdal 65
Steelcut Trio 3
Tack Four (in/out)

- 11** Arda
Ecriture
Zero

Faux Leather / Ecopiel

- 1** Valencia
2 Silvertex
3 Maglia
4 Dolce
8 Ultraleather
9 Brisa
Brisa Distressed
Fresco
Ultraleather Pro
Promessa
- 10** Tottori
Coast (in/out)
- 11** Reef Pro
Volar Bio

Leather / Piel

- L1** High grade cow leather.
Piel de vaca de 1ª categoría.
- L3** Polished full grain leather.
Piel de vaca pulida.
- L6** Aniline leather batique-effect.
Scandinavian cattle.
Piel anilina efecto batique.
Ganado escandinavo.

Finish perimeter
Acabado zócalo

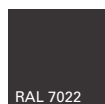

Certificates
Certificados

Fireproof polyurethane foam
Espuma de poliuretano ignífuga

UNE EN 1021:2006
BS 5852 part 2 crib 5
UNI 9175 Classe 1 IM
BKZ 5.2
California TB 117:2013
California TB 133*

*Contact our Customer Department
*Consultar con nuestro Departamento Comercial

Quality - Resistance
Calidad - Resistencia

UNE EN 16139:2013

Intellectual property Propiedad intelectual

All our collections are protected by international industrial design registries, designs patents, copyrights and intellectual Property laws. Unauthorized use of AW International Property is a criminal offence and can lead to prosecution.
Todas nuestras colecciones están protegidas por registros de diseño industrial, diseño de patente, copyright y derechos de propiedad intelectual en todo el mundo. El uso no autorizado de los diseños y propiedad intelectual de AW supone un delito que puede ser sometido a acción judicial.



SF2090

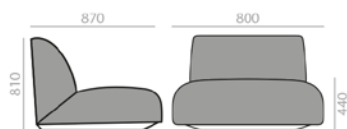

1-seater sofa with upholstered seat and backrest and thermo-polymer base.

Sofá de 1 plaza con asiento y respaldo tapizado y zócalo de termopolímero.

	COM cm. per unit	COL m2
1 units	520	10,2
10 units or more	520	

0,6 m3
 20,5 kg
 x1

€	COM	COL	1	2	3	4	5	6	7	8	9	10	11	L1	L2	L3	L6
	1.151	1.211	1.284	1.342	1.389	1.468	1.547	1.625	1.706	1.784	1.863	1.942	2.021	2.091	2.377	2.898	4.273

SF2091



2-seater sofa with upholstered seat and backrest and wood base.

Sofá de 2 plazas con asiento y respaldo tapizado y zócalo de madera.

	COM cm. per unit	COL m2
1 units	730	14,3
10 units or more	730	

1,25 m3
 57,6 kg
 x1

€	COM	COL	1	2	3	4	5	6	7	8	9	10	11	L1	L2	L3	L6
	1.929	2.001	2.090	2.162	2.217	2.313	2.408	2.505	2.601	2.696	2.792	2.889	2.985	3.070	3.416	4.101	6.021

SF2092

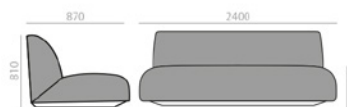

3-seater sofa with upholstered seat and backrest and wood base.

Sofá de 3 plazas con asiento y respaldo tapizado y zócalo de madera.

	COM cm. per unit	COL m2
1 units	1170	22,9
10 units or more	1170	

1,99 m3
 85,5 kg
 x1

€	COM	COL	1	2	3	4	5	6	7	8	9	10	11	L1	L2	L3	L6
	2.462	2.577	2.717	2.829	2.919	3.070	3.222	3.375	3.527	3.679	3.831	3.984	4.136	4.271	4.820	5.848	8.776

For wooden legs. Para bases de madera.



Optional glides on page 482.

Opciones de tacos deslizantes en página 482.

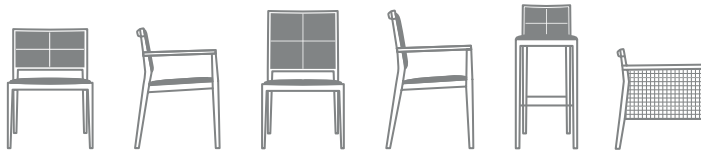

Description
Descripción

A collection of chairs, armchairs and barstools with quilted upholstered seat and backrest and solid beech wood or oak wood frame and arms. The chairs and armchairs are featured in two different heights for the backrest. Stackable versions for chair and armchair are also available.

Sillas, sillones y banqueta con asiento y respaldo tapizados en cruz y estructura y brazos de madera maciza de haya o roble. Las sillas y sillones se ofrecen con dos alturas diferentes de respaldo. Disponibles versiones apilables en silla y sillón.

Upholstery
Tapicería

The Manila collection supports following upholsteries of Andreu World Catalogue. For fabrics in our catalogue not specified in this box or customers own materials please contact our Customer Service Department.

La colección Manila admite las siguientes tapicerías del catálogo de Andreu World. Para las telas de nuestro catálogo no indicadas en este cuadro o telas cliente, consultar con nuestro Departamento Comercial.

Fabrics / Telas

- 1 Soft-fiber
Jacquard One
Jacquard Three
Citadel
Sand
Era
Gravity
Rivet
Urban
Reel One (in/out)
Spin One
Spin Two
Spin Three
Spin Four
Spin Five
- 2 Jacquard Two
Solid & Stripes
Loom One
Circular One Pure Eco
Tack One (in/out)

- 3 Jacquard Four
Medley
Revive 1
Natte
Main Line Flax
Loom Two (in/out)
Mezzo
Reel two (in/out)
Jacquard Five

- 4 Jacquard 4 Special
Nexus
Field 2
Remix 3
Heritage
Savane
Loom Three
Loom Four
Cura
Oceanic
Reel Three (in/out)
Reel Four (in/out)
Reflect
Spin Six

- 5 Silk
Synergy
Step
Step Melange
Blazer
Melange Nap
Chili
Noma
Re-wool

- 6 Go check
Swing
Chartres
Zori
Patio
Tack Two (in/out)
Tack Three (in/out)
Tack Four (in/out)

- 7 Canvas 2
Select
Clara 2
Tack Five (in/out)
Hero 2

- 8 Capture
Fiord 2
Tonus
Divina 3
Lopi
Domino
Atrium
- 9 Divina MD
Divina Melange 3
Hallingdal 65
Steelcut Trio 3
Tack Four (in/out)

- 11 Arda
Ecriture
Zero

Faux Leather / Ecopiel

- 1 Valencia
- 2 Silvertex
- 3 Maglia
- 4 Dolce
- 8 Ultraleather
- 9 Brisa
Brisa Distressed
Fresco
Ultraleather Pro
Promessa
- 10 Tottori
Coast (in/out)
- 11 Reef Pro
Volar Bio

Leather / Piel

- L1 High grade cow leather.
Piel de vaca de 1ª categoría.
- L3 Polished full grain leather.
Plena flor pulida.
- L6 Aniline leather batique-effect.
Scandinavian cattle.
Piel anilina efecto batique.
Ganado escandinavo.

Wood finish Beech
Acabado madera Haya



Premium finish and wood lacquers
Acabado premium y lacas madera



Wood finish Oak
Acabado madera Roble



Premium finish and wood lacquers
Acabado premium y lacas madera

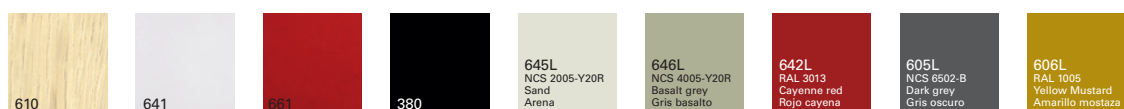

Certificates
Certificados

Fireproof polyurethane foam
Espuma de poliuretano ignifuga

UNE EN 1021:2006
BS 5852 part 2 crib 5
UNI 9175 Classe 1 IM
BKZ 5.2
California TB 117:2013
California TB 133*

Quality - Resistance
Calidad - Resistencia

UNE EN 16139:2013

*Contact our Customer Department
*Consultar con nuestro Departamento Comercial

Intellectual property Propiedad intelectual

All our collections are protected by international industrial design registries, designs patents, copyrights and intellectual Property laws. Unauthorized use of AW International Property is a criminal offence and can lead to prosecution.

Todas nuestras colecciones están protegidas por registros de diseño industrial, diseño de patente, copyright y derechos de propiedad intelectual todo el mundo. El uso no autorizado de los diseños y propiedad intelectual de AW supone un delito que puede ser sometido a acción judicial.



SI2016

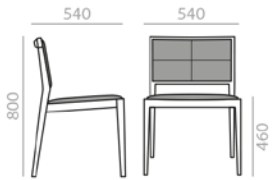

Chair with upholstered seat and backrest and solid beech wood frame. Low back version. Quilted upholstered seat and back. Also available without quilting (please specify).
Silla con asiento y respaldo tapizado y estructura de madera maciza de haya. Versión de respaldo bajo. Asiento y respaldo tapizado en cruz. También disponible sin tapizado en cruz (por favor especificar).

	COM cm. per unit	COL m2
1 units	165	2
10 units or more	83	

0,39 m3
 18 kg
 x2

€	COM	COL	1	2	3	4	5	6	7	8	9	10	11	L1	L2	L3	L6
	389	397	407	415	422	434	445	456	472	479	497	509	520	531	574	654	861

SERIE 600	Matte lacquered and premium upcharge Incremento por lacado mate y premium	39	SERIE 800	Bright lacquered upcharge Incremento por lacado brillo	59
------------------	--	----	------------------	---	----

SO2017

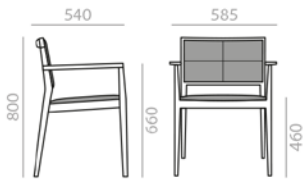

Armchair with upholstered seat and backrest and solid beech wood frame. Low back version. Quilted upholstered seat and back. Also available without quilting (please specify).
Sillón con asiento y respaldo tapizado y estructura de madera maciza de haya. Versión de respaldo bajo. Asiento y respaldo tapizado en cruz. También disponible sin tapizado en cruz (por favor especificar).

	COM cm. per unit	COL m2
1 units	165	2
10 units or more	83	

0,28 m3
 9,8 kg
 x1

€	COM	COL	1	2	3	4	5	6	7	8	9	10	11	L1	L2	L3	L6
	472	480	490	500	505	517	529	541	552	563	582	589	598	616	660	741	952

SERIE 600	Matte lacquered and premium upcharge Incremento por lacado mate y premium	47	SERIE 800	Bright lacquered upcharge Incremento por lacado brillo	69
------------------	--	----	------------------	---	----

SI2130

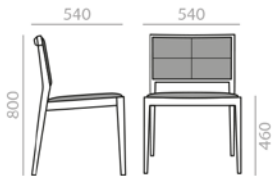

Chair with upholstered seat and backrest and solid oak wood frame. Low back version. Quilted upholstered seat and back. Also available without quilting (please specify).
Silla con asiento y respaldo tapizado y estructura de madera maciza de roble. Versión de respaldo bajo. Asiento y respaldo tapizado en cruz. También disponible sin tapizado en cruz (por favor especificar).

	COM cm. per unit	COL m2
1 units	165	2
10 units or more	83	

0,4 m3
 18 kg
 x2

€	COM	COL	1	2	3	4	5	6	7	8	9	10	11	L1	L2	L3	L6
	437	445	455	463	470	482	493	507	515	533	544	555	569	579	621	700	907

SERIE 600	Matte lacquered and premium upcharge Incremento por lacado mate y premium	39	SERIE 800	Bright lacquered upcharge Incremento por lacado brillo	50
------------------	--	----	------------------	---	----

SO2131

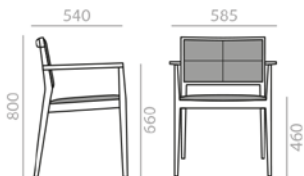

Armchair with upholstered seat and backrest and solid oak wood frame. Low back version. Quilted upholstered seat and back. Also available without quilting (please specify).
Sillón con asiento y respaldo tapizado y estructura de madera maciza de roble. Versión de respaldo bajo. Asiento y respaldo tapizado en cruz. También disponible sin tapizado en cruz (por favor especificar).

	COM cm. per unit	COL m2
1 units	165	2
10 units or more	83	

0,31 m3
 9,8 kg
 x1

€	COM	COL	1	2	3	4	5	6	7	8	9	10	11	L1	L2	L3	L6
	528	536	546	554	561	573	585	596	608	619	630	647	662	671	715	793	1.004

SERIE 600	Matte lacquered and premium upcharge Incremento por lacado mate y premium	47	SERIE 800	Bright lacquered upcharge Incremento por lacado brillo	54
------------------	--	----	------------------	---	----



Measures +- 5 mm.
Medidas +- 5 mm.

SI2023

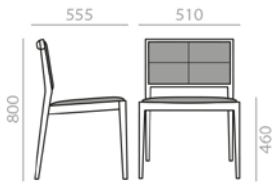

Stackable chair with upholstered seat and backrest and solid beech wood frame. Low back version. Quilted upholstered seat and back. Iso available without quilting (please specify).

Silla apilable con asiento y respaldo tapizado y estructura de madera maciza de haya. Versión de respaldo bajo. Asiento y respaldo tapizado en cruz. También disponible sin tapizado en cruz (por favor especificar).

	COM cm. per unit	COL m2
1 units	165	2
10 units or more	83	

- 0,34 m3
- 16,6 kg
- x2
- 3
- 6

€	COM	COL	1	2	3	4	5	6	7	8	9	10	11	L1	L2	L3	L6
	394	402	412	420	427	439	450	467	472	485	503	516	528	538	582	661	869

SERIE 600	Matte lacquered and premium upcharge Incremento por lacado mate y premium	39	SERIE 800	Bright lacquered upcharge Incremento por lacado brillo	59
-----------	--	----	-----------	---	----

SO2033

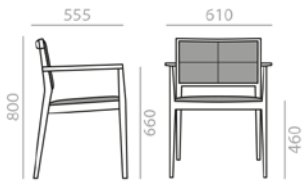

Stackable armchair with upholstered seat and backrest and solid beech wood frame. Low back version. Quilted upholstered seat and bac . Also available without quilting (please specify).

Sillón apilable con asiento y respaldo tapizado y estructura de madera maciza de haya. Versión de respaldo bajo. Asiento y respaldo apizado en cruz. También disponible sin tapizado en cruz (por favor especificar).

	COM cm. per unit	COL m2
1 units	165	2
10 units or more	83	

- 0,38 m3
- 19 kg
- x2
- 3
- 6

€	COM	COL	1	2	3	4	5	6	7	8	9	10	11	L1	L2	L3	L6
	487	495	505	515	520	533	544	555	567	579	590	601	614	624	666	758	973

SERIE 600	Matte lacquered and premium upcharge Incremento por lacado mate y premium	47	SERIE 800	Bright lacquered upcharge Incremento por lacado brillo	69
-----------	--	----	-----------	---	----

SI2106

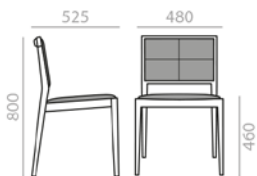

Chair with upholstered seat and backrest and solid beech wood frame. Small version. Quilted upholstered seat and back. Also available without quilting (please specify).

Silla con asiento y respaldo tapizado y estructura de madera maciza de haya. Versión pequeña. Asiento y respaldo tapizado en cruz. También disponible sin tapizado en cruz (por favor especificar).

	COM cm. per unit	COL m2
1 units	145	2
10 units or more	73	

- 0,32 m3
- 16,4 kg
- x2

€	COM	COL	1	2	3	4	5	6	7	8	9	10	11	L1	L2	L3	L6
	382	389	397	405	411	421	431	441	454	461	471	487	496	508	544	615	798

SERIE 600	Matte lacquered and premium upcharge Incremento por lacado mate y premium	39	SERIE 800	Bright lacquered upcharge Incremento por lacado brillo	59
-----------	--	----	-----------	---	----

SO2107

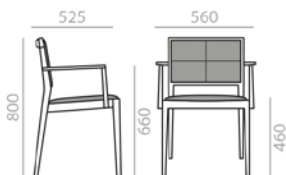

Armchair with upholstered seat and backrest and solid beech wood frame. Small version. Quilted upholstered seat and back. Also available without quilting (please specify).

Sillón con asiento y respaldo tapizado y estructura de madera maciza de haya. Versión pequeña. Asiento y respaldo tapizado en cruz. También disponible sin tapizado en cruz (por favor especificar).

	COM cm. per unit	COL m2
1 units	145	2
10 units or more	73	

- 0,28 m3
- 9,3 kg
- x1

€	COM	COL	1	2	3	4	5	6	7	8	9	10	11	L1	L2	L3	L6
	465	474	482	490	496	506	516	527	545	557	568	581	593	602	644	723	928

SERIE 600	Matte lacquered and premium upcharge Incremento por lacado mate y premium	47	SERIE 800	Bright lacquered upcharge Incremento por lacado brillo	69
-----------	--	----	-----------	---	----



Measures +- 5 mm.
Medidas +- 5 mm.

SI2111

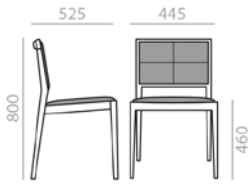

Stackable chair with upholstered seat and backrest and solid beech wood frame. Small version. Quilted upholstered seat and back. Also available without quilting (please specify).

Silla apilable con asiento y respaldo tapizado y estructura de madera maciza de haya. Versión pequeña. Asiento y respaldo tapizado en cruz. También disponible sin tapizado en cruz (por favor especificar).

	COM cm. per unit	COL m2
1 units	150	2
10 units or more	75	

- 0,33 m3
- 16,4 kg
- x2
- 3
- 6

€	COM	COL	1	2	3	4	5	6	7	8	9	10	11	L1	L2	L3	L6
	382	391	399	407	413	424	434	444	455	465	476	492	502	513	552	624	814

SERIE 600	Matte lacquered and premium upcharge Incremento por lacado mate y premium	39	SERIE 800	Bright lacquered upcharge Incremento por lacado brillo	59
------------------	--	----	------------------	---	----

SO2113

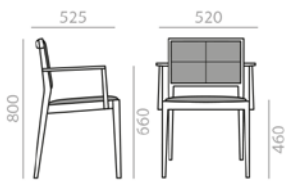

Stackable armchair with upholstered seat and backrest and solid beech wood frame. Small version. Quilted upholstered seat and back. Also available without quilting (please specify).

Sillón apilable con asiento y respaldo tapizado y estructura de madera maciza de haya. Versión pequeña. Asiento y respaldo tapizado en cruz. También disponible sin tapizado en cruz (por favor especificar).

	COM cm. per unit	COL m2
1 units	150	2
10 units or more	75	

- 0,33 m3
- 18,8 kg
- x2
- 3
- 6

€	COM	COL	1	2	3	4	5	6	7	8	9	10	11	L1	L2	L3	L6
	476	483	493	501	508	518	529	539	550	560	584	598	609	620	662	743	956

SERIE 600	Matte lacquered and premium upcharge Incremento por lacado mate y premium	47	SERIE 800	Bright lacquered upcharge Incremento por lacado brillo	69
------------------	--	----	------------------	---	----

BQ2038

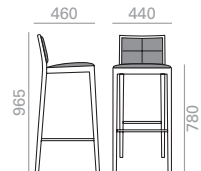

Barstool with upholstered seat and backrest and solid beech wood frame. Quilted upholstered seat and back. Also available without quilting (please specify).

Banqueta alta con asiento y respaldo tapizado y estructura de madera maciza de haya. Asiento y respaldo tapizado en cruz. También disponible sin tapizado en cruz (por favor especificar).

	COM cm. per unit	COL m2
1 units	135	1,5
10 units or more	60	

- 0,24 m3
- 9,1 kg
- x1

€	COM	COL	1	2	3	4	5	6	7	8	9	10	11	L1	L2	L3	L6
	444	451	458	465	471	479	488	496	505	513	522	536	545	553	586	646	809

SERIE 600	Matte lacquered and premium upcharge Incremento por lacado mate y premium	44	SERIE 800	Bright lacquered upcharge Incremento por lacado brillo	65
------------------	--	----	------------------	---	----

BQ2032

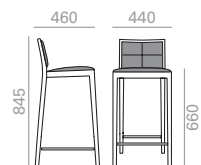

Counter stool with upholstered seat and backrest and solid beech wood frame. Quilted upholstered seat and back. Also available without quilting (please specify).

Banqueta baja con asiento y respaldo tapizado y estructura de madera maciza de haya. Asiento y respaldo tapizado en cruz. También disponibles en tapizado en cruz (por favor especificar).

	COM cm. per unit	COL m2
1 units	135	1,5
10 units or more	60	

- 0,21 m3
- 8,8 kg
- x1

€	COM	COL	1	2	3	4	5	6	7	8	9	10	11	L1	L2	L3	L6
	444	451	458	465	471	479	488	496	505	513	522	536	545	553	586	646	809

SERIE 600	Matte lacquered and premium upcharge Incremento por lacado mate y premium	44	SERIE 800	Bright lacquered upcharge Incremento por lacado brillo	65
------------------	--	----	------------------	---	----



Measures +- 5 mm.
Medidas +- 5 mm.

SO2061

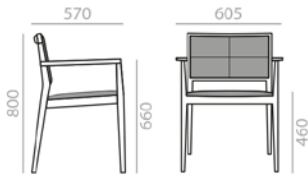

Manila Corporate. Armchair with upholstered seat and backrest and solid beech wood frame. Wider version. Quilted upholstered seat and back. Also available without quilting (please specify).

Manila Corporate. Sillón con asiento y respaldo tapizado y estructura de madera maciza de haya. Versión ancha. Asiento y respaldo tapizado en cruz. También disponible sin tapizado en cruz (por favor especificar).

	COM cm. per unit	COL m2
1 units	170	3,25
10 units or more	85	

0,33 m3
 10 kg
 x1

€	COM	COL	1	2	3	4	5	6	7	8	9	10	11	L1	L2	L3	L6
	493	502	513	523	530	543	555	568	581	593	606	625	638	649	698	782	1.010

SERIE 600	Matte lacquered and premium upcharge Incremento por lacado mate y premium	47	SERIE 800	Bright lacquered upcharge Incremento por lacado brillo	69
-----------	--	----	-----------	---	----

BU2031

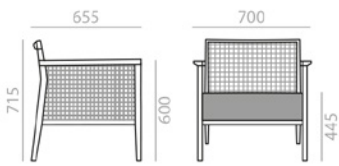

Lounge chair with upholstered seat, wicker backrest and solid beech wood frame.

Butaca con asiento tapizado y respaldo de rejilla y estructura de madera maciza de haya.

	COM cm. per unit	COL m2
1 units	120	2,25
10 units or more	110	

0,37 m3
 12,2 kg
 x1

€	COM	COL	1	2	3	4	5	6	7	8	9	10	11	L1	L2	L3	L6
	973	986	1.001	1.014	1.023	1.040	1.057	1.074	1.091	1.108	1.124	1.141	1.158	1.173	1.234	1.343	1.686

SERIE 600	Matte lacquered and premium upcharge Incremento por lacado mate y premium	54	SERIE 800	Bright lacquered upcharge Incremento por lacado brillo	81
-----------	--	----	-----------	---	----

For wooden legs. Para bases de madera.



Optional glides on page 482.

Opciones de tacos deslizantes en página 482.

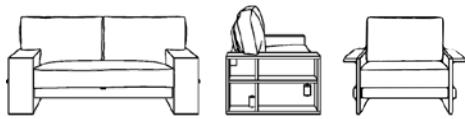

Description
Descripción

Armchairs and sofas with upholstered seat and back and oak wood frame. Auxiliary arm cushion available.
Butacas y sofás con asiento y respaldo tapizado y estructura de madera de roble. Disponible cojín auxiliar para brazo.

Upholstery
Tapicería

The Mariya collection supports following upholsteries of Andreu World Catalogue. For fabrics in our catalogue not specified in this box or customers own materials please contact our Customer Service Department.
La colección Mariya admite las siguientes tapicerías del catálogo de Andreu World. Para las telas de nuestro catálogo no indicadas en este cuadro o telas cliente, consultar con nuestro Departamento Comercial.

Fabrics / Telas

- 1** Soft-fiber
Jacquard One
Jacquard Three
Citadel
Sand
Era
Gravity
Rivet
Urban
Reel One (in/out)
Spin One
Spin Two
Spin Three
Spin Four
Spin Five
- 2** Jacquard Two
Solid & Stripes
Loom One
Circular One Pure Eco
Tack One (in/out)

- 3** Jacquard Four
Medley
Revive 1
Natte
Main Line Flax
Loom Two (in/out)
Mezzo
Reel two (in/out)
Jacquard Five

- 4** Jacquard 4 Special
Nexus
Field 2
Remix 3
Heritage
Savane
Loom Three
Loom Four
Cura
Oceanic
Reel Three (in/out)
Reel Four (in/out)
Reflect
Spin Six

- 5** Silk
Synergy
Step
Step Melange
Blazer
Melange Nap
Chili
Noma
Re-wool

- 6** Go check
Swing
Chartres
Zori
Patio
Tack Two (in/out)
Tack Three (in/out)

- 7** Canvas 2
Select
Clara 2
Tack Five (in/out)
Hero 2

- 8** Capture
Fiord 2
Tonus 4
Divina 3
Lopi
Domino
Atrium
- 9** Divina MD
Divina Melange 3
Hallingdal 65
Steelcut Trio 3
Tack Four (in/out)

- 11** Arda
Ecriture
Zero

Faux Leather / Ecopiel

- 1** Valencia
- 2** Silvertex
- 3** Maglia
- 4** Dolce
- 8** Ultraleather
- 9** Brisa
Brisa Distressed
Fresco
Ultraleather Pro
Promessa
- 10** Tottori
Coast (in/out)
- 11** Reef Pro
Volar Bio

Leather / Piel

- L1** High grade cow leather.
Piel de vaca de 1ª categoría.
- L3** Polished full grain leather.
Plena flor pulida.
- L6** Aniline leather batique-effect.
Scandinavian cattle.
Piel anilina efecto batique.
Ganado escandinavo.

Wood finish Oak
Acabado madera
Roble

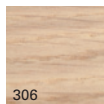

Piping finish
Acabado ribete

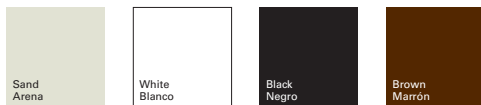

Certificates
Certificados

Fireproof polyurethane foam
Espuma de poliuretano ignifuga

UNE EN 1021:2006
BS 5852 part 2 crib 5
UNI 9175 Classe 1 IM
BKZ 5.2
California TB 117:2013
California TB 133*

*Contact our Customer Department
*Consultar con nuestro Departamento Comercial

Quality - Resistance
Calidad - Resistencia

UNE EN 16139:2013

Intellectual property Propiedad intelectual

All our collections are protected by international industrial design registries, designs patents, copyrights and intellectual Property laws. Unauthorized use of AW International Property is a criminal offence and can lead to prosecution.
Todas nuestras colecciones están protegidas por registros de diseño industrial, diseño de patente, copyright y derechos de propiedad intelectual todo el mundo. El uso no autorizado de los diseños y propiedad intelectual de AW supone un delito que puede ser sometido a acción judicial.



BU2247

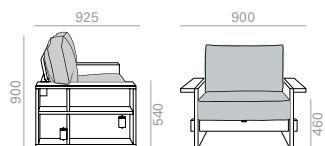

Armchair with upholstered seat and backrest and oak wood structure. Wide version.
Butaca con asiento y respaldo tapizado y estructura de madera de roble. Versión ancha.

	COM cm. per unit	COL m2
1 units	400	8
10 units or more	400	

0,87 m3
 74 kg
 x1

€	COM	COL	1	2	3	4	5	6	7	8	9	10	11	L1	L2	L3	L6
€	2.222	2.255	2.296	2.328	2.354	2.399	2.443	2.487	2.531	2.575	2.619	2.663	2.707	2.746	2.906	3.197	3.964

SF2244

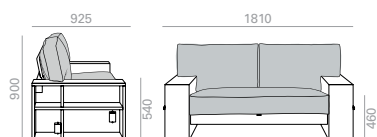

2-seater sofa with upholstered seat and backrest and oak wood structure.
Sofá de 2 plazas con asiento y respaldo tapizado y estructura de madera de roble.

	COM cm. per unit	COL m2
1 units	650	13
10 units or more	650	

1,69 m3
 110 kg
 x1

€	COM	COL	1	2	3	4	5	6	7	8	9	10	11	L1	L2	L3	L6
€	4.774	4.837	4.915	4.977	5.026	5.111	5.195	5.279	5.363	5.447	5.532	5.616	5.700	5.776	6.079	6.634	8.100

SF2245

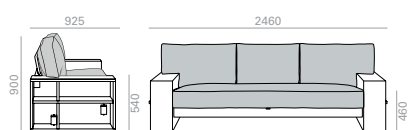

3-seater sofa with upholstered seat and backrest and oak wood structure.
Sofá de 3 plazas con asiento y respaldo tapizado y estructura de madera de roble.

	COM cm. per unit	COL m2
1 units	1000	20
10 units or more	1000	

2,28 m3
 136 kg
 x1

€	COM	COL	1	2	3	4	5	6	7	8	9	10	11	L1	L2	L3	L6
€	5.808	5.905	6.024	6.119	6.195	6.324	6.453	6.582	6.711	6.840	6.969	7.098	7.227	7.342	7.808	8.656	10.903

CJ2246

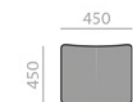

Auxiliary arm cushion.
Cojín auxiliar para brazo.

	COM cm. per unit	COL m2
1 units	100	2
10 units or more	100	

0,02 m3
 2,5 kg
 x1

€	COM	COL	1	2	3	4	5	6	7	8	9	10	11	L1	L2	L3	L6
€	146	157	167	178	185	197	210	222	236	248	260	273	285	297	342	425	646

For wooden legs. Para bases de madera.



Optional glides on page 482.
Opciones de tacos deslizantes en página 482.



Description Side chair with ash wood frame and upholstered seat and back.
Descripción Silla con asiento y respaldo tapizado y estructura de madera maciza de fresno.

Upholstery The Moody collection supports following upholsteries of Andreu World Catalogue. For fabrics in our catalogue not specified in this box or customers own materials please contact our Customer Service Department.
Tapicería La colección Moody admite las siguientes tapicerías del catálogo de Andreu World. Para las telas de nuestro catálogo no indicadas en este cuadro o telas cliente, consultar con nuestro Departamento Comercial.

Fabrics / Telas

- 1** Soft-fiber
Jacquard One
Jacquard Three
Citadel
Sand
Era
Gravity
Rivet
Urban
Reel One (in/out)
Spin One
Spin Two
Spin Three
Spin Four
Spin Five
- 2** Jacquard Two
Solid & Stripes
Loom One
Circular One Pure Eco
Tack One (in/out)

- 3** Jacquard Four
Medley
Revive 1
Natte
Main Line Flax
Loom Two (in/out)
Mezzo
Reel two (in/out)
Jacquard Five
- 4** Jacquard 4 Special
Nexus
Field 2
Remix 3
Heritage
Savane
Loom Three
Loom Four
Cura
Oceanic
Reel Three (in/out)
Reel Four (in/out)
Reflect
Spin Six

- 5** Silk
Synergy
Step
Step Melange
Blazer
Melange Nap
Chili
Noma
Re-wool
- 6** Go check
Swing
Chartres
Zori
Patio
Tack Two (in/out)
Tack Three (in/out)
- 7** Canvas 2
Select
Clara 2
Tack Five (in/out)
Hero 2

- 8** Capture
Fiord 2
Tonus 4
Divina 3
Lopi
Domino
Atrium
- 9** Divina MD
Divina Melange 3
Hallingdal 65
Steelcut Trio 3
Tack Four (in/out)
- 11** Arda
Ecriture
Zero

Faux Leather / Ecopiel

- 1** Valencia
- 2** Silvertex
- 3** Maglia
- 4** Dolce
- 8** Ultraleather
- 9** Brisa
Brisa Distressed
Fresco
Ultraleather Pro
Promessa
- 10** Tottori
Coast (in/out)
- 11** Reef Pro
Volar Bio

Leather / Piel

- L1** High grade cow leather.
Piel de vaca de 1ª categoría.
- L3** Polished full grain leather.
Piena flor pulida.
- L6** Aniline leather batique-effect.
Scandinavian cattle.
Piel anilina efecto batique.
Ganado escandinavo.

Wood finish Ash
Acabado madera
Fresno



Premium finish and wood lacquers
Acabado premium y lacas madera



Certificates **Fireproof polyurethane foam** UNE EN 1021:2006
BS 5852 part 2 crib 5
UNI 9175 Classe 1 IM
BKZ 5.2
California TB 117:2013
California TB 133*
*Contact our Customer Department
*Consultar con nuestro Departamento Comercial

Quality - Resistance UNE EN 16139:2013
Calidad - Resistencia

Intellectual property Propiedad intelectual

All our collections are protected by international industrial design registries, designs patents, copyrights and intellectual Property laws. Unauthorized use of AW International Property is a criminal offence and can lead to prosecution.
 Todas nuestras colecciones están protegidas por registros de diseño industrial, diseño de patente, copyright y derechos de propiedad intelectual todo el mundo. El uso no autorizado de los diseños y propiedad intelectual de AW supone un delito que puede ser sometido a acción judicial.



SI1260

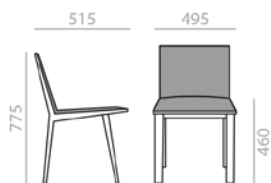

Chair with upholstered seat and backrest and solid ash wood frame.
Silla con asiento y respaldo tapizado y estructura de madera maciza de fresno.

	COM cm. per unit	COL m2
1 units	60	1,25
10 units or more	53	

0,39 m3
 21 kg
 x2

€	COM	COL	1	2	3	4	5	6	7	8	9	10	11	L1	L2	L3	L6
	493	499	504	512	517	526	535	543	552	561	569	577	585	594	625	681	831

SERIE 600	Matte lacquered and premium upcharge Incremento por lacado mate y premium	32
-----------	--	----

Glides. Tacos.

Use/Usu	Reference/Referencia	Material/Material	Price/Precio
Hard floors. Suelos duros.	TS0574	Plastic (PE). Plástico (PE).	0 € Included from orders of 10 units. Incluido a partir de pedidos de 10 unidades.
Wooden and delicated floors. Suelos de madera y delicados.	TS0569	Plastic (PE) with felt. Plástico (PE) con fieltro.	3 € Set of 4 glides. Juego de 4 tacos.

The indicated price is for glides placed on chairs. To order loose parts, please ask to our Sales Department.

El precio indicado en Tarifa es para tacos colocados en las sillas. Para pedidos de repuesto, consultar con el Departamento Comercial.



Description
Descripción

Armchairs with Eco thermo-polymer shell available in several colors or Pure Eco thermo-polymer (100% recycled) available in sand color. The available base options are: steel sled base and polished chrome finish, white or black, 4 legs solid beech wood base, 4-star solid beech wood central swivel base with self-return and height adjustable and central swivel base with 5 casters, all in polished aluminum finish, white or black. Optional fully upholstered shell or seat pad.

Sillones con carcasa de termopolímero Eco disponible en diferentes colores o termopolímero Pure Eco (100% reciclado) disponible en color arena. Las bases disponibles son: patín de varilla de acero y acabado cromo brillo, blanco o negro, 4 patas de madera maciza de haya, base central giratoria de 4 aspas de madera maciza de haya con sistema de retorno y base central giratoria de aluminio con 5 ruedas regulable en altura, ambas en acabado aluminio pulido, blanco o negro. Opción de carcasa tapizada o asiento plafonado.

Upholstery
Tapicería

The Next collection supports following upholsteries of Andreu World Catalogue. All upholstered versions are made with 100% recycled Pure Eco thermo-polymer. For fabrics in our catalogue not specified in this box or customers own materials please contact our Customer Service Department.

La colección Next admite las siguientes tapicerías del catálogo de Andreu World. Todas las versiones tapizadas están hechas con termopolímero Pure Eco 100% reciclado. Para las telas de nuestro catálogo no indicadas en este cuadro o telas cliente, consultar con nuestro Departamento Comercial.

Fabrics / Telas

- 1 Jacquard One
Jacquard Three
Era
Gravity
Urban
Spin One
Spin Two
Spin Three
Spin Four
Spin Five
- 2 Circular One Pure Eco
Tack One (in/out)
- 3 Jacquard Four
Medley
Main Line Flax
Loom Two (in/out)
Mezzo
Reel two (in/out)
Jacquard Five

- 4 Loom Three
Loom Four
Cura
Oceanic
Reel Three (in/out)
Reel Four (in/out)
Reflect
Spin Six
- 5 Silk
Synergy
Step
Step Melange
Blazer
Chili
Noma
Re-wool

- 6 Go check
Swing
Chartres
Zori
Patio
Tack Two (in/out)
Tack Three (in/out)
- 7 Select
Clara 2
Tack Five (in/out)
Hero 2
- 8 Capture
Fiord 2
Tonus 4
Domino
Atrium

- 9 Divina MD
Divina Melange 3
Hallingdal 65
Steelcut Trio 3
Tack Four (in/out)

- 11 Arda
Ecriture
Zero

Faux Leather / Ecopiel

- 1 Valencia
- 2 Silvertex
- 8 Ultraleather
- 9 Brisa
Brisa Distressed
Fresco
Ultraleather Pro
Promessa
- 10 Tottori
Coast (in/out)
- 11 Reef Pro
Volar Bio

Leather / Piel

- L1 High grade cow leather.
Piel de vaca de 1ª categoría.
- L3 Polished full grain leather.
Plena flor pulida.
- L6 Aniline leather batique-effect.
Scandinavian cattle.
Piel anilina efecto batique.
Ganado escandinavo.

Eco Thermo-polymer finish

Acabado de Termo-polímero Eco

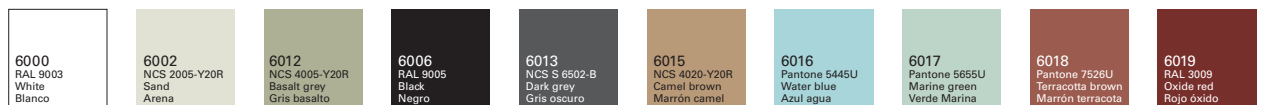

Pure Eco Thermo-polymer finish

Acabado de Termo-polímero Pure Eco



Wood finish Beech

Acabado madera Haya

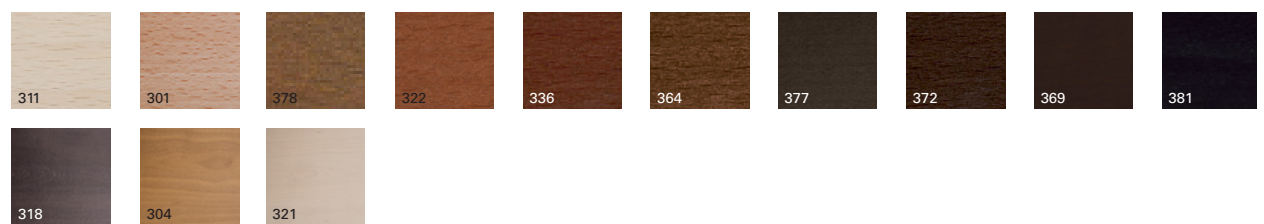

Premium finish and wood lacquers

Acabado premium y lacas madera

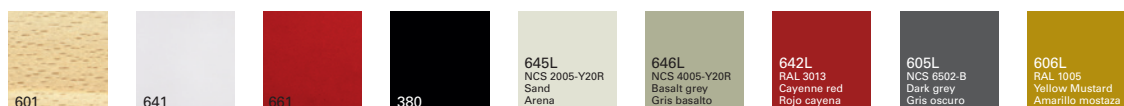

Aluminum finish

Acabado aluminio



Certificates
Certificados

Fireproof polyurethane foam

Espuma de poliuretano ignifuga

UNE EN 1021:2006
BS 5852 part 2 crib 5
UNI 9175 Classe 1 IM
BKZ 5.2
California TB 117:2013
California TB 133*

*Contact our Customer Department
*Consultar con nuestro Departamento Comercial

Quality - Resistance
Calidad - Resistencia

UNE EN 16139:2013

Intellectual property Propiedad intelectual

All our collections are protected by international industrial design registries, designs patents, copyrights and intellectual Property laws. Unauthorized use of AW International Property is a criminal offence and can lead to prosecution.
Todas nuestras colecciones están protegidas por registros de diseño industrial, diseño de patente, copyright y derechos de propiedad intelectual todo el mundo. El uso no autorizado de los diseños y propiedad intelectual de AW supone un delito que puede ser sometido a acción judicial.



SO0495

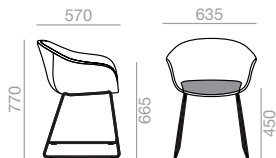

Armchair with Eco thermo-polymer shell available in several colors or Pure Eco thermo-polymer (100% recycled) available in sand color and steel sled base finished in polished chrome, white or black. Optional fully upholstered shell or upholstered seat pad. In upholstered versions the seat height increases 20 mm.

Sillón con carcasa de termopolímero Eco disponible en diferentes colores o termopolímero Pure Eco (100% reciclado) disponible en varios colores y base de patín de varilla de acero en acabado cromo brillo, blanco o negro. Opción de carcasa tapizada o asiento plafonado. En versiones tapizadas la altura de asiento aumenta 20 mm.

COM cm. per unit	COL m2
------------------	--------

0,33 m3
15,1 kg
x1

Fully upholstered Carcasa tapizada		
1 units	180	3,75
10 units or more	180	

Seat pad Asiento plafonado		
1 units	55	1,25
10 units or more	55	

€ TP
197



Thermo-polymer shell
Carcasa termopolímero



Fully upholstered shell
Carcasa tapizada



Upholstered seat pad
Asiento plafonado

COM	COL	1	2	3	4	5	6	7	8	9	10	11	L1	L2	L3	L6
406	420	439	455	466	486	509	532	557	581	605	631	655	677	768	931	1.371

COM	COL	1	2	3	4	5	6	7	8	9	10	11	L1	L2	L3	L6
288	293	298	303	308	313	320	325	332	339	344	351	358	363	385	427	536

SO0496

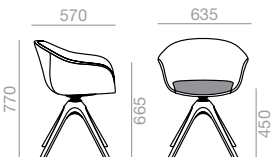

Armchair with Eco thermo-polymer shell available in several colors or Pure Eco thermo-polymer (100% recycled) available in sand color and 4- star solid beech wood swivel base. Optional fully upholstered shell or upholstered seat pad. In upholstered versions the seat height increases 20 mm.

Sillón con carcasa de termopolímero Eco disponible en diferentes colores o termopolímero Pure Eco (100% reciclado) disponible en color arena y base central giratoria de 4 aspas de madera maciza de haya. Opción de carcasa tapizada o asiento plafonado. En versiones tapizadas la altura de asiento aumenta 20 mm.

COM cm. per unit	COL m2
------------------	--------

0,32 m3
14,1 kg
x1

Fully upholstered Carcasa tapizada		
1 units	180	3,75
10 units or more	180	

Seat pad Asiento plafonado		
1 units	55	1,25
10 units or more	55	

€ TP
385



Thermo-polymer shell
Carcasa termopolímero



Fully upholstered shell
Carcasa tapizada



Upholstered seat pad
Asiento plafonado

COM	COL	1	2	3	4	5	6	7	8	9	10	11	L1	L2	L3	L6
600	617	634	650	661	684	709	730	754	779	802	825	850	872	961	1.124	1.598

COM	COL	1	2	3	4	5	6	7	8	9	10	11	L1	L2	L3	L6
483	487	492	497	501	507	513	520	526	532	539	544	551	556	579	619	728

SERIE 600
Matte lacquered and premium upcharge
Incremento por lacado mate y premium

26

SERIE 800
Bright lacquered upcharge
Incremento por lacado brillo

36



Measures +- 5 mm.
Medidas +- 5 mm.

SO0497

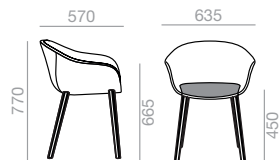

Armchair with Eco thermo-polymer shell available in several colors or Pure Eco thermo-polymer (100% recycled) available in sand color and 4- legs solid beech wood legs. Optional fully upholstered shell or upholstered seat pad. In upholstered versions the seat height increases 20 mm.

Sillón con carcasa de termopolímero Eco disponible en diferentes colores o termopolímero Pure Eco (100% reciclado) disponible en color arena y base de 4 patas de madera maciza de haya. Opción de carcasa tapizada o asiento plafonado. En versiones tapizadas la altura de asiento aumenta 20 mm.

COM cm. per unit	COL m2
------------------	--------

0,32 m3
14,4 kg
x1

Fully upholstered Carcasa tapizada

1 units	180	3,75
10 units or more	180	

Seat pad Asiento plafonado

1 units	55	1,25
10 units or more	55	

€ TP
283



Thermo-polymer shell
Carcasa termopolímero



Fully upholstered shell
Carcasa tapizada



Upholstered seat pad
Asiento plafonado

COM	COL	1	2	3	4	5	6	7	8	9	10	11	L1	L2	L3	L6
496	511	530	546	558	578	599	619	640	662	685	708	733	760	838	992	1.405
COM	COL	1	2	3	4	5	6	7	8	9	10	11	L1	L2	L3	L6
375	379	384	389	393	399	406	412	419	424	431	438	443	450	473	515	626

SERIE 600 Matte lacquered and premium upcharge
Incremento por lacado mate y premium | 17 |

SERIE 800 Bright lacquered upcharge
Incremento por lacado brillo | 24 |

SO0498

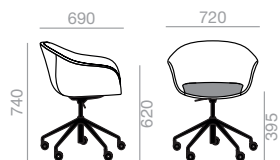

Armchair with Eco thermo-polymer shell available in several colors or Pure Eco thermo-polymer (100% recycled) available in sand color and aluminum central base with 5 casters, swivel and pneumatic height adjustment. Available in polished aluminum, white or black. Optional fully upholstered shell or upholstered seat pad.

Sillón con carcasa de termopolímero Eco disponible en diferentes colores o termopolímero Pure Eco (100% reciclado) disponible en color arena y base central giratoria de aluminio de 5 ruedas, regulable en altura y acabado aluminio pulido blanco o negro. Opción de carcasa tapizada o asiento plafonado.

COM cm. per unit	COL m2
------------------	--------

0,33 m3
14,3 kg
x1

Fully upholstered Carcasa tapizada

1 units	180	3,75
10 units or more	180	

Seat pad Asiento plafonado

1 units	55	1,25
10 units or more	55	

€ TP
367



Thermo-polymer shell
Carcasa termopolímero



Fully upholstered shell
Carcasa tapizada



Upholstered seat pad
Asiento plafonado

COM	COL	1	2	3	4	5	6	7	8	9	10	11	L1	L2	L3	L6
599	619	642	662	676	702	728	753	779	803	831	855	887	903	994	1.170	1.651
COM	COL	1	2	3	4	5	6	7	8	9	10	11	L1	L2	L3	L6
473	479	486	493	497	506	514	523	531	540	548	557	564	572	602	657	801

SO0499

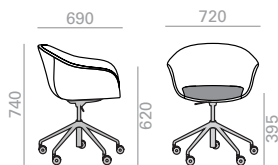

Armchair with Eco thermo-polymer shell available in several colors or Pure Eco thermo-polymer (100% recycled) available in sand color and Eco thermo-polymer central base with 5 casters, swivel and pneumatic height adjustment, finished in black. Optional fully upholstered shell or upholstered seat pad.

Sillón con carcasa de termopolímero Eco disponible en diferentes colores o termopolímero Pure Eco (100% reciclado) disponible en color arena y base central giratoria de termopolímero Eco de 5 ruedas, regulable en altura y acabado negro. Opción de carcasa tapizada o asiento plafonado.

COM cm. per unit	COL m2
---------------------	-----------

0,32 m3
13,3 kg
x1

Fully upholstered Carcasa tapizada

1 units	180	3,75
10 units or more	180	

Seat pad Asiento plafonado

1 units	55	1,25
10 units or more	55	

€



274

Thermo-polymer shell
Carcasa termopolímero



Fully upholstered shell
Carcasa tapizada



Upholstered seat pad
Asiento plafonado

COM	COL	1	2	3	4	5	6	7	8	9	10	11	L1	L2	L3	L6
488	506	529	549	563	589	614	638	664	691	717	743	771	794	892	1.069	1.538
COM	COL	1	2	3	4	5	6	7	8	9	10	11	L1	L2	L3	L6
365	372	379	386	390	399	408	416	425	433	442	451	459	466	498	553	702

Glides for sled bases/cantilever. Tacos para bases de patín/cantilever.

Use/Usó	Reference/Referencia	Material/Material	Price/Precio
Hard floors. Suelos duros.	TS0531	Plastic (PE). Plástico (PE).	0 € Standard. Estándar.
Wooden and delicated floors. Suelos de madera y delicados.	TS0538	Plastic (PE) with felt. Plástico (PE) con fieltro.	6 € Set of 4 glides. Juego de 4 tacos.
Mats/carpet floors. Suelos de moqueta/ alfombra.	TS0537	No glide. Sin taco.	0 €

The indicated price is for glides placed on chairs. To order loose parts, please ask to our Sales Department.

El precio indicado en Tarifa es para tacos colocados en las sillas. Para pedidos de tacos sueltos de repuesto, consultar con el Departamento Comercial.

For wooden legs. Para bases de madera.



Optional glides on page 482.

Opciones de tacos deslizantes en página 482.

Casters. Ruedas.



| Standard. |
| Estándar. |



Description
Descripción

Lounge chairs with upholstered shell. Available in 2 back heights. The available base options are: solid ash wood central swivel base, aluminum swivel 4-star base with self-return and finished in polished aluminum, white or black and 4 solid ash wood base.

Butacas con carcasa tapizada. Disponibles en 2 alturas diferentes de respaldo. Las bases disponibles son: base central giratoria de 4 aspas de madera maciza de fresno, base central giratoria de aluminio de 4 aspas con sistema de retorno disponible en acabado aluminio pulido, blanco o negro y base de 4 patas de madera maciza de fresno. Opción de sistema basculante.

Upholstery
Tapicería

The Next Lounge collection supports following upholsteries of Andreu World Catalogue. All upholstered versions are made with 100% recycled Pure Eco thermo-polymer. For fabrics in our catalogue not specified in this box or customers own materials please contact our Customer Service Department.

La colección Next Lounge admite las siguientes tapicerías del catálogo de Andreu World. Todas las versiones tapizadas están hechas con termopolímero Pure Eco 100% reciclado. Para las telas de nuestro catálogo no indicadas en este cuadro o telas cliente, consultar con nuestro Departamento Comercial.

Fabrics / Telas

- 1 Jacquard One
Jacquard Three
Era
Gravity
Urban
Spin One
Spin Two
Spin Three
Spin Four
Spin Five
- 2 Circular One Pure Eco
Tack One (in/out)
- 3 Jacquard Four
Medley
Main Line Flax
Loom Two (in/out)
Mezzo
Reel two (in/out)
Jacquard Five

- 4 Loom Three
Loom Four
Cura
Oceanic
Reel Three (in/out)
Reel Four (in/out)
Reflect
Spin Six
- 5 Silk
Synergy
Step
Step Melange
Blazer
Chili
Noma
Re-wool

- 6 Go check
Swing
Chartres
Zori
Patio
Tack Two (in/out)
Tack Three (in/out)
- 7 Select
Clara 2
Tack Five (in/out)
Hero 2
- 8 Capture
Fiord 2
Tonus 4
Domino
Atrium

- 9 Divina MD
Divina Melange 3
Hallingdal 65
Steelcut Trio 3
Tack Four (in/out)
- 11 Arda
Ecriture
Zero

Faux Leather / Ecopiel

- 1 Valencia
- 2 Silvertex
- 8 Ultraleather
- 9 Brisa
Brisa Distressed
Fresco
Ultraleather Pro
Promessa
- 10 Tottori
Coast (in/out)
- 11 Reef Pro
Volar Bio

Leather / Piel

- L1 High grade cow leather.
Piel de vaca de 1ª categoría.
- L3 Polished full grain leather.
Piel de vaca pulida.
- L6 Aniline leather batique-effect.
Scandinavian cattle.
Piel anilina efecto batique.
Ganado escandinavo.

Wood finish Ash
Acabado madera
Fresno



Premium finish and wood lacquers
Acabado premium y lacas madera



Aluminum finish
Acabado aluminio



Certificates
Certificados

Fireproof polyurethane foam
Espuma de poliuretano ignifuga

UNE EN 1021:2006
BS 5852 part 2 crib 5
UNI 9175 Classe 1 IM
BKZ 5.2
California TB 117:2013
California TB 133*

Quality - Resistance
Calidad - Resistencia

UNE EN 16139:2013

*Contact our Customer Department
*Consultar con nuestro Departamento Comercial

Intellectual property Propiedad intelectual

All our collections are protected by international industrial design registries, designs patents, copyrights and intellectual Property laws. Unauthorized use of AW International Property is a criminal offence and can lead to prosecution.

Todas nuestras colecciones están protegidas por registros de diseño industrial, diseño de patente, copyright y derechos de propiedad intelectual en todo el mundo. El uso no autorizado de los diseños y propiedad intelectual de AW supone un delito que puede ser sometido a acción judicial.



BU0489

Low back lounge chair with upholstered shell and solid ash wood central swivel base. Additional options include: tilting mechanism.

Butaca de respaldo bajo con carcasa tapizada y base central giratoria de 4 aspas de madera maciza de fresno. Opción de sistema basculante.

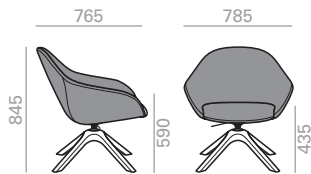

	COM cm. per unit	COL m2
1 units	250	5
10 units or more	250	

0,56 m3
20,38 kg
x1

€	COM	COL	1	2	3	4	5	6	7	8	9	10	11	L1	L2	L3	L6
	984	1.004	1.029	1.050	1.074	1.103	1.131	1.161	1.189	1.218	1.249	1.284	1.319	1.350	1.477	1.725	2.306

SERIE 600 | Matte lacquered and premium upcharge | Incremento por lacado mate y premium | 24 |

 Tilting mechanism upcharge | Incremento por sistema basculante | 42 |

BU0490

Low back lounge chair with upholstered shell and aluminum swivel 4-star base with self-return system and finished in polished aluminum, white or black. Additional options include: tilting mechanism.

Butaca de respaldo bajo con carcasa tapizada y base central giratoria de aluminio de 4 aspas con sistema de retorno disponible en acabado aluminio pulido, blanco o negro. Opción de sistema basculante.

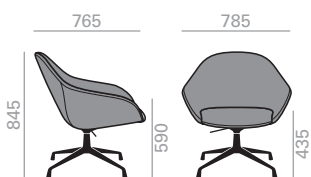

	COM cm. per unit	COL m2
1 units	250	5
10 units or more	250	

0,57 m3
21,82 kg
x1

€	COM	COL	1	2	3	4	5	6	7	8	9	10	11	L1	L2	L3	L6
	811	831	856	877	893	920	946	974	1.000	1.035	1.070	1.105	1.139	1.200	1.307	1.527	2.135

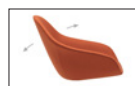
 Tilting mechanism upcharge | Incremento por sistema basculante | 42 |

BU0491

Low back lounge chair with upholstered shell and 4 solid ash wood base.

Butaca de respaldo bajo con carcasa tapizada y base de 4 patas de madera maciza de fresno.

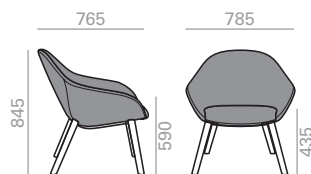

	COM cm. per unit	COL m2
1 units	250	5
10 units or more	250	

0,57 m3
18,74 kg
x1

€	COM	COL	1	2	3	4	5	6	7	8	9	10	11	L1	L2	L3	L6
	847	867	892	913	928	955	982	1.010	1.036	1.064	1.090	1.118	1.144	1.168	1.283	1.514	2.129

SERIE 600 | Matte lacquered and premium upcharge | Incremento por lacado mate y premium | 24 |

BU0492

High back lounge chair with upholstered shell and a solid ash wood central swivel base. Additional options include: tilting mechanism.

Butaca de respaldo alto con carcasa tapizada y base central giratoria de 4 aspas de madera maciza de fresno. Opción de sistema basculante.

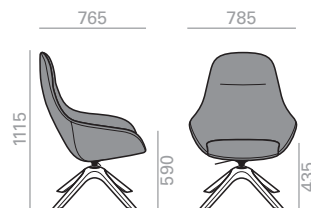

	COM cm. per unit	COL m2
1 units	300	6
10 units or more	300	

0,74 m3
22,4 kg
x1

€	COM	COL	1	2	3	4	5	6	7	8	9	10	11	L1	L2	L3	L6
	1.103	1.130	1.162	1.188	1.215	1.253	1.289	1.337	1.385	1.433	1.519	1.556	1.594	1.628	1.797	2.118	2.964

SERIE 600 | Matte lacquered and premium upcharge | Incremento por lacado mate y premium | 24 |

 Tilting mechanism upcharge | Incremento por sistema basculante | 42 |

BU0493



High back lounge chair with upholstered shell and aluminum swivel 4-star base with self-return system and finished in polished aluminum, white or black. Additional options include: tilting mechanism.

Butaca de respaldo alto con carcasa tapizada y base central giratoria de aluminio de 4 aspas con sistema de retorno disponible en acabado aluminio pulido, blanco o negro. Opción de sistema basculante.

COM cm. per unit	COL m2
---------------------	-----------

0,74 m3
 23,94 kg
 x1

Fully upholstered	Carcasa tapizada	
1 units	300	6
10 units or more	300	

COM	COL	1	2	3	4	5	6	7	8	9	10	11	L1	L2	L3	L6
€ 927	953	985	1.012	1.036	1.073	1.120	1.170	1.250	1.286	1.325	1.368	1.416	1.461	1.641	1.964	2.827

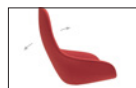

Tilting mechanism
upcharge
Incremento por
sistema basculante

42

BU0494

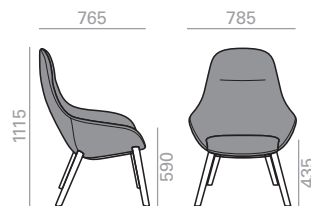

High back lounge chair with upholstered shell and 4 solid ash wood base.

Butaca de respaldo alto con carcasa tapizada y base de 4 patas de madera maciza de fresno.

COM cm. per unit	COL m2
---------------------	-----------

0,74 m3
 20,86 kg
 x1

1 units	300	6
10 units or more	300	

COM	COL	1	2	3	4	5	6	7	8	9	10	11	L1	L2	L3	L6
€ 921	947	977	1.003	1.028	1.064	1.115	1.197	1.232	1.267	1.316	1.367	1.417	1.463	1.644	1.975	2.852

SERIE
600

Matte lacquered and
premium upcharge
Incremento por lacado
mate y premium

24

Glides for central base. Tacos para base central.

Use/Usu	Reference/Referencia		Material/Material	Price/Precio
Hard floors. Suelos duros.	TS0550		Plastic (PE). Plástico (PE).	0 € Standard. Estándar.
Wooden and delicated floors. Suelos de madera y delicados.	TS0551		Plastic (PE) with felt. Plástico (PE) con fieltro.	3 € Set of 4 glides. Juego de 4 tacos.
Mats/carpet floors. Suelos de moqueta/ alfombra.	TS0552		Metal. Metal.	3 €

The indicated price is for glides placed on chairs. To order loose parts, please ask to our Sales Department.
El precio indicado en Tarifa es para tacos colocados en las sillas. Para pedidos de tacos sueltos de repuesto, consultar con el Departamento Comercial.

For wooden legs. Para bases de madera.



Optional glides on page 482.

Opciones de tacos deslizantes en página 482.



Description Stackable side chair with beech wood frame and upholstered seat and back.
Descripción Silla apilable con asiento y respaldo tapizado y estructura y brazos de madera maciza de haya.

Upholstery The Noosa collection supports following upholsteries of Andreu World Catalogue. For fabrics in our catalogue not specified in this box or customers own materials please contact our Customer Service Department.
Tapicería La colección Noosa admite las siguientes tapicerías del catálogo de Andreu World. Para las telas de nuestro catálogo no indicadas en este cuadro o telas cliente, consultar con nuestro Departamento Comercial.

Fabrics / Telas

- 1** Soft-fiber
Jacquard One
Jacquard Three
Citadel
Sand
Era
Gravity
Rivet
Urban
Reel One (in/out)
Spin One
Spin Two
Spin Three
Spin Four
Spin Five
- 2** Jacquard Two
Solid & Stripes
Loom One
Circular One Pure Eco
Tack One (in/out)

- 3** Jacquard Four
Medley
Revive 1
Natte
Main Line Flax
Loom Two (in/out)
Mezzo
Reel two (in/out)
Jacquard Five
- 4** Jacquard 4 Special
Nexus
Field 2
Remix 3
Heritage
Savane
Loom Three
Loom Four
Cura
Oceanic
Reel Three (in/out)
Reel Four (in/out)
Reflect
Spin Six

- 5** Silk
Synergy
Step
Step Melange
Blazer
Melange Nap
Chili
Noma
Re-wool
- 6** Go check
Swing
Chartres
Zori
Patio
Tack Two (in/out)
Tack Three (in/out)
- 7** Canvas 2
Select
Clara 2
Tack Five (in/out)
Hero 2

- 8** Capture
Fiord 2
Tonus 4
Divina 3
Lopi
Domino
Atrium
- 9** Divina MD
Divina Melange 3
Hallingdal 65
Steelcut Trio 3
Tack Four (in/out)
- 11** Arda
Ecriture
Zero

Faux Leather / Ecopiel

- 1** Valencia
- 2** Silvertex
- 3** Maglia
- 4** Dolce
- 8** Ultraleather
- 9** Brisa
Brisa Distressed
Fresco
Ultraleather Pro
Promessa
- 10** Tottori
Coast (in/out)
- 11** Reef Pro
Volar Bio

Leather / Piel

- L1** High grade cow leather.
Piel de vaca de 1ª categoría.
- L3** Polished full grain leather.
Piel de vaca pulida.
- L6** Aniline leather batique-effect.
Scandinavian cattle.
Piel anilina efecto batique.
Ganado escandinavo.

Wood finish Beech
Acabado madera Haya

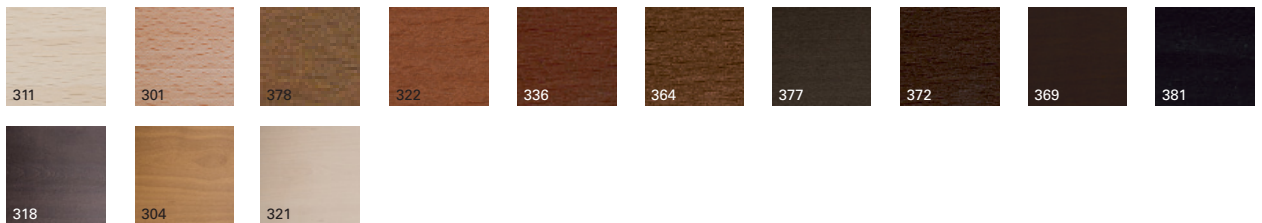

Premium finish and wood lacquers
Acabado premium y lacas madera



Certificates
Certificados

Fireproof polyurethane foam
Espuma de poliuretano ignífuga

UNE EN 1021:2006
BS 5852 part 2 crib 5
UNI 9175 Classe 1 IM
BKZ 5.2
California TB 117:2013
California TB 133*

*Contact our Customer Department
*Consultar con nuestro Departamento Comercial

Quality - Resistance
Calidad - Resistencia

UNE EN 16139:2013

Intellectual property Propiedad intelectual

All our collections are protected by international industrial design registries, designs patents, copyrights and intellectual Property laws. Unauthorized use of AW International Property is a criminal offence and can lead to prosecution.
 Todas nuestras colecciones están protegidas por registros de diseño industrial, diseño de patente, copyright y derechos de propiedad intelectual en todo el mundo. El uso no autorizado de los diseños y propiedad intelectual de AW supone un delito que puede ser sometido a acción judicial.



SI1341

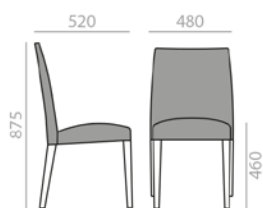

Stackable chair with upholstered seat and backrest and solid beech wood frame.
Silla apilable con asiento y respaldo tapizado y estructura de madera maciza de haya.

	COM cm. per unit	COL m2
1 units	130	2,5
10 units or more	100	

0,38 m3
21,8 kg
x2
4
6

€	COM	COL	1	2	3	4	5	6	7	8	9	10	11	L1	L2	L3	L6
	271	281	292	302	310	322	341	355	369	383	397	412	426	437	488	581	824

SERIE 600	Matte lacquered and premium upcharge Incremento por lacado mate y premium	17	SERIE 800	Bright lacquered upcharge Incremento por lacado brillo	24
-----------	--	----	-----------	---	----

For wooden legs. Para bases de madera.



Optional glides on page 482.
Opciones de tacos deslizantes en página 482.



Description
Descripción

Chairs, armchairs, barstools, lounge chairs, throne, rocker, and benches with solid beech seat and back and different base options: 4 legs solid beech base, steel sled bases or steel rod and beech rocker base, available in polished chrome, black and white, and 4 star central column swivel base with self-return system and available in polished aluminum, black and white. The throne and bench are only available with 4 legs solid beech base. Optional upholstered seat pad and lumbar cushion

Sillas, sillones, banquetas, butacas, trono, balancín y banco con asiento y respaldo de madera maciza de haya y diferentes opciones de bases: base de 4 patas de madera maciza de haya, bases de patín de varilla de acero o de balancín de varilla de acero y madera maciza, disponibles en acabado cromo brillo, negro y blanco, y base central giratoria de 4 aspas de aluminio, con sistema de retorno y disponible en acabado aluminio pulido, negro y blanco. El trono y el banco únicamente disponibles con base de 4 patas de madera maciza de haya. Opción de cojín tapizado. Opción de cojín lumbar.

Upholstery
Tapicería

The Nub collection supports following upholsteries of Andreu World Catalogue. For fabrics in our catalogue not specified in this box or customers own materials please contact our Customer Service Department.

La colección Nub admite las siguientes tapicerías del catálogo de Andreu World. Para las telas de nuestro catálogo no indicadas en este cuadro o telas cliente, consultar con nuestro Departamento Comercial.

Fabrics / Telas

- 1** Soft-fiber
Jacquard One
Jacquard Three
Citadel
Sand
Era
Gravity
Rivet
Urban
Reel One (in/out)
Spin One
Spin Two
Spin Three
Spin Four
Spin Five
- 2** Jacquard Two
Solid & Stripes
Loom One
Circular One Pure Eco
Tack One (in/out)

- 3** Jacquard Four
Medley
Revive 1
Natte
Main Line Flax
Loom Two (in/out)
Mezzo
Reel two (in/out)
Jacquard Five

- 4** Jacquard 4 Special
Nexus
Field 2
Remix 3
Heritage
Savane
Loom Three
Loom Four
Cura
Oceanic
Reel Three (in/out)
Reel Four (in/out)
Reflect
Spin Six

- 5** Silk
Synergy
Step
Step Melange
Blazer
Melange Nap
Chili
Noma
Re-wool
- 6** Go check
Swing
Chartres
Zori
Patio
Tack Two (in/out)
Tack Three (in/out)

- 7** Canvas 2
Select
Clara 2
Tack Five (in/out)
Hero 2

- 8** Capture
Fiord 2
Tonus 4
Divina 3
Lopi
Domino
Atrium
- 9** Divina MD
Divina Melange 3
Hallingdal 65
Steelcut Trio 3
Tack Four (in/out)

- 11** Arda
Ecriture
Zero

Faux Leather / Ecopiel

- 1** Valencia
- 2** Silvertex
- 3** Maglia
- 4** Dolce
- 8** Ultraleather
- 9** Brisa
Brisa Distressed
Fresco
Ultraleather Pro
Promessa
- 10** Tottori
Coast (in/out)
- 11** Reef Pro
Volar Bio

Leather / Piel

- L1** High grade cow leather.
Piel de vaca de 1ª categoría.
- L3** Polished full grain leather.
Piena flor pulida.
- L6** Aniline leather batique-effect.
Scandinavian cattle.
Piel anilina efecto batique.
Ganado escandinavo.

Wood finish Beech
Acabado madera Haya

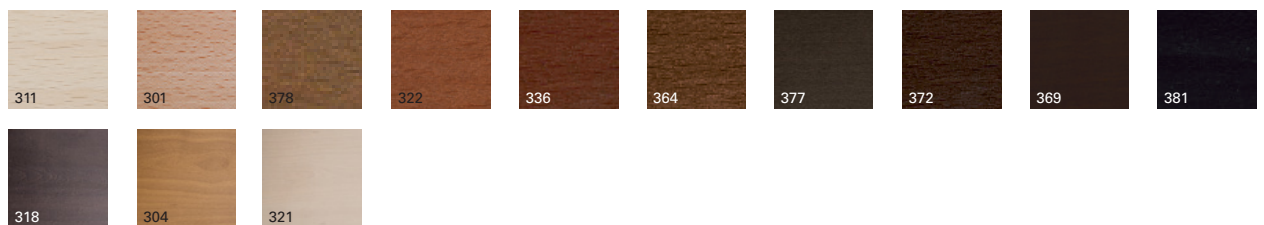

Premium finish and wood lacquers
Acabado premium y lacas madera



Aluminum finish
Acabado aluminio



Steel finish
Acabado de acero



Certificates
Certificados

Fireproof polyurethane foam

Espuma de poliuretano ignifuga

UNE EN 1021:2006
BS 5852 part 2 crib 5
UNI 9175 Classe 1 IM
BKZ 5.2
California TB 117:2013
California TB 133*

*Contact our Customer Department
*Consultar con nuestro Departamento Comercial

Quality - Resistance
Calidad - Resistencia

UNE EN 16139:2013

Intellectual property Propiedad intelectual

All our collections are protected by international industrial design registries, designs patents, copyrights and intellectual Property laws. Unauthorized use of AW International Property is a criminal offence and can lead to prosecution.
Todas nuestras colecciones están protegidas por registros de diseño industrial, diseño de patente, copyright y derechos de propiedad intelectual todo el mundo. El uso no autorizado de los diseños y propiedad intelectual de AW supone un delito que puede ser sometido a acción judicial.



SI1449



Chair with solid beech wood seat and backrest and 4-legs solid beech wood base. Optional removable upholstered seat cushion.
Silla con asiento y respaldo de madera maciza de haya y base de 4 patasde madera maciza de haya. Opción de cojín tapizado en asiento

	COM cm. per unit	COL m2
1 units	55	1,25
10 units or more	33	

0,24 m3
8,6 kg
x1

€	COM	COL	1	2	3	4	5	6	7	8	9	10	11	L1	L2	L3	L6	
	636	733	736	740	744	747	752	756	760	766	770	775	779	785	789	805	837	918

SERIE 600	Matte lacquered and premium upcharge Incremento por lacado mate y premium	65	SERIE 800	Bright lacquered upcharge Incremento por lacado brillo	96
-----------	--	----	-----------	---	----

SI1450



Chair with solid beech wood seat and backrest, removable upholstered seat cushion and steel sled base and finished in polished chrome, white or black.
Silla con asiento y respaldo de madera maciza de haya y base de patín de varilla de acero disponible en acabado cromo brillo, blanco negro. Opción de cojín tapizado en asiento.

	COM cm. per unit	COL m2
1 units	55	1,25
10 units or more	33	

0,24 m3
11,6 kg
x1

€	COM	COL	1	2	3	4	5	6	7	8	9	10	11	L1	L2	L3	L6	
	596	722	727	730	734	737	742	746	751	755	760	764	769	775	778	796	826	907

SERIE 600	Matte lacquered and premium upcharge Incremento por lacado mate y premium	59	SERIE 800	Bright lacquered upcharge Incremento por lacado brillo	87
-----------	--	----	-----------	---	----

SO1434



Armchair with solid beech wood seat and backrest and 4-legs solid beech wood base. Optional removable upholstered seat cushion.
Sillón con asiento y respaldo de madera maciza de haya y base de 4 patas de madera maciza de haya. Opción de cojín tapizado en asiento.

	COM cm. per unit	COL m2
1 units	55	1,25
10 units or more	33	

0,34 m3
10 kg
x1

€	COM	COL	1	2	3	4	5	6	7	8	9	10	11	L1	L2	L3	L6	
	690	803	806	810	814	817	821	827	831	836	841	846	850	855	858	875	907	989

SERIE 600	Matte lacquered and premium upcharge Incremento por lacado mate y premium	68	SERIE 800	Bright lacquered upcharge Incremento por lacado brillo	101
-----------	--	----	-----------	---	-----

SO1435



Armchair with solid beech wood seat and backrest and steel sled base and finished in polished chrome, white or black. Optional removable upholstered seat cushion.
Sillón con asiento y respaldo de madera maciza de haya y base de patín de varilla de acero disponible en acabado cromo brillo, blanco o negro. Opción de cojín tapizado en asiento.

	COM cm. per unit	COL m2
1 units	55	1,25
10 units or more	33	

0,34 m3
13 kg
x1

€	COM	COL	1	2	3	4	5	6	7	8	9	10	11	L1	L2	L3	L6	
	629	720	723	728	732	735	741	746	752	756	762	767	773	779	783	801	837	930

SERIE 600	Matte lacquered and premium upcharge Incremento por lacado mate y premium	62	SERIE 800	Bright lacquered upcharge Incremento por lacado brillo	93
-----------	--	----	-----------	---	----



Haya
Beech

Measures +- 5 mm.
Medidas +- 5 mm.

SO1454

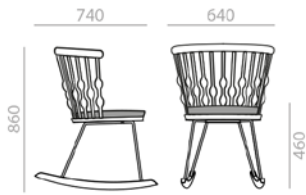

Armchair with solid beech seat and back, removable upholstered seat cushion and steel rod finished in polished chrome, white or black and solid beech rocker base.

Sillón con asiento y respaldo de madera maciza de haya, cojín tapizado en asiento y base de balancín de varilla de acero en acabado cromo brillo, blanco y negro y madera maciza de haya.

	COM cm. per unit	COL m2
1 units	55	1,25
10 units or more	33	

0,49 m3
15 kg
x1

€	COM	COL	1	2	3	4	5	6	7	8	9	10	11	L1	L2	L3	L6	
	788	803	807	810	814	817	821	825	829	833	838	842	846	850	854	869	898	973

SERIE 600	Matte lacquered and premium upcharge Incremento por lacado mate y premium	68	SERIE 800	Bright lacquered upcharge Incremento por lacado brillo	68
-----------	--	----	-----------	---	----

BU1437

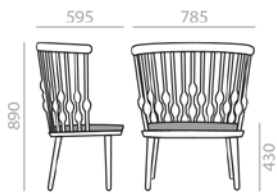

Lounge chair with solid beech wood seat and backrest, removable upholstered seat cushion, and 4-legs solid beech wood base.

Butaca con asiento y respaldo de madera maciza de haya, cojín tapizado en asiento y base de 4 patas de madera maciza de haya.

	COM cm. per unit	COL m2
1 units	70	1,5
10 units or more	45	

0,48 m3
20 kg
x1

€	COM	COL	1	2	3	4	5	6	7	8	9	10	11	L1	L2	L3	L6
	1.009	1.014	1.019	1.024	1.028	1.035	1.041	1.048	1.055	1.061	1.067	1.075	1.081	1.087	1.111	1.154	1.327

SERIE 600	Matte lacquered and premium upcharge Incremento por lacado mate y premium	72	SERIE 800	Bright lacquered upcharge Incremento por lacado brillo	107
-----------	--	----	-----------	---	-----

BU1455

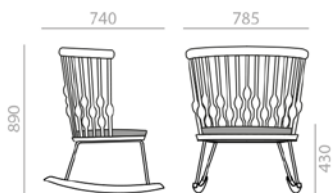

Lounge chair with solid beech seat and back, removable upholstered seat cushion and steel rod finished in polished chrome, white or lack and solid beech rocker base.

Butaca con asiento y respaldo de madera maciza de haya, cojín tapizado en asiento y base de balancín de varilla de acero en acabado romo brillo, blanco y negro y madera maciza de haya.

	COM cm. per unit	COL m2
1 units	70	1,5
10 units or more	45	

0,65 m3
18,3 kg
x1

€	COM	COL	1	2	3	4	5	6	7	8	9	10	11	L1	L2	L3	L6
	1.127	1.132	1.138	1.143	1.148	1.154	1.161	1.168	1.175	1.181	1.189	1.195	1.202	1.208	1.233	1.321	1.442

SERIE 600	Matte lacquered and premium upcharge Incremento por lacado mate y premium	72	SERIE 800	Bright lacquered upcharge Incremento por lacado brillo	72
-----------	--	----	-----------	---	----

BU1440

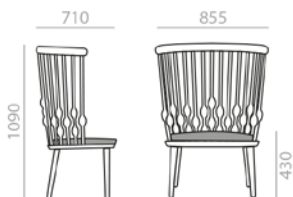

Throne with solid beech wood seat and backrest, upholstered removable seat pad and 4-legs solid beech wood base.

Trono con asiento y respaldo de madera maciza de haya, cojín tapizado en asiento y base de 4 patas de madera maciza de haya.

	COM cm. per unit	COL m2
1 units	70	1,5
10 units or more	45	

0,74 m3
17,9 kg
x1

€	COM	COL	1	2	3	4	5	6	7	8	9	10	11	L1	L2	L3	L6
	1.222	1.227	1.233	1.239	1.243	1.250	1.257	1.264	1.271	1.277	1.285	1.293	1.299	1.305	1.366	1.413	1.533

SERIE 600	Matte lacquered and premium upcharge Incremento por lacado mate y premium	77	SERIE 800	Bright lacquered upcharge Incremento por lacado brillo	116
-----------	--	----	-----------	---	-----

BC1441

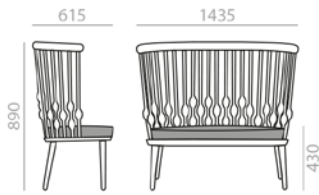

Bench with solid beech wood seat and backrest, fixed upholstered seat pad and 4-legged solid beech wood base.

Banco con asiento y respaldo de madera maciza de haya, cojín tapizado fijo en asiento y base de 4 patas de madera maciza de haya.

	COM cm. per unit	COL m2
1 units	180	3,5
10 units or more	140	

0,95 m3
22 kg
x1

€	COM	COL	1	2	3	4	5	6	7	8	9	10	11	L1	L2	L3	L6
	1.689	1.709	1.735	1.757	1.772	1.800	1.827	1.855	1.883	1.911	1.938	1.966	1.994	2.018	2.118	2.301	2.818

SERIE 600	Matte lacquered and premium upcharge Incremento por lacado mate y premium	93	SERIE 800	Bright lacquered upcharge Incremento por lacado brillo	138
-----------	--	----	-----------	---	-----

BQ1452

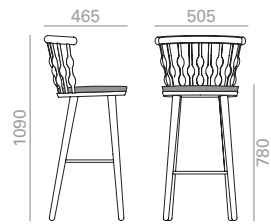

Barstool with solid beech seat and back, upholstered seat pad and 4-legs solid beech wood base.

Banqueta alta con asiento y respaldo de madera maciza de haya, cojín tapizado en asiento y base de 4 patas de madera maciza de haya.

	COM cm. per unit	COL m2
1 units	54	1
10 units or more	35	

0,34 m3
9,1 kg
x1

€	COM	COL	1	2	3	4	5	6	7	8	9	10	11	L1	L2	L3	L6
	744	748	751	755	758	762	766	770	774	778	782	788	792	794	811	838	912

SERIE 600	Matte lacquered and premium upcharge Incremento por lacado mate y premium	60	SERIE 800	Bright lacquered upcharge Incremento por lacado brillo	90
-----------	--	----	-----------	---	----

BQ1453

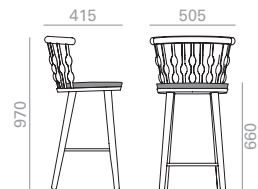

Counter stool with solid beech seat and back, upholstered seat pad and 4-legs solid beech wood base.

Banqueta baja con asiento y respaldo de madera maciza de haya, cojín tapizado en asiento y base de 4 patas de madera maciza de haya.

	COM cm. per unit	COL m2
1 units	54	1
10 units or more	35	

0,31 m3
7,3 kg
x1

€	COM	COL	1	2	3	4	5	6	7	8	9	10	11	L1	L2	L3	L6
	744	748	751	755	758	762	766	770	774	778	782	788	792	794	811	838	912

SERIE 600	Matte lacquered and premium upcharge Incremento por lacado mate y premium	60	SERIE 800	Bright lacquered upcharge Incremento por lacado brillo	90
-----------	--	----	-----------	---	----

CJ1430

Loose cushion for chairs.
Cojín suelto para sillas.



	COM cm. per unit	COL m2
1 units	31	0,75
10 units or more	31	

0,01 m3
0,2 kg
x1

€	COM	COL	1	2	3	4	5	6	7	8	9	10	11	L1	L2	L3	L6
	94	97	102	107	110	114	121	125	131	136	142	147	151	158	176	212	303

CJ1428

Loose cushion for armchairs.
Cojín suelto para sillones.

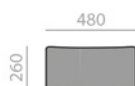

	COM cm. per unit	COL m2
1 units	31	0,75
10 units or more	31	

0,01 m3
 0,3 kg
 x1

	COM	COL	1	2	3	4	5	6	7	8	9	10	11	L1	L2	L3	L6
€	91	94	99	103	106	112	117	123	127	133	138	144	150	154	172	208	301

CJ1429

Loose cushion for lounge chairs.
Cojín suelto para butacas.



	COM cm. per unit	COL m2
1 units	40	0,75
10 units or more	40	

0,01 m3
 0,3 kg
 x1

	COM	COL	1	2	3	4	5	6	7	8	9	10	11	L1	L2	L3	L6
€	96	100	105	110	114	119	125	131	137	143	149	154	160	166	186	225	326

Glides for sled bases/cantilever. Tacos para bases de patín/cantilever.

Use/Usu	Reference/Referencia	Material/Material	Price/Precio
Hard floors. Suelos duros.	TS0531	Plastic (PE). Plástico (PE).	0 € Standard. Estándar.
Wooden and delicated floors. Suelos de madera y delicados.	TS0538	Plastic (PE) with felt. Plástico (PE) con fieltro.	6 € Set of 4 glides. Juego de 4 tacos.
Mats/carpet floors. Suelos de moqueta/ alfombra.	TS0537	No glide. Sin taco.	0 €

The indicated price is for glides placed on chairs. To order loose parts, please ask to our Sales Department.
El precio indicado en Tarifa es para tacos colocados en las sillas. Para pedidos de tacos sueltos de repuesto, consultar con el Departamento Comercial.

Glides for 4 star aluminum central base. Tacos para base central de aluminio de 4 aspas.

Use/Usó	Reference/Referencia	Material/Material	Price/Precio
Hard floors. Suelos duros.	TS0544	Plastic (PE). Plástico (PE).	0 € Standard. Estándar.
Wooden and delicated floors. Suelos de madera y delicados.	TS0556	Plastic (PE) with felt. Plástico (PE) con fieltro.	3 € Set of 4 glides. Juego de 4 tacos.
Mats/carpet floors. Suelos de moqueta/ alfombra.	TS0557	No glide. Sin taco.	0 €

The indicated price is for glides placed on chairs. To order loose parts, please ask to our Sales Department.

El precio indicado en Tarifa es para tacos colocados en las sillas. Para pedidos de tacos sueltos de repuesto, consultar con el Departamento Comercial.

For wooden legs. Para bases de madera.



Optional glides on page 482.

Opciones de tacos deslizantes en página 482.



Description
Descripción

Chairs, armchairs and barstools with Eco thermo-polymer shell available in several colors or Pure Eco thermo-polymer (100% recycled) available in sand color. The available base options are: 4 legs solid ash wood, 4-star solid ash wood central swivel base with self-return and height adjustable, steel oval cantilever base polished chrome finish, white or black, 4-star aluminum central swivel base with self-return or central swivel base with 5 casters, all in polished aluminum finish, white or black. Optional upholstered seat pad or shell pad.

Sillas, sillones y banquetas con carcasa de termopolímero Eco disponible en diferentes colores o termopolímero Pure Eco (100% reciclado) disponible en color arena. Las bases disponibles son: 4 patas de madera maciza de fresno, base central giratoria de 4 aspas de madera maciza de fresno con sistema de retorno, cantiléver de pletina ovalada de acero en acabado cromo brillo, blanco o negro, base central giratoria de aluminio de 4 aspas con sistema de retorno o base central giratoria de aluminio con 5 ruedas regulable en altura, ambas en acabado aluminio pulido, blanco o negro. Opción de asiento plafonado o asiento y respaldo plafonados.

Upholstery
Tapicería

The Nuez Chair collection supports following upholsteries of Andreu World Catalogue. All upholstered versions are made with 100% recycled Pure Eco thermo-polymer. For fabrics in our catalogue not specified in this box or customers own materials please contact our Customer Service Department.

La colección Nuez Chair admite las siguientes tapicerías del catálogo de Andreu World. Todas las versiones tapizadas están hechas con termopolímero Pure Eco 100% reciclado. Para las telas de nuestro catálogo no indicadas en este cuadro o telas cliente, consultar con nuestro Departamento Comercial.

Fabrics / Telas

- 1 Jacquard One
- Jacquard Three
- Citadel
- Sand
- Era
- Gravity
- Rivet
- Urban
- Spin One
- Spin Two
- Spin Three
- Spin Four
- Spin Five

- 2 Jacquard Two
- Loom One
- Circular One Pure Eco
- Tack One (in/out)

- 3 Jacquard Four
- Medley
- Revive 1
- Main Line Flax
- Loom Two (in/out)
- Mezzo
- Reel two (in/out)
- Jacquard Five

- 4 Jacquard 4 Special
- Nexus
- Remix 3
- Heritage
- Savane
- Loom Three
- Loom Four
- Cura
- Oceanic
- Reel Three (in/out)
- Reel Four (in/out)
- Reflect
- Spin Six

- 5 Silk
- Synergy
- Step
- Step Melange
- Blazer
- Melange Nap
- Chili
- Noma
- Re-wool

- 6 Go check
- Swing
- Chartres
- Zori
- Patio
- Tack Two (in/out)
- Tack Three (in/out)

- 7 Canvas 2
- Select
- Clara 2
- Tack Five (in/out)
- Hero 2

- 8 Capture
- Fiord 2
- Tonus 4
- Divina 3
- Lopi
- Domino
- Atrium
- 9 Divina MD
- Divina Melange 3
- Hallingdal 65
- Steelcut Trio 3
- Tack Four (in/out)

- 11 Arda
- Ecriture
- Zero

Faux Leather / Ecopiel

- 1 Valencia
- 2 Silvertex
- 3 Maglia
- 4 Dolce
- 8 Ultraleather

- 9 Brisa
- Brisa Distressed
- Fresco
- Ultraleather Pro
- Promessa

- 10 Tottori
- Coast (in/out)

- 11 Reef Pro
- Volar Bio

Leather / Piel

- L1 High grade cow leather.
- Piel de vaca de 1ª categoría.

- L3 Polished full grain leather.
- Plena flor pulida.

- L6 Aniline leather batique-effect.
- Scandinavian cattle.
- Piel anilina efecto batique.
- Ganado escandinavo.

Eco Thermo-polymer finish

Acabado de Termopolímero Eco

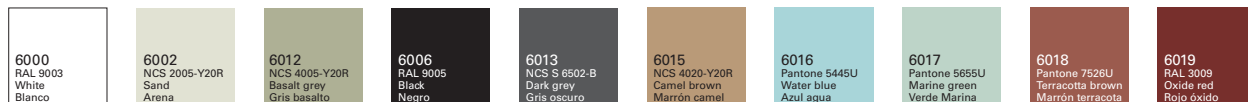

Pure Eco Thermo-polymer finish

Acabado de Termopolímero Pure Eco



Wood finish Ash

Acabado madera Fresno



Premium finish and wood lacquers

Acabado premium y lacas madera



Steel finish

Acabado de acero



Aluminum finish

Acabado aluminio



Certificates
Certificados

Fireproof polyurethane foam

Espuma de poliuretano ignifuga

UNE EN 1021:2006
BS 5852 part 2 crib 5
UNI 9175 Classe 1 IM
BKZ 5.2
California TB 117:2013
California TB 133*

*Contact our Customer Department
*Consultar con nuestro Departamento Comercial

Quality - Resistance
Calidad - Resistencia

UNE EN 16139:2013

Intellectual property Propiedad intelectual

All our collections are protected by international industrial design registries, designs patents, copyrights and intellectual Property laws. Unauthorized use of AW International Property is a criminal offence and can lead to prosecution.

Todas nuestras colecciones están protegidas por registros de diseño industrial, diseño de patente, copyright y derechos de propiedad intelectual todo el mundo. El uso no autorizado de los diseños y propiedad intelectual de AW supone un delito que puede ser sometido a acción judicial.



SO2770

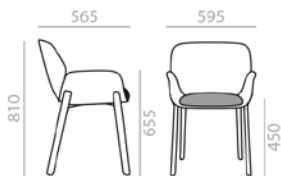

Armchair with Eco thermo-polymer shell available in several colors or Pure Eco thermo-polymer (100% recycled) available in sand color and 4- legs solid ash wood base. Optional upholstered pad or upholstered shell pad. In upholstered versions the seat height increases 20 mm.

Sillón con carcasa de termopolímero Eco disponible en diferentes colores o termopolímero Pure Eco (100% reciclado) disponible en color arena y base de 4 patas de madera maciza de fresno. Opción de asiento plafonado o asiento y respaldo plafonado. En versiones tapizadas la altura de asiento aumenta 20 mm.

COM cm. per unit	COL m2
------------------	--------

0,3 m3
10,4 kg
x1

Seat pad Asiento plafonado

1 units	60	1
10 units or more	30	

Shell pad Asiento y respaldo plafonado

1 units	120	2,75
10 units or more	110	



TP
290

Thermo-polymer shell
Carcasa termopolímero



COM	COL	1	2	3	4	5	6	7	8	9	10	11	L1	L2	L3	L6
399	402	405	409	411	415	419	423	428	431	435	439	443	446	462	487	558

Upholstered seat pad
Asiento plafonado



COM	COL	1	2	3	4	5	6	7	8	9	10	11	L1	L2	L3	L6
577	588	602	614	623	638	653	669	685	701	716	731	747	760	816	918	1.186

Upholstered shell pad
Asiento y respaldo plafonado



Matte lacquered and premium upcharge
Incremento por lacado mate y premium

17

SO2771

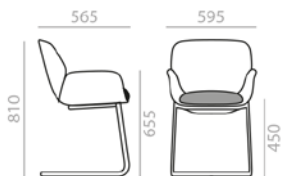

Armchair with Eco thermo-polymer shell available in several colors or Pure Eco thermo-polymer (100% recycled) available in sand color and steel oval cantilever base finished in polished chrome, white or black. Optional upholstered seat pad or upholstered shell pad. In upholstered versions the seat height increases 20 mm.

Sillón con carcasa de termopolímero Eco disponible en diferentes colores o termopolímero Pure Eco (100% reciclado) disponible en color arena y base cantiléver de pletina ovalada de acero en acabado cromo brillo, blanco o negro. Opción de asiento plafonado o asiento y respaldo plafonado. En versiones tapizadas la altura de asiento aumenta 20 mm.

COM cm. per unit	COL m2
------------------	--------

0,28 m3
13,5 kg
x1

Seat pad Asiento plafonado

1 units	60	1
10 units or more	30	

Shell pad Asiento y respaldo plafonado

1 units	120	2,75
10 units or more	110	



TP
289

Thermo-polymer shell
Carcasa termopolímero



COM	COL	1	2	3	4	5	6	7	8	9	10	11	L1	L2	L3	L6
392	395	398	401	404	406	411	415	418	422	425	429	432	436	449	471	534

Upholstered seat pad
Asiento plafonado



COM	COL	1	2	3	4	5	6	7	8	9	10	11	L1	L2	L3	L6
610	621	635	647	656	671	686	701	717	732	747	762	778	790	845	945	1.209

Upholstered shell pad
Asiento y respaldo plafonado

SO2772



Armchair with Eco thermo-polymer shell available in several colors or Pure Eco thermo-polymer (100% recycled) available in sand color and aluminum swivel 4-star base with self-return system and finished in polished aluminum, white or black. Optional upholstered seat pad or upholstered shell pad. In upholstered versions the seat height increases 20 mm.

Sillón con carcasa de termopolímero Eco disponible en diferentes colores o termopolímero Pure Eco (100% reciclado) disponible en color arena y base central giratoria de aluminio de 4 aspas con sistema de retorno en acabado aluminio pulido, blanco o negro. Opción de asiento plafonado o asiento y respaldo plafonado. En versiones tapizadas la altura de asiento aumenta 20 mm.

COM cm. per unit	COL m2
------------------	--------

- 0,3 m3
- 11,6 kg
- x1

Seat pad Asiento plafonado

1 units	60	1
10 units or more	30	

Shell pad Asiento y respaldo plafonado

1 units	120	2,75
10 units or more	110	



Thermo-polymer shell
Carcasa termopolímero



Upholstered seat pad
Asiento plafonado

COM	COL	1	2	3	4	5	6	7	8	9	10	11	L1	L2	L3	L6
473	476	479	483	485	489	493	497	501	506	510	514	518	522	536	564	635



Upholstered shell pad
Asiento y respaldo plafonado

COM	COL	1	2	3	4	5	6	7	8	9	10	11	L1	L2	L3	L6
652	664	678	691	699	715	731	746	762	778	793	809	824	839	896	999	1.279

SO2783

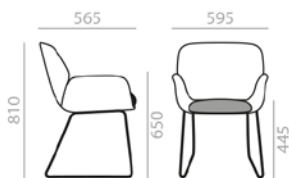

Armchair with Eco thermo-polymer shell available in several colors or Pure Eco thermo-polymer (100% recycled) available in sand color and steel sled base finished in polished chrome, white or black. Optional upholstered seat pad or upholstered shell pad. In upholstered versions the seat height increases 20 mm.

Sillón con carcasa de termopolímero Eco disponible en diferentes colores o termopolímero Pure Eco (100% reciclado) disponible en color arena y base de patín de acero en acabado cromo brillo, blanco o negro. Opción de asiento plafonado o asiento y respaldo plafonado. En versiones tapizadas la altura de asiento aumenta 20 mm.

COM cm. per unit	COL m2
------------------	--------

- 0,29 m3
- 12,5 kg
- x1

Seat pad Asiento plafonado

1 units	60	1
10 units or more	30	

Shell pad Asiento y respaldo plafonado

1 units	120	2,75
10 units or more	110	



Thermo-polymer shell
Carcasa termopolímero



Upholstered seat pad
Asiento plafonado

COM	COL	1	2	3	4	5	6	7	8	9	10	11	L1	L2	L3	L6
300	303	306	309	312	314	318	323	325	329	332	336	340	343	356	379	441



Upholstered shell pad
Asiento y respaldo plafonado

COM	COL	1	2	3	4	5	6	7	8	9	10	11	L1	L2	L3	L6
506	518	531	543	552	567	581	598	613	627	642	657	673	687	742	841	1.105

SO2773

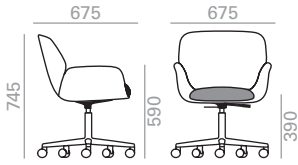

Armchair with Eco thermo-polymer shell available in several colors or Pure Eco thermo-polymer (100% recycled) available in sand color and aluminum central base with 5 casters, swivel and pneumatic height adjustment. Available in polished aluminum, white or black. Optional upholstered seat pad or upholstered shell pad. Height ranges: seat 390-510 mm./arms 590-710 mm. In upholstered versions the seat height increases 20 mm.

Sillón con carcasa de termopolímero Eco disponible en diferentes colores o termopolímero Pure Eco (100% reciclado) disponible en color arena y base central giratoria con 5 ruedas regulable en altura en acabado aluminio pulido, blanco o negro. Opción de asiento plafonado o asiento y respaldo plafonado. Rangos de altura: asiento 390-510 mm./brazos 590-710 mm. En versiones tapizadas la altura de asiento aumenta 20 mm.

COM cm. per unit	COL m2
------------------	--------

0,33 m3

12,6 kg

x1

Seat pad Asiento plafonado

1 units	60	1
10 units or more	30	

Shell pad Asiento y respaldo plafonado

1 units	120	2,75
10 units or more	110	

€  TP
404

Thermo-polymer shell
Carcasa termopolímero

 COM COL 1 2 3 4 5 6 7 8 9 10 11 L1 L2 L3 L6
510 514 517 521 524 528 533 537 541 547 551 555 560 564 579 609 689

Upholstered seat pad
Asiento plafonado

 COM COL 1 2 3 4 5 6 7 8 9 10 11 L1 L2 L3 L6
686 699 714 726 736 753 771 787 804 820 837 853 870 885 945 1.055 1.345

Upholstered shell pad
Asiento y respaldo plafonado

SO2740

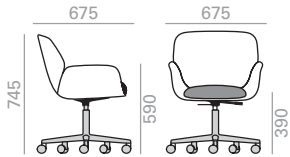

Armchair with Eco thermo-polymer shell available in several colors or Pure Eco thermo-polymer (100% recycled) available in sand color and Eco thermo-polymer central base with 5 casters, swivel and pneumatic height adjustment, finished in black. Optional upholstered seat pad or upholstered shell pad. Height ranges: seat 390-510 mm./arms 590-710 mm. In upholstered versions the seat height increases 20 mm.

Sillón con carcasa de termopolímero Eco disponible en diferentes colores o termopolímero Pure Eco (100% reciclado) disponible en color arena y base central giratoria de termopolímero Eco de 5 ruedas, regulable en altura y acabado negro. Opción de asiento plafonado o asiento y respaldo plafonado. Rangos de altura: asiento 390-510 mm./brazos 590-710 mm. En versiones tapizadas la altura de asiento aumenta 20 mm.

COM cm. per unit	COL m2
------------------	--------

0,31 m3

11,6 kg

x1

Seat pad Asiento plafonado

1 units	60	1
10 units or more	30	

Shell pad Asiento y respaldo plafonado

1 units	120	2,75
10 units or more	110	

€  302

Thermo-polymer shell
Carcasa termopolímero

 COM COL 1 2 3 4 5 6 7 8 9 10 11 L1 L2 L3 L6
407 411 414 418 421 425 430 434 438 443 447 453 457 461 477 505 584

Upholstered seat pad
Asiento plafonado

 COM COL 1 2 3 4 5 6 7 8 9 10 11 L1 L2 L3 L6
554 565 580 592 602 618 632 648 664 680 696 712 728 741 798 903 1.177

Upholstered shell pad
Asiento y respaldo plafonado

SO2774



Armchair with Eco thermo-polymer shell available in several colors or Pure Eco thermo-polymer (100% recycled) available in sand color and 4- star solid ash wood central swivel base with self-return system. Optional upholstered seat pad or upholstered shell pad. In upholstered versions the seat height increases 20 mm.

Sillón con carcasa de termopolímero Eco disponible en diferentes colores o termopolímero Pure Eco (100% reciclado) disponible en color arena y base central giratoria de 4 aspas de madera maciza de fresno con sistema de retorno. Opción de asiento plafonado o asiento y respaldo plafonado. En versiones tapizadas la altura de asiento aumenta 20 mm.

COM cm. per unit	COL m2
------------------	--------

0,31 m3

10,8 kg

x1

Seat pad Asiento plafonado

1 units	60	1
10 units or more	30	

Shell pad Asiento y respaldo plafonado

1 units	120	2,75
10 units or more	110	

€

TP	414
----	-----



Thermo-polymer shell
Carcasa termopolímero



Upholstered seat pad
Asiento plafonado

COM	COL	1	2	3	4	5	6	7	8	9	10	11	L1	L2	L3	L6
522	525	528	532	534	538	542	546	551	555	559	563	567	570	586	613	684



Upholstered shell pad
Asiento y respaldo plafonado

COM	COL	1	2	3	4	5	6	7	8	9	10	11	L1	L2	L3	L6
731	744	758	771	781	796	813	829	846	861	878	894	911	925	983	1.091	1.374



SERIE
600

Matte lacquered and premium upcharge
Incremento por lacado mate y premium

26

SI2784



Chair Eco thermo-polymer shell available in several colors or Pure Eco thermo-polymer (100% recycled) available in sand color and 4-legs solid ash wood base. Optional upholstered seat pad or shell pad. In upholstered versions the seat height increases 20 mm.

Silla con carcasa de termopolímero Eco disponible en diferentes colores o termopolímero Pure Eco (100% reciclado) disponible en color arena y base de 4 patas de madera maciza de fresno. Opción de asiento plafonado o asiento y respaldo plafonados. En versiones tapizadas la altura de asiento aumenta 20 mm.

COM cm. per unit	COL m2
------------------	--------

0,28 m3

10,8 kg

x1

Seat pad Asiento plafonado

1 units	60	1
10 units or more	30	

Shell pad Asiento y respaldo plafonado

1 units	100	1,25
10 units or more	80	

€

TP	269
----	-----



Thermo-polymer shell
Carcasa termopolímero



Upholstered seat pad
Asiento plafonado

COM	COL	1	2	3	4	5	6	7	8	9	10	11	L1	L2	L3	L6
362	365	368	371	373	378	380	384	389	391	395	400	402	406	419	443	507



Upholstered shell pad
Asiento y respaldo plafonado

COM	COL	1	2	3	4	5	6	7	8	9	10	11	L1	L2	L3	L6
515	523	532	541	547	558	568	579	590	600	611	622	633	641	681	751	944



SERIE
600

Matte lacquered and premium upcharge
Incremento por lacado mate y premium

26

SI2785

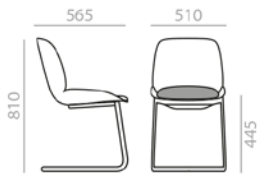

Chair Eco thermo-polymer shell available in several colors or Pure Eco thermo-polymer (100% recycled) available in sand color and steel oval cantilever base polished chrome finish, white or black. Optional upholstered seat pad or shell pad. In upholstered versions the seat height increases 20 mm.

Silla con carcasa de termopolímero Eco disponible en diferentes colores o termopolímero Pure Eco (100% reciclado) disponible en color arena y base cantiléver de pletina ovalada de acero en acabado cromo brillo, blanco o negro. Opción de asiento plafonado o asiento y respaldo plafonados. En versiones tapizadas la altura de asiento aumenta 20 mm.

COM cm. per unit	COL m2
------------------	--------

0,25 m3

12 kg

x1

Seat pad Asiento plafonado

1 units	60	1
10 units or more	30	

Shell pad Asiento y respaldo plafonado

1 units	100	1,25
10 units or more	80	

€  TP
282

Thermo-polymer shell
Carcasa termopolímero



Upholstered seat pad
Asiento plafonado

COM	COL	1	2	3	4	5	6	7	8	9	10	11	L1	L2	L3	L6
376	379	382	386	388	392	396	400	404	409	413	416	420	424	438	465	535



Upholstered shell pad
Asiento y respaldo plafonado

COM	COL	1	2	3	4	5	6	7	8	9	10	11	L1	L2	L3	L6
541	550	560	569	576	588	600	612	624	636	648	660	671	682	723	802	1.015

SI2786



Chair Eco thermo-polymer shell available in several colors or Pure Eco thermo-polymer (100% recycled) available in sand color and aluminum swivel 4-star base with self-return system and finished in polished aluminum, white or black. Optional upholstered seat pad or shell pad. In upholstered versions the seat height increases 20 mm.

Silla con carcasa de termopolímero Eco disponible en diferentes colores o termopolímero Pure Eco (100% reciclado) disponible en color arena y base central giratoria de aluminio de 4 aspas con sistema de retorno en acabado aluminio pulido, blanco o negro. Opción de asiento plafonado o asiento y respaldo plafonados. En versiones tapizadas la altura de asiento aumenta 20 mm.

COM cm. per unit	COL m2
------------------	--------

0,29 m3

13 kg

x1

Seat pad Asiento plafonado

1 units	60	1
10 units or more	30	

Shell pad Asiento y respaldo plafonado

1 units	100	1,25
10 units or more	80	

€  TP
334

Thermo-polymer shell
Carcasa termopolímero



Upholstered seat pad
Asiento plafonado

COM	COL	1	2	3	4	5	6	7	8	9	10	11	L1	L2	L3	L6
442	445	448	452	454	458	462	466	471	475	479	483	488	492	506	534	607



Upholstered shell pad
Asiento y respaldo plafonado

COM	COL	1	2	3	4	5	6	7	8	9	10	11	L1	L2	L3	L6
585	594	604	613	620	631	643	656	667	678	690	701	713	723	766	842	1.055

SI2787



Chair Eco thermo-polymer shell available in several colors or Pure Eco thermo-polymer (100% recycled) available in sand color and steel sled base polished chrome finish, white or black. Optional upholstered seat pad or shell pad. In upholstered versions the seat height increases 20 mm.

Silla con carcasa de termopolímero Eco disponible en diferentes colores o termopolímero Pure Eco (100% reciclado) disponible en color arena y base de patín de acero en acabado cromo brillo, blanco o negro. Opción de asiento plafonado o asiento y respaldo plafonados. En versiones tapizadas la altura de asiento aumenta 20 mm.

COM cm. per unit	COL m2
------------------	--------

0,26 m3

11,1 kg

x1

Seat pad Asiento plafonado

1 units	60	1
10 units or more	30	

Shell pad Asiento y respaldo plafonado

1 units	100	1,25
10 units or more	80	



Thermo-polymer shell
Carcasa termopolímero



Upholstered seat pad
Asiento plafonado

COM	COL	1	2	3	4	5	6	7	8	9	10	11	L1	L2	L3	L6
266	268	271	274	276	279	283	286	290	292	296	299	303	306	317	339	397



Upholstered shell pad
Asiento y respaldo plafonado

COM	COL	1	2	3	4	5	6	7	8	9	10	11	L1	L2	L3	L6
428	435	444	453	459	469	480	490	500	511	521	532	542	551	588	661	859

SI2788

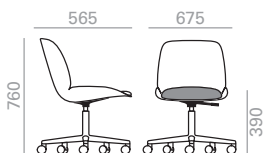

Chair with Eco thermo-polymer shell available in several colors or Pure Eco thermo-polymer (100% recycled) available in sand color and aluminum central base with 5 casters, swivel and pneumatic height adjustment. Finished in polished aluminum, white or black. Optional upholstered seat pad or shell pad. In upholstered versions the seat height increases 20 mm.

Silla con carcasa de termopolímero Eco disponible en diferentes colores o termopolímero Pure Eco (100% reciclado) disponible en color arena y base central giratoria de aluminio con 5 ruedas regulable en altura en acabado aluminio pulido, blanco o negro. Opción de asiento plafonado o asiento y respaldo plafonados. En versiones tapizadas la altura de asiento aumenta 20 mm.

COM cm. per unit	COL m2
------------------	--------

0,28 m3

10,7 kg

x1

Seat pad Asiento plafonado

1 units	60	1
10 units or more	30	

Shell pad Asiento y respaldo plafonado

1 units	100	1,25
10 units or more	80	



Thermo-polymer shell
Carcasa termopolímero



Upholstered seat pad
Asiento plafonado

COM	COL	1	2	3	4	5	6	7	8	9	10	11	L1	L2	L3	L6
475	478	482	486	489	493	498	502	506	512	516	520	525	529	545	575	653



Upholstered shell pad
Asiento y respaldo plafonado

COM	COL	1	2	3	4	5	6	7	8	9	10	11	L1	L2	L3	L6
622	631	642	652	659	672	683	696	708	721	733	745	758	769	813	895	1.109

SI2741



Chair with Eco thermo-polymer shell available in several colors or Pure Eco thermo-polymer (100% recycled) available in sand color and Eco thermo-polymer central base with 5 casters, swivel and pneumatic height adjustment, finished in black. Optional upholstered seat pad or upholstered shell pad. Seat height range: 390-510 mm. In upholstered versions the seat height increases 20 mm.

Silla con carcasa de termopolímero Eco disponible en diferentes colores o termopolímero Pure Eco (100% reciclado) disponible en color arena y base central giratoria de termopolímero Eco de 5 ruedas, regulable en altura y acabado negro. Opción de asiento plafonado o asiento y respaldo plafonado. Rango de altura de asiento: 390-510 mm. En versiones tapizadas la altura de asiento aumenta 20 mm.

COM cm. per unit	COL m2
------------------	--------

0,3 m3
9,7 kg
x1

Seat pad Asiento plafonado

1 units	60	1
10 units or more	30	

Shell pad Asiento y respaldo plafonado

1 units	120	2,75
10 units or more	110	



Upholstered seat pad
Asiento plafonado

COM	COL	1	2	3	4	5	6	7	8	9	10	11	L1	L2	L3	L6
381	385	388	392	395	399	404	408	412	417	421	425	429	434	449	478	553



Upholstered shell pad
Asiento y respaldo plafonado

COM	COL	1	2	3	4	5	6	7	8	9	10	11	L1	L2	L3	L6
490	499	509	518	525	535	547	558	570	580	592	603	615	624	664	738	934

SI2789



Chair with Eco thermo-polymer shell available in several colors or Pure Eco thermo-polymer (100% recycled) available in sand color and 4-star solid ash wood central swivel base with self-return system. Optional upholstered seat pad or shell pad. In upholstered versions the seat height increases 20 mm.

Silla con carcasa de termopolímero Eco disponible en diferentes colores o termopolímero Pure Eco (100% reciclado) disponible en color arena y base central giratoria de 4 aspas de madera maciza de fresno con sistema de retorno. Opción de cojín auxiliar en asiento. En versiones tapizadas la altura de asiento aumenta 20 mm.

COM cm. per unit	COL m2
------------------	--------

0,26 m3
10,6 kg
x1

Seat pad Asiento plafonado

1 units	60	1
10 units or more	30	

Shell pad Asiento y respaldo plafonado

1 units	100	1,25
10 units or more	80	



Upholstered seat pad
Asiento plafonado

COM	COL	1	2	3	4	5	6	7	8	9	10	11	L1	L2	L3	L6
496	498	501	505	507	511	515	519	523	527	530	534	538	542	556	582	649



Upholstered shell pad
Asiento y respaldo plafonado

COM	COL	1	2	3	4	5	6	7	8	9	10	11	L1	L2	L3	L6
662	671	681	690	697	707	719	731	743	754	764	776	788	798	839	914	1.112

SERIE 600
Matte lacquered and premium upcharge
Incremento por lacado mate y premium

26



Measures +- 5 mm.
Medidas +- 5 mm.

BQ2775



Barstool Eco thermo-polymer shell available in several colors or Pure Eco thermo-polymer (100% recycled) available in sand color and 4-legs solid ash wood base. Optional upholstered seat pad or upholstered shell pad. In upholstered versions the seat height increases 20 mm.

Banqueta alta con carcasa de termopolímero Eco disponible en diferentes colores o termopolímero Pure Eco (100% reciclado) disponible en color arena y base de 4 patas de madera maciza de fresno. Opción de asiento plafonado y respaldo plafonado. En versiones tapizadas la altura de asiento aumenta 20 mm.

COM cm. per unit	COL m2
------------------	--------

0,28 m3
11,4 kg
x1

Seat pad Asiento plafonado

1 units	55	0,75
10 units or more	30	

Shell pad Asiento y respaldo plafonado

1 units	90	1
10 units or more	70	

€  TP
437

Thermo-polymer shell
Carcasa termopolímero

	COM	COL	1	2	3	4	5	6	7	8	9	10	11	L1	L2	L3	L6
	515	517	520	523	525	528	532	535	539	542	546	548	552	555	567	590	650

Upholstered seat pad
Asiento plafonado

	COM	COL	1	2	3	4	5	6	7	8	9	10	11	L1	L2	L3	L6
	620	625	632	639	643	651	660	668	676	685	693	701	710	717	747	816	1.003

Upholstered shell pad
Asiento y respaldo plafonado

SERIE 600 | Matte lacquered and premium upcharge | Incremento por lacado mate y premium | 26 |

BQ2776

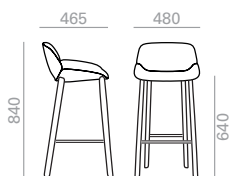

Counter stool Eco thermo-polymer shell available in several colors or Pure Eco thermo-polymer (100% recycled) available in sand color and 4-legs solid ash wood base. Optional upholstered seat pad or upholstered shell pad. In upholstered versions the seat height increases 20 mm.

Banqueta baja con carcasa de termopolímero Eco disponible en diferentes colores o termopolímero Pure Eco (100% reciclado) disponible en color arena y base de 4 patas de madera maciza de fresno. Opción de Asiento plafonado o asiento y respaldo plafonado. En versiones tapizadas la altura de asiento aumenta 20 mm.

COM cm. per unit	COL m2
------------------	--------

0,26 m3
11 kg
x1

Seat pad Asiento plafonado

1 units	55	0,75
10 units or more	30	

Shell pad Asiento y respaldo plafonado

1 units	90	1
10 units or more	70	

€  TP
437

Thermo-polymer shell
Carcasa termopolímero

	COM	COL	1	2	3	4	5	6	7	8	9	10	11	L1	L2	L3	L6
	515	517	520	523	525	528	532	535	539	542	546	548	552	555	567	590	650

Upholstered seat pad
Asiento plafonado

	COM	COL	1	2	3	4	5	6	7	8	9	10	11	L1	L2	L3	L6
	620	625	632	639	643	651	660	668	676	685	693	701	710	717	747	816	1.003

Upholstered shell pad
Asiento y respaldo plafonado

SERIE 600 | Matte lacquered and premium upcharge | Incremento por lacado mate y premium | 26 |

BQ2777

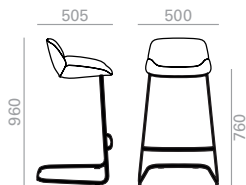

Barstool Eco thermo-polymer shell available in several colors or Pure Eco thermo-polymer (100% recycled) available in sand color and steel oval cantilever base finished in polished chrome, white or black. Optional upholstered seat pad or upholstered shell pad. In upholstered versions the seat height increases 20 mm.

Banqueta alta con carcasa de termopolímero Eco disponible en diferentes colores o termopolímero Pure Eco (100% reciclado) disponible en color arena y base cantiléver de pletina ovalada de acero en acabado cromo brillo, blanco o negro. Opción de asiento plafonado o asiento y respaldo plafonado. En versiones tapizadas la altura de asiento aumenta 20 mm.

COM cm. per unit	COL m2
------------------	--------

0,28 m3
12,5 kg
x1

Seat pad Asiento plafonado

1 units	55	0,75
10 units or more	30	

Shell pad Asiento y respaldo plafonado

1 units	90	1
10 units or more	70	



TP
299

Thermo-polymer shell
Carcasa termopolímero



Upholstered seat pad
Asiento plafonado

COM	COL	1	2	3	4	5	6	7	8	9	10	11	L1	L2	L3	L6
374	376	379	382	384	387	391	394	398	400	403	407	410	412	424	445	505



Upholstered shell pad
Asiento y respaldo plafonado

COM	COL	1	2	3	4	5	6	7	8	9	10	11	L1	L2	L3	L6
548	555	562	569	575	584	594	602	611	620	630	639	647	656	689	754	956

BQ2778

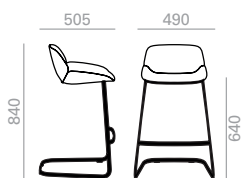

Counter stool Eco thermo-polymer shell available in several colors or Pure Eco thermo-polymer (100% recycled) available in sand color and steel oval cantilever base finished in polished chrome, white or black. Optional upholstered seat pad or upholstered shell pad. In upholstered versions the seat height increases 20 mm.

Banqueta baja con carcasa de termopolímero Eco disponible en diferentes colores o termopolímero Pure Eco (100% reciclado) disponible en color arena y base cantiléver de pletina ovalada de acero en acabado cromo brillo, blanco o negro. Opción de asiento plafonado o asiento y respaldo plafonado. En versiones tapizadas la altura de asiento aumenta 20 mm.

COM cm. per unit	COL m2
------------------	--------

0,23 m3
11,5 kg
x1

Seat pad Asiento plafonado

1 units	55	0,75
10 units or more	30	

Shell pad Asiento y respaldo plafonado

1 units	90	1
10 units or more	70	



TP
299

Thermo-polymer shell
Carcasa termopolímero



Upholstered seat pad
Asiento plafonado

COM	COL	1	2	3	4	5	6	7	8	9	10	11	L1	L2	L3	L6
374	376	379	382	384	387	391	394	398	400	403	407	410	412	424	445	505



Upholstered shell pad
Asiento y respaldo plafonado

COM	COL	1	2	3	4	5	6	7	8	9	10	11	L1	L2	L3	L6
548	555	562	569	575	584	594	602	611	620	630	639	647	656	689	754	956

BQ2781

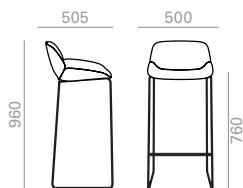

Barstool Eco thermo-polymer shell available in several colors or Pure Eco thermo-polymer (100% recycled) available in sand color and steel sled base finished in polished chrome, white or black. Optional upholstered seat pad or upholstered shell pad. In upholstered versions the seat height increases 20 mm.

Banqueta alta con carcasa de termopolímero Eco disponible en diferentes colores o termopolímero Pure Eco (100% reciclado) disponible en color arena y base de patín de acero en acabado cromo brillo, blanco o negro. Opción de asiento plafonado o asiento y respaldo plafonado. En versiones tapizadas la altura de asiento aumenta 20 mm.

COM cm. per unit	COL m2
------------------	--------

0,28 m3

12,5 kg

x1

Seat pad Asiento plafonado

1 units	55	0,75
10 units or more	30	

Shell pad Asiento y respaldo plafonado

1 units	90	1
10 units or more	70	



Thermo-polymer shell
Carcasa termopolímero



Upholstered seat pad
Asiento plafonado

COM	COL	1	2	3	4	5	6	7	8	9	10	11	L1	L2	L3	L6
356	358	361	365	366	371	375	379	382	386	390	394	397	401	414	439	506



Upholstered shell pad
Asiento y respaldo plafonado

COM	COL	1	2	3	4	5	6	7	8	9	10	11	L1	L2	L3	L6
503	510	519	526	532	543	553	562	572	583	593	602	612	621	657	722	915

BQ2782

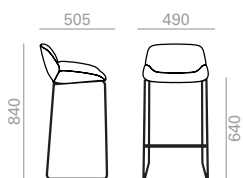

Counter stool with thermo-polymer seat and steel sled base finished in polished chrome, white or black. Optional upholstered seat pad or upholstered shell pad. In upholstered versions the seat height increases 20 mm.

Banqueta baja con carcasa de termopolímero Eco disponible en diferentes colores o termopolímero Pure Eco (100% reciclado) disponible en color arena y base de patín de acero en acabado cromo brillo, blanco o negro. Opción de asiento plafonado o asiento y respaldo plafonado. En versiones tapizadas la altura de asiento aumenta 20 mm.

COM cm. per unit	COL m2
------------------	--------

0,23 m3

11,5 kg

x1

Seat pad Asiento plafonado

1 units	55	0,75
10 units or more	30	

Shell pad Asiento y respaldo plafonado

1 units	90	1
10 units or more	70	



Thermo-polymer shell
Carcasa termopolímero



Upholstered seat pad
Asiento plafonado

COM	COL	1	2	3	4	5	6	7	8	9	10	11	L1	L2	L3	L6
356	358	361	365	366	371	375	379	382	386	390	394	397	401	414	439	506



Upholstered shell pad
Asiento y respaldo plafonado

COM	COL	1	2	3	4	5	6	7	8	9	10	11	L1	L2	L3	L6
503	510	519	526	532	543	553	562	572	583	593	602	612	621	657	722	915

BQ2779



Barstool Eco thermo-polymer shell available in several colors or Pure Eco thermo-polymer (100% recycled) available in sand color and 4-star solid ash wood central swivel base with self-return system. Optional upholstered seat pad or upholstered shell pad. In upholstered versions the seat height increases 20 mm.

Banqueta alta con carcasa de termopolímero Eco disponible en diferentes colores o termopolímero Pure Eco (100% reciclado) disponible en color arena y base central giratoria de 4 aspas de madera maciza de fresno con sistema de retorno. Opción de asiento plafonado o asiento y respaldo plafonado. En versiones tapizadas la altura de asiento aumenta 20 mm.

COM cm. per unit	COL m2
------------------	--------

0,26 m3

11,5 kg

x1

Seat pad Asiento plafonado

1 units	55	0,75
10 units or more	30	

Shell pad Asiento y respaldo plafonado

1 units	90	1
10 units or more	70	

€  TP
448

Thermo-polymer shell
Carcasa termopolímero



Upholstered seat pad
Asiento plafonado

COM	COL	1	2	3	4	5	6	7	8	9	10	11	L1	L2	L3	L6
550	552	555	559	560	565	569	571	575	579	583	586	590	594	606	631	696



Upholstered shell pad
Asiento y respaldo plafonado

COM	COL	1	2	3	4	5	6	7	8	9	10	11	L1	L2	L3	L6
726	733	742	749	755	766	775	785	794	805	815	824	835	842	878	942	1.114



SERIE
600

Matte lacquered and premium upcharge
Incremento por lacado mate y premium

26

BQ2780



Counter stool Eco thermo-polymer shell available in several colors or Pure Eco thermo-polymer (100% recycled) available in sand color and 4-star solid ash wood central swivel base with self-return system. Optional upholstered seat pad or upholstered shell pad. In upholstered versions the seat height increases 20 mm.

Banqueta baja con carcasa de termopolímero Eco disponible en diferentes colores o termopolímero Pure Eco (100% reciclado) disponible en color arena y base central giratoria de 4 aspas de madera maciza de fresno con sistema de retorno. Opción de asiento plafonado o asiento y respaldo plafonado. En versiones tapizadas la altura de asiento aumenta 20 mm.

COM cm. per unit	COL m2
------------------	--------

0,18 m3

11 kg

x1

Seat pad Asiento plafonado

1 units	55	1,25
10 units or more	30	

Shell pad Asiento y respaldo plafonado

1 units	90	1
10 units or more	70	

€  TP
448

Thermo-polymer shell
Carcasa termopolímero



Upholstered seat pad
Asiento plafonado

COM	COL	1	2	3	4	5	6	7	8	9	10	11	L1	L2	L3	L6
550	552	555	559	560	565	569	571	575	579	583	586	590	594	606	631	696



Upholstered shell pad
Asiento y respaldo plafonado

COM	COL	1	2	3	4	5	6	7	8	9	10	11	L1	L2	L3	L6
726	733	742	749	755	766	775	785	794	805	815	824	835	842	878	942	1.114



SERIE
600

Matte lacquered and premium upcharge
Incremento por lacado mate y premium

26

BQ2748

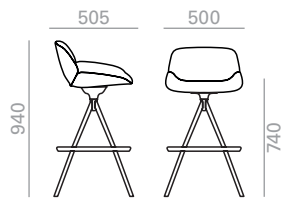

Barstool with upholstered shell and 4-legs steel swivel base and finished in polished chrome, white or black. Optional upholstered seat pad or upholstered shell pad. In upholstered versions the seat height increases 20 mm.

Banqueta alta con carcasa de termopolímero y base giratoria de 4 patas de acero y acabado cromo brillo, blanco o negro. Opción de asiento plafonado o asiento y respaldo plafonado. En versiones tapizadas la altura de asiento aumenta 20 mm.

COM cm. per unit	COL m2
---------------------	-----------

0,25 m3

10 kg

x1

Seat pad Asiento plafonado

1 units	60	0,75
10 units or more	30	

Shell pad Asiento y respaldo plafonado

1 units	90	1
10 units or more	70	



Thermo-polymer shell
Carcasa termopolímero



Upholstered seat pad
Asiento plafonado

COM	COL	1	2	3	4	5	6	7	8	9	10	11	L1	L2	L3	L6
394	396	399	403	404	409	413	415	419	423	428	430	434	438	452	476	542



Upholstered shell pad
Asiento y respaldo plafonado

COM	COL	1	2	3	4	5	6	7	8	9	10	11	L1	L2	L3	L6
555	563	572	580	586	596	607	616	626	635	646	656	665	674	716	794	998

BQ2749

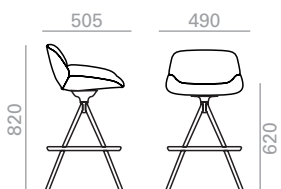

Counter stool with upholstered shell and 4-legs steel swivel base and finished in polished chrome, white or black. Optional upholstered seat pad or upholstered shell pad. In upholstered versions the seat height increases 20 mm.

Banqueta baja con carcasa de termopolímero y base giratoria de 4 patas de acero y acabado cromo brillo, blanco o negro. Opción de asiento plafonado o asiento y respaldo plafonado. En versiones tapizadas la altura de asiento aumenta 20 mm.

COM cm. per unit	COL m2
---------------------	-----------

0,2 m3

9 kg

x1

Seat pad Asiento plafonado

1 units	60	0,75
10 units or more	30	

Shell pad Asiento y respaldo plafonado

1 units	90	1
10 units or more	70	



Thermo-polymer shell
Carcasa termopolímero



Upholstered seat pad
Asiento plafonado

COM	COL	1	2	3	4	5	6	7	8	9	10	11	L1	L2	L3	L6
394	396	399	403	404	409	413	415	419	423	428	430	434	438	452	476	542



Upholstered shell pad
Asiento y respaldo plafonado

COM	COL	1	2	3	4	5	6	7	8	9	10	11	L1	L2	L3	L6
555	563	572	580	586	596	607	616	626	635	646	656	665	674	716	794	998

BQ2762



Barstool with upholstered shell and 4-legs solid ash wood. Optional upholstered seat pad or upholstered shell pad. In upholstered versions the seat height increases 20 mm.

Banqueta alta con carcasa de termopolímero y base de 4 patas de madera maciza de fresno. Opción de asiento plafonado o asiento y respaldo plafonado. En versiones tapizadas la altura de asiento aumenta 20 mm.

COM cm. per unit	COL m2
------------------	--------

0,42 m3

14,1 kg

x1

Seat pad Asiento plafonado

1 units	60	1
10 units or more	30	

Shell pad Asiento y respaldo plafonado

1 units	100	1,25
10 units or more	80	



TP

448

Thermo-polymer shell
Carcasa termopolímero



Upholstered seat pad
Asiento plafonado

COM	COL	1	2	3	4	5	6	7	8	9	10	11	L1	L2	L3	L6
555	558	561	564	567	571	574	578	582	586	589	593	598	601	615	640	706



Upholstered shell pad
Asiento y respaldo plafonado

COM	COL	1	2	3	4	5	6	7	8	9	10	11	L1	L2	L3	L6
699	708	717	726	732	743	755	765	776	786	798	809	820	830	869	942	1.132

BQ2763



Counter stool with upholstered shell and 4-legs ash beech wood. Optional upholstered seat pad or upholstered shell pad. In upholstered versions the seat height increases 20 mm.

Banqueta baja con carcasa de termopolímero y base de 4 patas de madera maciza de fresno. Opción de asiento plafonado o asiento y respaldo plafonado. En versiones tapizadas la altura de asiento aumenta 20 mm.

COM cm. per unit	COL m2
------------------	--------

0,36 m3

13,7 kg

x1

Seat pad Asiento plafonado

1 units	60	1
10 units or more	30	

Shell pad Asiento y respaldo plafonado

1 units	100	1,25
10 units or more	80	



TP

448

Thermo-polymer shell
Carcasa termopolímero



Upholstered seat pad
Asiento plafonado

COM	COL	1	2	3	4	5	6	7	8	9	10	11	L1	L2	L3	L6
555	558	561	564	567	571	574	578	582	586	589	593	598	601	615	640	706



Upholstered shell pad
Asiento y respaldo plafonado

COM	COL	1	2	3	4	5	6	7	8	9	10	11	L1	L2	L3	L6
699	708	717	726	732	743	755	765	776	786	798	809	820	830	869	942	1.132

BQ2764

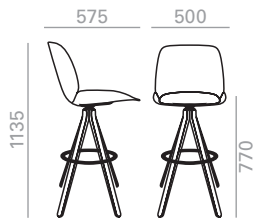

Barstool with upholstered shell and solid ash wood central swivel base and self-return system. Optional upholstered seat pad or upholstered shell pad. In upholstered versions the seat height increases 20 mm.

Banqueta alta con carcasa de termopolímero y base central giratoria de 4 aspas de madera maciza de fresno con sistema de retorno. Opción de asiento plafonado o asiento y respaldo plafonado. En versiones tapizadas la altura de asiento aumenta 20 mm.

COM cm. per unit	COL m2
------------------	--------

0,38 m3

14,2 kg

x1

Seat pad Asiento plafonado

1 units	60	1
10 units or more	30	

Shell pad Asiento y respaldo plafonado

1 units	100	1,25
10 units or more	80	



TP

486

Thermo-polymer shell
Carcasa termopolímero



Upholstered seat pad
Asiento plafonado

COM	COL	1	2	3	4	5	6	7	8	9	10	11	L1	L2	L3	L6
563	565	568	571	573	578	580	584	588	591	595	599	602	605	618	641	705



Upholstered shell pad
Asiento y respaldo plafonado

COM	COL	1	2	3	4	5	6	7	8	9	10	11	L1	L2	L3	L6
743	752	761	770	776	787	799	809	820	830	843	853	864	874	913	986	1.176

BQ2765



Counter stool with upholstered shell and solid ash wood central swivel base and self-return system. Optional upholstered seat pad or upholstered shell pad. In upholstered versions the seat height increases 20 mm.

Banqueta baja con carcasa de termopolímero y base central giratoria de 4 aspas de madera maciza de fresno con sistema de retorno. Opción de asiento plafonado o asiento y respaldo plafonado. En versiones tapizadas la altura de asiento aumenta 20 mm.

COM cm. per unit	COL m2
------------------	--------

0,34 m3

13,7 kg

x1

Seat pad Asiento plafonado

1 units	60	1
10 units or more	30	

Shell pad Asiento y respaldo plafonado

1 units	100	1,25
10 units or more	80	



TP

486

Thermo-polymer shell
Carcasa termopolímero



Upholstered seat pad
Asiento plafonado

COM	COL	1	2	3	4	5	6	7	8	9	10	11	L1	L2	L3	L6
563	565	568	571	573	578	580	584	588	591	595	599	602	605	618	641	705



Upholstered shell pad
Asiento y respaldo plafonado

COM	COL	1	2	3	4	5	6	7	8	9	10	11	L1	L2	L3	L6
743	752	761	770	776	787	799	809	820	830	843	853	864	874	913	986	1.176

BQ2766



Barstool with upholstered shell and steel sled base finished in polished chrome, white or black. Optional upholstered seat pad or upholstered shell pad. In upholstered versions the seat height increases 20 mm.

Banqueta alta con carcasa de termopolímero y base de patín de acero en acabado cromo brillo, blanco o negro. Opción de asiento plafonado o asiento y respaldo plafonado. En versiones tapizadas la altura de asiento aumenta 20 mm.

COM cm. per unit	COL m2
------------------	--------

0,39 m3

15,1 kg

x1

Seat pad Asiento plafonado

1 units	60	1
10 units or more	30	

Shell pad Asiento y respaldo plafonado

1 units	100	1,25
10 units or more	80	



TP

273

Thermo-polymer shell
Carcasa termopolímero



Upholstered seat pad
Asiento plafonado

COM	COL	1	2	3	4	5	6	7	8	9	10	11	L1	L2	L3	L6
364	367	370	374	376	380	384	388	391	395	399	403	406	410	424	449	517



Upholstered shell pad
Asiento y respaldo plafonado

COM	COL	1	2	3	4	5	6	7	8	9	10	11	L1	L2	L3	L6
498	507	517	526	533	544	554	566	577	589	601	611	622	632	673	747	943

BQ2767



Counter stool with upholstered shell and steel sled base finished in polished chrome, white or black. Optional upholstered seat pad or upholstered shell pad. In upholstered versions the seat height increases 20 mm.

Banqueta baja con carcasa de termopolímero y base de patín de acero en acabado cromo brillo, blanco o negro. Opción de asiento plafonado o asiento y respaldo plafonado. En versiones tapizadas la altura de asiento aumenta 20 mm.

COM cm. per unit	COL m2
------------------	--------

0,36 m3

14,1 kg

x1

Seat pad Asiento plafonado

1 units	60	1
10 units or more	30	

Shell pad Asiento y respaldo plafonado

1 units	100	1,25
10 units or more	80	



TP

273

Thermo-polymer shell
Carcasa termopolímero



Upholstered seat pad
Asiento plafonado

COM	COL	1	2	3	4	5	6	7	8	9	10	11	L1	L2	L3	L6
364	367	370	374	376	380	384	388	391	395	399	403	406	410	424	449	517



Upholstered shell pad
Asiento y respaldo plafonado

COM	COL	1	2	3	4	5	6	7	8	9	10	11	L1	L2	L3	L6
498	507	517	526	533	544	554	566	577	589	601	611	622	632	673	747	943

BQ2768



Barstool with upholstered shell and 4-legs steel swivel base and finished in polished chrome, white or black. Optional upholstered seat pad or upholstered shell pad. In upholstered versions the seat height increases 20 mm.

Banqueta alta con carcasa de termopolímero y base giratoria de 4 patas de acero y acabado cromo brillo, blanco o negro. Opción de asiento plafonado o asiento y respaldo plafonado. En versiones tapizadas la altura de asiento aumenta 20 mm.

COM cm. per unit	COL m2
------------------	--------

0,36 m3

11,1 kg

x1

Seat pad Asiento plafonado

1 units	60	1
10 units or more	30	

Shell pad Asiento y respaldo plafonado

1 units	100	1,25
10 units or more	80	



TP

327

Thermo-polymer shell
Carcasa termopolímero



Upholstered seat pad
Asiento plafonado

COM	COL	1	2	3	4	5	6	7	8	9	10	11	L1	L2	L3	L6
413	416	419	422	425	429	433	436	440	444	447	451	455	458	472	497	562



Upholstered shell pad
Asiento y respaldo plafonado

COM	COL	1	2	3	4	5	6	7	8	9	10	11	L1	L2	L3	L6
541	548	558	566	573	583	595	604	616	627	637	648	659	668	707	778	977

BQ2769



Counter stool with upholstered shell and 4-legs steel swivel base and finished in polished chrome, white or black. Optional upholstered seat pad or upholstered shell pad. In upholstered versions the seat height increases 20 mm.

Banqueta baja con carcasa de termopolímero y base giratoria de 4 patas de acero y acabado cromo brillo, blanco o negro. Opción de asiento plafonado o asiento y respaldo plafonado. En versiones tapizadas la altura de asiento aumenta 20 mm.

COM cm. per unit	COL m2
------------------	--------

0,34 m3

10,6 kg

x1

Seat pad Asiento plafonado

1 units	60	1
10 units or more	30	

Shell pad Asiento y respaldo plafonado

1 units	100	1,25
10 units or more	80	



TP

327

Thermo-polymer shell
Carcasa termopolímero



Upholstered seat pad
Asiento plafonado

COM	COL	1	2	3	4	5	6	7	8	9	10	11	L1	L2	L3	L6
413	416	419	422	425	429	433	436	440	444	447	451	455	458	472	497	562



Upholstered shell pad
Asiento y respaldo plafonado

COM	COL	1	2	3	4	5	6	7	8	9	10	11	L1	L2	L3	L6
541	548	558	566	573	583	595	604	616	627	637	648	659	668	707	778	977

BQ2745

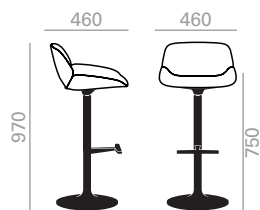

Barstool with Eco thermo-polymer shell available in several colors or Pure Eco thermo-polymer (100% recycled) available in sand color and injection swivel central base finished in polished aluminum, white or black. Optional upholstered seat pad or upholstered shell pad. In upholstered versions the seat height increases 20 mm.

Banqueta alta con carcasa de termopolímero Eco disponible en diferentes colores o termopolímero Pure Eco (100% reciclado) disponible en color arena y base central giratoria de inyección de aluminio en acabado aluminio pulido, blanco o negro. Opción de asiento plafonado o asiento y respaldo plafonado. En versiones tapizadas la altura de asiento aumenta 20 mm.

COM cm. per unit	COL m2
------------------	--------

0,28 m3

10,5 kg

x1

Seat pad Asiento plafonado

1 units	60	1
10 units or more	30	

Shell pad Asiento y respaldo plafonado

1 units	100	1,25
10 units or more	80	



TP

336

Thermo-polymer shell
Carcasa termopolímero



Upholstered seat pad
Asiento plafonado

COM	COL	1	2	3	4	5	6	7	8	9	10	11	L1	L2	L3	L6
419	422	425	428	430	433	437	440	444	447	451	454	458	461	473	495	556



Upholstered shell pad
Asiento y respaldo plafonado

COM	COL	1	2	3	4	5	6	7	8	9	10	11	L1	L2	L3	L6
494	499	506	513	517	525	533	541	548	556	564	572	580	587	615	672	861

BQ2746

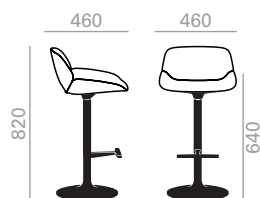

Counter stool with Eco thermo-polymer shell available in several colors or Pure Eco thermo-polymer (100% recycled) available in sand color and injection swivel central base finished in polished aluminum, white or black. Optional upholstered seat pad or upholstered shell pad.

Banqueta baja con carcasa de termopolímero Eco disponible en diferentes colores o termopolímero Pure Eco (100% reciclado) disponible en color arena y base central giratoria de inyección de aluminio en acabado aluminio pulido, blanco negro. Opción de asiento plafonado o asiento y respaldo plafonado.

COM cm. per unit	COL m2
------------------	--------

0,22 m3

9,5 kg

x1

Seat pad Asiento plafonado

1 units	60	1
10 units or more	30	

Shell pad Asiento y respaldo plafonado

1 units	100	1,25
10 units or more	80	



TP

336

Thermo-polymer shell
Carcasa termopolímero



Upholstered seat pad
Asiento plafonado

COM	COL	1	2	3	4	5	6	7	8	9	10	11	L1	L2	L3	L6
419	422	425	428	430	433	437	440	444	447	451	454	458	461	473	495	556



Upholstered shell pad
Asiento y respaldo plafonado

COM	COL	1	2	3	4	5	6	7	8	9	10	11	L1	L2	L3	L6
494	499	506	513	517	525	533	541	548	556	564	572	580	587	615	672	861

BQ2747

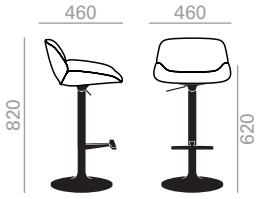

Barstool with Eco thermo-polymer shell available in several colors or Pure Eco thermo-polymer (100% recycled) available in sand col or and injection swivel central base, adjustable height and finished in polished aluminum, white or black. Optional upholstered seat pad or upholstered shell pad. Seat height range: 620-750 mm.

Banqueta alta con carcasa de termopolímero Eco disponible en diferentes colores o termopolímero Pure Eco (100% reciclado) disponible en color arena y base central giratoria de inyección de aluminio, regulable en altura y acabado aluminio pulido, blanco o negro. Opción de asiento plafonado o asiento y respaldo plafonado. Rango de altura de asiento: 620-750 mm.

COM cm. per unit	COL m2
------------------	--------

0,22 m3

9,5 kg

x1

Seat pad Asiento plafonado

1 units	60	1
10 units or more	30	

Shell pad Asiento y respaldo plafonado

1 units	100	1,25
10 units or more	80	



Thermo-polymer shell
Carcasa termopolímero

TP
343



Upholstered seat pad
Asiento plafonado

COM	COL	1	2	3	4	5	6	7	8	9	10	11	L1	L2	L3	L6
427	430	433	436	438	441	445	448	452	455	459	462	466	469	481	505	565



Upholstered shell pad
Asiento y respaldo plafonado

COM	COL	1	2	3	4	5	6	7	8	9	10	11	L1	L2	L3	L6
505	510	517	524	528	536	544	552	560	568	575	583	591	598	628	685	878

BQ2736



Barstool with Eco thermo-polymer shell available in several colors or Pure Eco thermo-polymer (100% recycled) available in sand col or and injection swivel central base finished in polished aluminum, white or black. Optional upholstered seat pad or upholstered shell pad. In upholstered versions the seat height increases 20 mm.

Banqueta alta con carcasa de termopolímero Eco disponible en diferentes colores o termopolímero Pure Eco (100% reciclado) disponible en color arena y base central giratoria de inyección de aluminio en acabado aluminio pulido, blanco o negro. Opción de asiento plafonado o asiento y respaldo plafonado. En versiones tapizadas la altura de asiento aumenta 20 mm.

COM cm. per unit	COL m2
------------------	--------

0,37 m3

10,5 kg

x1

Seat pad Asiento plafonado

1 units	60	1
10 units or more	30	

Shell pad Asiento y respaldo plafonado

1 units	100	1,25
10 units or more	80	



Thermo-polymer shell
Carcasa termopolímero

TP
369



Upholstered seat pad
Asiento plafonado

COM	COL	1	2	3	4	5	6	7	8	9	10	11	L1	L2	L3	L6
482	485	488	491	494	497	501	505	508	513	516	520	523	527	540	565	631



Upholstered shell pad
Asiento y respaldo plafonado

COM	COL	1	2	3	4	5	6	7	8	9	10	11	L1	L2	L3	L6
535	542	551	558	564	574	582	592	602	610	620	629	639	647	680	746	975

BQ2737



Counter stool with Eco thermo-polymer shell available in several colors or Pure Eco thermo-polymer (100% recycled) available in sand color and injection swivel central base finished in polished aluminum, white or black. Optional upholstered seat pad or upholstered shell pad. In upholstered versions the seat height increases 20 mm.

Banqueta baja con carcasa de termopolímero Eco disponible en diferentes colores o termopolímero Pure Eco (100% reciclado) disponible en color arena y base central giratoria de inyección de aluminio en acabado aluminio pulido, blanco negro. Opción de asiento plafonado o asiento y respaldo plafonado. En versiones tapizadas la altura de asiento aumenta 20 mm.

COM cm. per unit	COL m2
------------------	--------

0,28 m3

9,5 kg

x1

Seat pad Asiento plafonado

1 units	60	1
10 units or more	30	

Shell pad Asiento y respaldo plafonado

1 units	100	1,25
10 units or more	80	

€  TP
369

Thermo-polymer shell
Carcasa termopolímero



Upholstered seat pad
Asiento plafonado

COM	COL	1	2	3	4	5	6	7	8	9	10	11	L1	L2	L3	L6
482	485	488	491	494	497	501	505	508	513	516	520	523	527	540	565	631



Upholstered shell pad
Asiento y respaldo plafonado

COM	COL	1	2	3	4	5	6	7	8	9	10	11	L1	L2	L3	L6
535	542	551	558	564	574	582	592	602	610	620	629	639	647	680	746	975

BQ2738

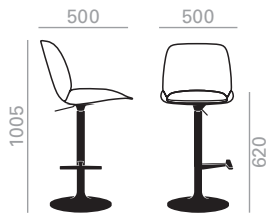

Barstool with Eco thermo-polymer shell available in several colors or Pure Eco thermo-polymer (100% recycled) available in sand color and injection swivel central base, adjustable height and finished in polished aluminum, white or black. Optional upholstered seat pad or upholstered shell pad. Seat height range: 620-750 mm. In upholstered versions the seat height increases 20 mm.

Banqueta alta con carcasa de termopolímero Eco disponible en diferentes colores o termopolímero Pure Eco (100% reciclado) disponible en color arena y base central giratoria de inyección de aluminio, regulable en altura y acabado aluminio pulido, blanco o negro. Opción de asiento plafonado o asiento y respaldo plafonado. Rango de altura de asiento: 620-750 mm. En versiones tapizadas la altura de asiento aumenta 20 mm.

COM cm. per unit	COL m2
------------------	--------

0,28 m3

9,5 kg

x1

Seat pad Asiento plafonado

1 units	60	1
10 units or more	30	

Shell pad Asiento y respaldo plafonado

1 units	100	1,25
10 units or more	80	

€  TP
376

Thermo-polymer shell
Carcasa termopolímero



Upholstered seat pad
Asiento plafonado



COM	COL	1	2	3	4	5	6	7	8	9	10	11	L1	L2	L3	L6
491	494	497	500	503	506	511	514	519	522	525	529	532	535	549	574	640



Upholstered shell pad
Asiento y respaldo plafonado

COM	COL	1	2	3	4	5	6	7	8	9	10	11	L1	L2	L3	L6
546	553	562	569	575	585	593	603	613	622	632	641	651	659	694	761	995

Glides for cantilever base. Tacos para base cantiléver.

Use/Usó	Reference/Referencia		Material/Material	Price/Precio	
Hard floors. Suelos duros.	TS0545		Plastic (PE). Plástico (PE).	0 €	Standard. Estándar.
Wooden and delicated floors. Suelos de madera y delicados.	TS0546		Plastic (PE) with felt. Plástico (PE) con fieltro.	6 €	Set of 4 glides. Juego de 4 tacos.
Mats/carpet floors. Suelos de moqueta/ alfombra.	TS0547		No glide. Sin taco.	0 €	

The indicated price is for glides placed on chairs. To order loose parts, please ask to our Sales Department.

El precio indicado en Tarifa es para tacos colocados en las sillas. Para pedidos de tacos sueltos de repuesto, consultar con el Departamento Comercial.

Glides for 4 star aluminum central base. Tacos para base central de aluminio de 4 aspas.

Use/Usó	Reference/Referencia		Material/Material	Price/Precio	
Hard floors. Suelos duros.	TS0544		Plastic (PE). Plástico (PE).	0 €	Standard. Estándar.
Wooden and delicated floors. Suelos de madera y delicados.	TS0556		Plastic (PE) with felt. Plástico (PE) con fieltro.	3 €	Set of 4 glides. Juego de 4 tacos.
Mats/carpet floors. Suelos de moqueta/ alfombra.	TS0557		No glide. Sin taco.	0 €	

The indicated price is for glides placed on chairs. To order loose parts, please ask to our Sales Department.

El precio indicado en Tarifa es para tacos colocados en las sillas. Para pedidos de tacos sueltos de repuesto, consultar con el Departamento Comercial.

For wooden legs. Para bases de madera.



Optional glides on page 482.

Opciones de tacos deslizantes en página 482.

Casters. Ruedas.



Standard.
Estándar.

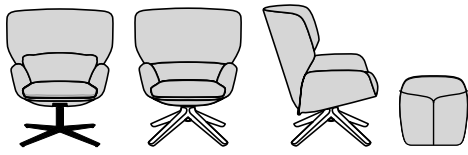

Description
Descripción

High-back lounge chairs with BIO thermopolymer shell available in different colors and padded seat and backrest. Upholstered seat cushion. The available bases are: 4-star aluminum central swivel base with return system available in polished aluminum, white or black finish and 4-star central swivel base in solid ash. Available options: tilting system and auxiliary cushion. Upholstered footrest version available.

Butacas de respaldo alto con carcasa de termopolímero BIO disponible en diferentes colores y asiento y respaldo plafonado. Cojín tapizado en asiento. Las bases disponibles son: base central giratoria de aluminio de 4 aspas con sistema de retorno disponible en acabado aluminio pulido, blanco o negro y base central giratoria de 4 aspas de madera maciza de fresno. Opciones disponibles: sistema basculante y cojín auxiliar. Disponible versión de reposapiés tapizado.

Upholstery
Tapicería

The Nuez Lounge BIO collection supports following upholsteries of Andreu World Catalogue. All upholstered versions are made with 100% recycled Pure Eco thermo-polymer. For fabrics in our catalogue not specified in this box or customers own materials please contact our Customer Service Department.

La colección Nuez Lounge BIO admite las siguientes tapicerías del catálogo de Andreu World. Todas las versiones tapizadas están hechas con termopolímero Pure Eco 100% reciclado. Para las telas de nuestro catálogo no indicadas en este cuadro o telas cliente, consultar con nuestro Departamento Comercial.

Fabrics / Telas

- 1 Jacquard One
- Jacquard Three
- Citadel
- Sand
- Era
- Gravity
- Rivet
- Urban
- Spin One
- Spin Two
- Spin Three
- Spin Four
- Spin Five

- 2 Jacquard Two
- Loom One
- Circular One Pure Eco
- Tack One (in/out)

- 3 Jacquard Four
- Medley
- Revive 1
- Main Line Flax
- Loom Two (in/out)
- Mezzo
- Reel two (in/out)
- Jacquard Five

- 4 Jacquard 4 Special
- Nexus
- Remix 3
- Heritage
- Savane
- Loom Three
- Loom Four
- Cura
- Oceanic
- Reel Three (in/out)
- Reel Four (in/out)
- Reflect
- Spin Six

- 5 Silk
- Synergy
- Step
- Step Melange
- Blazer
- Melange Nap
- Chili
- Noma
- Re-wool

- 6 Go check
- Swing
- Chartres
- Zori
- Patio
- Tack Two (in/out)
- Tack Three (in/out)

- 7 Canvas 2
- Select
- Clara 2
- Tack Five (in/out)
- Hero 2

- 8 Capture
- Fjord 2
- Tonus 4
- Divina 3
- Lopi
- Domino
- Atrium
- 9 Divina MD
- Divina Melange 3
- Hallingdal 65
- Steelcut Trio 3
- Tack Four (in/out)

- 11 Arda
- Ecriture
- Zero

Faux Leather / Ecopiel

- 1 Valencia
- 2 Silvertex
- 3 Maglia
- 4 Dolce
- 8 Ultraleather
- 9 Brisa
- Brisa Distressed
- Fresco
- Ultraleather Pro
- Promessa
- 10 Tottori
- Coast (in/out)
- 11 Reef Pro
- Volar Bio

Leather / Piel

- L1 High grade cow leather.
- Piel de vaca de 1ª categoría.
- L3 Polished full grain leather.
- Plena flor pulida.
- L6 Aniline leather batique-effect.
- Scandinavian cattle.
- Piel anilina efecto batique.
- Ganado escandinavo.

Wood finish Ash
Acabado madera
Fresno



Premium finish and wood lacquers
Acabado premium y lacas madera



Bio Thermo-polymer finish
Acabado de Termo-polímero Bio

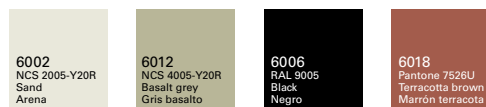

Aluminum finish
Acabado aluminio



Certificates
Certificados

Fireproof polyurethane foam
Espuma de poliuretano ignifuga

UNE EN 1021:2006
BS 5852 part 2 crib 5
UNI 9175 Classe 1 IM
BKZ 5.2
California TB 117:2013
California TB 133*

Quality - Resistance
Calidad - Resistencia

UNE EN 16139:2013

*Contact our Customer Department
*Consultar con nuestro Departamento Comercial

Intellectual property Propiedad intelectual

All our collections are protected by international industrial design registries, designs patents, copyrights and intellectual Property laws. Unauthorized use of AW International Property is a criminal offence and can lead to prosecution.
Todas nuestras colecciones están protegidas por registros de diseño industrial, diseño de patente, copyright y derechos de propiedad intelectual en todo el mundo. El uso no autorizado de los diseños y propiedad intelectual de AW supone un delito que puede ser sometido a acción judicial.



BU2742

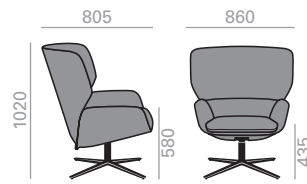

High back lounge chair with Bio thermo-polymer, upholstered shell and aluminum swivel 4-star base with self-return and finished in polished aluminum, white or black. Upholstered seat cushion on seat. Additional options include: tilting mechanism.

Butaca de respaldo alto con carcasa de termopolímero Bio, asiento y respaldo plafonado y base central giratoria de aluminio de 4 aspas con sistema de retorno disponible en acabado aluminio pulido, blanco o negro. Cojín tapizado en asiento. Opciones disponibles: sistema basculante.

	COM cm. per unit	COL m2
1 units	360	7
10 units or more	360	

0,97 m3
 37 kg
 x1

€	COM	COL	1	2	3	4	5	6	7	8	9	10	11	L1	L2	L3	L6
	1.792	1.829	1.873	1.910	1.938	1.985	2.034	2.082	2.131	2.180	2.227	2.277	2.324	2.367	2.542	2.860	3.720



Tilting mechanism upcharge
 Incremento por sistema basculante

| 90 |

BU2743

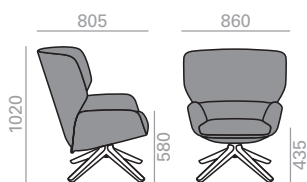

High back lounge chair with Bio thermo-polymer, upholstered shell and solid ash wood central swivel base. Upholstered seat cushion on seat. Additional options include: tilting mechanism.

Butaca de respaldo alto con carcasa de termopolímero Bio, asiento y respaldo plafonado y base central giratoria de 4 aspas de madera maciza de fresno. Cojín tapizado en asiento. Opciones disponibles: sistema basculante.

	COM cm. per unit	COL m2
1 units	360	7
10 units or more	360	

0,97 m3
 41 kg
 x1

€	COM	COL	1	2	3	4	5	6	7	8	9	10	11	L1	L2	L3	L6
	1.912	1.949	1.994	2.031	2.060	2.109	2.158	2.208	2.257	2.306	2.355	2.404	2.453	2.498	2.675	2.999	3.923



SERIE 600
 Matte lacquered and premium upcharge
 Incremento por lacado mate y premium

| 24 |



SERIE 800
 Bright lacquered upcharge
 Incremento por lacado brillo

| 35 |



Tilting mechanism upcharge
 Incremento por sistema basculante

| 90 |

CJ2744

Loose cushion
 Cojín auxiliar

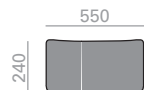

	COM cm. per unit	COL m2
1 units	45	1
10 units or more	45	

0,01 m3
 1,6 kg
 x1

€	COM	COL	1	2	3	4	5	6	7	8	9	10	11	L1	L2	L3	L6
	112	116	121	127	130	136	142	148	154	161	167	173	179	185	207	248	355

RS2739

Upholstered ottoman.
 Reposapiés tapizado.

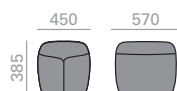

	COM cm. per unit	COL m2
1 units	140	3
10 units or more	140	

0,11 m3
 7,5 kg
 x1

€	COM	COL	1	2	3	4	5	6	7	8	9	10	11	L1	L2	L3	L6
	535	549	564	578	588	606	624	642	660	678	695	713	731	746	811	928	1.278

Glides for 4 star aluminum central base. Tacos para base central de aluminio de 4 aspas.

Use/Usó	Reference/Referencia		Material/Material	Price/Precio	
Hard floors. Suelos duros.	TS0544		Plastic (PE). Plástico (PE).	0 €	Standard. Estándar.
Wooden and delicated floors. Suelos de madera y delicados.	TS0556		Plastic (PE) with felt. Plástico (PE) con fieltro.	3 €	Set of 4 glides. Juego de 4 tacos.
Mats/carpet floors. Suelos de moqueta/ alfombra.	TS0557		No glide. Sin taco.	0 €	

The indicated price is for glides placed on chairs. To order loose parts, please ask to our Sales Department.

El precio indicado en Tarifa es para tacos colocados en las sillas. Para pedidos de tacos sueltos de repuesto, consultar con el Departamento Comercial.

For wooden legs. Para bases de madera.



Optional glides on page 482.

Opciones de tacos deslizantes en página 482.



Description
Descripción

Chair with oak seat and backrest and optional upholstered seat cushion. Wide version available. The bases available are: 4 solid beech wood legs, central aluminum swivel base with 4 wheels in black finish, central aluminum swivel base with 5 wheels, height-adjustable with black finish or central thermopolymer swivel base with 5 wheels, adjustable in height and with black finish.

Silla con asiento y respaldo de roble y opción de cojín tapizado en asiento. Disponible versión ancha. Las bases disponibles son: 4 patas de madera maciza de haya, base central giratoria de aluminio de 4 ruedas en acabado negro, base central giratoria de aluminio de 5 ruedas, regulable en altura y acabado negro y y base central giratoria de termopolímero de 5 ruedas, regulable en altura y acabado negro.

Upholstery
Tapicería

The Olena collection supports following upholsteries of Andreu World Catalogue. For fabrics in our catalogue not specified in this box or customers own materials please contact our Customer Service Department.

La colección Olena admite las siguientes tapicerías del catálogo de Andreu World. Para las telas de nuestro catálogo no indicadas en este cuadro o telas cliente, consultar con nuestro Departamento Comercial.

Fabrics / Telas

- 1** Soft-fiber
Jacquard One
Jacquard Three
Citadel
Sand
Era
Gravity
Rivet
Urban
Reel One (in/out)
Spin One
Spin Two
Spin Three
Spin Four
Spin Five
- 2** Jacquard Two
Solid & Stripes
Loom One
Circular One Pure Eco
Tack One (in/out)

- 3** Jacquard Four
Medley
Revive 1
Natte
Main Line Flax
Loom Two (in/out)
Mezzo
Reel two (in/out)
Jacquard Five
- 4** Jacquard 4 Special
Nexus
Field 2
Remix 3
Heritage
Savane
Loom Three
Loom Four
Cura
Oceanic
Reel Three (in/out)
Reel Four (in/out)
Reflect
Spin Six

- 5** Silk
Synergy
Step
Step Melange
Blazer
Melange Nap
Chili
Noma
Re-wool
- 6** Go check
Swing
Chartres
Zori
Patio
Tack Two (in/out)
Tack Three (in/out)
- 7** Canvas 2
Select
Clara 2
Tack Five (in/out)
Hero 2

- 8** Capture
Fiord 2
Tonus 4
Divina 3
Lopi
Domino
Atrium
- 9** Divina MD
Divina Melange 3
Hallingdal 65
Steelcut Trio 3
Tack Four (in/out)
- 11** Arda
Ecriture
Zero

Faux Leather / Ecopiel

- 1** Valencia
- 2** Silvertex
- 3** Maglia
- 4** Dolce
- 8** Ultraleather
- 9** Brisa
Brisa Distressed
Fresco
Ultraleather Pro
Promessa
- 10** Tottori
Coast (in/out)
- 11** Reef Pro
Volar Bio

Leather / Piel

- L1** High grade cow leather.
Piel de vaca de 1ª categoría.
- L3** Polished full grain leather.
Piena flor pulida.
- L6** Aniline leather batique-effect.
Scandinavian cattle.
Piel anilina efecto batique.
Ganado escandinavo.

Wood finish Oak
Acabado madera
Roble



Aluminum finish
Acabado aluminio

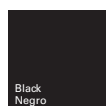

Certificates
Certificados

Fireproof polyurethane foam

Espuma de poliuretano ignifuga

UNE EN 1021:2006
BS 5852 part 2 crib 5
UNI 9175 Classe 1 IM
BKZ 5.2
California TB 117:2013
California TB 133*

*Contact our Customer Department
*Consultar con nuestro Departamento Comercial

Quality - Resistance
Calidad - Resistencia

UNE EN 16139:2013

Intellectual property Propiedad intelectual

All our collections are protected by international industrial design registries, designs patents, copyrights and intellectual Property laws. Unauthorized use of AW International Property is a criminal offence and can lead to prosecution.
Todas nuestras colecciones están protegidas por registros de diseño industrial, diseño de patente, copyright y derechos de propiedad intelectual todo el mundo. El uso no autorizado de los diseños y propiedad intelectual de AW supone un delito que puede ser sometido a acción judicial.



SI1290



Chair with oak seat and backrest and 4-legged base in solid beech wood. Option of upholstered seat cushion.

Silla con asiento y respaldo de roble y base de 4 patas de madera maciza de haya. Opción de cojín tapizado en asiento.

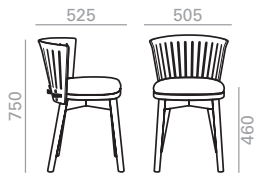

	COM cm. per unit	COL m2
1 units	80	1,75
10 units or more	40	

0,35 m3

10,1 kg

x1

€ 388



Upholstered cushion
Cojín tapizado

COM	COL	1	2	3	4	5	6	7	8	9	10	11	L1	L2	L3	L6
476	481	485	490	493	499	504	509	515	519	525	531	536	597	636	706	895



Matte lacquered and premium upcharge
Incremento por lacado mate y premium

39

SI1291



Chair with oak seat and backrest and 4-legged base in solid beech wood. Wide version. Option of upholstered seat cushion.

Silla con asiento y respaldo de roble y base de 4 patas de madera maciza de haya. Versión ancha. Opción de cojín tapizado en asiento.

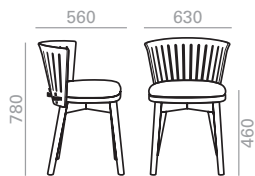

	COM cm. per unit	COL m2
1 units	90	2
10 units or more	45	

0,41 m3

11,2 kg

x1

€ 403



Upholstered cushion
Cojín tapizado

COM	COL	1	2	3	4	5	6	7	8	9	10	11	L1	L2	L3	L6
481	490	500	509	516	528	542	554	566	578	590	602	615	625	669	749	961



Matte lacquered and premium upcharge
Incremento por lacado mate y premium

39

SI1292

Chair with oak seat and backrest and central aluminum swivel base with 4 wheels in black finish. Option of upholstered seat cushion.

Silla con asiento y respaldo de roble y base central giratoria de aluminio de 4 ruedas en acabado negro. Opción de cojín tapizado en asiento.

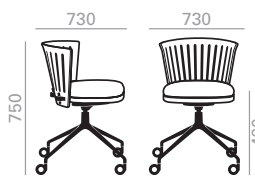

	COM cm. per unit	COL m2
1 units	80	1,75
10 units or more	40	

0,48 m3

13,2 kg

x1

€ 525



Upholstered cushion
Cojín tapizado

COM	COL	1	2	3	4	5	6	7	8	9	10	11	L1	L2	L3	L6
613	618	622	631	637	647	659	670	680	691	702	713	723	734	773	843	1.032

SI1293



Chair with oak seat and backrest and central aluminum swivel base with 5 wheels, height-adjustable in black finish. Wide version. Option of upholstered seat cushion.

Silla con asiento y respaldo de roble y base central giratoria de aluminio de 5 ruedas, regulable en altura y acabado negro. Versión ancha. Opción de cojín tapizado en asiento.

	COM cm. per unit	COL m2
1 units	90	2
10 units or more	45	

0,43 m3
 14,4 kg
 x1

€ 555



Upholstered cushion
Cojín tapizado

COM	COL	1	2	3	4	5	6	7	8	9	10	11	L1	L2	L3	L6
643	648	652	661	668	680	694	706	718	730	741	753	767	777	821	901	1.113

SI1294

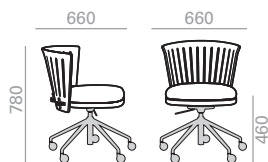

Chair with oak seat and backrest and central thermopolymer swivel base with 5 wheels, height-adjustable in black finish. Wide version. Option of upholstered seat cushion.

Silla con asiento y respaldo de roble y base central giratoria de termopolímero de 5 ruedas, regulable en altura y acabado negro. Versión ancha. Opción de cojín tapizado en asiento.

	COM cm. per unit	COL m2
1 units	90	2
10 units or more	45	

0,43 m3
 13,2 kg
 x1

€ 473



Upholstered cushion
Cojín tapizado

COM	COL	1	2	3	4	5	6	7	8	9	10	11	L1	L2	L3	L6
561	566	570	579	586	598	612	624	636	648	660	671	685	695	739	819	1.031

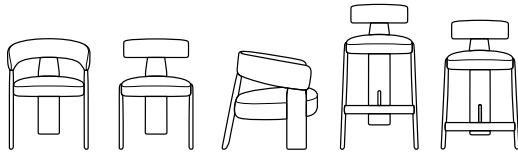

Description
Descripción

Chair and armchair with upholstered seat or upholstered seat and backrest and structure in solid ash wood. Available wide version of armchair. Armchair version with upholstered seat and backrest and solid ash wood structure.
Silla y sillón con asiento tapizado o asiento y respaldo tapizado y estructura de madera maciza de fresno. Disponible versión ancha de sillón. Versión de butaca con asiento y respaldo tapizado y estructura de madera maciza de fresno.

Upholstery
Tapicería

The Óru Chair collection supports following upholsteries of Andreu World Catalogue. For fabrics in our catalogue not specified in this box or customers own materials please contact our Customer Service Department.
La colección Óru Chair admite las siguientes tapicerías del catálogo de Andreu World. Para las telas de nuestro catálogo no indicadas en este cuadro o telas cliente, consultar con nuestro Departamento Comercial.

Fabrics / Telas

1 Jacquard One
Jacquard Three
Era
Spin One
Spin Two
Spin Three
Spin Four
Spin Five

2 Jacquard Two
Circular One Pure Eco
Tack One (in/out)

3 Jacquard Four
Medley
Main Line Flax
Jacquard Five

4 Jacquard 4 Special
Cura
Spin Six

5 Silk
Synergy
Step
Step Melange
Blazer
Melange Nap
Chili
Noma

6 Go check
Tack Two (in/out)
Tack Three (in/out)

8 Capture
Tonus 4
Divina 3
Domino

9 Divina MD
Divina Melange 3
Hallingdal 65
Steelcut Trio 3
Tack Four (in/out)

11 Arda
Ecriture
Zero

Faux Leather / Ecopiel

1 Valencia
2 Silvertex
3 Maglia

Leather / Piel

L1 High grade cow leather.
Piel de vaca de 1ª categoría.
L3 Polished full grain leather.
Piel de vaca pulida.
L6 Aniline leather batique-effect.
Scandinavian cattle.
Piel anilina efecto batique.
Ganado escandinavo.

Wood finish Ash
Acabado madera
Fresno



Premium finish and wood lacquers
Acabado premium y lacas madera

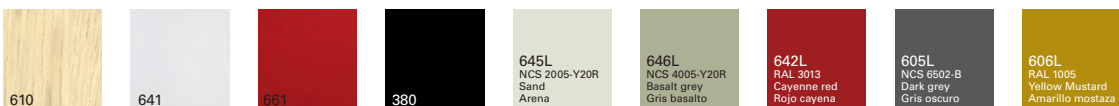

Certificates
Certificados

Fireproof polyurethane foam

Espuma de poliuretano ignifuga

UNE EN 1021:2006
BS 5852 part 2 crib 5
UNI 9175 Classe 1 IM
BKZ 5.2
California TB 117:2013
California TB 133*

*Contact our Customer Department
*Consultar con nuestro Departamento Comercial

Quality - Resistance
Calidad - Resistencia

UNE EN 16139:2013

Intellectual property Propiedad intelectual

All our collections are protected by international industrial design registries, designs patents, copyrights and intellectual Property laws. Unauthorized use of AW International Property is a criminal offence and can lead to prosecution.
Todas nuestras colecciones están protegidas por registros de diseño industrial, diseño de patente, copyright y derechos de propiedad intelectual en todo el mundo. El uso no autorizado de los diseños y propiedad intelectual de AW supone un delito que puede ser sometido a acción judicial.



SI2270

Chair with upholstered seat or upholstered seat and backrest and structure in solid ash wood.
Silla con asiento tapizado o asiento y respaldo tapizado y estructura de madera maciza de fresno.

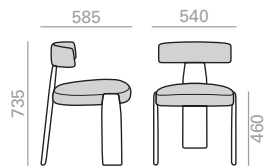

Upholstered seat and back
Asiento y respaldo tapizado



Upholstered seat
Asiento tapizado



Matte lacquered and premium upcharge
Incremento por lacado mate y premium | 47 |

COM cm. per unit	COL m2
------------------	--------

0,28 m3
12,5 kg
x1

Upholstered seat and back
Asiento y respaldo tapizado

1 units	90	2
10 units or more	60	

Upholstered seat Asiento tapizado

1 units	90	2
10 units or more	50	

COM	COL	1	2	3	4	5	6	7	8	9	10	11	L1	L2	L3	L6
640	647	656	663	669	679	687	697	707	707	726	734	744	753	787	849	1.014

COM	COL	1	2	3	4	5	6	7	8	9	10	11	L1	L2	L3	L6
650	654	660	666	670	677	684	690	697	704	711	719	726	731	756	801	920

SO2271

Armchair with upholstered seat or upholstered seat and backrest and structure in solid ash wood.
Sillón con asiento tapizado o asiento y respaldo tapizado y estructura de madera maciza de fresno.

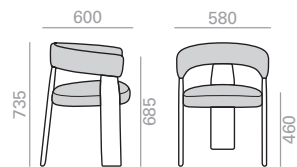

Upholstered seat and back
Asiento y respaldo tapizado



Upholstered seat
Asiento tapizado



Matte lacquered and premium upcharge
Incremento por lacado mate y premium | 47 |

COM cm. per unit	COL m2
------------------	--------

0,31 m3
15,5 kg
x1

Upholstered seat and back
Asiento y respaldo tapizado

1 units	150	3
10 units or more	90	

Upholstered seat Asiento tapizado

1 units	90	2
10 units or more	50	

COM	COL	1	2	3	4	5	6	7	8	9	10	11	L1	L2	L3	L6
744	754	766	776	783	796	809	821	834	847	860	873	887	899	944	1.030	1.256

COM	COL	1	2	3	4	5	6	7	8	9	10	11	L1	L2	L3	L6
797	803	809	814	817	824	831	839	846	851	859	866	873	879	903	949	1.069

SO2273

Armchair with upholstered seat or upholstered seat and backrest and structure in solid ash wood. Wide version.
Sillón con asiento tapizado o asiento y respaldo tapizado y estructura de madera maciza de fresno. Versión ancha.

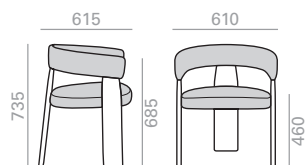

Upholstered seat and back
Asiento y respaldo tapizado



Upholstered seat
Asiento tapizado



Matte lacquered and premium upcharge
Incremento por lacado mate y premium | 47 |

COM cm. per unit	COL m2
------------------	--------

0,34 m3
17,5 kg
x1

Upholstered seat and back
Asiento y respaldo tapizado

1 units	150	3
10 units or more	100	

Upholstered seat Asiento tapizado

1 units	90	2
10 units or more	60	

COM	COL	1	2	3	4	5	6	7	8	9	10	11	L1	L2	L3	L6
750	760	773	784	793	807	821	836	850	864	879	893	907	919	970	1.064	1.313

COM	COL	1	2	3	4	5	6	7	8	9	10	11	L1	L2	L3	L6
811	816	823	829	833	840	847	854	861	869	876	883	890	896	921	969	1.093

BQ2274

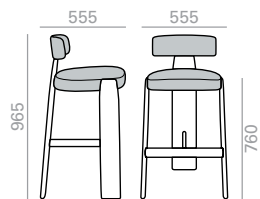

High stool with upholstered seat or upholstered seat and backrest and solid ash wood structure.
Banqueta alta con asiento tapizado o asiento y respaldo tapizado y estructura de madera maciza de fresno.

COM cm. per unit	COL m2
------------------	--------

0,36 m3
12,5 kg
x1

Upholstered seat and back Asiento y respaldo tapizado		
1 units	80	1,75
10 units or more	60	

Upholstered seat Asiento tapizado		
1 units	80	1,75
10 units or more	50	



COM	COL	1	2	3	4	5	6	7	8	9	10	11	L1	L2	L3	L6
793	799	806	813	819	827	836	846	854	863	871	880	889	897	929	987	1.140

Upholstered seat and back
Asiento y respaldo tapizado



COM	COL	1	2	3	4	5	6	7	8	9	10	11	L1	L2	L3	L6
804	809	814	820	823	830	836	841	849	854	860	867	873	879	901	941	1.050

Upholstered seat
Asiento tapizado



Matte lacquered and premium upcharge
Incremento por lacado mate y premium | 47 |

BQ2275

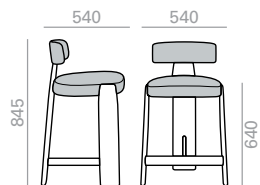

Low stool with upholstered seat or upholstered seat and backrest and solid ash wood structure.
Banqueta baja con asiento tapizado o asiento y respaldo tapizado y estructura de madera maciza de fresno.

COM cm. per unit	COL m2
------------------	--------

0,32 m3
11,5 kg
x1

Upholstered seat and back Asiento y respaldo tapizado		
1 units	80	1,75
10 units or more	60	

Upholstered seat Asiento tapizado		
1 units	80	1,75
10 units or more	50	



COM	COL	1	2	3	4	5	6	7	8	9	10	11	L1	L2	L3	L6
793	799	806	813	819	827	836	846	854	863	871	880	889	897	929	987	1.140

Upholstered seat and back
Asiento y respaldo tapizado



COM	COL	1	2	3	4	5	6	7	8	9	10	11	L1	L2	L3	L6
804	809	814	820	823	830	836	841	849	854	860	867	873	879	901	941	1.050

Upholstered seat
Asiento tapizado



Matte lacquered and premium upcharge
Incremento por lacado mate y premium | 47 |

BU2277

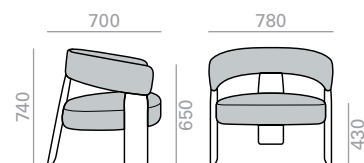

Armchair with upholstered seat and backrest and solid ash wood structure.
Butaca con asiento y respaldo tapizado y estructura de madera maciza de fresno.

COM cm. per unit	COL m2
------------------	--------

0,48 m3
32 kg
x1

1 units	160	3,25
10 units or more	160	

COM	COL	1	2	3	4	5	6	7	8	9	10	11	L1	L2	L3	L6
894	911	930	947	959	980	1.001	1.023	1.044	1.066	1.087	1.109	1.130	1.149	1.226	1.367	1.739



Matte lacquered and premium upcharge
Incremento por lacado mate y premium | 39 |

For wooden legs. Para bases de madera.



Optional glides on page 482.

Opciones de tacos deslizantes en página 482.

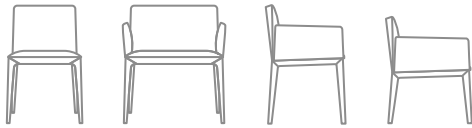

Description
Descripción

Side chairs, armchairs and lounge chairs made of solid beech wood frame with upholstered seat and back. Corporate version available in chair and armchair.
Sillas, sillones y butaca con asiento y respaldo tapizado y estructura de madera maciza de haya. Disponible versión Corporate en silla y sillón.

Upholstery
Tapicería

The Pillow collection supports following upholsteries of Andreu World Catalogue. For fabrics in our catalogue not specified in this box or customers own materials please contact our Customer Service Department.
La colección Pillow admite las siguientes tapicerías del catálogo de Andreu World. Para las telas de nuestro catálogo no indicadas en este cuadro o telas cliente, consultar con nuestro Departamento Comercial.

Fabrics / Telas

- 1** Soft-fiber
Jacquard One
Jacquard Three
Citadel
Sand
Era
Gravity
Rivet
Urban
Reel One (in/out)
Spin One
Spin Two
Spin Three
Spin Four
Spin Five
- 2** Jacquard Two
Solid & Stripes
Loom One
Circular One Pure Eco
Tack One (in/out)

- 3** Jacquard Four
Medley
Revive 1
Natte
Main Line Flax
Loom Two (in/out)
Mezzo
Reel two (in/out)
Jacquard Five
- 4** Jacquard 4 Special
Field 2
Remix 3
Heritage
Savane
Loom Three
Loom Four
Cura
Oceanic
Reel Three (in/out)
Reel Four (in/out)
Reflect
Spin Six

- 5** Silk
Synergy
Step
Step Melange
Blazer
Melange Nap
Chili
Noma
Re-wool
- 6** Go check
Swing
Chartres
Zori
Patio
Tack Two (in/out)
Tack Three (in/out)
- 7** Canvas 2
Select
Clara 2
Tack Five (in/out)
Hero 2

- 8** Capture
Fiord 2
Tonus 4
Divina 3
Lopi
Domino
Atrium
- 9** Divina MD
Divina Melange 3
Hallingdal 65
Steelcut Trio 3
Tack Four (in/out)
- 11** Arda
Ecriture
Zero

Faux Leather / Ecopiel

- 1** Valencia
- 2** Silvertex
- 3** Maglia
- 4** Dolce
- 8** Ultraleather
- 9** Brisa
Brisa Distressed
Fresco
Ultraleather Pro
Promessa
- 10** Tottori
Coast (in/out)
- 11** Reef Pro
Volar Bio

Leather / Piel

- L1** High grade cow leather.
Piel de vaca de 1ª categoría.
- L3** Polished full grain leather.
Piel de vaca pulida.
- L6** Aniline leather batique-effect.
Scandinavian cattle.
Piel anilina efecto batique.
Ganado escandinavo.

Wood finish Beech
Acabado madera Haya

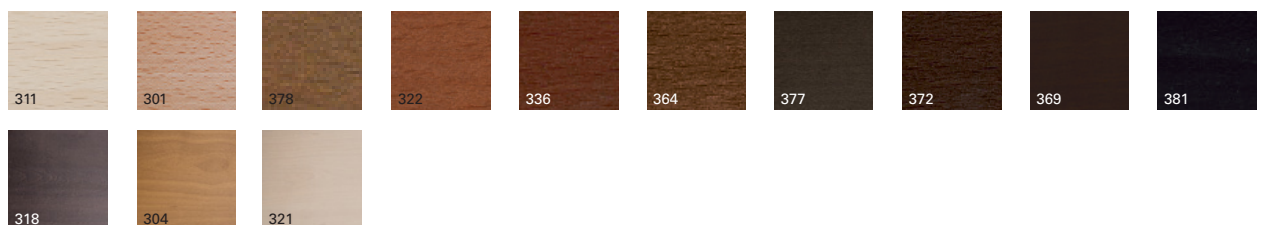

Premium finish and wood lacquers
Acabado premium y lacas madera



Certificates
Certificados

Fireproof polyurethane foam
Espuma de poliuretano ignifuga

UNE EN 1021:2006
BS 5852 part 2 crib 5
UNI 9175 Classe 1 IM
BKZ 5.2
California TB 117:2013
California TB 133*

*Contact our Customer Department
*Consultar con nuestro Departamento Comercial

Quality - Resistance
Calidad - Resistencia

UNE EN 16139:2013

Intellectual property Propiedad intelectual

All our collections are protected by international industrial design registries, designs patents, copyrights and intellectual Property laws. Unauthorized use of AW International Property is a criminal offence and can lead to prosecution.
Todas nuestras colecciones están protegidas por registros de diseño industrial, diseño de patente, copyright y derechos de propiedad intelectual todo el mundo. El uso no autorizado de los diseños y propiedad intelectual de AW supone un delito que puede ser sometido a acción judicial.



SI1540

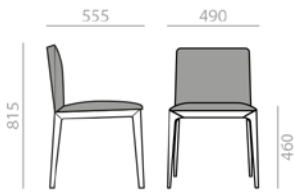

Chair with upholstered seat and backrest and solid beech wood frame.
Silla con asiento y respaldo tapizado y estructura de madera maciza de haya.

	COM cm. per unit	COL m2
1 units	130	2,5
10 units or more	90	

0,36 m3
 21,6 kg
 x2

€	COM	COL	1	2	3	4	5	6	7	8	9	10	11	L1	L2	L3	L6
	497	505	515	525	530	543	554	565	576	588	604	619	631	640	682	762	971

SERIE 600	Matte lacquered and premium upcharge Incremento por lacado mate y premium	32	SERIE 800	Bright lacquered upcharge Incremento por lacado brillo	47
------------------	--	----	------------------	---	----

SO1541

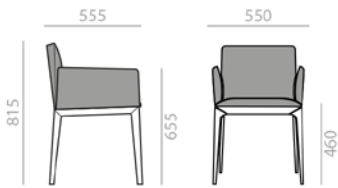

Armchair with upholstered seat, backrest and arms. Solid beech wood frame.
Sillón con asiento, brazos y respaldo tapizados y estructura de madera maciza de haya.

	COM cm. per unit	COL m2
1 units	180	3,5
10 units or more	170	

0,29 m3
 12,3 kg
 x1

€	COM	COL	1	2	3	4	5	6	7	8	9	10	11	L1	L2	L3	L6
	639	656	675	691	704	724	746	767	789	822	846	867	891	910	992	1.141	1.536

SERIE 600	Matte lacquered and premium upcharge Incremento por lacado mate y premium	32	SERIE 800	Bright lacquered upcharge Incremento por lacado brillo	47
------------------	--	----	------------------	---	----

SI1542

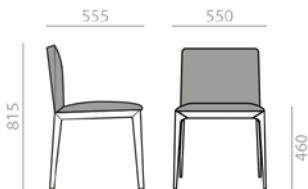

Chair with upholstered seat and backrest and solid beech wood frame. Wider version.
Silla con asiento y respaldo tapizado y estructura de madera maciza de haya. Versión ancha.

	COM cm. per unit	COL m2
1 units	130	2,5
10 units or more	100	

0,45 m3
 22 kg
 x2

€	COM	COL	1	2	3	4	5	6	7	8	9	10	11	L1	L2	L3	L6
	501	511	522	532	538	551	563	577	589	602	619	633	645	657	704	790	1.018

SERIE 600	Matte lacquered and premium upcharge Incremento por lacado mate y premium	32	SERIE 800	Bright lacquered upcharge Incremento por lacado brillo	47
------------------	--	----	------------------	---	----

SO1543

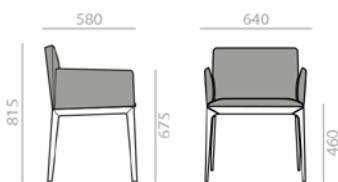

Armchair with upholstered seat, backrest and arms. Solid beech wood frame. Wider version.
Sillón con asiento, brazos y respaldo tapizados y estructura de madera maciza de haya. Versión ancha.

	COM cm. per unit	COL m2
1 units	190	4
10 units or more	185	

0,36 m3
 12,7 kg
 x1

€	COM	COL	1	2	3	4	5	6	7	8	9	10	11	L1	L2	L3	L6
	717	735	757	775	789	813	837	870	898	922	949	973	1.001	1.022	1.115	1.284	1.728

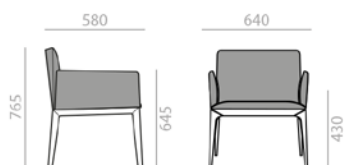

SERIE 600	Matte lacquered and premium upcharge Incremento por lacado mate y premium	32	SERIE 800	Bright lacquered upcharge Incremento por lacado brillo	47
------------------	--	----	------------------	---	----

BU1544



 Lounge chair with upholstered seat, backrest and arms. Solid beech wood frame.
Butaca con asiento, brazos y respaldo tapizados y estructura de madera maciza de haya.

	COM cm. per unit	COL m2
1 units	205	4
10 units or more	185	

 0,32 m3
 13 kg
 x1

€	COM	COL	1	2	3	4	5	6	7	8	9	10	11	L1	L2	L3	L6
	732	749	771	789	803	826	851	874	898	937	962	989	1.013	1.036	1.129	1.297	1.744

SERIE 600	Matte lacquered and premium upcharge Incremento por lacado mate y premium	32	SERIE 800	Bright lacquered upcharge Incremento por lacado brillo	47
-----------	--	----	-----------	---	----

For wooden legs. Para bases de madera.



Optional glides on page 482.
Opciones de tacos deslizantes en página 482.

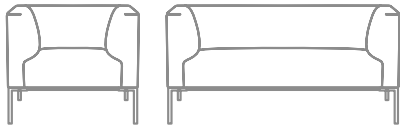

Description
Descripción

Lounge chairs and armchairs with upholstered seat and back with 4 injected aluminum legs in polished aluminum, matte white or matte black finishes. Available in bench version of 1, 2 or 3 seats, in 2 different leg heights. Edge piping is available in matching textile or white, black or sand colors. In case of any other piping combination, contact our Customer Department.

Butacas y sofás con asiento y respaldo tapizado y base de 4 patas de inyección de aluminio y acabado aluminio pulido, blanco mate o negro mate. Disponible versión de bancada de 1, 2 o 3 plazas en 2 diferentes altura de pata. Ribete perimetral disponible en tapicería al tono, o en color blanco, negro o arena. En caso de cualquier otra combinación de ribete, consulte con nuestro Departamento Comercial.

Upholstery
Tapicería

The Raglan collection supports following upholsteries of Andreu World Catalogue. For fabrics in our catalogue not specified in this box or customers own materials please contact our Customer Service Department.

La colección Raglan admite las siguientes tapicerías del catálogo de Andreu World. Para las telas de nuestro catálogo no indicadas en este cuadro o telas cliente, consultar con nuestro Departamento Comercial.

Fabrics / Telas

- 1** Soft-fiber
Jacquard One
Jacquard Three
Citadel
Sand
Era
Gravity
Rivet
Urban
Reel One (in/out)
Spin One
Spin Two
Spin Three
Spin Four
Spin Five
- 2** Jacquard Two
Solid & Stripes
Loom One
Circular One Pure Eco
Tack One (in/out)

- 3** Jacquard Four
Medley
Revive 1
Natte
Main Line Flax
Loom Two (in/out)
Mezzo
Reel two (in/out)
Jacquard Five

- 4** Jacquard 4 Special
Nexus
Field 2
Remix 3
Heritage
Savane
Loom Three
Loom Four
Cura
Oceanic
Reel Three (in/out)
Reel Four (in/out)
Reflect
Spin Six

- 5** Silk
Synergy
Step
Step Melange
Blazer
Melange Nap
Chili
Noma
Re-wool

- 6** Go check
Swing
Chartres
Zori
Patio
Tack Two (in/out)
Tack Three (in/out)

- 7** Canvas 2
Select
Clara 2
Tack Five (in/out)
Hero 2

- 8** Capture
Fiord 2
Tonus 4
Divina 3
Lopi
Domino
Atrium
- 9** Divina MD
Divina Melange 3
Hallingdal 65
Steelcut Trio 3
Tack Four (in/out)

- 11** Arda
Ecriture
Zero

Faux Leather / Ecopiel

- 1** Valencia
- 2** Silvertex
- 3** Maglia
- 4** Dolce
- 8** Ultraleather
- 9** Brisa
Brisa Distressed
Fresco
Ultraleather Pro
Promessa
- 10** Tottori
Coast (in/out)
- 11** Reef Pro
Volar Bio

Leather / Piel

- L1** High grade cow leather.
Piel de vaca de 1ª categoría.
- L3** Polished full grain leather.
Piena flor pulida.
- L6** Aniline leather batique-effect.
Scandinavian cattle.
Piel anilina efecto batique.
Ganado escandinavo.

Piping finish
Acabado ribete



Aluminum finish
Acabado aluminio



Certificates
Certificados

Fireproof polyurethane foam

Espuma de poliuretano ignifuga

UNE EN 1021:2006
BS 5852 part 2 crib 5
UNI 9175 Classe 1 IM
BKZ 5.2
California TB 117:2013
California TB 133*

*Contact our Customer Department
*Consultar con nuestro Departamento Comercial

Quality - Resistance
Calidad - Resistencia

UNE EN 16139:2013

Intellectual property Propiedad intelectual

All our collections are protected by international industrial design registries, designs patents, copyrights and intellectual Property laws. Unauthorized use of AW International Property is a criminal offence and can lead to prosecution.
Todas nuestras colecciones están protegidas por registros de diseño industrial, diseño de patente, copyright y derechos de propiedad intelectual en todo el mundo. El uso no autorizado de los diseños y propiedad intelectual de AW supone un delito que puede ser sometido a acción judicial.



BU2065

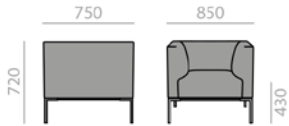

Lounge chair with upholstered seat and backrest and 4-legs aluminum injected base available in different finishes.

Butaca con asiento y respaldo tapizado y base de 4 patas de inyección de aluminio disponible en diferentes acabados.

	COM cm. per unit	COL m2
1 units	360	7,1
10 units or more	360	

0,6 m3
 40 kg
 x1

€	COM	COL	1	2	3	4	5	6	7	8	9	10	11	L1	L2	L3	L6
	1.566	1.606	1.654	1.694	1.725	1.778	1.832	1.885	1.939	1.992	2.046	2.099	2.153	2.200	2.393	2.745	3.712



USB charging system upcharge
 Incremento por sistema de USB de carga

| 195 |



Polished chrome upcharge
 Incremento cromo brillo

| 90 |

SF2066

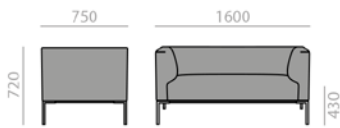

2-seater sofa with upholstered seat and backrest and 4-legs aluminum injected base available in different finishes.

Sofá de 2 plazas con asiento y respaldo tapizado y base de 4 patas de inyección de aluminio disponible en diferentes acabados.

	COM cm. per unit	COL m2
1 units	500	9,8
10 units or more	500	

1,02 m3
 58 kg
 x1

€	COM	COL	1	2	3	4	5	6	7	8	9	10	11	L1	L2	L3	L6
	1.940	1.992	2.056	2.107	2.147	2.217	2.287	2.356	2.426	2.495	2.570	2.645	2.722	2.789	3.064	3.567	4.894



USB charging system upcharge
 Incremento por sistema de USB de carga

| 195 |



Polished chrome upcharge
 Incremento cromo brillo

| 129 |

SF2067

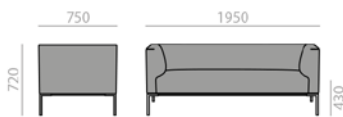

3-seater sofa with upholstered seat and backrest and 4-legs aluminum injected base available in different finishes.

Sofá de 3 plazas con asiento y respaldo tapizado y base de 4 patas de inyección de aluminio disponible en diferentes acabados.

	COM cm. per unit	COL m2
1 units	570	11,2
10 units or more	570	

1,2 m3
 66 kg
 x1

€	COM	COL	1	2	3	4	5	6	7	8	9	10	11	L1	L2	L3	L6
	2.191	2.252	2.327	2.388	2.435	2.517	2.597	2.679	2.760	2.841	2.925	3.014	3.104	3.183	3.502	4.087	5.632



USB charging system upcharge
 Incremento por sistema de USB de carga

| 195 |



Polished chrome upcharge
 Incremento cromo brillo

| 150 |

SF2068

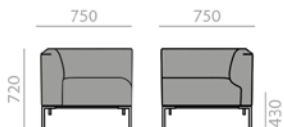

1-seater corner sofa with upholstered seat and back and 4-legs injected aluminum base available in different finishes. Left side.

Sofá rinconero de 1 plaza con asiento y respaldo tapizado y base de 4 patas de inyección de aluminio disponible en diferentes acabados. Lado izquierdo.

	COM cm. per unit	COL m2
1 units	360	7,1
10 units or more	360	

0,46 m3
 33 kg
 x1

€	COM	COL	1	2	3	4	5	6	7	8	9	10	11	L1	L2	L3	L6
	1.422	1.459	1.505	1.542	1.571	1.621	1.671	1.721	1.771	1.821	1.871	1.919	1.969	2.014	2.194	2.523	3.440



USB charging system upcharge
 Incremento por sistema de USB de carga

| 195 |



Polished chrome upcharge
 Incremento cromo brillo

| 84 |

SF2069

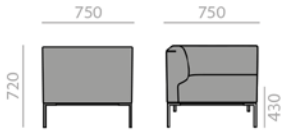

1-seater corner sofa with upholstered seat and back and 4-legs injected aluminum base available in different finishes. Right side.

Sofá rinconero de 1 plaza con asiento y respaldo tapizado y base de 4 patas de inyección de aluminio disponible en diferentes acabados. Lado derecho.

	COM cm. per unit	COL m2
1 units	360	7,1
10 units or more	360	

0,46 m3
 33 kg
 x1

€	COM	COL	1	2	3	4	5	6	7	8	9	10	11	L1	L2	L3	L6
	1.422	1.459	1.505	1.542	1.571	1.621	1.671	1.721	1.771	1.821	1.871	1.919	1.969	2.014	2.194	2.523	3.440



USB charging system upcharge
 Incremento por sistema de USB de carga

| 195 |



Polished chrome upcharge
 Incremento cromo brillo

| 84 |

SF2070

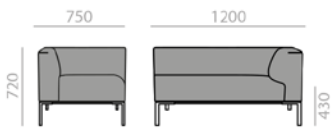

2-seater corner sofa with upholstered seat and back and 4-legs injected aluminum base available in different finishes. Left side.

Sofá rinconero de 2 plazas con asiento y respaldo tapizado y base de 4 patas de inyección de aluminio disponible en diferentes acabados. Lado izquierdo.

	COM cm. per unit	COL m2
1 units	500	9,8
10 units or more	500	

0,76 m3
 49 kg
 x1

€	COM	COL	1	2	3	4	5	6	7	8	9	10	11	L1	L2	L3	L6
	1.760	1.811	1.874	1.925	1.965	2.034	2.102	2.171	2.240	2.315	2.393	2.469	2.545	2.614	2.890	3.392	4.723



USB charging system upcharge
 Incremento por sistema de USB de carga

| 195 |



Polished chrome upcharge
 Incremento cromo brillo

| 108 |

SF2071

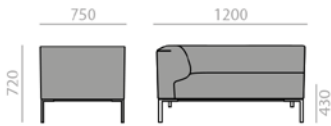

2-seater corner sofa with upholstered seat and back and 4-legs injected aluminum base available in different finishes. Right side.

Sofá rinconero de 2 plazas con asiento y respaldo tapizado y base de 4 patas de inyección de aluminio disponible en diferentes acabados. Lado derecho.

	COM cm. per unit	COL m2
1 units	500	9,8
10 units or more	500	

0,76 m3
 49 kg
 x1

€	COM	COL	1	2	3	4	5	6	7	8	9	10	11	L1	L2	L3	L6
	1.760	1.811	1.874	1.925	1.965	2.034	2.102	2.171	2.240	2.315	2.393	2.469	2.545	2.614	2.890	3.392	4.723



USB charging system upcharge
 Incremento por sistema de USB de carga

| 195 |



Polished chrome upcharge
 Incremento cromo brillo

| 108 |

SF2072

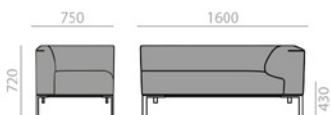

3-seater corner sofa with upholstered seat and back and 4-legs injected aluminum base available in different finishes. Left side.

Sofá rinconero de 3 plazas con asiento y respaldo tapizado y base de 4 patas de inyección de aluminio disponible en diferentes acabados. Lado izquierdo.

	COM cm. per unit	COL m2
1 units	580	11,4
10 units or more	580	

1,12 m3
 60,7 kg
 x1

€	COM	COL	1	2	3	4	5	6	7	8	9	10	11	L1	L2	L3	L6
	2.054	2.116	2.192	2.253	2.301	2.384	2.467	2.549	2.632	2.713	2.796	2.879	2.961	3.036	3.333	3.920	5.486



USB charging system upcharge
 Incremento por sistema de USB de carga

| 195 |



Polished chrome upcharge
 Incremento cromo brillo

| 129 |

SF2073

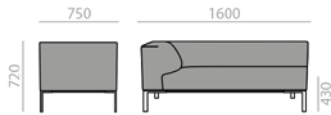

3-seater corner sofa with upholstered seat and back and 4-legs injected aluminum base available in different finishes. Right side.

Sofá rinconero de 3 plazas con asiento y respaldo tapizado y base de 4 patas de inyección de aluminio disponible en diferentes acabados. Lado derecho.

	COM cm. per unit	COL m2
1 units	580	11,4
10 units or more	580	

1,12 m3
60,7 kg
x1

€	COM	COL	1	2	3	4	5	6	7	8	9	10	11	L1	L2	L3	L6
	2.054	2.116	2.192	2.253	2.301	2.384	2.466	2.549	2.632	2.713	2.796	2.879	2.961	3.034	3.333	3.918	5.483



USB charging system upcharge
Incremento por sistema de USB de carga

| 195 |



Polished chrome upcharge
Incremento cromo brillo

| 129 |

SF2117

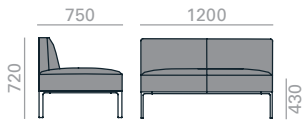

2-seater sofa with upholstered seat and back and 4-legs injected aluminum base available in different finishes.

Sofá de 2 plazas con asiento y respaldo tapizado y base de 4 patas de inyección de aluminio disponible en diferentes acabados.

	COM cm. per unit	COL m2
1 units	330	6,75
10 units or more	330	

0,92 m3
46 kg
x1

€	COM	COL	1	2	3	4	5	6	7	8	9	10	11	L1	L2	L3	L6
	1.578	1.613	1.657	1.692	1.719	1.767	1.813	1.860	1.908	1.954	2.001	2.048	2.095	2.137	2.306	2.614	3.474



Polished chrome upcharge
Incremento cromo brillo

| 108 |

SF2118

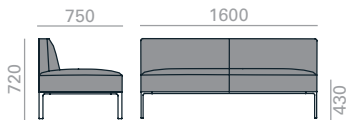

3-seater sofa with upholstered seat and back and 4-legs injected aluminum base available in different finishes.

Sofá de 3 plazas con asiento y respaldo tapizado y base de 4 patas de inyección de aluminio disponible en diferentes acabados.

	COM cm. per unit	COL m2
1 units	400	8
10 units or more	400	

1,09 m3
58 kg
x1

€	COM	COL	1	2	3	4	5	6	7	8	9	10	11	L1	L2	L3	L6
	1.728	1.771	1.823	1.865	1.898	1.954	2.012	2.068	2.124	2.181	2.240	2.303	2.367	2.420	2.646	3.058	4.147



Polished chrome upcharge
Incremento cromo brillo

| 129 |

SF2119

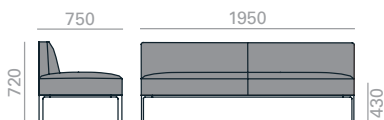

3-seater sofa with upholstered seat and back and 4-legs injected aluminum base available in different finishes. Wider version.

Sofá de 3 plazas con asiento y respaldo tapizado y base de 4 patas de inyección de aluminio disponible en diferentes acabados. Versión ancha.

	COM cm. per unit	COL m2
1 units	480	9,75
10 units or more	480	

1,2 m3
65 kg
x1

€	COM	COL	1	2	3	4	5	6	7	8	9	10	11	L1	L2	L3	L6
	1.867	1.918	1.981	2.032	2.073	2.140	2.210	2.277	2.346	2.415	2.483	2.552	2.620	2.682	2.929	3.380	4.574



Polished chrome upcharge
Incremento cromo brillo

| 150 |

SF2120

2-seater sofa with upholstered seat and backrest and 4-legs injected aluminum base available in different finishes. Left side.

Sofá de 2 plazas con asiento y respaldo tapizado y base de 4 patas de inyección de aluminio disponible en diferentes acabados. Lado izquierdo.

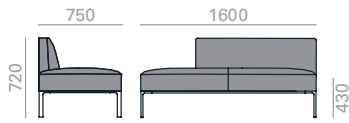

	COM cm. per unit	COL m2
1 units	350	7
10 units or more	350	

0,98 m3
58 kg
x1

€	COM	COL	1	2	3	4	5	6	7	8	9	10	11	L1	L2	L3	L6
	1.907	1.945	1.990	2.027	2.056	2.106	2.155	2.205	2.254	2.303	2.354	2.404	2.453	2.497	2.676	3.002	3.899



SF2121

2-seater sofa with upholstered seat and backrest and 4-legs injected aluminum base available in different finishes. Right side.

Sofá de 2 plazas con asiento y respaldo tapizado y base de 4 patas de inyección de aluminio disponible en diferentes acabados. Lado derecho.

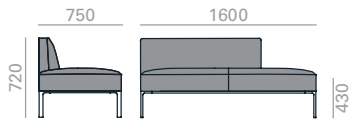

	COM cm. per unit	COL m2
1 units	350	7
10 units or more	350	

0,98 m3
58 kg
x1

€	COM	COL	1	2	3	4	5	6	7	8	9	10	11	L1	L2	L3	L6
	1.907	1.945	1.990	2.027	2.056	2.106	2.155	2.205	2.254	2.303	2.354	2.404	2.453	2.497	2.676	3.002	3.899



SF2122

3-seater sofa with upholstered seat and backrest and 4-legs injected aluminum base available in different finishes. Left side.

Sofá de 3 plazas con asiento y respaldo tapizado y base de 4 patas de inyección de aluminio disponible en diferentes acabados. Lado izquierdo.

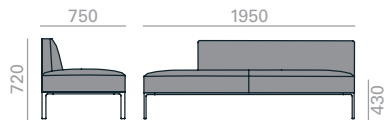

	COM cm. per unit	COL m2
1 units	450	9
10 units or more	450	

1,2 m3
65 kg
x1

€	COM	COL	1	2	3	4	5	6	7	8	9	10	11	L1	L2	L3	L6
	1.999	2.044	2.100	2.145	2.181	2.241	2.301	2.363	2.423	2.483	2.544	2.607	2.673	2.731	2.971	3.410	4.566



SF2123

3-seater sofa with upholstered seat and backrest and 4-legs injected aluminum base available in different finishes. Right side.

Sofá de 3 plazas con asiento y respaldo tapizado y base de 4 patas de inyección de aluminio disponible en diferentes acabados. Lado derecho.

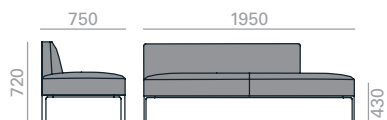

	COM cm. per unit	COL m2
1 units	450	9
10 units or more	450	

1,2 m3
65 kg
x1

€	COM	COL	1	2	3	4	5	6	7	8	9	10	11	L1	L2	L3	L6
	1.999	2.044	2.100	2.145	2.181	2.241	2.301	2.363	2.423	2.483	2.544	2.607	2.673	2.731	2.971	3.410	4.566

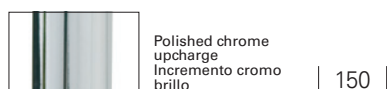

SF2124

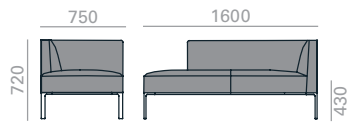

2-seater corner sofa with upholstered seat and backrest and 4-legs injected aluminum base available in different finishes. Left side.

Sofá rinconero de 2 plazas con asiento y respaldo tapizado y base de 4 patas de inyección de aluminio disponible en diferentes acabados. Lado izquierdo.

	COM cm. per unit	COL m2
1 units	450	8,75
10 units or more	450	

0,98 m3
 58 kg
 x1

€	COM	COL	1	2	3	4	5	6	7	8	9	10	11	L1	L2	L3	L6
	1.891	1.936	1.991	2.036	2.070	2.130	2.189	2.249	2.308	2.368	2.429	2.492	2.557	2.615	2.854	3.284	4.426



USB charging system upcharge
 Incremento por sistema de USB de carga

| 195 |



Polished chrome upcharge
 Incremento cromo brillo

| 129 |

SF2125

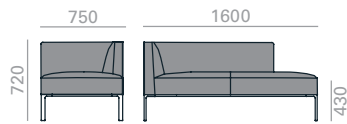

2-seater corner sofa with upholstered seat and backrest and 4-legs injected aluminum base available in different finishes. Right side.

Sofá rinconero de 2 plazas con asiento y respaldo tapizado y base de 4 patas de inyección de aluminio disponible en diferentes acabados. Lado derecho.

	COM cm. per unit	COL m2
1 units	450	8,75
10 units or more	450	

0,98 m3
 58 kg
 x1

€	COM	COL	1	2	3	4	5	6	7	8	9	10	11	L1	L2	L3	L6
	1.891	1.936	1.991	2.036	2.070	2.130	2.189	2.249	2.308	2.368	2.429	2.492	2.557	2.615	2.854	3.284	4.426



USB charging system upcharge
 Incremento por sistema de USB de carga

| 195 |



Polished chrome upcharge
 Incremento cromo brillo

| 129 |

SF2126

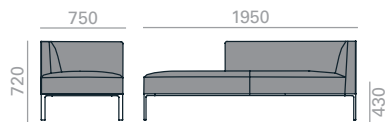

3-seater corner sofa with upholstered seat and backrest and 4 aluminum injected legs base available in different finishes. Left side

Sofá rinconero de 3 plazas con asiento y respaldo tapizado y base de 4 patas de inyección de aluminio disponible en diferentes acabados. Lado izquierdo.

	COM cm. per unit	COL m2
1 units	500	10
10 units or more	500	

1,2 m3
 65 kg
 x1

€	COM	COL	1	2	3	4	5	6	7	8	9	10	11	L1	L2	L3	L6
	2.067	2.120	2.183	2.234	2.275	2.344	2.412	2.481	2.550	2.619	2.688	2.757	2.825	2.887	3.135	3.588	4.868



USB charging system upcharge
 Incremento por sistema de USB de carga

| 195 |



Polished chrome upcharge
 Incremento cromo brillo

| 150 |

SF2127

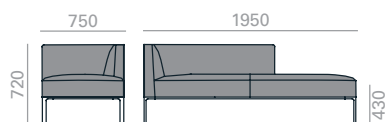

3-seater corner sofa with upholstered seat and backrest and 4-legs injected aluminum base available in different finishes. Right side

Sofá rinconero de 3 plazas con asiento y respaldo tapizado y base de 4 patas de inyección de aluminio disponible en diferentes acabados. Lado derecho.

	COM cm. per unit	COL m2
1 units	500	10
10 units or more	500	

1,2 m3
 65 kg
 x1

€	COM	COL	1	2	3	4	5	6	7	8	9	10	11	L1	L2	L3	L6
	2.067	2.120	2.183	2.234	2.275	2.344	2.412	2.481	2.550	2.619	2.688	2.757	2.825	2.887	3.135	3.588	4.868



USB charging system upcharge
 Incremento por sistema de USB de carga

| 195 |



Polished chrome upcharge
 Incremento cromo brillo

| 150 |

SF2128

3-seater corner sofa with upholstered seat and backrest and 4 aluminum injected legs base available in different finishes. Left side

Sofá rinconero de 3 plazas con asiento y respaldo tapizado y base de 4 patas de inyección de aluminio disponible en diferentes acabados. Lado izquierdo.

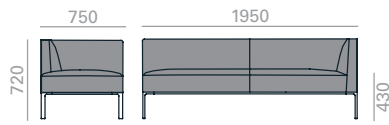

	COM cm. per unit	COL m2
1 units	550	11
10 units or more	550	

1,2 m3
 65 kg
 x1

€	COM	COL	1	2	3	4	5	6	7	8	9	10	11	L1	L2	L3	L6
	2.104	2.160	2.229	2.285	2.329	2.405	2.480	2.556	2.630	2.706	2.781	2.857	2.932	2.999	3.271	3.767	5.079



USB charging system upcharge
 Incremento por sistema de USB de carga

| 195 |

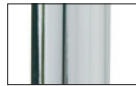

Polished chrome upcharge
 Incremento cromo brillo

| 150 |

SF2129

3-seater corner sofa with upholstered seat and backrest and 4-legs injected aluminum base available in different finishes. Right side

Sofá rinconero de 3 plazas con asiento y respaldo tapizado y base de 4 patas de inyección de aluminio disponible en diferentes acabados. Lado derecho.

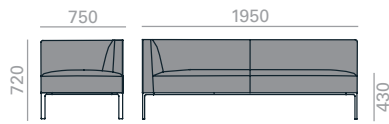

	COM cm. per unit	COL m2
1 units	550	11
10 units or more	550	

1,2 m3
 65 kg
 x1

€	COM	COL	1	2	3	4	5	6	7	8	9	10	11	L1	L2	L3	L6
	2.104	2.160	2.229	2.285	2.329	2.405	2.480	2.556	2.630	2.706	2.781	2.857	2.932	2.999	3.271	3.767	5.079



USB charging system upcharge
 Incremento por sistema de USB de carga

| 195 |



Polished chrome upcharge
 Incremento cromo brillo

| 150 |

SF2134

Corner sofa with chaise lounge with upholstered seat and backrest and 4 legs aluminum injected base available in different finishes. Left side.

Sofá rinconero con chaise lounge con asiento y respaldo tapizado y base de 4 patas de inyección de aluminio disponible en diferentes acabados. Lado izquierdo

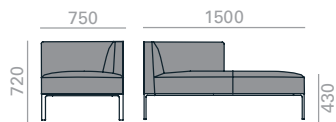

	COM cm. per unit	COL m2
1 units	385	7,75
10 units or more	385	

0,92 m3
 55 kg
 x1

€	COM	COL	1	2	3	4	5	6	7	8	9	10	11	L1	L2	L3	L6
	1.971	2.012	2.063	2.104	2.136	2.191	2.246	2.301	2.358	2.413	2.468	2.523	2.578	2.627	2.826	3.190	4.183



USB charging system upcharge
 Incremento por sistema de USB de carga

| 195 |



Polished chrome upcharge
 Incremento cromo brillo

| 129 |

SF2135

Corner sofa with chaise lounge with upholstered seat and backrest and 4 legs injected aluminum base available in different finishes. Right side.

Sofá rinconero con chaise lounge con asiento y respaldo tapizado y base de 4 patas de inyección de aluminio disponible en diferentes acabados. Lado derecho.

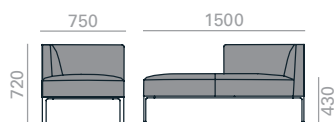

	COM cm. per unit	COL m2
1 units	385	7,75
10 units or more	385	

0,92 m3
 55 kg
 x1

€	COM	COL	1	2	3	4	5	6	7	8	9	10	11	L1	L2	L3	L6
	1.971	2.012	2.063	2.104	2.136	2.191	2.246	2.301	2.358	2.413	2.468	2.523	2.578	2.627	2.826	3.190	4.183



USB charging system upcharge
 Incremento por sistema de USB de carga

| 195 |



Polished chrome upcharge
 Incremento cromo brillo

| 129 |

BC2074

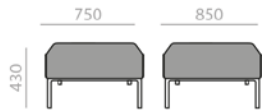

1-seater bench with 4-legged injected aluminum base available in polished aluminum, matte white and matte black. Piping available in fabric to match upholstery on the bench, white, black or sand color.

Bancada de 1 plaza con asiento tapizado y base de 4 patas de inyección de aluminio y acabado aluminio pulido, blanco mate o negro mate. Ribete perimetral disponible en tapicería al tono, o en color blanco, negro o arena.

	COM cm. per unit	COL m2
1 units	130	5
10 units or more	130	

0,33 m3
26,9 kg
x1

€	COM	COL	1	2	3	4	5	6	7	8	9	10	11	L1	L2	L3	L6
	864	877	894	908	918	937	955	973	991	1.010	1.028	1.046	1.064	1.081	1.146	1.267	1.586



Polished chrome upcharge
Incremento cromo brillo

| 210 |

BC2075

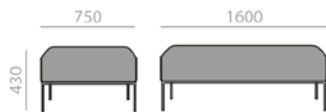

2-seater bench with 4-legged injected aluminum base available in polished aluminum, matte white and matte black. Piping available in fabric to match upholstery on the bench, white, black or sand color.

Bancada de 2 plazas con asiento tapizado y base de 4 patas de inyección de aluminio y acabado aluminio pulido, blanco mate o negro mate. Ribete perimetral disponible en tapicería al tono, o en color blanco, negro o arena.

	COM cm. per unit	COL m2
1 units	210	10
10 units or more	210	

0,61 m3
29,1 kg
x1

€	COM	COL	1	2	3	4	5	6	7	8	9	10	11	L1	L2	L3	L6
	1.128	1.149	1.176	1.199	1.215	1.246	1.276	1.305	1.335	1.364	1.394	1.424	1.453	1.480	1.586	1.781	2.333



Polished chrome upcharge
Incremento cromo brillo

| 275 |

BC2076

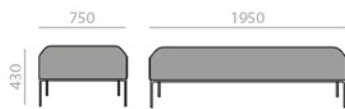

3-seater bench with 4-legged injected aluminum base available in polished aluminum, matte white and matte black. Piping available in fabric to match upholstery on the bench, white, black or sand color.

BancBancada de 3 plazas con asiento tapizado y base de 4 patas de inyección de aluminio y acabado aluminio pulido, blanco mate o negro mate. Ribete perimetral disponible en tapicería al tono, o en color blanco, negro o arena.

	COM cm. per unit	COL m2
1 units	240	12
10 units or more	240	

0,72 m3
46,5 kg
x1

€	COM	COL	1	2	3	4	5	6	7	8	9	10	11	L1	L2	L3	L6
	1.246	1.272	1.302	1.328	1.347	1.381	1.415	1.448	1.482	1.516	1.549	1.584	1.617	1.648	1.768	1.992	2.628



Polished chrome upcharge
Incremento cromo brillo

| 300 |

BC2077

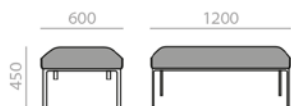

2-seater bench with 4-legged injected aluminum base available in polished aluminum, matte white and matte black. Piping available in fabric to match upholstery on the bench, white, black or sand color.

BancBancada de 2 plazas con asiento tapizado y base de 4 patas de inyección de aluminio y acabado aluminio pulido, blanco mate o negro mate. Ribete perimetral disponible en tapicería al tono, o en color blanco, negro o arena.

	COM cm. per unit	COL m2
1 units	170	7
10 units or more	170	

0,45 m3
24,2 kg
x1

€	COM	COL	1	2	3	4	5	6	7	8	9	10	11	L1	L2	L3	L6
	931	949	971	989	1.003	1.027	1.050	1.075	1.098	1.122	1.147	1.170	1.194	1.216	1.302	1.477	1.937



Polished chrome upcharge
Incremento cromo brillo

| 282 |

BC2078

Bench
Banc



	COM cm. per unit	COL m2
1 units	220	9
10 units or more	220	

0,66 m3
 32,1 kg
 x1

€	COM	COL	1	2	3	4	5	6	7	8	9	10	11	L1	L2	L3	L6
	1.075	1.096	1.124	1.147	1.164	1.193	1.224	1.254	1.283	1.313	1.345	1.381	1.415	1.445	1.566	1.790	2.382



Polished chrome
upcharge
Incremento cromo
brillo

| 326 |

Glides. Tacos.

Use/Usó	Reference/Referencia	Material/Material	Price/Precio
Hard floors. Suelos duros.	TS0419	 Plastic (PE). Plástico (PE).	0 € Standard. Estándar.
Wooden and delicated floors. Suelos de madera y delicados.	TS0420	 Plastic (PE) with felt. Plástico (PE) con fieltro.	5 € Set of 4 glides. Juego de 4 tacos.
Mats/carpet floors. Suelos de moqueta/ alfombra.	TS0421	 Plastic (POM). Plástico (POM).	0 € Standard. Estándar.

The indicated price is for glides placed on chairs. To order loose parts, please ask to our Sales Department.

El precio indicado en Tarifa es para tacos colocados en las sillas. Para pedidos de repuesto, consultar con el Departamento Comercial.

Examples of modular configurations Ejemplos de combinaciones modulares

Set 1 / Conjunto 1

2 Modules 2 Módulos
SF2070 + SF2071

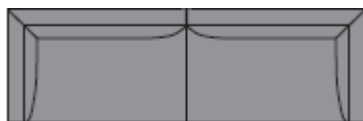

	COM cm. per unit	COL m2
1 units	1000	19,6
10 units or more	1000	

€	COM	COL	1	2	3	4	5	6	7	8	9	10	11	L1	L2	L3	L6
	3.520	3.622	3.748	3.850	3.930	4.068	4.204	4.342	4.480	4.630	4.786	4.938	5.090	5.228	5.780	6.784	9.446

Set 2 / Conjunto 2

2 Modules 2 Módulos
SF2073 + SF2072



	COM cm. per unit	COL m2
1 units	1160	22,8
10 units or more	1160	

€	COM	COL	1	2	3	4	5	6	7	8	9	10	11	L1	L2	L3	L6
	4.108	4.232	4.384	4.506	4.602	4.768	4.933	5.098	5.264	5.426	5.592	5.758	5.922	6.070	6.666	7.838	10.969

Set 3 / Conjunto 3

2 Modules 2 Módulos
SF2073 + SF2067

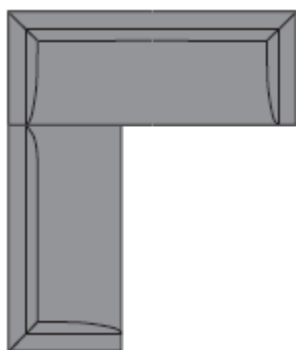

	COM cm. per unit	COL m2
1 units	1150	22,6
10 units or more	1150	

€	COM	COL	1	2	3	4	5	6	7	8	9	10	11	L1	L2	L3	L6
	4.245	4.368	4.519	4.641	4.736	4.901	5.063	5.228	5.392	5.554	5.721	5.893	6.065	6.217	6.835	8.005	11.115

Examples of modular configurations Ejemplos de combinaciones modulares

Set 4 / Conjunto 4

2 Modules 2 Módulos
SF2067 + SF2072

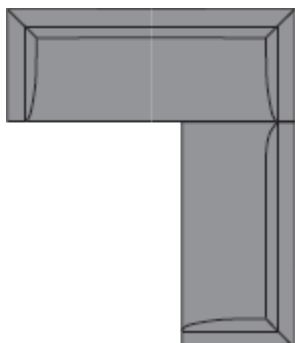

	COM cm. per unit	COL m2
1 units	1150	22,6
10 units or more	1150	

€	COM	COL	1	2	3	4	5	6	7	8	9	10	11	L1	L2	L3	L6
	4.245	4.368	4.519	4.641	4.736	4.901	5.064	5.228	5.392	5.554	5.721	5.893	6.065	6.219	6.835	8.007	11.118

Set 5 / Conjunto 5

3 Modules 3 Módulos
SF2073 + SF2069 + SF2072

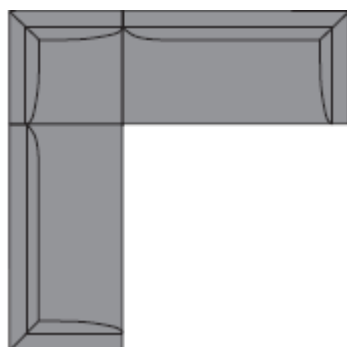

	COM cm. per unit	COL m2
1 units	1520	29,9
10 units or more	1520	

€	COM	COL	1	2	3	4	5	6	7	8	9	10	11	L1	L2	L3	L6
	5.530	5.691	5.889	6.048	6.173	6.389	6.604	6.819	7.035	7.247	7.463	7.677	7.891	8.084	8.860	10.361	14.409

Set 6 / Conjunto 6

4 Modules 4 Módulos
SF2073 + SF2073 + SF2072 + SF2072

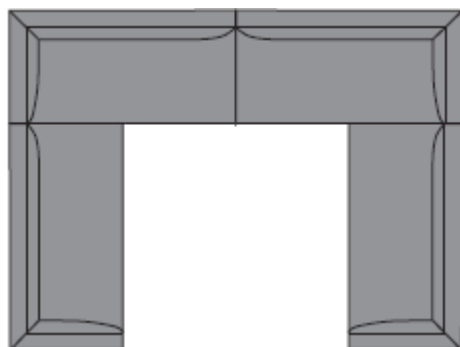

	COM cm. per unit	COL m2
1 units	2320	45,6
10 units or more	2320	

€	COM	COL	1	2	3	4	5	6	7	8	9	10	11	L1	L2	L3	L6
	8.216	8.464	8.768	9.012	9.204	9.536	9.866	10.196	10.528	10.852	11.184	11.516	11.844	12.140	13.332	15.676	21.938

Examples of modular configurations Ejemplos de combinaciones modulares

Set 7 / Conjunto 7

4 Modules 4 Módulos
SF2068 + SF2069 + SF2068 + SF2069

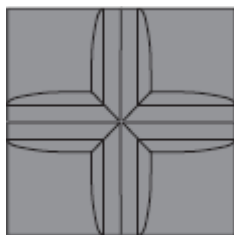

	COM cm. per unit	COL m2
1 units	1440	28,4
10 units or more	1440	

€	COM	COL	1	2	3	4	5	6	7	8	9	10	11	L1	L2	L3	L6
	5.688	5.836	6.020	6.168	6.284	6.484	6.684	6.884	7.084	7.284	7.484	7.676	7.876	8.056	8.776	10.092	13.760

Set 8 / Conjunto 8

2 Modules 2 Módulos
SF2120 + SF2121



	COM cm. per unit	COL m2
1 units	700	14
10 units or more	700	

€	COM	COL	1	2	3	4	5	6	7	8	9	10	11	L1	L2	L3	L6
	3.814	3.890	3.980	4.054	4.112	4.212	4.310	4.410	4.508	4.606	4.708	4.808	4.906	4.994	5.352	6.004	7.798

Set 9 / Conjunto 9

2 Modules 2 Módulos
SF2122 + SF2123



	COM cm. per unit	COL m2
1 units	900	18
10 units or more	900	

€	COM	COL	1	2	3	4	5	6	7	8	9	10	11	L1	L2	L3	L6
	3.998	4.088	4.200	4.290	4.362	4.482	4.602	4.726	4.846	4.966	5.088	5.214	5.346	5.462	5.942	6.820	9.132

Examples of modular configurations Ejemplos de combinaciones modulares

Set 10 / Conjunto 10

3 Modules 3 Módulos
SF2122 + SF2119 + SF2123

	COM cm. per unit	COL m2
1 units	1380	27,75
10 units or more	1380	



€	COM	COL	1	2	3	4	5	6	7	8	9	10	11	L1	L2	L3	L6
	5.865	6.006	6.181	6.322	6.435	6.622	6.812	7.003	7.192	7.381	7.571	7.766	7.966	8.144	8.871	10.200	13.706

Set 11 / Conjunto 11

3 Modules 3 Módulos
SF2120 + SF2118 + SF2121

	COM cm. per unit	COL m2
1 units	1100	22
10 units or more	1100	

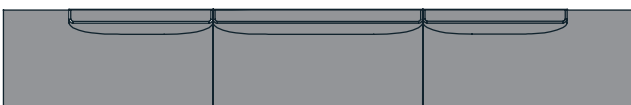

€	COM	COL	1	2	3	4	5	6	7	8	9	10	11	L1	L2	L3	L6
	5.542	5.661	5.803	5.919	6.010	6.166	6.322	6.478	6.632	6.787	6.948	7.111	7.273	7.414	7.998	9.062	11.945

Set 12 / Conjunto 12

3 Modules 3 Módulos
SF2129 + SF2119 + SF2128

	COM cm. per unit	COL m2
1 units	1580	31,75
10 units or more	1580	



€	COM	COL	1	2	3	4	5	6	7	8	9	10	11	L1	L2	L3	L6
	6.075	6.238	6.439	6.602	6.731	6.950	7.170	7.389	7.606	7.827	8.045	8.266	8.484	8.680	9.471	10.914	14.732

Examples of modular configurations Ejemplos de combinaciones modulares

Set 13 / Conjunto 13

3 Modules 3 Módulos
SF2073 + SF2118 + SF2072

	COM cm. per unit	COL m2
1 units	1560	30,8
10 units or more	1560	



€	COM	COL	1	2	3	4	5	6	7	8	9	10	11	L1	L2	L3	L6
	5.836	6.003	6.207	6.371	6.500	6.722	6.945	7.166	7.388	7.607	7.832	8.061	8.289	8.490	9.312	10.896	15.116

Set 14 / Conjunto 14

3 Modules 3 Módulos
SF2071 + SF2117 + SF2070

	COM cm. per unit	COL m2
1 units	1330	26,35
10 units or more	1330	



€	COM	COL	1	2	3	4	5	6	7	8	9	10	11	L1	L2	L3	L6
	5.098	5.235	5.405	5.542	5.649	5.835	6.017	6.202	6.388	6.584	6.787	6.986	7.185	7.365	8.086	9.398	12.920

Set 15 / Conjunto 15

3 Modules 3 Módulos
SF2135 + SF2119 + SF2134

	COM cm. per unit	COL m2
1 units	1250	25,25
10 units or more	1250	

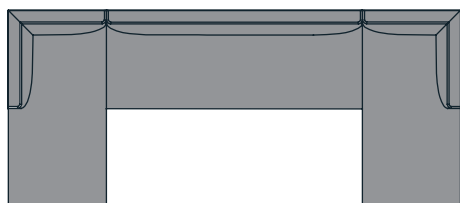

€	COM	COL	1	2	3	4	5	6	7	8	9	10	11	L1	L2	L3	L6
	5.809	5.942	6.107	6.240	6.345	6.522	6.702	6.879	7.062	7.241	7.419	7.598	7.776	7.936	8.581	9.760	12.940

Examples of modular configurations
Ejemplos de combinaciones modulares

Set 16 / Conjunto 16

4 Modules 4 Módulos
SF2121 + SF2120 + SF2120 + SF2121

	COM cm. per unit	COL m2
1 units	1400	28
10 units or more	1400	

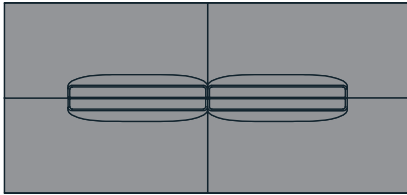

	COM	COL	1	2	3	4	5	6	7	8	9	10	11	L1	L2	L3	L6
€	7.628	7.780	7.960	8.108	8.224	8.424	8.620	8.820	9.016	9.212	9.416	9.616	9.812	9.988	10.704	12.008	15.596

Set 17 / Conjunto 17

4 Modules 4 Módulos
SF2123 + SF2122 + SF2122 + SF2123

	COM cm. per unit	COL m2
1 units	1800	36
10 units or more	1800	

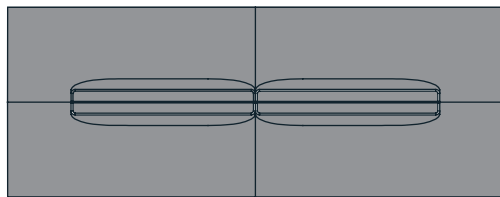

	COM	COL	1	2	3	4	5	6	7	8	9	10	11	L1	L2	L3	L6
€	7.996	8.176	8.400	8.580	8.724	8.964	9.204	9.452	9.692	9.932	10.176	10.428	10.692	10.924	11.884	13.640	18.264

Set 18 / Conjunto 18

6 Modules 6 Módulos
SF2121 + SF2120 + SF2118 + SF2118 + SF2120 + SF2121

	COM cm. per unit	COL m2
1 units	2200	44
10 units or more	2200	

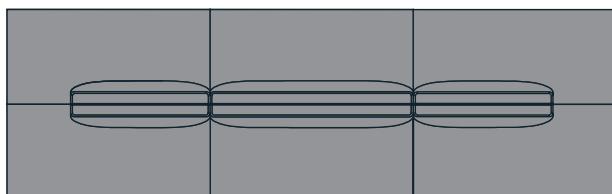

	COM	COL	1	2	3	4	5	6	7	8	9	10	11	L1	L2	L3	L6
€	11.084	11.322	11.606	11.838	12.020	12.332	12.644	12.956	13.264	13.574	13.896	14.222	14.546	14.828	15.996	18.124	23.890

Examples of modular configurations
Ejemplos de combinaciones modulares

Set 19 / Conjunto 19

6 Modules 6 Módulos
SF2123 + SF2122 + SF2119 + SF2119 + SF2122 + SF2123

	COM cm. per unit	COL m2
1 units	2760	55,5
10 units or more	2760	

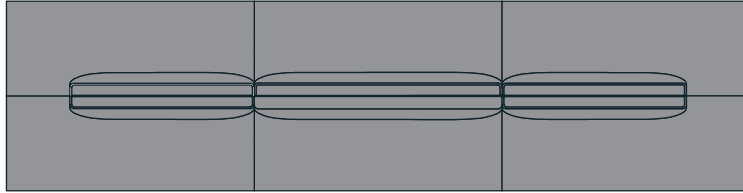

	COM	COL	1	2	3	4	5	6	7	8	9	10	11	L1	L2	L3	L6
€	11.730	12.012	12.362	12.644	12.870	13.244	13.624	14.006	14.384	14.762	15.142	15.532	15.932	16.288	17.742	20.400	27.412

Set 20 / Conjunto 20

4 Modules 4 Módulos
SF2125 + SF2124 + SF2124 + SF2125

	COM cm. per unit	COL m2
1 units	1800	35
10 units or more	1800	

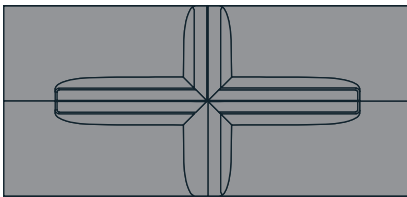

	COM	COL	1	2	3	4	5	6	7	8	9	10	11	L1	L2	L3	L6
€	7.564	7.744	7.964	8.144	8.280	8.520	8.756	8.996	9.232	9.472	9.716	9.968	10.228	10.460	11.416	13.136	17.704

Set 21 / Conjunto 21

4 Modules 4 Módulos
SF2127 + SF2126 + SF2126 + SF2127

	COM cm. per unit	COL m2
1 units	2000	40
10 units or more	2000	

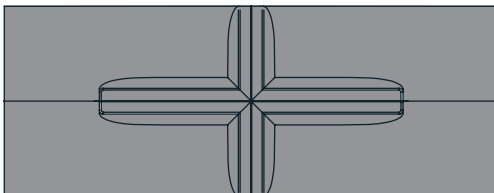

	COM	COL	1	2	3	4	5	6	7	8	9	10	11	L1	L2	L3	L6
€	8.268	8.480	8.732	8.936	9.100	9.376	9.648	9.924	10.200	10.476	10.752	11.028	11.300	11.548	12.540	14.352	19.472

Examples of modular configurations Ejemplos de combinaciones modulares

Set 22 / Conjunto 22

6 Modules 6 Módulos

SF2071 + SF2071 + SF2117 + SF2117 + SF2070 + SF2070

	COM cm. per unit	COL m2
1 units	2660	52,7
10 units or more	2660	

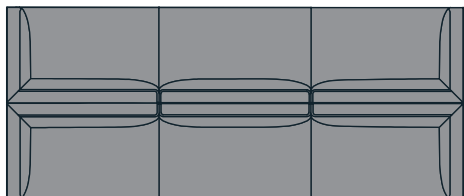

	COM	COL	1	2	3	4	5	6	7	8	9	10	11	L1	L2	L3	L6
€	10.196	10.470	10.810	11.084	11.298	11.670	12.034	12.404	12.776	13.168	13.574	13.972	14.370	14.730	16.172	18.796	25.840

Set 23 / Conjunto 23

6 Modules 6 Módulos

SF2072 + SF2072 + SF2118 + SF2118 + SF2072 + SF2072

	COM cm. per unit	COL m2
1 units	3120	61,6
10 units or more	3120	

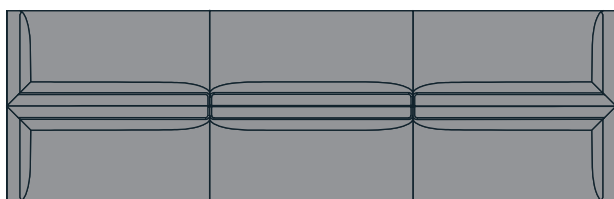

	COM	COL	1	2	3	4	5	6	7	8	9	10	11	L1	L2	L3	L6
€	11.672	12.006	12.414	12.742	13.000	13.444	13.892	14.332	14.776	15.214	15.664	16.122	16.578	16.984	18.624	21.796	30.238

Set 24 / Conjunto 24

6 Modules 6 Módulos

SF2128 + SF2129 + SF2119 + SF2119 + SF2129 + SF2128

	COM cm. per unit	COL m2
1 units	3160	63,5
10 units or more	3160	

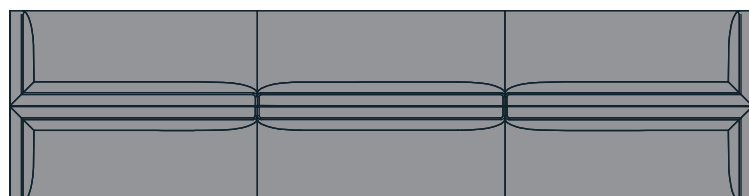

	COM	COL	1	2	3	4	5	6	7	8	9	10	11	L1	L2	L3	L6
€	12.150	12.476	12.878	13.204	13.462	13.900	14.340	14.778	15.212	15.654	16.090	16.532	16.968	17.360	18.942	21.828	29.464

Examples of modular configurations Ejemplos de combinaciones modulares

Set 25 / Conjunto 25

8 Modules 8 Módulos

SF2068 + SF2068 + SF2118 + SF2118 + SF2118 + SF2068 + SF2068

	COM cm. per unit	COL m2
1 units	3040	60,4
10 units or more	3040	

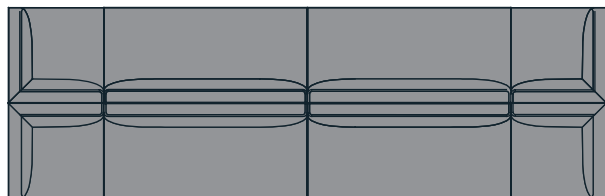

€	COM	COL	1	2	3	4	5	6	7	8	9	10	11	L1	L2	L3	L6
	12.600	12.920	13.312	13.628	13.876	14.300	14.732	15.156	15.580	16.008	16.444	16.888	17.344	17.736	19.360	22.324	30.348

Set 26 / Conjunto 26

4 Modules 4 Módulos

SF2135 + SF2134 + SF2134 + SF2135

	COM cm. per unit	COL m2
1 units	1540	31
10 units or more	1540	

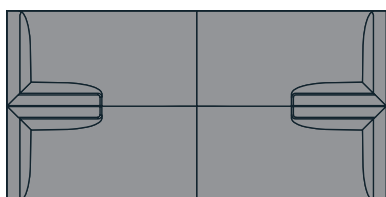

€	COM	COL	1	2	3	4	5	6	7	8	9	10	11	L1	L2	L3	L6
	7.884	8.048	8.252	8.416	8.544	8.764	8.984	9.204	9.432	9.652	9.872	10.092	10.312	10.508	11.304	12.760	16.732

Set 27 / Conjunto 27

6 Modules 6 Módulos

SF2074 + SF2074 + SF2119 + SF2119 + SF2074 + SF2074

	COM cm. per unit	COL m2
1 units	960	19,5
10 units or more	960	

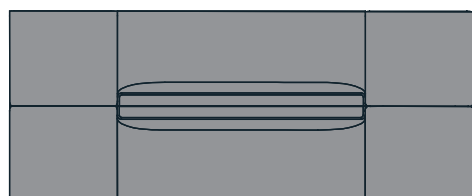

€	COM	COL	1	2	3	4	5	6	7	8	9	10	11	L1	L2	L3	L6
	3.734	3.836	3.962	4.064	4.146	4.280	4.420	4.554	4.692	4.830	4.966	5.104	5.240	5.364	5.858	6.760	9.148

Examples of modular configurations Ejemplos de combinaciones modulares

Set 28 / Conjunto 28

3 Modules 3 Módulos
SF2127 + SF2119 + SF2126

	COM cm. per unit	COL m2
1 units	1480	29,75
10 units or more	1480	

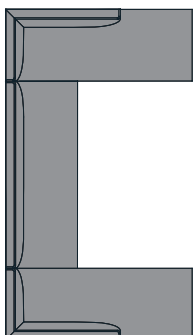

	COM	COL	1	2	3	4	5	6	7	8	9	10	11	L1	L2	L3	L6
€	6.001	6.158	6.347	6.500	6.623	6.828	7.034	7.239	7.446	7.653	7.859	8.066	8.270	8.456	9.199	10.556	14.310

Set 29 / Conjunto 29

3 Modules 3 Módulos
SF2067 + SF2119 + SF2067

	COM cm. per unit	COL m2
1 units	1620	32,15
10 units or more	1620	

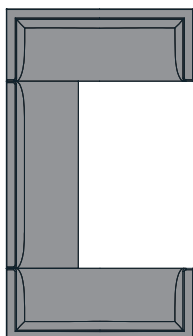

	COM	COL	1	2	3	4	5	6	7	8	9	10	11	L1	L2	L3	L6
€	6.249	6.422	6.635	6.808	6.943	7.174	7.404	7.635	7.866	8.097	8.333	8.580	8.828	9.048	9.933	11.554	15.838

Set 30 / Conjunto 30

4 Modules 4 Módulos
SF2126 + SF2123 + SF2122 + SF2127

	COM cm. per unit	COL m2
1 units	1900	38
10 units or more	1900	

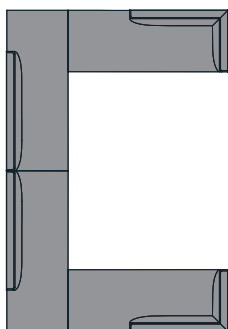

	COM	COL	1	2	3	4	5	6	7	8	9	10	11	L1	L2	L3	L6
€	8.132	8.328	8.566	8.758	8.912	9.170	9.426	9.688	9.946	10.204	10.464	10.728	10.996	11.236	12.212	13.996	18.868

Examples of modular configurations
Ejemplos de combinaciones modulares

Set 31 / Conjunto 31

7 Modules 7 Módulos

SF2068 + SF2119 + SF2069 + SF2119 + SF2068 +
SF2119 + SF2069

	COM cm. per unit	COL m2
1 units	2880	57,65
10 units or more	2880	

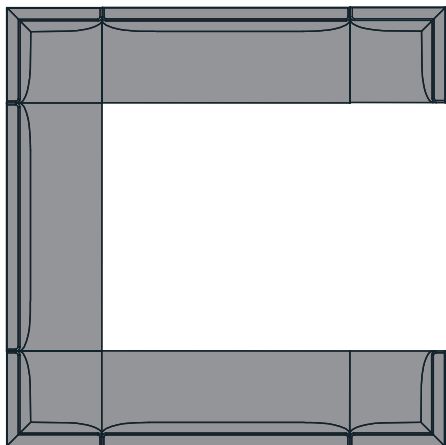

	COM	COL	1	2	3	4	5	6	7	8	9	10	11	L1	L2	L3	L6
€	11.289	11.590	11.963	12.264	12.503	12.904	13.314	13.715	14.122	14.529	14.933	15.332	15.736	16.102	17.563	20.232	27.482

Set 32 / Conjunto 32

3 Modules 3 Módulos

SF2122 + SF2068 + SF2123

	COM cm. per unit	COL m2
1 units	1260	25,1
10 units or more	1260	

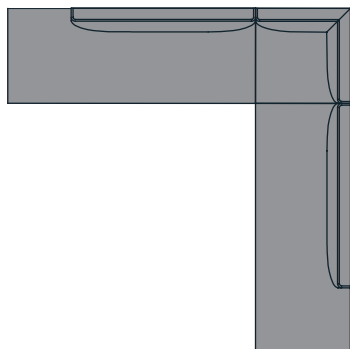

	COM	COL	1	2	3	4	5	6	7	8	9	10	11	L1	L2	L3	L6
€	5.420	5.547	5.705	5.832	5.933	6.103	6.273	6.447	6.617	6.787	6.959	7.133	7.315	7.476	8.136	9.343	12.572

Examples of modular configurations Ejemplos de combinaciones modulares

Set 33 / Conjunto 33

4 Modules 4 Módulos

SF2123 + SF2126 + SF2126 + SF2123

	COM cm. per unit	COL m2
1 units	1900	38
10 units or more	1900	

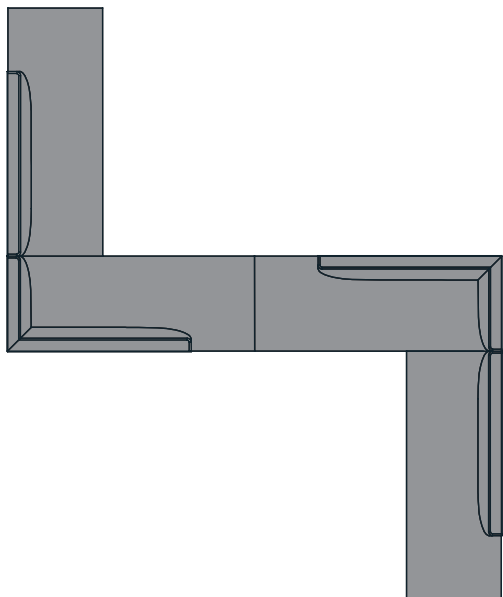

€	COM	COL	1	2	3	4	5	6	7	8	9	10	11	L1	L2	L3	L6
€	8.132	8.328	8.566	8.758	8.912	9.170	9.426	9.688	9.946	10.204	10.464	10.728	10.996	11.236	12.212	13.996	18.868

Set 34 / Conjunto 34

6 Modules 6 Módulos

SF2069 + SF2118 + SF2126 + SF2126 + SF2118 + SF2069

	COM cm. per unit	COL m2
1 units	2520	50,2
10 units or more	2520	

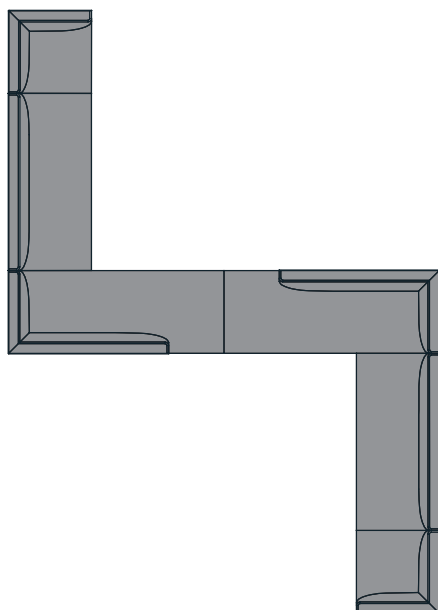

€	COM	COL	1	2	3	4	5	6	7	8	9	10	11	L1	L2	L3	L6
€	10.434	10.700	11.022	11.282	11.488	11.838	12.190	12.540	12.890	13.242	13.598	13.958	14.322	14.642	15.950	18.338	24.910



Description
Descripción

Sofas with upholstered seat and backrest, with the option of combining different upholstery and 4-legged die-cast aluminum base with white, black or polished aluminum finish. Available in modular or corner version with 2 and 3 seats and separate footrest version. Side table and loose cushion available. USB charging system option, depending on version.

Sofás con asiento y respaldo tapizado, con opción de combinar tapicerías diferentes y base de 4 patas de inyección de aluminio en acabado aluminio pulido, blanco o negro. Disponible versión modular o rinconero de 2 y 3 plazas y versión reposapiés. Disponible mesa y cojín auxiliar. Opción de sistema de USB de carga, según versiones.

Upholstery
Tapicería

The Raglan Home collection supports following upholsteries of Andreu World Catalogue. For fabrics in our catalogue not specified in this box or customers own materials please contact our Customer Service Department.

La colección Raglan Home admite las siguientes tapicerías del catálogo de Andreu World. Para las telas de nuestro catálogo no indicadas en este cuadro o telas cliente, consultar con nuestro Departamento Comercial.

Fabrics / Telas

- 1** Soft-fiber
Jacquard One
Jacquard Three
Citadel
Sand
Era
Gravity
Rivet
Urban
Reel One (in/out)
Spin One
Spin Two
Spin Three
Spin Four
Spin Five
- 2** Jacquard Two
Solid & Stripes
Loom One
Circular One Pure Eco
Tack One (in/out)

- 3** Jacquard Four
Medley
Revive 1
Natte
Main Line Flax
Loom Two (in/out)
Mezzo
Reel two (in/out)
Jacquard Five

- 4** Jacquard 4 Special
Nexus
Field 2
Remix 3
Heritage
Savane
Loom Three
Loom Four
Cura
Oceanic
Reel Three (in/out)
Reel Four (in/out)
Reflect
Spin Six

- 5** Silk
Synergy
Step
Step Melange
Blazer
Melange Nap
Chili
Noma
Re-wool
- 6** Go check
Swing
Chartres
Zori
Patio
Tack Two (in/out)
Tack Three (in/out)

- 7** Canvas 2
Select
Clara 2
Tack Five (in/out)
Hero 2

- 8** Capture
Fiord 2
Tonus 4
Divina 3
Lopi
Domino
Atrium
- 9** Divina MD
Divina Melange 3
Hallingdal 65
Steelcut Trio 3
Tack Four (in/out)

- 11** Arda
Ecriture
Zero

Faux Leather / Ecopiel

- 1** Valencia
- 2** Silvertex
- 3** Maglia
- 4** Dolce
- 8** Ultraleather
- 9** Brisa
Brisa Distressed
Fresco
Ultraleather Pro
Promessa
- 10** Tottori
Coast (in/out)
- 11** Reef Pro
Volar Bio

Leather / Piel

- L1** High grade cow leather.
Piel de vaca de 1ª categoría.
- L3** Polished full grain leather.
Piel de vaca pulida.
- L6** Aniline leather batique-effect.
Scandinavian cattle.
Piel anilina efecto batique.
Ganado escandinavo.

Piping finish

Acabado ribete



Aluminum finish

Acabado aluminio



Wood finish Oak

Acabado madera Roble



Open pore in oak wood seats and backs. /Poros abiertos en asientos y respaldos de tablero de roble.

Wood lacquer finish

Acabado laca madera

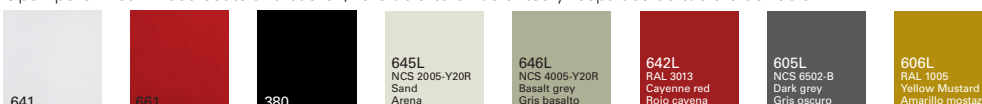

Certificates
Certificados

Quality - Resistance UNE EN 16139:2013
Calidad - Resistencia

Intellectual property Propiedad intelectual

All our collections are protected by international industrial design registries, designs patents, copyrights and intellectual Property laws. Unauthorized use of AW International Property is a criminal offence and can lead to prosecution. Todas nuestras colecciones están protegidas por registros de diseño industrial, diseño de patente, copyright y derechos de propiedad intelectual en todo el mundo. El uso no autorizado de los diseños y propiedad intelectual de AW supone un delito que puede ser sometido a acción judicial.



SF2210

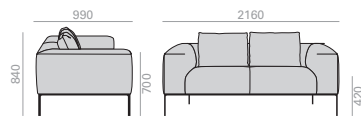

2-seater sofa with upholstered seat and back, with the option of combining different upholstery and 4-legged die-cast polished aluminum base in white, black or polished aluminum finish. Edge piping available in the same color as the upholstery, or in white, black or sand. USB charging system option. The sofa always has back cushions (x2 units).

Sofá de 2 plazas con asiento y respaldo tapizado, con opción de combinar tapicerías diferentes y base de 4 patas de inyección de aluminio en acabado aluminio pulido, blanco o negro. Ribete perimetral disponible al tono de la tapicería, o en color blanco, negro o arena. Opción de sistema de USB de carga. El sofá siempre lleva cojines de respaldo (x2 uds.)

	COM cm. per unit	COL m2
1 units	1000	20
10 units or more	1000	

2,07 m3
 88 kg
 x1

COM	COL	1	2	3	4	5	6	7	8	9	10	11	L1	L2	L3	L6
€ 2.174	2.265	2.374	2.462	2.531	2.650	2.769	2.887	3.007	3.126	3.244	3.363	3.482	3.588	4.016	4.798	6.867



USB charging system
upcharge
Incremento por sistema de USB de carga

| 195 |

SF2211



3-seater sofa with upholstered seat and back, with the option of combining different upholstery and 4-legged die-cast polished aluminum base in white, black or polished aluminum finish. Edge piping available in the same color as the upholstery, or in white, black or sand. USB charging system option. The sofa always has back cushions (x3 units).

Sofá de 3 plazas con asiento y respaldo tapizado con opción de combinar tapicerías diferentes y base de 4 patas de inyección de aluminio en acabado aluminio pulido, blanco o negro. Ribete perimetral disponible al tono de la tapicería, o en color blanco, negro o arena. Opción de sistema de USB de carga. El sofá siempre lleva cojines de respaldo (x3 uds.)

	COM cm. per unit	COL m2
1 units	1225	24,5
10 units or more	1225	

2,35 m3
 95 kg
 x1

COM	COL	1	2	3	4	5	6	7	8	9	10	11	L1	L2	L3	L6
€ 2.386	2.489	2.616	2.718	2.797	2.935	3.071	3.209	3.347	3.483	3.620	3.758	3.894	4.017	4.512	5.415	7.803



USB charging system
upcharge
Incremento por sistema de USB de carga

| 195 |

SF2212

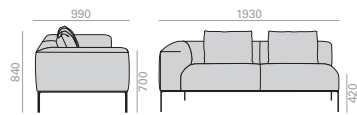

2-seater corner sofa (right side) with upholstered seat and backrest with the option of combining different upholstery and 4-legged die-cast polished aluminum base in white, black or polished aluminum finish. Edge piping available in the same color as the upholstery, or in white, black or sand. USB charging system option. The sofa always has back cushions (x2 units).

Sofá rinconero de 2 plazas (lado derecho) con asiento y respaldo tapizado con opción de combinar diferentes tapicerías y base de 4 patas de inyección de aluminio en acabado aluminio pulido, blanco o negro. Ribete perimetral disponible al tono de la tapicería, o en color blanco, negro o arena. Opción de sistema de USB de carga. El sofá siempre lleva cojines de respaldo (x2 uds.)

	COM cm. per unit	COL m2
1 units	900	18
10 units or more	900	

1,85 m3
 75 kg
 x1

COM	COL	1	2	3	4	5	6	7	8	9	10	11	L1	L2	L3	L6
€ 2.047	2.126	2.225	2.304	2.365	2.472	2.578	2.683	2.790	2.896	3.001	3.108	3.214	3.308	3.692	4.389	6.236



USB charging system
upcharge
Incremento por sistema de USB de carga

| 195 |

SF2213

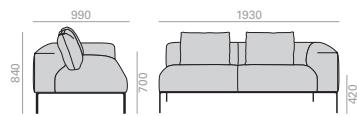

2-seater corner sofa (left side) with upholstered seat and backrest with the option of combining different upholstery and 4-legged die-cast polished aluminum base in white, black or polished aluminum finish. Edge piping available in the same color as the upholstery, or in white, black or sand. USB charging system option. The sofa always has back cushions (x2 units).

Sofá rinconero de 2 plazas (lado izquierdo) con asiento y respaldo tapizado con opción de combinar diferentes tapicerías y base de 4 patas de inyección de aluminio en acabado aluminio pulido, blanco o negro. Ribete perimetral disponible al tono de la tapicería, o en color blanco, negro o arena. Opción de sistema de USB de carga. El sofá siempre lleva cojines de respaldo (x2 uds.)

	COM cm. per unit	COL m2
1 units	900	18
10 units or more	900	

1,85 m3
 75 kg
 x1

COM	COL	1	2	3	4	5	6	7	8	9	10	11	L1	L2	L3	L6
€ 2.047	2.127	2.225	2.304	2.366	2.472	2.578	2.685	2.791	2.896	3.002	3.108	3.214	3.309	3.692	4.391	6.238



USB charging system
upcharge
Incremento por sistema de USB de carga

| 195 |

SF2214

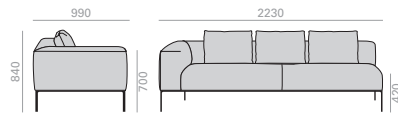

3-seater corner sofa (right side) with upholstered seat and backrest with the option of combining different upholstery and 4-legged die-cast polished aluminum base in white, black or polished aluminum finish. Edge piping available in the same color as the upholstery, or in white, black or sand. USB charging system option. The sofa always has back cushions (x3 units).

Sofá rinconero de 3 plazas (lado derecho) con asiento y respaldo tapizado con opción de combinar diferentes tapicerías y base de 4 patas de inyección de aluminio en acabado aluminio pulido, blanco o negro. Ribete perimetral disponible al tono de la tapicería, o en color blanco, negro o arena. Opción de sistema de USB de carga. El sofá siempre lleva cojines de respaldo (x3 uds.)

	COM cm. per unit	COL m2
1 units	1075	21,5
10 units or more	1075	

2,13 m3
82 kg
x1

COM	COL	1	2	3	4	5	6	7	8	9	10	11	L1	L2	L3	L6
€ 2.243	2.335	2.451	2.544	2.616	2.739	2.865	2.988	3.112	3.237	3.361	3.486	3.610	3.720	4.169	4.988	7.152



USB charging system upcharge
Incremento por sistema de USB de carga

195

SF2215



3-seater corner sofa (left side) with upholstered seat and backrest with the option of combining different upholstery and 4-legged die-cast polished aluminum base in white, black or polished aluminum finish. Edge piping available in the same color as the upholstery, or in white, black or sand. USB charging system option. The sofa always has back cushions (x3 units).

Sofá rinconero de 3 plazas (lado izquierdo) con asiento y respaldo tapizado con opción de combinar diferentes tapicerías y base de 4 patas de inyección de aluminio en acabado aluminio pulido, blanco o negro. Ribete perimetral disponible al tono de la tapicería, o en color blanco, negro o arena. Opción de sistema de USB de carga. El sofá siempre lleva cojines de respaldo (x3 uds.)

	COM cm. per unit	COL m2
1 units	1075	21,5
10 units or more	1075	

2,13 m3
82 kg
x1

COM	COL	1	2	3	4	5	6	7	8	9	10	11	L1	L2	L3	L6
€ 2.243	2.335	2.451	2.544	2.616	2.739	2.865	2.988	3.112	3.237	3.361	3.486	3.610	3.720	4.169	4.988	7.152



USB charging system upcharge
Incremento por sistema de USB de carga

195

SF2216

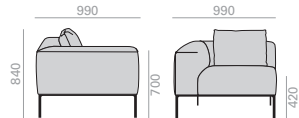

Corner sofa with upholstered seat and backrest with the option of combining different upholstery and 4-legged die-cast aluminum base in white, black or polished aluminum finish. Edge piping available in the same color as the upholstery, or in white, black or sand. USB charging system option. The sofa always has back cushions (x1 unit).

Sofá rinconero (corner) con asiento y respaldo tapizado con opción de combinar diferentes tapicerías y base de 4 patas de inyección de aluminio en acabado aluminio pulido, blanco o negro. Ribete perimetral disponible al tono de la tapicería, o en color blanco, negro o arena. Opción de sistema de USB de carga. El sofá siempre lleva cojines de respaldo (x1 ud.)

	COM cm. per unit	COL m2
1 units	520	10,5
10 units or more	520	

0,98 m3
55 kg
x1

COM	COL	1	2	3	4	5	6	7	8	9	10	11	L1	L2	L3	L6
€ 1.502	1.549	1.607	1.654	1.690	1.752	1.815	1.877	1.939	2.003	2.065	2.127	2.189	2.246	2.470	2.881	3.968

SF2217

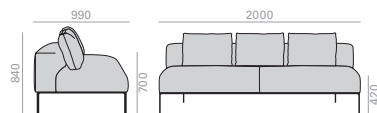

3-seater modular sofa with upholstered seat and backrest with the option of combining different upholstery and 4-legged die-cast aluminum base in white, black or polished aluminum finish. Edge piping available in the same color as the upholstery, or in white, black or sand. The sofa always has back cushions (x3 units).

Sofá modular de 3 plazas con asiento y respaldo tapizado con opción de combinar tapicerías diferentes y base de 4 patas de inyección de aluminio en acabado aluminio pulido, blanco o negro. Ribete perimetral disponible al tono de la tapicería, o en color blanco, negro o arena. El sofá siempre lleva cojines de respaldo (x3 uds.)

	COM cm. per unit	COL m2
1 units	875	17,5
10 units or more	875	

1,92 m3
75 kg
x1

COM	COL	1	2	3	4	5	6	7	8	9	10	11	L1	L2	L3	L6
€ 2.055	2.129	2.223	2.298	2.356	2.457	2.558	2.659	2.759	2.860	2.960	3.062	3.162	3.252	3.614	4.278	6.031

SF2218

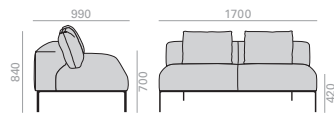

2-seater modular sofa with upholstered seat and backrest with the option of combining different upholstery and 4-legged die-cast aluminum base in white, black or polished aluminum finish. Edge piping available in the same color as the upholstery, or in white, black or sand. The sofa always has back cushions (x2 units).

Sofá modular de 2 plazas con asiento y respaldo tapizado con opción de combinar tapicerías diferentes y base de 4 patas de inyección de aluminio en acabado aluminio pulido, blanco o negro. Ribete perimetral disponible al tono de la tapicería, o en color blanco, negro o arena. El sofá siempre lleva cojines de respaldo (x2 uds.)

	COM cm. per unit	COL m2
1 units	630	12,5
10 units or more	630	

1,64 m3
68 kg
x1

COM	COL	1	2	3	4	5	6	7	8	9	10	11	L1	L2	L3	L6
€ 1.937	1.994	2.064	2.120	2.164	2.239	2.316	2.391	2.467	2.542	2.618	2.694	2.769	2.836	3.108	3.652	5.223

RS2219

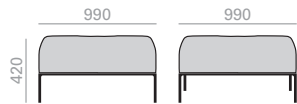

Ottoman with upholstered seat and 4-legged die-cast aluminum base in white, black or polished aluminum finish. Edge piping available in the same color as the upholstery, or in white, black or sand.

Reposapiés con asiento tapizado y base de 4 patas de inyección de aluminio en acabado aluminio pulido, blanco o negro. Ribete perimetral disponible al tono de la tapicería, o en color blanco, negro o arena.

	COM cm. per unit	COL m2
1 units	230	4,75
10 units or more	180	

0,48 m3
36 kg
x1

COM	COL	1	2	3	4	5	6	7	8	9	10	11	L1	L2	L3	L6
1.174	1.193	1.218	1.239	1.254	1.282	1.308	1.336	1.362	1.389	1.416	1.442	1.469	1.494	1.590	1.767	2.235

ME2220



Occasional table with 4-legged die-cast aluminum base in white, black or polished aluminum finish and oak table top.

Mesa auxiliar con base de 4 patas de inyección de aluminio en acabado aluminio pulido, blanco o negro y sobre roble.

0,229 m3
36 kg
x1

€ 1.026

ME2222



Occasional table with 4-legged die-cast aluminum base in white, black or polished aluminum finish and lacquered table top.

Mesa auxiliar con base de 4 patas de inyección de aluminio en acabado aluminio pulido, blanco o negro y sobre lacado.

0,229 m3
36 kg
x1

€ 991

CJ2221

Loose cushion.
Cojín auxiliar.

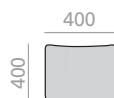

	COM cm. per unit
1 units	50
10 units or more	50

m3
 kg
 x1

€	COM	COL	1	2	3	4	5	6	7	8	9	10	11	L1	L2	L3	L6
	86	91	95	100	105	112	118	125	132	138	145	151	158	165	188	231	349

Glides. Tacos.

Use/Usó	Reference/Referencia		Material/Material	Price/Precio
Hard floors. Suelos duros.	TS0419		Plastic (PE). Plástico (PE).	0 € Standard. Estándar.
Wooden and delicate floors. Suelos de madera y delicados.	TS0420		Plastic (PE) with felt. Plástico (PE) con fieltro.	5 € Set of 4 glides. Juego de 4 tacos.
Mats/carpet floors. Suelos de moqueta/alfombra.	TS0421		Plastic (POM). Plástico (POM).	0 € Standard. Estándar.

The indicated price is for glides placed on chairs. To order loose parts, please ask to our Sales Department.

El precio indicado en Tarifa es para tacos colocados en las sillas. Para pedidos de tacos sueltos de repuesto, consultar con el Departamento Comercial.



Description
Descripción

Lounge chair and 2-3-seater sofas with upholstered seat and back and 4 legs steel legs polished chrome finish, white or black. Additional options include: fixed auxiliary table or satellite finished in oak, walnut or lacquered, USB charging system and walnut back.

Butaca y sofás de 2 o 3 plazas con asiento y respaldo tapizado y base de 4 patas de tubo de acero en acabado cromo brillo, blanco o negro. Mesas auxiliares disponibles en acabado roble, nogal y Compacto HPL. Opciones disponibles: mesa auxiliar fija o satélite en acabado roble, nogal o lacado, sistema de USB de carga y respaldo en madera de nogal.

Upholstery
Tapicería

The Rap collection supports following upholsteries of Andreu World Catalogue. For fabrics in our catalogue not specified in this box or customers own materials please contact our Customer Service Department.

La colección Rap admite las siguientes tapicerías del catálogo de Andreu World. Para las telas de nuestro catálogo no indicadas en este cuadro o telas cliente, consultar con nuestro Departamento Comercial.

Fabrics / Telas

- 1** Soft-fiber
Jacquard One
Jacquard Three
Citadel
Sand
Era
Gravity
Rivet
Urban
Reel One (in/out)
Spin One
Spin Two
Spin Three
Spin Four
Spin Five

- 2** Jacquard Two
Solid & Stripes
Loom One
Circular One Pure Eco
Tack One (in/out)

- 3** Jacquard Four
Medley
Revive 1
Natte
Main Line Flax
Loom Two (in/out)
Mezzo
Reel two (in/out)
Jacquard Five

- 4** Jacquard 4 Special
Nexus
Field 2
Remix 3
Heritage
Savane
Loom Three
Loom Four
Cura
Oceanic
Reel Three (in/out)
Reel Four (in/out)
Reflect
Spin Six

- 5** Silk
Synergy
Step
Step Melange
Blazer
Melange Nap
Chili
Noma
Re-wool

- 6** Go check
Swing
Chartres
Zori
Patio
Tack Two (in/out)
Tack Three (in/out)

- 7** Canvas 2
Select
Clara 2
Tack Five (in/out)
Hero 2

- 8** Capture
Fiord 2
Tonus 4
Divina 3
Lopi
Domino
Atrium
9 Divina MD
Divina Melange 3
Hallingdal 65
Steelcut Trio 3
Tack Four (in/out)

- 11** Arda
Ecriture
Zero

Faux Leather / Ecopiel

- 1** Valencia
2 Silvertex
3 Maglia
4 Dolce
8 Ultraleather
9 Brisa
Brisa Distressed
Fresco
Ultraleather Pro
Promessa

- 10** Tottori
Coast (in/out)

- 11** Reef Pro
Volar Bio

Leather / Piel

- L1** High grade cow leather.
Piel de vaca de 1ª categoría.
L3 Polished full grain leather.
Piel de vaca pulida.
L6 Aniline leather batique-effect.
Scandinavian cattle.
Piel anilina efecto batique.
Ganado escandinavo.

Compacto HPL finish
Acabado Compacto HPL



Wood finish Walnut
Acabado madera Nogal

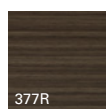

Wood finish Oak
Acabado madera Roble



Steel finish
Acabado de acero



Certificates
Certificados

Fireproof polyurethane foam

Espuma de poliuretano ignifuga

UNE EN 1021:2006
BS 5852 part 2 crib 5
UNI 9175 Classe 1 IM
BKZ 5.2
California TB 117:2013
California TB 133*

*Contact our Customer Department
*Consultar con nuestro Departamento Comercial

Quality - Resistance
Calidad - Resistencia

UNE EN 16139:2013

Intellectual property Propiedad intelectual

All our collections are protected by international industrial design registries, designs patents, copyrights and intellectual Property laws. Unauthorized use of AW International Property is a criminal offence and can lead to prosecution.
Todas nuestras colecciones están protegidas por registros de diseño industrial, diseño de patente, copyright y derechos de propiedad intelectual todo el mundo. El uso no autorizado de los diseños y propiedad intelectual de AW supone un delito que puede ser sometido a acción judicial.



BU1135

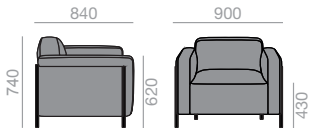

Upholstered lounge chair and oak wooden back and sides and 4 steel legs finished in white or black with polished chrome finish option. Additional options include: fixed auxiliary table or satellite finished in oak, walnut or Compacto HPL, USB charging system and walnut back.

Butaca tapizada con respaldo trasero y laterales de madera de roble y base de 4 patas de tubo de acero en acabado blanco o negro con opción de acabado cromo brillo. Opciones disponibles: mesa auxiliar fija o satélite en acabado roble, nogal o Compacto HPL, sistema e USB de carga y respaldo en madera de nogal.

	COM cm. per unit	COL m2
1 units	380	7,75
10 units or more	380	

0,62 m3
51,18 kg
x1

€	COM	COL	1	2	3	4	5	6	7	8	9	10	11	L1	L2	L3	L6
	2.297	2.341	2.394	2.438	2.472	2.533	2.597	2.661	2.724	2.789	2.854	2.917	2.982	3.040	3.271	3.692	4.809



USB charging system upcharge
Incremento por sistema de USB de carga

195



Fixed auxiliary table upcharge
Incremento mesa auxiliar fija

144



Satellite auxiliary table upcharge
Incremento mesa auxiliar satélite

315



Polished chrome upcharge
Incremento cromo brillo

174



Walnut back upcharge
Incremento respaldo en nogal

150

SF1136

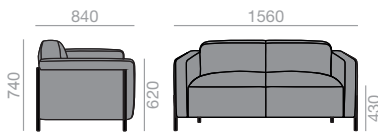

2-seater upholstered sofa and wooden back and sides and 4 steel legs finished in white or black with polished chrome finish option. Additional options include: fixed auxiliary table or satellite finished in oak, walnut or Compacto HPL, USB charging system and walnut back.

Sofá de 2 plazas tapizado con respaldo trasero y laterales de madera de roble y base de 4 patas de tubo de acero en acabado blanco o negro con opción de acabado cromo brillo. Opciones disponibles: mesa auxiliar fija o satélite en acabado roble, nogal o Compacto HPL, sistema de USB de carga y respaldo en madera de nogal.

	COM cm. per unit	COL m2
1 units	490	9,75
10 units or more	490	

1,08 m3
69,8 kg
x1

€	COM	COL	1	2	3	4	5	6	7	8	9	10	11	L1	L2	L3	L6
	2.801	2.860	2.861	2.978	3.036	3.114	3.192	3.270	3.349	3.425	3.504	3.582	3.659	3.729	4.011	4.526	5.905



USB charging system upcharge
Incremento por sistema de USB de carga

195



Fixed auxiliary table upcharge
Incremento mesa auxiliar fija

144



Satellite auxiliary table upcharge
Incremento mesa auxiliar satélite

315



Polished chrome upcharge
Incremento cromo brillo

231



Walnut back upcharge
Incremento respaldo en nogal

210

SF1137

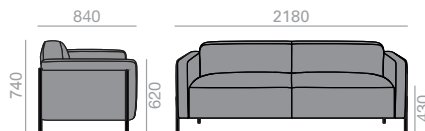

3-seater upholstered sofa and wooden back and sides and 4 steel legs finished in white or black with polished chrome finish option. Additional options include: fixed auxiliary table or satellite finished in oak, walnut or Compacto HPL, USB charging system and walnut back.

Sofá de 3 plazas tapizado con respaldo trasero y laterales de madera y base de 4 patas de tubo de acero en acabado blanco o negro con opción de acabado cromo brillo. Opciones disponibles: mesa auxiliar fija o satélite acabado roble, nogal o Compacto HPL, sistema USB de carga y respaldo en madera de nogal.

	COM cm. per unit	COL m2
1 units	650	13
10 units or more	650	

1,59 m3
88,42 kg
x1

€	COM	COL	1	2	3	4	5	6	7	8	9	10	11	L1	L2	L3	L6
	3.391	3.474	3.485	3.637	3.720	3.830	3.940	4.049	4.159	4.269	4.379	4.488	4.597	4.694	5.091	5.812	7.722



USB charging system upcharge
Incremento por sistema de USB de carga

195



Fixed auxiliary table upcharge
Incremento mesa auxiliar fija

144



Satellite auxiliary table upcharge
Incremento mesa auxiliar satélite

315



Polished chrome upcharge
Incremento cromo brillo

384



Walnut back upcharge
Incremento respaldo en nogal

264



Description

Chairs, armchairs, lounge chairs and barstools with beech or oak seat and back and solid beech or oak frame. Optional upholstered seat.

Descripción

Sillas, sillones, butacas y banquetas con asiento y respaldo de haya o roble y estructura de madera maciza de haya o roble. Opción de asiento tapizado.

Upholstery

The RDL collection supports following upholsteries of Andreu World Catalogue. For fabrics in our catalogue not specified in this box or customers own materials please contact our Customer Service Department.

Tapicería

La colección RDL admite las siguientes tapicerías del catálogo de Andreu World. Para las telas de nuestro catálogo no indicadas en este cuadro o telas cliente, consultar con nuestro Departamento Comercial.

Fabrics / Telas

- 1** Soft-fiber
Jacquard One
Jacquard Three
Citadel
Sand
Era
Gravity
Rivet
Urban
Reel One (in/out)
Spin One
Spin Two
Spin Three
Spin Four
Spin Five
- 2** Jacquard Two
Solid & Stripes
Loom One
Circular One Pure Eco
Tack One (in/out)
- 3** Jacquard Four
Medley
Revive 1
Natte
Main Line Flax
Loom Two (in/out)
Mezzo
Reel two (in/out)
Jacquard Five
- 4** Jacquard 4 Special
Nexus
Field 2
Remix 3
Heritage
Savane
Loom Three
Loom Four
Cura
Oceanic
Reel Three (in/out)
Reel Four (in/out)
Reflect
Spin Six
- 5** Silk
Synergy
Step
Step Melange
Blazer
Melange Nap
Chili
Noma
Re-wool
- 6** Go check
Swing
Chartres
Zori
Patio
Tack Two (in/out)
Tack Three (in/out)
- 7** Canvas 2
Select
Clara 2
Tack Five (in/out)
Hero 2
- 8** Capture
Fiord 2
Tonus 4
Divina 3
Lopi
Domino
Atrium
- 9** Divina MD
Divina Melange 3
Hallingdal 65
Steelcut Trio 3
Tack Four (in/out)
- 11** Arda
Ecriture
Zero

Faux Leather / Ecopiel

- 1** Valencia
- 2** Silvertex
- 3** Maglia
- 4** Dolce
- 8** Ultraleather
- 9** Brisa
Brisa Distressed
Fresco
Ultraleather Pro
Promessa
- 10** Tottori
Coast (in/out)
- 11** Reef Pro
Volar Bio

Leather / Piel

- L1** High grade cow leather.
Piel de vaca de 1ª categoría.
- L3** Polished full grain leather.
Plena flor pulida.
- L6** Aniline leather batique-effect.
Scandinavian cattle.
Piel anilina efecto batique.
Ganado escandinavo.

Wood finish Beech
Acabado madera Haya

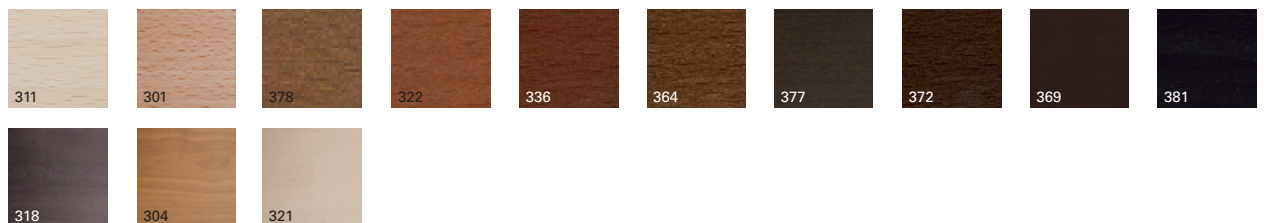

Premium finish and wood lacquers
Acabado premium y lacas madera

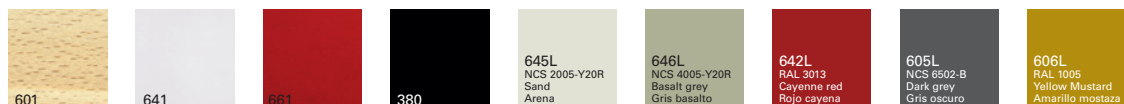

Wood finish Oak
Acabado madera Roble



Premium finish and wood lacquers
Acabado premium y lacas madera



Open pore in oak wood seats and backs. / Poro abierto en asientos y respaldos de tablero de roble.

Certificates

Fireproof polyurethane foam

UNE EN 1021:2006
BS 5852 part 2 crib 5
UNI 9175 Classe 1 IM
BKZ 5.2
California TB 117:2013
California TB 133*

Quality - Resistance
Calidad - Resistencia

UNE EN 16139:2013

Intellectual property Propiedad intelectual

All our collections are protected by international industrial design registries, designs patents, copyrights and intellectual Property laws. Unauthorized use of AW International Property is a criminal offence and can lead to prosecution.
Todas nuestras colecciones están protegidas por registros de diseño industrial, diseño de patente, copyright y derechos de propiedad intelectual todo el mundo. El uso no autorizado de los diseños y propiedad intelectual de AW supone un delito que puede ser sometido a acción judicial.



SI7291

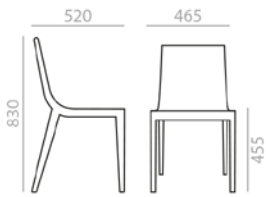

Chair with oak board seat and backrest and solid oak wood frame. Optional: Upholstered seat pad.

Silla con asiento y respaldo de tablero de roble y estructura de madera maciza de roble. Opción de asiento plafonado.

	COM cm. per unit	COL m2
1 units	48	1
10 units or more	24	

0,32 m3

14,8 kg

x2

€ 581



COM	COL	1	2	3	4	5	6	7	8	9	10	11	L1	L2	L3	L6
628	632	634	637	639	642	646	649	655	659	664	670	675	680	699	733	824



Matte lacquered and premium upcharge
Incremento por lacado mate y premium

39

SO7292

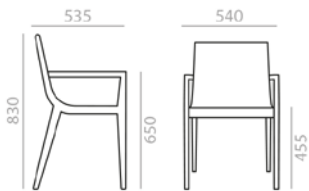

Armchair with oak board seat and backrest and solid oak wood frame. Optional: Upholstered seat pad.

Sillón con asiento y respaldo de tablero de roble y estructura de madera maciza de roble. Opción de asiento plafonado.

	COM cm. per unit	COL m2
1 units	48	1
10 units or more	24	

0,27 m3

9,4 kg

x1

€ 816



COM	COL	1	2	3	4	5	6	7	8	9	10	11	L1	L2	L3	L6
845	848	851	854	852	858	863	868	874	879	884	890	894	899	919	952	1.044

BQ7296

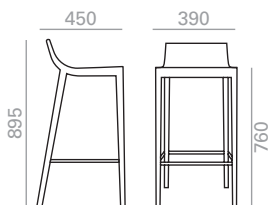

Barstool with oak board seat and backrest and solid oak wood frame. Optional: Upholstered seat pad.

Banqueta alta con asiento y respaldo de tablero de roble y estructura de madera maciza de roble. Opción de asiento plafonado.

	COM cm. per unit	COL m2
1 units	40	0,75
10 units or more	20	

0,24 m3

7,2 kg

x1

€ 576



COM	COL	1	2	3	4	5	6	7	8	9	10	11	L1	L2	L3	L6
640	642	643	646	647	648	652	655	656	659	664	669	672	677	693	721	798



Matte lacquered and premium upcharge
Incremento por lacado mate y premium

32



Roble
Oak

Measures +- 5 mm.
Medidas +- 5 mm.

SI7291

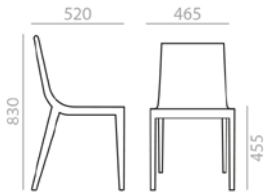

Chair with oak board seat and backrest and solid oak wood frame. Optional: Upholstered seat pad.

Silla con asiento y respaldo de tablero de roble y estructura de madera maciza de roble. Opción de asiento plafonado.

	COM cm. per unit	COL m2
1 units	48	1
10 units or more	24	

0,32 m3

14,8 kg

x2



€ 581



COM	COL	1	2	3	4	5	6	7	8	9	10	11	L1	L2	L3	L6
628	632	634	637	639	642	646	649	655	659	664	670	675	680	699	733	824



Matte lacquered and premium upcharge
Incremento por lacado mate y premium

39

For wooden legs. Para bases de madera.



Optional glides on page 482.

Opciones de tacos deslizantes en página 482.

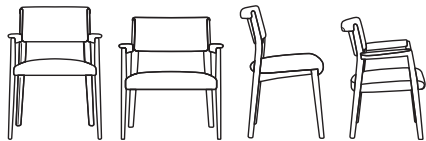

Description
Descripción

Chair, armchair and lounge chair with upholstered seat and backrest and 4-legged frame in solid beech wood. Wide version of chair and armchair available. A "bicolor" option is offered in which the back of the backrest and armrest can be upholstered in faux leather in two color tones to match the wood finish, brown for light wood finishes and black for dark wood finishes (*).

Silla, sillón y butaca con asiento y respaldo tapizado y estructura de 4 patas de madera maciza de haya. Disponible versión ancha de silla y sillón. Se ofrece una opción "bicolor" en la que la parte trasera del respaldo y el brazo pueden ir tapizados en ecopiel en dos tonos de color a juego con el acabado de la madera, marrón para acabados claros de madera y negro para acabados de madera oscura (*).

Upholstery
Tapicería

The Rizo collection supports following upholsteries of Andreu World Catalogue. For fabrics in our catalogue not specified in this box or customers own materials please contact our Customer Service Department.

La colección Rizo admite las siguientes tapicerías del catálogo de Andreu World. Para las telas de nuestro catálogo no indicadas en este cuadro o telas cliente, consultar con nuestro Departamento Comercial.

Fabrics / Telas

- 1 Jacquard One
- Jacquard Three
- Era
- Gravity
- Rivet
- Urban
- Spin One
- Spin Two
- Spin Three
- Spin Four
- Spin Five

- 2 Circular One Pure Eco
- Tack One (in/out)

- 3 Jacquard Four
- Medley
- Revive 1
- Main Line Flax
- Loom Two (in/out)
- Mezzo
- Reel two (in/out)
- Jacquard Five

- 4 Jacquard 4 Special
- Nexus
- Heritage
- Savane
- Loom Three
- Loom Four
- Cura
- Oceanic
- Reel Three (in/out)
- Reel Four (in/out)
- Spin Six

- 5 Silk
- Synergy
- Step
- Step Melange
- Blazer
- Melange Nap
- Chili
- Noma
- Re-wool

- 6 Go check
- Swing
- Chartres
- Zori
- Patio
- Tack Two (in/out)
- Tack Three (in/out)

- 7 Canvas 2
- Select
- Clara 2
- Tack Five (in/out)
- Hero 2

- 8 Capture
- Fiord 2
- Tonus 4
- Divina 3
- Lopi
- Domino

- 9 Divina MD
- Divina Melange 3
- Hallingdal 65
- Steelcut Trio 3
- Tack Four (in/out)

- 11 Arda
- Ecriture
- Zero

Faux Leather / Ecopiel

- 1 Valencia
- 2 Silvertex
- 3 Maglia
- 8 Ultraleather

- 9 Brisa
- Brisa Distressed
- Fresco
- Ultraleather Pro
- Promessa

- 10 Tottori
- Coast (in/out)

- 11 Reef Pro
- Volar Bio

Leather / Piel

- L1 High grade cow leather.
- Piel de vaca de 1ª categoría.

- L3 Polished full grain leather.
- Plena flor pulida.

- L6 Aniline leather batique-effect.
- Scandinavian cattle.
- Piel anilina efecto batique.
- Ganado escandinavo.

Wood finish Beech
Acabado madera Haya



Premium finish and wood lacquers
Acabado premium y lacas madera



***Faux leather finish bicolor**
***Acabado ecopiel bicolor**

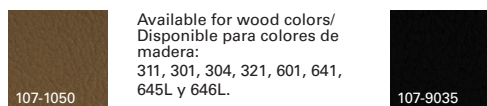

Available for wood colors/
Disponible para colores de
madera:
311, 301, 304, 321, 601, 641,
645L y 646L.

Available for wood colors/Dis-
ponible para colores de madera:
378, 322, 336, 364, 377, 372, 369,
381, 318, 661, 380, 642L, 605L
y 606L.

Certificates
Certificados

Fireproof polyurethane foam
Espuma de poliuretano ignifuga

UNE EN 1021:2006
BS 5852 part 2 crib 5
UNI 9175 Classe 1 IM
BKZ 5.2
California TB 117:2013
California TB 133*

*Contact our Customer Department
*Consultar con nuestro Departamento Comercial

Quality - Resistance
Calidad - Resistencia

UNE EN 16139:2013

Intellectual property Propiedad intelectual

All our collections are protected by international industrial design registries, designs patents, copyrights and intellectual Property laws. Unauthorized use of AW International Property is a criminal offence and can lead to prosecution.
Todas nuestras colecciones están protegidas por registros de diseño industrial, diseño de patente, copyright y derechos de propiedad intelectual todo el mundo. El uso no autorizado de los diseños y propiedad intelectual de AW supone un delito que puede ser sometido a acción judicial.



SI2040

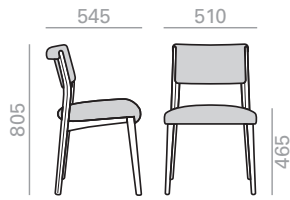

Chair with upholstered seat and backrest and solid beech wood frame. A "bicolor" option is offered in which the back of the backrest can be upholstered in faux leather in two color tones to match the wood finish, brown for light wood finishes and black for dark wood finishes.

Silla con asiento y respaldo tapizado y estructura de madera maciza de haya. Opción "bicolor" en la parte trasera del respaldo tapizada en ecopiel en dos tonos, combinados con los acabados de madera disponibles, marrón para maderas claras y de color negro para maderas oscuras.

	COM cm. per unit	COL m2
1 units	80	1,75
10 units or more	80	

0,23 m3
8 kg
x1

COM	COL	1	2	3	4	5	6	7	8	9	10	11	L1	L2	L3	L6
€ 472	479	487	494	499	509	519	527	537	545	555	564	573	581	614	675	834

SERIE 600 | Matte lacquered and premium upcharge | Incremento por lacado mate y premium | 39 |

SO2041

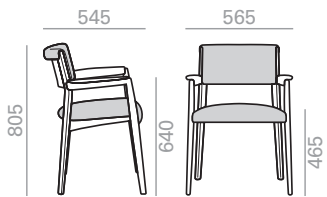

Armchair with upholstered seat and backrest and solid beech wood frame. Upholstered arm upcharge. A "bicolor" option is offered in which the back of the backrest and armrest can be upholstered in faux leather in n two color tones to match the wood finish, brown for light wood finishes and black for dark wood finishes.

Sillón con asiento y respaldo tapizado y estructura de madera maciza de haya. Incremento por reposabrazos tapizado. Opción "bicolor" en la parte trasera del respaldo y el reposabrazos, tapizadas en ecopiel en dos tonos, combinados con los acabados de madera disponibles, marrón para maderas claras y de color negro para maderas oscuras.

	COM cm. per unit	COL m2
1 units	110	2,25
10 units or more	90	

0,26 m3
9 kg
x1

COM	COL	1	2	3	4	5	6	7	8	9	10	11	L1	L2	L3	L6
€ 558	566	574	582	587	598	607	616	627	636	646	656	665	675	709	774	944

SERIE 600 | Matte lacquered and premium upcharge | Incremento por lacado mate y premium | 47 |  Upholstered arm upcharge | Incremento brazo tapizado | 54 |

SI2042

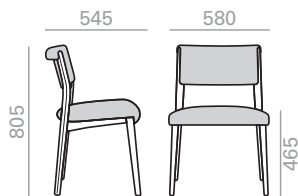

Chair with upholstered seat and backrest with solid beech wood frame. Wide version. A "bicolor" option is offered in which the back of the backrest can be upholstered in faux leather in two color tones to match the wood finish, brown for light wood finishes and black for dark wood finishes.

Silla con asiento y respaldo tapizado y estructura de madera maciza de haya. Versión ancha. Opción "bicolor" en la parte trasera del respaldo tapizada en ecopiel en dos tonos, combinados con los acabados de madera disponibles, color marrón para maderas claras y de color negro para maderas oscuras.

	COM cm. per unit	COL m2
1 units	80	1,75
10 units or more	80	

0,26 m3
8,5 kg
x1

COM	COL	1	2	3	4	5	6	7	8	9	10	11	L1	L2	L3	L6
€ 491	498	506	513	518	528	538	546	555	565	573	583	593	601	634	694	855

SERIE 600 | Matte lacquered and premium upcharge | Incremento por lacado mate y premium | 39 |

SO2043

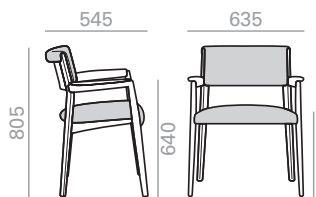

Armchair with upholstered seat and backrest with solid beech wood frame. Wide version. Upholstered arm upcharge. A "bicolor" option is offered in which the back of the backrest and armrest can be upholstered in faux leather in two color tones to match the wood finish, brown for light wood finishes and black for dark wood finishes.

Sillón con asiento y respaldo tapizado y estructura de madera maciza de haya. Versión ancha. Incremento por reposabrazos tapizado. Opción "bicolor" en la parte trasera del respaldo y el reposabrazos, tapizadas en ecopiel en dos tonos, combinados con los acabados de madera disponibles, marrón para maderas claras y de color negro para maderas oscuras.

	COM cm. per unit	COL m2
1 units	110	2,25
10 units or more	90	

0,29 m3
9,5 kg
x1

COM	COL	1	2	3	4	5	6	7	8	9	10	11	L1	L2	L3	L6
€ 595	603	611	619	624	635	645	655	665	676	685	694	705	713	750	816	991

SERIE 600 | Matte lacquered and premium upcharge | Incremento por lacado mate y premium | 47 |  Upholstered arm upcharge | Incremento brazo tapizado | 54 |

BU2044

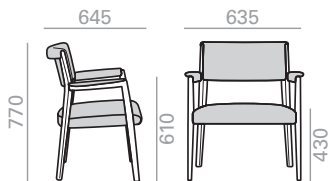

Lounge chair with upholstered seat and backrest with solid beech wood frame. A "bicolor" option is offered in which the back of the backrest and armrest can be upholstered in faux leather in two color tones to match the wood finish, brown for light wood finishes and black for dark wood finishes.

Butaca con asiento y respaldo tapizado y estructura de madera maciza de haya. Opción "bicolor" en la parte trasera del respaldo y el reposabrazos, tapizadas en ecopiel en dos tonos, combinados con los acabados de madera disponibles, marrón para maderas claras y de color negro para maderas oscuras.

	COM cm. per unit	COL m2
1 units	120	2,5
10 units or more	110	

0,33 m3
 11 kg
 x1

€	COM	COL	1	2	3	4	5	6	7	8	9	10	11	L1	L2	L3	L6
	659	669	680	690	698	710	724	736	749	762	775	787	801	812	858	943	1.167

SERIE
600

Matte lacquered and premium upcharge
Incremento por lacado mate y premium

47

For wooden legs. Para bases de madera.



Optional glides on page 482.

Opciones de tacos deslizantes en página 482.



Description
Descripción

Armchairs with oak board shell or Eco thermo-polymer shell available in several colors or Pure Eco thermo-polymer (100% recycled) available in sand color. Available with steel sled base in polished chrome finish, white or black, 4 legs steel tube base or steel swivel base in polished chrome finish, solid beech wood swivel base or central aluminum swivel 4 star base in self-return in polished aluminum finish, white or black. Barstool model with 4 legs steel swivel base with polished chrome base. Optional fully upholstered shell, seat pad or upholstered shell pad.

Sillones con carcasa de tablero de roble o de termopolímero Eco disponible en diferentes colores o termopolímero Pure Eco (100% reciclado) disponible en color arena. Disponibles con base de patín de varilla de acero y acabado cromo brillo, blanco o negro, 4 patas de tubo de acero o base central giratoria de acero, acabadas en cromo brillo, base central giratoria de madera maciza de fresno o base central giratoria de aluminio de 4 aspas, con sistema de retorno y acabado aluminio pulido, blanco o negro. Versión de banqueta con base giratoria de 4 patas de acero y acabado cromo brillo. Opción de carcasa tapizada, asiento plafonado o asiento y respaldo plafonado.

Upholstery
Tapicería

The Ronda collection supports following upholsteries of Andreu World Catalogue. All upholstered versions are made with 100% recycled Pure Eco thermo-polymer. For fabrics in our catalogue not specified in this box or customers own materials please contact our Customer Service Department.

La colección Ronda admite las siguientes tapicerías del catálogo de Andreu World. Todas las versiones tapizadas con están hechas con termopolímero Pure Eco 100% reciclado. Para las telas de nuestro catálogo no indicadas en este cuadro o telas cliente, consultar con nuestro Departamento Comercial.

Fabrics / Telas

- 1** Jacquard One
Jacquard Three
Era
Gravity
Rivet
Urban
Spin One
Spin Two
Spin Three
Spin Four
Spin Five
- 2** Circular One Pure Eco
Tack One (in/out)
- 3** Jacquard Four
Medley
Revive 1
Main Line Flax
Loom Two (in/out)
Mezzo
Reel two (in/out)
Jacquard Five

- 4** Jacquard 4 Special
Nexus
Heritage
Savane
Loom Three
Loom Four
Cura
Oceanic
Reel Three (in/out)
Reel Four (in/out)
Spin Six
- 5** Silk
Synergy
Step
Step Melange
Blazer
Melange Nap
Chilli
Noma
Re-wool

- 6** Go check
Swing
Chartres
Zori
Patio
Tack Two (in/out)
Tack Three (in/out)
- 7** Canvas 2
Select
Clara 2
Tack Five (in/out)
Hero 2

- 8** Capture
Fiord 2
Tonus 4
Divina 3
Lopi
Domino

- 9** Divina MD
Divina Melange 3
Hallingdal 65
Steelcut Trio 3
Tack Four (in/out)

- 11** Arda
Ecriture
Zero

Faux Leather / Ecopiel

- 1** Valencia
- 2** Silvertex
- 3** Maglia
- 8** Ultraleather
- 9** Brisa
Brisa Distressed
Fresco
Ultraleather Pro
Promessa
- 10** Tottori
Coast (in/out)
- 11** Reef Pro
Volar Bio

Leather / Piel

- L1** High grade cow leather.
Piel de vaca de 1ª categoría.
- L3** Polished full grain leather.
Piena flor pulida.
- L6** Aniline leather batique-effect.
Scandinavian cattle.
Piel anilina efecto batique.
Ganado escandinavo.

Hide Leather / Cuero

- L2** Chrome tanned split leather.
Base in polyurethane resin emulsion in water. Cellulose nitric varnish.
Costra cocida al cromo. Base de emulsiones de resinas poliuretánicas en agua. Barniz nitro celulósico.

Eco Thermo-polymer finish

Acabado de Termopolímero Eco

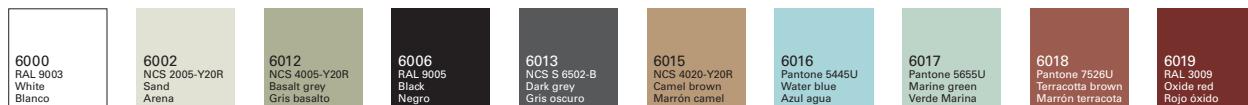

Pure Eco Thermo-polymer finish

Acabado de Termopolímero Pure Eco



Wood finish Oak

Acabado madera Roble



Aluminum finish
Acabado aluminio

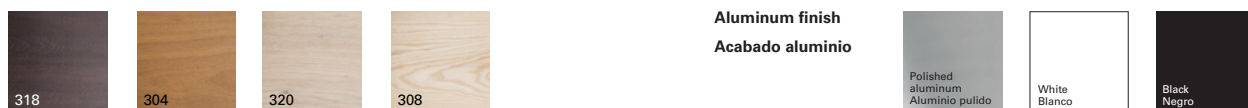

Wood finish Ash

Acabado madera Fresno



Steel finish
Acabado de acero



Premium finish and wood lacquers

Acabado premium y lacas madera



Certificates
Certificados

Fireproof polyurethane foam
Espuma de poliuretano ignifuga

UNE EN 1021:2006
BS 5852 part 2 crib 5
UNI 9175 Classe 1 IM
BKZ 5.2
California TB 117:2013
California TB 133*

*Contact our Customer Department
*Consultar con nuestro Departamento Comercial

Quality - Resistance
Calidad - Resistencia

UNE EN 16139:2013

Intellectual property Propiedad intelectual

All our collections are protected by international industrial design registries, designs patents, copyrights and intellectual Property laws. Unauthorized use of AW International Property is a criminal offence and can lead to prosecution.
Todas nuestras colecciones están protegidas por registros de diseño industrial, diseño de patente, copyright y derechos de propiedad intelectual todo el mundo. El uso no autorizado de los diseños y propiedad intelectual de AW supone un delito que puede ser sometido a acción judicial.



SO0453

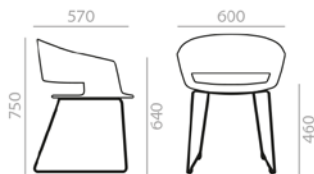

Armchair with oak board shell and steel sled base finished in polished chrome, white or black. Upholstered seat pad or upholstered shell pad. In upholstered versions the seat height increases 20 mm. (L2 Hide Leather).

Sillón con carcasa de tablero de roble y base de patín de varilla de acero en acabado cromo brillo, blanco o negro. Asiento plafonado o asiento y respaldo plafonado. En versiones tapizadas la altura de asiento aumenta 20 mm. (L2 Cuero).

COM cm. per unit	COL m2
------------------	--------

0,29 m3
10,7 kg
x1

Seat pad Asiento plafonado

1 units	55	1
10 units or more	30	

Shell pad Asiento y respaldo plafonado

1 units	110	2,25
10 units or more	100	



610

€

Oak
Roble



Upholstered seat pad
Asiento plafonado

COM	COL	1	2	3	4	5	6	7	8	9	10	11	L1	L2	L3	L6
695	698	702	706	709	713	717	722	727	731	736	740	744	748	765	795	874



Upholstered shell pad
Asiento y respaldo plafonado

COM	COL	1	2	3	4	5	6	7	8	9	10	11	L1	L2	L3	L6
814	825	838	849	858	872	886	900	915	929	943	957	971	983	1.035	1.141	1.437



Matte lacquered and premium upcharge
Incremento por lacado mate y premium

27

SO0425

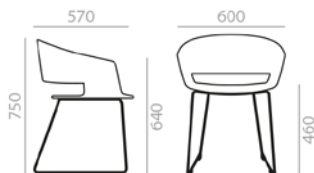

Armchair with Eco thermo-polymer shell available in several colors or Pure Eco thermo-polymer (100% recycled) available in sand color and steel sled base finished in polished chrome, white or black. Optional fully upholstered shell, upholstered seat pad or upholstered shell pad. In upholstered versions the seat height increases 20 mm. (L2 Hide Leather).

Sillón con carcasa de termopolímero Eco disponible en diferentes colores o termopolímero Pure Eco (100% reciclado) disponible en color arena y base de patín de varilla de acero en acabado cromo brillo, blanco o negro. Opción de carcasa tapizada, asiento plafonado o asiento y respaldo plafonado. En versiones tapizadas la altura de asiento aumenta 20 mm. (L2 Cuero).

COM cm. per unit	COL m2
------------------	--------

0,29 m3
10 kg
x1

Fully upholstered shell Carcasa tapizada

1 units	160	3
10 units or more	160	

Seat pad Asiento plafonado

1 units	55	1
10 units or more	30	

Shell pad Asiento y respaldo plafonado

1 units	110	2,25
10 units or more	110	



TP

228

€

Thermo-polymer shell
Carcasa termopolímero



Fully upholstered shell
Carcasa tapizada

COM	COL	1	2	3	4	5	6	7	8	9	10	11	L1	L2	L3	L6
432	448	467	483	495	517	537	559	583	605	629	654	676	698	781	936	1.380



Upholstered seat pad
Asiento plafonado

COM	COL	1	2	3	4	5	6	7	8	9	10	11	L1	L2	L3	L6
300	303	306	309	312	316	319	323	326	330	334	337	341	344	358	382	446



Upholstered shell pad
Asiento y respaldo plafonado

COM	COL	1	2	3	4	5	6	7	8	9	10	11	L1	L2	L3	L6
397	406	415	424	430	442	453	464	474	487	500	513	526	537	582	675	919



Roble
Oak



Fresno
Ash

Measures +- 5 mm.
Medidas +- 5 mm.

SO0454



Armchair with oak board seat and backrest and 4-legs steel base finished in polished chrome, white or black. Optional fully upholstered shell. Optional upholstered seat pad. In upholstered versions the seat height increases 20 mm. (L2 Hide Leather).
Sillón con carcasa de tablero de roble y base de 4 patas de acero en acabado cromo brillo, blanco o negro. Opción de carcasa tapizada. Opción de Asiento plafonado. En versiones tapizadas la altura de asiento aumenta 20 mm. (L2) Cuero.

COM cm. per unit	COL m2
------------------	--------

0,29 m3
9,1 kg
x1

Seat pad Asiento plafonado

1 units	55	1
10 units or more	30	

Shell pad Asiento y respaldo plafonado

1 units	110	2,25
10 units or more	100	

€  561
Oak
Roble

COM	COL	1	2	3	4	5	6	7	8	9	10	11	L1	L2	L3	L6
706	711	714	718	721	726	730	735	741	745	750	754	759	763	781	813	896

Upholstered seat pad
Asiento plafonado

COM	COL	1	2	3	4	5	6	7	8	9	10	11	L1	L2	L3	L6
827	837	851	863	871	886	901	916	931	947	962	975	991	1.004	1.059	1.161	1.448

Upholstered shell pad
Asiento y respaldo plafonado

SERIE 600 | Matte lacquered and premium upcharge
Incremento por lacado mate y premium | 27 |

SO0426

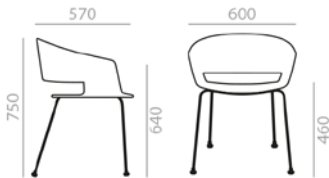

Armchair with Eco thermo-polymer shell available in several colors or Pure Eco thermo-polymer (100% recycled) available in sand colors and 4-legs steel base finished in polished chrome, white or black. Optional fully upholstered shell, upholstered seat pad or upholstered shell pad. In upholstered versions the seat height increases 20 mm. (L2 Hide Leather).
Sillón con carcasa de termopolímero Eco disponible en diferentes colores o termopolímero Pure Eco (100% reciclado) disponible en color arena y base de 4 patas de acero en acabado cromo brillo, blanco o negro. Opción de carcasa tapizada, asiento plafonado o asiento y respaldo plafonado. En versiones tapizadas la altura de asiento aumenta 20 mm. (L2) Cuero.

COM cm. per unit	COL m2
------------------	--------

0,3 m3
8,4 kg
x1

Fully upholstered shell Carcasa tapizada

1 units	160	3
10 units or more	160	

Seat pad Asiento plafonado

1 units	55	1
10 units or more	30	

Shell pad Asiento y respaldo plafonado

1 units	110	2,25
10 units or more	110	

€  TP
238
Thermo-polymer shell
Carcasa termopolímero

COM	COL	1	2	3	4	5	6	7	8	9	10	11	L1	L2	L3	L6
570	590	616	638	654	683	710	739	768	797	824	853	883	910	1.017	1.216	1.735

Fully upholstered shell
Carcasa tapizada

COM	COL	1	2	3	4	5	6	7	8	9	10	11	L1	L2	L3	L6
334	338	341	345	348	352	356	360	365	369	373	377	381	386	401	429	504

Upholstered seat pad
Asiento plafonado

COM	COL	1	2	3	4	5	6	7	8	9	10	11	L1	L2	L3	L6
431	441	452	462	469	481	494	506	519	532	544	557	569	580	625	708	946

Upholstered shell pad
Asiento y respaldo plafonado

SO0459

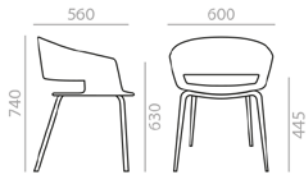

Armchair with oak board seat and backrest and 4-legs solid oak wood legs. Optional upholstered seat pad. In upholstered versions the seat height increases 20 mm. (L2 Hide Leather).

Sillón con carcasa de tablero de roble y base de 4 patas de roble. Opción de asiento plafonado. En versiones tapizadas la altura de asiento aumenta 20 mm. (L2) Cuero.

COM cm. per unit	COL m2
------------------	--------

0,28 m3

8,6 kg

x1

Seat pad Asiento plafonado

1 units	55	1
10 units or more	30	

Shell pad Asiento y respaldo plafonado

1 units	110	2,25
10 units or more	100	



681

Oak
Roble



Upholstered seat pad
Asiento plafonado

COM	COL	1	2	3	4	5	6	7	8	9	10	11	L1	L2	L3	L6
840	843	848	852	855	861	866	872	876	882	887	893	899	903	921	957	1.050



Upholstered shell pad
Asiento y respaldo plafonado

COM	COL	1	2	3	4	5	6	7	8	9	10	11	L1	L2	L3	L6
959	971	986	998	1.009	1.026	1.041	1.057	1.074	1.091	1.106	1.123	1.139	1.155	1.214	1.322	1.606



Matte lacquered and premium upcharge
Incremento por lacado mate y premium

44

SO0460

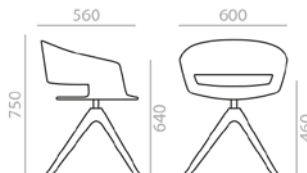

Armchair with oak board seat and backrest and 4-star solid ash wood swivel base. Optional upholstered seat pad. In upholstered versions the seat height increases 20 mm. (L2 Hide Leather).

Sillón con carcasa de tablero de roble y base central giratoria de 4 aspas de madera maciza de fresno. Opción de asiento plafonado. En versiones tapizadas la altura de asiento aumenta 20 mm. (L2) Cuero.

COM cm. per unit	COL m2
------------------	--------

0,28 m3

10,2 kg

x1

Seat pad Asiento plafonado

1 units	55	1
10 units or more	30	

Shell pad Asiento y respaldo plafonado

1 units	110	2,25
10 units or more	100	



736

Oak
Roble



Upholstered seat pad
Asiento plafonado

COM	COL	1	2	3	4	5	6	7	8	9	10	11	L1	L2	L3	L6
820	824	827	831	832	837	841	845	849	853	857	861	865	869	884	912	983



Upholstered shell pad
Asiento y respaldo plafonado

COM	COL	1	2	3	4	5	6	7	8	9	10	11	L1	L2	L3	L6
940	950	961	971	979	992	1.006	1.019	1.033	1.045	1.058	1.072	1.084	1.097	1.145	1.232	1.494



Matte lacquered and premium upcharge
Incremento por lacado mate y premium

24



Roble
Oak



Fresno
Ash

Measures +- 5 mm.
Medidas +- 5 mm.

SO0429

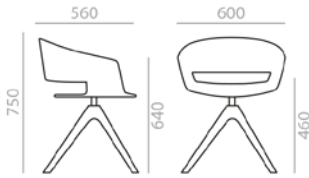

Armchair with Eco thermo-polymer shell available in several colors or Pure Eco thermo-polymer (100% recycled) available in sand color and 4- star solid ash wood swivel base. Optional fully upholstered shell, upholstered seat pad or upholstered shell pad. In upholstered versions the seat height increases 20 mm. (L2 Hide Leather).

Sillón con carcasa de termopolímero Eco disponible en diferentes colores o termopolímero Pure Eco (100% reciclado) disponible en color arena y base central giratoria de 4 aspas de madera maciza de fresno. Opción de carcasa tapizada, asiento plafonado o asiento y respaldo plafonado. En versiones tapizadas la altura de asiento aumenta 20 mm. (L2) Cuero.

COM cm. per unit	COL m2
------------------	--------

0,27 m3
9,5 kg
x1

Fully upholstered shell Carcasa tapizada		
1 units	160	3
10 units or more	160	

Seat pad Asiento plafonado		
1 units	55	1
10 units or more	30	

Shell pad Asiento y respaldo plafonado		
1 units	110	2,25
10 units or more	110	

€ TP
408

Thermo-polymer shell
Carcasa termopolímero

COM COL 1 2 3 4 5 6 7 8 9 10 11 L1 L2 L3 L6
649 666 685 701 714 736 757 779 801 826 849 873 898 920 1.033 1.186 1.591

Fully upholstered shell
Carcasa tapizada

COM COL 1 2 3 4 5 6 7 8 9 10 11 L1 L2 L3 L6
503 506 509 513 515 519 523 526 530 534 538 541 545 548 562 587 664

Upholstered seat pad
Asiento plafonado

COM COL 1 2 3 4 5 6 7 8 9 10 11 L1 L2 L3 L6
624 633 644 654 661 673 686 698 710 732 744 758 771 784 832 939 1.218

Upholstered shell pad
Asiento y respaldo plafonado

SERIE 600 Matte lacquered and premium upcharge Incremento por lacado mate y premium | 24 |

SO0465

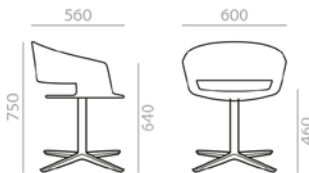

Armchair with oak board seat and backrest and 4-star central aluminum swivel base with self-return system and finished in polished aluminum, white or black. Optional upholstered seat pad. In upholstered versions the seat height increases 20 mm. (L2 Hide Leather).

Sillón con carcasa de tablero de roble y base central giratoria de aluminio de 4 aspas con sistema de retorno y acabado aluminio pulido, blanco o negro. Opción de asiento plafonado. En versiones tapizadas la altura de asiento aumenta 20 mm. (L2) Cuero.

COM cm. per unit	COL m2
------------------	--------

0,26 m3
12 kg
x1

Seat pad Asiento plafonado		
1 units	55	1
10 units or more	30	

Shell pad Asiento y respaldo plafonado		
1 units	110	2,25
10 units or more	100	

€ 658

Oak
Roble

COM COL 1 2 3 4 5 6 7 8 9 10 11 L1 L2 L3 L6
743 745 748 752 753 758 762 766 770 774 778 782 785 789 803 830 898

Upholstered seat pad
Asiento plafonado

COM COL 1 2 3 4 5 6 7 8 9 10 11 L1 L2 L3 L6
863 873 884 894 902 915 927 940 953 965 978 991 1.005 1.016 1.062 1.158 1.432

Upholstered shell pad
Asiento y respaldo plafonado

SERIE 600 Matte lacquered and premium upcharge Incremento por lacado mate y premium | 27 |



Measures +- 5 mm.
Medidas +- 5 mm.

SO0430

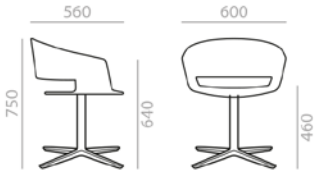

Armchair with Eco thermo-polymer shell available in several colors or Pure Eco thermo-polymer (100% recycled) available in sand color and 4- star central aluminum swivel base with self-return system and finished in polished aluminum, white or black. Optional fully upholstered shell, upholstered seat pad or upholstered shell pad. In upholstered versions the seat height increases 20 mm. (L2 Hide Leather).

Sillón con carcasa de termopolímero Eco disponible en diferentes colores o termopolímero Pure Eco (100% reciclado) disponible en color arena y base central giratoria de aluminio de 4 aspas con sistema de retorno y acabado aluminio pulido, blanco o negro. Opción de asiento plafonado. En versiones tapizadas la altura de asiento aumenta 20 mm. (L2) Cuero.

COM cm. per unit	COL m2
------------------	--------

0,26 m3
11,3 kg
x1

Fully upholstered shell Carcasa tapizada

1 units	160	3
10 units or more	160	

Seat pad Asiento plafonado

1 units	55	1
10 units or more	30	

Shell pad Asiento y respaldo plafonado

1 units	110	2,25
10 units or more	110	

€ TP
374



COM	COL	1	2	3	4	5	6	7	8	9	10	11	L1	L2	L3	L6
613	629	650	668	680	704	726	749	775	802	829	853	880	904	997	1.169	1.671

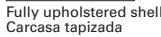

COM	COL	1	2	3	4	5	6	7	8	9	10	11	L1	L2	L3	L6
468	471	474	478	480	484	488	492	496	500	505	509	513	516	531	557	628



COM	COL	1	2	3	4	5	6	7	8	9	10	11	L1	L2	L3	L6
569	578	589	599	606	618	631	644	656	668	680	693	705	717	761	858	1.141

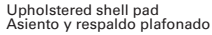

SO0479

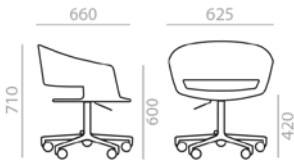

Armchair with oak board seat and backrest and aluminum central base with 5 casters, swivel and pneumatic height adjustment. Available in polished aluminum, white or black. Optional upholstered seat pad. In upholstered versions the seat height increases 20 mm. (L2 Hide Leather).

Sillón con carcasa de tablero de roble y base central giratoria de aluminio de 5 ruedas, regulable en altura y acabado aluminio pulido, blanco o negro. Opción de asiento plafonado. En versiones tapizadas la altura de asiento aumenta 20 mm. (L2) Cuero.

COM cm. per unit	COL m2
------------------	--------

0,32 m3
10,9 kg
x1

Seat pad Asiento plafonado

1 units	55	1
10 units or more	30	

Shell pad Asiento y respaldo plafonado

1 units	110	2,25
10 units or more	100	

€ 867



COM	COL	1	2	3	4	5	6	7	8	9	10	11	L1	L2	L3	L6
949	952	957	962	965	971	976	980	987	991	998	1.002	1.008	1.013	1.032	1.068	1.161



COM	COL	1	2	3	4	5	6	7	8	9	10	11	L1	L2	L3	L6
1.068	1.081	1.095	1.107	1.118	1.134	1.151	1.167	1.184	1.201	1.217	1.234	1.252	1.266	1.327	1.436	1.756

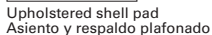

SERIE 600
Matte lacquered and premium upcharge
Incremento por lacado mate y premium

27



Measures +- 5 mm.
Medidas +- 5 mm.

SO0480

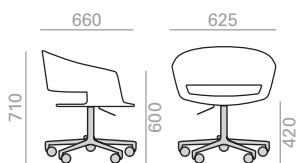

Armchair with oak shell and thermo-polymer central base with 5 casters, swivel and pneumatic height adjustment, finished in black. Available options: Upholstered shell, upholstered seat pad or upholstered shell pad.

Sillón con carcasa de roble y base central giratoria de termopolímero de 5 ruedas, regulable en altura y acabado negro. Opciones disponibles: Asiento plafonado o asiento y respaldo plafonado. En versiones tapizadas la altura de asiento aumenta 20 mm. (L2) Cuero.

COM cm. per unit	COL m2
------------------	--------

0,34 m3
9,9 kg
x1

Seat pad Asiento plafonado

1 units	55	1
10 units or more	30	

Shell pad Asiento y respaldo plafonado

1 units	110	2,25
10 units or more	100	

€



Oak
Roble

674



Upholstered seat pad
Asiento plafonado

COM	COL	1	2	3	4	5	6	7	8	9	10	11	L1	L2	L3	L6
759	764	767	772	775	779	784	789	793	798	803	807	812	817	834	866	950



Upholstered shell pad
Asiento y respaldo plafonado

COM	COL	1	2	3	4	5	6	7	8	9	10	11	L1	L2	L3	L6
883	894	908	920	928	944	959	973	989	1.005	1.019	1.034	1.050	1.062	1.117	1.217	1.504



SERIE
600

Matte lacquered and premium upcharge
Incremento por lacado mate y premium

| 27 |

SO0431



Armchair with Eco thermo-polymer shell available in several colors or Pure Eco thermo-polymer (100% recycled) available in sand color and aluminum central base with 5 casters, swivel and pneumatic height adjustment. Available in polished aluminum, white or black. Optional fully upholstered seat pad. In upholstered versions the seat height increases 20 mm. (L2 Hide Leather).

Sillón con carcasa de termopolímero Eco disponible en diferentes colores o termopolímero Pure Eco (100% reciclado) disponible en color arena y base central giratoria de aluminio de 5 ruedas, regulable en altura y acabado aluminio pulido blanco o negro. Opción de carcasa tapizada, asiento plafonado o asiento plafonado. En versiones tapizadas la altura de asiento aumenta 20 mm. (L2) Cuero.

COM cm. per unit	COL m2
------------------	--------

0,29 m3
10,2 kg
x1

Fully upholstered shell Carcasa tapizada

1 units	160	3
10 units or more	160	

Seat pad Asiento plafonado

1 units	55	1
10 units or more	30	

Shell pad Asiento y respaldo plafonado

1 units	110	2,25
10 units or more	110	

€



Thermo-polymer shell
Carcasa termopolímero

TP

408



Fully upholstered shell
Carcasa tapizada

COM	COL	1	2	3	4	5	6	7	8	9	10	11	L1	L2	L3	L6
643	661	685	705	720	745	770	796	822	847	873	899	924	947	1.044	1.223	1.691



Upholstered seat pad
Asiento plafonado

COM	COL	1	2	3	4	5	6	7	8	9	10	11	L1	L2	L3	L6
502	505	509	513	516	520	526	530	535	540	545	549	555	559	576	607	691



Upholstered shell pad
Asiento y respaldo plafonado

COM	COL	1	2	3	4	5	6	7	8	9	10	11	L1	L2	L3	L6
600	609	622	633	642	656	670	684	698	711	725	739	753	766	816	910	1.196



Roble
Oak



Fresno
Ash

Measures +- 5 mm.
Medidas +- 5 mm.

SO0481

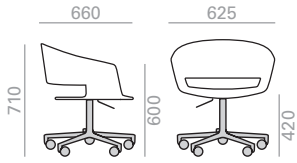

Armchair with Eco thermo-polymer shell available in several colors or Pure Eco thermo-polymer (100% recycled) available in sand color and thermo-polymer central base with 5 casters, swivel and pneumatic height adjustment, finished in black. Available options: Optional fully upholstered shell, upholstered seat pad or upholstered shell pad.

Sillón con carcasa de termopolímero Eco disponible en diferentes colores o termopolímero Pure Eco (100% reciclado) disponible en color arena y base central giratoria de termopolímero de 5 ruedas, regulable en altura y acabado negro. Opciones disponibles: Carcasa tapizada, asiento plafonado o asiento y respaldo plafonado. En versiones tapizadas la altura de asiento aumenta 20 mm. (L2) Cuero.

COM cm. per unit	COL m2
------------------	--------

0,29 m3
11,2 kg
x1

Fully upholstered shell Carcasa tapizada

1 units	160	3
10 units or more	160	

Seat pad Asiento plafonado

1 units	55	1
10 units or more	30	

Shell pad Asiento y respaldo plafonado

1 units	110	2,25
10 units or more	110	

€ 386

Thermo-polymer shell
Carcasa termopolímero

€ 590 603 620 634 645 664 688 710 734 757 782 806 831 849 937 1.093 1.508

Fully upholstered shell
Carcasa tapizada

€ 470 472 475 478 480 483 487 490 494 497 501 504 508 510 523 544 603

Upholstered seat pad
Asiento plafonado

€ 583 591 600 609 615 627 637 648 659 670 682 692 703 716 776 885 1.172

Upholstered shell pad
Asiento y respaldo plafonado

BQ0476

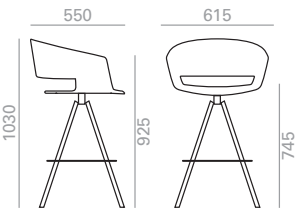

Barstool with oak board seat and backrest and 4-legs steel swivel base finished in polished chrome, white or black. Optional fully upholstered shell. Optional upholstered seat pad. In upholstered versions the seat height increases 20 mm. (L2 Hide Leather).

Banqueta alta con carcasa de tablero de roble y base giratoria de 4 patas de acero y acabado cromo brillo, blanco o negro. Opción de carcasa tapizada. Opción de asiento plafonado. En versiones tapizadas la altura de asiento aumenta 20 mm. (L2) Cuero.

COM cm. per unit	COL m2
------------------	--------

0,38 m3
10,6 kg
x1

Seat pad Asiento plafonado

1 units	55	1
10 units or more	30	

Shell pad Asiento y respaldo plafonado

1 units	110	2,25
10 units or more	100	

€ 723

Oak
Roble

€ 807 811 814 818 821 826 830 834 838 843 847 851 856 860 876 905 983

Upholstered seat pad
Asiento plafonado

€ 928 939 951 963 970 985 998 1.013 1.027 1.041 1.055 1.068 1.083 1.096 1.146 1.241 1.534

Upholstered shell pad
Asiento y respaldo plafonado

SERIE 600 Matte lacquered and premium upcharge
Incremento por lacado mate y premium

| 27 |



Measures +- 5 mm.
Medidas +- 5 mm.

BQ0432

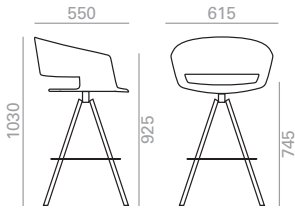

Barstool with Eco thermo-polymer shell available in several colors or Pure Eco thermo-polymer (100% recycled) available in sand col or and 4- legs steel swivel base finished in polished chrome, white or black. Optional fully upholstered shell, upholstered seat pad or upholstered shell pad. In upholstered versions the seat height increases 20 mm. (L2 Hide Leather).

Banqueta alta con carcasa de termopolímero Eco disponible en diferentes colores o termopolímero Pure Eco (100% reciclado) disponible en color arena y base giratoria de 4 patas de acero y acabado cromo brillo, blanco o negro. Opción de carcasa tapizada, asiento plafonado o asiento y respaldo plafonado. En versiones tapizadas la altura de asiento aumenta 20 mm. (L2) Cuero.

COM cm. per unit	COL m2
------------------	--------

0,38 m3
11,3 kg
x1

Fully upholstered shell Carcasa tapizada

1 units	160	3
10 units or more	160	

Seat pad Asiento plafonado

1 units	55	1
10 units or more	30	

Shell pad Asiento y respaldo plafonado

1 units	110	2,25
10 units or more	110	

€ TP
408



Thermo-polymer shell
Carcasa termopolímero



Fully upholstered shell
Carcasa tapizada



Upholstered seat pad
Asiento plafonado



Upholstered shell pad
Asiento y respaldo plafonado

COM	COL	1	2	3	4	5	6	7	8	9	10	11	L1	L2	L3	L6
683	704	729	750	766	793	821	848	877	903	932	959	988	1.011	1.117	1.346	1.852
502	505	509	513	516	520	524	530	534	538	542	548	552	556	571	602	680
600	611	622	633	640	654	668	681	695	707	721	735	748	760	809	904	1.194

BQ0478

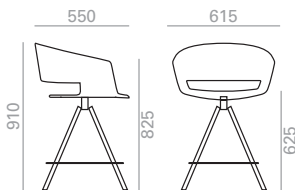

Counter stool with oak board seat and backrest and 4 legs steel swivel base finished in polished chrome, white or black. Optional upholstered seat pad. In upholstered versions the seat height increases 20 mm. (L2 Hide Leather).

Banqueta baja con carcasa de tablero de roble y base giratoria de 4 patas de acero y acabado cromo brillo, blanco o negro. Opción de Asiento plafonado. En versiones tapizadas la altura de asiento aumenta 20 mm. (L2) Cuero.

COM cm. per unit	COL m2
------------------	--------

0,34 m3
10 kg
x1

Seat pad Asiento plafonado

1 units	55	1
10 units or more	30	

Shell pad Asiento y respaldo plafonado

1 units	110	2,25
10 units or more	100	

€ 723



Oak
Roble



Upholstered seat pad
Asiento plafonado



Upholstered shell pad
Asiento y respaldo plafonado

COM	COL	1	2	3	4	5	6	7	8	9	10	11	L1	L2	L3	L6
807	811	814	818	821	826	830	834	838	843	847	851	856	860	876	905	983
928	939	951	963	970	985	998	1.013	1.027	1.041	1.055	1.068	1.083	1.096	1.146	1.241	1.534

SERIE 600
Matte lacquered and premium upcharge
Incremento por lacado mate y premium

| 27 |



Roble
Oak



Fresno
Ash

Measures +- 5 mm.
Medidas +- 5 mm.

BQ0433

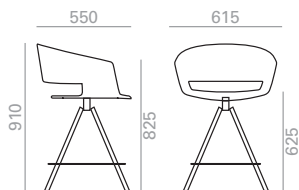

Counter stool with Eco thermo-polymer shell available in several colors or Pure Eco thermo-polymer (100% recycled) available in sand color and 4-legs steel swivel base finished in polished chrome, white or black. Optional fully upholstered shell, upholstered seat pad or upholstered shell pad. In upholstered versions the seat height increases 20 mm. (L2 Hide Leather).

Banqueta baja con carcasa de termopolímero Eco disponible en diferentes colores o termopolímero Pure Eco (100% reciclado) disponible en color arena y base giratoria de 4 patas de acero y acabado cromo brillo, blanco o negro. Opción de carcasa tapizada, asiento plafonado o asiento y respaldo plafonado. En versiones tapizadas la altura de asiento aumenta 20 mm. (L2) Cuero.

COM cm. per unit	COL m2
------------------	--------

0,34 m3
10,8 kg
x1

Fully upholstered shell Carcasa tapizada

1 units	160	3
10 units or more	160	

Seat pad Asiento plafonado

1 units	55	1
10 units or more	30	

Shell pad Asiento y respaldo plafonado

1 units	110	2,25
10 units or more	110	

€ TP
408



Thermo-polymer shell
Carcasa termopolímero



Fully upholstered shell
Carcasa tapizada



Upholstered seat pad
Asiento plafonado



Upholstered shell pad
Asiento y respaldo plafonado

COM	COL	1	2	3	4	5	6	7	8	9	10	11	L1	L2	L3	L6
683	704	729	750	766	793	821	848	877	903	932	959	988	1.011	1.117	1.346	1.852
502	505	509	513	516	520	524	530	534	538	542	548	552	556	571	602	680
600	611	622	633	640	654	668	681	695	707	721	735	748	760	809	904	1.194

BQ0485

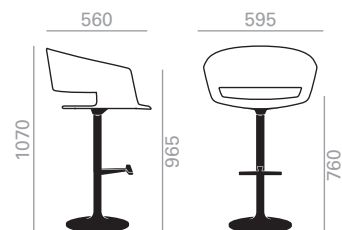

Barstool with oak board shell and injection swivel central base finished in polished aluminum, white or black. In upholstered versions the seat height increases 20 mm. (L2 Hide Leather).

Banqueta alta con carcasa de roble y base central giratoria de inyección de aluminio en acabado aluminio pulido, blanco o negro. En versiones tapizadas la altura de asiento aumenta 20 mm. (L2) Cuero.

COM cm. per unit	COL m2
------------------	--------

0,57 m3
14,3 kg
x1

Seat pad Asiento plafonado

1 units	55	1
10 units or more	30	

Shell pad Asiento y respaldo plafonado

1 units	110	2,25
10 units or more	100	

€ 696



Oak
Roble



Upholstered seat pad
Asiento plafonado



Upholstered shell pad
Asiento y respaldo plafonado

COM	COL	1	2	3	4	5	6	7	8	9	10	11	L1	L2	L3	L6
801	804	807	810	813	818	821	826	829	833	838	841	846	849	863	891	961
933	944	955	966	974	986	1.000	1.013	1.027	1.039	1.052	1.066	1.078	1.091	1.138	1.225	1.494

SERIE 600
Matte lacquered and premium upcharge
Incremento por lacado mate y premium

| 27 |



Roble
Oak



Fresno
Ash

Measures +- 5 mm.
Medidas +- 5 mm.

BQ0487

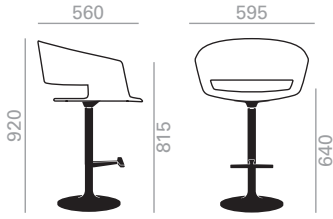

Counter stool with oak board shell and injection swivel central base finished in polished aluminum, white or black. In upholstered versions the seat height increases 20 mm. (L2 Hide Leather).

Banqueta baja con carcasa de roble y base central giratoria de inyección de aluminio en acabado aluminio pulido, blanco o negro. En versiones tapizadas la altura de asiento aumenta 20 mm. (L2) Cuero.

COM cm. per unit	COL m2
------------------	--------

0,35 m3
10 kg
x1

Seat pad Asiento plafonado

1 units	55	1
10 units or more	30	

Shell pad Asiento y respaldo plafonado

1 units	110	2,25
10 units or more	100	



696

Oak Roble



Upholstered seat pad Asiento plafonado

COM	COL	1	2	3	4	5	6	7	8	9	10	11	L1	L2	L3	L6
801	804	807	810	813	818	821	826	829	833	838	841	846	849	863	891	961



Upholstered shell pad Asiento y respaldo plafonado

COM	COL	1	2	3	4	5	6	7	8	9	10	11	L1	L2	L3	L6
933	944	955	966	974	986	1.000	1.013	1.027	1.039	1.052	1.066	1.078	1.091	1.138	1.225	1.494



Matte lacquered and premium upcharge Incremento por lacado mate y premium

27

BQ0488

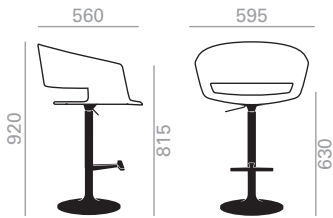

Barstool with oak board shell and injection swivel central base, adjustable height and finished in polished aluminum, white or black. In upholstered versions the seat height increases 0.75 inches. Height ranges: seat 24.75-30 pulgadas/arms 32-37.25 pulgadas. (L2 Hide Leather).

Banqueta alta con carcasa de roble y base central giratoria de inyección de aluminio, regulable en altura y acabado aluminio pulido, blanco o negro. En versiones tapizadas la altura de asiento aumenta 20 mm. Rangos de altura: asiento 630-760 mm./brazos 815-945 mm. (L2) Cuero.

COM cm. per unit	COL m2
------------------	--------

0,35 m3
10 kg
x1

Seat pad Asiento plafonado

1 units	55	1
10 units or more	30	

Shell pad Asiento y respaldo plafonado

1 units	110	2,25
10 units or more	100	



710

Oak Roble



Upholstered seat pad Asiento plafonado

COM	COL	1	2	3	4	5	6	7	8	9	10	11	L1	L2	L3	L6
817	820	823	826	829	834	837	842	845	850	854	858	862	865	881	908	980



Upholstered shell pad Asiento y respaldo plafonado

COM	COL	1	2	3	4	5	6	7	8	9	10	11	L1	L2	L3	L6
953	964	975	986	994	1.007	1.021	1.034	1.048	1.060	1.075	1.087	1.102	1.114	1.162	1.252	1.524



Matte lacquered and premium upcharge Incremento por lacado mate y premium

27



Roble Oak



Fresno Ash

Measures +- 5 mm. Medidas +- 5 mm.

BQ0482

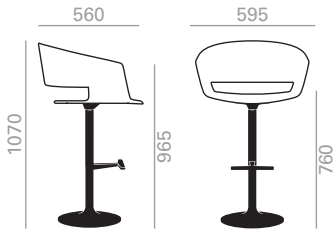

Barstool with ECO thermo-polymer shell and injection swivel central base finished in polished aluminum, white or black. In upholstered versions the seat height increases 20 mm. (L2 Hide Leather).

Banqueta alta con carcasa de termopolímero ECO y base central giratoria de inyección de aluminio en acabado aluminio pulido, blanco o negro. En versiones tapizadas la altura de asiento aumenta 20 mm. (L2) Cuero.

COM cm. per unit	COL m2
------------------	--------

0,57 m3
14,3 kg
x1

Fully upholstered shell Carcasa tapizada

1 units	160	3
10 units or more	160	

Seat pad Asiento plafonado

1 units	55	1
10 units or more	30	

Shell pad Asiento y respaldo plafonado

1 units	110	2,25
10 units or more	100	

€ TP
414



Thermo-polymer shell
Carcasa termopolímero



Fully upholstered shell
Carcasa tapizada



Upholstered seat pad
Asiento plafonado



Upholstered shell pad
Asiento y respaldo plafonado

COM	COL	1	2	3	4	5	6	7	8	9	10	11	L1	L2	L3	L6
706	724	746	765	778	803	827	850	874	898	921	945	969	991	1.077	1.234	1.682
509	512	515	519	521	525	529	533	536	541	545	549	552	556	570	596	665
630	639	650	660	667	680	693	705	718	731	744	755	768	779	825	909	1.189

BQ0483

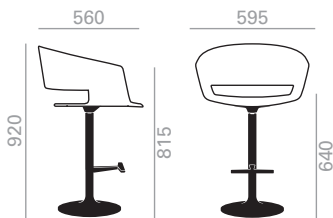

Counter stool with ECO thermo-polymer shell and injection swivel central base finished in polished aluminum, white or black. In upholstered versions the seat height increases 20 mm. (L2 Hide Leather).

Banqueta baja con carcasa de termopolímero ECO y base central giratoria de inyección de aluminio en acabado aluminio pulido, blanco o negro. En versiones tapizadas la altura de asiento aumenta 20 mm. (L2) Cuero.

COM cm. per unit	COL m2
------------------	--------

0,35 m3
10 kg
x1

Fully upholstered shell Carcasa tapizada

1 units	160	3
10 units or more	160	

Seat pad Asiento plafonado

1 units	55	1
10 units or more	30	

Shell pad Asiento y respaldo plafonado

1 units	110	2,25
10 units or more	100	

€ TP
414



Thermo-polymer shell
Carcasa termopolímero



Fully upholstered shell
Carcasa tapizada



Upholstered seat pad
Asiento plafonado



Upholstered shell pad
Asiento y respaldo plafonado

COM	COL	1	2	3	4	5	6	7	8	9	10	11	L1	L2	L3	L6
706	724	746	765	778	803	827	850	874	898	921	945	969	991	1.077	1.234	1.682
509	512	515	519	521	525	529	533	536	541	545	549	552	556	570	596	665
630	639	650	660	667	680	693	705	718	731	744	755	768	779	825	909	1.189



Measures +- 5 mm.
Medidas +- 5 mm.

BQ0484

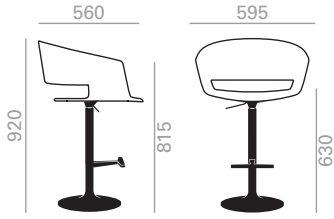

Barstool with ECO thermo-polymer shell and injection swivel central base, adjustable height and finished in polished aluminum, white or black. In upholstered versions the seat height increases 0.75 inches. Height ranges: seat 24.75-30 pulgadas/arms 32-37.25 pulgadas. (L2 Hide Leather).

Banqueta alta con carcasa de termopolímero ECO y base central giratoria de inyección de aluminio, regulable en altura y acabado aluminio pulido, blanco o negro. En versiones tapizadas la altura de asiento aumenta 20 mm. Rangos de altura: asiento 630-760 mm./brazos 815-945 mm. (L2) Cuero.

COM cm. per unit	COL m2
------------------	--------

0,35 m3
10 kg
x1

Fully upholstered shell Carcasa tapizada

1 units	160	3
10 units or more	160	

Seat pad Asiento plafonado

1 units	55	1
10 units or more	30	

Shell pad Asiento y respaldo plafonado

1 units	110	2,25
10 units or more	100	

€ TP
422

Thermo-polymer shell
Carcasa termopolímero

COM COL 1 2 3 4 5 6 7 8 9 10 11 L1 L2 L3 L6
721 739 761 780 794 818 842 867 891 914 940 963 987 1.010 1.099 1.256 1.716

Fully upholstered shell
Carcasa tapizada

COM COL 1 2 3 4 5 6 7 8 9 10 11 L1 L2 L3 L6
520 523 526 530 532 536 540 545 547 552 556 560 565 567 582 609 678

Upholstered seat pad
Asiento plafonado

COM COL 1 2 3 4 5 6 7 8 9 10 11 L1 L2 L3 L6
642 652 664 674 681 694 707 720 733 746 759 772 785 796 843 928 1.213

Upholstered shell pad
Asiento y respaldo plafonado

SO0455

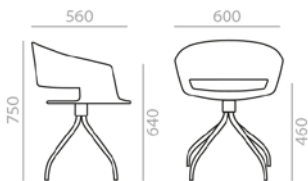

Armchair with oak board seat and backrest and 4-star central steel swivel base and polished chrome finish. Optional upholstered seat pad.

Sillón con carcasa de tablero de roble y base central giratoria de acero de 4 espas y acabado cromo brillo. Opción de asiento plafonado.

COM cm. per unit	COL m2
------------------	--------

0,33 m3
9 kg
x1

Seat pad Asiento plafonado

1 units	55	1
10 units or more	30	

Shell pad Asiento y respaldo plafonado

1 units	110	2,25
10 units or more	100	

€
580

Oak
Roble

COM COL 1 2 3 4 5 6 7 8 9 10 11 L1 L2 L3 L6
677 680 684 689 692 696 702 707 713 717 722 728 732 737 755 789 877

Upholstered seat pad
Asiento plafonado

COM COL 1 2 3 4 5 6 7 8 9 10 11 L1 L2 L3 L6
787 799 813 825 834 850 865 881 898 913 929 944 961 974 1.031 1.134 1.408

Upholstered shell pad
Asiento y respaldo plafonado

SERIE
600

Matte lacquered and premium upcharge
Incremento por lacado mate y premium

| 27 |





Roble
Oak



Fresno
Ash

Measures +- 5 mm.
Medidas +- 5 mm.



Glides for 4 star aluminum central base. Tacos para base central de aluminio de 4 aspas.

Use/Usó	Reference/Referencia		Material/Material	Price/Precio	
Hard floors. Suelos duros.	TS0544		Plastic (PE). Plástico (PE).	0 €	Standard. Estándar.
Wooden and delicated floors. Suelos de madera y delicados.	TS0556		Plastic (PE) with felt. Plástico (PE) con fieltro.	3 €	Set of 4 glides. Juego de 4 tacos.
Mats/carpet floors. Suelos de moqueta/ alfombra.	TS0557		No glide. Sin taco.	0 €	

The indicated price is for glides placed on chairs. To order loose parts, please ask to our Sales Department.

El precio indicado en Tarifa es para tacos colocados en las sillas. Para pedidos de tacos sueltos de repuesto, consultar con el Departamento Comercial.

Glies for 4 metal legs base. Tacos para bases de 4 patas metálicas.

Use/Usó	Reference/Referencia		Material/Material	Price/Precio	
Hard floors. Suelos duros.	TS0560		Plastic (PE). Plástico (PE).	0 €	Standard. Estándar.
Wooden and delicated floors. Suelos de madera y delicados.	TS0542		Plastic (PE) with felt. Plástico (PE) con fieltro.	3 €	Set of 4 glides. Juego de 4 tacos.
Mats/carpet floors. Suelos de moqueta/ alfombra.	TS0566		Metal. Metal.	3 €	Set of 4 glides. Juego de 4 tacos.



Glides for sled bases/cantilever. Tacos para bases de patín/cantilever.

Use/Usó	Reference/Referencia		Material/Material	Price/Precio	
Hard floors. Suelos duros.	TS0531		Plastic (PE). Plástico (PE).	0 €	Standard. Estándar.
Wooden and delicated floors. Suelos de madera y delicados.	TS0538		Plastic (PE) with felt. Plástico (PE) con fieltro.	6 €	Set of 4 glides. Juego de 4 tacos.
Mats/carpet floors. Suelos de moqueta/ alfombra.	TS0537		No glide. Sin taco.	0 €	

The indicated price is for glides placed on chairs. To order loose parts, please ask to our Sales Department.

El precio indicado en Tarifa es para tacos colocados en las sillas. Para pedidos de tacos sueltos de repuesto, consultar con el Departamento Comercial.

Glides for 4 steel legs with swivel base. Tacos para base giratoria de 4 patas de acero.

Use/Usó	Reference/Referencia		Material/Material	Price/Precio	
Hard floors and mats/ carpet floors. Suelos duros y moqueta/alfombra.	TS0416		Plastic (PE). Plástico (PE).	0 €	Standard. Estándar.
Wooden and delicated floors. Suelos de madera y delicados.	TS0417		Plastic (PE) with felt. Plástico (PE) con fieltro.	12 €	Set of 4 glides. Juego de 4 tacos.

For wooden legs. Para bases de madera.



Optional glides on page 482.

Opciones de tacos deslizantes en página 482.

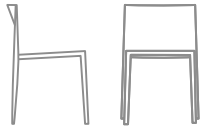

Description
Descripción

Stackable chair and stool, in 2 different heights, in Eco thermo-polymer available in different colors (Cayenne Red and Mango Green only available in S11245) or Pure Eco thermo-polymer (100% recycled) available in sand color. Available fully upholstered in leather or oak wood version.

Silla apilable y banqueta, en 2 alturas diferentes, de termopolímero Eco disponible en diferentes colores (rojo cayena y verde mango solo disponible en S11245) o termopolímero Pure Eco (100% reciclado) disponible en color arena. Disponible versión completamente tapizada en cuero o versión de madera de roble.

Upholstery
Tapicería

The Sail collection supports following upholsteries of Andreu World Catalogue. For fabrics in our catalogue not specified in this box or customers own materials please contact our Customer Service Department.

La colección Sail admite las siguientes tapicerías del catálogo de Andreu World. Para las telas de nuestro catálogo no indicadas en este cuadro o telas cliente, consultar con nuestro Departamento Comercial.

Fabrics / Telas

- 1 Soft-fiber
- Jacquard One
- Jacquard Three
- Citadel
- Sand
- Era
- Gravity
- Rivet
- Urban
- Reel One (in/out)
- Spin One
- Spin Two
- Spin Three
- Spin Four
- Spin Five

- 3 Jacquard Four
- Medley
- Revive 1
- Natte
- Main Line Flax
- Loom Two (in/out)
- Mezzo
- Reel two (in/out)
- Jacquard Five

- 5 Silk
- Synergy
- Step
- Step Melange
- Blazer
- Melange Nap
- Chili
- Noma
- Re-wool

- 8 Capture
- Fiord 2
- Tonus 4
- Divina 3
- Lopi
- Domino
- Atrium

- 9 Divina MD
- Divina Melange 3
- Hallingdal 65
- Steelcut Trio 3
- Tack Four (in/out)

- 11 Arda
- Ecriture
- Zero

- 4 Jacquard 4 Special
- Nexus
- Field 2
- Remix 3
- Heritage
- Savane
- Loom Three
- Loom Four
- Cura
- Oceanic
- Reel Three (in/out)
- Reel Four (in/out)
- Reflect
- Spin Six

- 6 Go check
- Swing
- Chartres
- Zori
- Patio
- Tack Two (in/out)
- Tack Three (in/out)

- 7 Canvas 2
- Select
- Clara 2
- Tack Five (in/out)
- Hero 2

Faux Leather / Ecopiel

- 1 Valencia
- 2 Silvertex
- 3 Maglia
- 4 Dolce
- 8 Ultraleather

Leather / Piel

- L1 High grade cow leather. Piel de vaca de 1ª categoría.
- L3 Polished full grain leather. Plena flor pulida.
- L6 Aniline leather batique-effect. Scandinavian cattle. Piel anilina efecto batique. Ganado escandinavo.

Hide Leather / Cuero

- L2 Chrome tanned split leather. Base in polyurethane resin emulsion in water. Cellulose nitric varnish. Costra cocida al cromo. Base de emulsiones de resinas poliuretánicas en agua. Barniz nitro celulósico.

Eco Thermo-polymer finish
Acabado de Termo-polímero Eco

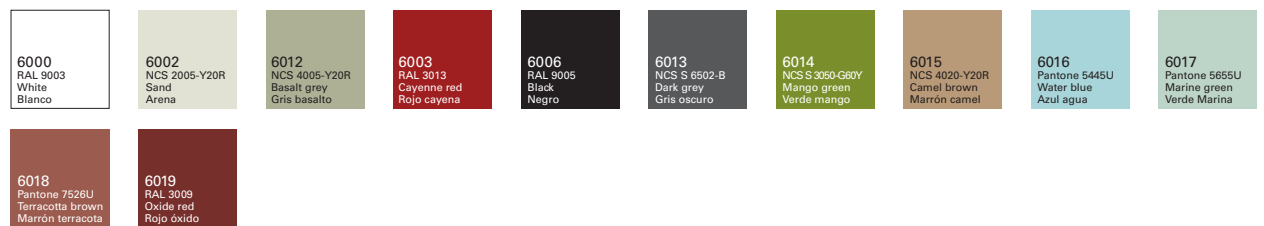

Pure Eco Thermo-polymer finish
Acabado de Termo-polímero Pure Eco



Wood finish Oak
Acabado madera Roble

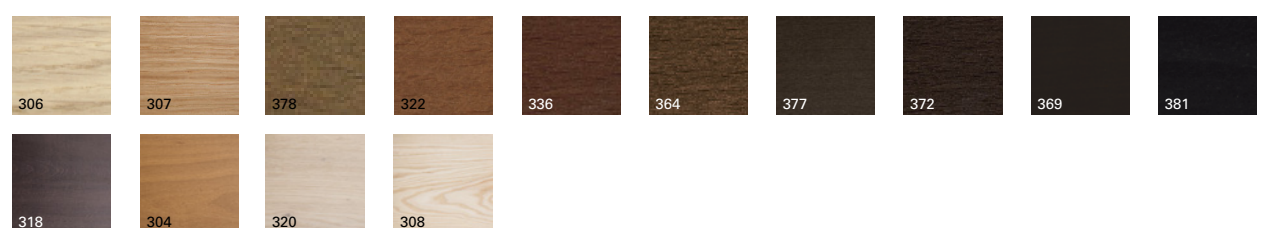

Premium finish and wood lacquers
Acabado premium y lacas madera



Leather finish
Acabado de cuero



Certificates
Certificados

Fireproof polyurethane foam
Espuma de poliuretano ignifuga

UNE EN 1021:2006
BS 5852 part 2 crib 5
UNI 9175 Classe 1 IM
BKZ 5.2
California TB 117:2013
California TB 133*

*Contact our Customer Department
*Consultar con nuestro Departamento Comercial

Quality - Resistance
Calidad - Resistencia

UNE EN 16139:2013

Intellectual property Propiedad intelectual

All our collections are protected by international industrial design registries, designs patents, copyrights and intellectual Property laws. Unauthorized use of AW International Property is a criminal offence and can lead to prosecution. Todas nuestras colecciones están protegidas por registros de diseño industrial, diseño de patente, copyright y derechos de propiedad intelectual en todo el mundo. El uso no autorizado de los diseños y propiedad intelectual de AW supone un delito que puede ser sometido a acción judicial.



SI1245

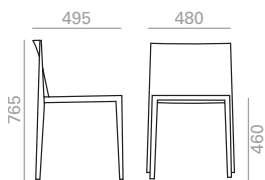

Chair with seat and back in Eco thermo-polymer available in different colors or Pure Eco thermo-polymer (100% recycled) available in sand color. Option for an upholstered seat. Minimum order per color: 6 units, except in the version with a upholstered seat pad (minimum does not apply).

Silla con asiento y respaldo de termopolímero Eco disponible en diferentes colores o termopolímero Pure Eco (100% reciclado) disponible en color arena. Opción de asiento plafonado. Pedido mínimo por color: 6 unidades, excepto en versión de asiento plafonado (no se aplica mínimo).

COM cm. per unit	COL m2
------------------	--------

Seat pad Asiento plafonado

1 units	60	1
10 units or more	30	

- 0,32 m3
- 26,04 kg
- x6
- 12
- 20



TP
108



Upholstered seat pad
Asiento plafonado

COM	COL	1	2	3	4	5	6	7	8	9	10	11	L1	L2	L3	L6
180	183	186	191	194	198	202	208	211	216	221	225	228	233	250	278	356



Linking device upcharge
Incremento por sistema de unión

36

SI1246

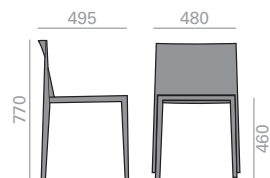

Chair fully upholstered in leather with thermo-polymer interior frame.

Silla completamente tapizada en cuero con estructura interior de termopolímero.

- 0,29 m3
- 14,4 kg
- x2

L2

€ 508

SI1248



Stackable chair with oak board seat and backrest and solid oak wood frame.

Silla apilable con asiento y respaldo de tablero de roble y estructura de madera maciza de roble.

- 0,24 m3
- 14,6 kg
- x2
- 8
- 12



€ 753

BQ1250

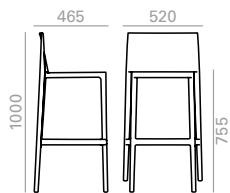

Barstool with seat and back in Eco thermo-polymer available in different colors or Pure Eco thermo-polymer (100% recycled) available in sand color. Option for an upholstered seat.

Banqueta alta con asiento y respaldo de termopolímero Eco disponible en diferentes colores o termopolímero Pure Eco (100% reciclado) disponible en color arena. Opción de asiento plafonado.

COM cm. per unit	COL m2
------------------	--------

0,35 m3
24,04 kg

Seat pad Asiento plafonado

1 units	60	1
10 units or more	30	

x4

10

15



TP

125



Upholstered seat pad
Asiento plafonado

COM	COL	1	2	3	4	5	6	7	8	9	10	11	L1	L2	L3	L6
204	207	210	215	223	231	240	248	256	265	273	282	290	298	330	385	534

BQ1251

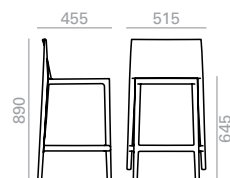

Counter stool with seat and back in Eco thermo-polymer available in different colors or Pure Eco thermo-polymer (100% recycled) available in sand color. Option for an upholstered seat.

Banqueta baja con asiento y respaldo de termopolímero Eco disponible en diferentes colores o termopolímero Pure Eco (100% reciclado) disponible en color arena. Opción de asiento plafonado.

COM cm. per unit	COL m2
------------------	--------

0,32 m3
23 kg

Seat pad Asiento plafonado

1 units	60	1
10 units or more	30	

x4

10

15

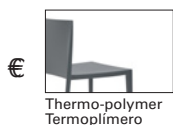

TP

125



Upholstered seat pad
Asiento plafonado

COM	COL	1	2	3	4	5	6	7	8	9	10	11	L1	L2	L3	L6
204	207	210	215	223	231	240	248	256	265	273	282	290	298	330	385	534

CA5004

Metallic trolley for transport stackable seating.
Carro metálico para transportar asientos apilables.

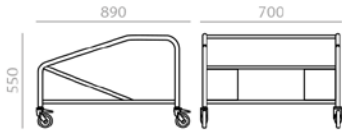
 0,39 m³ 14 kg x1

€ 216

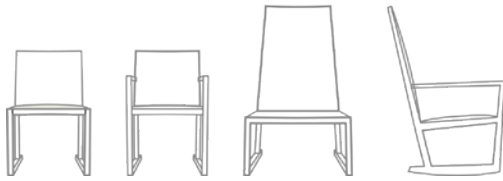

Description
Descripción

Chair and armchair with upholstered seat and back and solid oak frame. Lounge chair version with or without arms, available in 2 different back heights, with upholstered seat and back and solid oak frame.

Silla y sillón con asiento y respaldo tapizado y estructura de madera maciza de roble. Versión de butacas con o sin brazos disponible en 2 alturas diferentes de respaldo, con asiento y respaldo tapizado y estructura de madera maciza de roble.

Upholstery
Tapicería

The Serena collection supports all upholsteries of Andreu World Catalogue. For custom own materials, contact our Customer Department.

La colección Serena admite todas las telas del catálogo de Andreu World. Para telas cliente, consultar con nuestro Departamento Comercial.

Fabrics / Telas

- 1 Soft-fiber
Jacquard One
Jacquard Three
Citadel
Sand
Era
Gravity
Rivet
Urban
Reel One (in/out)
Spin One
Spin Two
Spin Three
Spin Four
Spin Five
- 2 Jacquard Two
Solid & Stripes
Loom One
Circular One Pure Eco
Tack One (in/out)

- 3 Jacquard Four
Medley
Revive 1
Natte
Main Line Flax
Loom Two (in/out)
Mezzo
Reel two (in/out)
Jacquard Five
- 4 Jacquard 4 Special
Nexus
Field 2
Remix 3
Heritage
Savane
Loom Three
Loom Four
Cura
Oceanic
Reel Three (in/out)
Reel Four (in/out)
Reflect
Spin Six

- 5 Silk
Synergy
Step
Step Melange
Blazer
Melange Nap
Chili
Noma
Re-wool
- 6 Go check
Swing
Chartres
Zori
Patio
Tack Two (in/out)
Tack Three (in/out)
- 7 Canvas 2
Select
Clara 2
Tack Five (in/out)
Hero 2

- 8 Capture
Fiord 2
Tonus 4
Divina 3
Lopi
Domino
Atrium
- 9 Divina MD
Divina Melange 3
Hallingdal 65
Steelcut Trio 3
Tack Four (in/out)
- 11 Arda
Ecriture
Zero

Faux Leather / Ecopiel

- 1 Valencia
- 2 Silvertex
- 3 Maglia
- 4 Dolce
- 8 Ultraleather
- 9 Brisa
Brisa Distressed
Fresco
Ultraleather Pro
Promessa
- 10 Tottori
Coast (in/out)
- 11 Reef Pro
Volar Bio

Leather / Piel

- L1 High grade cow leather.
Piel de vaca de 1ª categoría.
- L3 Polished full grain leather.
Plena flor pulida.
- L6 Aniline leather batique-effect.
Scandinavian cattle.
Piel anilina efecto batique.
Ganado escandinavo.

Wood finish Oak
Acabado madera
Roble



Premium finish and wood lacquers
Acabado premium y lacas madera



Certificates
Certificados

Fireproof polyurethane foam
Espuma de poliuretano ignífuga

UNE EN 1021:2006
BS 5852 part 2 crib 5
UNI 9175 Classe 1 IM
BKZ 5.2
California TB 117:2013
California TB 133*

*Contact our Customer Department
*Consultar con nuestro Departamento Comercial

Quality - Resistance
Calidad - Resistencia

UNE EN 16139:2013

Intellectual property Propiedad intelectual

All our collections are protected by international industrial design registries, designs patents, copyrights and intellectual Property laws. Unauthorized use of AW International Property is a criminal offence and can lead to prosecution.
Todas nuestras colecciones están protegidas por registros de diseño industrial, diseño de patente, copyright y derechos de propiedad intelectual en todo el mundo. El uso no autorizado de los diseños y propiedad intelectual de AW supone un delito que puede ser sometido a acción judicial.



SI1344

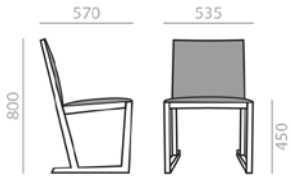

Chair with upholstered seat and back and solid oak wood frame.

Silla con asiento y respaldo tapizado y estructura de madera maciza de roble.

	COM cm. per unit	COL m2
1 units	115	3
10 units or more	105	

0,41 m3
 20 kg
 x2

€	COM	COL	1	2	3	4	5	6	7	8	9	10	11	L1	L2	L3	L6
	475	487	495	507	518	532	544	559	572	588	601	614	629	640	692	782	1.026

SERIE 600 | Matte lacquered and premium upcharge | Incremento por lacado mate y premium | 44 |

SO1346

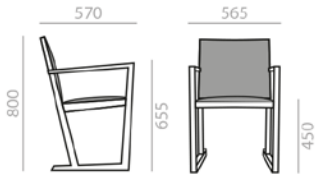

Armchair with upholstered seat and back and solid oak wood frame.

Sillón con asiento y respaldo tapizado y estructura de madera maciza de roble.

	COM cm. per unit	COL m2
1 units	115	3
10 units or more	105	

0,31 m3
 10,3 kg
 x1

€	COM	COL	1	2	3	4	5	6	7	8	9	10	11	L1	L2	L3	L6
	583	595	604	616	627	639	655	668	682	698	709	724	739	751	802	894	1.139

SERIE 600 | Matte lacquered and premium upcharge | Incremento por lacado mate y premium | 51 |

BU1352

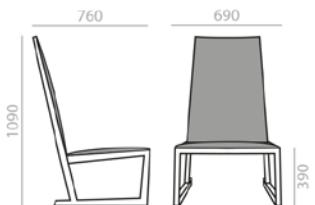

High back lounge chair with upholstered seat and back and solid oak wood frame.

Butaca de respaldo alto con asiento y respaldo tapizado y estructura de madera maciza de roble.

	COM cm. per unit	COL m2
1 units	170	4,5
10 units or more	170	

0,6 m3
 12,9 kg
 x1

€	COM	COL	1	2	3	4	5	6	7	8	9	10	11	L1	L2	L3	L6
	737	755	770	788	805	829	852	876	900	922	945	968	992	1.012	1.096	1.251	1.652

SERIE 600 | Matte lacquered and premium upcharge | Incremento por lacado mate y premium | 44 |

BU1354

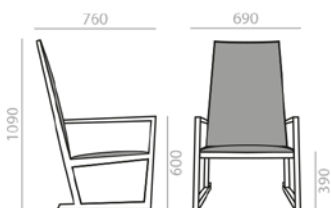

High back lounge chair with arms, upholstered seat and back and solid oak wood frame.

Butaca de respaldo alto con brazos, asiento y respaldo tapizado y estructura de madera maciza de roble.

	COM cm. per unit	COL m2
1 units	170	4,5
10 units or more	170	

0,66 m3
 13,3 kg
 x1

€	COM	COL	1	2	3	4	5	6	7	8	9	10	11	L1	L2	L3	L6
	825	842	860	880	897	920	942	967	990	1.012	1.037	1.062	1.083	1.105	1.191	1.343	1.753

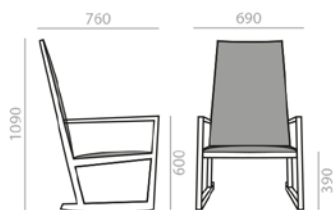

SERIE 600 | Matte lacquered and premium upcharge | Incremento por lacado mate y premium | 51 |

BU1356



 Rocker high back lounge chair with arms, upholstered seat and back and solid oak wood frame.
Butaca de respaldo alto con brazos, asiento y respaldo tapizado y estructura de balancín de madera maciza de roble.

	COM cm. per unit	COL m2
1 units	170	4,5
10 units or more	170	

 0,67 m3
 14,5 kg
 x1

€	COM	COL	1	2	3	4	5	6	7	8	9	10	11	L1	L2	L3	L6
	861	879	895	915	932	956	980	1.004	1.027	1.051	1.074	1.099	1.122	1.144	1.230	1.385	1.800

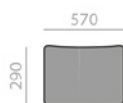

SERIE 600	Matte lacquered and premium upcharge Incremento por lacado mate y premium	51
-----------	--	----

CJ1357



Loose cushion
Cojín auxiliar

	COM cm. per unit	COL m2
1 units	45	1
10 units or more	45	

 0,01 m3
 2 kg
 x1

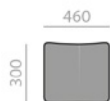

€	COM	COL	1	2	3	4	5	6	7	8	9	10	11	L1	L2	L3	L6
	81	85	88	92	96	102	107	111	117	122	128	132	137	142	161	195	285

CJ1358



Loose cushion.
Cojín auxiliar.

	COM cm. per unit	COL m2
1 units	45	1
10 units or more	45	

 0,02 m3
 0,34 kg
 x1

€	COM	COL	1	2	3	4	5	6	7	8	9	10	11	L1	L2	L3	L6
	65	69	72	76	80	86	91	95	101	106	111	115	121	125	144	177	266

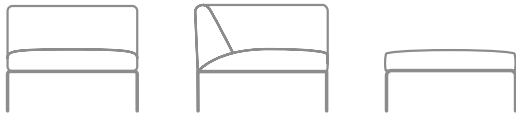

Description
Descripción

Highly modular sectional sofa that allows for numerous combinations. It is constructed with steel frame available in different colors and dismountable upholstered parts, available in all our fabrics for indoor use.

Sofá componible de gran modularidad, que permite diferentes composiciones. Estructura de acero disponible en diferentes colores y partes tapizadas desmontables, disponibles en todos nuestros tejidos para uso interior.

Upholstery
Tapicería

The Siesta indoor collection supports all upholsteries of Andreu World Catalogue. For custom own materials, contact our Customer Department.

La colección Siesta indoor admite todas las telas del catálogo de Andreu World. Para telas cliente, consultar con nuestro Departamento Comercial.

Fabrics / Telas

- 1** Soft-fiber
Jacquard One
Jacquard Three
Citadel
Sand
Era
Gravity
Rivet
Urban
Reel One (in/out)
Spin One
Spin Two
Spin Three
Spin Four
Spin Five
- 2** Jacquard Two
Solid & Stripes
Loom One
Circular One Pure Eco
Tack One (in/out)

- 3** Jacquard Four
Medley
Revive 1
Natte
Main Line Flax
Loom Two (in/out)
Mezzo
Reel two (in/out)
Jacquard Five
- 4** Jacquard 4 Special
Nexus
Field 2
Remix 3
Heritage
Savane
Loom Three
Loom Four
Cura
Oceanic
Reel Three (in/out)
Reel Four (in/out)
Reflect
Spin Six

- 5** Silk
Synergy
Step
Step Melange
Blazer
Melange Nap
Chili
Noma
Re-wool
- 6** Go check
Swing
Chartres
Zori
Patio
Tack Two (in/out)
Tack Three (in/out)
- 7** Canvas 2
Select
Clara 2
Tack Five (in/out)
Hero 2

- 8** Capture
Fiord 2
Tonus 4
Divina 3
Lopi
Domino
Atrium
- 9** Divina MD
Divina Melange 3
Hallingdal 65
Steelcut Trio 3
Tack Four (in/out)
- 11** Arda
Ecriture
Zero

Faux Leather / Ecopiel

- 1** Valencia
- 2** Silvertex
- 3** Maglia
- 4** Dolce
- 8** Ultraleather
- 9** Brisa
Brisa Distressed
Fresco
Ultraleather Pro
Promessa
- 10** Tottori
Coast (in/out)
- 11** Reef Pro
Volar Bio

Leather / Piel

- L1** High grade cow leather.
Piel de vaca de 1ª categoría.
- L3** Polished full grain leather.
Piena flor pulida.
- L6** Aniline leather batique-effect.
Scandinavian cattle.
Piel anilina efecto batique.
Ganado escandinavo.

Steel finish

Acabado de acero

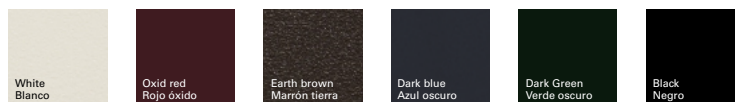

Certificates
Certificados

Fireproof polyurethane foam

Espuma de poliuretano ignífuga

UNE EN 1021:2006
BS 5852 part 2 crib 5
UNI 9175 Classe 1 IM
BKZ 5.2
California TB 117:2013
California TB 133*

*Contact our Customer Department
*Consultar con nuestro Departamento Comercial

Quality - Resistance
Calidad - Resistencia

UNE EN 16139:2013

Intellectual property Propiedad intelectual

All our collections are protected by international industrial design registries, designs patents, copyrights and intellectual Property laws. Unauthorized use of AW International Property is a criminal offence and can lead to prosecution.

Todas nuestras colecciones están protegidas por registros de diseño industrial, diseño de patente, copyright y derechos de propiedad intelectual en todo el mundo. El uso no autorizado de los diseños y propiedad intelectual de AW supone un delito que puede ser sometido a acción judicial.



SF3005

1-seater sofa with upholstered seat and backrest and steel sled base available in different finishes.

Sofá de una plaza con asiento y respaldo tapizado y base de patín de varilla de acero disponible en diferentes acabados.

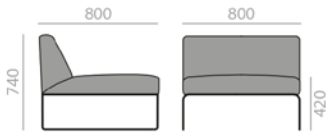

	COM cm. per unit	COL m2
1 units	380	10
10 units or more	380	

0,6 m3
28 kg
x1

€	COM	COL	1	2	3	4	5	6	7	8	9	10	11	L1	L2	L3	L6
	1.144	1.181	1.227	1.265	1.294	1.343	1.397	1.449	1.500	1.553	1.603	1.655	1.708	1.753	1.940	2.291	3.220

SF3006

1-seater corner sofa (right side) with upholstered seat and backrest and steel sled base available in different finishes.

Sofá rinconero de una plaza (lado derecho) con asiento y respaldo tapizado y base de patín de varilla de acero disponible en diferentes acabados.

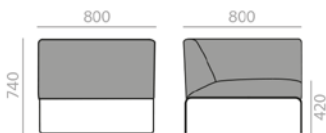

	COM cm. per unit	COL m2
1 units	530	15
10 units or more	530	

0,6 m3
32,5 kg
x1

€	COM	COL	1	2	3	4	5	6	7	8	9	10	11	L1	L2	L3	L6
	1.652	1.710	1.779	1.835	1.879	1.955	2.030	2.106	2.180	2.256	2.331	2.407	2.481	2.549	2.821	3.317	4.647

SF3007

1-seater corner sofa (left side) with upholstered seat and backrest and steel sled base available in different finishes.

Sofá rinconero de una plaza (lado izquierdo) con asiento y respaldo tapizado y base de patín de varilla de acero disponible en diferentes acabados.

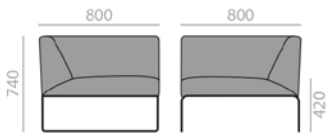

	COM cm. per unit	COL m2
1 units	530	15
10 units or more	530	

0,6 m3
32,5 kg
x1

€	COM	COL	1	2	3	4	5	6	7	8	9	10	11	L1	L2	L3	L6
	1.652	1.710	1.779	1.835	1.879	1.955	2.030	2.106	2.182	2.256	2.332	2.408	2.483	2.550	2.823	3.320	4.647

RS3009

Upholstered ottoman with steel sled base available in different finishes.

Reposapiés tapizado con base de patín de varilla de acero disponible en diferentes acabados.

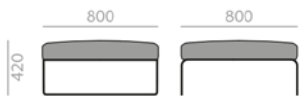

	COM cm. per unit	COL m2
1 units	200	5
10 units or more	200	

0,34 m3
22,8 kg
x1

€	COM	COL	1	2	3	4	5	6	7	8	9	10	11	L1	L2	L3	L6
	751	771	795	815	830	857	884	910	937	964	991	1.017	1.044	1.067	1.164	1.338	1.801

CJ3010

Loose cushion
Cojín auxiliar

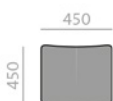

	COM cm. per unit	COL m2
1 units	65	1,5
10 units or more	650	

0,02 m3
2 kg
x1

€	COM	COL	1	2	3	4	5	6	7	8	9	10	11	L1	L2	L3	L6
	77	82	89	95	99	107	115	124	132	140	150	159	169	177	211	273	435

CJ3011

Loose cushion
Cojín auxiliar

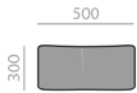

	COM cm. per unit	COL m2
1 units	45	1
10 units or more	450	

0,02 m3
2 kg
x1

	COM	COL	1	2	3	4	5	6	7	8	9	10	11	L1	L2	L3	L6
€	84	89	93	98	102	108	114	119	125	131	137	143	151	154	183	216	372

Examples of modular configurations Ejemplos de combinaciones modulares

Set 1 / Conjunto 1

3 Modules 3 Módulos
RS3009 + SF3005 + SF3005

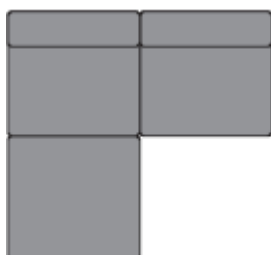

	COM cm. per unit	COL m2
1 units	960	25
10 units or more	960	

	COM	COL	1	2	3	4	5	6	7	8	9	10	11	L1	L2	L3	L6
€	3.039	3.133	3.249	3.345	3.418	3.543	3.678	3.808	3.937	4.070	4.197	4.327	4.460	4.573	5.044	5.920	8.241

Set 2 / Conjunto 2

5 Modules 5 Módulos
SF3005 + SF3005 + SF3006 + SF3005 + SF3005

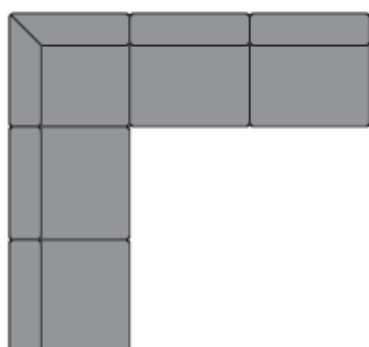

	COM cm. per unit	COL m2
1 units	2050	55
10 units or more	2050	

	COM	COL	1	2	3	4	5	6	7	8	9	10	11	L1	L2	L3	L6
€	6.228	6.434	6.687	6.895	7.055	7.327	7.618	7.902	8.180	8.468	8.743	9.027	9.313	9.561	10.581	12.481	17.527

Set 3 / Conjunto 3

6 Modules 6 Módulos
SF3006 + SF3005 + SF3005 + SF3007 + SF3005 +
RS3009

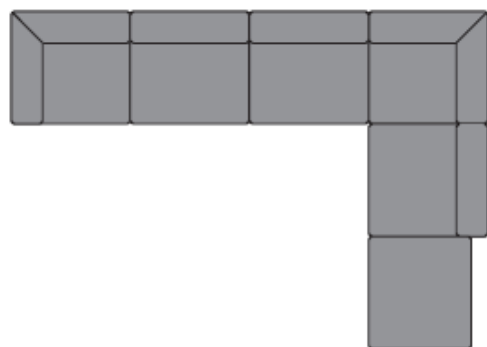

	COM cm. per unit	COL m2
1 units	2400	65
10 units or more	2400	

	COM	COL	1	2	3	4	5	6	7	8	9	10	11	L1	L2	L3	L6
€	7.487	7.734	8.034	8.280	8.470	8.796	9.135	9.469	9.799	10.135	10.463	10.797	11.132	11.425	12.628	14.848	20.755

Examples of modular configurations Ejemplos de combinaciones modulares

Set 4 / Conjunto 4

7 Modules 7 Módulos

SF3005 + SF3005 + SF3007 + SF3005 + SF3005 +
SF3005 + RS3009



	COM cm. per unit	COL m2
1 units	2630	70
10 units or more	2630	

€	COM	COL	1	2	3	4	5	6	7	8	9	10	11	L1	L2	L3	L6
	8.123	8.386	8.709	8.975	9.179	9.527	9.899	10.261	10.619	10.985	11.338	11.700	12.067	12.382	13.687	16.113	22.548

Set 5 / Conjunto 5

4 Modules 4 Módulos

SF3007 + SF3005 + SF3005 + SF3006



	COM cm. per unit	COL m2
1 units	1820	50
10 units or more	1820	

€	COM	COL	1	2	3	4	5	6	7	8	9	10	11	L1	L2	L3	L6
	5.592	5.782	6.012	6.200	6.346	6.596	6.854	7.110	7.362	7.618	7.869	8.125	8.380	8.605	9.524	11.219	15.734

Set 6 / Conjunto 6

5 Modules 5 Módulos

SF3007 + SF3005 + SF3005 + SF3005 + SF3006



	COM cm. per unit	COL m2
1 units	2200	60
10 units or more	2200	

€	COM	COL	1	2	3	4	5	6	7	8	9	10	11	L1	L2	L3	L6
	6.736	6.963	7.239	7.465	7.640	7.939	8.251	8.559	8.862	9.171	9.472	9.780	10.088	10.358	11.464	13.510	18.954

**Examples of modular configurations
Ejemplos de combinaciones modulares**

Set 7 / Conjunto 7

6 Modules 6 Módulos

SF3007 + SF3005 + SF3007 + SF3005 + SF3005 + SF3006

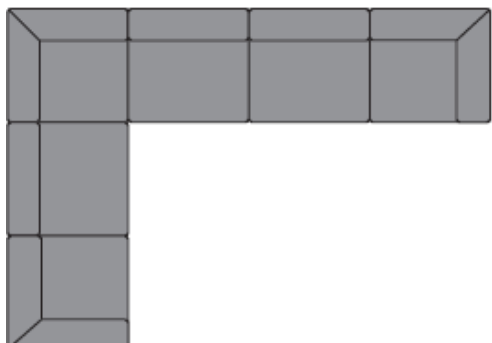

	COM cm. per unit	COL m2
1 units	2730	75
10 units or more	2730	

	COM	COL	1	2	3	4	5	6	7	8	9	10	11	L1	L2	L3	L6
€	8.388	8.673	9.018	9.300	9.519	9.894	10.281	10.665	11.044	11.427	11.804	12.188	12.571	12.908	14.287	16.830	23.601

Set 8 / Conjunto 8

9 Modules 9 Módulos

SF3005 + SF3005 + SF3007 + SF3005 + SF3005 + SF3005 + SF3006 + SF3005 + SF3005

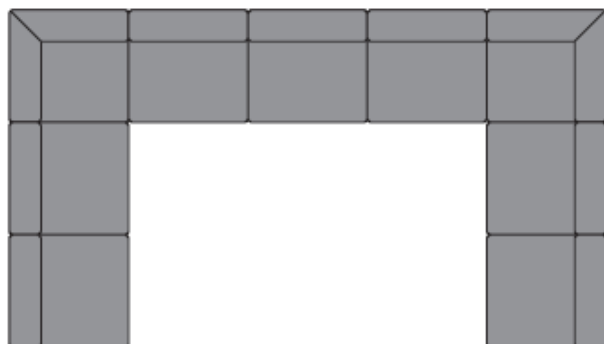

	COM cm. per unit	COL m2
1 units	3720	100
10 units or more	3720	

	COM	COL	1	2	3	4	5	6	7	8	9	10	11	L1	L2	L3	L6
€	11.312	11.687	12.147	12.525	12.816	13.311	13.839	14.355	14.862	15.383	15.884	16.400	16.920	17.370	19.224	22.674	31.834

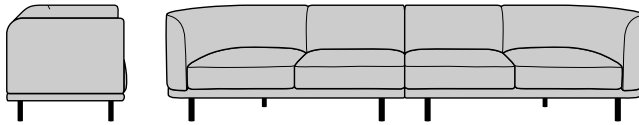

Description
Descripción

Lounge chair and 2 and 3-seater sofas with upholstered seat and backrest and 4-legged steel base in white or black finish. Modular system of 2, 3 seats and/or chaise lounge that allow the piece to adapt to any space offering great versatility. Available in several shapes: straight or segment end and curved to 30, 60 and 90 degrees. For combinations not indicated in our Price List, please consult our Sales Department.

Butaca y sofás de 2 y 3 plazas con asiento y respaldo tapizado y base de 4 patas de acero en acabado blanco o negro. Disponible sistema modular de 2, 3 plazas y chaise lounge que permiten adaptarse a cualquier espacio por su gran versatilidad. Disponible en diferentes formas: rectos o final de segmento y curvos de 30, 60 y 90 grados. Para combinaciones no indicadas en nuestra Lista de Precios, consultar con nuestro Departamento Comercial.

Upholstery
Tapicería

The Sir collection supports following upholsteries of Andreu World Catalogue. For fabrics in our catalogue not specified in this box or customers own materials please contact our Customer Service Department.

La colección Sir admite las siguientes tapicerías del catálogo de Andreu World. Para las telas de nuestro catálogo no indicadas en este cuadro o telas cliente, consultar con nuestro Departamento Comercial.

Fabrics / Telas

- 1** Soft-fiber
Jacquard One
Jacquard Three
Citadel
Sand
Era
Gravity
Rivet
Urban
Reel One (in/out)
Spin One
Spin Two
Spin Three
Spin Four
Spin Five
- 2** Jacquard Two
Solid & Stripes
Loom One
Circular One Pure Eco
Tack One (in/out)

- 3** Jacquard Four
Medley
Revive 1
Natte
Main Line Flax
Loom Two (in/out)
Mezzo
Reel two (in/out)
Jacquard Five
- 4** Jacquard 4 Special
Nexus
Field 2
Remix 3
Heritage
Savane
Loom Three
Loom Four
Cura
Oceanic
Reel Three (in/out)
Reel Four (in/out)
Reflect
Spin Six

- 5** Silk
Synergy
Step
Step Melange
Blazer
Melange Nap
Chili
Noma
Re-wool
- 6** Go check
Swing
Chartres
Zori
Patio
Tack Two (in/out)
Tack Three (in/out)
- 7** Canvas 2
Select
Clara 2
Tack Five (in/out)
Hero 2

- 8** Capture
Fiord 2
Tonus 4
Divina 3
Lopi
Domino
Atrium
- 9** Divina MD
Divina Melange 3
Hallingdal 65
Steelcut Trio 3
Tack Four (in/out)
- 11** Arda
Ecriture
Zero

Faux Leather / Ecopiel

- 1** Valencia
- 2** Silvertex
- 3** Maglia
- 4** Dolce
- 8** Ultraleather
- 9** Brisa
Brisa Distressed
Fresco
Ultraleather Pro
Promessa
- 10** Tottori
Coast (in/out)
- 11** Reef Pro
Volar Bio

Leather / Piel

- L1** High grade cow leather.
Piel de vaca de 1ª categoría.
- L3** Polished full grain leather.
Piel de vaca pulida.
- L6** Aniline leather batique-effect.
Scandinavian cattle.
Piel anilina efecto batique.
Ganado escandinavo.

Steel finish
Acabado de acero



Certificates
Certificados

Fireproof polyurethane foam
Espuma de poliuretano ignifuga

UNE EN 1021:2006
BS 5852 part 2 crib 5
UNI 9175 Classe 1 IM
BKZ 5.2
California TB 117:2013
California TB 133*

*Contact our Customer Department
*Consultar con nuestro Departamento Comercial

Quality - Resistance
Calidad - Resistencia

UNE EN 16139:2013

Intellectual property Propiedad intelectual

All our collections are protected by international industrial design registries, designs patents, copyrights and intellectual Property laws. Unauthorized use of AW International Property is a criminal offence and can lead to prosecution.

Todas nuestras colecciones están protegidas por registros de diseño industrial, diseño de patente, copyright y derechos de propiedad intelectual en todo el mundo. El uso no autorizado de los diseños y propiedad intelectual de AW supone un delito que puede ser sometido a acción judicial.



BU2310

Lounge chair with upholstered seat and backrest and 4-legged steel base in white or black finish.

Butaca con asiento y respaldo tapizado y base de 4 patas de acero en acabado blanco o negro.

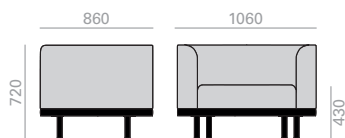

	COM cm. per unit	COL m2
1 units	480	9,75
10 units or more	480	

0,76 m3
 37 kg
 x1

€	COM	COL	1	2	3	4	5	6	7	8	9	10	11	L1	L2	L3	L6
	1.557	1.612	1.679	1.733	1.776	1.849	1.922	1.996	2.069	2.142	2.215	2.288	2.361	2.425	2.690	3.170	4.443

SF2311

2-seater sofa with upholstered seat and backrest and 4-legged steel base in white or black finish.

Sofá de 2 plazas con asiento y respaldo tapizado y base de 4 patas de acero en acabado blanco o negro.

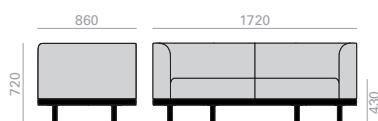

	COM cm. per unit	COL m2
1 units	750	15
10 units or more	750	

1,21 m3
 46 kg
 x1

€	COM	COL	1	2	3	4	5	6	7	8	9	10	11	L1	L2	L3	L6
	2.455	2.547	2.661	2.753	2.824	2.948	3.071	3.195	3.318	3.442	3.565	3.689	3.811	3.921	4.368	5.179	7.329

SF2312

3-seater sofa with upholstered seat and backrest and 4-legged steel base in white or black finish.

Sofá de 3 plazas con asiento y respaldo tapizado y base de 4 patas de acero en acabado blanco o negro.

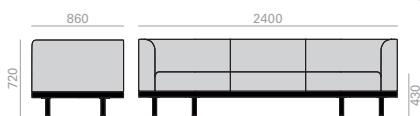

	COM cm. per unit	COL m2
1 units	1110	22
10 units or more	1110	

1,67 m3
 64 kg
 x1

€	COM	COL	1	2	3	4	5	6	7	8	9	10	11	L1	L2	L3	L6
	3.094	3.229	3.397	3.531	3.637	3.818	3.998	4.179	4.360	4.542	4.723	4.903	5.084	5.245	5.898	7.090	10.242

SF2313

2-seater modular sofa with upholstered seat and backrest and 4-legged steel base in white or black finish.

Sofá modular de 2 plazas con asiento y respaldo tapizado y base de 4 patas de acero en acabado blanco o negro.

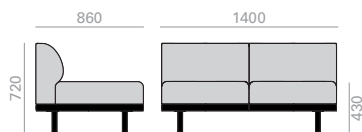

	COM cm. per unit	COL m2
1 units	630	12,5
10 units or more	630	

0,99 m3
 40 kg
 x1

€	COM	COL	1	2	3	4	5	6	7	8	9	10	11	L1	L2	L3	L6
	1.911	1.989	2.085	2.161	2.223	2.326	2.429	2.534	2.637	2.740	2.844	2.948	3.052	3.144	3.518	4.200	6.005

SF2314

3-seater modular sofa with upholstered seat and backrest and 4-legged steel base in white or black finish.

Sofá modular de 3 plazas con asiento y respaldo tapizado y base de 4 patas de acero en acabado blanco o negro.

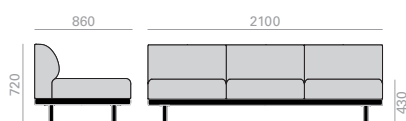

	COM cm. per unit	COL m2
1 units	980	19,5
10 units or more	980	

1,47 m3
 59 kg
 x1

€	COM	COL	1	2	3	4	5	6	7	8	9	10	11	L1	L2	L3	L6
	2.571	2.692	2.840	2.960	3.055	3.216	3.376	3.537	3.698	3.860	4.021	4.182	4.344	4.487	5.069	6.131	8.939

SF2315

Modular chaise lounge sofa (left side) with upholstered seat and backrest and 4-legged steel base in white or black finish.

Sofá modular chaise lounge (lado izquierdo) con asiento y respaldo tapizado y base de 4 patas de acero en acabado blanco o negro.

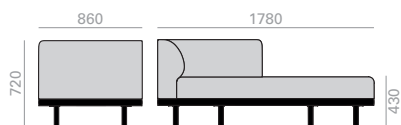

	COM cm. per unit	COL m2
1 units	750	15
10 units or more	750	

1,25 m3
 37 kg
 x1

€	COM	COL	1	2	3	4	5	6	7	8	9	10	11	L1	L2	L3	L6
€	1.934	2.027	2.142	2.232	2.305	2.427	2.552	2.674	2.798	2.921	3.045	3.168	3.292	3.402	3.847	4.660	6.808

SF2316

Modular chaise lounge sofa (right side) with upholstered seat and backrest and 4-legged steel base in white or black finish.

Sofá modular chaise lounge (lado derecho) con asiento y respaldo tapizado y base de 4 patas de acero en acabado blanco o negro.

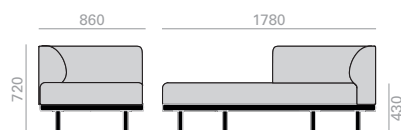

	COM cm. per unit	COL m2
1 units	750	15
10 units or more	750	

1,25 m3
 37 kg
 x1

€	COM	COL	1	2	3	4	5	6	7	8	9	10	11	L1	L2	L3	L6
€	1.934	2.027	2.142	2.232	2.305	2.427	2.552	2.674	2.798	2.921	3.045	3.168	3.292	3.402	3.847	4.660	6.808

SF2317

2-seater modular corner sofa (left side) with upholstered seat and backrest and 4-legged steel base in white or black finish.

Sofá modular rinconero (lado izquierdo) de 2 plazas con asiento y respaldo tapizado y base de 4 patas de acero en acabado blanco o negro.

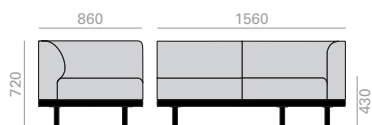

	COM cm. per unit	COL m2
1 units	620	12,5
10 units or more	620	

1,1 m3
 47,5 kg
 x1

€	COM	COL	1	2	3	4	5	6	7	8	9	10	11	L1	L2	L3	L6
€	2.137	2.215	2.308	2.384	2.444	2.545	2.648	2.750	2.852	2.953	3.056	3.158	3.260	3.350	3.719	4.390	6.166

SF2318

2-seater modular corner sofa (right side) with upholstered seat and backrest and 4-legged steel base in white or black finish.

Sofá modular rinconero (lado derecho) de 2 plazas con asiento y respaldo tapizado y base de 4 patas de acero en acabado blanco o negro.

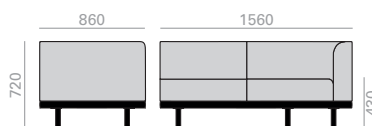

	COM cm. per unit	COL m2
1 units	620	12,5
10 units or more	620	

1,1 m3
 47,5 kg
 x1

€	COM	COL	1	2	3	4	5	6	7	8	9	10	11	L1	L2	L3	L6
€	2.137	2.215	2.308	2.384	2.444	2.545	2.648	2.750	2.852	2.953	3.056	3.158	3.260	3.350	3.719	4.390	6.166

SF2319

2-seater modular corner sofa (left side) with upholstered seat and open back and 4-legged steel base in white or black finish.

Sofá modular rinconero (lado izquierdo) de 2 plazas con asiento y respaldo abierto tapizado y base de 4 patas de acero en acabado blanco o negro.

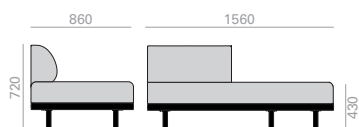

	COM cm. per unit	COL m2
1 units	620	12,5
10 units or more	620	

1,1 m3
 36 kg
 x1

€	COM	COL	1	2	3	4	5	6	7	8	9	10	11	L1	L2	L3	L6
€	1.742	1.819	1.913	1.989	2.048	2.150	2.253	2.355	2.456	2.558	2.661	2.763	2.865	2.955	3.324	3.995	5.771

SF2320

2-seater modular corner sofa (right side) with upholstered seat and open back and 4-legged steel base in white or black finish.

Sofá modular rinconero (lado derecho) de 2 plazas con asiento y respaldo abierto tapizado y base de 4 patas de acero en acabado blanco o negro.

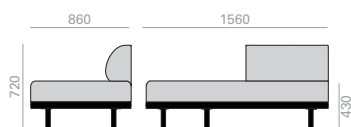

	COM cm. per unit	COL m2
1 units	620	12,5
10 units or more	620	

1,1 m3
 36 kg
 x1

€	COM	COL	1	2	3	4	5	6	7	8	9	10	11	L1	L2	L3	L6
	1.742	1.819	1.913	1.989	2.048	2.150	2.253	2.355	2.456	2.558	2.661	2.763	2.865	2.955	3.324	3.995	5.771

SF2321

90° curved modular sofa with upholstered seat and open back and 4-legged steel base in white or black finish.

Sofá modular curvo 90° con asiento y respaldo abierto tapizado y base de 4 patas de acero en acabado blanco o negro.

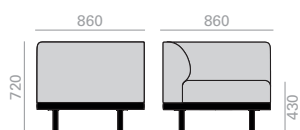

	COM cm. per unit	COL m2
1 units	390	7,75
10 units or more	390	

0,62 m3
 32,5 kg
 x1

€	COM	COL	1	2	3	4	5	6	7	8	9	10	11	L1	L2	L3	L6
	1.842	1.890	1.950	1.997	2.035	2.098	2.163	2.227	2.292	2.356	2.419	2.484	2.548	2.605	2.837	3.260	4.377

SF2322

60° curved modular sofa with upholstered seat and open back and 4-legged steel base in white or black finish.

Sofá modular curvo 60° con asiento y respaldo abierto tapizado y base de 4 patas de acero en acabado blanco o negro.

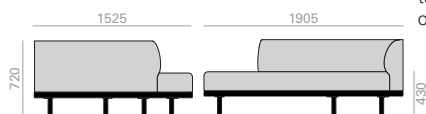

	COM cm. per unit	COL m2
1 units	980	19,5
10 units or more	980	

2,31 m3
 57 kg
 x1

€	COM	COL	1	2	3	4	5	6	7	8	9	10	11	L1	L2	L3	L6
	2.721	2.842	2.992	3.111	3.205	3.366	3.527	3.689	3.850	4.011	4.173	4.334	4.495	4.639	5.221	6.282	9.090

SF2323

30° curved modular sofa with upholstered seat and open back and 4-legged steel base in white or black finish.

Sofá modular curvo 30° con asiento y respaldo abierto tapizado y base de 4 patas de acero en acabado blanco o negro.

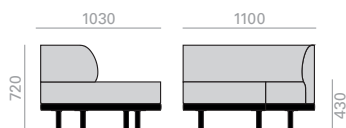

	COM cm. per unit	COL m2
1 units	490	9,75
10 units or more	490	

0,93 m3
 30 kg
 x1

€	COM	COL	1	2	3	4	5	6	7	8	9	10	11	L1	L2	L3	L6
	1.597	1.658	1.732	1.792	1.839	1.919	2.000	2.081	2.161	2.242	2.323	2.403	2.484	2.555	2.847	3.377	4.781

Set 1 / Conjunto 1

2 Modules 2 Módulos
SF2313 + SF2313

Examples of modular configurations Ejemplos de combinaciones modulares

	COM cm. per unit	COL m2
1 units	1260	25
10 units or more	1260	

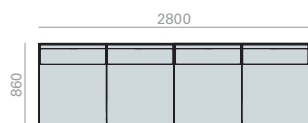

	COM	COL	1	2	3	4	5	6	7	8	9	10	11	L1	L2	L3	L6
€	3.822	3.978	4.170	4.322	4.446	4.652	4.858	5.068	5.274	5.480	5.688	5.896	6.104	6.288	7.036	8.400	12.010

Set 2 / Conjunto 2

2 Modules 2 Módulos
SF2314 + SF2314

	COM cm. per unit	COL m2
1 units	1960	39
10 units or more	1960	

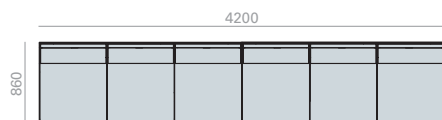

	COM	COL	1	2	3	4	5	6	7	8	9	10	11	L1	L2	L3	L6
€	5.142	5.384	5.680	5.920	6.110	6.432	6.752	7.074	7.396	7.720	8.042	8.364	8.688	8.974	10.138	12.262	17.878

Set 3 / Conjunto 3

2 Modules 2 Módulos
SF2318 + SF2317

	COM cm. per unit	COL m2
1 units	1240	25
10 units or more	1240	

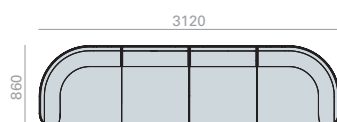

	COM	COL	1	2	3	4	5	6	7	8	9	10	11	L1	L2	L3	L6
€	4.274	4.430	4.616	4.768	4.888	5.090	5.296	5.500	5.704	5.906	6.112	6.316	6.520	6.700	7.438	8.780	12.332

Set 4 / Conjunto 4

3 Modules 3 Módulos
SF2316 + SF2313 + SF2315

	COM cm. per unit	COL m2
1 units	2130	42,5
10 units or more	2130	

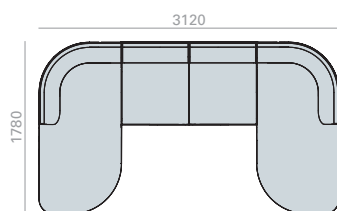

	COM	COL	1	2	3	4	5	6	7	8	9	10	11	L1	L2	L3	L6
€	5.779	6.043	6.369	6.625	6.833	7.180	7.533	7.882	8.233	8.582	8.934	9.284	9.636	9.948	11.212	13.520	19.621

Set 5 / Conjunto 5

3 Modules 3 Módulos
SF2316 + SF2314 + SF2315

Examples of modular configurations Ejemplos de combinaciones modulares

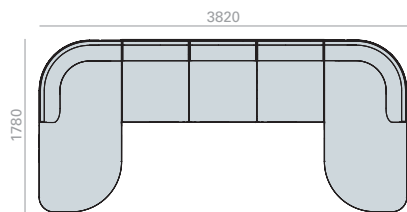

	COM cm. per unit	COL m2
1 units	2480	49,5
10 units or more	2480	

€	COM	COL	1	2	3	4	5	6	7	8	9	10	11	L1	L2	L3	L6
	6.439	6.746	7.124	7.424	7.665	8.070	8.480	8.885	9.294	9.702	10.111	10.518	10.928	11.291	12.763	15.451	22.555

Set 6 / Conjunto 6

3 Modules 3 Módulos
SF2320 + SF2313 + SF2319

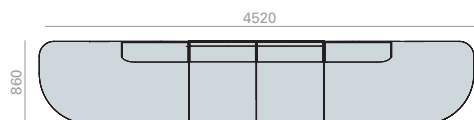

	COM cm. per unit	COL m2
1 units	1870	37,5
10 units or more	1870	

€	COM	COL	1	2	3	4	5	6	7	8	9	10	11	L1	L2	L3	L6
	5.395	5.627	5.911	6.139	6.319	6.626	6.935	7.244	7.549	7.856	8.166	8.474	8.782	9.054	10.166	12.190	17.547

Set 7 / Conjunto 7

3 Modules 3 Módulos
SF2320 + SF2314 + SF2319

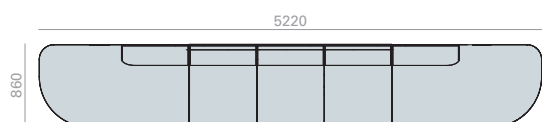

	COM cm. per unit	COL m2
1 units	2220	44,5
10 units or more	2220	

€	COM	COL	1	2	3	4	5	6	7	8	9	10	11	L1	L2	L3	L6
	6.055	6.330	6.666	6.938	7.151	7.516	7.882	8.247	8.610	8.976	9.343	9.708	10.074	10.397	11.717	14.121	20.481

Set 8 / Conjunto 8

3 Modules 3 Módulos
SF2318 + SF2321 + SF2319

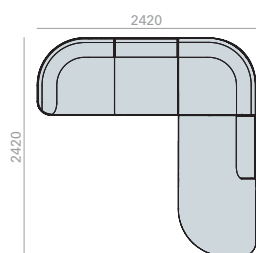

	COM cm. per unit	COL m2
1 units	1630	32,75
10 units or more	1630	

€	COM	COL	1	2	3	4	5	6	7	8	9	10	11	L1	L2	L3	L6
	5.721	5.924	6.171	6.370	6.527	6.793	7.064	7.332	7.600	7.867	8.136	8.405	8.673	8.910	9.880	11.645	16.314

Set 9 / Conjunto 9

3 Modules 3 Módulos
SF2320 + SF2321 + SF2317

Examples of modular configurations Ejemplos de combinaciones modulares

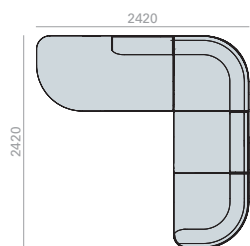

	COM cm. per unit	COL m2
1 units	1630	32,75
10 units or more	1630	

€	COM	COL	1	2	3	4	5	6	7	8	9	10	11	L1	L2	L3	L6
	5.721	5.924	6.171	6.370	6.527	6.793	7.064	7.332	7.600	7.867	8.136	8.405	8.673	8.910	9.880	11.645	16.314

Set 10 / Conjunto 10

3 Modules 3 Módulos
SF2318 + SF2321 + SF2317

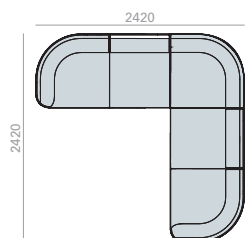

	COM cm. per unit	COL m2
1 units	1630	32,75
10 units or more	1630	

€	COM	COL	1	2	3	4	5	6	7	8	9	10	11	L1	L2	L3	L6
	6.116	6.320	6.566	6.765	6.923	7.188	7.459	7.727	7.996	8.262	8.531	8.800	9.068	9.305	10.275	12.040	16.709

Set 11 / Conjunto 11

5 Modules 5 Módulos
SF2318 + SF2313 + SF2321 + SF2313 + SF2317

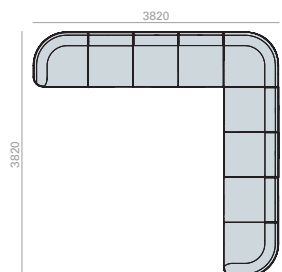

	COM cm. per unit	COL m2
1 units	2890	57,75
10 units or more	2890	

€	COM	COL	1	2	3	4	5	6	7	8	9	10	11	L1	L2	L3	L6
	9.938	10.298	10.736	11.087	11.369	11.840	12.317	12.795	13.270	13.742	14.219	14.696	15.172	15.593	17.311	20.440	28.719

Set 12 / Conjunto 12

5 Modules 5 Módulos
SF2320 + SF2313 + SF2321 + SF2313 + SF2319

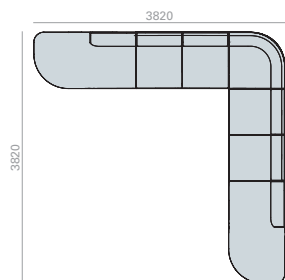

	COM cm. per unit	COL m2
1 units	2890	57,75
10 units or more	2890	

€	COM	COL	1	2	3	4	5	6	7	8	9	10	11	L1	L2	L3	L6
	9.148	9.506	9.946	10.297	10.577	11.050	11.527	12.005	12.478	12.952	13.429	13.906	14.382	14.803	16.521	19.650	27.929

**Examples of modular configurations
Ejemplos de combinaciones modulares**

Set 13 / Conjunto 13

5 Modules 5 Módulos

SF2316 + SF2313 + SF2321 + SF2313 + SF2315

	COM cm. per unit	COL m2
1 units	3150	62,75
10 units or more	3150	

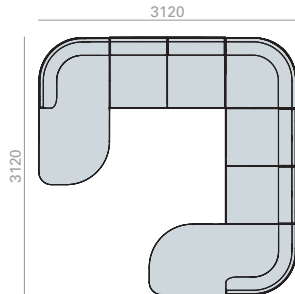

	COM	COL	1	2	3	4	5	6	7	8	9	10	11	L1	L2	L3	L6
€	9.532	9.922	10.404	10.783	11.091	11.604	12.125	12.643	13.162	13.678	14.197	14.716	15.236	15.697	17.567	20.980	30.003

Set 14 / Conjunto 14

8 Modules 8 Módulos

SF2318 + SF2313 + SF2321 + SF2313 + SF2313 +
SF2321 + SF2313 + SF2317

	COM cm. per unit	COL m2
1 units	4540	90,5
10 units or more	4540	

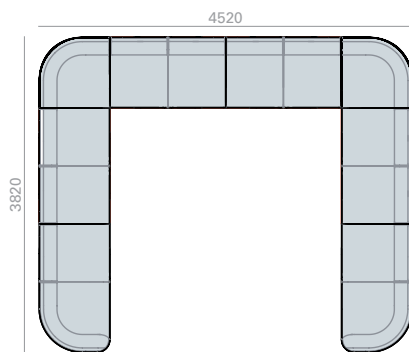

	COM	COL	1	2	3	4	5	6	7	8	9	10	11	L1	L2	L3	L6
€	15.602	16.166	16.856	17.406	17.850	18.590	19.338	20.090	20.836	21.578	22.326	23.076	23.824	24.486	27.184	32.100	45.106

Set 15 / Conjunto 15

8 Modules 8 Módulos

SF2320 + SF2313 + SF2321 + SF2313 + SF2313 +
SF2321 + SF2313 + SF2319

	COM cm. per unit	COL m2
1 units	4540	90,5
10 units or more	4540	

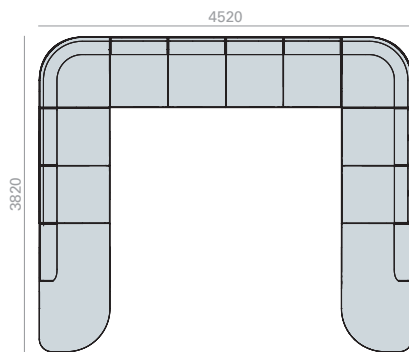

	COM	COL	1	2	3	4	5	6	7	8	9	10	11	L1	L2	L3	L6
€	14.812	15.374	16.066	16.616	17.058	17.800	18.548	19.300	20.044	20.788	21.536	22.286	23.034	23.696	26.394	31.310	44.316

Examples of modular configurations
Ejemplos de combinaciones modulares

Set 16 / Conjunto 16

6 Modules 6 Módulos
SF2318 + SF2321 + SF2313 + SF2313 + SF2321 + SF2317

	COM cm. per unit	COL m2
1 units	3280	65,5
10 units or more	3280	

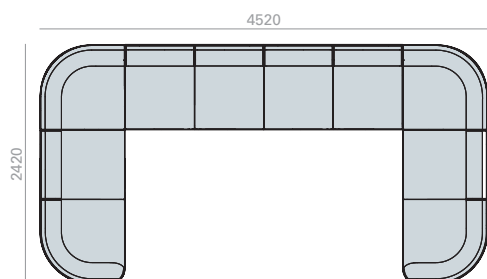

	COM	COL	1	2	3	4	5	6	7	8	9	10	11	L1	L2	L3	L6
€	11.780	12.188	12.686	13.084	13.404	13.938	14.480	15.022	15.562	16.098	16.638	17.180	17.720	18.198	20.148	23.700	33.096

Set 17 / Conjunto 17

6 Modules 6 Módulos
SF2320 + SF2321 + SF2313 + SF2313 + SF2321 + SF2319

	COM cm. per unit	COL m2
1 units	3280	65,5
10 units or more	3280	

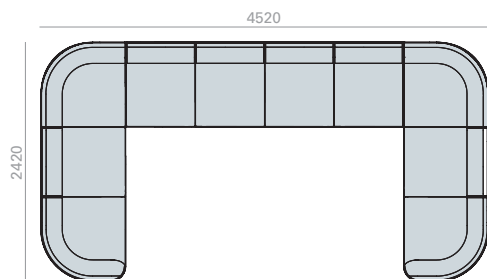

	COM	COL	1	2	3	4	5	6	7	8	9	10	11	L1	L2	L3	L6
€	10.990	11.396	11.896	12.294	12.612	13.148	13.690	14.232	14.770	15.308	15.848	16.390	16.930	17.408	19.358	22.910	32.306

Set 18 / Conjunto 18

2 Modules 2 Módulos
SF2313 + SF2313

	COM cm. per unit	COL m2
1 units	1260	25
10 units or more	1260	

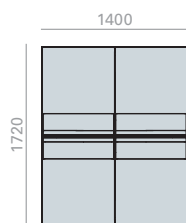

	COM	COL	1	2	3	4	5	6	7	8	9	10	11	L1	L2	L3	L6
€	3.822	3.978	4.170	4.322	4.446	4.652	4.858	5.068	5.274	5.480	5.688	5.896	6.104	6.288	7.036	8.400	12.010

Set 19 / Conjunto 19

2 Modules 2 Módulos
SF2314 + SF2314

Examples of modular configurations Ejemplos de combinaciones modulares

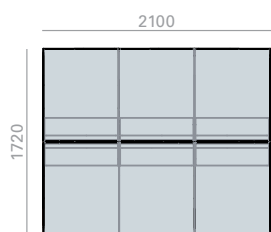

	COM cm. per unit	COL m2
1 units	1960	39
10 units or more	1960	

€	COM	COL	1	2	3	4	5	6	7	8	9	10	11	L1	L2	L3	L6
	5.142	5.384	5.680	5.920	6.110	6.432	6.752	7.074	7.396	7.720	8.042	8.364	8.688	8.974	10.138	12.262	17.878

Set 20 / Conjunto 20

6 Modules 6 Módulos
SF2320 + SF2313 + SF2319 + SF2320 + SF2313 + SF2319

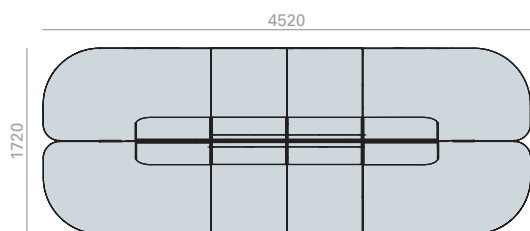

	COM cm. per unit	COL m2
1 units	3740	75
10 units or more	3740	

€	COM	COL	1	2	3	4	5	6	7	8	9	10	11	L1	L2	L3	L6
	10.790	11.254	11.822	12.278	12.638	13.252	13.870	14.488	15.098	15.712	16.332	16.948	17.564	18.108	20.332	24.380	35.094

Set 21 / Conjunto 21

6 Modules 6 Módulos
SF2320 + SF2314 + SF2319 + SF2320 + SF2314 + SF2319

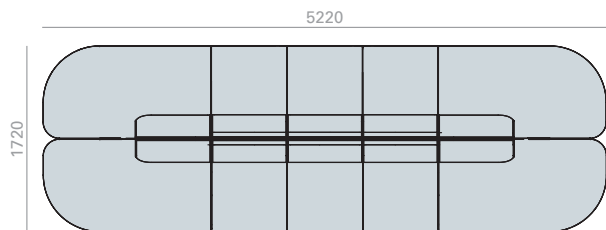

	COM cm. per unit	COL m2
1 units	4440	89
10 units or more	4440	

€	COM	COL	1	2	3	4	5	6	7	8	9	10	11	L1	L2	L3	L6
	12.110	12.660	13.332	13.876	14.302	15.032	15.764	16.494	17.220	17.952	18.686	19.416	20.148	20.794	23.434	28.242	40.962

Set 22 / Conjunto 22

3 Modules 3 Módulos
SF2318 + SF2323 + SF2317

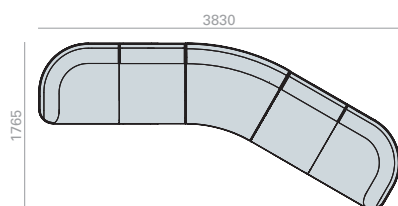

	COM cm. per unit	COL m2
1 units	1730	34,75
10 units or more	1730	

€	COM	COL	1	2	3	4	5	6	7	8	9	10	11	L1	L2	L3	L6
	5.871	6.088	6.348	6.560	6.727	7.009	7.296	7.581	7.865	8.148	8.435	8.719	9.004	9.255	10.285	12.157	17.113

Set 23 / Conjunto 23

4 Modules 4 Módulos
SF2318 + SF2313 + SF2323 + SF2313

Examples of modular configurations Ejemplos de combinaciones modulares

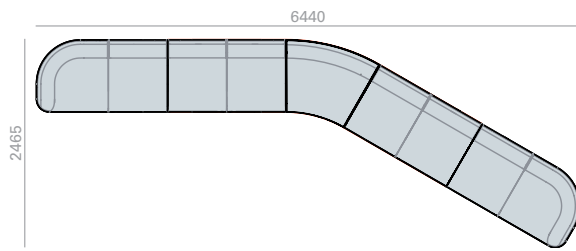

	COM cm. per unit	COL m2
1 units	2370	47,25
10 units or more	2370	

€	COM	COL	1	2	3	4	5	6	7	8	9	10	11	L1	L2	L3	L6
	7.556	7.851	8.210	8.498	8.729	9.116	9.506	9.899	10.287	10.675	11.067	11.457	11.848	12.193	13.602	16.167	22.957

Set 24 / Conjunto 24

6 Modules 6 Módulos
SF2317 + SF2320 + SF2313 + SF2323 + SF2313 + SF2319

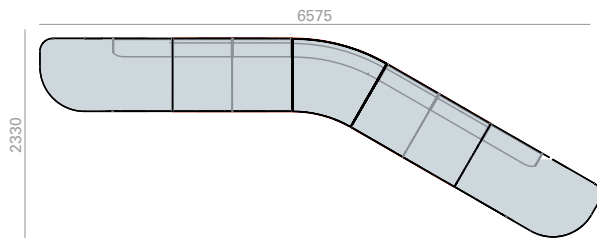

	COM cm. per unit	COL m2
1 units	3610	72,25
10 units or more	3610	

€	COM	COL	1	2	3	4	5	6	7	8	9	10	11	L1	L2	L3	L6
	11.040	11.489	12.036	12.476	12.825	13.416	14.012	14.609	15.199	15.791	16.389	16.983	17.578	18.103	20.250	24.157	34.499

Set 25 / Conjunto 25

5 Modules 5 Módulos
SF2318 + SF2323 + SF2313 + SF2323 + SF2317

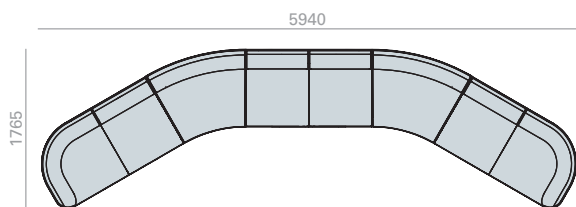

	COM cm. per unit	COL m2
1 units	2850	57
10 units or more	2850	

€	COM	COL	1	2	3	4	5	6	7	8	9	10	11	L1	L2	L3	L6
	9.379	9.735	10.165	10.513	10.789	11.254	11.725	12.196	12.663	13.130	13.602	14.070	14.540	14.954	16.650	19.734	27.899

Set 26 / Conjunto 26

5 Modules 5 Módulos
SF2320 + SF2323 + SF2313 + SF2323 + SF2319

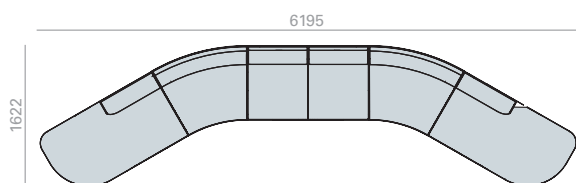

	COM cm. per unit	COL m2
1 units	2850	57
10 units or more	2850	

€	COM	COL	1	2	3	4	5	6	7	8	9	10	11	L1	L2	L3	L6
	8.589	8.943	9.375	9.723	9.997	10.464	10.935	11.406	11.871	12.340	12.812	13.280	13.750	14.164	15.860	18.944	27.109

Examples of modular configurations
Ejemplos de combinaciones modulares

Set 27 / Conjunto 27

3 Modules 3 Módulos
SF2318 + SF2322 + SF2317

	COM cm. per unit	COL m2
1 units	2220	44,5
10 units or more	2220	

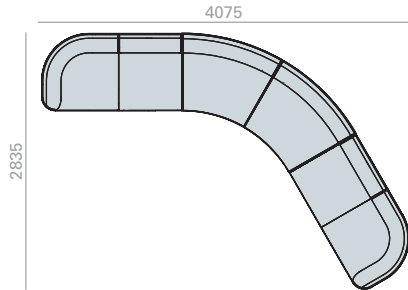

	COM	COL	1	2	3	4	5	6	7	8	9	10	11	L1	L2	L3	L6
€	6.995	7.272	7.608	7.879	8.093	8.456	8.823	9.189	9.554	9.917	10.285	10.650	11.015	11.339	12.659	15.062	21.422

Set 28 / Conjunto 28

3 Modules 3 Módulos
SF2320 + SF2322 + SF2319

	COM cm. per unit	COL m2
1 units	2220	44,5
10 units or more	2220	

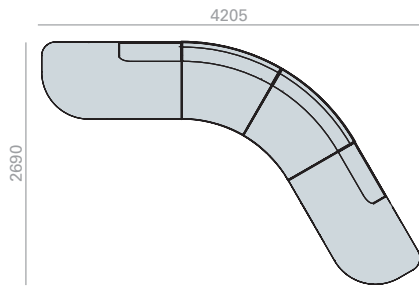

	COM	COL	1	2	3	4	5	6	7	8	9	10	11	L1	L2	L3	L6
€	6.205	6.480	6.818	7.089	7.301	7.666	8.033	8.399	8.762	9.127	9.495	9.860	10.225	10.549	11.869	14.272	20.632

Set 29 / Conjunto 29

5 Modules 5 Módulos
SF2318 + SF2313 + SF2322 + SF2313 + SF2317

	COM cm. per unit	COL m2
1 units	3480	69,5
10 units or more	3480	

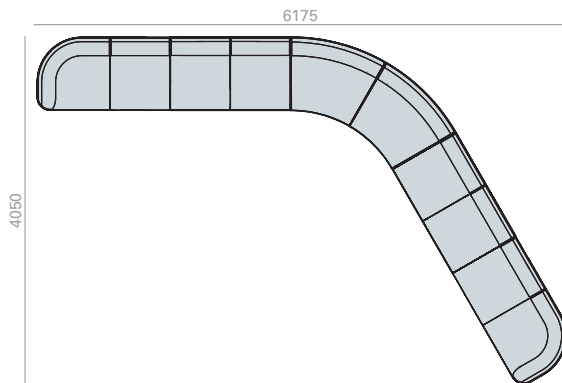

	COM	COL	1	2	3	4	5	6	7	8	9	10	11	L1	L2	L3	L6
€	10.817	11.250	11.778	12.201	12.539	13.108	13.681	14.257	14.828	15.397	15.973	16.546	17.119	17.627	19.695	23.462	33.432

Examples of modular configurations
Ejemplos de combinaciones modulares

Set 30 / Conjunto 30

5 Modules 5 Módulos
SF2320 + SF2313 + SF2322 + SF2313 + SF2319

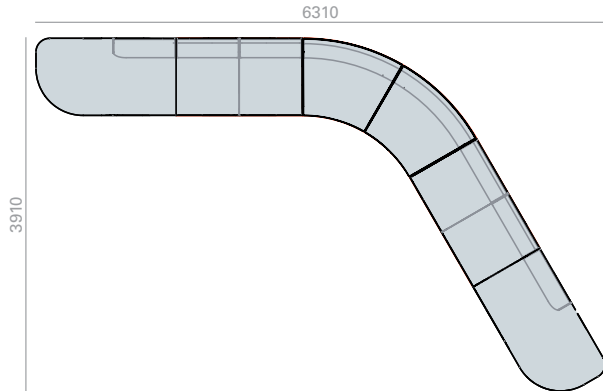

	COM cm. per unit	COL m2
1 units	3480	69,5
10 units or more	3480	

	COM	COL	1	2	3	4	5	6	7	8	9	10	11	L1	L2	L3	L6
€	10.027	10.458	10.988	11.411	11.747	12.318	12.891	13.467	14.036	14.607	15.183	15.756	16.329	16.837	18.905	22.672	32.642

Set 31 / Conjunto 31

7 Modules 7 Módulos
SF2318 + SF2313 + SF2322 + SF2313 + SF2322 + SF2313 + SF2317

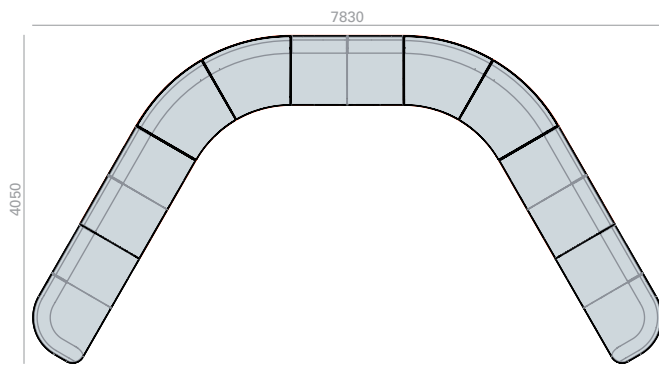

	COM cm. per unit	COL m2
1 units	5090	101,5
10 units or more	5090	

	COM	COL	1	2	3	4	5	6	7	8	9	10	11	L1	L2	L3	L6
€	15.449	16.081	16.855	17.473	17.967	18.800	19.637	20.480	21.315	22.148	22.990	23.828	24.666	25.410	28.434	33.944	48.527

Set 32 / Conjunto 32

7 Modules 7 Módulos
SF2320 + SF2313 + SF2322 + SF2313 + SF2322 + SF2313 + SF2319

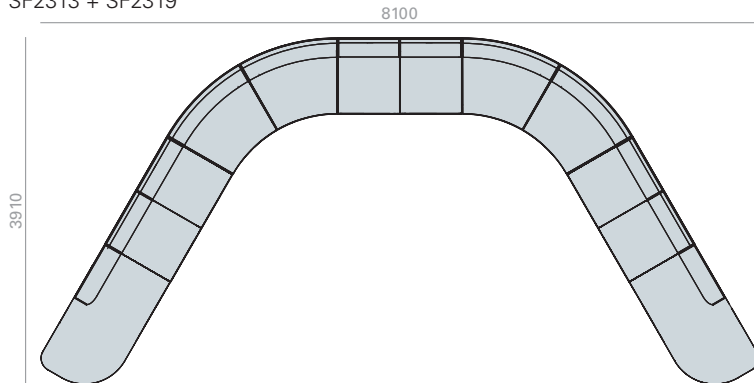

	COM cm. per unit	COL m2
1 units	5090	101,5
10 units or more	5090	

	COM	COL	1	2	3	4	5	6	7	8	9	10	11	L1	L2	L3	L6
€	14.659	15.289	16.065	16.683	17.175	18.010	18.847	19.690	20.523	21.358	22.200	23.038	23.876	24.620	27.644	33.154	47.737

Examples of modular configurations
Ejemplos de combinaciones modulares

Set 33 / Conjunto 33

4 Modules 4 Módulos
SF2318 + SF2322 + SF2322 + SF2317

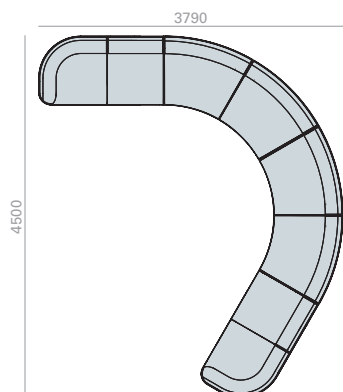

	COM cm. per unit	COL m2
1 units	3200	64
10 units or more	3200	

	COM	COL	1	2	3	4	5	6	7	8	9	10	11	L1	L2	L3	L6
€	9.716	10.114	10.600	10.990	11.298	11.822	12.350	12.878	13.404	13.928	14.458	14.984	15.510	15.978	17.880	21.344	30.512

Set 34 / Conjunto 34

5 Modules 5 Módulos
SF2318 + SF2322 + SF2322 + SF2322 + SF2317

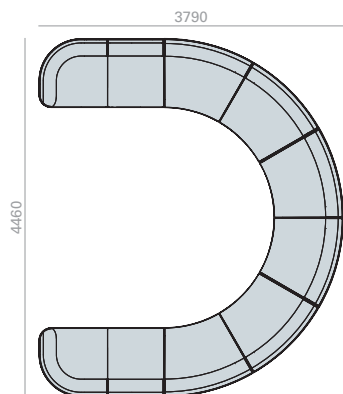

	COM cm. per unit	COL m2
1 units	4180	83,5
10 units or more	4180	

	COM	COL	1	2	3	4	5	6	7	8	9	10	11	L1	L2	L3	L6
€	12.437	12.956	13.592	14.101	14.503	15.188	15.877	16.567	17.254	17.939	18.631	19.318	20.005	20.617	23.101	27.626	39.602

Set 35 / Conjunto 35

4 Modules 4 Módulos
SF2320 + SF2322 + SF2322 + SF2319

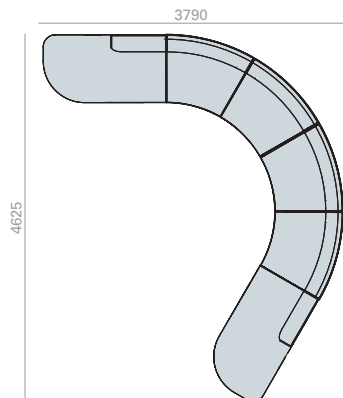

	COM cm. per unit	COL m2
1 units	3200	64
10 units or more	3200	

	COM	COL	1	2	3	4	5	6	7	8	9	10	11	L1	L2	L3	L6
€	8.926	9.322	9.810	10.200	10.506	11.032	11.560	12.088	12.612	13.138	13.668	14.194	14.720	15.188	17.090	20.554	29.722

Examples of modular configurations
Ejemplos de combinaciones modulares

Set 36 / Conjunto 36

5 Modules 5 Módulos
SF2320 + SF2322 + SF2322 + SF2322 + SF2319

	COM cm. per unit	COL m2
1 units	4180	83,5
10 units or more	4180	

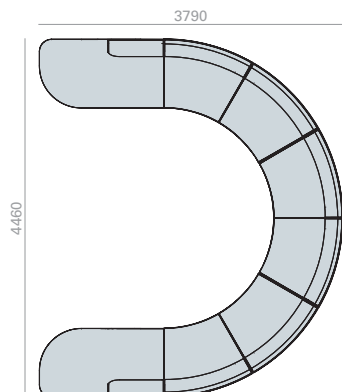

	COM	COL	1	2	3	4	5	6	7	8	9	10	11	L1	L2	L3	L6
€	11.647	12.164	12.802	13.311	13.711	14.398	15.087	15.777	16.462	17.149	17.841	18.528	19.215	19.827	22.311	26.836	38.812

Set 37 / Conjunto 37

7 Modules 7 Módulos
SF2318 + SF2323 + SF2322 + SF2313 + SF2322 + SF2323 + SF2317

	COM cm. per unit	COL m2
1 units	4810	96
10 units or more	4810	

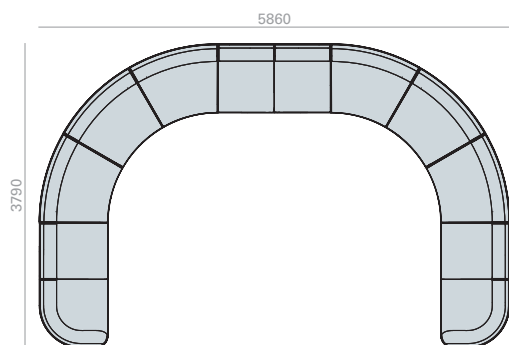

	COM	COL	1	2	3	4	5	6	7	8	9	10	11	L1	L2	L3	L6
€	14.821	15.419	16.149	16.735	17.199	17.986	18.779	19.574	20.363	21.152	21.948	22.738	23.530	24.232	27.092	32.298	46.079

Set 38 / Conjunto 38

7 Modules 7 Módulos
SF2320 + SF2323 + SF2322 + SF2313 + SF2322 + SF2323 + SF2319

	COM cm. per unit	COL m2
1 units	4810	96
10 units or more	4810	

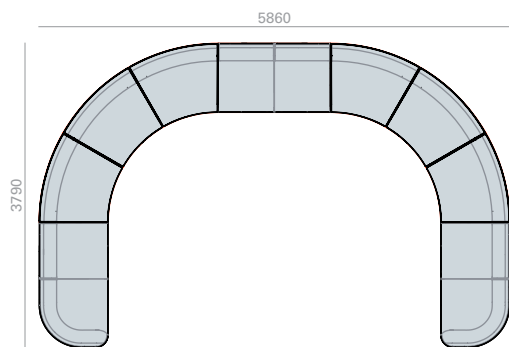

	COM	COL	1	2	3	4	5	6	7	8	9	10	11	L1	L2	L3	L6
€	14.031	14.627	15.359	15.945	16.407	17.196	17.989	18.784	19.571	20.362	21.158	21.948	22.740	23.442	26.302	31.508	45.289

Examples of modular configurations
Ejemplos de combinaciones modulares

Set 39 / Conjunto 39

9 Modules 9 Módulos

SF2318 + SF2322 + SF2313 + SF2322 + SF2313 +
SF2322 + SF2313 + SF2322 + SF2317

	COM cm. per unit	COL m2
1 units	7050	140,5
10 units or more	7050	

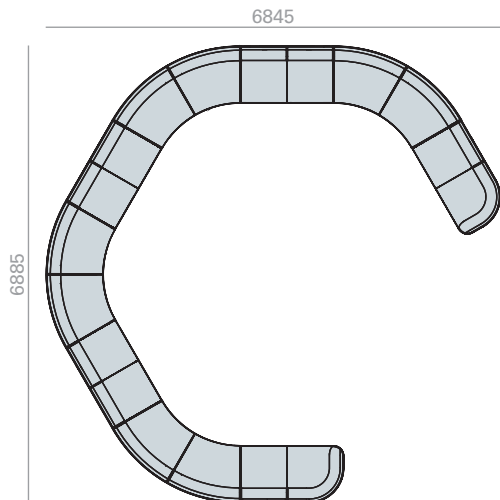

	COM	COL	1	2	3	4	5	6	7	8	9	10	11	L1	L2	L3	L6
€	20.891	21.765	22.839	23.695	24.377	25.532	26.691	27.858	29.015	30.170	31.336	32.496	33.656	34.688	38.876	46.508	66.707

Set 40 / Conjunto 40

9 Modules 9 Módulos

SF2320 + SF2322 + SF2313 + SF2322 + SF2313 +
SF2322 + SF2313 + SF2322 + SF2319

	COM cm. per unit	COL m2
1 units	7050	140,5
10 units or more	7050	

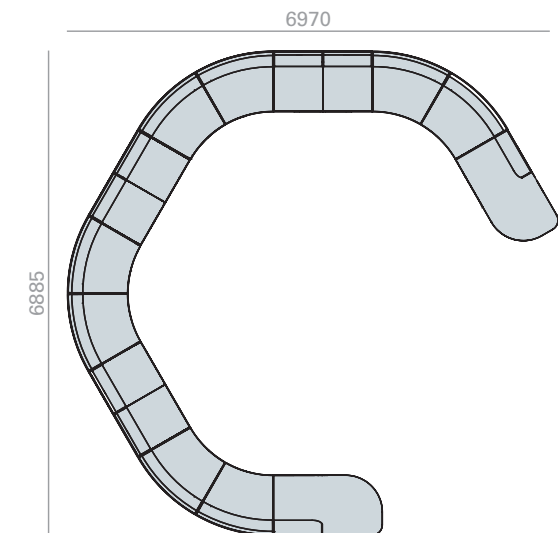

	COM	COL	1	2	3	4	5	6	7	8	9	10	11	L1	L2	L3	L6
€	20.101	20.973	22.049	22.905	23.585	24.742	25.901	27.068	28.223	29.380	30.546	31.706	32.866	33.898	38.086	45.718	65.917

Examples of modular configurations
Ejemplos de combinaciones modulares

Set 41 / Conjunto 41

8 Modules 8 Módulos

SF2320 + SF2322 + SF2322 + SF2322 + SF2322 +
SF2322 + SF2322 + SF2320

	COM cm. per unit	COL m2
1 units	7120	142
10 units or more	7120	

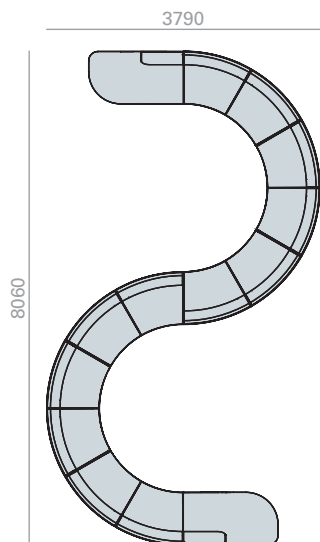

	COM	COL	1	2	3	4	5	6	7	8	9	10	11	L1	L2	L3	L6
€	19.810	20.690	21.778	22.644	23.326	24.496	25.668	26.844	28.012	29.182	30.360	31.530	32.700	33.744	37.974	45.682	66.082

Set 42 / Conjunto 42

8 Modules 8 Módulos

SF2320 + SF2313 + SF2321 + SF2313 + SF2313 +
SF2321 + SF2313 + SF2320

	COM cm. per unit	COL m2
1 units	4540	90,5
10 units or more	4540	

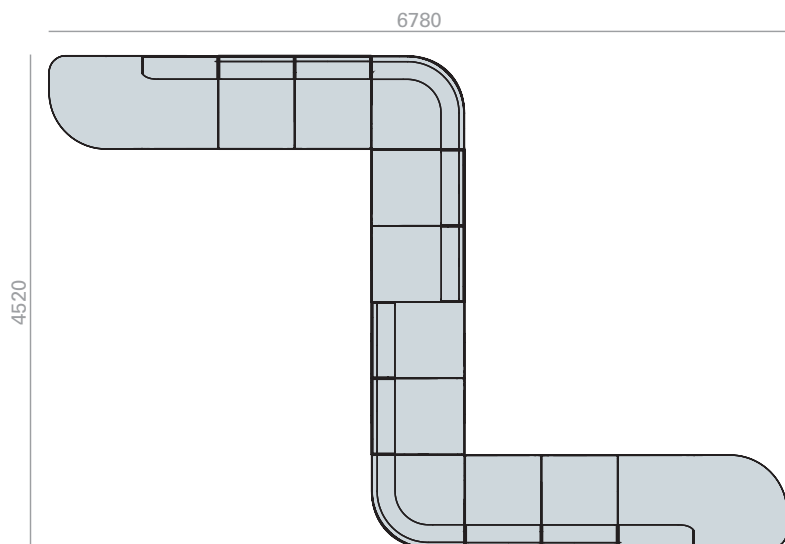

	COM	COL	1	2	3	4	5	6	7	8	9	10	11	L1	L2	L3	L6
€	14.812	15.374	16.066	16.616	17.058	17.800	18.548	19.300	20.044	20.788	21.536	22.286	23.034	23.696	26.394	31.310	44.316

Examples of modular configurations
Ejemplos de combinaciones modulares

Set 43 / Conjunto 43

8 Modules 8 Módulos
SF2318 + SF2313 + SF2321 + SF2313 + SF2313 +
SF2321 + SF2313 + SF2318

	COM cm. per unit	COL m2
1 units	4540	90,5
10 units or more	4540	

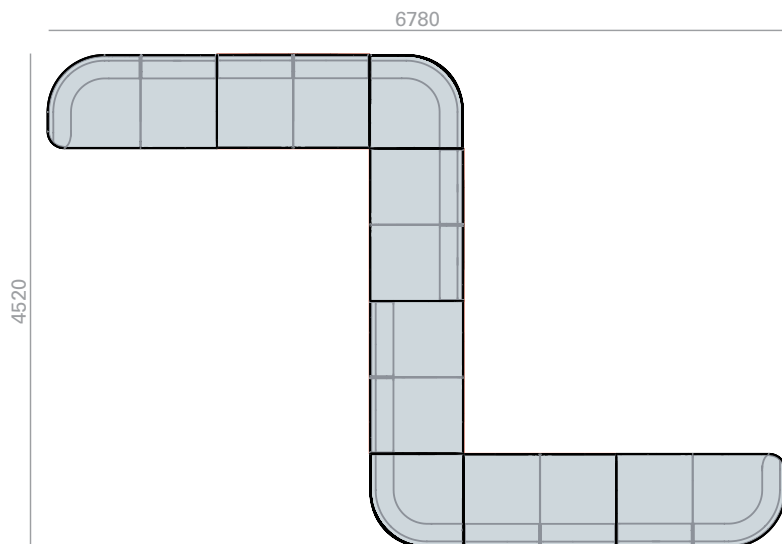

	COM	COL	1	2	3	4	5	6	7	8	9	10	11	L1	L2	L3	L6
€	15.602	16.166	16.856	17.406	17.850	18.590	19.338	20.090	20.836	21.578	22.326	23.076	23.824	24.486	27.184	32.100	45.106

Set 44 / Conjunto 44

6 Modules 6 Módulos
SF2318 + SF2323 + SF2322 + SF2322 + SF2323 +
SF2318

	COM cm. per unit	COL m2
1 units	4180	83,5
10 units or more	4180	

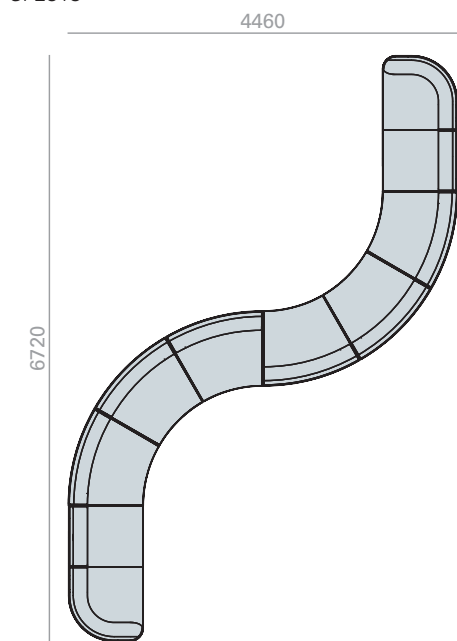

	COM	COL	1	2	3	4	5	6	7	8	9	10	11	L1	L2	L3	L6
€	12.910	13.430	14.064	14.574	14.976	15.660	16.350	17.040	17.726	18.412	19.104	19.790	20.478	21.088	23.574	28.098	40.074

Examples of modular configurations
Ejemplos de combinaciones modulares

Set 45 / Conjunto 45

7 Modules 7 Módulos

SF2320 + SF2323 + SF2322 + SF2322 + SF2323 + SF2323 + SF2320

	COM cm. per unit	COL m2
1 units	4670	93,25
10 units or more	4670	

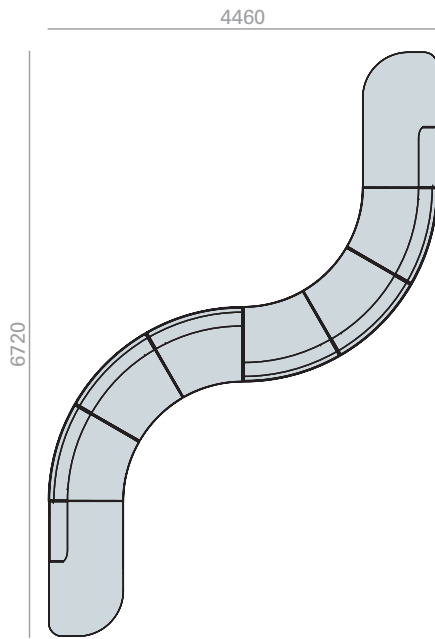

	COM	COL	1	2	3	4	5	6	7	8	9	10	11	L1	L2	L3	L6
€	13.717	14.296	15.006	15.576	16.023	16.789	17.560	18.331	19.095	19.864	20.637	21.403	22.172	22.853	25.631	30.685	44.065

Set 46 / Conjunto 46

9 Modules 9 Módulos

SF2320 + SF2322 + SF2319 + SF2320 + SF2322 + SF2319 + SF2320 + SF2322 + SF2319

	COM cm. per unit	COL m2
1 units	6660	133,5
10 units or more	6660	

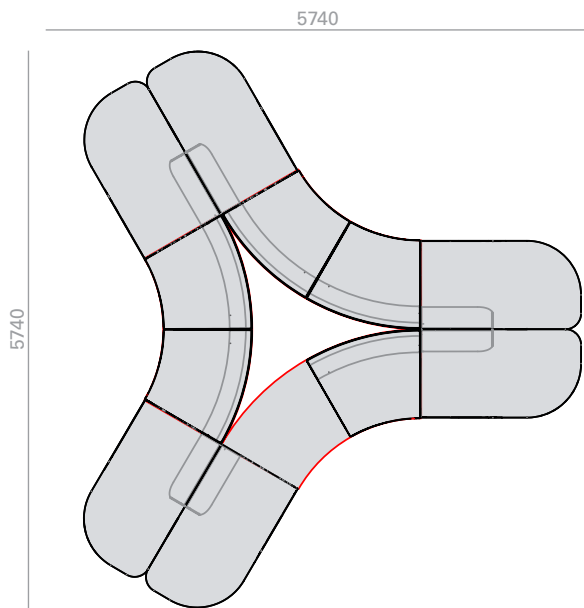

	COM	COL	1	2	3	4	5	6	7	8	9	10	11	L1	L2	L3	L6
€	18.615	19.440	20.454	21.267	21.903	22.998	24.099	25.197	26.286	27.381	28.485	29.580	30.675	31.647	35.607	42.816	61.896

Examples of modular configurations
Ejemplos de combinaciones modulares

Set 47 / Conjunto 47

9 Modules 9 Módulos

SF2318 + SF2322 + SF2317 + SF2318 + SF2322 +
SF2317 + SF2318 + SF2322 + SF2317

	COM cm. per unit	COL m2
1 units	6660	133,5
10 units or more	6660	

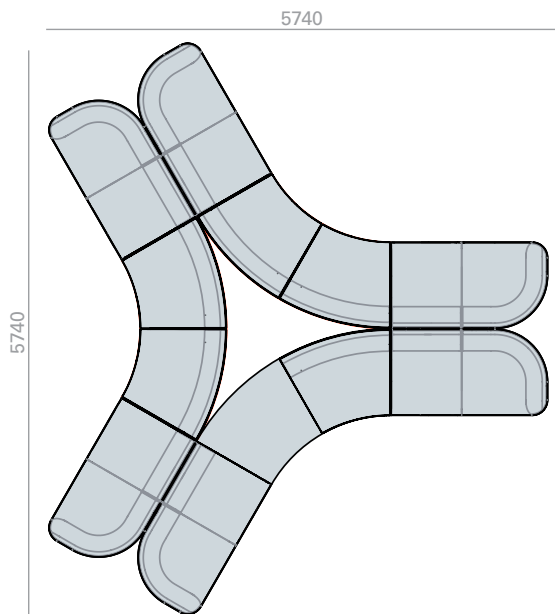

	COM	COL	1	2	3	4	5	6	7	8	9	10	11	L1	L2	L3	L6
€	20.985	21.816	22.824	23.637	24.279	25.368	26.469	27.567	28.662	29.751	30.855	31.950	33.045	34.017	37.977	45.186	64.266

Set 48 / Conjunto 48

12 Modules 12 Módulos

SF2320 + SF2321 + SF2320 + SF2319 + SF2321 +
SF2319 + SF2320 + SF2321 + SF2319 + SF2321 +
SF2320 + SF2319

	COM cm. per unit	COL m2
1 units	6520	131
10 units or more	6520	

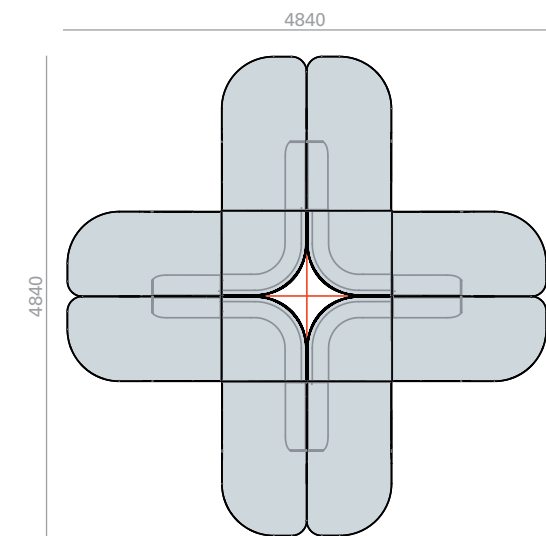

	COM	COL	1	2	3	4	5	6	7	8	9	10	11	L1	L2	L3	L6
€	21.304	22.112	23.104	23.900	24.524	25.592	26.676	27.748	28.816	29.888	30.964	32.040	33.112	34.060	37.940	45.000	63.676

Examples of modular configurations
Ejemplos de combinaciones modulares

Set 49 / Conjunto 49

24 Modules 24 Módulos

SF2320 + SF2322 + SF2322 + SF2319 + SF2320 + SF2322 + SF2322 + SF2320
+ SF2319 + SF2322 + SF2322 + SF2319 + SF2320 + SF2322 + SF2322 +
SF2319 + SF2320 + SF2322 + SF2322 + SF2320 + SF2319 + SF2322 + SF2322
+ SF2319

	COM cm. per unit	COL m2
1 units	19200	384
10 units or more	19200	

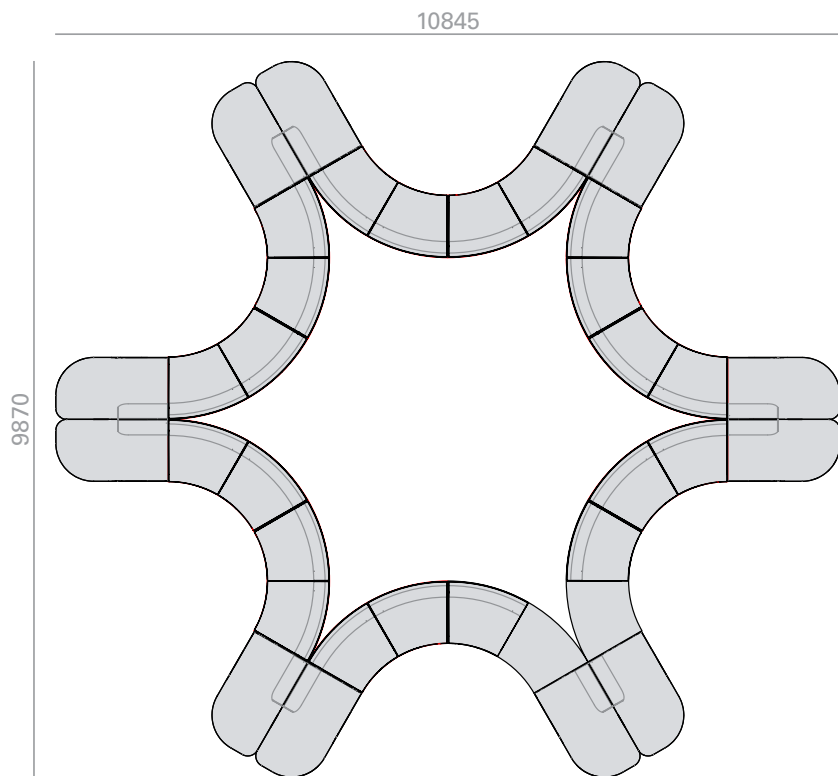

	COM	COL	1	2	3	4	5	6	7	8	9	10	11	L1	L2	L3	L6
€	53.556	55.932	58.860	61.200	63.036	66.192	69.360	72.528	75.672	78.828	82.008	85.164	88.320	91.128	102.540	123.324	178.332

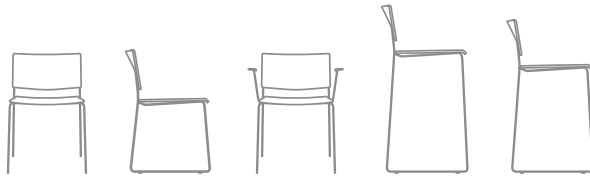

Description
Descripción

Stackable chairs, armchairs and stools with Eco thermopolymer seat and backrest available in different colors or Pure Eco thermopolymer (100% recycled content) available in sand, oak or upholstered color (including stack protector). Available with a steel rod sled base and polished chrome, white or black finish or a 4-legged steel tube base available in different colors. The stools are Stackable chairs, armchairs and stools with Eco thermopolymer seat and backrest available in different colors or Pure Eco thermopolymer (100% recycled content) available in sand, oak or upholstered color (including stack protector). Available with a steel rod sled base and polished chrome, white or black finish or a 4-legged steel tube base available in different colors. The stools are offered in two different heights and finished in polished chrome, white or black. Available upholstered version with parallel seams. Flame retardant version available, for more information consult our Sales Department.

Sillas, sillones y banquetas apilables con asiento y respaldo de termopolímero Eco disponible en diferentes colores o termopolímero Pure Eco (100% reciclado) disponible en color arena, roble o tapizado (incluido protector de apilado). Disponible con base de patín de varilla de acero y acabado cromo brillo, blanco o negro o base de 4 patas de tubo de acero disponible en diferentes colores. Las banquetas se ofrecen en dos alturas diferentes y acabado cromo brillo, blanco o negro. Disponible versión tapizada con costuras paralelas. Versión ignífuga disponible, para más información consulte con nuestro Departamento Comercial.

Upholstery
Tapicería

The Sit collection supports all upholsteries of Andreu World Catalogue. For custom own materials, contact our Customer Department. La colección Sit admite todas las telas del catálogo de Andreu World. Para telas cliente, consultar con nuestro Departamento Comercial.

Fabrics / Telas

- 1** Soft-fiber
Jacquard One
Jacquard Three
Citadel
Sand
Era
Gravity
Rivet
Urban
Reel One (in/out)
Spin One
Spin Two
Spin Three
Spin Four
Spin Five
- 2** Jacquard Two
Solid & Stripes
Loom One
Circular One Pure Eco
Tack One (in/out)

- 3** Jacquard Four
Medley
Revive 1
Natte
Main Line Flax
Loom Two (in/out)
Mezzo
Reel two (in/out)
Jacquard Five

- 4** Jacquard 4 Special
Nexus
Field 2
Remix 3
Heritage
Savane
Loom Three
Loom Four
Cura
Oceanic
Reel Three (in/out)
Reel Four (in/out)
Reflect
Spin Six

- 5** Silk
Synergy
Step
Step Melange
Blazer
Melange Nap
Chili
Noma
Re-wool

- 6** Go check
Swing
Chartres
Zori
Patio
Tack Two (in/out)
Tack Three (in/out)

- 7** Canvas 2
Select
Clara 2
Tack Five (in/out)
Hero 2

- 8** Capture
Fiord 2
Tonus 4
Divina 3
Lopi
Domino
Atrium

- 9** Divina MD
Divina Melange 3
Hallingdal 65
Steelcut Trio 3
Tack Four (in/out)

- 11** Arda
Ecriture
Zero

Faux Leather / Ecopiel

- 1** Valencia
- 2** Silvertex
- 3** Maglia
- 4** Dolce
- 8** Ultraleather
- 9** Brisa
Brisa Distressed
Fresco
Ultraleather Pro
Promessa

- 10** Tottori
Coast (in/out)

- 11** Reef Pro
Volar Bio

Leather / Piel

- L1** High grade cow leather.
Piel de vaca de 1ª categoría.
- L3** Polished full grain leather.
Piena flor pulida.
- L6** Aniline leather batique-effect.
Scandinavian cattle.
Piel anilina efecto batique.
Ganado escandinavo.

Wood finish Oak
Acabado madera
Roble

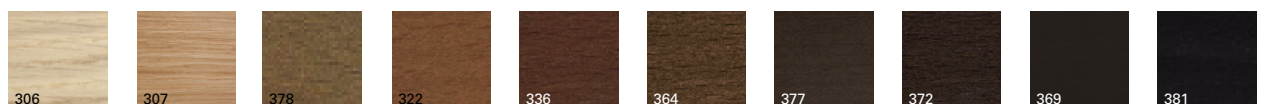

Premium finish and wood lacquers
Acabado premium y lacas madera

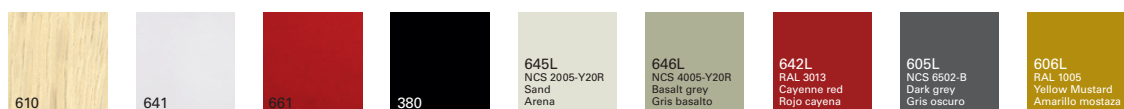

Open pore in oak wood seats and backs. /Poros abiertos en asientos y respaldos de tablero de roble.

Steel finish
Acabado de acero

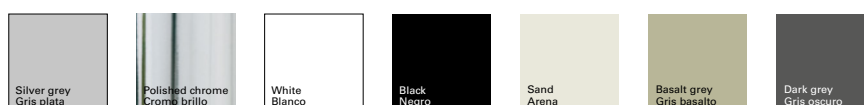

Certificates
Certificados

Fireproof polyurethane foam
Espuma de poliuretano ignífuga

UNE EN 1021:2006
BS 5852 part 2 crib 5
UNI 9175 Classe 1 IM
BKZ 5.2
California TB 117:2013
California TB 133*

*Contact our Customer Department
*Consultar con nuestro Departamento Comercial

Quality - Resistance
Calidad - Resistencia

UNE EN 16139:2013

Intellectual property Propiedad intelectual

All our collections are protected by international industrial design registries, designs patents, copyrights and intellectual Property laws. Unauthorized use of AW International Property is a criminal offence and can lead to prosecution. Todas nuestras colecciones están protegidas por registros de diseño industrial, diseño de patente, copyright y derechos de propiedad intelectual todo el mundo. El uso no autorizado de los diseños y propiedad intelectual de AW supone un delito que puede ser sometido a acción judicial.



SI1200



Stackable chair Eco thermo-polymer shell available in several colors or Pure Eco thermo-polymer (100% recycled) available in sand color and 4- legs tubular steel base available in several colors. Optional upholstered seat (includes a stacking protector or upholstered seat and back. Optional parallel stitching upholstery for seat.

Silla apilable con asiento y respaldo de termopolímero disponible en varios colores y base de 4 patas de tubo de acero disponible en diferentes colores. Opción de asiento tapizado (incluido protector de apilado) o asiento y respaldo tapizado. Opción de asiento tapizado con costuras paralelas.

COM cm. per unit	COL m2
------------------	--------

Upholstered seat and back Asiento y respaldo tapizado

1 units	85	1,75
10 units or more	80	

Upholstered seat Asiento tapizado

1 units	60	1,25
10 units or more	50	

- 0,34 m3
- 30,8 kg
- x4
- 15
- 20

€ TP
139

Thermo-polymer shell
Carcasa termopolímero



Upholstered seat and back
Asiento y respaldo tapizado

COM	COL	1	2	3	4	5	6	7	8	9	10	11	L1	L2	L3	L6
263	272	278	285	293	302	312	322	332	340	351	359	369	378	413	476	643



Upholstered seat
Asiento tapizado

COM	COL	1	2	3	4	5	6	7	8	9	10	11	L1	L2	L3	L6
233	239	243	249	254	259	265	273	278	284	291	296	302	309	332	371	479

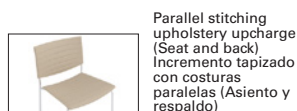

Parallel stitching upholstery upcharge (Seat and back)
Incremento tapizado con costuras paralelas (Asiento y respaldo) | 59 |



Parallel stitching upholstery upcharge (Seat)
Incremento tapizado con costuras paralelas (Asiento) | 30 |



Polished chrome upcharge and steel colors
Incremento cromo brillo y resto de colores acero | 24 |

SO1202



Stackable Armchair with Eco thermo-polymer shell available in several colors or Pure Eco thermo-polymer (100% recycled) available in sand color and 4-legs tubular steel base available in several colors. Optional upholstered seat (includes a stacking protector) or upholstered seat and back. Optional parallel stitching upholstery for seat.

Sillón apilable con asiento y respaldo de termopolímero disponible en varios colores y base de 4 patas de tubo de acero disponible en diferentes colores. Opción de asiento tapizado (incluido protector de apilado) o asiento y respaldo tapizado. Opción de asiento tapizado con costuras paralelas.

COM cm. per unit	COL m2
------------------	--------

Upholstered seat and back Asiento y respaldo tapizado

1 units	85	1,75
10 units or more	80	

Upholstered seat Asiento tapizado

1 units	60	1,25
10 units or more	50	

- 0,44 m3
- 37,2 kg
- x4
- 10
- 20

€ TP
194

Thermo-polymer shell
Carcasa termopolímero



Upholstered seat and back
Asiento y respaldo tapizado

COM	COL	1	2	3	4	5	6	7	8	9	10	11	L1	L2	L3	L6
329	337	344	352	359	367	377	386	396	404	414	424	433	441	474	536	698



Upholstered seat
Asiento tapizado

COM	COL	1	2	3	4	5	6	7	8	9	10	11	L1	L2	L3	L6
311	315	318	324	328	334	340	347	353	359	365	371	377	384	404	445	553

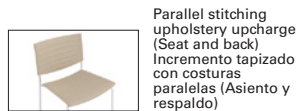

Parallel stitching upholstery upcharge (Seat and back)
Incremento tapizado con costuras paralelas (Asiento y respaldo) | 59 |



Parallel stitching upholstery upcharge (Seat)
Incremento tapizado con costuras paralelas (Asiento) | 30 |



Polished chrome upcharge and steel colors
Incremento cromo brillo y resto de colores acero | 30 |

SI1201



Stackable chair Eco thermo-polymer shell available in several colors or Pure Eco thermo-polymer (100% recycled) available in sand color and steel sled base finished in polished chrome, white or black. Optional upholstered seat (includes a stacking protector) or upholstered seat and back. Optional parallel stitching upholstery for seat

Silla apilable con asiento y respaldo de termopolímero disponible en varios colores y base de patín de varilla de acero en acabado cromo brillo, blanco o negro. Opción de asiento tapizado (incluido protector de apilado) o asiento y respaldo tapizado. Opción de asiento tapizado con costuras paralelas.

COM cm. per unit	COL m2
------------------	--------

Upholstered seat and back Asiento y respaldo tapizado

1 units	85	1,75
10 units or more	80	

Upholstered seat Asiento tapizado

1 units	60	1,25
10 units or more	50	

0,37 m3

33,6 kg

x4

17

20

€ TP
145

Thermo-polymer shell
Carcasa termopolímero



Upholstered seat and back
Asiento y respaldo tapizado

COM	COL	1	2	3	4	5	6	7	8	9	10	11	L1	L2	L3	L6
296	303	312	320	327	337	348	359	367	378	388	399	408	418	456	522	698



Upholstered seat
Asiento tapizado

COM	COL	1	2	3	4	5	6	7	8	9	10	11	L1	L2	L3	L6
251	255	259	264	268	276	281	287	295	300	306	314	319	325	347	388	497

Parallel stitching upholstery upcharge (Seat and back)
Incremento tapizado con costuras paralelas (Asiento y respaldo) | 59 |

Parallel stitching upholstery upcharge (Seat)
Incremento tapizado con costuras paralelas (Asiento) | 30 |

BQ1203

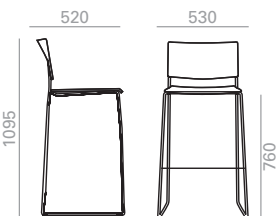

Stackable barstool Eco thermo-polymer shell available in several colors or Pure Eco thermo-polymer (100% recycled) available in sand color and steel sled base finished in polished chrome, white or black. Optional upholstered seat (includes a stacking protector) or upholstered seat and back. Optional parallel stitching upholstery for seat

Banqueta alta apilable con asiento y respaldo de termopolímero disponible en varios colores y base de patín de varilla de acero en acabado cromo brillo, blanco o negro. Incluido protector de apilado. Opción de asiento tapizado (incluido protector de apilado) o asiento y respaldo tapizado. Opción de asiento tapizado con costuras paralelas.

COM cm. per unit	COL m2
------------------	--------

Upholstered seat and back Asiento y respaldo tapizado

1 units	85	1,75
10 units or more	80	

Upholstered seat Asiento tapizado

1 units	60	1,25
10 units or more	50	

0,35 m3

23 kg

x2

8

€ TP
231

Thermo-polymer shell
Carcasa termopolímero



Upholstered seat and back
Asiento y respaldo tapizado

COM	COL	1	2	3	4	5	6	7	8	9	10	11	L1	L2	L3	L6
420	427	436	445	455	465	477	489	500	512	523	535	546	556	600	676	877



Upholstered seat
Asiento tapizado

COM	COL	1	2	3	4	5	6	7	8	9	10	11	L1	L2	L3	L6
325	329	334	340	345	352	358	363	369	375	382	389	396	400	423	466	576

Parallel stitching upholstery upcharge (Seat and back)
Incremento tapizado con costuras paralelas (Asiento y respaldo) | 59 |

Parallel stitching upholstery upcharge (Seat)
Incremento tapizado con costuras paralelas (Asiento) | 30 |

BQ1204

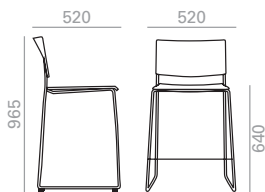

Stackable counter stool Eco thermo-polymer shell available in several colors or Pure Eco thermo-polymer (100% recycled) available in sand color and steel sled base finished in polished chrome, white or black. Optional upholstered seat (includes a stacking protector or upholstered seat and back. Optional parallel stitching upholstery or seat.

Banqueta baja apilable con asiento y respaldo de termopolímero disponible en varios colores y base de patín de varilla de acero en a abado cromo brillo, blanco o negro. Incluido protector de apilado. Opción de asiento tapizado (incluido protector de apilado) o asiento y respaldo tapizado. Opción de asiento tapizado con costuras paralelas.

COM cm. per unit	COL m2
------------------	--------

Upholstered seat and back Asiento y respaldo tapizado

1 units	85	1,75
10 units or more	80	

Upholstered seat Asiento tapizado

1 units	60	1,25
10 units or more	50	

- 0,34 m3
- 22,8 kg
- x2
- 8

€ TP
231

Thermo-polymer shell
Carcasa termopolímero



Upholstered seat and back
Asiento y respaldo tapizado

COM	COL	1	2	3	4	5	6	7	8	9	10	11	L1	L2	L3	L6
420	427	436	445	455	465	477	489	500	512	523	535	546	556	600	676	877



Upholstered seat
Asiento tapizado

COM	COL	1	2	3	4	5	6	7	8	9	10	11	L1	L2	L3	L6
325	329	334	340	345	352	358	363	369	375	382	389	396	400	423	466	576

Parallel stitching upholstery upcharge (Seat and back)
Incremento tapizado con costuras paralelas (Asiento y respaldo) | 59 |



Parallel stitching upholstery upcharge (Seat)
Incremento tapizado con costuras paralelas (Asiento) | 30 |

SI1206



Sit Wood. Stackable chair with oak board seat and backrest and 4-legs tubular steel base available in several colors. Optional upholstered seat (includes a stacking protector) or upholstered seat and back. Optional parallel stitching upholstery for seat.

Sit Wood. Silla apilable con asiento y respaldo de tablero de roble y base de 4 patas de tubo de acero disponible en diferentes colores. Opción de asiento tapizado (incluido protector de apilado) o asiento y respaldo tapizado. Opción de asiento tapizado con costura paralelas.

COM cm. per unit	COL m2
------------------	--------

Upholstered seat Asiento tapizado

1 units	60	1,25
10 units or more	50	

- 0,33 m3
- 34,8 kg
- x4
- 5
- 10

€ 321

Oak
Roble



Upholstered seat
Asiento tapizado

COM	COL	1	2	3	4	5	6	7	8	9	10	11	L1	L2	L3	L6
394	399	405	410	415	422	429	436	443	450	457	464	471	476	501	546	672

SERIE 600
Matte lacquered and premium upcharge
Incremento por lacado mate y premium | 17 |



Parallel stitching upholstery upcharge (Seat)
Incremento tapizado con costuras paralelas (Asiento) | 30 |

SI1207

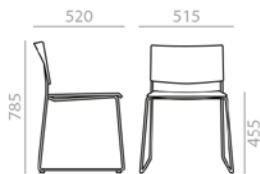

Sit Wood. Stackable chair with oak board seat and backrest and steel sled base finished in polished chrome, white or black. Optional upholstered seat (includes a stacking protector). Optional parallel stitching upholstery for seat.

Sit Wood. Silla apilable con asiento y respaldo de tablero de roble y base de patín de varilla de acero en acabado cromo brillo, blanco o negro. Opción de asiento tapizado (incluido protector de apilado). Opción de asiento tapizado con costuras paralelas.

COM cm. per unit	COL m2
------------------	--------

0,33 m3

37,6 kg

x4

Upholstered seat Asiento tapizado

1 units	60	1,25
10 units or more	50	

5

10



332

Oak
Roble



Upholstered seat
Asiento tapizado

COM	COL	1	2	3	4	5	6	7	8	9	10	11	L1	L2	L3	L6
362	367	374	380	384	391	399	405	413	420	428	434	442	449	475	523	649



Matte lacquered and premium upcharge
Incremento por lacado mate y premium

17



Parallel stitching upholstery upcharge (Seat)
Incremento tapizado con costuras paralelas (Asiento)

30

SO1208



Sit Wood. Stackable armchair with oak board seat and backrest and 4-legs tubular steel base available in several colors. Optional upholstered seat (includes a stacking protector) or upholstered seat and back. Optional parallel stitching upholstery for seat.

Sit Wood. Sillón apilable con asiento y respaldo de tablero de roble y base de 4 patas de tubo de acero disponible en diferentes colores. Opción de asiento tapizado (incluido protector de apilado) o asiento y respaldo tapizado. Opción de asiento tapizado con costuras paralelas.

COM cm. per unit	COL m2
------------------	--------

0,44 m3

41,2 kg

x4

Upholstered seat Asiento tapizado

1 units	60	1,25
10 units or more	50	

5

10



393

Oak
Roble



Upholstered seat
Asiento tapizado

COM	COL	1	2	3	4	5	6	7	8	9	10	11	L1	L2	L3	L6
546	552	558	564	569	576	585	593	600	607	615	622	630	637	664	715	849



Matte lacquered and premium upcharge
Incremento por lacado mate y premium

24



Parallel stitching upholstery upcharge (Seat)
Incremento tapizado con costuras paralelas (Asiento)

30

BQ1209

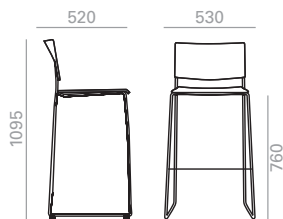

Sit Wood. Stackable barstool with oak board seat and backrest and steel sled base finished in polished chrome, white or black. Optional upholstered seat (includes a stacking protector). Optional parallel stitching upholstery for seat.

Sit Wood. Banqueta alta apilable con asiento y respaldo de tablero de roble y base de patin de varilla de acero en acabado cromo brillo, blanco o negro. Opción de asiento tapizado (incluido protector de apilado). Opción de asiento tapizado con costuras paralelas.

COM cm. per unit	COL m2
------------------	--------

- 0,35 m3
- 25 kg
- x2
- 8

Upholstered seat Asiento tapizado		1,25
1 units	60	
10 units or more	50	



439

€

Oak
Roble



Upholstered seat
Asiento tapizado

COM	COL	1	2	3	4	5	6	7	8	9	10	11	L1	L2	L3	L6
572	578	585	593	597	604	613	621	630	639	646	655	663	670	700	755	899



Matte lacquered and premium upcharge
Incremento por lacado mate y premium

17



Parallel stitching upholstery upcharge (Seat)
Incremento tapizado con costuras paralelas (Asiento)

30

BQ1210

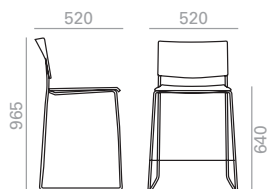

Sit Wood. Stackable counter stool with oak board seat and backrest and steel sled base finished in polished chrome, white or black. Optional upholstered seat (includes a stacking protector). Optional parallel stitching upholstery for seat.

Sit Wood. Banqueta baja apilable con asiento y respaldo de tablero de roble y base de patin de varilla de acero en acabado cromo brillo, blanco o negro. Opción de asiento tapizado (incluido protector de apilado). Opción de asiento tapizado con costuras paralelas.

COM cm. per unit	COL m2
------------------	--------

- 0,34 m3
- 24,8 kg
- x2
- 8

Upholstered seat Asiento tapizado		1,25
1 units	60	
10 units or more	50	



439

€

Oak
Roble



Upholstered seat
Asiento tapizado

COM	COL	1	2	3	4	5	6	7	8	9	10	11	L1	L2	L3	L6
572	578	585	593	597	604	613	621	630	639	646	655	663	670	700	755	899



Matte lacquered and premium upcharge
Incremento por lacado mate y premium

17



Parallel stitching upholstery upcharge (Seat)
Incremento tapizado con costuras paralelas (Asiento)

30

Sit accessories / Accesorios Sit

 0,01 m3

 3,2 kg

 1

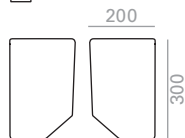

Removable right and left desk accessory for chair with panic latch rotation. HPL finished in polished chrome, black or white surface 4-leg frames with writing supports can be stacked up to 4 units deep. Available for models: SI1206.

Pala de escritura derecha e izquierda desmontable para sillas con rotación antipánico. Tablero HPL acabado cromo brillo, blanco o negro. Las estructuras de 4 patas con pala apilan hasta un máximo de 4 unidades. Válido para los modelos: SI1206.

DR-0802

Left Izquierda € 97

DL-0803

€

 0,0029 m3

 0,2 kg

 1

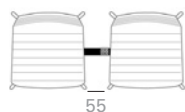

LD0807

4 legs frame Estructura 4 patas € 15
SI1206

Removable thermo-polymer linking device of available for chairs.

Sistema de unión de Termopolímero desmontable válido para sillas. Se puede ocultar debajo del asiento.

 0,0043 m3

 0,3 kg

 1

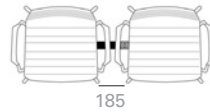

LD0809

4 legs frame Estructura 4 patas € 16
SO1208

Removable thermo-polymer linking device of available for armchairs.

Sistema de unión de Termopolímero desmontable válido para sillones. Se puede ocultar debajo del asiento.



Glides for sled bases/cantilever. Tacos para bases de patín/cantilever.

Use/Usó	Reference/Referencia		Material/Material	Price/Precio	
Hard floors. Suelos duros.	TS0531		Plastic (PE). Plástico (PE).	0 €	Standard. Estándar.
Wooden and delicate floors. Suelos de madera y delicados.	TS0538		Plastic (PE) with felt. Plástico (PE) con fieltro.	6 €	Set of 4 glides. Juego de 4 tacos.
Mats/carpet floors. Suelos de moqueta/ alfombra.	TS0537		No glide. Sin taco.	0 €	

The indicated price is for glides placed on chairs. To order loose parts, please ask to our Sales Department.

El precio indicado en Tarifa es para tacos colocados en las sillas. Para pedidos de tacos sueltos de repuesto, consultar con el Departamento Comercial.

Glides for 4 metal legs base. Tacos para bases de 4 patas metálicas.

Use/Usó	Reference/Referencia		Material/Material	Price/Precio	
Hard floors. Suelos duros.	TS0558		Plastic (PE). Plástico (PE).	0 €	Standard. Estándar.
Wooden and delicated floors. Suelos de madera y delicados.	TS0534		Plastic (PE) with felt. Plástico (PE) con fieltro.	4 €	Set of 4 glides. Juego de 4 tacos.
Mats/carpet floors. Suelos de moqueta/ alfombra.	TS0559		Metal. Metal.	4 €	Set of 4 glides. Juego de 4 tacos.

The indicated price is for glides placed on chairs. To order loose parts, please ask to our Sales Department.

El precio indicado en Tarifa es para tacos colocados en las sillas. Para pedidos de tacos sueltos de repuesto, consultar con el Departamento Comercial.

Sit stackability



SI1206 AU SOL
5 unités
510 x 665 x 1060 mm.

Tapissé
5 unités
510 x 600 x 1005 mm.

SUR CHARRIOT
10 unités
560 x 850 x 1260 mm.

Tapissé
10 unités
510 x 600 x 1005 mm.



SO1208 AU SOL
5 unités
610 x 605 x 975 mm.

Tapissé
5 unités
610 x 600 x 1005 mm.

SUR CHARRIOT
10 unités
560 x 850 x 1260 mm.

Tapissé
10 unités
610 x 600 x 1005 mm.



BQ1209 AU SOL
5 unités
510 x 655 x 1375 mm.

Tapissé
4 unités
510 x 570 x 1260 mm.





BQ1210 AU SOL
5 unités
510 x 655 x 1245 mm.

Tapissé
4 unités
510 x 570 x 1130 mm.

CA5004

Metallic trolley for transport stackable seating.
Carro metálico para transportar asientos apilables.

 0,39 m3

 14 kg

 x1

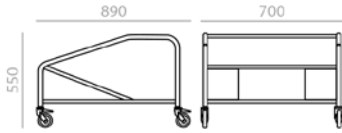

€ 216

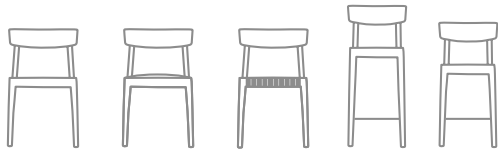

Description
Descripción

Stacking chair and barstool with frame and back made of solid beech wood and seat in oak, upholstered or with woven bands.

Silla apilable y banqueta con asiento cinchado, tapizado o en tablero de roble y respaldo de madera maciza de haya y estructura de madera maciza de haya.

Upholstery
Tapicería

The Smart collection supports following upholsteries of Andreu World Catalogue. For fabrics in our catalogue not specified in this box or customers own materials please contact our Customer Service Department.

La colección Smart admite las siguientes tapicerías del catálogo de Andreu World. Para las telas de nuestro catálogo no indicadas en este cuadro o telas cliente, consultar con nuestro Departamento Comercial.

Fabrics / Telas

- 1** Soft-fiber
Jacquard One
Jacquard Three
Citadel
Sand
Era
Gravity
Rivet
Urban
Reel One (in/out)
Spin One
Spin Two
Spin Three
Spin Four
Spin Five
- 2** Jacquard Two
Solid & Stripes
Loom One
Circular One Pure Eco
Tack One (in/out)

- 3** Jacquard Four
Medley
Revive 1
Natte
Main Line Flax
Loom Two (in/out)
Mezzo
Reel two (in/out)
Jacquard Five

- 4** Jacquard 4 Special
Nexus
Field 2
Remix 3
Heritage
Savane
Loom Three
Loom Four
Cura
Oceanic
Reel Three (in/out)
Reel Four (in/out)
Reflect
Spin Six

- 5** Silk
Synergy
Step
Step Melange
Blazer
Melange Nap
Chili
Noma
Re-wool

- 6** Go check
Swing
Chartres
Zori
Patio
Tack Two (in/out)
Tack Three (in/out)

- 7** Canvas 2
Select
Clara 2
Tack Five (in/out)
Hero 2

- 8** Capture
Fiord 2
Tonus 4
Divina 3
Lopi
Domino
Atrium
- 9** Divina MD
Divina Melange 3
Hallingdal 65
Steelcut Trio 3
Tack Four (in/out)

- 11** Arda
Ecriture
Zero

Faux Leather / Ecopiel

- 1** Valencia
- 2** Silvertex
- 3** Maglia
- 4** Dolce
- 8** Ultraleather
- 9** Brisa
Brisa Distressed
Fresco
Ultraleather Pro
Promessa

- 10** Tottori
Coast (in/out)

- 11** Reef Pro
Volar Bio

Leather / Piel

- L1** High grade cow leather.
Piel de vaca de 1ª categoría.
- L3** Polished full grain leather.
Piel de vaca pulida.
- L6** Aniline leather batique-effect.
Scandinavian cattle.
Piel anilina efecto batique.
Ganado escandinavo.

Woven finish

Acabado de cincha



Wood finish Beech

Acabado madera Haya

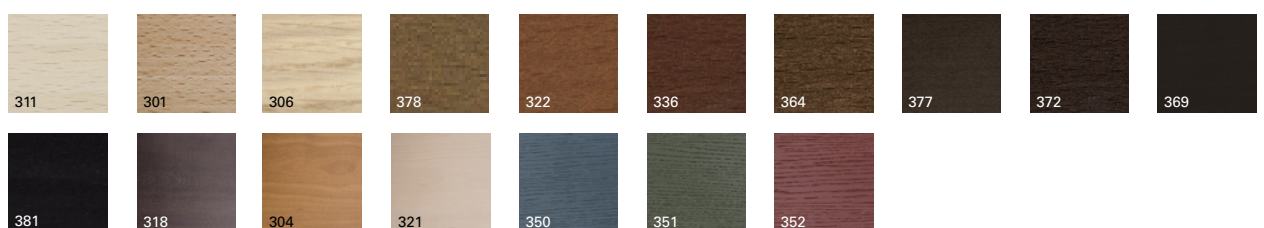

Certificates
Certificados

Fireproof polyurethane foam

Espuma de poliuretano ignífuga

UNE EN 1021:2006
BS 5852 part 2 crib 5
UNI 9175 Classe 1 IM
BKZ 5.2
California TB 117:2013
California TB 133*

*Contact our Customer Department
*Consultar con nuestro Departamento Comercial

Quality - Resistance
Calidad - Resistencia

UNE EN 16139:2013

Intellectual property Propiedad intelectual

All our collections are protected by international industrial design registries, designs patents, copyrights and intellectual Property laws. Unauthorized use of AW International Property is a criminal offence and can lead to prosecution.

Todas nuestras colecciones están protegidas por registros de diseño industrial, diseño de patente, copyright y derechos de propiedad intelectual todo el mundo. El uso no autorizado de los diseños y propiedad intelectual de AW supone un delito que puede ser sometido a acción judicial.



SI0610

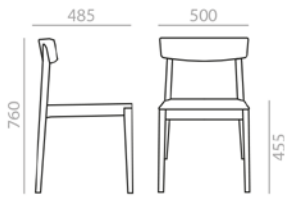

Stackable chair with oak board seat and backrest and solid beech wood frame. Minimum order per color: 4 units.
Silla apilable con asiento de tablero de roble y respaldo y estructura de madera maciza de haya. Pedido mínimo por color: 4 unidades.

- 0,39 m3
- 26,8 kg
- x4
- 8
- 12

€ 256

SI0612

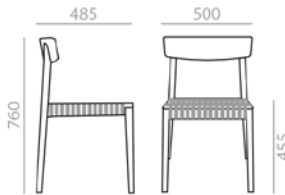

Stackable chair with seat webbing in matching wood and solid beech wood backrest and frame. Minimum order per color: 4 units.
Silla apilable con asiento cinchado en color al tono de la madera y estructura y respaldo de madera maciza de haya. Pedido mínimo por color: 4 unidades.

- 0,39 m3
- 24 kg
- x4
- 8
- 12

€ 256

SI0611

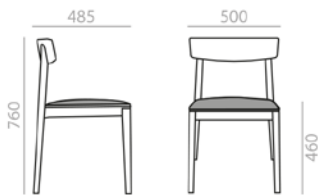

Stackable chair with upholstered seat and solid beech wood backrest and frame. Minimum order per color: 4 units.
Silla apilable con asiento tapizado y respaldo y estructura de madera maciza de haya. Pedido mínimo por color: 4 unidades.

	COM cm. per unit	COL m2
1 units	58	1,25
10 units or more	29	

- 0,27 m3
- 16,6 kg
- x2
- 6
- 12

€	COM	COL	1	2	3	4	5	6	7	8	9	10	11	L1	L2	L3	L6
	366	369	372	375	378	382	385	390	394	397	401	406	409	413	426	452	597

BQ0637

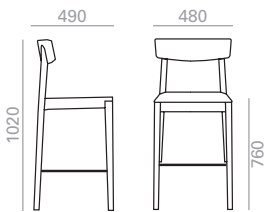

Barstool with oak board seat and backrest and solid beech wood frame. Minimum order per color: 4 units.
Banqueta alta con asiento de tablero de roble y respaldo y estructura de madera maciza de haya. Pedido mínimo por color: 4 unidades. Pedido mínimo por color: 4 unidades.

- 0,28 m3
- 7,7 kg
- x1

€ 375

BQ0651

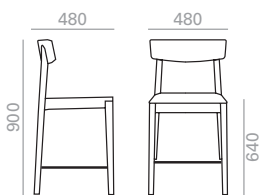

Counter stool with oak board seat and backrest and solid beech wood frame. Minimum order per color: 4 units.
Banqueta baja con asiento de tablero de roble y respaldo y estructura de madera maciza de haya. Pedido mínimo por color: 4 unidades.

- 0,25 m3
- 7,5 kg
- x1

€ 375

BQ0644

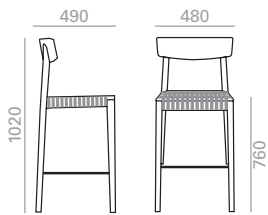

Barstool with seat webbing in matching wood and solid beech wood backrest and frame. Minimum order per color: 4 units.

Banqueta alta con asiento cinchado en color al tono de la madera y estructura y respaldo de madera maciza de haya. Pedido mínimo por color: 4 unidades. Pedido mínimo por color: 4 unidades.

0,25 m3
7 kg
x1

€ 375

BQ0658

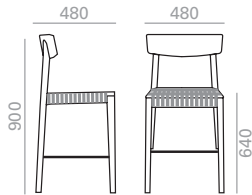

Counter stool with seat webbing in matching wood and solid beech wood backrest and frame. Minimum order per color: 4 units.

Banqueta baja con asiento cinchado en color al tono de la madera y estructura y respaldo de madera maciza de haya. Pedido mínimo por color: 4 unidades.

0,25 m3
6,8 kg
x1

€ 375

BQ0649

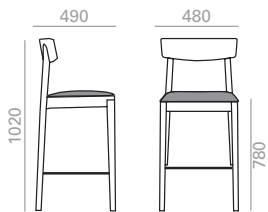

Barstool with upholstered seat and solid beech wood backrest and frame. Minimum order per color: 4 units.

Banqueta alta con asiento tapizado y respaldo y estructura de madera maciza de haya. Pedido mínimo por color: 4 unidades. Pedido mínimo por color: 4 unidades.

	COM cm. per unit	COL m2
1 units	55	1,25
10 units or more	28	

0,29 m3
8,7 kg
x1

€	COM	COL	1	2	3	4	5	6	7	8	9	10	11	L1	L2	L3	L6
	487	490	493	496	499	502	506	511	514	518	521	525	528	533	546	571	732

BQ0659

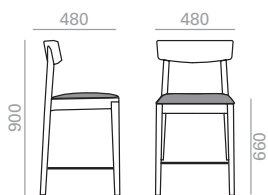

Counter stool with upholstered seat and solid beech wood backrest and frame. Minimum order per color: 4 units.

Banqueta baja con asiento tapizado y respaldo y estructura de madera maciza de haya. Pedido mínimo por color: 4 unidades.

	COM cm. per unit	COL m2
1 units	55	1,25
10 units or more	28	

0,25 m3
8,3 kg
x1

€	COM	COL	1	2	3	4	5	6	7	8	9	10	11	L1	L2	L3	L6
	487	490	493	496	499	502	506	511	514	518	521	525	528	533	546	571	732

For wooden legs. Para bases de madera.

SI0611, BQ0649, BQ0659



Optional glides on page 482.
Opciones de tacos deslizantes en página 482.

SI0611, SI0612, BQ0637, BQ0651, BQ0644, BQ0658



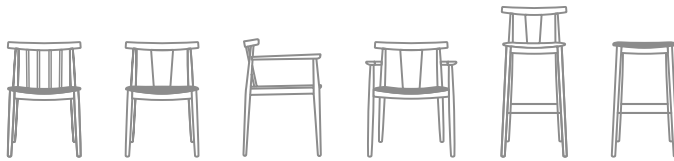

Description
Descripción

Stacking chairs, armchair and stool with frame and back made of beech wood and oak wood or upholstered seat. Two different back options are spindle back or board wood back.
Silla, sillón y banquetas con asiento de tablero de roble o tablero tapizado y respaldo de varillas de madera maciza de haya o de tablero de roble. Brazos y estructura de madera maciza de haya.

Upholstery
Tapicería

The Smile collection supports all upholsteries of Andreu World Catalogue. For custom own materials, contact our Customer Department.
La colección Smile admite todas las telas del catálogo de Andreu World. Para telas cliente, consultar con nuestro Departamento Comercial.

Fabrics / Telas

- 1** Soft-fiber
Jacquard One
Jacquard Three
Citadel
Sand
Era
Gravity
Rivet
Urban
Reel One (in/out)
Spin One
Spin Two
Spin Three
Spin Four
Spin Five
- 2** Jacquard Two
Solid & Stripes
Loom One
Circular One Pure Eco
Tack One (in/out)

- 3** Jacquard Four
Medley
Revive 1
Natte
Main Line Flax
Loom Two (in/out)
Mezzo
Reel two (in/out)
Jacquard Five

- 4** Jacquard 4 Special
Nexus
Field 2
Remix 3
Heritage
Savane
Loom Three
Loom Four
Cura
Oceanic
Reel Three (in/out)
Reel Four (in/out)
Reflect
Spin Six

- 5** Silk
Synergy
Step
Step Melange
Blazer
Melange Nap
Chili
Noma
Re-wool
- 6** Go check
Swing
Chartres
Zori
Patio
Tack Two (in/out)
Tack Three (in/out)

- 7** Canvas 2
Select
Clara 2
Tack Five (in/out)
Hero 2

- 8** Capture
Fiord 2
Tonus 4
Divina 3
Lopi
Domino
Atrium
- 9** Divina MD
Divina Melange 3
Hallingdal 65
Steelcut Trio 3
Tack Four (in/out)

- 11** Arda
Ecriture
Zero

Faux Leather / Ecopiel

- 1** Valencia
- 2** Silververtex
- 3** Maglia
- 4** Dolce
- 8** Ultraleather
- 9** Brisa
Brisa Distressed
Fresco
Ultraleather Pro
Promessa
- 10** Tottori
Coast (in/out)
- 11** Reef Pro
Volar Bio

Leather / Piel

- L1** High grade cow leather.
Piel de vaca de 1ª categoría.
- L3** Polished full grain leather.
Piel de vaca pulida.
- L6** Aniline leather batique-effect.
Scandinavian cattle.
Piel anilina efecto batique.
Ganado escandinavo.

Hide Leather / Cuero

- L2** Chrome tanned split leather.
Base in polyurethane resin
emulsion in water. Cellulose
nitric varnish.
Costra cocida al cromo. Base
de emulsiones de resinas
poliuretánicas en agua. Barniz
nitro celulósico.

Wood finish Beech
Acabado madera Haya

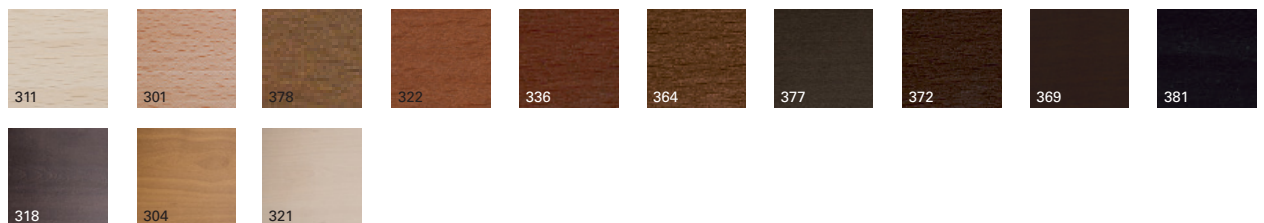

Premium finish and wood lacquers
Acabado premium y lacas madera



Leather finish
Acabado de cuero



Certificates
Certificados

Fireproof polyurethane foam
Espuma de poliuretano ignifuga

UNE EN 1021:2006
BS 5852 part 2 crib 5
UNI 9175 Classe 1 IM
BKZ 5.2
California TB 117:2013
California TB 133*

*Contact our Customer Department
*Consultar con nuestro Departamento Comercial

Quality - Resistance
Calidad - Resistencia

UNE EN 16139:2013

Intellectual property Propiedad intelectual

All our collections are protected by international industrial design registries, designs patents, copyrights and intellectual Property laws. Unauthorized use of AW International Property is a criminal offence and can lead to prosecution.
Todas nuestras colecciones están protegidas por registros de diseño industrial, diseño de patente, copyright y derechos de propiedad intelectual todo el mundo. El uso no autorizado de los diseños y propiedad intelectual de AW supone un delito que puede ser sometido a acción judicial.



SI0323

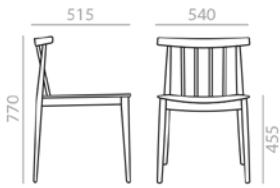

Stackable chair with oak board seat and solid beech wood spindle backrest and frame.
Silla apilable con asiento de tablero de roble, respaldo de varillas de madera maciza de haya y estructura de madera maciza de haya.

- 0,34 m3
- 13,4 kg
- x2
- 4
- 8

€ 445

SERIE 600	Matte lacquered and premium upcharge Incremento por lacado mate y premium	33	SERIE 800	Bright lacquered upcharge Incremento por lacado brillo	50
-----------	--	----	-----------	---	----

SI0324

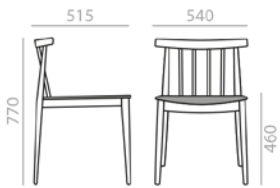

Stackable chair with upholstered seat and solid beech wood spindle backrest and frame. (L2) Hide Leather.
Silla apilable con asiento tapizado, respaldo de varillas de madera maciza de haya y estructura de madera maciza de haya. (L2) Cuero.

	COM cm. per unit	COL m2
1 units	58	1,25
10 units or more	29	

- 0,34 m3
- 14,8 kg
- x2
- 4
- 8

€	COM	COL	1	2	3	4	5	6	7	8	9	10	11	L1	L2	L3	L6
	374	378	381	385	388	392	396	400	404	408	412	416	420	423	437	464	535

SERIE 600	Matte lacquered and premium upcharge Incremento por lacado mate y premium	30	SERIE 800	Bright lacquered upcharge Incremento por lacado brillo	44
-----------	--	----	-----------	---	----

SI0325

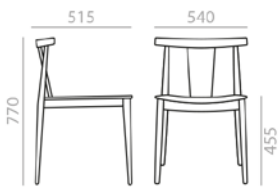

Stackable chair with oak board seat and backrest and solid beech wood frame.
Silla apilable con asiento y respaldo de tablero de roble y estructura de madera maciza de haya.

- 0,34 m3
- 13,4 kg
- x2
- 4
- 8

€ 434

SERIE 600	Matte lacquered and premium upcharge Incremento por lacado mate y premium	32	SERIE 800	Bright lacquered upcharge Incremento por lacado brillo	47
-----------	--	----	-----------	---	----

SI0326

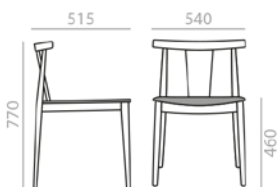

Stackable chair with upholstered seat, oak board backrest and solid beech wood frame. (L2) Hide Leather.
Silla apilable con asiento tapizado, respaldo de tablero de roble y estructura de madera maciza de haya. (L2) Cuero.

	COM cm. per unit	COL m2
1 units	58	1,25
10 units or more	29	

- 0,34 m3
- 14,8 kg
- x2
- 4
- 8

€	COM	COL	1	2	3	4	5	6	7	8	9	10	11	L1	L2	L3	L6
	360	364	367	371	374	378	382	386	390	394	398	402	406	410	425	451	521

SERIE 600	Matte lacquered and premium upcharge Incremento por lacado mate y premium	27	SERIE 800	Bright lacquered upcharge Incremento por lacado brillo	41
-----------	--	----	-----------	---	----

SO0333

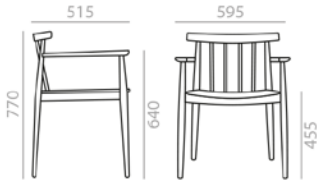

Armchair with oak board seat and solid beech wood spindle backrest and frame.
Sillón con asiento tablero de roble, respaldo de varillas de madera maciza de haya y estructura de madera maciza de haya.

0,27 m3
 7,9 kg
 x1

€ 540

SERIE 600	Matte lacquered and premium upcharge Incremento por lacado mate y premium	38	SERIE 800	Bright lacquered upcharge Incremento por lacado brillo	56
-----------	--	----	-----------	---	----

SO0334

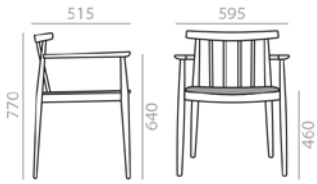

Armchair with upholstered seat and solid beech wood spindle backrest and frame. (L2) Hide Leather.
Sillón con asiento tapizado, respaldo de varillas de madera maciza de haya y estructura de madera maciza de haya. (L2) Cuero.

	COM cm. per unit	COL m2
1 units	58	1,25
10 units or more	29	

0,27 m3
 8,7 kg
 x1

COM	COL	1	2	3	4	5	6	7	8	9	10	11	L1	L2	L3	L6
€ 457	461	464	468	471	475	479	483	487	491	495	499	503	507	521	549	621

SERIE 600	Matte lacquered and premium upcharge Incremento por lacado mate y premium	33	SERIE 800	Bright lacquered upcharge Incremento por lacado brillo	50
-----------	--	----	-----------	---	----

SO0335

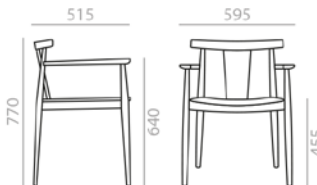

Armchair with oak board seat and backrest and solid beech wood frame.
Sillón con asiento y respaldo de tablero de roble y estructura de madera maciza de haya.

0,27 m3
 7,9 kg
 x1

€ 529

SERIE 600	Matte lacquered and premium upcharge Incremento por lacado mate y premium	35	SERIE 800	Bright lacquered upcharge Incremento por lacado brillo	53
-----------	--	----	-----------	---	----

SO0336

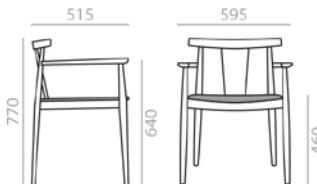

Armchair with upholstered seat, oak board backrest and solid beech wood frame. (L2) Hide Leather.
Sillón con asiento tapizado, respaldo de tablero de roble y estructura de madera maciza de haya. (L2) Cuero.

	COM cm. per unit	COL m2
1 units	58	1,25
10 units or more	29	

0,27 m3
 8,7 kg
 x1

COM	COL	1	2	3	4	5	6	7	8	9	10	11	L1	L2	L3	L6
€ 442	446	449	453	456	460	464	468	472	476	480	484	488	492	507	534	606

SERIE 600	Matte lacquered and premium upcharge Incremento por lacado mate y premium	32	SERIE 800	Bright lacquered upcharge Incremento por lacado brillo	47
-----------	--	----	-----------	---	----

BQ0327

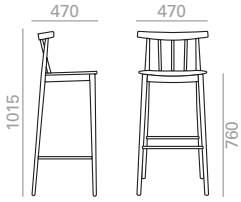

Barstool with oak board seat, solid beech wood spindle backrest and frame.
 Banqueta alta con asiento tablero de roble, respaldo de varillas de madera maciza de haya y estructura de madera maciza de haya.

0,25 m3
 7,5 kg
 x1

€ 535

SERIE 600	Matte lacquered and premium upcharge Incremento por lacado mate y premium	33	SERIE 800	Bright lacquered upcharge Incremento por lacado brillo	50
-----------	--	----	-----------	---	----

BQ0328

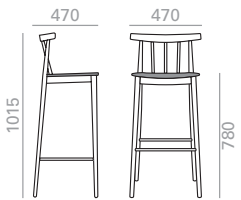

Barstool with upholstered seat, solid beech wood spindle backrest and frame. (L2) Hide Leather.
 Banqueta alta con asiento tapizado, respaldo de varillas de madera maciza de haya y estructura de madera maciza de haya. (L2) Cuero.

	COM cm. per unit	COL m2
1 units	55	1,25
10 units or more	28	

0,25 m3
 8,3 kg
 x1

COM	COL	1	2	3	4	5	6	7	8	9	10	11	L1	L2	L3	L6
€ 485	487	490	494	495	499	503	507	512	514	518	522	526	530	544	569	643

SERIE 600	Matte lacquered and premium upcharge Incremento por lacado mate y premium	30	SERIE 800	Bright lacquered upcharge Incremento por lacado brillo	44
-----------	--	----	-----------	---	----

BQ0346

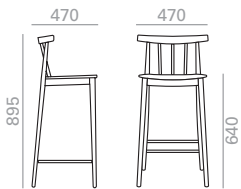

Counter stool with oak board seat, solid beech wood spindle backrest and frame.
 Banqueta baja con asiento tablero de roble, respaldo de varillas de madera maciza de haya y estructura de madera maciza de haya.

	COM cm. per unit	COL m2
1 units	55	1,25
10 units or more	28	

0,22 m3
 7 kg
 x1

€ 535

SERIE 600	Matte lacquered and premium upcharge Incremento por lacado mate y premium	33	SERIE 800	Bright lacquered upcharge Incremento por lacado brillo	50
-----------	--	----	-----------	---	----

BQ0347



Counter stool with upholstered seat, solid beech wood spindle backrest and frame. (L2) Hide Leather.
 Banqueta baja con asiento tapizado, respaldo de varillas de madera maciza de haya y estructura de madera maciza de haya. (L2) Cuero.

	COM cm. per unit	COL m2
1 units	55	1,25
10 units or more	28	

0,22 m3
 7,8 kg
 x1

COM	COL	1	2	3	4	5	6	7	8	9	10	11	L1	L2	L3	L6
€ 485	487	490	494	495	499	503	507	512	514	518	522	526	530	544	569	643

SERIE 600	Matte lacquered and premium upcharge Incremento por lacado mate y premium	30	SERIE 800	Bright lacquered upcharge Incremento por lacado brillo	44
-----------	--	----	-----------	---	----





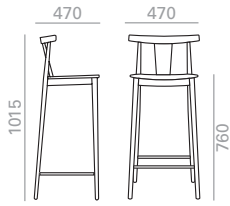

Haya
Beech

Measures +- 5 mm.
Medidas +- 5 mm.

BQ0337



 Barstool with oak board seat and backrest and solid beech wood frame.
Banqueta alta con asiento y respaldo de tablero de roble y estructura de madera maciza de haya.

 0,25 m3
 7,5 kg
 x1

€ 552

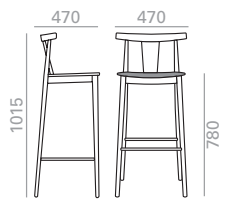

SERIE 600	Matte lacquered and premium upcharge Incremento por lacado mate y premium	33	SERIE 800	Bright lacquered upcharge Incremento por lacado brillo	50
-----------	--	----	-----------	---	----

BQ0338



 Barstool with upholstered seat and oak board backrest and solid beech wood frame. (L2) Hide Leather.
Banqueta alta con asiento tapizado, respaldo de tablero de roble y estructura de madera maciza de haya. (L2) Cuero.

	COM cm. per unit	COL m2
1 units	55	1,25
10 units or more	28	

 0,25 m3
 8,3 kg
 x1



€	COM	COL	1	2	3	4	5	6	7	8	9	10	11	L1	L2	L3	L6
	504	506	509	513	514	518	522	526	530	534	538	542	546	549	564	589	665

SERIE 600	Matte lacquered and premium upcharge Incremento por lacado mate y premium	30	SERIE 800	Bright lacquered upcharge Incremento por lacado brillo	44
-----------	--	----	-----------	---	----

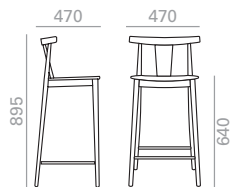
BQ0348



 Counter stool with oak board seat and backrest and solid beech wood frame.
Banqueta baja con asiento y respaldo de tablero de roble y estructura de madera maciza de haya.

 0,22 m3
 7 kg
 x1

€ 552

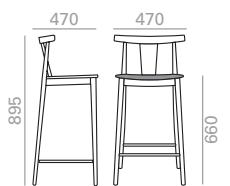

SERIE 600	Matte lacquered and premium upcharge Incremento por lacado mate y premium	33	SERIE 800	Bright lacquered upcharge Incremento por lacado brillo	50
-----------	--	----	-----------	---	----

BQ0349



 Counter stool with upholstered seat and oak board backrest and solid beech wood frame. (L2) Hide Leather.
Banqueta baja con asiento tapizado, respaldo de tablero de roble y estructura de madera maciza de haya. (L2) Cuero.

	COM cm. per unit	COL m2
1 units	55	1,25
10 units or more	28	

 0,22 m3
 7,8 kg
 x1

€	COM	COL	1	2	3	4	5	6	7	8	9	10	11	L1	L2	L3	L6
	504	506	509	513	514	518	522	526	530	534	538	542	546	549	564	589	665

SERIE 600	Matte lacquered and premium upcharge Incremento por lacado mate y premium	30	SERIE 800	Bright lacquered upcharge Incremento por lacado brillo	44
-----------	--	----	-----------	---	----

BQ0329

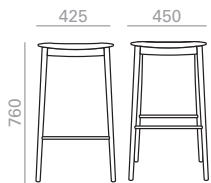

Backless barstool with oak board seat and solid beech wood frame.

Banqueta alta sin respaldo con asiento de tablero de roble y estructura de madera maciza de haya.

0,25 m³

14 kg

x2

€ 428

SERIE 600 Matte lacquered and premium upcharge
Incremento por lacado mate y premium | 30 |

SERIE 800 Bright lacquered upcharge
Incremento por lacado brillo | 44 |

BQ0339

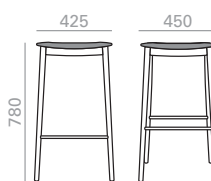

Backless barstool with upholstered seat and solid beech wood frame. (L2) Hide Leather.

Banqueta alta sin respaldo con asiento tapizado y estructura de madera maciza de haya. (L2) Cuero.

	COM cm. per unit	COL m ²
1 units	55	1,25
10 units or more	28	

0,26 m³

15,6 kg

x2

€

COM	COL	1	2	3	4	5	6	7	8	9	10	11	L1	L2	L3	L6
381	384	388	392	395	400	404	410	414	419	423	429	433	437	454	485	568

SERIE 600 Matte lacquered and premium upcharge
Incremento por lacado mate y premium | 26 |

SERIE 800 Bright lacquered upcharge
Incremento por lacado brillo | 38 |

BQ0351

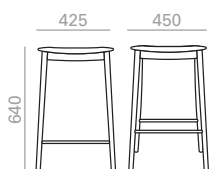

Backless counter stool with oak board seat and solid beech wood frame.

Banqueta baja sin respaldo con asiento de tablero de roble y estructura de madera maciza de haya.

0,22 m³

13 kg

x2

€ 428

SERIE 600 Matte lacquered and premium upcharge
Incremento por lacado mate y premium | 30 |

SERIE 800 Bright lacquered upcharge
Incremento por lacado brillo | 44 |

BQ0350



Backless counter stool with upholstered seat and solid beech wood frame. (L2) Hide Leather.

Banqueta baja sin respaldo con asiento tapizado y estructura de madera maciza de haya. (L2) Cuero.

	COM cm. per unit	COL m ²
1 units	55	1,25
10 units or more	28	

0,27 m³

14,6 kg

x2

€

COM	COL	1	2	3	4	5	6	7	8	9	10	11	L1	L2	L3	L6
381	384	388	392	395	400	404	410	414	419	423	429	433	437	454	485	568

SERIE 600 Matte lacquered and premium upcharge
Incremento por lacado mate y premium | 26 |

SERIE 800 Bright lacquered upcharge
Incremento por lacado brillo | 38 |



Haya
Beech

Measures +- 5 mm.
Medidas +- 5 mm.

For wooden legs. Para bases de madera.



Optional glides on page 482.

Opciones de tacos deslizantes en página 482.

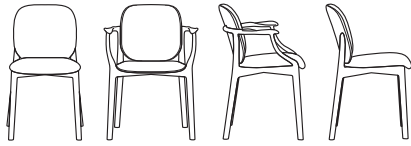

Description
Descripción

Stackable chair and armchair with oak board seat and backrest and solid beech wood frame. Option of upholstered seat and backrest or upholstered seat and backrest. Wide version of chair and armchair available.
Silla y sillón apilable con asiento y respaldo de tablero de roble y estructura de madera maciza de haya. Opción de asiento y respaldo tapizado o asiento y respaldo plafonado. Disponible versión ancha de silla y sillón.

Upholstery
Tapicería

The Solo Chair collection supports following upholsteries of Andreu World Catalogue. For fabrics in our catalogue not specified in this box or customers own materials please contact our Customer Service Department.

La colección Solo Chair admite las siguientes tapicerías del catálogo de Andreu World. Para las telas de nuestro catálogo no indicadas en este cuadro o telas cliente, consultar con nuestro Departamento Comercial.

Fabrics / Telas

- 1** Soft-fiber
Jacquard One
Jacquard Three
Citadel
Sand
Era
Gravity
Rivet
Urban
Reel One (in/out)
Spin One
Spin Two
Spin Three
Spin Four
Spin Five
- 2** Jacquard Two
Solid & Stripes
Loom One
Circular One Pure Eco
Tack One (in/out)

- 3** Jacquard Four
Medley
Revive 1
Natte
Main Line Flax
Loom Two (in/out)
Mezzo
Reel two (in/out)
Jacquard Five
- 4** Jacquard 4 Special
Nexus
Field 2
Remix 3
Heritage
Savane
Loom Three
Loom Four
Cura
Oceanic
Reel Three (in/out)
Reel Four (in/out)
Reflect
Spin Six

- 5** Silk
Synergy
Step
Step Melange
Blazer
Melange Nap
Chili
Noma
Re-wool
- 6** Go check
Swing
Chartres
Zori
Patio
Tack Two (in/out)
Tack Three (in/out)
- 7** Canvas 2
Select
Clara 2
Tack Five (in/out)
Hero 2

- 8** Capture
Fiord 2
Tonus 4
Divina 3
Lopi
Domino
Atrium
- 9** Divina MD
Divina Melange 3
Hallingdal 65
Steelcut Trio 3
Tack Four (in/out)
- 11** Arda
Ecriture
Zero

Faux Leather / Ecopiel

- 1** Valencia
- 2** Silvertex
- 3** Maglia
- 4** Dolce
- 8** Ultraleather
- 9** Brisa
Brisa Distressed
Fresco
Ultraleather Pro
Promessa
- 10** Tottori
Coast (in/out)
- 11** Reef Pro
Volar Bio

Leather / Piel

- L1** High grade cow leather.
Piel de vaca de 1ª categoría.
- L3** Polished full grain leather.
Piel de vaca pulida.
- L6** Aniline leather batique-effect.
Scandinavian cattle.
Piel anilina efecto batique.
Ganado escandinavo.

Wood finish Beech
Acabado madera Haya



Certificates
Certificados

Fireproof polyurethane foam

Espuma de poliuretano ignifuga

UNE EN 1021:2006
BS 5852 part 2 crib 5
UNI 9175 Classe 1 IM
BKZ 5.2
California TB 117:2013
California TB 133*

*Contact our Customer Department
*Consultar con nuestro Departamento Comercial

Quality - Resistance
Calidad - Resistencia

UNE EN 16139:2013

Intellectual property Propiedad intelectual

All our collections are protected by international industrial design registries, designs patents, copyrights and intellectual Property laws. Unauthorized use of AW International Property is a criminal offence and can lead to prosecution.
Todas nuestras colecciones están protegidas por registros de diseño industrial, diseño de patente, copyright y derechos de propiedad intelectual en todo el mundo. El uso no autorizado de los diseños y propiedad intelectual de AW supone un delito que puede ser sometido a acción judicial.



SI3020

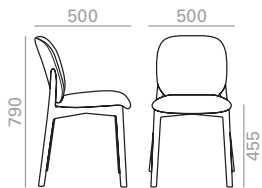

Stackable chair with oak board seat and backrest and solid beech wood. Option of fully upholstered shell or upholstered shell pad.

Silla apilable con asiento y respaldo de tablero de roble y estructura de madera maciza de haya. Opción de asiento y respaldo plafonado.

COM cm. per unit	COL m2
------------------	--------

0,3 m3
22 kg
x2

Fully upholstered Carcasa tapizada		
1 units	65	1,5
10 units or more	65	

Shell pad Asiento y respaldo plafonado		
1 units	65	1,5
10 units or more	65	

4
4



407

Beech Haya

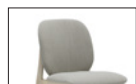

Fully upholstered Toda tapizada

COM	COL	1	2	3	4	5	6	7	8	9	10	11	L1	L2	L3	L6
397	403	410	417	421	430	438	446	455	463	471	480	488	495	524	579	722



Upholstered shell pad Asiento y respaldo plafonado

COM	COL	1	2	3	4	5	6	7	8	9	10	11	L1	L2	L3	L6
520	527	535	543	548	558	568	577	587	597	607	616	626	634	670	734	902

SO3021

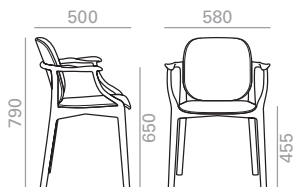

Stackable armchair with oak board seat and backrest and solid beech wood. Option of fully upholstered shell or upholstered shell pad.

Sillón apilable con asiento y respaldo de tablero de roble y estructura de madera maciza de haya. Opción de asiento y respaldo plafonado.

COM cm. per unit	COL m2
------------------	--------

0,38 m3
24 kg
x2

Fully upholstered Carcasa tapizada		
1 units	65	1,5
10 units or more	65	

Shell pad Asiento y respaldo plafonado		
1 units	65	1,5
10 units or more	65	

4
4



608

Beech Haya



Fully upholstered Toda tapizada

COM	COL	1	2	3	4	5	6	7	8	9	10	11	L1	L2	L3	L6
590	596	603	610	615	624	632	641	650	659	668	677	685	693	724	781	932



Upholstered shell pad Asiento y respaldo plafonado

COM	COL	1	2	3	4	5	6	7	8	9	10	11	L1	L2	L3	L6
711	718	726	734	739	749	759	769	778	788	798	808	818	826	862	926	1.094

SI3022

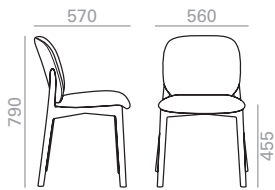

Stackable chair with oak board seat and backrest and solid beech wood. Wide version. Option of fully upholstered shell or upholstered shell pad.

Silla apilable con asiento y respaldo de tablero de roble y estructura de madera maciza de haya. Versión ancha. Opción de asiento y respaldo plafonado.

COM cm. per unit	COL m2
------------------	--------

0,41 m3
24 kg
x2

Fully upholstered Carcasa tapizada		2
1 units	100	
10 units or more	100	

Shell pad Asiento y respaldo plafonado		1,5
1 units	65	
10 units or more	65	

4
4



417

€

Beech Haya



Fully upholstered Toda tapizada

COM	COL	1	2	3	4	5	6	7	8	9	10	11	L1	L2	L3	L6
410	421	432	442	449	464	477	490	503	515	528	541	554	566	613	700	927



Upholstered shell pad Asiento y respaldo plafonado

COM	COL	1	2	3	4	5	6	7	8	9	10	11	L1	L2	L3	L6
530	537	545	553	558	568	578	587	597	607	617	627	636	644	680	744	912

SO3023

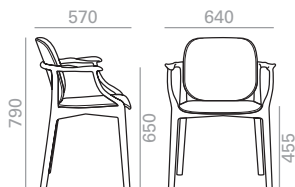

Stackable armchair with oak board seat and backrest and solid beech wood. Wide version. Option of fully upholstered shell or upholstered shell pad.

Sillón apilable con asiento y respaldo de tablero de roble y estructura de madera maciza de haya. Versión ancha. Opción de asiento y respaldo plafonado.

COM cm. per unit	COL m2
------------------	--------

0,4 m3
26 kg
x2

Fully upholstered Carcasa tapizada		2
1 units	100	
10 units or more	100	

Shell pad Asiento y respaldo plafonado		1,5
1 units	65	
10 units or more	65	

4
4



627

€

Beech Haya



Fully upholstered Toda tapizada

COM	COL	1	2	3	4	5	6	7	8	9	10	11	L1	L2	L3	L6
607	617	629	639	647	662	675	689	702	716	729	743	756	768	817	907	1.143



Upholstered shell pad Asiento y respaldo plafonado

COM	COL	1	2	3	4	5	6	7	8	9	10	11	L1	L2	L3	L6
728	735	743	751	756	766	776	785	795	805	815	825	834	843	879	942	1.111

For wooden legs. Para bases de madera.



Optional glides on page 482.

Opciones de tacos deslizantes en página 482.



Description
Descripción

Armchairs, lounge chairs and barstools with upholstered seat and back and steel sled base finished in polished chrome, white or black. Available armchair and lounge chair with 4 legs solid beech base.

Sillón, butacas y banqueta con asiento y respaldo tapizado y base de patín de acero en acabado cromo brillo, blanco o negro. Disponible sillón y butaca con base de 4 patas de madera maciza de haya.

Upholstery
Tapicería

The Tauro collection supports following upholsteries of Andreu World Catalogue. For fabrics in our catalogue not specified in this box or customers own materials please contact our Customer Service Department.

La colección Tauro admite las siguientes tapicerías del catálogo de Andreu World. Para las telas de nuestro catálogo no indicadas en este cuadro o telas cliente, consultar con nuestro Departamento Comercial.

Fabrics / Telas

- 1 Jacquard One
 - Jacquard Three
 - Citadel
 - Era
 - Gravity
 - Rivet
 - Urban
 - Spin One
 - Spin Two
 - Spin Three
 - Spin Four
 - Spin Five
- 2 Jacquard Two
 - Circular One Pure Eco
 - Tack One (in/out)

- 3 Jacquard Four
- Medley
- Revive 1
- Natte
- Main Line Flax
- Loom Two (in/out)
- Mezzo
- Reel two (in/out)
- Jacquard Five

- 4 Jacquard 4 Special
- Heritage
- Savane
- Loom Three
- Loom Four
- Cura
- Oceanic
- Reel Three (in/out)
- Reel Four (in/out)
- Reflect
- Spin Six

- 5 Silk
- Synergy
- Step
- Step Melange
- Blazer
- Melange Nap
- Chili
- Noma
- Re-wool

- 6 Go check
- Swing
- Nexus
- Chartres
- Zori
- Patio
- Tack Two (in/out)
- Tack Three (in/out)

- 7 Canvas 2
- Select
- Clara 2
- Tack Five (in/out)
- Hero 2

- 8 Capture
 - Fiord 2
 - Tonus 4
 - Divina 3
 - Lopi
 - Domino
- 9 Divina MD
 - Divina Melange 3
 - Hallingdal 65
 - Steelcut Trio 3
 - Tack Four (in/out)

- 11 Arda
- Ecriture
- Zero

Faux Leather / Ecopiel

- 1 Valencia
 - 2 Silvertex
 - 3 Maglia
 - 4 Dolce
 - 8 Ultraleather
- 9 Brisa
 - Brisa Distressed
 - Fresco
 - Ultraleather Pro
 - Promessa
- 10 Tottori
 - Coast (in/out)
- 11 Reef Pro
 - Voliar Bio

Leather / Piel

- L1 High grade cow leather.
 - Piel de vaca de 1ª categoría.
- L3 Polished full grain leather.
 - Plena flor pulida.
- L6 Aniline leather batique-effect.
 - Scandinavian cattle.
 - Piel anilina efecto batique.
 - Ganado escandinavo.

Wood finish Beech
Acabado madera Haya



Premium finish and wood lacquers
Acabado premium y lacas madera



Steel finish
Acabado de acero



Certificates
Certificados

Fireproof polyurethane foam
Espuma de poliuretano ignifuga

UNE EN 1021:2006
BS 5852 part 2 crib 5
UNI 9175 Classe 1 IM
BKZ 5.2
California TB 117:2013
California TB 133*

*Contact our Customer Department
*Consultar con nuestro Departamento Comercial

Quality - Resistance
Calidad - Resistencia

UNE EN 16139:2013

Intellectual property Propiedad intelectual

All our collections are protected by international industrial design registries, designs patents, copyrights and intellectual Property laws. Unauthorized use of AW International Property is a criminal offence and can lead to prosecution.

Todas nuestras colecciones están protegidas por registros de diseño industrial, diseño de patente, copyright y derechos de propiedad intelectual todo el mundo. El uso no autorizado de los diseños y propiedad intelectual de AW supone un delito que puede ser sometido a acción judicial.



SO4200

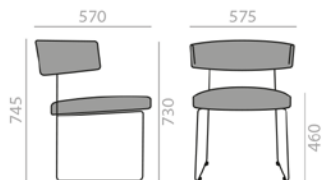

Armchair with upholstered seat and backrest and steel sled base finished in polished chrome white or black.
Sillón con asiento y respaldo tapizado y base de patín de acero en acabado cromo brillo, blanco o negro.

	COM cm. per unit	COL m2
1 units	160	3
10 units or more	100	

0,26 m3
 10,8 kg
 x1

€	COM	COL	1	2	3	4	5	6	7	8	9	10	11	L1	L2	L3	L6
	462	474	487	499	507	523	538	553	568	584	598	614	629	643	697	796	1.075

BU4201

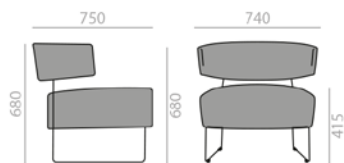

Lounge chair with upholstered seat and backrest and steel sled base finished in polished chrome white or black.
Butaca con asiento y respaldo tapizado y base de patín de acero en acabado cromo brillo, blanco o negro.

	COM cm. per unit	COL m2
1 units	190	4
10 units or more	190	

0,4 m3
 19,6 kg
 x1

€	COM	COL	1	2	3	4	5	6	7	8	9	10	11	L1	L2	L3	L6
	747	772	800	824	843	875	907	938	971	1.002	1.035	1.066	1.098	1.127	1.250	1.477	2.076

BU4203

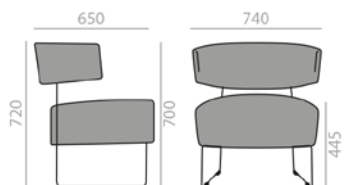

Lounge chair with upholstered seat and backrest and steel sled base finished in polished chrome white or black.
Butaca con asiento y respaldo tapizado y base de patín de acero en acabado cromo brillo, blanco o negro.

	COM cm. per unit	COL m2
1 units	188	4
10 units or more	188	

0,39 m3
 17,5 kg
 x1

€	COM	COL	1	2	3	4	5	6	7	8	9	10	11	L1	L2	L3	L6
	680	703	729	751	772	806	839	871	904	937	970	1.004	1.036	1.067	1.186	1.404	1.978

BQ4202

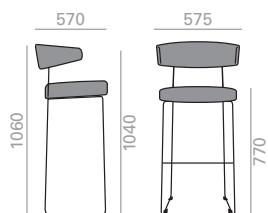

Barstool with upholstered seat and backrest and steel sled base finished in polished chrome white or black.
Banqueta alta con asiento y respaldo tapizado y base de patín de acero en acabado cromo brillo, blanco o negro.

	COM cm. per unit	COL m2
1 units	150	3
10 units or more	100	

0,35 m3
 14,5 kg
 x1

€	COM	COL	1	2	3	4	5	6	7	8	9	10	11	L1	L2	L3	L6
	540	552	566	579	588	604	619	635	651	667	683	699	715	728	785	889	1.169

SO4205

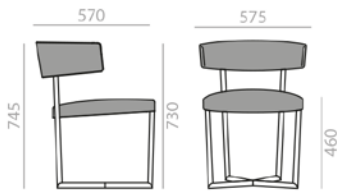

Armchair with upholstered seat and back and 4-legs solid beech wood base.
Sillón con asiento y respaldo tapizado y base de 4 patas de madera maciza de haya.

	COM cm. per unit	COL m2
1 units	160	3
10 units or more	100	

0,28 m3
 12,4 kg
 x1

COM	COL	1	2	3	4	5	6	7	8	9	10	11	L1	L2	L3	L6
€ 706	717	729	740	748	762	776	791	805	818	832	847	861	873	924	1.030	1.282

SERIE 600
Matte lacquered and premium upcharge
Incremento por lacado mate y premium

SERIE 800
Bright lacquered upcharge
Incremento por lacado brillo

BU4206

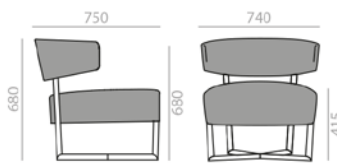

Lounge chair with upholstered seat and back and 4-legs solid beech wood base.
Butaca con asiento y respaldo tapizado y base de 4 patas de madera maciza de haya.

	COM cm. per unit	COL m2
1 units	190	4
10 units or more	190	

0,4 m3
 19,2 kg
 x1

COM	COL	1	2	3	4	5	6	7	8	9	10	11	L1	L2	L3	L6
€ 1.028	1.049	1.075	1.097	1.112	1.141	1.169	1.198	1.225	1.254	1.281	1.309	1.338	1.363	1.465	1.649	2.153

SERIE 600
Matte lacquered and premium upcharge
Incremento por lacado mate y premium

SERIE 800
Bright lacquered upcharge
Incremento por lacado brillo

Glides for sled bases/cantilever. Tacos para bases de patín/cantilever.

Use/Usu	Reference/Referencia	Material/Material	Price/Precio
Hard floors. Suelos duros.	TS0531	Plastic (PE). Plástico (PE).	0 € Standard. Estándar.
Wooden and delicate floors. Suelos de madera y delicados.	TS0538	Plastic (PE) with felt. Plástico (PE) con fieltro.	6 € Set of 4 glides. Juego de 4 tacos.
Mats/carpet floors. Suelos de moqueta/alfombra.	TS0537	No glide. Sin taco.	0 €

The indicated price is for glides placed on chairs. To order loose parts, please ask to our Sales Department.
El precio indicado en Tarifa es para tacos colocados en las sillas. Para pedidos de tacos sueltos de repuesto, consultar con el Departamento Comercial.

For wooden legs. Para bases de madera.



Optional glides on page 482.
Opciones de tacos deslizantes en página 482.



Description
Descripción

Stacking armchair with upholstered seat and back and solid oak wood frame.
Sillón apilable con asiento y respaldo tapizado y estructura de madera maciza de roble.

Upholstery
Tapicería

The Valeria collection supports following upholsteries of Andreu World Catalogue. For fabrics in our catalogue not specified in this box or customers own materials please contact our Customer Service Department.

La colección Valeria admite las siguientes tapicerías del catálogo de Andreu World. Para las telas de nuestro catálogo no indicadas en este cuadro o telas cliente, consultar con nuestro Departamento Comercial.

Fabrics / Telas

- 1** Soft-fiber
Jacquard One
Jacquard Three
Citadel
Sand
Era
Gravity
Rivet
Urban
Reel One (in/out)
Spin One
Spin Two
Spin Three
Spin Four
Spin Five
- 2** Jacquard Two
Solid & Stripes
Loom One
Circular One Pure Eco
Tack One (in/out)

- 3** Jacquard Four
Medley
Revive 1
Natte
Main Line Flax
Loom Two (in/out)
Mezzo
Reel two (in/out)
Jacquard Five

- 4** Jacquard 4 Special
Nexus
Field 2
Remix 3
Heritage
Savane
Loom Three
Loom Four
Cura
Oceanic
Reel Three (in/out)
Reel Four (in/out)
Reflect
Spin Six

- 5** Silk
Synergy
Step
Step Melange
Blazer
Melange Nap
Chili
Noma
Re-wool

- 6** Go check
Swing
Chartres
Zori
Patio
Tack Two (in/out)
Tack Three (in/out)

- 7** Canvas 2
Select
Clara 2
Tack Five (in/out)
Hero 2

- 8** Capture
Fiord 2
Tonus 4
Divina 3
Lopi
Domino
Atrium
- 9** Divina MD
Divina Melange 3
Hallingdal 65
Steelcut Trio 3
Tack Four (in/out)

- 11** Arda
Ecriture
Zero

Faux Leather / Ecopiel

- 1** Valencia
2 Silvertex
3 Maglia
4 Dolce
8 Ultraleather
9 Brisa
Brisa Distressed
Fresco
Ultraleather Pro
Promessa
- 10** Tottori
Coast (in/out)
- 11** Reef Pro
Volar Bio

Leather / Piel

- L1** High grade cow leather.
Piel de vaca de 1ª categoría.
- L3** Polished full grain leather.
Plena flor pulida.
- L6** Aniline leather batique-effect.
Scandinavian cattle.
Piel anilina efecto batique.
Ganado escandinavo.

Wood finish Oak
Acabado madera
Roble

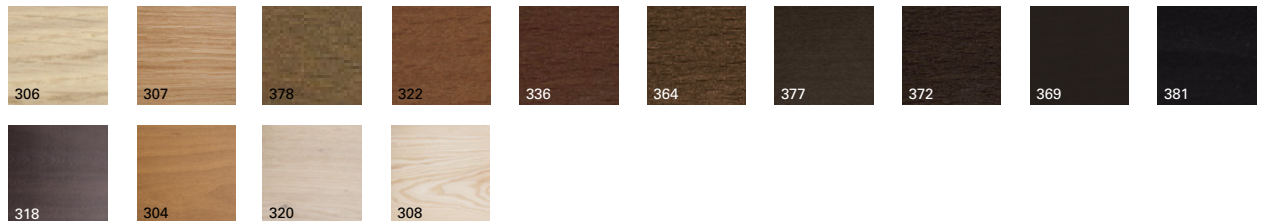

Premium finish and wood lacquers
Acabado premium y lacas madera

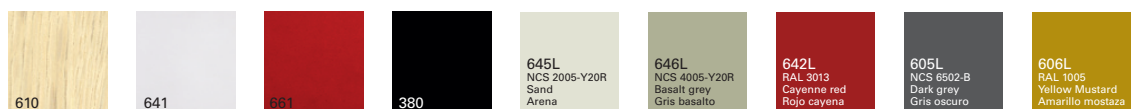

Certificates
Certificados

Fireproof polyurethane foam
Espuma de poliuretano ignifuga

UNE EN 1021:2006
BS 5852 part 2 crib 5
UNI 9175 Classe 1 IM
BKZ 5.2
California TB 117:2013
California TB 133*

*Contact our Customer Department
*Consultar con nuestro Departamento Comercial

Quality - Resistance
Calidad - Resistencia

UNE EN 16139:2013

Intellectual property Propiedad intelectual

All our collections are protected by international industrial design registries, designs patents, copyrights and intellectual Property laws. Unauthorized use of AW International Property is a criminal offence and can lead to prosecution.
Todas nuestras colecciones están protegidas por registros de diseño industrial, diseño de patente, copyright y derechos de propiedad intelectual en todo el mundo. El uso no autorizado de los diseños y propiedad intelectual de AW supone un delito que puede ser sometido a acción judicial.



SO7522

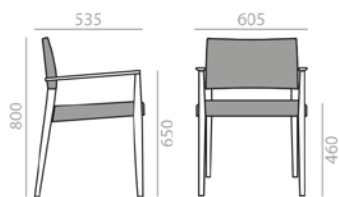

Stackable armchair with upholstered seat and backrest and solid oak wood frame.
Sillón apilable con asiento y respaldo tapizado y estructura de madera maciza de roble.

	COM cm. per unit	COL m2
1 units	75	1,5
10 units or more	75	

0,36 m3
 20,4 kg
 x2
 4
 6

€	COM	COL	1	2	3	4	5	6	7	8	9	10	11	L1	L2	L3	L6
	540	547	555	564	573	583	593	605	616	625	638	647	658	669	708	779	967

For wooden legs. Para bases de madera.



Optional glides on page 482.
Opciones de tacos deslizantes en página 482.

CA5004

Metallic trolley for transport stackable seating.
Carro metálico para transportar asientos apilables.

 0,39 m3

 14 kg

 x1

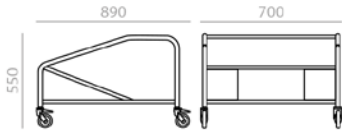

€ 216

CA5003

Metallic trolley for transport stackable seating.
Carro metálico para transportar asientos apilables.

 0,34 m3

 10,5 kg

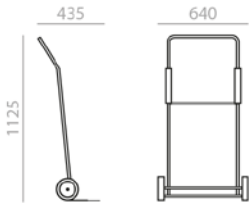

 x1



€ 200

For wooden legs.

Para patas de madera.

	Reference/Referencia	Material/Material	Use/Usó	Price/Precio	
	TS0410	Plastic (PE). Plástico (PE).	Hard floors. Suelos duros.	0€	Standard.Estándar.
	TS0413	Felt. Fieltro.	Wooden and delicated floors. Suelos de madera y delicados.	2 €	Set of 4 glides. Juego de 4 tacos.
	TS0412	Dual glide. Plastic and felt. Taco reversible. Plástico y fieltro.	Hard floors and wooden/ delicate floors. suelos duros y de madera/delicados.	7 €	Set of 4 glides. Juego de 4 tacos.
	TS0414	Felt with plastic (PE) and rubber absorber to reduce noise and vibrations. Fieltro con plástico (PE) y separador de goma para absorver ruido y vibraciones.	Wooden and delicate floors. Suelos de madera y delicados.	4 €	Set of 4 glides. Juego de 4 tacos.
	TS0415	Metal. Metal.	Mats/carpet floors. Suelos de moqueta/ alfombra.	2 €	Set of 4 glides. Juego de 4 tacos.

The indicated price is for glides placed on chairs. To order loose parts, please ask to our Sales Department.

El precio indicado en Tarifa es para tacos colocados en las sillas. Para pedidos de tacos sueltos de repuesto, consultar con el Departamento Comercial.

SALES CONDITIONS/REMARKS

1- This price-list is valid from the 01/01/2024

2- HOW TO ORDER.

Please specify:

- Model name and reference No. (ie. Alya BU-1522).
- Wood color name and reference N°. (ie. Natural beech Ref.300).
- Fabric category and reference No.
- Quantity.

3- DELIVERY TIME:

Is 4- 5 weeks after order confirmation. Loading date for orders with customer's special finishes or C.O.M. (Customer's Own Material) cannot be confirmed until confirmation of our counter-sample or C.O.M. arrives at Andreu World.

4- Goods remain our property until full payment.

5- Delivery terms indicated in our order confirmation are to be considered as indicative and are not binding for the manufacturer.

6- PRICE INCREASES:

Price increases given next to the product price in the catalogue are to be added per unit.

7- WITHOUT FABRIC:

Articles will be supplied with a protective white fabric (muslin) for upholstery by the customer. This option is not recommended for certain models due to difficulties in the upholstery process. Warning: Please mark on your purchase order if the articles without fabric should be provided with a cover.

8- UPHOLSTERED WITH CUSTOMER'S OWN MATERIAL (C.O.M.):

Not all upholsteries are suitable for all models of our catalog. For difficult cases where additional working time is required, an added cost may be applied. This fee will be communicated by Andreu World to be validated by the client.

t can be supplied at the price indicated in the Customer's Own Material category, but materials must arrive at the factory with the paid freight and at least 3 weeks before the loading date.

If materials are shipped from non-European Union countries, please be sure to include an invoice with no commercial value for customs clearance purposes. Any additional expenses incurred by Andreu World in using C.O.M. will be charged in the final invoice. Not all fabrics are suitable for the following models: Alya, Brandy, Flex chair, Flex High Back, Flex Corporate, Flex Executive, Lineal, Lineal Comfort, Lineal Corporate, Ronda, Tauro and Wok.

The fabric needed to upholster one or two units it is next to the pattern's detail. Should the width of your fabric be different from 140 cm., please contact with Customer Department. The quantity of fabric needed can vary significantly depending on the fabric's width. When C.O.M. requirements exceed one roll, one additional meter per roll has to be considered.

To facilitate the C.O.M. process, it is advisable to have the fabric sent to us 4 weeks before your expected loading date.

- The C.O.M.-requirement for fabrics with special rapport, because of its design, will be supplied on request after inspecting the size of the rapport.
- For C.O.M., facing and direction should be indicated.
- Please indicate the reference number of the order and the chairs which correspond to the C.O.M.

9- COVERS:

Andreu World's Upholstery Catalog includes fabrics that are suitable for covers. Please get in touch with the Sales Contact to consult each fabric's suitability for this use. We offer chair covers, as well as loose covers for some of our chairs. Some chair covers have Velcro adjustment. Maintenance: We recommend that you follow the cleaning instructions listed in our fabrics catalogue. We offer chairs with loose covers, as well as separate covers for some of our chairs. In both cases the covers will be fitted to the chair with Velcro. Maintenance: We recommend to follow the cleaning instructions that appear in our fabric sample catalogue.

10- MODEL WITH LOOSE COVERS:

The chair will be upholstered always with a protecting white fabric (muslin) and the cover will be manufactured in the fabric chosen by the customer.

11- COVERS IN C.O.M:

We can produce our covers with your own fabric, but we shall remind you that there are some fabrics that cannot be used to make covers due to its thickness and other particularities.

12- FABRIC ORDERS:

For fabric orders from the Andreu World catalogue, freight costs will be paid by the customer.

13- INTERLINER:

Andreu World supplies this material. Please contact our Sales Department for information of the price increases.

14- FSC®:

The majority of the products included in the catalogue of Andreu World are certified with the Forest Stewardship Council (FSC®) certification that ensures a sustainable use of wood. The full list of models with FSC® certification is available on Andreu World website: www.andreuworld.com.

15- VARIATIONS IN COLOR OR TONALITY:

Since wood is a natural material, slight tone differences may be noticed on the individual elements of the product. In addition, if products are purchased at different times, natural ageing and climatic conditions may cause variations in color and/or tonality. Andreu World therefore accepts no claims or complaints with respect to tone differences and no goods may be returned for such reasons.

16- FINISHES IN SERIES 600 AND 800:

Price increases in Series 600 (matte lacquered) and in Series 800 (bright lacquered) are indicated next to each model price.

17- SPECIAL COLOR FINISHES:

Andreu World allows you to order finishes for the models of your choice using stain and lacquer samples supplied by you. To do so, please bear in mind the following surcharges:

a) SPECIAL CUSTOMER STAINS:

Gloss: model price + S/800 surcharge cost

b) SPECIAL CUSTOMER LACQUER:

Matte: model price + S/600 surcharge cost

Gloss: model price + S/800 surcharge cost

For seats orders under 10 units, add 100 Euros to the final amount shown on the order.

For tables orders, please contact our Customer Department.

Upon request, Andreu World can also supply a gloss finish on the model of your choice using the stains as shown in the color finishes catalogue. The surcharges are as follow:

Seats: model price + S/800 surcharge cost

18- TRANSPORT:

Andreu World pays the transport on the Peninsula and Balears except Andorra, Ceuta, Melilla and Canarias.

a) Andreu World cannot be held responsible for damage happened during the transport unless the following conditions are fulfilled:

- Transport is paid by Andreu World,
- The forwarder is assigned by Andreu World,
- The forwarder's delivery note states that the goods were accepted "PENDING INSPECTION"; and
- The damage is reported within 24 hours of reception. Failing these conditions, the damage will not be covered by the transport insurance and Andreu World is free from all responsibility.

- When carriage is for customer account or the carrier is chosen by the customer, the customer shall be responsible for any damage sustained during carriage.
- Orders for less than 1.000 Euros will have a transport up-charge 150 Euros

19- PACKING REINFORCEMENT:

The price increase for packing reinforcement is:

Seating/Tables: 50 Euros for the special packing.

20- SPECIAL MEASUREMENTS AND MODIFICATIONS:

Should you require any special measurement or modification to our standard products, please contact our sales department for information on viability, price and delivery time.

21- WEIGHTS AND VOLUMES: Weights and volumes that appear in the price-list refer to the weight and volume of the box including the products.

22- The manufacturer reserves the right to modify at any time the sizes and the patterns of the model, as well as to introduce any improvements and modifications deemed necessary in the manufacturer's sole criteria Warning: While we have tried to ensure that all prices, sizes, volumes, weights, and other specifications are accurate, they are intended only as a guide and are subject to modification without notice. Volumes, weights, number of boxes and units per box can vary depending on the combination of products or the total number of units ordered.

23- GUARANTEE: Andreu World products are guaranteed against all defects in materials and manufacturing processes for 10 years from the date of invoice. For special productions requested by customers, whether modifications or new models, as well as mechanisms, electrical components, models with natural wicker and the collections that make up our outdoor catalog, the guarantee will be two years. This guarantee does not include defects caused by misuse, accident, negligence, shipping damage, abuse, or the normal aging and wear and tear of the use itself. This guarantee does not extend to fabrics, leathers, covers and materials, not included in the Andreu World offering, owned by the customer or purchased by Andreu World at the customer's request. The correct selection of the product for each application is the responsibility of the buyer. This constitutes the complete and only guarantee, and replaces all possible guarantees of any kind, either implicitly or explicitly, including but not limited to compliance with Law 23/2003 dated July 10, 2003. Repair, exchange or prorated discount on the total price constitute the total responsibility of Andreu World and the only possible solution to the buyer. Andreu World assumes no responsibility for commercial losses and any consequences for damages that may result from any defect in the product, shortage or delay. It is understood that these solution and responsibility limitations are part of the terms and conditions of purchase from Andreu World of its products, and when an order is placed, the conditions, terms and limitations are being accepted.

CONDICIONES DE VENTA/OBSERVACIONES

1 - Lista de precios vigente a partir del 01/01/2024

2 - CÓMO REALIZAR UN PEDIDO.

Concreten, por favor:

- Nombre y número de referencia del modelo (por ej., Alya BU-1522)
- Nombre y número de referencia del color de la madera (por ej., Haya natural, ref.300)
- Categoría y número de referencia de la tela.
- Cantidad.

3 - PLAZO DE ENTREGA:

Entre 4 y 5 semanas tras la confirmación del pedido. La fecha de carga para pedidos con acabados especiales para el cliente o con tela cliente no podrá confirmarse hasta la ratificación de nuestra contra muestra o cuando la tela cliente llegue a Andreu World.

4 - Las mercancías serán de nuestra propiedad hasta que se paguen en su totalidad.

5 - Los plazos de entrega indicados en nuestro pedido de confirmación se considerarán como indicativos y no tendrán carácter obligatorio para el fabricante.

6 - INCREMENTOS DE PRECIOS:

Junto a los precios de cada modelo figuran los incrementos a añadir por unidad.

7 - PRETAPIZADO:

Los artículos se suministrarán con una tela blanca protectora (muslin) para ser posteriormente tapizados por el cliente. Hay algunos modelos en que no recomendamos esta posibilidad debido a la dificultad de su realización. Advertencia: Por favor, señale en la orden de compra si los artículos solicitados en pretapizado llevarán una funda.

8 -TAPIZADO CON TELA CLIENTE:

No todas las tapicerías son aptas para todos los modelos de nuestro catálogo. En los casos en los que exista una dificultad añadida que requiera un aumento del tiempo de trabajo, cabe la posibilidad de que suponga un extra coste, que será comunicado por Andreu World para ser validado por el cliente.

Podrán suministrarse por el precio indicado en la categoría de tela cliente, pero las telas tienen que llegar a nuestras fábricas a portes pagados y con una antelación de 3-4 semanas desde la fecha de entrega del pedido.

Para los países no pertenecientes a la Unión Europea deben incluir una factura sin valor comercial, requisito obligatorio para pasar las aduanas en España. Cualquier gasto causado por la tela cliente se cargará en la factura.

No todas las tapicerías son aptas para los siguientes modelos: Alya, Brandy, Flex chair, Flex High Back, Flex Corporate, Flex Executive, Lineal, Lineal Comfort, Lineal Corporate, Ronda, Tauro y Wok.

La tela necesaria para tapizar una o dos unidades se encuentra junto el detalle de cada modelo. Si el ancho de su tela no es de 140 cm., por favor consulte con el Departamento Comercial. Las necesidades de tela varían en ocasiones de forma significativa según el ancho del rollo. Cuando las necesidades de tela cliente excede de un rollo, se debe considerar un metro más por rollo.

Para evitar problemas se recomienda enviar la tapicería 4 semanas antes de la fecha de entrega prevista para su pedido.

- La solicitud de tela cliente para telas con estampado especial, a causa de su diseño, se proporcionará sobre pedido después de inspeccionar el tamaño del estampado.
- Para la tela cliente deberá indicarse la cara buena y la dirección de la tela para su correcto tapizado.
- Por favor, indiquen el número de referencia del pedido y las sillas que correspondan a la tela cliente.

9 - FUNDAS:

Dentro del Catálogo de tapizados de Andreu World se ofrecen unas telas válidas para fundas. Rogamos se pongan en contacto con la Comercial para consultar la validez de la tela. Ofrecemos sillas con fundas, así como también fundas sueltas para algunas de nuestras sillas. En algunos casos la funda se ajustará a la silla con Velcro. Mantenimiento: Recomendamos que sigan las instrucciones de limpieza que figuran en nuestro catálogo de telas.

10 - MODELO CON FUNDAS:

La silla se tapizará siempre con una tela blanca protectora (muslin) y la funda se fabricará en la tela elegida por el cliente.

11 - FUNDAS EN TELA CLIENTE:

Podemos producir nuestras fundas con su tela, pero les advertimos que hay algunas telas que no pueden usarse para hacer una funda a causa de su espesor u otras peculiaridades.

12 - PEDIDOS DE TELAS:

En los pedidos de tapicerías del Catálogo de Andreu World los portes de envío serán a cuenta del cliente.

13 - INTERLINER:

Andreu World proporciona este material. Por favor contactar con nuestro Departamento Comercial para informarse de estos incrementos.

14 - FSC®:

Dentro del catálogo Andreu World, la gran mayoría de los modelos cumplen los requisitos del certificado FSC® que garantiza el uso sostenible de la madera. El listado completo de modelos que cumplen el FSC® está disponible en la web de Andreu World www.andreuworld.com

15- VARIACIONES EN EL COLOR O TONALIDAD:

Como la madera es un material natural, puede haber ligeras diferencias de tono entre los distintos elementos que componen el producto. Además, si los productos se compran en períodos distintos, el tiempo transcurrido y las condiciones climáticas pueden causar variaciones en el color y/o tonalidad. Por lo tanto, Andreu World no aceptará ninguna reclamación sobre este asunto y ningún artículo podrá devolverse por ello.

16- ACABADOS EN LA SERIE 600 Y EN LA SERIE 800:

Los incrementos de precios para los acabados de la Serie 600 (lacados mate) y de la Serie 800 (lacados brillo) están indicados junto al precio para cada modelo.

17- ACABADOS ESPECIALES DE COLOR:

Andreu World ofrece la posibilidad de acabar sus modelos con muestras de tintes y lacas suministradas por los clientes. Para ello, hay que tener en cuenta los siguientes incrementos:

a) TINTES ESPECIALES CLIENTE:

Brillo: precio del modelo + precio incremento s/800

b) LACA ESPECIALES CLIENTE:

Mate: precio del modelo + precio incremento s/600

Brillo: precio del modelo + precio incremento s / 800

Si el pedido fuera inferior a 10 unidades, se añadirán 100 Euros al valor final del pedido. Para mesas consulte con el Departamento Comercial.

Andreu World también ofrece la posibilidad de dar acabado brillo a las lacas pertenecientes a su Catálogo de acabados de color. Los incrementos serían los siguientes:

Asientos: precio del modelo + precio incremento s/800

18 - TRANSPORTE:

Andreu World cubre los portes de envío en la Península y Baleares salvo Andorra, Ceuta, Melilla y Canarias.

a) Andreu World sólo se responsabilizará de daños producidos en el transporte, cuando se cumplan los requisitos siguientes:

- Que el porte sea pagado por Andreu World,
 - Que la agencia de transportes sea asignada por Andreu World,
 - Que en el albarán de recepción de la agencia figure que la mercancía ha sido aceptada "SALVO EXAMEN",y
 - Que el daño sea comunicado en el plazo de 24 horas desde la recepción.
- Si no se dan estas condiciones el seguro de transporte no cubrirá el daño y Andreu World quedará exenta de toda responsabilidad.

b) Cuando el transporte sea pagado por el cliente o la agencia de transportes elegida por el cliente, el cliente será el responsable de los posibles daños producidos durante el transporte.

c) Los pedidos inferiores a 1.000 Euros tendrán un suplemento de transporte de 150 Euros.

19 - GASTOS POR ENVÍO AÉREO:

El aumento de precio por envío de la carga por avión será:
Asientos/Mesas: 50 Euros por refuerzo especial.

20- MEDIDAS ESPECIALES Y MODIFICACIONES:

Cualquier medida especial o modificación sobre nuestra oferta estándar de producto que usted precise, deberá consultarla con nuestro Departamento Comercial, el cual le confirmará su viabilidad, precio y plazo de servicio.

21- PESOS Y VOLÚMENES: Los pesos y volúmenes que figuran en el catálogo de precios se refieren al peso y volumen de la caja en la que van los productos.

22- El fabricante se reserva el derecho, según su propio criterio, a modificar en cualquier momento los tamaños y modelos del prototipo, ya consistan en mejoras o en variantes. Advertencia: Si bien hemos tratado de asegurar que todos los precios, tamaños, volúmenes, pesos, y otras especificaciones sean precisas, ello se pretende sólo como una guía y está sujeto a modificación sin previo aviso. Los volúmenes, pesos, número de cajas y unidades por caja pueden variar dependiendo de la combinación de productos o del número total de unidades pedidas.

23- GARANTÍA: Los productos de Andreu World están garantizados contra todos los defectos en materiales y procesos de elaboración por 10 años desde la fecha de factura. Para las producciones especiales solicitadas por los clientes, ya sean modificaciones o nuevos modelos, así como para los mecanismos, componentes eléctricos, los modelos con rejilla natural y las colecciones que componen nuestros catálogo de exterior, la garantía será de dos años. Esta garantía no incluye las deficiencias ocasionadas por un uso indebido, accidente, negligencia, daños de transporte, abuso, o el envejecimiento y desgaste normal del propio uso. Esta garantía no se extiende a telas, pieles, fundas y materiales, no incluidos en la oferta de Andreu World, propiedad del cliente o comprados por Andreu World a petición del cliente. La correcta selección del producto para cada aplicación es responsabilidad del comprador. Ésta constituye la completa y única garantía, y reemplaza a todas aquellas posibles garantías de cualquier clase bien de forma implícita o explícita, incluyendo pero no limitando el cumplimiento de la Ley 23/2003 del 10 de julio de 2003. La reparación, cambio o el descuento prorrateado sobre el precio total constituyen la responsabilidad total de Andreu World y la única solución posible al comprador. Andreu World no asume ninguna responsabilidad por pérdidas comerciales y cualquier consecuencia en daños que puedan ser resultado de cualquier defecto en el producto, falta o retraso. Se entiende que estas limitaciones de solución y responsabilidad son parte de los términos y condiciones de compra a Andreu World de sus productos, y cuando se pasa un pedido se están aceptando las condiciones, términos y limitaciones.

MAINTENANCE

1- WOOD/LACQUER

The majority of the beech, oak, walnut, maple, and ash woods used in the AW collections is obtained from sustainable wood sources. The FSC® (Forest Stewardship Council) certificate guarantees that our FSC®-certified products have been extracted from reforested areas and are prepared according to the FSC® Principles and Criteria, which define the minimum standards for good forest management worldwide.

MAINTENANCE

We recommend cleaning stains with a damp cloth and a soap solution.

2- WEBBING

30 mm. thick polypropylene webbing with satin finish. Used in Valeria and Smart collection.

MAINTENANCE

To clean, gently wipe the webbing belts using a brush and a cloth soaked in soapy water. Remove the excess soap and dry with a cloth.

3- UPHOLSTERY/COVERS

The Andreu World catalog offers different types of fabrics, leathers and synthetic leathers manufactured by world-leading companies.

MAINTENANCE

Information on maintenance, composition and technical characteristics, as well as the suitability of each fabric for use as covers, can be found in our upholstery catalogs.

4- CERAMICS

The ceramic tops and boards of the bases and tables included in the Andreu World are waterproof, hygienic and colorfast. They are fireproof and abrasion-resistant, as well as 100% recyclable.

MAINTENANCE

We recommend the use of regular detergents for cleaning. Lime, wine, ice cream, coffee and grease stains should be removed using an alkaline detergent or a descaling product. Wipe clean bird droppings as quickly as possible, since they can cause permanent stains.

5.- HIGH PRESSURE LAMINATES

The high pressure laminate table tops are suitable for outdoor use. They are treated against UV action and are highly resistant to wear, heat and moisture.

MAINTENANCE

The surface should be cleaned with a nonabrasive sponge, water and detergent. The imporosity of the surface helps prevent the penetration of dirt. Wipe clean bird droppings as soon as possible, since they can cause permanent stains on the surface of high pressure laminate.

6. – LAMINATED BOARDS

The laminated plywood table tops are suitable for covered outdoor spaces. They are extremely resistant to impacts and scratches and have been specifically designed for those uses which require a high-quality finish and a consistent surface.

MAINTENANCE

Cleaning is simple and only requires water and detergent.

7- STEEL

Steel is robust, hard, rigid and weather-resistant, making it suitable for a large number of uses. Andreu World uses chromed steel.

MAINTENANCE

Chromed steel requires regular cleaning with soapy water. In the case of stains, avoid abrasive sponges or fabrics.

Stainless steel only requires regular cleaning with soapy water. Stainless steel is synonymous with an attractive finish and durability. Any stains caused by aggressive products require a specific cleaning:

- Water- and lime-stains: Remains of lime can be removed by soaking with a 25% vinegar solution or a 15% nitric acid solution. Rinse well and continue washing with soap or detergent and water. Rinse with hot water. Wipe dry with a soft, clean cloth.

- Oil and Grease: Rinse with an organic/hydrocarbon (e.g., alcohol) product, then clean with soap or detergent and water. Rinse well with cold water and a dry cloth. Soaking is advisable before cleaning with hot soapy water.

- Tea and Coffee stains: Wash with washing soda (sodium bicarbonate) and hot water. Then wash with soap or detergent and water. Rinse thoroughly with hot water. Wipe dry with a soft, clean cloth.

For the correct maintenance of stainless steel structures in areas near the coast and for areas in permanent contact with marine environments, we recommend regular cleaning with soapy water.

8- THERMO-POLYMER

The Flex Chair, Flex High Back, Sail and Sit collection seats and backrests are made of high-quality, resistant thermopolymer that offers enormous versatility for all types of indoor and outdoor environments.

MAINTENANCE

Only soap and water is required for cleaning.

9. - GLASS

Tempered glass coated with high-adhesion vitrified paint that prevents color changes over time.

MAINTENANCE

Any cleaning product (including solvents) can be used

10- ALUMINUM

Aluminum is a lightweight, resistant alternative of proven effectiveness for outdoor and indoor furniture. It is 100% recyclable.

MAINTENANCE

Requires only soap and water.

11- SOLID SURFACE

Solid Surface is a non-porous and homogeneous material comprised of natural minerals and a small percentage of highly durable resins. These tops, made of natural minerals, are similar in appearance and feel to natural stone and are available in white. Suitable for outdoor use.

MAINTENANCE

The Solid surface tops does not absorb liquids, but is recommended to dry spills or drops immediately. Generally, most stains can be removed using a microfiber cloth dampened with household cleaner spray with circular movements.

12- MARBLE

Marble is a natural stone of great warmth and personality. It is able to be used in numerous environments and the ideal material for cutting edge installations.

MAINTENANCE

Proper cleaning of marble is essential for the life of the product. It is recommended to use neutral detergents diluted in water. It is not advisable to use cleaning products that contain acetone, lemon, or vinegar as these substances could dull or abrade the surface over time.

Marble is a natural material susceptible to staining due to its porosity. Therefore all spills should be cleaned up immediately to avoid staining.

MANTENIMIENTO

1- MADERA/LACA

La madera utilizada en las colecciones de AW, de haya, roble nogal, arce y fresno, en su mayoría están desarrolladas a partir de maderas sostenibles. La certificación FSC® (Forest Stewardship Council) garantiza que nuestros productos certificados como FSC® se extraen de bosques reforestados y se elaboran de acuerdo a los Principios y Criterios del FSC®, los cuales definen los niveles mínimos de buena gestión para los bosques de todo el mundo.

MANTENIMIENTO

En caso de manchas se recomienda limpiar la superficie con un paño húmedo en una solución jabonosa.

2- CINCHA

Cincha realizada en polipropileno de 30 mm de grosor y en acabado mate. Utilizada en la colección Valeria y Smart.

MANTENIMIENTO

Para la limpieza se recomienda frotar suavemente las cintas con un cepillo y un paño empapado con agua jabonosa. Posteriormente retirar los excesos de jabón y secar con un paño.

3- TAPICERÍAS/FUNDAS

Andreu World ofrece en su catálogo distintos tipos de tapicerías, pieles y polipiel, fabricadas por líderes mundiales.

MANTENIMIENTO

El mantenimiento, su composición, así como sus características técnicas, y si son aptas para su confección como fundas, está indicado en nuestros catálogos de tapizados.

4- CERÁMICA

Los sobres y tableros cerámicos de las mesas incluidas en las colecciones de Andreu World son impermeables, higiénicos y presentan colores inalterables. Son ignífugos y resistentes a la abrasión. Es 100% reciclable.

MANTENIMIENTO

Para su limpieza se recomienda usar una esponja no abrasiva, agua caliente y detergente común. Para las manchas de cal, vino, helado, café o grasa se debe emplear un detergente alcalino o un desincrustante.

5- TABLEROS COMPACTOS

Los sobres de mesa de tablero compacto son idóneos para su uso en exterior. Incorporan un tratamiento que los protege de la acción UV, unido a la elevada resistencia al desgaste, al calor y a la humedad. La naturaleza no porosa ayuda a que la suciedad no penetre.

MANTENIMIENTO

Solo requiere limpiar la superficie con una esponja no abrasiva, agua caliente y jabón.

6- TABLERO LAMINADO

Los sobres de tablero contrachapado laminado son extremadamente resistentes a los golpes y al rayado, están especialmente preparados para aquellos usos donde se necesita un buen acabado y una superficie consistente.

MANTENIMIENTO

Su limpieza requiere únicamente agua caliente y jabón.

7- ACERO

El acero se caracteriza por ser robusto, duro, rígido y resistente a la agresión de agentes climáticos, permitiendo un gran número de usos.

Andreu World utiliza dos tipos de acero:

- Acero con acabado cromado.
- Acero inoxidable 304L, muy resistente, idóneo para exteriores situados a más de 20km de la costa.

MANTENIMIENTO

El Acero cromado, requiere una limpieza regular con agua jabonosa. En caso de manchas, se deben evitar las esponjas o tejidos abrasivos.

En el caso de acero inoxidable, su mantenimiento tan solo requiere una limpieza regular con agua jabonosa. El acero inoxidable es sinónimo de durabilidad con buen aspecto, siempre que se tengan en cuenta las manchas de productos agresivos y se proceda a una limpieza específica:

- Marcas de agua y cal: Restos importantes de cal pueden ser eliminados remojando con una solución de vinagre al 25% o ácido nítrico al 15%. Aclarar bien y continuar lavando con jabón o detergente y agua. Aclarar con agua caliente. Limpie en seco con un paño de limpieza suave.
- Aceite y Grasa: Lavar con un producto orgánico/hidrocarbónico (por ejemplo alcohol), después limpiar con jabón o detergente suave y agua. Aclarar bien con agua fría y un trapo seco. Se recomienda remojar antes de limpiar con agua caliente enjabonada.
- Marcas de Té y Café: Lavar con soda de lavar (bicarbonato de sodio) y agua caliente. Continuar con un lavado con jabón o detergente y agua. Aclarar a fondo con agua caliente. Limpie en seco con un paño de limpieza suave.

Para un óptimo mantenimiento de las estructuras metálicas de acero inoxidable en zonas cercanas a la costa y en permanente contacto con ambientes marinos, se recomienda una limpieza regular con agua jabonosa.

8- TERMOPOLÍMERO

Los asientos y respaldos de las colecciones Flex Chair, Flex High Back, Sail y Sit están realizados en termopolímero de alta calidad y resistencia que le otorgan gran versatilidad para todo tipo de ambientes tanto de interior como de exterior.

MANTENIMIENTO

Su limpieza requiere únicamente agua caliente y jabón.

9- CRISTAL

Vidrio templado recubierto con pintura vitrificada de gran adherencia que evita variaciones de color a lo largo del tiempo.

MANTENIMIENTO

Puede utilizarse cualquier producto de limpieza (incluidos disolventes).

10- ALUMINIO

El aluminio es una alternativa ligera, resistente y de contrastada eficacia en la realización de mobiliario de interior o exterior. Es 100% reciclable.

MANTENIMIENTO

Solo precisa de agua y jabón.

11- SOLID SURFACE

Solid Surface es un material compacto y homogéneo, compuesto de minerales naturales y un bajo porcentaje de resinas de alta resistencia. Estos sobres, compuestos por minerales naturales, son en su apariencia y tacto similares a la piedra natural y están disponibles en blanco. Válido para uso en exterior.

MANTENIMIENTO

Los Top Solid Surface no absorben líquidos, pero se recomienda pasar una esponja o bayeta humedecida para secar las salpicaduras. Las manchas en superficie se pueden eliminar utilizando una bayeta de microfibra humedecida con detergente doméstico en spray realizando movimientos circulares.

12- MÁRMOL

El mármol es una piedra natural de gran calidez y gran personalidad que le permiten su aplicación en múltiples ambientes, siendo un material idóneo para la decoración de vanguardia.

MANTENIMIENTO

La limpieza del mármol es fundamental para la duración del producto. Se recomienda utilizar detergentes neutros diluidos en agua. No es recomendable utilizar materiales de limpieza que contengan acetona, limón, o vinagre porque con el tiempo podrían opacar o desgastar la superficie.

El mármol es un material natural vulnerable ante las manchas debido a su porosidad por lo que debe limpiarse inmediatamente después de cualquier mancha.

CERTIFICATIONS

1.- WEBBING

EN 1021 part 1-2:94 Fire resistance

3. - CERAMICS

UNE EN ISO 10545-3 Water absorption

UNE EN ISO 10545-4 Flexural strength

UNE EN ISO 10545-6 Abrasion resistance

UNE EN ISO 10545-4 Breakage strength

UNE ENV 12633 Friction coefficient

UNE EN ISO 1054512 Frost resistance

UNE EN ISO 10545-9 Resistance to thermal shock

UNE EN 13501-1:02 Fire resistance

4.- COMPACT BOARDS

EN 438-6 Exterior-grade compact laminates (2mm and thicker)

EN 438-2-10 Abrasion resistance

EN 438-2-12 Resistance to boiling water

EN 438-2-14 Resistance to water vapor

EN 438-2-16 Resistance to dry heat 180°C

EN 12721 Resistance to wet heat

EN 438-2-17 Dimensional stability at high temperature

EN 438-2-21 Resistance to impact by large-diameter ball

EN 438-2-24 Resistance to crazing

EN 438-2-25 Resistance to scratching

EN 438-2-26 Stain resistance

EN 438-2-27 Colorfastness in artificial light

EN 438-2-30 Resistance to cigarette burns.

Fire resistance C-s1,d0

5.- LAMINATED BOARDS

UNE-EN 315:2001 Plywood. Dimensional tolerances

EN 314-2/clase 3 Bonding quality

EN 438-2-10 Abrasion resistance

EN 438-2-12 Resistance to boiling water

EN 438-2-14 Resistance to water vapor

EN 438-2-16 Resistance to dry heat 180°C

EN 12721 Resistance to wet heat

EN 438-2-17 Dimensional stability at high temperature

EN 438-2-21 Resistance to impact by large-diameter ball

EN 438-2-20 Resistance to impact by small-diameter ball

EN 438-2-23 Cracking resistance

EN 438-2-24 Resistance to crazing

EN 438-2-25 Resistance to scratching

EN 438-2-26 Stain resistance

EN 438-2-27 Colorfastness in artificial light

EN 438-2-30 Resistance to cigarette burns

EN 438-2-33 Resistance to blistering

**For more detailed information on test results contact Export Department.

CERTIFICACIONES

1-CINCHA

EN 1021 part 1-2:94 Reacción al fuego

3- CERÁMICA

UNE EN ISO 10545-3 Absorción de agua

UNE EN ISO 10545-4 Resistencia a la flexión

UNE EN ISO 10545-6 Resistencia a la abrasión

UNE EN ISO 10545-4 Fuerza de rotura

UNE ENV 12633 Resistencia al deslizamiento

UNE EN ISO 1054512 Resistencia al hielo/deshielo

UNE EN ISO 10545-9 Resistencia al choque térmico

UNE EN 13501-1:02 Reacción al fuego

4- TABLERO COMPACTO

EN 438-6 Compactos para exteriores de 2 mm de espesor y mayores.

EN 438-2-10 Resistencia a la abrasión.

EN 438-2-12 Resistencia al agua hirviendo.

EN 438-2-14 Resistencia al vapor de agua.

EN 438-2-16 Resistente al calor seco 180°C.

EN 12721 Resistencia al calor húmedo.

EN 438-2-17 Estabilidad dimensional a temperatura elevada.

EN 438-2-21 Resistencia al impacto de una bola de gran diámetro.

EN 438-2-24 Resistencia al agrietado.

EN 438-2-25 Resistencia al rayado.

EN 438-2-26 Resistencia a las manchas.

EN 438-2-27 Solidez del color a la luz artificial.

EN 438-2-30 Resistencia a las quemaduras de cigarrillo.

Reacción al fuego C-s1,d0

5- TABLERO LAMINADO

UNE-EN 315:2001 Tablero contrachapado. Tolerancias dimensionales

EN 314-2/clase 3 Calidad del encolado. Especificaciones

EN 438-2-10 Resistencia a la abrasión

EN 438-2-12 Resistencia al agua hirviendo

EN 438-2-14 Resistencia al vapor de agua

EN 438-2-16 Resistente al calor seco 180°

EN 12721 Resistente al calor húmedo

EN 438-2-17 Estabilidad dimensional a temperatura elevada

EN 438-2-21 Resistencia al impacto de una bola de gran diámetro

EN 438-2-20 Resistencia al impacto de una bola de pequeño diámetro

EN 438-2-23 Resistencia a las fisuras

EN 438-2-24 Resistencia al agrietado

EN 438-2-25 Resistencia al rayado

EN 438-2-26 Resistencia a las manchas

EN 438-2-27 Solidez del color a la luz artificial

EN 438-2-30 Resistencia a las quemaduras de cigarrillo

EN 438-2-33 Resistencia a la formación de ampollas

**Para recibir información detallada sobre los resultados de los ensayos contactar con nuestro Departamento comercial.



Fabrics

Andreu World Leather

Leather Piel / Grade L1

Composition / Composición
Bovine leather of European origin
Piel bovina de origen europeo

Certifications / Certificados
EN ISO 102-1 - EN ISO 1021-2 •
BS 5852:Source 0 • BS 5852:
Source 1 • Cal TB 117 •
NFPA 260/UFAC

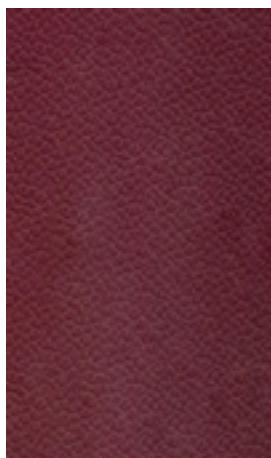

4210

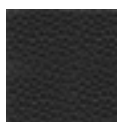

4025



4029

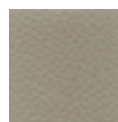

4034



4075

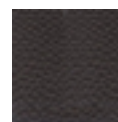

4084

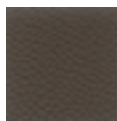

4085

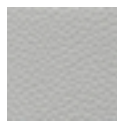

4224

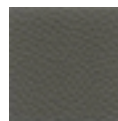

4225

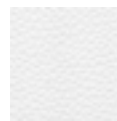

4226

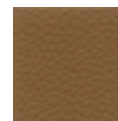

4228

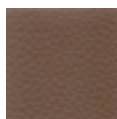

4230

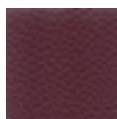

4231

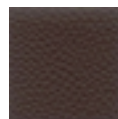

4232



4236

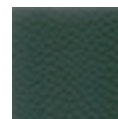

4237

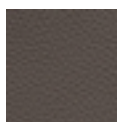

4820

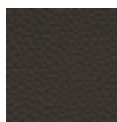

4821

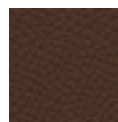

4822



4824

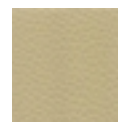

4229

Hide Leather Cuero / Grade L2

Composition / Composición
Bovine leather
Piel bovina

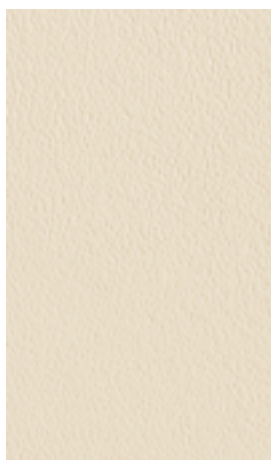

4051

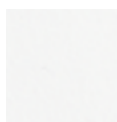

4050

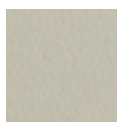

4052



4053



4054

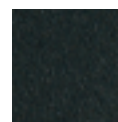

4055



4056

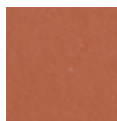

4057



4058

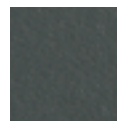

4061

Andreu World Leather

Leather Piel / Grade L3

Composition / Composición
Bovine leather of European origin
Piel bovina de origen europeo

The leathers have passed comprehensive processes of classification and treatment. The naturalness makes the texture appreciated from the marks and irregularities of the leather.
Las pieles han pasado exhaustivos procesos de clasificación y tratamiento. La naturalidad hace que en su textura se aprecien ciertas marcas e irregularidades propias de la piel.

Certifications / Certificados
EN 1021-1 - UNI EN 1021-2 • NFPA 260/UFAC • IMO Resolution A.652 (16)California TB 117 section E

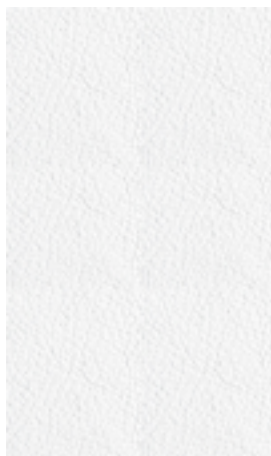

1800



1805



1806



1809

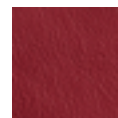

1810



1811

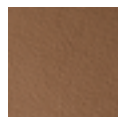

1815



1816



1818



1819



1820

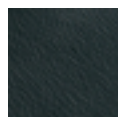

1821

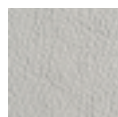

1822



1824

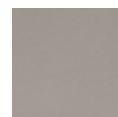

4830



4832



4833



4834



4835



4836



4837

Leather Elmotique VII / Grade L6

Composition / Composición
Bovine leather of Scandinavian origin
Piel bovina de origen escandinavo

Elmotique is aniline leather with a batique-effect and displays all the features possessed on the original hide. Visible insect-bites and scars from healed wounds add to the natural character of the leather.
To preserve, clean and sustain the leather, treat it a product specifically for leather.
Elmotique es una piel anilina con un efecto batique, en la que se muestran todas las características que posee la piel original. Por ello, son visibles picaduras de insectos y cicatrices de heridas, que se suman al carácter natural de la piel. Para preservar, limpiar y mantener el cuero, trátelo con un producto específico para el cuero.

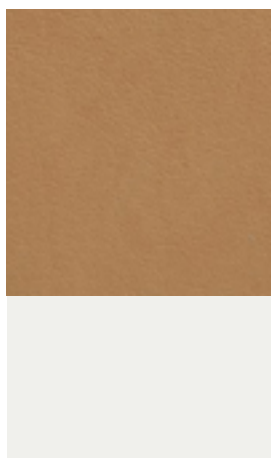

43024

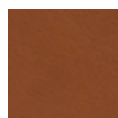

43807

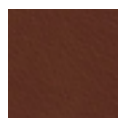

93718

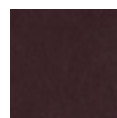

95044

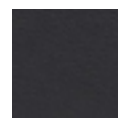

91059



99001

Certifications / Certificados
EN 1021-1&2 • ISO 8191-1&2 • California 117

Tapicerías

Andreu World Textiles

Soft-fibra Soft-fiber / Grade 1

Composition / Composición
Surface / Superficie 100% Pol.
Backing / Soplete 67% Pol. 33%
CO

Martindale test /
Resistencia a la abrasión
100.000 Cycles / Ciclos (BS
5690:91)



1500



1501

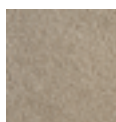

1502



1503



1504



1505



1507



1508



1510



1511



1512

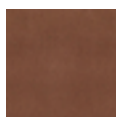

1514

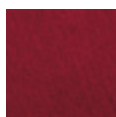

1515



1516

Jacquard Two / Grade 2

Composition / Composición
89% PES. 11% CO.

Martindale test /
Resistencia a la abrasión
60.000 Cycles / Ciclos
(EN ISO 12947-2:1998)

Certifications / Certificados
BS5852 Source 0 • EN 1021-
1:2006 • CAL TB-117



1969

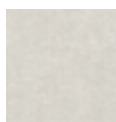

1700

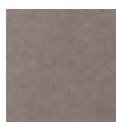

1702



1704



1705

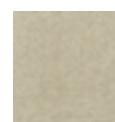

1956

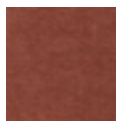

1959

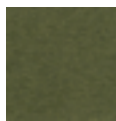

1961



1962



1964

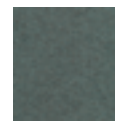

1966



1968



1712



1709



1732

Andreu World Textiles

Jacquard One / Grade 1

Composition / Composición
 48% PP. 18%PES. 9%CO. 25%
 Recycled yarn from GRS Bottles
 and textile waste
 48% PP. 18%PES. 9%CO. 25%
 Hilo reciclado de botellas GRS y
 residuos textiles.

Martindale test /
 Resistencia a la abrasión
 31.000 Cycles / Ciclos
 (EN ISO 12947-1:1998)

Certifications / Certificados
 BS5852 source 0/EN ISO 1021-
 1:2006 • CAL TB 117



1721

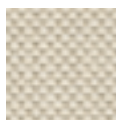

1715

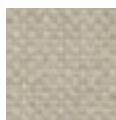

1716

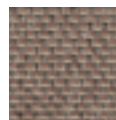

1778



1779



1780



1726



1717



1718



1727



1722

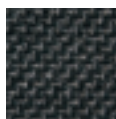

1723

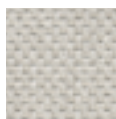

1728

Jacquard Three / Grade 1

Composition / Composición
 79% PES. 21% Recycled yarn
 from GRS Bottles and textile
 waste
 79% PES. 21% Hilo reciclado de
 botellas GRS y residuos textiles

Martindale test /
 66.000 Cycles / Ciclos
 (EN ISO 12947-2:1998)

Certifications / Certificados
 BS5852 Source 0/EN ISO 1021-
 1:2006 • CAL TB-117

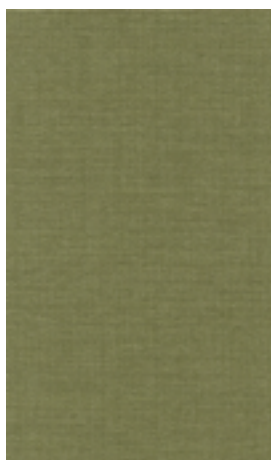

1953



1757



1758



1759



1950



1951

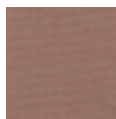

1952



1954



1955

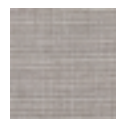

1970

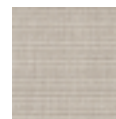

1971



1972

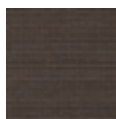

1973



1974



1975



1976



1977

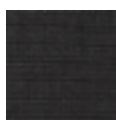

1978

Tapicerías

Andreu World Textiles

Jacquard Four / Grade 3

Composition / Composición
34% WO. 28% PES. 23% PP.
15%CO

Martindale test /
Resistencia a la abrasión
62.000 Cycles / Ciclos
(EN ISO 12947/2)

Certifications / Certificados
BS5852 0/1 ● EN 1021 1/2 ●
BS7176 Low hazard ● BS7176
Medium hazard ● CAL TB117 ●
NFPA 260:2013



2256



2251



2253



2257



2260



2263

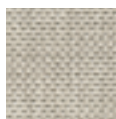

2282



2283



2284

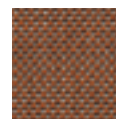

2285

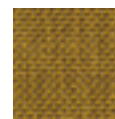

2288

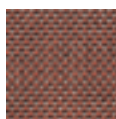

2289

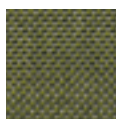

2291

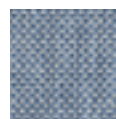

2293



2294

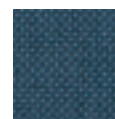

2295



2296

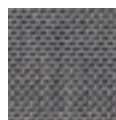

2297



2298



2299

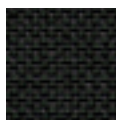

2300



2301

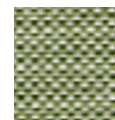

2302

Jacquard Five / Grade 3

Composition / Composición
80% PES. 11% PET Recycled
bottles GRS. 4&CO. 5% CO.
Recycled GRS
80% PES. 11% PET Reciclado
botellas GRS. 4&CO. 5% CO.
reciclado GRS

Martindale test /
Resistencia a la abrasión
200.000 Cycles / Ciclos
(EN ISO 12947/2)

Certifications / Certificados
BS5852 Source 0 ● EN1021-Part 1
● CAL TB 117 ● NFPA 260



2136

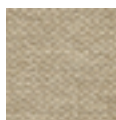

2135

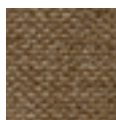

2138



2137



2139



2130



2131



2132



2142



2140

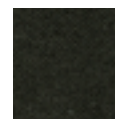

2141

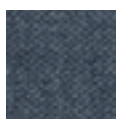

2143



2144



2133



2134

Andreu World Textiles

Jacquard Four Special / Grade 4

Composition / Composición
 47%PP 26%WO 16%PES 6%MA
 5%CO

Martindale test /
 Resistencia a la abrasión
 37.500 Cycles / Ciclos
 (EN ISO 12947/2)

Certifications / Certificados
 BS5852 source 0 ● EN 1021-
 1:2006 ● BS5852 source 1 ● EN
 1021-2:2006 ● CAL TB 117



2347



2344



2268



2345



2346



2348



2271



2350



2272



2352



2275



2353



2278



2354

Sand / Grade 1

IN/OUT



1184



1180

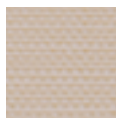

1181



1183



1182

Composition / Composición
 100% Dyed Acrylic Solution
 100% Acrílico teñido en masa

Martindale test /
 Resistencia a la abrasión
 17.000 Cycles / Ciclos

Tapicerías

Andreu World Textiles

Loom One / Grade 2

Composition / Composición
 100% Polyester-Trevira CS
 100% Poliéster-Trevira CS

Martindale test /
 Resistencia a la abrasión
 70.000 Cycles / Ciclos
 (EN ISO 12947/2)

Certifications / Certificados
 UNI 9174-8456 Class C1 • DIN
 4102 Class B1 • NF 92501-7 Class
 M1 • CRIB 5 • EN 1021/1-2 • IMO
 Part 8 Upholstery • UNI 9175 Class
 1IM • BS 7176 Medium Hazard •
 NF D 60013 Class AM 18

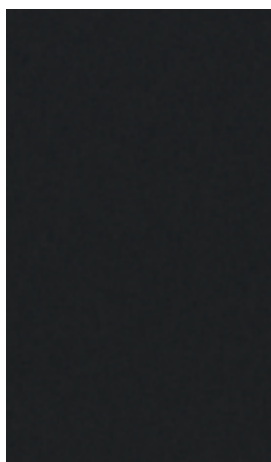

I015

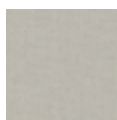

I001



I002



I003

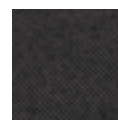

I004



I005



I006



I007



I008



I009



I010



I011



I012



I013



I014

Loom Two / Grade 3 IN/OUT

Composition / Composición
 100% PP

Martindale test /
 Resistencia a la abrasión
 20.000 Cycles / Ciclos
 (EN ISO 12947/2)

Certifications / Certificados
 BS 5852:1990 sez 4 part 1
 (Cigarette Test)



I065



I057

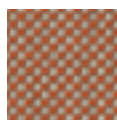

I058

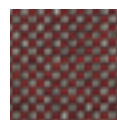

I059



I060



I061

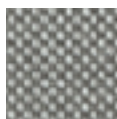

I062

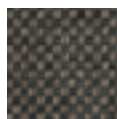

I063

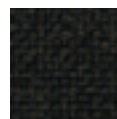

I064

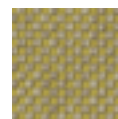

I066



I067

Andreu World Textiles

Loom Three / Grade 4

Composition / Composición
 100% Polyester-Trevira CS
 100% Poliéster-Trevira CS

Martindale test /
 Resistencia a la abrasión
 75.000 Cycles / Ciclos
 (EN ISO 12947/2)

Certifications / Certificados
 UNI 9174-8456 Class C1 ● DIN
 4102 Class B1 ● NF 92501-7 Class
 M1 ● CRIB 5 ● EN 1021/1-2 ● IMO
 Part 8 Upholstery ● UNI 9175 Class
 1IM ● BS 7176 Medium Hazard ●
 NF D 60013 Class AM 18



I030

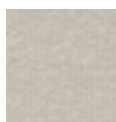

I022



I023



I024



I025



I026



I027

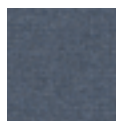

I028



I029



I031



I032



I033



I034



I035



I036

Loom Four / Grade 4

Composition / Composición
 100% Polyester-Trevira CS
 100% Poliéster-Trevira CS

Martindale test /
 Resistencia a la abrasión
 150.000 Cycles / Ciclos
 (EN ISO 12947/2)

Certifications / Certificados
 UNI 9174-8456 Class C1 ● DIN
 4102 Class B1 ● NF 92501-7 Class
 M1 ● CRIB 5 ● EN 1021/1-2 ● IMO
 Part 8 Upholstery ● UNI 9175 Class
 1IM ● BS 7176 Medium Hazard ●
 NF D 60013 Class AM 18

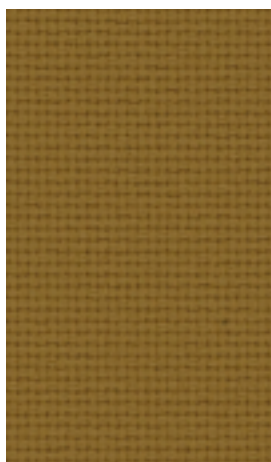

I042

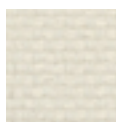

I037

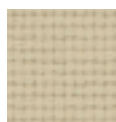

I038

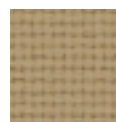

I039

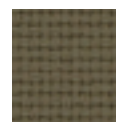

I040



I041



I043

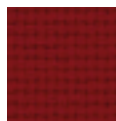

I044



I045



I046



I047

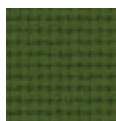

I048



I049



I050



I051



I052



I053



I054

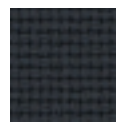

I055

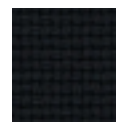

I056

Tapicerías

Andreu World Textiles

Circular ONE / Grade 2 PURE ECO

Composition / Composición
100% PES recycling / reciclado

Martindale test /
Resistencia a la abrasión
>100.000 Cycles / Ciclos

Certifications / Certificados
BS5852 Source 0 ● EN 1021-Part
1 ● CAL TB 117 ● NFPA 260 ● EN
12947-2:1998 ● EN 12945/2:2000
● EN 105-B02:1998 & 105 B02/
A01:2002 ● Oekotex certified ●
REACH approved chemicals
and dyes ● Biocide and PFCs
free ● Zero-waste production ●
Manufactured under ISO 9001
and ISO 14001 standards



2424

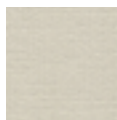

2420



2421



2422



2423



2425



2426



2427



2428



2429



2430

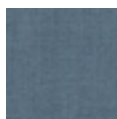

2431

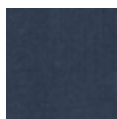

2432



2433

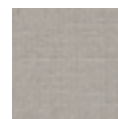

2434



2435



2436

Andreu World Textiles

Reel One / Grade 1 IN/OUT

Composition / Composición
 100% Fibra acrílica tintada en masa
 100% Solution-dyed acrylic fiber

Martindale test /
 Resistencia a la abrasión
 30.000 Cycles / Ciclos
 (EN ISO 12947/2)



R059

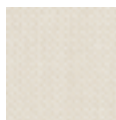

R050

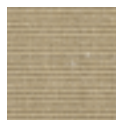

R053



R054



R051



R055



R056



R057



R058



R052



R060



R062



R065



R066



R067



R061



R063

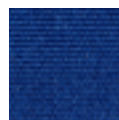

R064



R068



R070

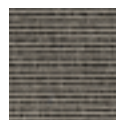

R071



R069



R072

Reel Two / Grade 3 IN/OUT

Composition / Composición
 100% Fibra acrílica tintada en masa
 100% Solution-dyed acrylic fiber

Martindale test /
 Resistencia a la abrasión
 30.000 Cycles / Ciclos
 (EN ISO 12947/2)



R078



R073



R074

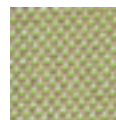

R075



R076

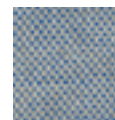

R077

Tapicerías

Andreu World Textiles

Reel Three / Grade 4 IN/OUT

Composition / Composición
100% Fibra acrílica tintada en masa
100% Solution-dyed acrylic fiber

Martindale test /
Resistencia a la abrasión
30.000 Cycles / Ciclos
(EN ISO 12947/2)

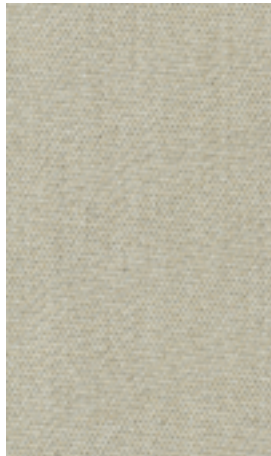

R079



R080



R081



R082

Reel Four / Grade 4 IN/OUT

Composition / Composición
100% Fibra acrílica tintada en masa
100% Solution-dyed acrylic fiber

Martindale test /
Resistencia a la abrasión
30.000 Cycles / Ciclos
(EN ISO 12947/2)



R083

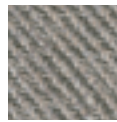

R084

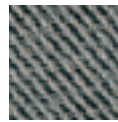

R085

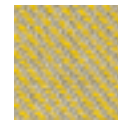

R086

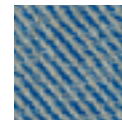

R087



R088

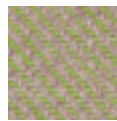

R089

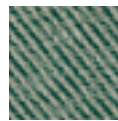

R090

Andreu World Textiles

Spin One / Grade 1

Composition / Composición
 49.5% PAC., 38,5%PES., 12%CO
 49.5% PAC., 38,5%PES., 12%CO

Martindale test /
 Resistencia a la abrasión
 35.000 Cycles / Ciclos
 (EN ISO 12947/2)



2716



2710

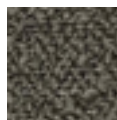

2711



2712



2713



2714

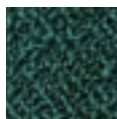

2715



2717



2718



2719

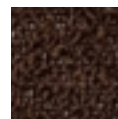

2720

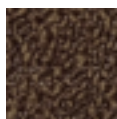

2721



2722



2723



2724



2725



2726

Spin Two / Grade 1

Composition / Composición
 54%PES., 38%CO, 5% PAC., 2%
 VIS, 1% OF.
 54%PES., 38%CO, 5% PAC., 2%
 VIS, 1% OF.

Martindale test /
 Resistencia a la abrasión
 50.000 Cycles / Ciclos
 (EN ISO 12947/2)



2733



2730



2731



2732



2734



2735

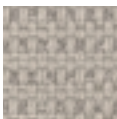

2736



2737

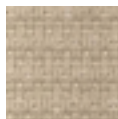

2738

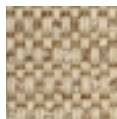

2739

Tapicerías

Andreu World Textiles

Spin Three / Grade 1

Composition / Composición
69%PES., 30%CO, 1% PA.
69%PES., 30%CO. 1% PA.

Martindale test /
Resistencia a la abrasión
70.000 Cycles / Ciclos
(EN ISO 12947/2)



2757

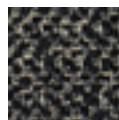

2745

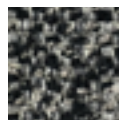

2746



2747

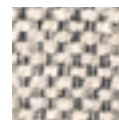

2748

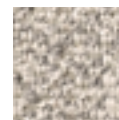

2749

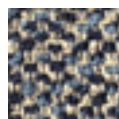

2750



2751



2752

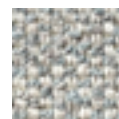

2753



2754



2755

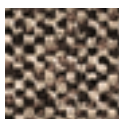

2756

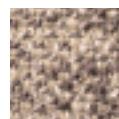

2758

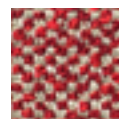

2759

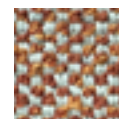

2760

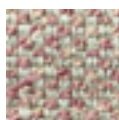

2761



2762



2763



2764

Spin Four / Grade 1

Composition / Composición
54%PAC., 35%PES., 11% CO
54%PAC., 35%PES., 11% CO

Martindale test /
Resistencia a la abrasión
30.000 Cycles / Ciclos
(EN ISO 12947/2)



2782

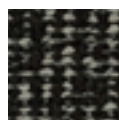

2770

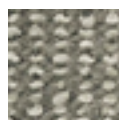

2771

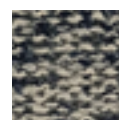

2772

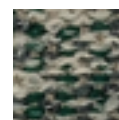

2773

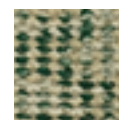

2774



2775

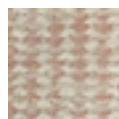

2776

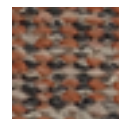

2777

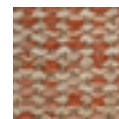

2778



2779

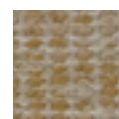

2780



2781

Andreu World Textiles

Spin Five / Grade 1

Composition / Composición
52%PAC., 39%PES., 9% CO.
52%PAC., 39%PES., 9% CO.

Martindale test /
Resistencia a la abrasión
50.000 Cycles / Ciclos
(EN ISO 12947/2)



2793

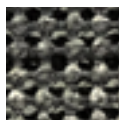

2785

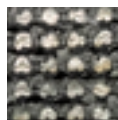

2786

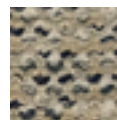

2787

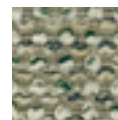

2788



2789

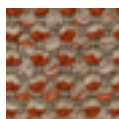

2790



2791



2792

Spin Six / Grade 4

Composition / Composición
80%PP., 14%PES. REC., 3% CO.
REC.3% OF. REC.
80%PP., 14%PES. REC., 3% CO.
REC.3% OF. REC.

Martindale test /
Resistencia a la abrasión
80.000 Cycles / Ciclos
(EN ISO 12947/2)

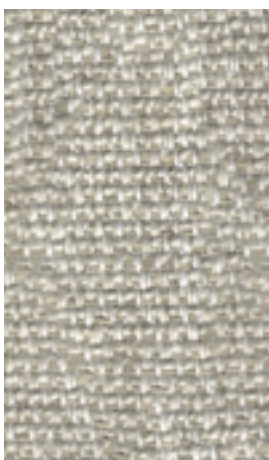

2165

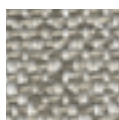

2166

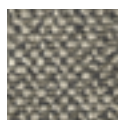

2167



2168



2169

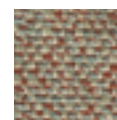

2170

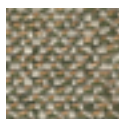

2171



2172

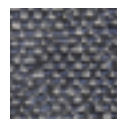

2173

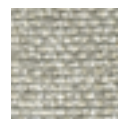

2174



2175



2176



2177

Tapicerías

Andreu World Textiles

Tack One / Grade 2 IN/OUT

Composition / Composición
60% PP, 40% PES REC
60% PP, 40% PES REC

Martindale test /
Resistencia a la abrasión
60.000 Cycles / Ciclos
(EN ISO 12947/2)



2442



2440

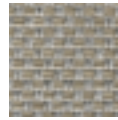

2441



2443



2444

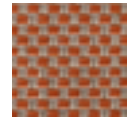

2445

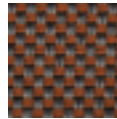

2446

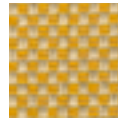

2447

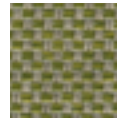

2448

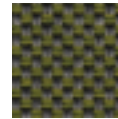

2449

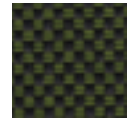

2450

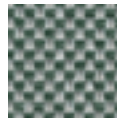

2451

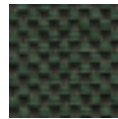

2452

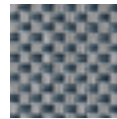

2453

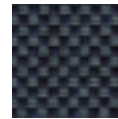

2454



2455

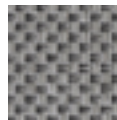

2456



2457

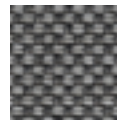

2458



2459



2470

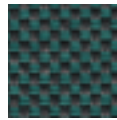

2471

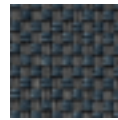

2472

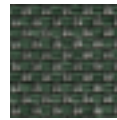

2473

Andreu World Textiles

Tack Two / Grade 6 IN/OUT

Composition / Composición
 82% PP., 18%PES. REC.
 82% PP., 18%PES. REC.

Martindale test /
 Resistencia a la abrasión
 100.000 Cycles / Ciclos
 (EN ISO 12947/2)



2178

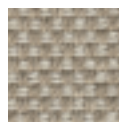

2179

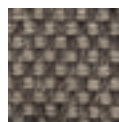

2180

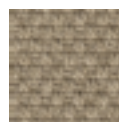

2181



2182

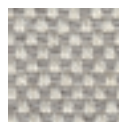

2183

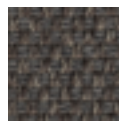

2184

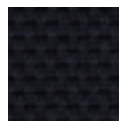

2185

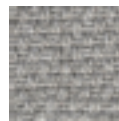

2186

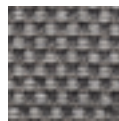

2187

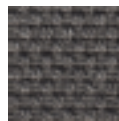

2188

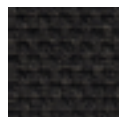

2189

Tack Three / Grade 6 IN/OUT

Composition / Composición
 100% PET.
 100% PET.

Martindale test /
 Resistencia a la abrasión
 100.000 Cycles / Ciclos
 (EN ISO 12947/2)

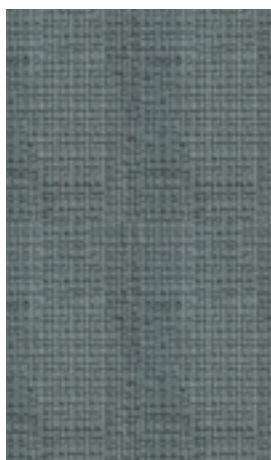

2826



2810



2811

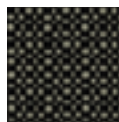

2812

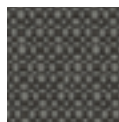

2813

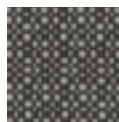

2814



2815



2816



2817



2818



2819

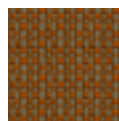

2820

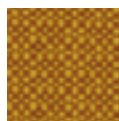

2821

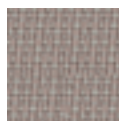

2822

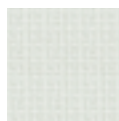

2823



2824

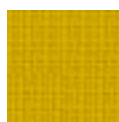

2825



2827



2829

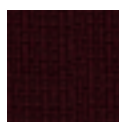

2829

Tapicerías

Andreu World Textiles

Tack Four / Grade 9 IN/OUT

Composition / Composición
100% PET
100% PET

Martindale test /
Resistencia a la abrasión
50.000 Cycles / Ciclos
(EN ISO 12947/2)



2831



2830

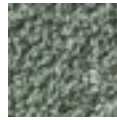

2832



2833

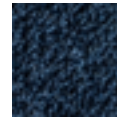

2834



2835



2836

Tack Five / Grade 7 IN/OUT

Composition / Composición
PP 100%
PP 100%

Martindale test /
Resistencia a la abrasión
100.000 Cycles / Ciclos
(EN ISO 12947/2)



L068



L069

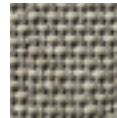

L070



L071



L072

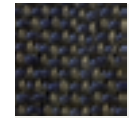

L073

Camira Textiles / Telas Camira

Citadel / Grade 1

Composition / Composición
 100% Flame Retardant
 Polypropylene
 Polipropileno 100% ignífugo

Martindale test /
 Resistencia a la abrasión
 >30.000 Cycles / Ciclos

Certifications / Certificados
 BS EN 1021-1 Cigarette ● BS EN
 1021 - 2 Match ● BS 7176 Low
 Hazard ● DIN 4102 B1 ● ÖNORM B
 3825 & A3800-1 (58Kg/m³ CMHR
 Foam) ● UNI 9175 Classe 1 IM
 ● EN 13501-1 Adhered Class B,
 s1, d0 ● EN 13501-1 Un-adhered
 Class B, s1, d2



FL833
Confine



FL010
Hamilton

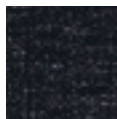

FL768
Ralstone

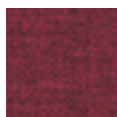

FL826
Hold



FL019
Craven



FL801
Bingham



FL828
Drawbridge



FL076
Redstone



FL821
Fortress



FL829
Abide



FL125
Augusta



FL822
Beacon



FL830
Resistance



FL757
Stillwater



FL824
Hideaway



FL832
Redoubt

Camira Textiles / Telas Camira

Gravity / Grade 1

Composition / Composición
100% Polyester
100% Poliéster

Martindale test /
Resistencia a la abrasión
>80.000 Cycles / Ciclos

Certifications / Certificados
EN 1021-1 Cigarette • EN 1021 - 2
Match • BS 7176 Low Hazard



CPC28
Aqua

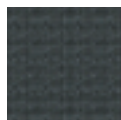

CPC16
Slate

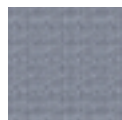

CPC17
Dove

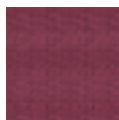

CPC01
Petal



CPC06
Botanic

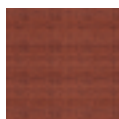

CPC11
Tigerlily



CPC20
Sunni

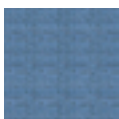

CPC27
Frozen

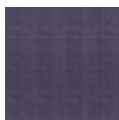

CPC02
Lavender



CPC07
Gooseberry

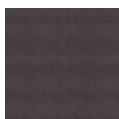

CPC12
Nutmeg

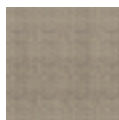

CPC21
Wheat



CPC29
Lagoon



CPC03
Berry



CPC08
Evergreen



CPC13
Rose



CPC23
Fresh



CPC30
Navy Blue



CPC04
Brook



CPC09
Lake



CPC14
Mustard



CPC25
Tulip



CPC31
Black



CPC05
Dewdrop



CPC10
Almond



CPC15
Ice

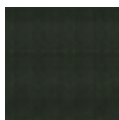

CPC26
Military



CPC32
Frost

Camira Textiles / Telas Camira

Rivet / Grade 1

Composition / Composición
 100% REPREVE Recycled Polyester
 100% REPREVE Poliéster reciclado

Martindale test / Resistencia a la abrasión
 >80.000 Cycles / Ciclos

Certifications / Certificados
 EN 1021-1 Cigarette • EN 1021 - 2 Match • BS 7176 Low Hazard • UNI 9175 Classe 1 IM



EGL48
Deep Sea



EGL01
Vitreous



EGL03
Wire



EGL04
Resin

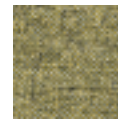

EGL05
Alloy



EGL07
Tungsten



EGL08
Fuse



EGL09
Molten



EGL10
Spark



EGL11
Burnish

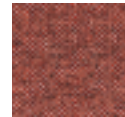

EGL12
Forge



EGL13
Abraid



EGL14
Cooper



EGL15
Ferrous

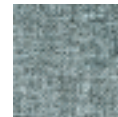

EGL16
Prime

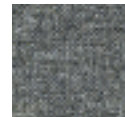

EGL18
Solder



EGL19
Chromoly



EGL20
Tensile

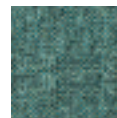

EGL21
Verdigris



EGL23
Quench



EGL24
Crucible



EGL25
Cast



EGL26
Galvanise



EGL27
Hammer

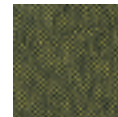

EGL31
Olive



EGL32
Deep Clay



EGL33
Woodrose



EGL34
Hemlock

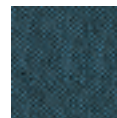

EGL35
Lagoon



EGL36
Otter



EGL37
Charcoal



EGL49
Twig

Camira Textiles / Telas Camira

Urban / Grade 1

Composition / Composición
 100% Recycled Flame Retardant
 Polyester. Non metallic dyestuffs
 100% poliéster ignífugo reciclado.
 Colorantes no metálicos.

Martindale test /
 Resistencia a la abrasión
 >100.000 Cycles / Ciclos

Certifications /Certificados
 EN 1021-1 Cigarette ● EN 1021 - 2
 Match ● BS 5852 Ignition Source 5
 ● NF D 60-013 ● ÖNORM A 3800-1

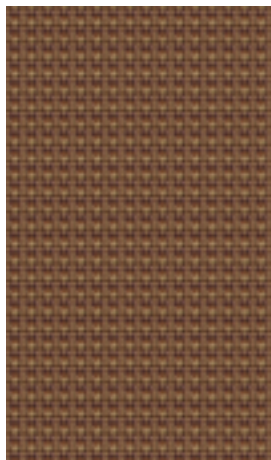

**YN091
Bench**



**YN009
Subway**



**YN083
Junction**

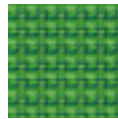

**YN159
Suburbia**

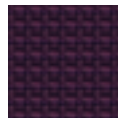

**YN204
Graffiti**



**YN209
Streetsmart**

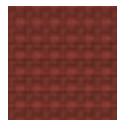

**YN027
Precinct**

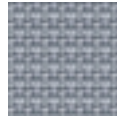

**YN094
Sidewalk**



**YN160
Boulevard**

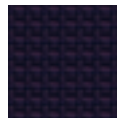

**YN205
Intersection**



**YN210
Nightowl**



**YN076
Highrise**



**YN108
Living**



**YN200
Uptown**



**YN206
Curb**

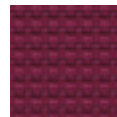

**YN211
Freeway**



**YN079
Congestion**



**YN145
Underground**



**YN202
Penthouse**



**YN207
Square**



**YN212
District**



**YN082
Conurbation**

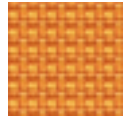

**YN148
Avenuev**



**YN203
Cosmopolitan**



**YN208
Ringroad**

Camira Textiles / Telas Camira

Era / Grade 1

Composition / Composición
100% Polyester
100% Poliéster

Martindale test /
Resistencia a la abrasión
>100.000 Cycles / Ciclos

Certifications / Certificados
EN 1021-1 Cigarette ● EN 1021 - 2
Match ● BS 7176 Low Hazard ● EN
13501-1 Adhered Class B, s1, d0
● EN 13501-1 Un-adhered Class
C, s1, d0



**CSE46
Memo**

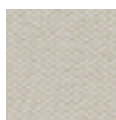

**CSE01
Futurist**



**CSE02
Generation**



**CSE03
Lifetime**



**CSE05
Span**



**CSE06
Cycle**



**CSE07
Period**



**CSE08
Chapter**



**CSE09
Prime**

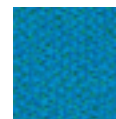

**CSE10
Everlasting**



**CSE11
Forecast**



**CSE12
Perennial**

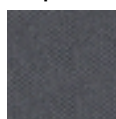

**CSE13
Present**



**CSE14
Forward**



**CSE15
Stage**



**CSE16
Timelapse**



**CSE17
Phase**



**CSE18
Event**



**CSE19
Calendar**



**CSE20
Aeon**



**CSE21
History**



**CSE23
Occurrence**



**CSE24
Date**



**CSE25
Sequence**



**CSE26
Turn**



**CSE27
Measure**

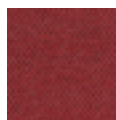

**CSE28
Extent**



**CSE29
Experience**



**CSE30
Transition**



**CSE31
Splitsecond**



**CSE32
Occasion**



**CSE33
Analogue**



**CSE34
Endurance**



**CSE35
Signature**



**CSE36
Notation**



**CSE37
Rest**



**CSE38
Allowance**



**CSE39
Youth**



**CSE40
Maturity**



**CSE41
Quota**



**CSE42
Range**



**CSE43
Late**



**CSE44
Prompt**



**CSE45
Ringroad**

Tapicerías

Camira Textiles / Telas Camira

Main Line Flax / Grade 3

Composition / Composición
70% Virgin Wool, 30% Flax
70% Lana Virge 30% Lino

Martindale test /
Resistencia a la abrasión
35.000 Cycles / Ciclos

Certifications / Certificados
BS7176 Low Hazard • BS 7176
Medium Hazard • BS 5867-2 type
B Curtains & Drapes • UNI 9175
Classe 1 IM • ACENORM B 3825&A
3800-1



MLF14
Parson

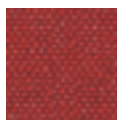

MLF01
Aldgate



MLF02
Arcway

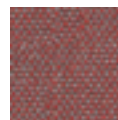

MLF03
Barbican

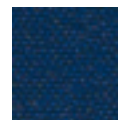

MLF05
Holborn



MLF06
Kilburn



MLF07
Kensington



MLF08
Lambeth



MLF09
Monument



MLF10
Newbury



MLF12
Modern



MLF13
Leyton

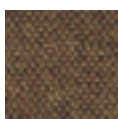

MLF15
Stockwell



MLF16
Temple



MLF17
Tooting



MLF18
Tufnell



MLF19
Victoria

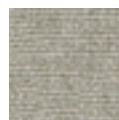

MLF20
Upminster

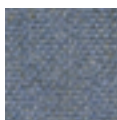

MLF21
Waterloo



MLF22
Westminster



MLF23
Bank



MLF24
Bayswater



MLF25
Bethnal

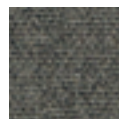

MLF26
Camden

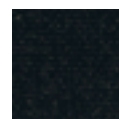

MLF28
Edware



MLF29
Farringdon



MLF31
Goldhawk



MLF32
Greenford



MLF34
Pimlico

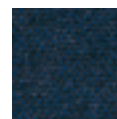

MLF35
Brompton

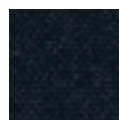

MLF36
Tower



MLF37
Stanmore

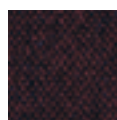

MLF40
Northfields



MLF43
Alperton



MLF44
Balham

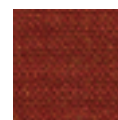

MLF45
Barking



MLF46
Blackwall



MLF47
Brixton



MLF48
Chigwell



MLF49
Clapham



MLF50
Embankment



MLF51
Epping



MLF52
Greenwich



MLF53
Hampstead



MLF54
Harrow



MLF55
Hornchurch



MLF56
Kentish

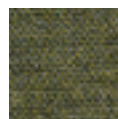

MLF57
Moorgate



MLF59
Perivale



MLF60
Pinner



MLF61
Redbridge



MLF62
Camden



MLF63
Shadwell



MLF64
Stratford



MLF65
Watford



MLF66
Whitechapel



MLF67
Woodford

Camira Textiles / Telas Camira

Nexus / Grade 4

Composition / Composición
100% Polyester. Non metallic
dyestuffs
100% poliéster. Colorantes no
metálicos.

Martindale test /
Resistencia a la abrasión
>100.000 Cycles / Ciclos

Certifications / Certificados
EN 1021-1 Cigarette ● EN 1021 - 2
Match ● BS 7176 Low Hazard ●
UNI 9175 Classe 1 IM ● BS 476
Part 7 Class 1 (Adhered) ● EN
13501-1 Adhered Class B, s1, d0
● EN 13501-1 Un-adhered Class
B, s1, d2

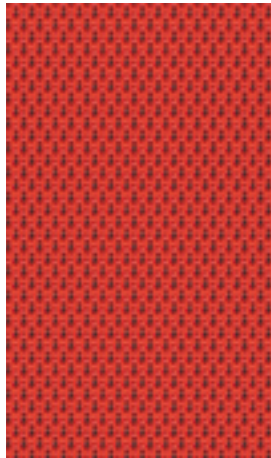

UNY04
Berry



UNY01
Pewter

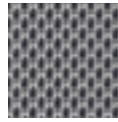

UNY02
Limestone



UNY03
Pacific

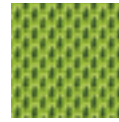

UNY05
Kiwi



UNY07
Storm



UNY08
Denim

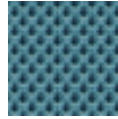

UNY10
Petrol



UNY11
Graphite

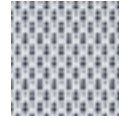

UNY12
Chalk



UNY13
Black



UNY15
Oceanic



UNY16
Russian

Oceanic / Grade 4

Composition / Composición
100% Post-consumer recycled
polyester, including 50% Seaqual
yarn.
100% Poliéster reciclado
posconsumo, incluido 50% hilo
Seaqual.

Martindale test /
Resistencia a la abrasión
≥100.000 Cycles / Ciclos

Certifications / Certificados
California Technical Bulletin 117-
2013 ● BS 7176 Low Hazard ●
BS 7176 Medium Hazard with
EnviroFlam5 ● ASTM E84 Class 1 or
A (Un-adhered)



OOC16
Seafarer



OOC02
Jetsam



OOC03
Coast



OOC04
Sea



OOC05
Coral



OOC06
Atoll



OOC07
Barrier

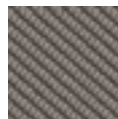

OOC08
Bay

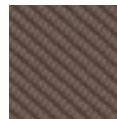

OOC09
Shore

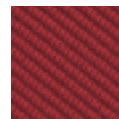

OOC10
Abyss



OOC11
Neptune



OOC12
Aquatic



OOC13
Paddle



OOC14
Riptide

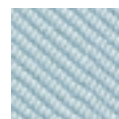

OOC15
Gulf



OOC01
Flotsam

Tapicerías

Camira Textiles / Telas Camira

Synergy / Grade 5

Composition / Composición
 95% Wool 5% Polyamida
 95% Lana 5% Poliamida

Martindale test /
 Resistencia a la abrasión
 80.000 Cycles / Ciclos

Certifications / Certificados
 EN 1021 - 1 Cigarette • EN 1021 -
 2 Match • BS 7176 Low Hazard •
 NF D 60-013



LDS54
Regard



LDS05
Venture



LDS07
Fate



LDS08
Serendipity

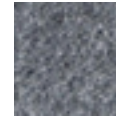

LDS16
Partner



LDS17
Mix

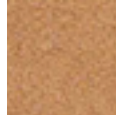

LDS18
Loop

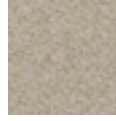

LDS19
Chain

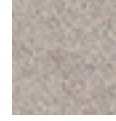

LDS20
Level



LDS21
Team



LDS22
Frame

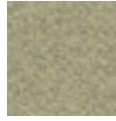

LDS23
Bracket

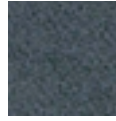

LDS24
Bond

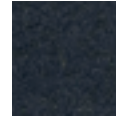

LDS25
Compound

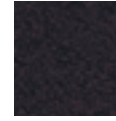

LDS26
Bridge

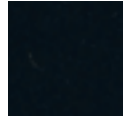

LDS27
Seek



LDS28
Lateral

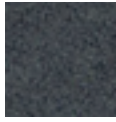

LDS29
Hook

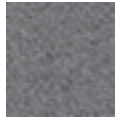

LDS31
Pair

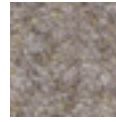

LDS32
Affix



LDS33
Tag



LDS34
Wed

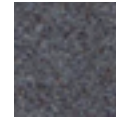

LDS35
Chemistry

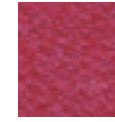

LDS36
Medley

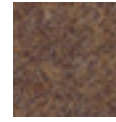

LDS37
Linea



LDS38
Unity

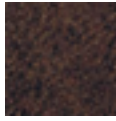

LDS39
Collective

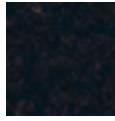

LDS40
Co-operate

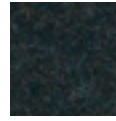

LDS41
Couple

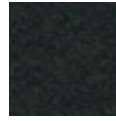

LDS42
Intertwine



LDS43
Marry



LDS44
Relate

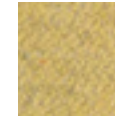

LDS45
Summon



LDS46
Gather



LDS47
Integrate



LDS48
Interfuse

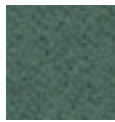

LDS49
Append



LDS50
League



LDS51
Kindness



LDS52
Comply



LDS53
Pact



LDS55
Support

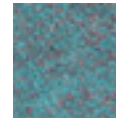

LDS56
Kinship



LDS57
Engage



LDS58
Family

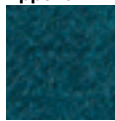

LDS59
Group

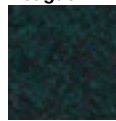

LDS60
Accord

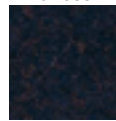

LDS61
Assemble

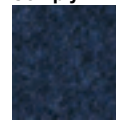

LDS62
Alike



LDS63
Gulid



LDS64
Order

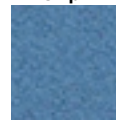

LDS65
Huddle



LDS66
Fellowship

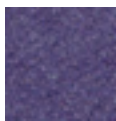

LDS67
Warmth



LDS68
Collaborate

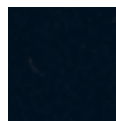

LDS69
Sync

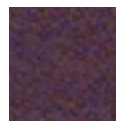

LDS70
Together

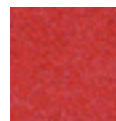

LDS71
Open

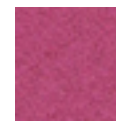

LDS72
Compose



LDS73
Work



LDS74
Affinity



LDS75
Contribution

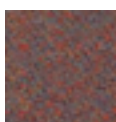

LDS76
Success

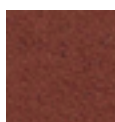

LDS77
Combo



LDS78
Cordial

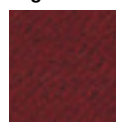

LDS79
Amiable

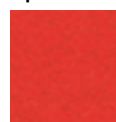

LDS80
Apt



LDS81
Similar



LDS82
Likeness



LDS83
Congregate

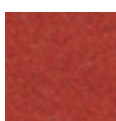

LDS84
Mutual

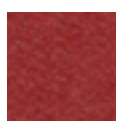

LDS85
Share

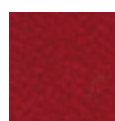

LDS86
Global



LDS87
Values

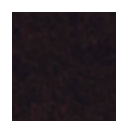

LDS88
Process

Fabrics

Camira Textiles / Telas Camira

Silk / Grade 5

Composition / Composición
67% Wool 22% Flax 11% Recycled
silk
67% Lana 22% Lino 11% Seda
reciclada

Martindale test /
Resistencia a la abrasión
35.000 Cycles / Ciclos

Certifications / Certificados
EN 1021 - 1 Cigarette • EN 1021
- 2 Match • BS 7176 Low Hazard
• NF D 60-013 • BS 5852 Ignition
Source 5 • BS 7176 Medium
Hazard • UNI 9175 Classe 1 IM
• BS 5867-2: Type B Curtains &
Drapes



SLK20
Imeon

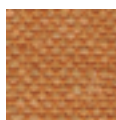

SLK01
Sahara



SLK02
Arabia



SLK03
Byzantine



SLK05
Empress



SLK06
Incense

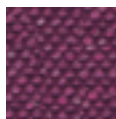

SLK07
Forbidden

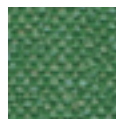

SLK08
Brunei

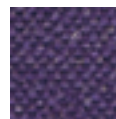

SLK09
Parthian



SLK10
Kingdom

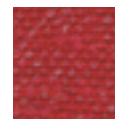

SLK12
Oriental



SLK13
Divine

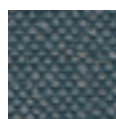

SLK14
Pamir

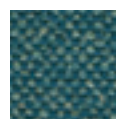

SLK15
Monarch



SLK16
Emperor



SLK17
Dynasty

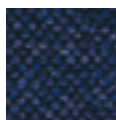

SLK19
Chancellor

Camira Textiles / Telas Camira

Blazer / Grade 5

Composition / Composición
 100% Virgin Wool. Non metallic
 dyestuffs
 Lana 100% virgen. Colorantes no
 metálicos.

Martindale test /
 Resistencia a la abrasión
 >50.000 Cycles / Ciclos

Certifications / Certificados
 EN 1021 - 1 Cigarette ● EN 1021 -
 2 Match ● BS 7176 Low Hazard ●
 NF D 60-013 ● ÖNORM B 3825 &
 A 3800-1 (58kg/m³CMHR Foam)
 ● UNI 9175 Classe 1 IM ● BS
 476 Part 7 Class 1 ● EN 13501-1
 Adhered Class D, s1, d0 ● BS 5852
 Ignition Source 5 when FR treated
 ● BS 7176 Medium Hazard when
 FR treated ● BS 476 Part 6 Class
 0 when FR treated ● EN 13501-1
 Adhered Class B, s1, d0 when FR
 treated ● EN 13501-1 Un-adhered
 Class D, s2, d0 when FR treated
 ● BS 5867-2: Type B Curtains &
 Drapes when FR treated

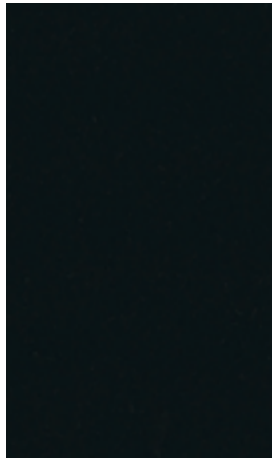

CUZ08
Napier



CUZ53
Bryanston

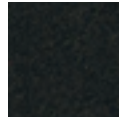

CUZ1M
Glasgow



CUZ1F
Ulster



CUZ2T
Holyoke

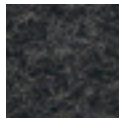

CUZ30
Silcoates



CUZ1E
Surrey



CUZ58
Dunhurst



CUZ82
Wesley

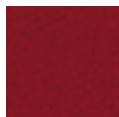

CUZ13
Wellington



CUZ3D
Barlborough



CUZ3C
Marymount



CUZ09
Oxford



CUZ33
Latymer



CUZ3B
Abertay

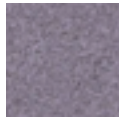

CUZ1T
Sheffield



CUZ28
Silverdale



CUZ2W
Eynesbury



CUZ2R
Stanford



CUZ1R
Plymouth



CUZ1V
Manchester



CUZ2Z
Woodcroft



CUZ2X
Penola



CUZ3E
Scottsdale



CUZ1J
Aberlour

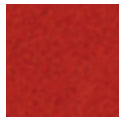

CUZ39
Goldsmith



CUZ2S
Barnard



CUZ1Y
Edinburgh



CUZ2U
Vassar



CUZ26
Knightsbridge



CUZ1K
Camphill



CUZ67
Kingsmead



CUZ2Q
Dartmouth

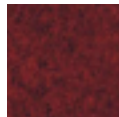

CUZ90
Edge Hill

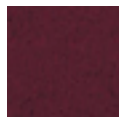

CUZ21
Magdalene



CUZ1W
Newcastle



CUZ2Y
Tyndale



CUZ1L
Newport



CUZ3A
Montcrest



CUZ35
Bromsgrove

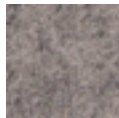

CUZ86
St Andrews



CUZ18
Oriel

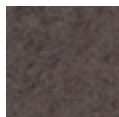

CUZ31
Trevelyan

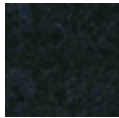

CUZ62
Gienalmond



CUZ02
Aston



CUZ1P
Hull



CUZ1N
Cardiff



CUZ12
Winchester

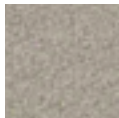

CUZ47
Fairfield



CUZ63
Handcross

Gabriel Textiles / Telas Gabriel

Medley / Grade 3

Composition / Composición
100% Polyester
100% Poliéster

Martindale test /
Resistencia a la abrasión
75.000 Cycles / Ciclos

Certifications / Certificados
BS EN 1021 1&2 Cigarette and
Match ● BS EN 1021-1 Cigarette
● BS 5852 Part 1 0,1 Cigarette &
match ● BS 476 Part 7, class 2 ●
Class Uno UNI 9174 - UNI 8457 ●
ÓNORM B 3825-B2-3800-Q1 UK ●
CA TB 117-2013 ● ASTM E 84



68114

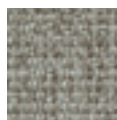

60003

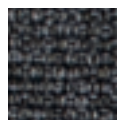

60004



60167

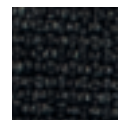

60999

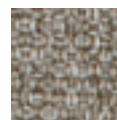

61002



61003

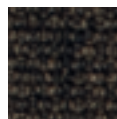

61004



61189



62002



62054

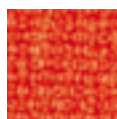

63013



63016



63017



63063

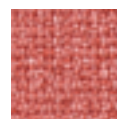

63064

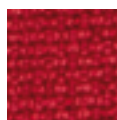

64019

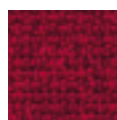

64123



64124



64125



65011



65012



65086



66007



66008



66009



66010



66144

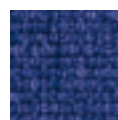

66145



67002



67006



67052



67053



67054



68002



68005



68115

Gabriel Textiles / Telas Gabriel

Cura / Grade 4

Composition / Composición
 98% post-consumer recycled polyester / 2% polyester
 98% poliéster reciclado postconsumo / 2% poliéster

Martindale test / Resistencia a la abrasión
 100.000 Cycles / Ciclos

Certifications / Certificados
 ASTM D4157-07 Wyz • ASTM D3511 Pilling • CA TB 117-2013 • AATCC 16 • AATCC 8 or 116 • EN 29053 & ISO 9053-1 • BS EN 1021 1&2 Cigarette and Match • BS 5852 Part 1 0,1 Cigarette & match • CA TB 117-2013

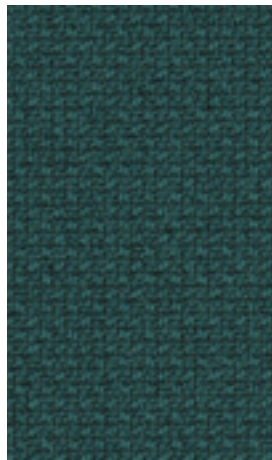

68264



60000



60019

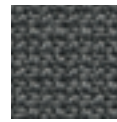

60109

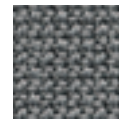

60110

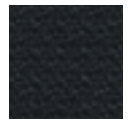

60111

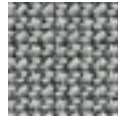

60112

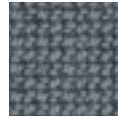

60327

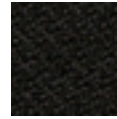

60999

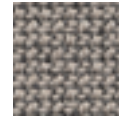

61168



61169



61232



61233

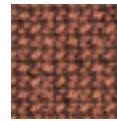

61257



61258



61259



61260

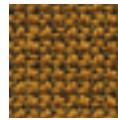

62082

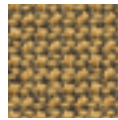

62083

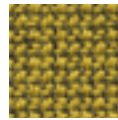

62084



62125

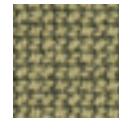

62126

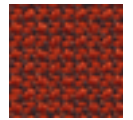

63012



63078

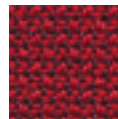

64013

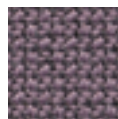

64194



64195

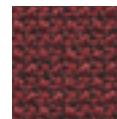

64196

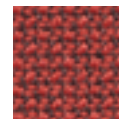

64197



64240

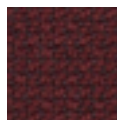

64252

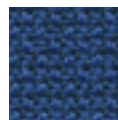

65105

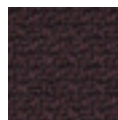

65137

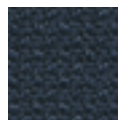

66165

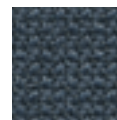

66166

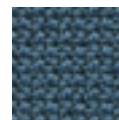

66167

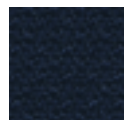

66169

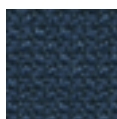

66170

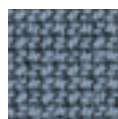

66239

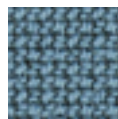

66240



67084

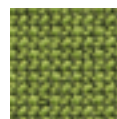

68180



68181



68182



68183



68186

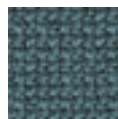

68187



68261



68262

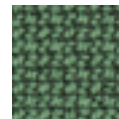

68263

Gabriel Textiles / Telas Gabriel

Noma / Grade 5

Composition / Composición
100% recycled polyester
100% poliéster reciclado

Martindale test /
Resistencia a la abrasión
60.000 Cycles / Ciclos

Certifications / Certificados
CA TB 117-2013 • ASTM D4157-07 Wyz • ASTM D3511 • AATCC 8 or 116 • AATCC 16 • EN 29053 & ISO 9053-1 • NFP 92-503/504/505 M1 • DIN 4102 - B1 • BS 7176 Medium hazard • BS EN 1021 1&2 Cigarette and Match • BS 5852 Crib 5 • BS 5852 Part 1 0,1 Cigarette & match Class Uno • UNI 9175 Class 1 | EMME • AM 18 - NF D 60-013 • CA TB 117-2013

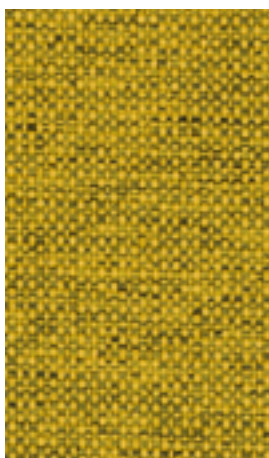

62102

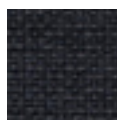

60135



60136

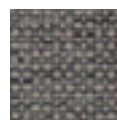

60137



60138



60999

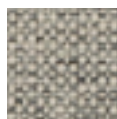

61191



61192

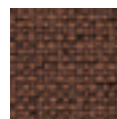

61193



62101



63103



64217



64218

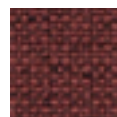

64219



64220



66195



66196



66197

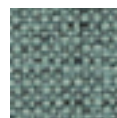

67102



67103



67104



67105



67106



67107



68212



68213



68214

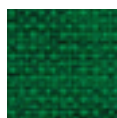

68215



68216



68217

Gabriel Textiles / Telas Gabriel

Step / Grade 5

Composition / Composición
100% Trevira CS

Martindale test /
Resistencia a la abrasión
100.000 Cycles / Ciclos

Certifications / Certificados
IMO MSC 307(88) Annex 1 part 8
● MED Certificate IMO ● DIN 4102
B1 ● NFP 92-503/504/505 M1 ● BS
EN 1021 1&2 Cigarette and Match ●
BS EN 1021-1 Cigarette ● BS 5852
Part 1 0,1 Cigarette & match ● BS
5852 Crib 5 ● ÖNORM B 3825-B1-
3800-Q1 UK ● FAR/JAR 25.853
(a) (i) (ii) ● BS 7176 Medium hazard
● AM 18 - NF D 60-013-(only for
fabric) ● CA TB 117-2013 ● Class
Uno UNI 9175 Class 1 I EMME ●
DIN EN 13501-1 B-s1,d0



66152

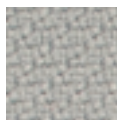

60004



60011



60021



60089



60090



60091



60092



60999



61102

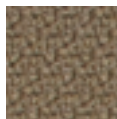

61103

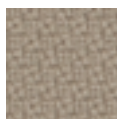

61149

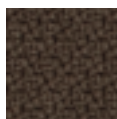

61150



62057



62073

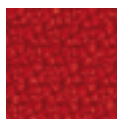

63012



63075



63082

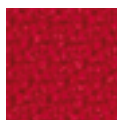

64013

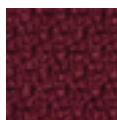

64159



64177



64178

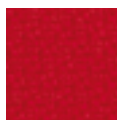

64179



64180



65011



65018

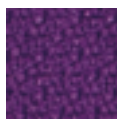

65023



65047



65090



65091



65092



65093

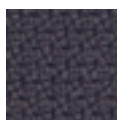

65094

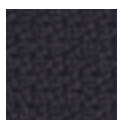

65095



66018



66019



66148



66149



66150



66151



67004



67007



67072



67073



68118



68119



68120



68121



68157



68158



68159

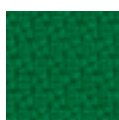

68160



68161



68162



68163



68164



68165

Gabriel Textiles / Telas Gabriel

Chili / Grade 5

Composition / Composición
 100% recycled polyester
 100% poliéster reciclado

Martindale test /
 Resistencia a la abrasión
 60.000 Cycles / Ciclos

Certifications / Certificados
 AATCC 16 ● AATCC 8 or 116 ●
 ASTM D4157-07 Wyz ● ASTM
 D3511 ● CA TB 117-2013 ● EN
 29053 & ISO 9053-1 ● CA TB
 117-2013 ● NFP 92-503/504/505
 M1 ● DIN 4102 - B1 ● Class Uno
 UNI 9175 Class 1 IEMME ● BS EN
 1021 1&2 Cigarette and Match ●
 BS EN 1021-1 Cigarette ● BS 7176
 Medium hazard ● BS 5852 Crib 5
 ● BS 5852 Part 1 0,1 Cigarette &
 match ● AM 18 - NF D 60-013 ●
 DIN EN 13501-1 B-s1,d0

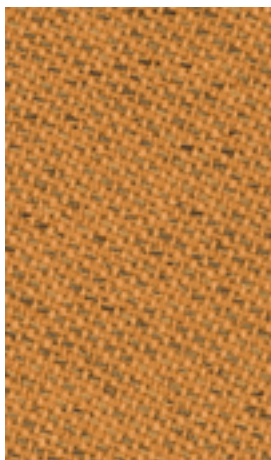

61173



60081

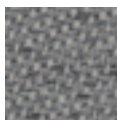

60083

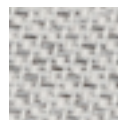

60114

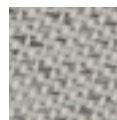

60115



60116

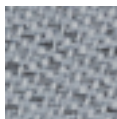

60117

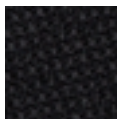

60999



61171

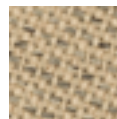

61172

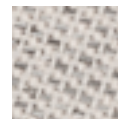

61174



61175



62085



62086



63090



63092



63093



63099



64197

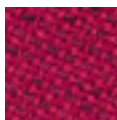

64198



64199

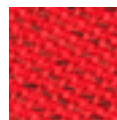

64200

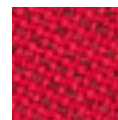

64201



64202



64203



65107

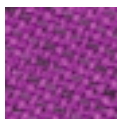

65108

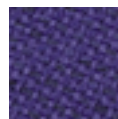

65109



65110



65111



66171



66172

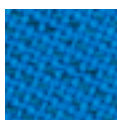

66173



66174



66175

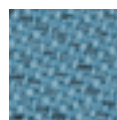

66176



67085



68189



68190

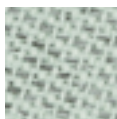

68191



68192

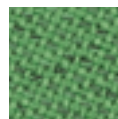

68193

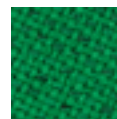

68194



68195



68196



68197

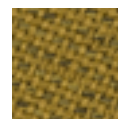

68198

Gabriel Textiles / Telas Gabriel

Step Melange / Grade 5

Composition / Composición
100% Trevira CS

Martindale test /
Resistencia a la abrasión
100.000 Cycles / Ciclos

Certifications / Certificados
IMO MSC 307(88) Annex 1 part 8
● MED Certificate IMO ● DIN 4102
B1 ● NFP 92-503/504/505 M1 ●
BS EN 1021 1&2 Cigarette and
Match ● BS EN 1021-1 Cigarette
● BS 5852 Part 1 0,1 Cigarette &
match ● BS 5852 Crib 5 ● ÖNORM
B 3825-B1-3800-Q1 UK ● FAR/
JAR 25.853 (a) (i) (ii) ● BS 7176
Medium hazard ● AM 18 - NF D
60-013-(only for fabric) ● CA TB
117-2013 ● Class Uno UNI 9175
Class 1 I EMME ● DIN EN 13501-1
B-s1,d0



66152



60004



60011

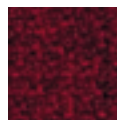

64013



60021



60090



60092



61102

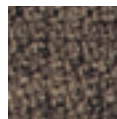

61103



61104



61149



61150



61151



61152



62057



62073

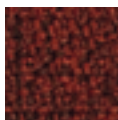

63075



63082

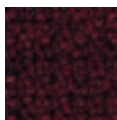

64159



64177

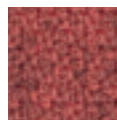

64178



64179



64181

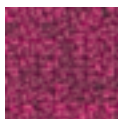

64182



65011



65018



65023

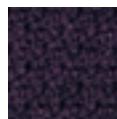

65047



65090

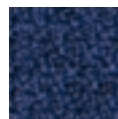

65091

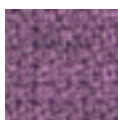

65092

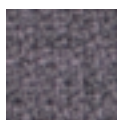

65093

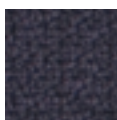

65094



66018



66019



66148



66149



66150



66151



67004



67007



67072

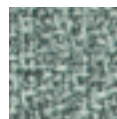

68118



68119



68120

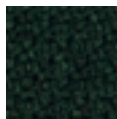

68121



68157



68158



68159

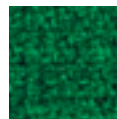

68160



68161



68162

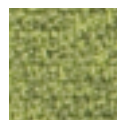

68163



68165

Gabriel Textiles / Telas Gabriel

Go check / Grade 6

Composition / Composición
100% Trevira CS

Martindale test /
Resistencia a la abrasión
80.000 Cycles / Ciclos

Certifications / Certificados
BS EN 1021 1&2 Cigarette and
Match • BS EN 1021-1 Cigarette
• BS 5852 Part 1 0,1 Cigarette
& match • BS 5852 Crib 5 • BS
7176 Medium hazard • DIN 4102
B1 • NFP 92-503/504/505 M1 •
ÖNORM B 3825-B1-3800-Q1 UK
• Class Uno UNI 9175 Class 1 I
EMME • FAR/JAR 25.853 (a) (i) (ii) •
CA TB 117-2013 • DIN EN 13501-1
B-s1,d0



60079

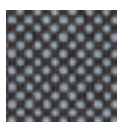

60080

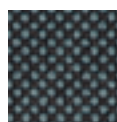

60081

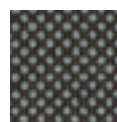

60083

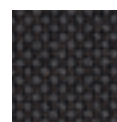

60084



60093



61138



61139



61140

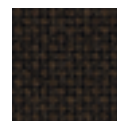

61141

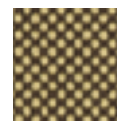

61142

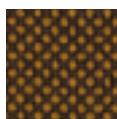

61143



61144

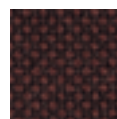

61145

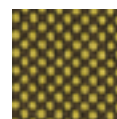

62071

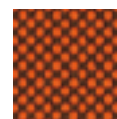

63079



63080



64171



64172



64174



64175



64183



65085

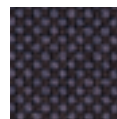

65086

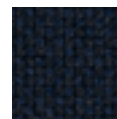

66134

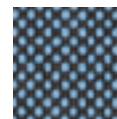

66135



66136



66137



66138

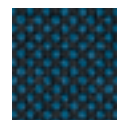

66139



66140

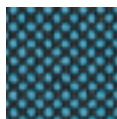

67070

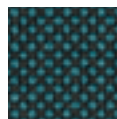

67071

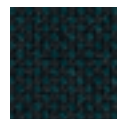

68149

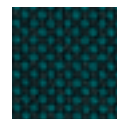

68152

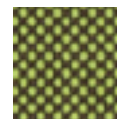

68153

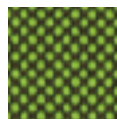

68154

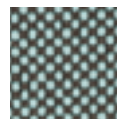

68168

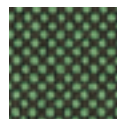

68169



68170

Gabriel Textiles / Telas Gabriel

Swing / Grade 6

Composition / Composición
 54% New Zealand wool / 44%
 post-consumer recycled polyester /
 2% polyamide
 54% lana de Nueva Zelanda / 44%
 poliéster reciclado postconsumo /
 2% poliamida

Martindale test /
 Resistencia a la abrasión
 100.000 Cycles / Ciclos

Certifications / Certificados
 BS EN 1021 1&2 Cigarette and
 Match ● BS EN 1021-1 Cigarette
 ● BS 5852 Part 1 0,1 Cigarette &
 match ● CA TB 117-2013

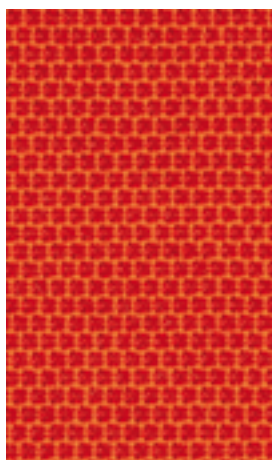

52209



51101



51202



51303



51404



51501

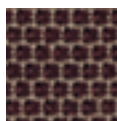

51605

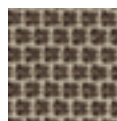

51706

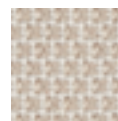

51807

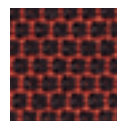

51902

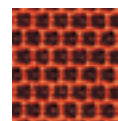

52005



52108

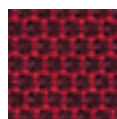

52310

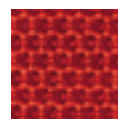

52411



52509



52612

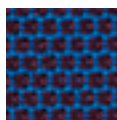

52705

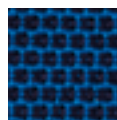

52713

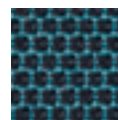

52815



52814

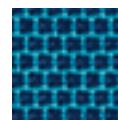

52914

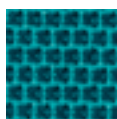

52916

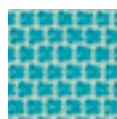

53017

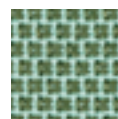

53019

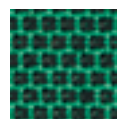

53118

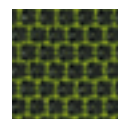

53218



53320

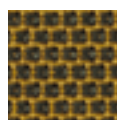

53421

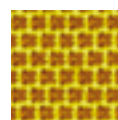

53522

Gabriel Textiles / Telas Gabriel

Select / Grade 7

Composition / Composición
 85% New Zealand wool / 15%
 polyamide
 85% lana de Nueva Zelanda / 15%
 poliamida

Martindale test /
 Resistencia a la abrasión
 200.000 Cycles / Ciclos

Certifications / Certificados
 ASTM D4966 • ASTM D4970 • CA
 TB 117-2013 • AATCC 16 • AATCC
 8 or 116 • BS EN 1021-1 Cigarette
 • BS EN 1021-2 Match • BS 5852
 Part 1.0.1 Cigarette & Match • BS
 5852 Crib 5 • IMO MSC 307(88)
 Annex 1 part 8 • MED Certificate
 IMO • CA TB 117-2013



61187

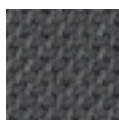

60003

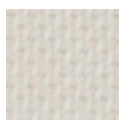

60005

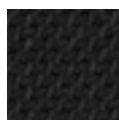

60051

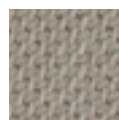

60129

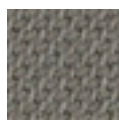

60130

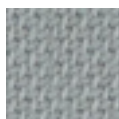

60131

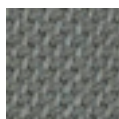

60132

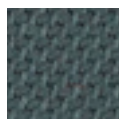

60133

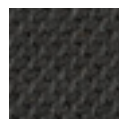

60134

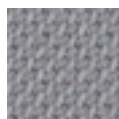

60139

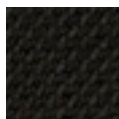

60999

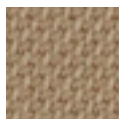

61184

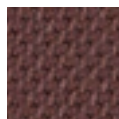

61185

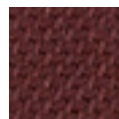

61186

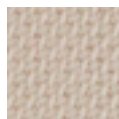

61188

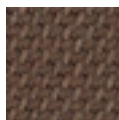

61189

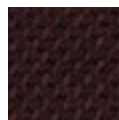

61190

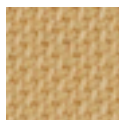

62097

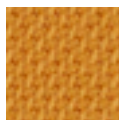

62098



62099

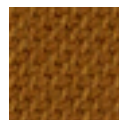

62100



62103



62104



63101

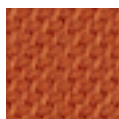

63102

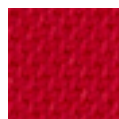

64089

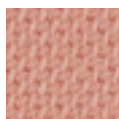

64213



64214



64215

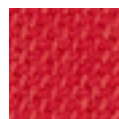

64216

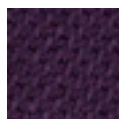

65077

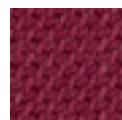

65114

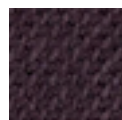

65115

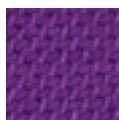

65116



65117

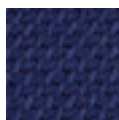

66005

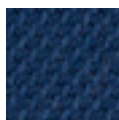

66071



66075

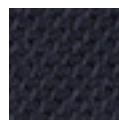

66144



66189



66190



66191



66192

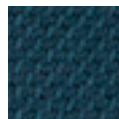

66193

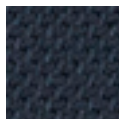

66194

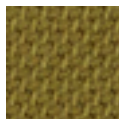

67093

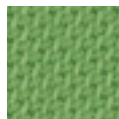

67094



67095

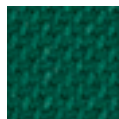

67096

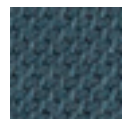

67097

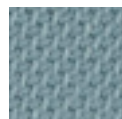

67098

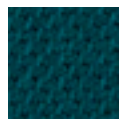

67099



67100

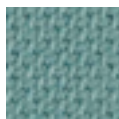

67101

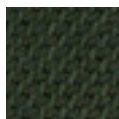

68209

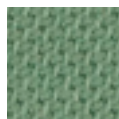

68210

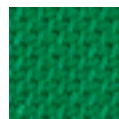

68211

Tapicerías

Gabriel Textiles / Telas Gabriel

Capture / Grade 8

Composition / Composición
 85% New Zealand wool / 15%
 polyamide
 85% lana de Nueva Zelanda / 15%
 poliamida

Martindale test /
 Resistencia a la abrasión
 200.000 Cycles / Ciclos

Certifications / Certificados
 BS EN 1021 1&2 Cigarette and
 Match • BS 5852 Part 1 0,1
 Cigarette & match • Class Uno
 UNI 9175 Class 1 | EMME • CA TB
 117-2013

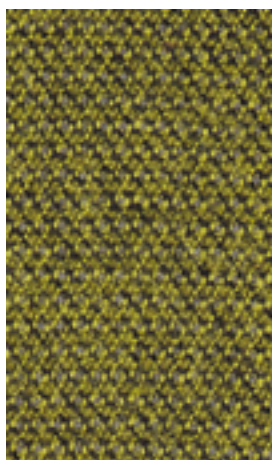

5301



4001



4101



4102



4201

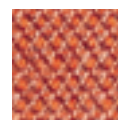

4301



4401



4501



4601



4702

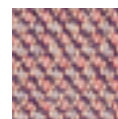

4801



4802

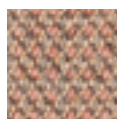

4803

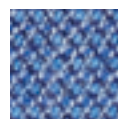

4901

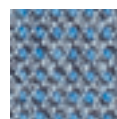

4902

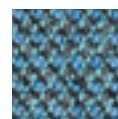

5001

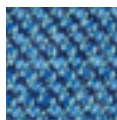

5002



5101



5102

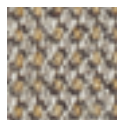

5103

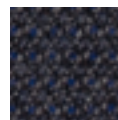

5201



5401

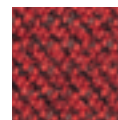

5402

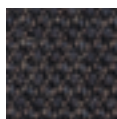

5501



6001

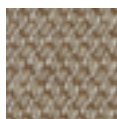

6101



6201



6202

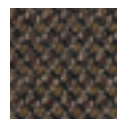

6301



6302



6401

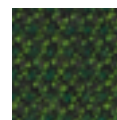

6501



6601

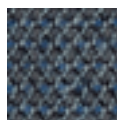

6602

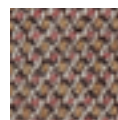

6701



6801



6901

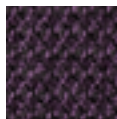

7001



7101

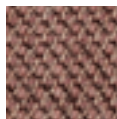

7201

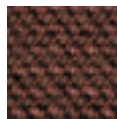

7301



7401



7501

Kvadrat Textiles / Telas Kvadrat

Revive 1 / Grade 3

Composition / Composición
100% Recycled Polyester FR
100% Poliéster reciclado FR

Martindale test /
Resistencia a la abrasión
60.000 Cycles / Ciclos

Certifications / Certificados
DIN 4102 B1 • EN 1021-1/2 • IMO
FTP Code 2010 Part 8 • UNI 9175
1IM • US Cal. Bull. 117-2013 •
ÖNORM B1/ Q1 • NF D 60 013 with
treatment • SN 198 898 5.3 with
treatment • AS/NZS 3837, class 1 •
BS 5852 ignition source 3BS 5852
Crib 5 with treatment

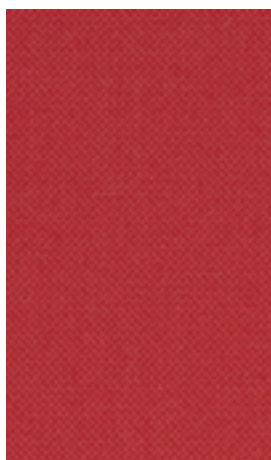

0634

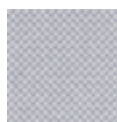

0144



0154



0164



0184



0194

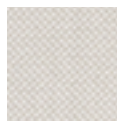

0224

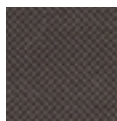

0274



0284

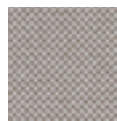

0324



0384



0414

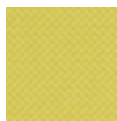

0424

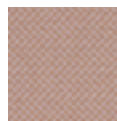

0434



0454



0524



0534



0664



0754



0764



0774



0834



0914



0944

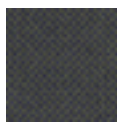

0974

Field 2 / Grade 4

Composition / Composición
100% Trevira

Martindale test /
Resistencia a la abrasión
100.000 Cycles / Ciclos

Certifications / Certificados
BS 5852 Crib 5 • BS 5852 part 1,
ig. s. 0 • DIN 4102 • B1EN 1021-
1/2 • FAR 25.853 • IMO FTP Code
2010 Part 8 • NF D 60 013 • NF P
92 507 M1 • UNI 9175 1IM • UNI
9177 Classe 1 • US Cal. Bull. 117-
2013 • ÖNORM B1/ Q1SN 198
898 5.2 • AS/NZS 3837, class 1



0662

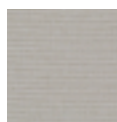

0123



0132



0142

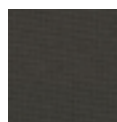

0173

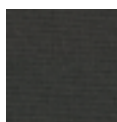

0182



0192



0222

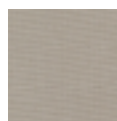

0233



0242

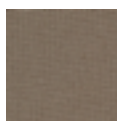

0343



0373



0443



0463



623

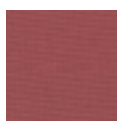

643



0663



0673

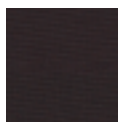

0693



0723



0733



0763



0773



0782



0793



0843



0933



0943



0963

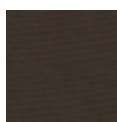

0983

Tapicerías

Kvadrat Textiles / Telas Kvadrat

Remix 3 / Grade 4

Composition / Composición
 90% Wool 10% Nylon
 90% Lana 10% Nylon

Martindale test /
 Resistencia a la abrasión
 100.000 Cycles / Ciclos

Certifications / Certificados
 AS/NZS 1530.3 • AS/NZS 3837,
 class 2 • BS 5852 part 1 • EN
 1021-1/2 • IMO FTP Code 2010
 Part 8 • NF D 60 013 • NFPA 260 •
 UNI 9175 1 • IMUS Cal. Bull. 117-
 2013 • ÖNORM B1/ Q1 • BS 5852
 Crib 5 with treatment • IMO FTP
 Code 2010 Part 7 with • SN 198
 898 5.3 with treatment • BS 5852
 ignition source 3



0692



0113



0123



0126



0133



0136



0143



0152



0163



0173

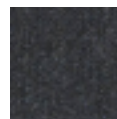

0183

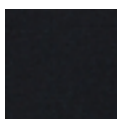

0196



0223



0233



0242



0252

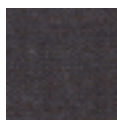

0266

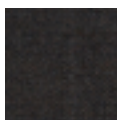

0276

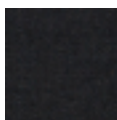

0286



0296

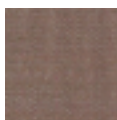

0326

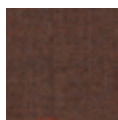

0346

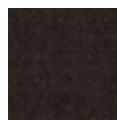

0356

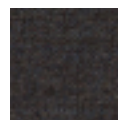

0362

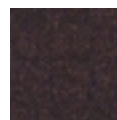

0373

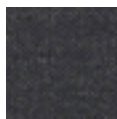

0383

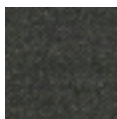

0393

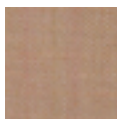

0406

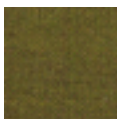

0412



0422



0433



0443

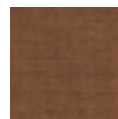

0452



0516



0536



0543

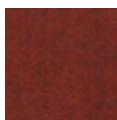

0566

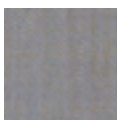

0606



0632

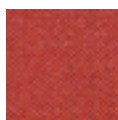

0643



0653

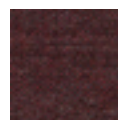

0662



0672



0682

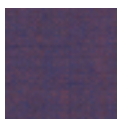

0686

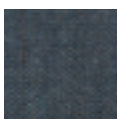

0716



0722



0733



0743



0753



0762

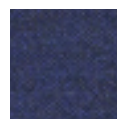

0773

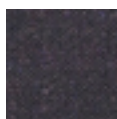

0783

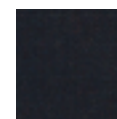

0796



0816



0823

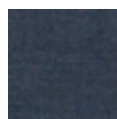

0836



0842



0852



0866



0873



0906



0912

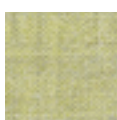

0923



0933

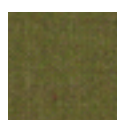

0942



0954

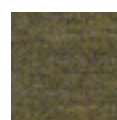

0962

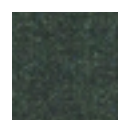

0973

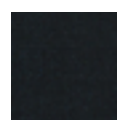

0996

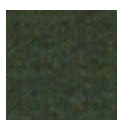

0982

Kvadrat Textiles / Telas Kvadrat

Melange Nap / Grade 5

Composition / Composición
97% New wool, 3% Nylon
97% Lana virgen, 3% Nailon

Martindale test /
Resistencia a la abrasión
60.000 Cycles / Ciclos

Certifications / Certificados
BS 5852 ignition source 3 ● EN
1021-1/2 ● NF D 60 013 ● UNI
9175 1 ● IMUS Cal. Bull. 117-2013
● BS 5852 part 1 ● BS 5852 Crib 5
with treatment

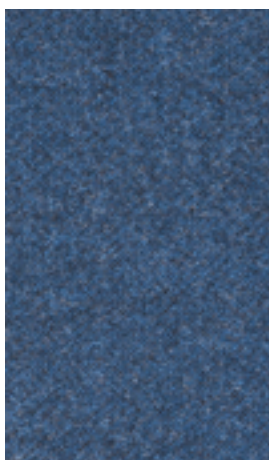

0871



0111



0171



0191



0211



0221

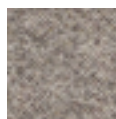

0241



0271



0321



0351



0371



0411



0441



0461



0491



0521



0551



0651

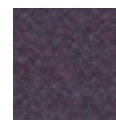

0691



0711

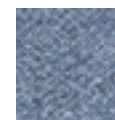

0751



0771

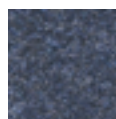

0791



0911



0951

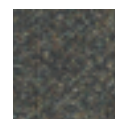

0991

Kvadrat Textiles / Telas Kvadrat

Re-Wool / Grade 5

Composition / Composición
 45% recycled wool, 45% new wool
 worsted, 10% nylon
 45% lana reciclada, 45% lana
 virgen peinada, 10% nailon

Martindale test /
 Resistencia a la abrasión
 100.000 Cycles / Ciclos

Certifications / Certificados
 AS/NZS 1530.3 • BS 5852 crib 5
 with treatment • BS 5852 ignition
 source 3 • BS 5852 part 1 • IMO
 FTP Code 2010 Part 8 • NF D 60
 013 • UNI 9175 1IM • US Cal. Bull.
 117-2013 • EN 1021-1/2 • SN 198
 898 5.3 with treatment • AS/NZS
 3837 class 2 • ÖNORM B1/Q1



0558

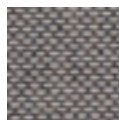

0108

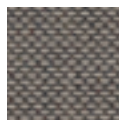

0128



0158

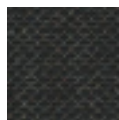

0198

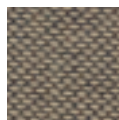

0218



0358



0378



0408

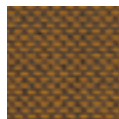

0448



0458



0568



0628



0648



0658

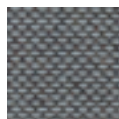

0718

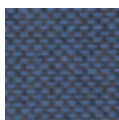

0758

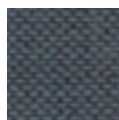

0768



0828

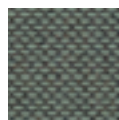

0858



0868

Patio / Grade 6 IN/OUT

Composition / Composición
 100% Trevira CS
 100% Trevira CS

Martindale test /
 Resistencia a la abrasión
 50.000 Cycles / Ciclos

Certifications / Certificados
 BS 5852 Crib 5 • IMO FTP Code
 2010 Part 8 • NF D 60 013 • NF
 P 92 507 M1 • UNI 9175 1IM •
 UNI 9177 Classe 1 • US Cal. Bull.
 117-2013 • DIN 4102 B1 • EN
 1021-1/2 • AS/NZS 3837 class 1
 • ASTM E84 Class A Unadhered •
 NFPA 701 • ÖNORM B1/Q1



0440

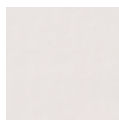

0100



0110



0140



0150

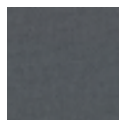

0170

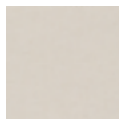

0200

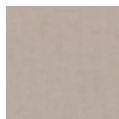

0210

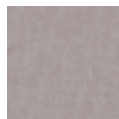

0220



0230



0340

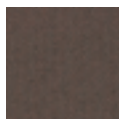

0370



0410



0430



0450



0550



0570

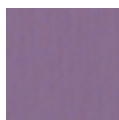

0650



0730



0740



0750

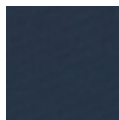

0780



0840



0970

Fabrics

Kvadrat Textiles / Telas Kvadrat

Canvas 2/ Grade 7

Composition / Composición
 90% New wool (worsted) /
 10% Nylon
 90% Lana virgen / 10% Nylon

Martindale test /
 Resistencia a la abrasión
 100.000 Cycles / Ciclos

Certifications / Certificados
 AS/NZS 1530.3 • BS 5852 part 1
 • EN 1021-1/2 • IMO FTP Code
 2010 Part 8 • NF D 60 013 • NFPA
 260SN 198 898 5.3 with treatment
 • UNI 9175 1 • IMUS Cal. Bull. 117-
 2013 • ÖNORM B1/ Q1 • BS 5852
 ignition source 3 • BS 5852 Crib 5
 with treatment



0946



0114



0124

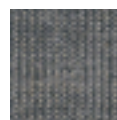

0134



0154

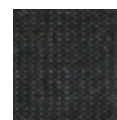

0174



0216



0224



0244



0254



0264



0356

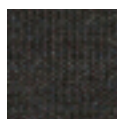

0364

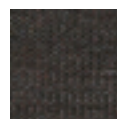

0374



0414



0424



0446

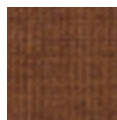

0454



0546



0556



0566



0576



0614



0644



0654



0666



0674

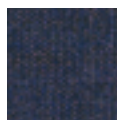

0684

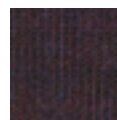

0694



0716

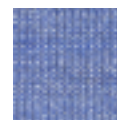

0726



0734

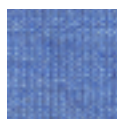

0746



0764



0786



0794



0836



0854



0926



0936



0954



0964

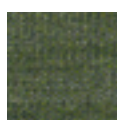

0974



0984

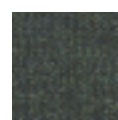

0996

Tapicerías

Kvadrat Textiles / Telas Kvadrat

Clara 2 / Grade 7

Composition / Composición
 92% New wool (worsted),
 8% Nylon
 92% lana nueva (peinada),
 8% Nylon

Martindale test /
 Resistencia a la abrasión
 80.000 Cycles / Ciclos

Certifications / Certificados
 AS/NZS 3837 • BS 5852 part 1
 • EN 1021-1/2 • IMO FTP Code
 2010 Part 8 • NF D 60 013 • NFPA
 260UNI 9175 1 • IMUS Cal. Bull.
 117-2013 • ÖNORM B1/ Q1 • BS
 5852 Crib 5 with treatment



0548



0144



0148



0184

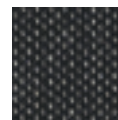

0188



0244



0248



0273



0277

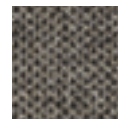

0384



0388



0423



0427

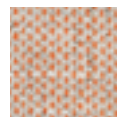

0544

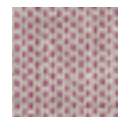

0643



0647

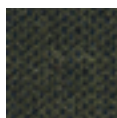

0793

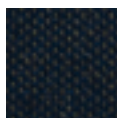

0797

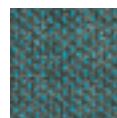

0884

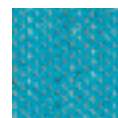

0888

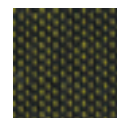

0933

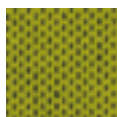

0937



0983



0987

Kvadrat Textiles / Telas Kvadrat

Hero 2 / Grade 7

Composition / Composición

97% new wool
3% recycled nylon
97 % lana virgen,
3 % nailon reciclado

Martindale test /

Resistencia a la abrasión
45.000 Cycles / Ciclos

Certifications / Certificados

*AS/NZS 3837 class 2 •ASTM E84
Class A Adhered •ASTM E84 Class
A Unadhered •BS 5852 crib 5 with
treatment * •BS 5852 part 1 •EN
1021-1/2 •IMO FTP Code 2010 Part 8
•NF D 60 013 •SN 198 898 5.3 with
treatment * •UNI 9175 11M •US Cal.
Bull. 117-2013 "



0732



0102



0152



0162



0182



0192



0202

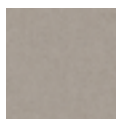

0212



0242



0312



0352

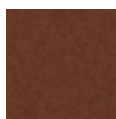

0372

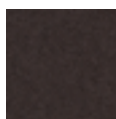

0392



0422



0432



0512

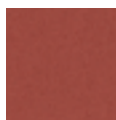

0542



0552



0582

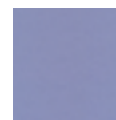

0622



0652



0662



0672



0742



0752



0772



0782



0862



0882



0912



0932



0942



0962

Kvadrat Textiles / Telas Kvadrat

Fiord 2 / Grade 8

Composition / Composición
 92% New wool (worsted),
 8% Nylon
 92% lana nueva (peinada),
 8% Nylon

Martindale test /
 Resistencia a la abrasión
 60.000 Cycles / Ciclos

Certifications / Certificados
 BS 5852 Crib 5 with treatment ●
 BS 5852 part 1 ● DIN 4102 B2 ● EN
 1021-1/2 ● IMO FTP Code 2010
 Part 8 ● NF D 60 013 ● UNI 9175 1
 ● IMUS Cal. Bull. 117-2013 ● AS/
 NZS 3837, class 2 ● SN 198 898
 5.3 with treatment



0571

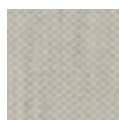

0101

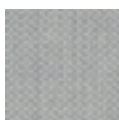

0121



0151



0171

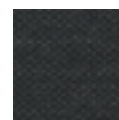

0191



0201



0251

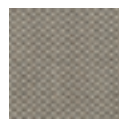

0262



0271



0322



0351

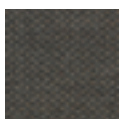

0371

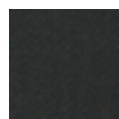

0382

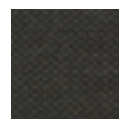

0391



0422

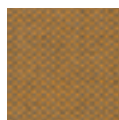

0442



0451



0521



0551



0562



0581

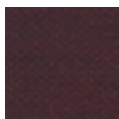

0591



0642



0662

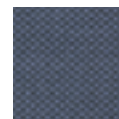

0672



0721



0751



0762



0771



0782



0791



0821



0862



0951



0961



0971



0981



0991

Kvadrat Textiles / Telas Kvadrat

Atrium / Grade 8 IN/OUT

Composition / Composición
100% Trevira CS, water repellent
100% Trevira CS, repelente al agua

Martindale test /
Resistencia a la abrasión
50.000 Cycles / Ciclos

Certifications / Certificados
OEKO-TEX® Standard 100 ●AS/
NZS 3837 ●BS 5852 part 1 ●EN
1021-1/2 ●IMO FTP Code 2010
Part 8 ●NF D 60 013 ●NFPA
260UNI 9175 1 ●IMUS Cal. Bull.
117-2013 ●ÖNORM B1/ Q1 ●BS
5852 Crib 5 with treatment



0951

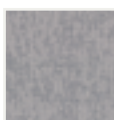

0131



0181



0201



0231



0241



0351



0451



0541



0631



0701



0751



0781



0901



0931



0981

Kvadrat Textiles / Telas Kvadrat

Tonus 4/ Grade 8

Composition / Composición
 90% New wool, 10% Helanca
 90% Lana virgen,
 10% HELanca

Martindale test /
 Resistencia a la abrasión
 100.000 Cycles / Ciclos

Certifications / Certificados
 BS 5852 part 1 • EN 1021-1/2 •
 IMO FTP Code 2010 Part 8 • NF D
 60 013 • NFPA 260SN 198 898 5.3
 with treatment • UNI 9175 1 • IMUS
 Cal. Bull. 117-2013 • ÖNORM B1/
 Q1 • BS 5852 Crib 5 with treatment



0130

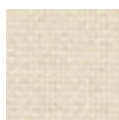

0100



0118

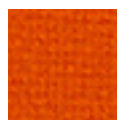

0125



0128



0129

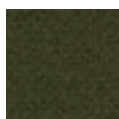

0131



0132

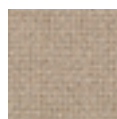

0135



0207



0210



0216

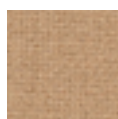

0224



0240



0244



0364

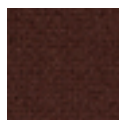

0374

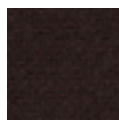

0394



0424



0440



0454



0464

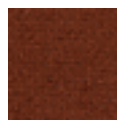

0474



0508



0554

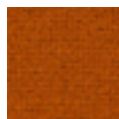

0605



0608



0609

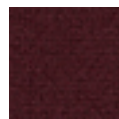

0610

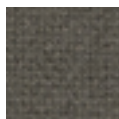

0613

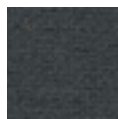

0615

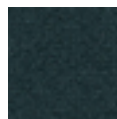

0619



0631



0634



0636

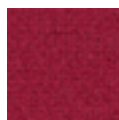

0654

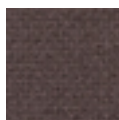

0664

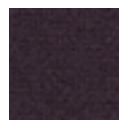

0684

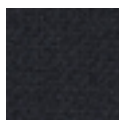

0690



0754

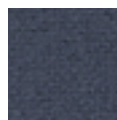

0764



0854



0914



0934



0954



0964



0974

Kvadrat Textiles / Telas Kvadrat

Divina 3 / Grade 8

Composition / Composición
100% New wool
100% Lana virgen

Martindale test /
Resistencia a la abrasión
45.000 Cycles / Ciclos

Certifications / Certificados
AS/NZS 1530.3 ● BS 5852 Crib 5
● BS 5852 part 1 ● BS 5867 part 2
type B ● EN 1021-1/2 ● EN 13501,
C-s1, d0, glued ● IMO FTP Code
2010 Part 8 ● NF D 60 013 ● NFPA
260SN 198 898 5.3 with treatment
● UNI 9175 1 ● IMUS Cal. Bull. 117-
2013 ● ÖNORM B1/ Q1 ● BS 5852
ignition source 3



Tapicerías

Kvadrat Textiles / Telas Kvadrat

Divina MD/ Grade 9

Composition / Composición
100% New wool,
100% Lana virgen

Martindale test /
Resistencia a la abrasión
45.000 Cycles / Ciclos

Certifications / Certificados
AS/NZS 1530.3 ● BS 5852 Crib
5 ● BS 5852 part 1 ● BS 5867
part 2 type B ● EN 1021-1/2 ● EN
13501, C-s1, d0, glued ● IMO FTP
Code 2010 Part 8 ● NF D 60 013 ●
NFPA 260 ● SN 198 898 5.3 with
treatment ● UNI 9175 1 ● IMUS Cal.
Bull. 117-2013 ● ÖNORM B1/ Q1 ●
BS 5852 ignition source 3



0633



0193



0203



0213

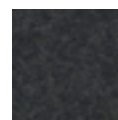

0293



0343

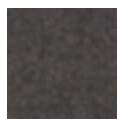

0353

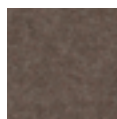

0363



0413



0433



0453



0613

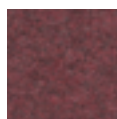

0653

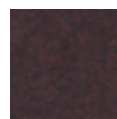

0673

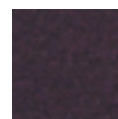

0683



0713



0733

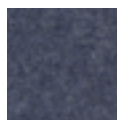

0743



0753



0773

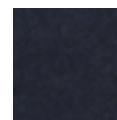

0783



0813



0843



0873

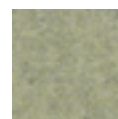

0913



0943

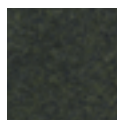

0973

Kvadrat Textiles / Telas Kvadrat

Divina Melange 3 / Grade 9

Composition / Composición
100% New wool
100% Lana virgen

Martindale test /
Resistencia a la abrasión
45.000 Cycles / Ciclos

Certifications / Certificados
AS/NZS 1530.3 ● BS 5852 Crib
5BS 5852 part 1 ● BS 5867 part 2
type B ● EN 1021-1/2 ● EN 13501,
C-s1, d0, glued ● IMO FTP Code
2010 Part 8 ● NF D 60 013NFPA
260 ● SN 198 898 5.3 with
treatment ● UNI 9175 1 ● IMUS Cal.
Bull. 117-2013 ● ÖNORM B1/ Q1 ●
BS 5852 ignition source 3



0731

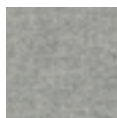

0120



0147



0170



0180

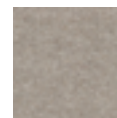

0227



0237

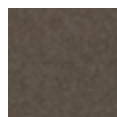

0260



0277

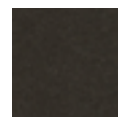

0280

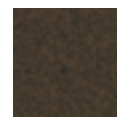

0367



0427



0457



0467



0471



0517



0527



0547



0557



0567

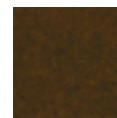

0571

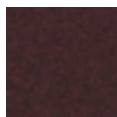

0581

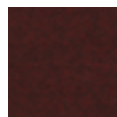

0597



0617



0620

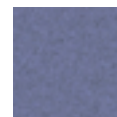

0647

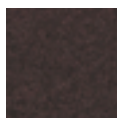

0677



0687



0747



0757



0777



0787



0821



0871



0917



0937



0967



0977

Kvadrat Textiles / Telas Kvadrat

Hallingdal 65 / Grade 9

Composition / Composición
 70% New wool, 30% Viscose
 70% Lana virgen, 30% Viscosa

Martindale test /
 Resistencia a la abrasión
 100.000 Cycles / Ciclos

Certifications / Certificados
 AS/NZS 1530.3 • AS/NZS 3837
 • BS 5852 Crib 5BS 5852 part 1
 • EN 1021-1/2 • IMO FTP Code
 2010 Part 8 • NF D 60 013 • NFPA
 260SN 198 898 5.3 with treatment
 • UNI 9175 1 • IMUS Cal. Bull. 117-
 2013 • ÖNORM B1/ Q1 • BS 5852
 ignition source 3



0563



0100

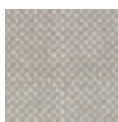

0103



0110



0113



0116

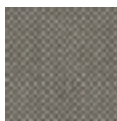

0123



0126

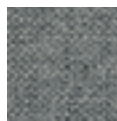

0130



0143

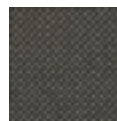

0153

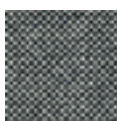

0166

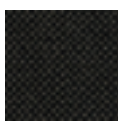

0173



0180

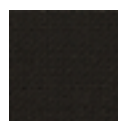

0190



0200



0220



0224



0227



0270



0350



0368



0370

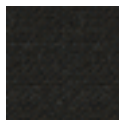

0376



0390

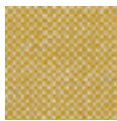

0407



0420

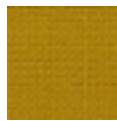

0457

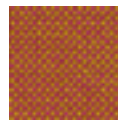

0526



0547

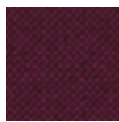

0573

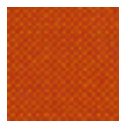

0590

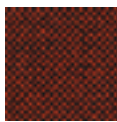

0596

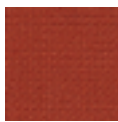

0600



0657



0660



0674



0680



0687

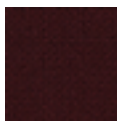

0694



0702



0723



0733



0750



0753



0754



0763



0764



0773



0810



0840



0850

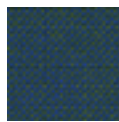

0890



0907



0944



0960



0968



0980

Kvadrat Textiles / Telas Kvadrat

Steelcut Trio 3 / Grade 9

Composition / Composición
 90% New wool (worsted),
 10% Nylon
 90% lana virgen,
 10% nailon

Martindale test /
 Resistencia a la abrasión
 100.000 Cycles / Ciclos

Certifications / Certificados
 AS/NZS 3837, class 2 • BS 5852
 part 1EN 1021-1/2 • IMO FTP
 Code 2010 Part 8 • NF D 60 013 •
 NFPA 260 • SN 198 898 5.3 with
 treatment • UNI 9175 1 • IMUS Cal.
 Bull. 117-2013 • ÖNORM B1/ Q1
 • BS 5852 Crib 5 with treatment •
 AS/NZS 1530.3BS 5852 ignition
 source 3



Tapicerías

Kvadrat Textiles / Telas Kvadrat

Reflect / Grade 4

Composition / Composición
 90% New wool (worsted),
 10% Nylon
 90% lana virgen,
 10% nailon

Martindale test /
 Resistencia a la abrasión
 100.000 Cycles / Ciclos

Certifications / Certificados
 AS/NZS 3837, class 2 • BS 5852
 part 1EN 1021-1/2 • IMO FTP
 Code 2010 Part 8 • NF D 60 013 •
 NFPA 260 • SN 198 898 5.3 with
 treatment • UNI 9175 1 • IMUS Cal.
 Bull. 117-2013 • ÖNORM B1/ Q1
 • BS 5852 Crib 5 with treatment •
 AS/NZS 1530.3BS 5852 ignition
 source 3



0434



0104



0114



0124



0154



0164



0174



0184



0194



0204



0224



0274



0344



0374



0384



0404



0444



0464



0564



0574



0614



0644



0674



0694



0714



0744



0774



0794



0824



0884



0924



0944



0964



0984



0994

Kvadrat Textiles / Telas Kvadrat

Ecriture / Grade 11

40% polyacrylic 9% linen
27% polyester 8% viscose
6% cotton
40% poliacrílico, 9% lino
27% poliéster, 18% viscosa
6% algodón

Martindale test /
Resistencia a la abrasión
70.000 Cycles / Ciclos

Certifications / Certificados
BS 5852 Crib 5 with treatment ●
BS 5852 Part 1 ●EN 1021-1/2
●US Cal. Bull. 117-2013"



0470

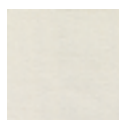

0100



0130



0150



0170



0180



0200



0210



0240



0270

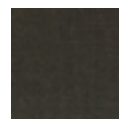

0380



0410



0570

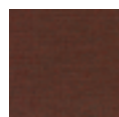

0580

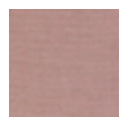

0640

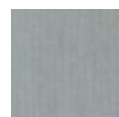

0710



0760

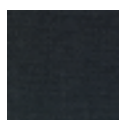

0780

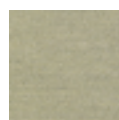

0910

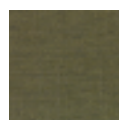

0970

Kvadrat Textiles / Telas Kvadrat

Zero / Grade 11

Composition / Composición
 65% cotton
 20% polyacrylic
 15% polyester

Martindale test /
 Resistencia a la abrasión
 70.000 Cycles/Ciclos.
 (EN ISO 12947)

Certifications / Certificados
 AS/NZS 3837 class 2
 BS 5852 Crib 5 with treatment *
 BS 5852 part 1 with treatment*
 EN 1021-1
 US Cal. Bull. 117-2013 with Cal.
 117 compliant interliner

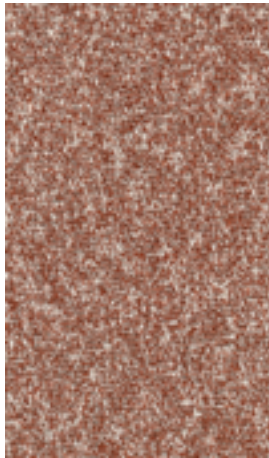

0008



0001



0002



0003



0004



0005

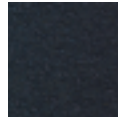

0006

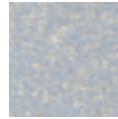

0007

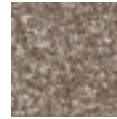

0009



0010



0011



0012



0013



0014

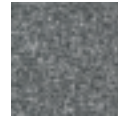

0015



0016

Arda / Grade 11

Composition / Composición
 97% new wool
 3% recycled nylon

Martindale test /
 Resistencia a la abrasión
 50.000 Cycles / Ciclos

Certifications / Certificados
 AS/NZS 3837 class 2
 ASTM E84 Class A un-adhered
 BS 5852 part 1 ignition source 0
 BS 5852 Crib 5, with treatment*
 DIN 4102-B2
 EN 1021-1/2
 IMO FTP Code 2010: part 8
 UNI 9175 1IM
 US Cal. Bull. 117-2013



0931



0131

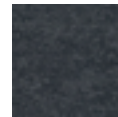

0161

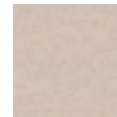

0201

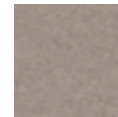

0211



0321

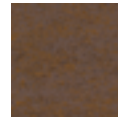

0351

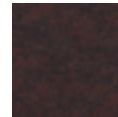

0671



0771



0791



0961

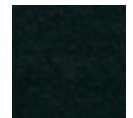

0991

Spradling Textiles / Telas Spradling

Valencia / Grade 1

Composition / Composición
 Vinyl / Urethane topcoat
 Capa de vinilo / uretano

Martindale test /
 Resistencia a la abrasión
 100.000 Cycles / Ciclos

Certifications / Certificados
 EU: EN 1021 Parte 1 y 2 ● ES: UNE 23.727-90 1R/M.2 ● FR: NF P 92-503/M2 ● DE: DIN 4102 B2 ● IT: UNI 9175 (1987) / UNI 9175/FA1 (1994) ● Classe 1.1M (UNO I EMME) ● AT: ÖNORM B 3825, Gruppe 1 - Schwerbrennbares Verhalten ● AT: ÖNORM A 3800 Teil 1, Qualmbildungsklasse Q1 - schwachqualmend ● IMO FTP 2010 Código MSC.307 (88) Parte 8 3.1 & 3.2 ● US: FMVSS 302 ● US: FAR 25/853 (MED) Marine Equipment Directive (en su versión en vigor) ● ECE R118.02 (replaces Directive 95/28/CE) Annexes 6, 7 & 8 ● EN 71-2:2006+A1:2007 - Seguridad del juguete - Parte 2: Inflamabilidad ● Selección de colores en calidad BS 5852 CRIB 5



Apfel
107-5041



Night
107-2108



Citrus
107-2109



Praliné
107-0001



Terracotta
107-0035

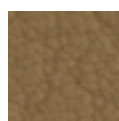

Beige
107-1050



Cognac
107-0002



Champagne
107-1001

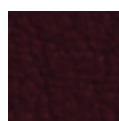

Merlot
107-2001



Mocca
107-0020



Ivory
107-1020



Berry
107-2002



Buche
107-0033

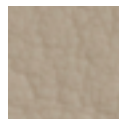

Sisal
107-1048

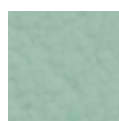

Coral
107-2106



Taupe
107-0034

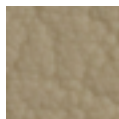

Leinen
107-1049

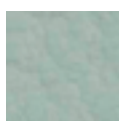

Skylight
107-2107



Chestnut
107-2115



Camel
107-2116

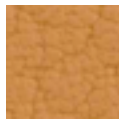

Cashmere
107-2117

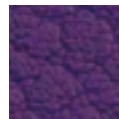

Ultra Violet
107-2118



Teal
107-2119



Sonne
107-2020



Pink
107-2021



Port
107-2062

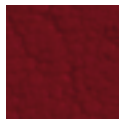

Kirsche
107-2074



Rot
107-2075



Lavendel
107-3001



Delft
107-3067



Marine
107-3068



Baltic
107-3069

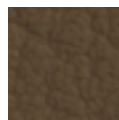

Mushroom
107-4001

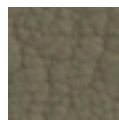

Laurel
107-4002

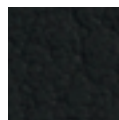

Graphite
107-4003



Silver
107-4020



Auster
107-4040

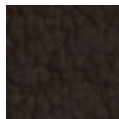

Meteor
107-4041



Titan
107-4042

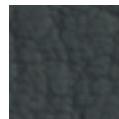

Platin
107-4043



Warm Grey
107-4044

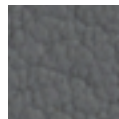

Perle
107-4045

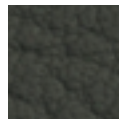

Lichtgrau
107-4052



Olive
107-5001

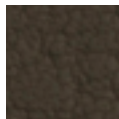

Moss
107-5002



Jade
107-5056



Türkis
107-5057

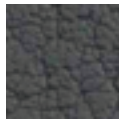

Petrol
107-5065

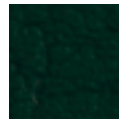

Grün
107-5069

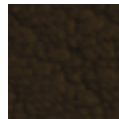

Bronze
107-6002



Nectarine
107-6003



Safran
107-6012



Melone
107-6013



Naranja
107-6019

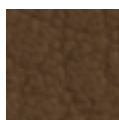

Sumatra
107-9001



Schwarz
107-9035

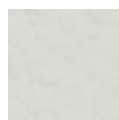

Pure White
107-9607

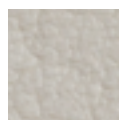

Pearlescence
107-8020

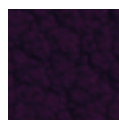

Amethyst
107-7001

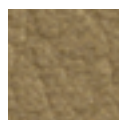

Gold
107-6020

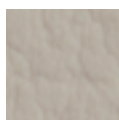

Weiss
107-8032

Tapicerías

Spradling Textiles / Telas Spradling

Silvertex / Grade 2

Composition / Composición
 Vinyl / Urethane topcoat
 Capa de vinilo / uretano

Martindale test /
 Resistencia a la abrasión
 300.000 Cycles / Ciclos

Certifications / Certificados
 EU: EN 1021 Parte 1 y 2 ● ES: UNE 23.727-90 1R/M.2 ● FR: NF P 92-503/M2 ● DE: DIN 4102 B2 ● IT: UNI 9175 (1987) / UNI 9175/FA1 (1994) ● Classe 1,IM (UNO I EMME) ● AT: ÖNORM B 3825, Gruppe 1 - Schwerbrennbares Verhalten ● AT: ÖNORM A 3800 Teil 1, Qualmbildungsklasse Q1 - schwachqualmend ● IMO FTP 2010 Código MSC.307 (88) Parte 8 3.1 & 3.2 ● US: FMVSS 302 ● US: FAR 25/853 (MED) Marine Equipment Directive (en su versión en vigor) ● ECE R118.02 (replaces Directive 95/28/CE) Annexes 6, 7 & 8 ● EN 71-2:2006+A1:2007 - Seguridad del juguete - Parte 2: Inflamabilidad ● Selección de colores en calidad BS 5852 CRIB 5

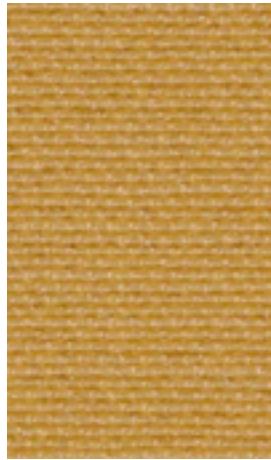

Camel
122-2105



Avocado
122-2092



Squash
122-2093

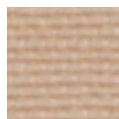

Lotus
122-2099

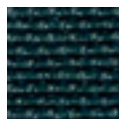

Teal
122-2100



Macadamia
122-0001

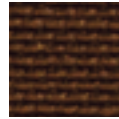

Luggage
122-0073

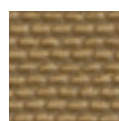

Champagne
122-1078

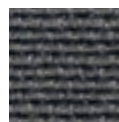

Petrol
122-2094



Aluminium
122-2101

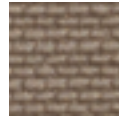

Sandstone
122-0002



Beige
122-1010

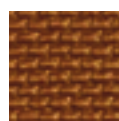

Cobre
122-2003

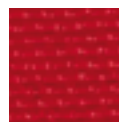

Grenadine
122-2095



Coral
122-2102



Mocca
122-0005



Umber
122-1014

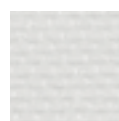

White
122-2089

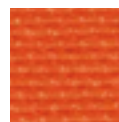

Tomato
122-2096



Skylight
122-2103



Taupe
122-0009



Sisal
122-1051

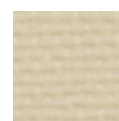

Ice Cream
122-2090

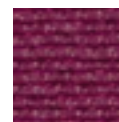

Orchid
122-2097



Ultra Violet
122-2104

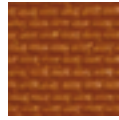

Naranja
122-0013



Cream
122-1077

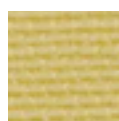

Citrus
122-2091



Rosé
122-2098



Red
122-2011



Sunkist
122-2012

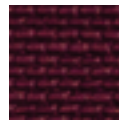

Raspberry
122-2016

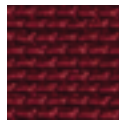

Wine
122-2064



Turquoise
122-3001



Sapphire
122-3007



Baltic
122-3066



Delft
122-3067

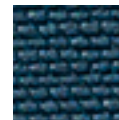

Jet
122-3068

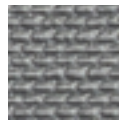

Plata
122-4001

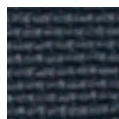

Storm
122-4002

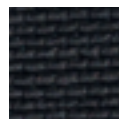

Graphite
122-4003

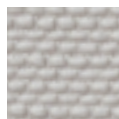

Ice
122-4004

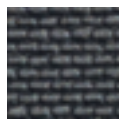

Titanium
122-4010

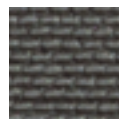

Sterling
122-4011



Shiitake
122-4012

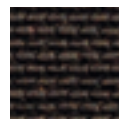

Meteor
122-4024



Pistacho
122-5008

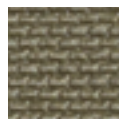

Sage
122-5009



Bottle
122-5010

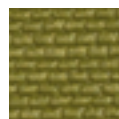

Celery
122-5019

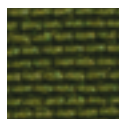

Basil
122-5020



Forest
122-5063

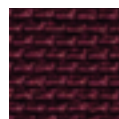

Rubín
122-6004



Mandarin
122-6061



Melon
122-6062



Safran
122-6065

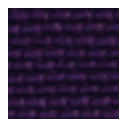

Aubergine
122-7001

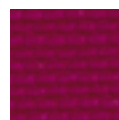

Magenta
122-7002

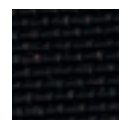

Black
122-9001

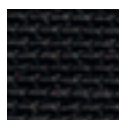

Carbon
122-9002

Spradling Textiles / Telas Spradling

Maglia / Grade 3

Composition / Composición
Vinyl / Urethane topcoat
Capa de vinilo / uretano

Martindale test /
Resistencia a la abrasión
>100.000 Cycles / Ciclos

Certifications / Certificados
EU: EN 1021 Parte 1 y 2 ● ES:
UNE 23.727-90 1R/M.2 ● FR: NF
P 92-503/M2 ● DE: DIN 4102 B2
● IT: UNI 9175 (1987) / UNI 9175/
FA1 (1994) Classe 1.IM (UNO I
EMME) ● AT: ÖNORM B 3825,
Gruppe 1 - Schwerbrennbare
Verhalten ● AT: ÖNORM A 3800
Teil 1, Qualmbildungsklasse Q1 -
schwachqualmend ● IMO FTP 2010
Código MSC.307 (88) Parte 8 3.1
& 3.2 ● US: FMVSS 302 ● US: FAR
25/853 ● (MED) Marine Equipment
Directive (en su versión en vigor) ●
ECE R118.02 (replaces Directive
95/28/CE) Annexes 6, 7 & 8 ● EN
71-2:2006+A1:2007 - Seguridad
del juguete - Parte 2: Inflamabilidad



Urban
MAG-8056



Armory
MAG-0031

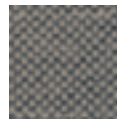

Dovetail
MAG-1702



Earth
MAG-3616

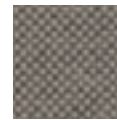

Granite
MAG-7026



Ginger
MAG-6025



Blossom
MAG-4203

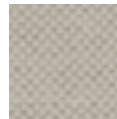

Uyumi
MAG-5001



Serenity
MAG-2420



Breeze
MAG-0003



Indigo
MAG-5559



Midnight
MAG-5450



Greenland
MAG-6443



Sky
MAG-2003



Safari
MAG-8022



Primrose
MAG-2000



Sage
MAG-0406



Mars
MAG-4227

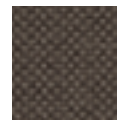

Truffle
MAG-4537



Thunder
MAG-6016



Alaska
MAG-4008



Açai
MAG-6030

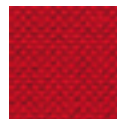

Maple
MAG-6026



Svalbard
MAG-6022



Kyanite
MAG-6023



Tahoe
MAG-6027



Minit
MAG-6028



Blackcave
MAG-6032



Monochrome
MAG-6024



Ash
MAG-6031

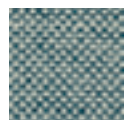

Fjord
MAG-6021



Maui
MAG-6020



Hive
MAG-6029



Grizzly
MAG-6019



Oak
MAG-6018



Artic
MAG-6017

Spradling Textiles / Telas Spradling

Dolce / Grade 4

Composition / Composición
100% Rayon
100% Rayón

Martindale test /
Resistencia a la abrasión
>300.000 Cycles / Ciclos

Certifications / Certificados
EU: EN 1021 Parte 1 y 2 ● IMO FTP
2010 Código MSC.307 (88) Parte 8
3.1 & 3.2 ● US: FMVSS 302

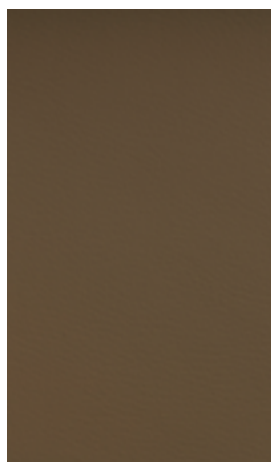

Mushroom
DOL-6708



Rattan
DOL-6730



Mango
DOL-6731



Pomance
DOL-6732



Limelight
DOL-6733

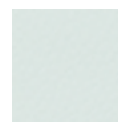

Coolmist
DOL-6737



Mistgrey
DOL-6729

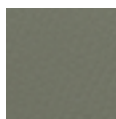

Pewter
DOL-6736



Slate
DOL-6735



Quetzal
DOL-6734



White
DOL-6701



Ivory
DOL-6702



Dune
DOL-6704



Mocha
DOL-6712



Camel
DOL-6709



Russet
DOL-6711



Chocolate
DOL-6713



Tangelo
DOL-6718



Poppy
DOL-6719



Burgundy
DOL-6714



Indigo
DOL-6725



Meteor
DOL-6727

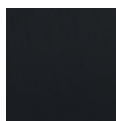

Black
DOL-6728

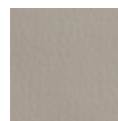

Artesian
DOL-6726



Ecu
DOL-6703



Grass
DOL-6722



Jet
DOL-6724



Latte
DOL-6706



Moss
DOL-6717



Peacock
DOL-6723



Grass
DOL-6722

Sunbrella Textiles / Telas Sunbrella

Solid & Stripes / Grade 2

IN/OUT

Composition / Composición
100% acrílico teñido en masa
100% acrylic dyed mass

Martindale test /
Resistencia a la abrasión
30.000 Cycles / Ciclos



SJA 5477
137 Logo Red

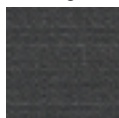

SJA 3906 137
Carbon



SJA 3964 137
Curacao

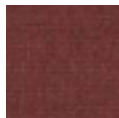

SJA 3982 137
Autumn

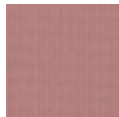

SJA 3989 137
Opera



SJA 5422 137
Antique Beige



SJA 3907 137
Taupe Chine



SJA 3965 137
Blush



SJA 3983 137
Almond



SJA 3990 137
Myosotis



SJA 5436 137
Burgundy

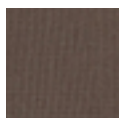

SJA 3127 137
Mink Brown

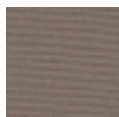

SJA 3729 137
Taupe

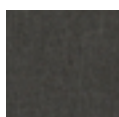

SJA 3757 137
Flanelle



SJA 3938 137
Mimosa



SJA 3966 137
Marble



SJA 3984 137
Canary

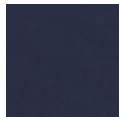

SJA 3991 137
Blazer

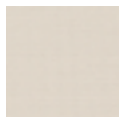

SJA 5453 137
Canvas

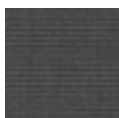

SJA 3705 137
Charcoal

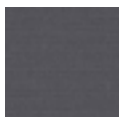

SJA 3737 137
Ardoise

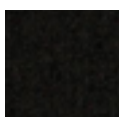

SJA 3758 137
Sooty

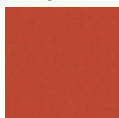

SJA 3939 137
Paprika

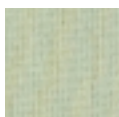

SJA 3967 137
Mint

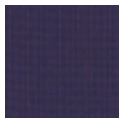

SJA 3985 137
Ink

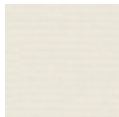

SJA 5404 137
Natural



SJA 5476 137
Heather Beige

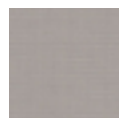

SJA 3706 137
Shingles



SJA 3738 137
Macao

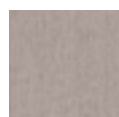

SJA 3780 137
Lin



SJA 3941 137
Adriatic



SJA 3968 137
Pepper



SJA 3986 137
Rainforest



SJA 5408 137
Black



SJA 5499 137
True Blue



SJA 3717 137
Riviera Blue

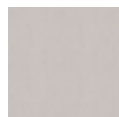

SJA 3741 137
Silver Grey



SJA 3792 137
Dark Smoke



SJA 3942 137
Blue Storm



SJA 3969
137 Pumpkin



SJA 3987 137
Alpine



SJA 5416 137
Aruba

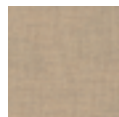

SJA 48009 137
Arbor Pebble



SJA 3728 137
Paris Red



SJA 3756 137
Lead Chine



SJA 3793 137
Blue Chine



SJA 3944 137
Charron



SJA 3970 137
Lichen

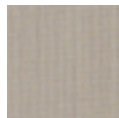

SJA 3988 137
Stone



SJA 5420 137
Mineral Blue

Sunbrella Textiles / Telas Sunbrella

Mezzo / Grade 3 IN/OUT



MEZ 10227
140 Atlas

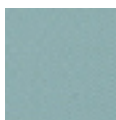

MEZ 10228
140 Celadon

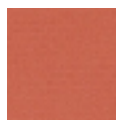

MEZ 10221
140 Coral



MEZ 10225
140 Feather



MEZ 10223
140 Henna

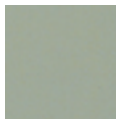

MEZ 10229
140 Opal

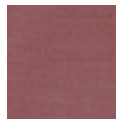

MEZ 10224
140 Scale



MEZ 10219
140 Sulfur



MEZ 10222
140 Tigerlily



MEZ 10226
140 Tropic



MEZ 10220
140 Turmeric

Composition / Composición
100% Sunbrella Acrylic
100% Sunbrella acrílico

Martindale test /
Resistencia a la abrasión
22.000 Cycles / Ciclos

Natte / Grade 3 IN/OUT



AT 10064 140
Carbon Sky

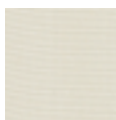

NAT 10014
140 Nature

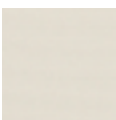

NAT 10020
140 White

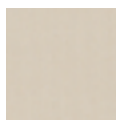

NAT 10021
140 Canvas



NAT 10022 140
Grey Chine



NAT 10025 140
Frosty Chine

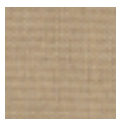

NAT 10028 140
Heather Beige



NAT 10029 140
Heather Grey

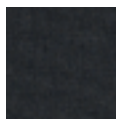

NAT 10030 140
Sooty



NAT 10040 140
Nature Grey



NAT 10059 140
Dark Taupe



NAT 10063 140
Charcoal Chine

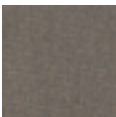

NAT 10065 140
Carbon beige

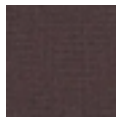

NAT 10101
140 Tonka

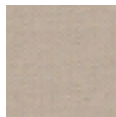

NAT 10150
140 Heather



NAT 10151
140 Linen

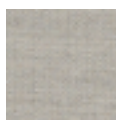

NAT 10152
140 Graumel

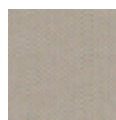

NAT 10155
140 Taupe

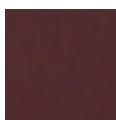

NAT 10231
140 Carmine

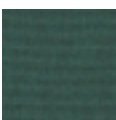

NAT 10232
140 Ivy

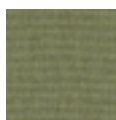

NAT 10233
140 Pistachio

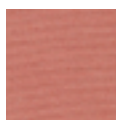

NAT 10234
140 Flamingo



NAT 10235
140 Amber

Composition / Composición
100% Sunbrella solution dyed
acrylic
Solución Sunbrella 100% teñida
acrílica

Martindale test /
Resistencia a la abrasión
30.000 Cycles / Ciclos

Sunbrella Textiles / Telas Sunbrella

Heritage / Grade 4 IN/OUT

Composition / Composición
50% Recycled acrylic, 47% acrylic,
3% PE
50% acrílico reciclado, 47%
acrílico, 3% PE

Martindale test /
Resistencia a la abrasión
22.000 Cycles / Ciclos



SJA 18012 00
137 Moss

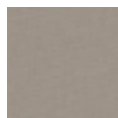

SJA 18001 00
137 Ash



SJA 18015 00
137 Slate



SJA 18021 00
137 Rust



SJA 18006 00
137 Papyrus

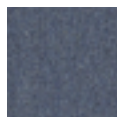

SJA 18016 00
137 Sky

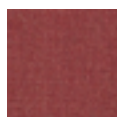

SJA 18022 00
137 Scarlet



SJA 18009 00
137 Char



SJA 18017 00
137 Indigo



SJA 18023 00
137 Dijon

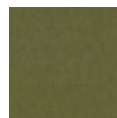

SJA 18011 00
137 Leaf

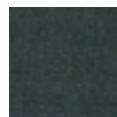

SJA 18018 00
137 Alpine

Savane / Grade 4 IN/OUT

Composition / Composición
100% Sunbrella solution dyed
acrylic
Solución Sunbrella 100% teñida
acrílica

Martindale test /
Resistencia a la abrasión
38.000 Cycles / Ciclos

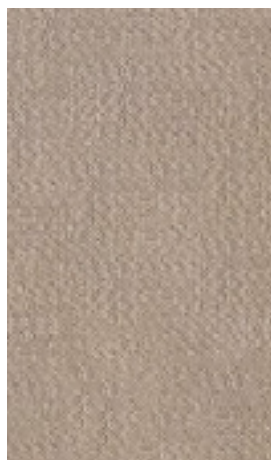

SAV2 J233
140 Coconut

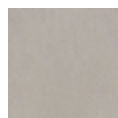

SAV2 J234
140 Grey

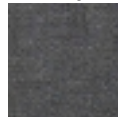

SAV2 J351
140 Tornado

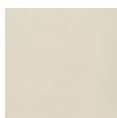

SAV2 J235
140 White

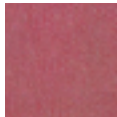

SAV2 J352
140 Eris

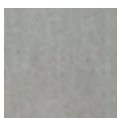

SAV2 J350
140 Nimbus

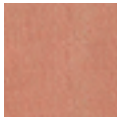

SAV2 J353
140 Dawn



SAV2 J349 140
Whisper



SAV2 J354
140 Spring

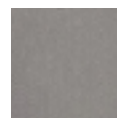

SAV2 J236
140 Zinc

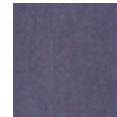

SAV2 J355
140 Midnight

Tapicerías

Sunbrella Textiles / Telas Sunbrella

Chartres / Grade 6 IN/OUT

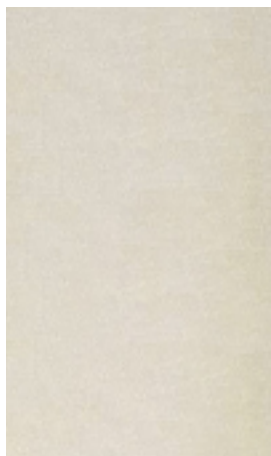

CHA2 J193
140 Pearl

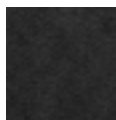

CHA2 J182
140 Sooty

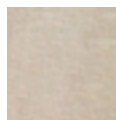

CHA2 J189
140 Heather

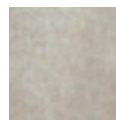

CHA2 J191
140 Grey

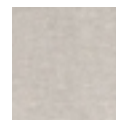

CHA2 J194
140 Silver



CHA2 J348 140
Drizzle

Composition / Composición
100% Sunbrella solution dyed
acrylic
Solución Sunbrella 100% teñida
acrílica

Martindale test /
Resistencia a la abrasión
35.000 Cycles / Ciclos

Zori / Grade 6 IN/OUT



ZOR R065
140 Fugu



ZOR R061
140 Gari



ZOR R067
140 Graphite



ZOR R063
140 Hibiscus



ZOR R064
140 Kiri



ZOR R059
140 Matcha



ZOR R069
140 Miso



ZOR R070
140 Muse



ZOR R068
140 Nami



ZOR R057
140 Rice



ZOR R066
140 Sake



ZOR R062
140 Sento



ZOR R060
140 Straw



ZOR R058
140 Washi

Composition / Composición
98% Sunbrella Acrylic, 2% Other
Fiber
98% Sunbrella acrílico, 2% otras
fibras

Martindale test /
Resistencia a la abrasión
37.000 Cycles / Ciclos

Sunbrella Textiles / Telas Sunbrella

Lopi / Grade 8

IN/OUT



LOP R033
140 Snow

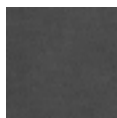

LOP R013
140 Shadow

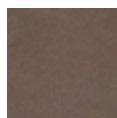

LOP R014
140 Coconut

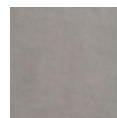

LOP R015
140 Silver



LOP R017
140 Charcoal

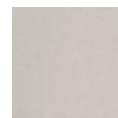

LOP R018
140 Marble

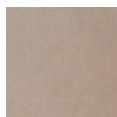

LOP R019
140 Sand



LOP R034
140 Antique

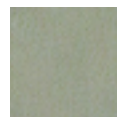

LOP R038
140 Beldi

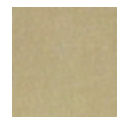

LOP R039
140 Biscuit

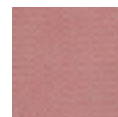

LOP R040
140 Azalea

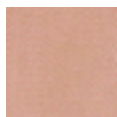

LOP R041
140 Tangerine



LOP R042
140 Nenuphar



LOP R043
140 Ash

Composition / Composición
100% Sunbrella solution dyed
acrylic
Solución Sunbrella 100% teñida
acrílica

Martindale test /
Resistencia a la abrasión
90.000 Cycles / Ciclos

Domino / Grade 8

IN/OUT

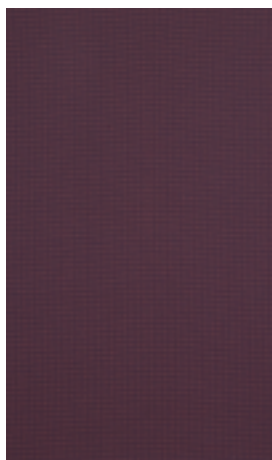

DOM R049
140 Casino



DOM R046
140 Craps



DOM R050
140 Jackpot



DOM R045
140 Joker

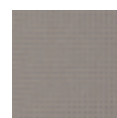

DOM R044
140 Loto



DOM R048
140 Poker



DOM R047 140
Roulette

100% Sunbrella Acrylic
100% Sunbrella acrílico

Martindale test /
Resistencia a la abrasión
80.000 Cycles / Ciclos

Tapicerías

Ultrafabrics Textiles / Telas Ultrafabrics

Ultraleather / Grade 8

Composition / Composición
 100% Polycarbonate
 Polyurethane Surface
 Policarbonato 100%
 Superficie de poliuretano

Martindale test /
 Resistencia a la abrasión
 180.000 Cycles / Ciclos

Certifications / Certificados
 ASTM E84-Class A • CA TB 117
 • FMVSS 302&95/28 Annex IV •
 NFPA 260-Class 1 • UFAC Class 1

BS 5852 Source 0, 1 & 5 Crib with
 treatment

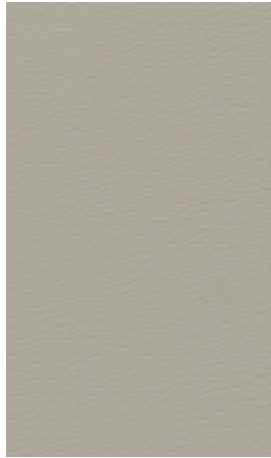

291-0001
White



291-5040
Elephant

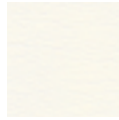
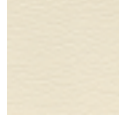

291-5805
Ermine

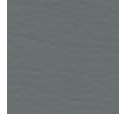

291-5708
Granite

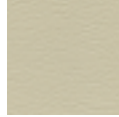

291-5714
Ice

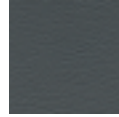

291-5763
Charcoal

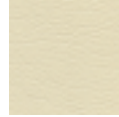

291-5668
Silver pearl

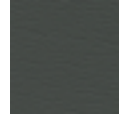

291-5806
Schooner

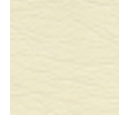

291-5666
Dove Grey

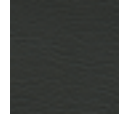

291-5607
Raven Wing



291-5676
Pelican



291-3720
Light Oyster



291-3455
Milkweed

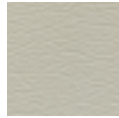

291-3599
Almond



291-3700
Ivory



291-5250
Sassy



291-3601
Doe



291-3609
Buff

291-3850
Sand



291-3719
Champagne



291-8243
Apricot



291-5684
Arctic



291-3851
Chamois



291-3926
Cashmere



291-3778
Pecan



291-3729
Tan



291-3183
Pine Cone

291-1256
Papyrus



291-8233
Autum Leaf



291-3602
Stone



291-3523
Cave



291-3779
Taupe



291-3612
Curry



291-1347
Poppy



291-3777
Walnut



291-3666
Fudge

291-3205
Hot Chocolate



291-3610
Hide



291-1176
Red



291-2552
Riviera



291-2527
Lagoon



291-5200
Citrus



291-1311
Brick



291-9385
Plum



291-2685
Bayou

291-2533
Cyan



291-4460
Parrot



291-7214
Boysenberry



291-3469
Garnet

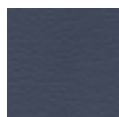

291-2508
Rain Dance



291-2507
St. John



291-4454
Sonora



291-6580
Sorbet



291-2551
Baltic

291-2509
Poseidon

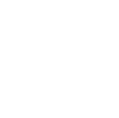

291-4314
Herbal Mist



291-4430
Eucalyptus



291-2555
Nile



291-2478
Diplomat Blue



291-4351
Shetland



291-1312
Chianti



291-2556
Admiral



Fabrics

Ultrafabrics Textiles / Telas Ultrafabrics

Ultraleather Pro / Grade 9

Composition / Composición
 100% Polycarbonate
 Polyurethane Surface
 Policarbonato 100%
 Superficie de poliuretano

Martindale test /
 Resistencia a la abrasión
 200.000 Cycles / Ciclos

Certifications / Certificados
 ASTM E84-Class A ● CA TB 117
 ● FMVSS 302&95/28 Annex IV ●
 NFPA 260-Class 1 ● UFAC Class 1

BS 5852 Source 0, 1 & 5 Crib with
 treatment

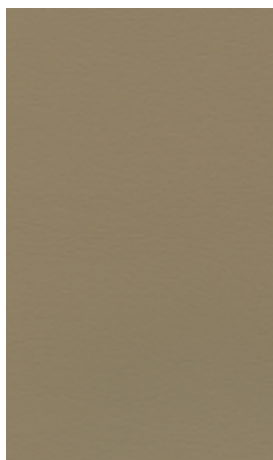

554-3894
Hazelwood



554-8254
Rosy Coral



554-2530
Sky



554-3835
Raw Sienna



554-3087
Woodcres



554-4333
Arugula



554-1357
Cranberry

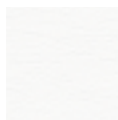

554-0008
White Wash

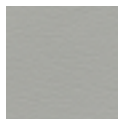

554-6566
Moon Glow

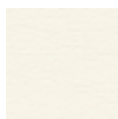

554-3811
Swan



554-2522
Capri



554-3444
Toasted Bagel



554-9451
Azalea

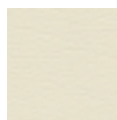

554-3412
Salt



554-5733
Mortar



554-8251
Melon



554-4530
Coastal



554-1329
Rhubarb



554-2547
Sailor



554-6547
Dawn Grey



554-5626
Char



554-2661
Blue Bird



554-3595
Cork



554-9441
Mauve



554-3209
Cougar



554-5648
Cloud

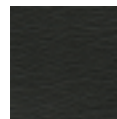

554-5618
Dark Knight



554-4315
Agave



554-8229
Campfire



554-2711
Blueberry



554-2616
Oxford Blue



554-3352
Shore



554-3376
Dark Chocolate

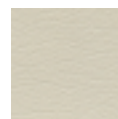

554-3803
Parfait

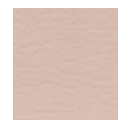

554-7200
Blush



554-4424
Chino



554-4534
Sherwood

Ultrafabrics Textiles / Telas Ultrafabrics

Brisa Distressed / Grade 9

Composition / Composición
 100% Polycarbonate
 Polyurethane Surface
 Policarbonato 100%
 Superficie de poliuretano

Martindale test /
 Resistencia a la abrasión
 160.000 Cycles / Ciclos

Certifications / Certificados
 ASTM E84-Class A ● CA TB 117
 ● FMVSS 302&95/28 Annex IV ●
 NFPA 260-Class 1 ● UFAC Class 1

BS 5852 Source 0, 1 & 5 Crib with
 treatment



**535-3273
Shield**



**535-3137
Saddle**

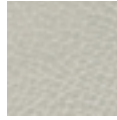

**535-3274
Coyote**

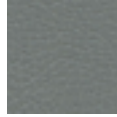

**535-3271
Koala**



**535-3871
Moccasin**



**535-3201
Bison**



**535-3021
Manila**

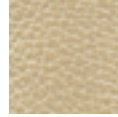

**535-3024
Chamois**

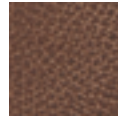

**535-3972
Lasso**



**535-3976
Bridle**



**535-3480
Navajo Ivory**



**535-3980
Waylan**

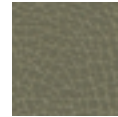

**535-4512
Prairie**



**535-3870
Pelt**



**535-3134
Buckskin**

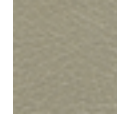

**535-3869
Muslin**



**535-3232
Railroad**



**535-5773
Stormy**



**353-3340
Desert Tan**

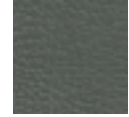

**535-5679
Iron**

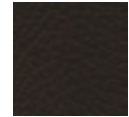

**535-3231
Franch Roast**



**535-3974
Steerhide**

Fresco / Grade 9

Composition / Composición
 100% Polycarbonate
 Polyurethane Surface
 Policarbonato 100%
 Superficie de poliuretano

Martindale test /
 Resistencia a la abrasión
 160.000 Cycles / Ciclos

Certifications / Certificados
 ASTM E84-Class A ● CA TB 117
 ● FMVSS 302&95/28 Annex IV ●
 NFPA 260-Class 1 ● UFAC Class 1

BS 5852 Source 0, 1 & 5 Crib with
 treatment



**544-3105
Sepia**

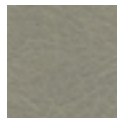

**544-3102
Grotto**



**544-5754
Peppercorn**



**544-5743
Peninsula**

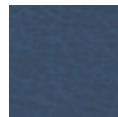

**544-2566
Azurite**

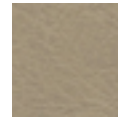

**544-3100
Whey**

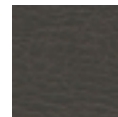

**544-3197
Patina**



**544-5752
Flint**



**544-3101
Oatstraw**

Ultrafabrics Textiles / Telas Ultrafabrics

Brisa / Grade 9

Composition / Composición
 100% Polycarbonate
 Polyurethane Surface
 Policarbonato 100%
 Superficie de poliuretano

Martindale test /
 Resistencia a la abrasión
 160.000 Cycles / Ciclos

Certifications / Certificados
 ASTM E84-Class A • CA TB 117
 • FMVSS 302&95/28 Annex IV •
 NFPA 260-Class 1 • UFAC Class 1

BS 5852 Source 0, 1 & 5 Crib with
 treatment

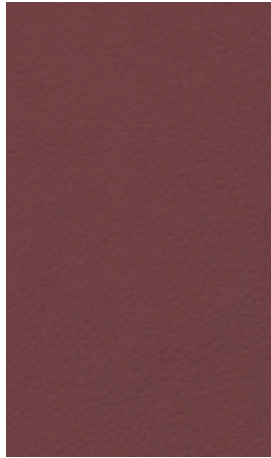

**533-1361
Beet Root**

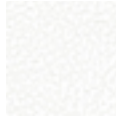

**533-5747
White**

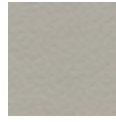

**533-3276
Wishbone**

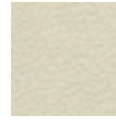

**533-3019
Birch**

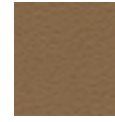

**533-3591
Caramel**



**533-3277
Moon**

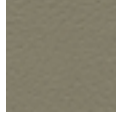

**533-3915
Putty**

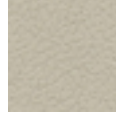

**533-3822
Bone**

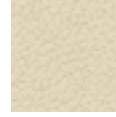

**533-3863
Cream**

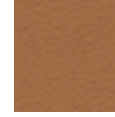

**533-3823
Aztec**



**533-5820
Quicksilver**

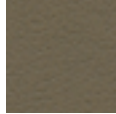

**533-3914
Bark**

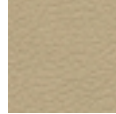

**533-3864
Desert Clay**

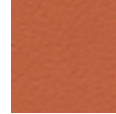

**533-8202
Koi**

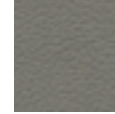

**533-5802
Ash**

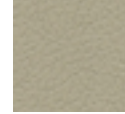

**533-3946
New Sand**

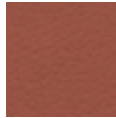

**533-8245
Cinnabar**

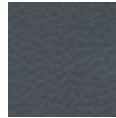

**533-5703
Wrought Iron**

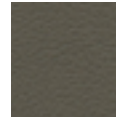

**533-3022
Shitake**

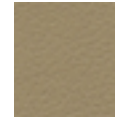

**533-3051
Ginger**

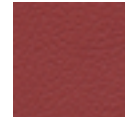

**533-1383
Pompeian Red**



**533-5749
Black Onyx**

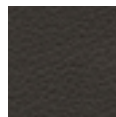

**533-3023
Coffee Bean**

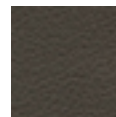

**533-3913
Truffle**

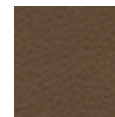

**533-3200
Peat**

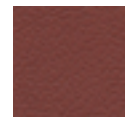

**533-1373
Salsa**

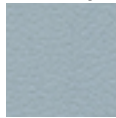

**533-3272
Iceberg**

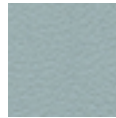

**533-2698
Sterling Blue**

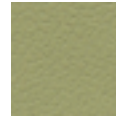

**533-4510
Celery**



**533-9400
Cabernet**

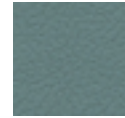

**533-2697
Mineral**



**533-4448
Apple Green**



**533-1344
Rose Red**

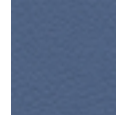

**533-2696
Skyway**



**533-4303
Seaweed**

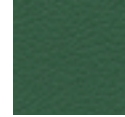

**533-4302
Esmeralda**

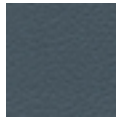

**533-2645
Cambridge Blue**

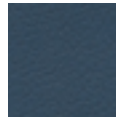

**533-2621
Blue Sea**

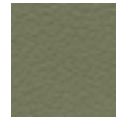

**533-4487
Sage**

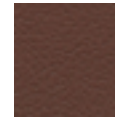

**533-3825
Canyon**

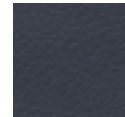

**533-2694
Night Navy**

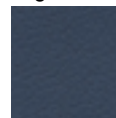

**533-2620
Evening Blue**

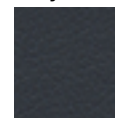

**533-2683
Indigo**

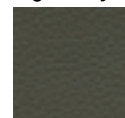

**533-4488
Olive**

Ultrafabrics Textiles / Telas Ultrafabrics

Reef Pro / Grade 11

Composition / Composición
 100% Polycarbonate
 Polyurethane Surface
 Policarbonato 100%
 Superficie de poliuretano

Martindale test /
 Resistencia a la abrasión
 200.000 Cycles / Ciclos

Certifications / Certificados
 ASTM E84-Class A • CA TB 117
 • FMVSS 302&95/28 Annex IV •
 NFPA 260-Class 1 • UFAC Class 1

BS 5852 Source 0, 1 & 5 Crib with
 treatment

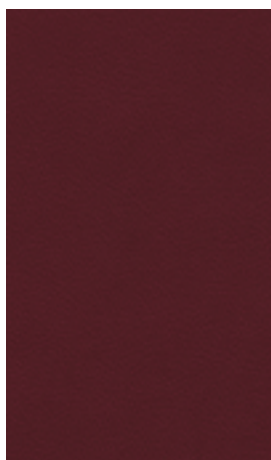

624-1413
Octopus



624-2632
Beluga



624-5246
Submarine



624-4434
Seagrass



624-3792
Hammerhead



624-3841
Stingray



624-5288
Squid

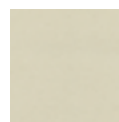

624-3487
Sea Star



624-3561
Boardwalk



624-3536
Lionfish



624-1415
Clownfish



624-1414
Coral



624-1408
Lobster



624-4316
Caribbean



624-2722
Saltwater



624-2627
Captain



624-4392
Algae

Ultrafabrics Textiles / Telas Ultrafabrics

Volar Bio / Grade 11

Composition / Composición
Proprietary Polycarbonate+Biobase
Surface
Superficie patentada de
policarbonato+biobase

Martindale test /
Resistencia a la abrasión
200.000 Cycles / Ciclos

Certifications / Certificados
ASTM E84-Class A ● CA TB 117
● FMVSS 302&95/28 Annex IV ●
NFPA 260-Class 1 ● UFAC Class 1

BS 5852 Source 0, 1 & 5 Crib with
treatment

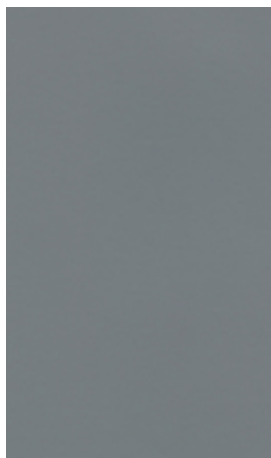

630-6018
Gravity



630-6549
Silverstone



630-3842
Burlap



630-8252
Monarch



630-7290
Mint



630-5004
Fortress



630-3893
Bramble



630-1407
Scarlet



630-2725
Macaw



630-8258
Café Noir



630-5877
Porcini



630-6073
Pitch Black



630-2749
Indigotin



630-4329
Matcha



630-4335
Spinach

Ultrafabrics Textiles / Telas Ultrafabrics

Tottori / Grade 10

Composition / Composición
 100% Polycarbonate
 Polyurethane Surface
 100% Policarbonato
 Superficie de poliuretano

Martindale test /
 Resistencia a la abrasión
 200.000 Cycles / Ciclos

Certifications / Certificados
 ASTM E84-Class A ● CA TB 117-
 2013-Pass ● FMVSS 302&95/28
 Annex IV-Pass ● NFPA 260-Class 1
 ● UFAC Class 1

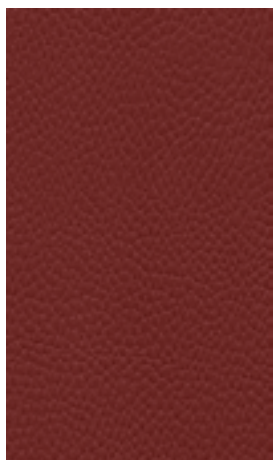

601-1404
Rouge

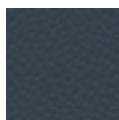

601-2595
Hot Spring



601-2622
Blue Mirage



601-3120
Udon



601-3280
Tatami Mat



601-3300
Terrain



601-3348
Ginseng

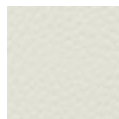

601-3418
Origami White

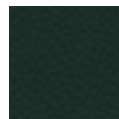

601-4346
Dark Spruce

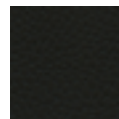

601-5020
Black Sesame



601-5033
Sand Castle

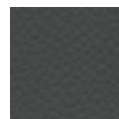

601-5037
Classic Grey

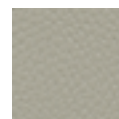

601-5998
Rice Paper

Coast / Grade 10

Composition / Composición
 100% Polycarbonate
 Polyurethane Surface
 100% Policarbonato
 Superficie de poliuretano

Martindale test /
 Resistencia a la abrasión
 180.000 Cycles / Ciclos

Certifications / Certificados
 ASTM E84-Class A ● CA TB 117-
 2013-Pass ● FMVSS 302&95/28
 Annex IV ● NFPA 260-Class 1 ●
 UFAC Class 1

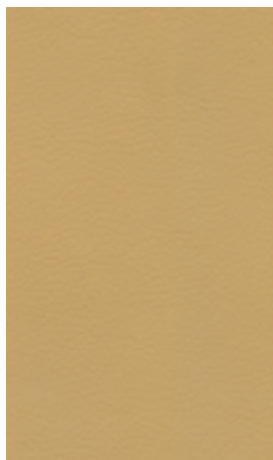

640-3837
Bungalow

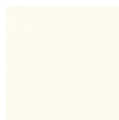

640-0021
Snow Cap

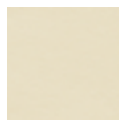

640-0042
Beacon



640-2579
Glacial



640-2590
Raindrop



640-2776
Naval Blue



640-3797
Conch



640-3879
Terra



640-3880
Savanna



640-3881
Dusty Earth



640-3890
Cabana



640-4338
Stem Green



640-5968
Feather

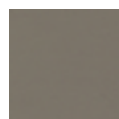

640-6086
Walrus Grey

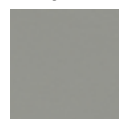

640-6508
Dolphin



640-7230
Calypso

Ultrafabrics Textiles / Telas Ultrafabrics

Promessa / Grade 9

Composition / Composición
 100% Polycarbonate
 Polyurethane Surface
 100% Policarbonato
 Superficie de poliuretano

Martindale test /
 Resistencia a la abrasión
 180.000 Cycles / Ciclos

Certifications / Certificados
 ASTM E84-Class A • CA TB 117
 • FMVSS 302&95/28 Annex IV •
 NFPA 260-Class 1 • UFAC Class 1

BS 5852 Source 0, 1 & 5 Crib with
 treatment

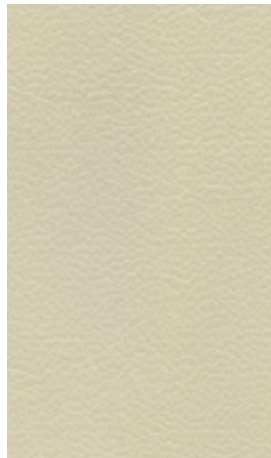

**363-3152
Parchment**

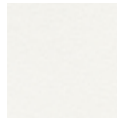

**363-5715
Snow**



**363-3464
Tusk**

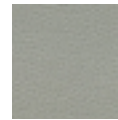

**363-5818
Ash**



**363-3463
Cocoa**

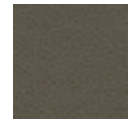

**363-3391
Sparrow**

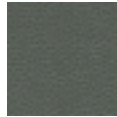

**363-5817
Shale**



**363-5011
Battleship**



**363-5845
Ebony**



**363-3462
Woodpecker**



**363-3037
Horsehair**



**363-5263
Mustard**



**363-2695
Aquamarine**



**363-4515
Shetland**



**363-3036
Linen**



**363-5258
Sun Shower**



**363-3145
Bronze**



**363-2604
Stone Blue**



**363-7309
Malibu**



**363-3189
Barley**



**363-1396
Blood Orange**

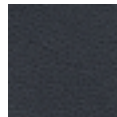

**363-2680
Atlantic**



**363-3148
Briarwood**



**363-3142
Camel**



**363-1387
Dogwood**



**363-2672
Corn Flour**



**363-7273
Aspen Green**



**363-3141
Fields**



**363-9387
Moroccan Fig**



**363-3195
Mesquite**



**363-9371
Beet**