

ezpeleta[®]



CONTRACT

Tarifas / Tabela de preços / Price list / Tarifs

2024



apilable · empilhável · stackable · empilable



uso interior · indoor use · pour l'intérieur



protección UV · proteção UV · UV protection



uso exterior · uso ao ar livre · outdoor use · utilisation en extérieur



abatible · rebatível · folding · pliante



apilable · empilhável · stackable · empilable



reguladores de altura · adjustable leveling feet · vérins réglables



desenfundable · removível · removable · déhousseable



reciclable · reciclável · recyclable



resistente al moho · resistente ao bolor · mold resistant · résistant à la moisissure



muy fácil de lavar y desinfectar · muito fácil de lavar e desinfetar
 very easy to cleanup and disinfect · trèsfacile à laver et à désinfecter



fabricado en la Unión Europea · feito na União Europeia
 made in the European Union · fabriqué dans l'Union Européenne



4
 Con volante con fugavientos
 Com babinela com fugaventos
 With valance with airvent
 Avec volants soufflet



2
 Sin volante con fugavientos
 Sem babinela com fugaventos
 Without valance with airvent
 Sans volant avec soufflet



1
 Con volante sin fugavientos
 Com babinela sem fugaventos
 With valance without airvent
 Avec volants sans soufflet



0
 Sin volante sin fugavientos
 Sem babinela sem fugaventos
 Without valance without airvent
 Sans volant sans soufflet



5
 Con volante sin fugavientos con flecos
 Com babinela sem fugaventos com franjas
 With valance without airvent with fringes
 Avec volants sans soufflet et avec des franges



6
 Sin volante sin fugavientos con flecos
 Sem babinela sem fugaventos com franjas
 Without valance without airvent with fringes
 Sans volant sans soufflet avec des franges

Índice

Index



sillas / cadeiras / chairs / chaises **04-09**



mesas / tables **10-18**

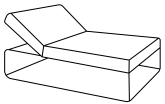

lounge **19-22**

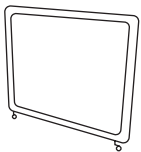

separadores / space dividers / séparateurs **23-25**



parasoles / guarda-sóis / parasols **26-38**



datos logísticos / dados logísticos/ logistic data / données logistiques **39-44**



condiciones generales/ condições gerais/ general conditions / conditions générales **45-47**

name info structure reference €

TRENA ARMCHAIR

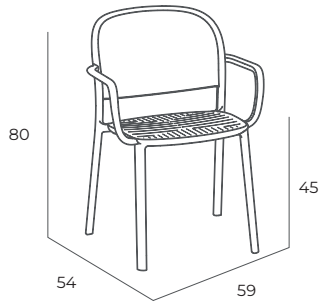

- anthracite
- taupe
- terracota
- blue grey
- soft pink
- pearl

- MN-TRE00-091X00
- MN-TRE00-024X00
- MN-TRE00-026X00
- MN-TRE00-029X00
- MN-TRE00-011X00
- MN-TRE00-028X00

85,00 €



name info structure reference €

TRENA CHAIR

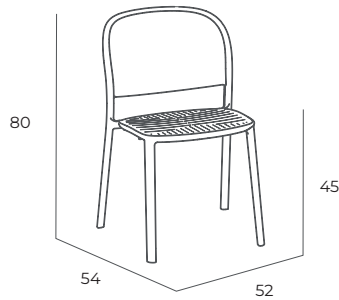

- anthracite
- taupe
- terracota
- blue grey
- soft pink
- pearl

- MS-TRE00-091X00
- MS-TRE00-024X00
- MS-TRE00-026X00
- MS-TRE00-029X00
- MS-TRE00-011X00
- MS-TRE00-028X00

75,00 €



name info structure reference €

TRENA STOOL

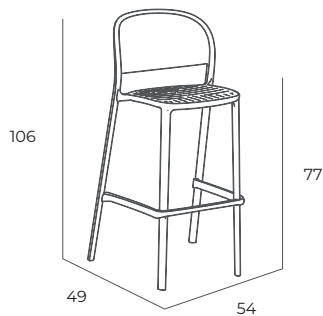

- anthracite
- taupe
- terracota
- blue grey
- soft pink
- pearl

- MT-TRE00-091X00
- MT-TRE00-024X00
- MT-TRE00-026X00
- MT-TRE00-029X00
- MT-TRE00-011X00
- MT-TRE00-028X00

89,00 €



name info structure reference €

NOON ARMCHAIR

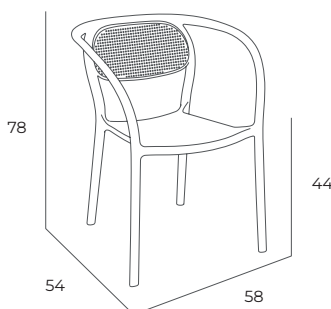

- taupe
- pearl
- terracota
- blue grey

- MN-NON00-024X00
- MN-NON00-028X00
- MN-NON00-026X00
- MN-NON00-029X00

85,00 €



name info structure backrest reference €

BAKE WOOD

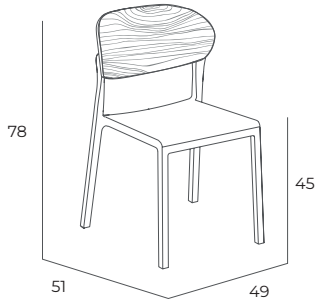

taupe	wood	MS-BAK20-024X00
sand	wood	MS-BAK20-071X00
anthracite	wood	MS-BAK20-091X00
olivo	wood	MS-BAK20-066X00

183,00 €



name info structure backrest pad reference €

BAKE WOOD PAD

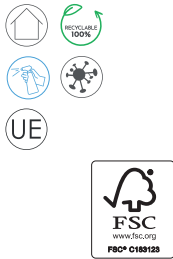
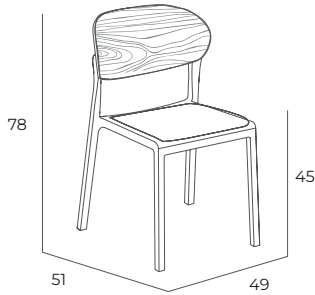

taupe	wood	taupe	MS-BAK23-024X-015S0
sand	wood	taupe	MS-BAK24-071X-015S0
anthracite	wood	taupe	MS-BAK21-091X-015S0
olivo	wood	taupe	MS-BAK25-066X-015S0

220,00 €



name info structure backrest reference €

BAKE

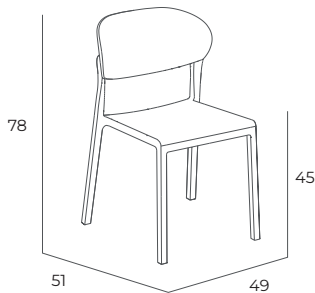

taupe	terracota	MS-BAK03-026X00
sand	taupe	MS-BAK04-024X00
anthracite	blue grey	MS-BAK01-029X00
olivo	pearl	MS-BAK05-028X00

77,00 €

name info structure backrest pad reference €

BAKE PAD

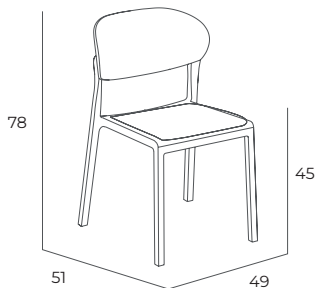

taupe	terracota	taupe	MS-BAK13-026X-015S0
sand	taupe	taupe	MS-BAK14-024X-015S0
anthracite	blue grey	taupe	MS-BAK11-029X-015S0
olivo	pearl	taupe	MS-BAK15-028X-015S0

113,00 €

name	info	structure	backrest	reference	€
------	------	-----------	----------	-----------	---

ROD

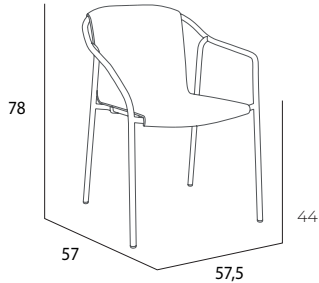

anthracite	anthracite	MN-ROD01-091X00	119,00 €
anthracite	blue grey	MN-ROD01-029X00	
moka	pearl	MN-ROD02-028X00	
taupe	taupe	MN-ROD03-024X00	
taupe	terracota	MN-ROD03-026X00	
sand	cappuccino	MN-ROD04-027X00	

name	info	structure	backrest	pad	reference	€
------	------	-----------	----------	-----	-----------	---

ROD PAD

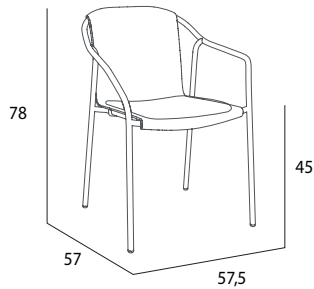

anthracite	anthracite	grey	MN-ROD11-091X-013S0	153,00 €
anthracite	blue grey	grey	MN-ROD11-029X-013S0	
moka	pearl	taupe	MN-ROD12-028X-015S0	
taupe	taupe	taupe	MN-ROD13-024X-015S0	
taupe	terracota	taupe	MN-ROD13-026X-015S0	
sand	cappuccino	taupe	MN-ROD14-027X-015S0	

name	info	structure	backrest	pad	reference	€
------	------	-----------	----------	-----	-----------	---

HOP

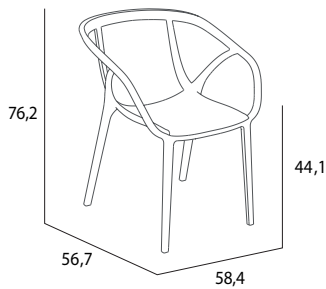

taupe	MN-HOP00-024X00	72,00 €
terracota	MN-HOP00-026X00	
olivo	MN-HOP00-066X00	

name	info	structure	reference	€
------	------	-----------	-----------	---

FADO

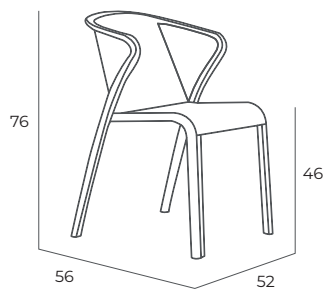

sand	MN-FAD00-071X00	72,00 €
taupe	MN-FAD00-024X00	
anthracite	MN-FAD00-091X00	
brick	MN-FAD00-065X00	
mustard	MN-FAD00-064X00	
aquamarine	MN-FAD00-084X00	
olivo	MN-FAD00-066X00	

name	info	structure	reference	€
ATTIC				
		white	MT-ATT00-010X00	81,00 €
		sand	MT-ATT00-071X00	
		taupe	MT-ATT00-024X00	
		anthracite	MT-ATT00-091X00	
		brick	MT-ATT00-065X00	
		mustard	MT-ATT00-064X00	
		aquamarine	MT-ATT00-084X00	
		olivo	MT-ATT00-066X00	

name	info	structure	reference	€
TOWN ARMCHAIR				
		white	MN-TOW00-010X00	81,00 €
		taupe	MN-TOW00-024X00	
		anthracite	MN-TOW00-091X00	
		brick	MN-TOW00-065X00	
		mustard	MN-TOW00-064X00	
		olivo	MN-TOW00-066X00	

name	info	structure	reference	€
TOWN CHAIR				
		white	MS-TOW00-010X00	72,00 €
		taupe	MS-TOW00-024X00	
		anthracite	MS-TOW00-091X00	
		brick	MS-TOW00-065X00	
		mustard	MS-TOW00-064X00	
		olivo	MS-TOW00-066X00	

name	info	structure	pad	reference	€
TOWN ARMCHAIR PAD					
		white	taupe	MN-TOW10-010X-015S0	115,00 €
		taupe	taupe	MN-TOW10-024X-015S0	
		anthracite	grey	MN-TOW10-091X-013S0	
		brick	taupe	MN-TOW10-065X-015S0	
		mustard	taupe	MN-TOW10-064X-015S0	
		olivo	grey	MN-TOW10-066X-013S0	

name	info	structure	pad	reference	€
TOWN CHAIR PAD					
		white	taupe	MS-TOW10-010X-015S0	106,00 €
		taupe	taupe	MS-TOW10-024X-015S0	
		anthracite	grey	MS-TOW10-091X-013S0	
		brick	taupe	MS-TOW10-065X-015S0	
		mustard	taupe	MS-TOW10-064X-015S0	
		olivo	grey	MS-TOW10-066X-013S0	

name	info	structure	reference	€
PARK ARMCHAIR				
		white	MN-PAR00-010X00	81,00 €
		taupe	MN-PAR00-024X00	
		anthracite	MN-PAR00-091X00	
		ocean*	MN-PAR00-083X00	
		olivo	MN-PAR00-066X00	

name	info	structure	reference	€
PARK CHAIR*				
		white	MS-PAR00-010X00	72,00 €
		taupe	MS-PAR00-024X00	
		anthracite	MS-PAR00-091X00	
		ocean	MS-PAR00-083X00	
		olivo	MS-PAR00-066X00	

name	info	structure	reference	€
DOCK				
		white	MN-DOC00-010X00	59,00 €
		sand	MN-DOC00-071X00	
		taupe	MN-DOC00-024X00	
		anthracite	MN-DOC00-091X00	
		moka	MN-DOC00-093X00	
		brick	MN-DOC00-065X00	

name	info	structure	reference	€
LAND				
	<p>PHIFERTEX Outdoor Fabrics</p>	white	MN-LAN00-010T11	149,00 €
		taupe	MN-LAN00-020T11	
		anthracite	MN-LAN00-091T11	

name	info	structure	reference	€
MONACO				
	<p>ECOWOOD</p>	white	MN-MON01-010T11	129,00 €
		sand	MN-MON01-071T11	
		taupe	MN-MON01-020T11	
		anthracite	MN-MON01-091T11	
		moka	MN-MON01-093T11	

name	info	structure	reference	€
SICILIA				
	<p>ECOWOOD</p>	white	MN-SIC00-041J00	125,00 €
		anthracite	MN-SIC00-091J00	
		moka	MN-SIC00-093J00	

cojines · almofadas · cushions · coussins

515 Bake, Hop, Rod, Dock, Town, Park, Sicilia

CAYO105150010P1 101010 taupe
 CAYO105150010P1 110010 anthracite

25,00 €

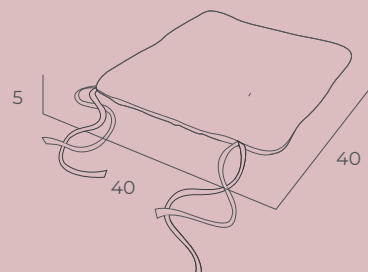

mesas tables

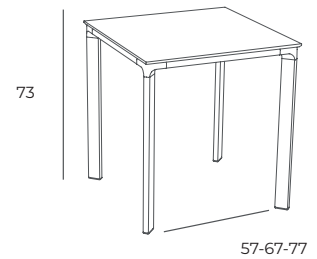
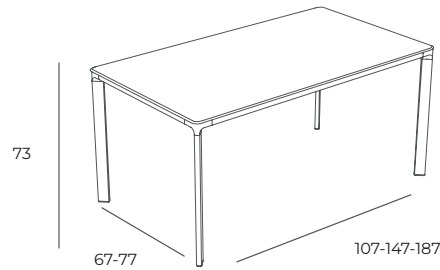
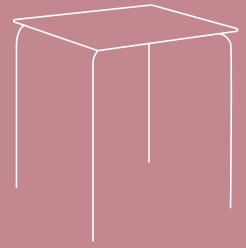

name	info	leg colour	leg reference	€ pata/leg	table reference	€ mesa/table
MEET 70X70						
COMPACT		white	40MEE04	167,00 €	MHK-MEEC07004	249,00 €
		taupe	40MEE06		MHK-MEEC07006	
		anthracite	40MEE05		MHK-MEEC07005	
MEET 80X80						
COMPACT		white	40MEE14	182,00 €	MHK-MEEC08004	322,00 €
		taupe	40MEE16		MHK-MEEC08006	
		anthracite	40MEE15		MHK-MEEC08005	
MEET 90X90						
COMPACT		white	40MEE24	202,00 €	MHK-MEEC09004K*	376,00 €
		taupe	40MEE26		MHK-MEEC09006K*	
		anthracite	40MEE25		MHK-MEEC09005K*	
MEET 120X80						
COMPACT		white	40MEE104	205,00 €	MHK-MEEH12004K*	435,00 €
		taupe	40MEE106		MHK-MEEH12006K*	
		anthracite	40MEE105		MHK-MEEH12005K*	
MEET 160X90						
COMPACT		white	40MEE204	285,00 €	MHK-MEEH16004K*	673,00 €
		taupe	40MEE206		MHK-MEEH16006K*	
		anthracite	40MEE205		MHK-MEEH16005K*	
MEET 200X90						
COMPACT		white	40MEE304	399,00 €	MHK-MEEH20004K*	834,00 €
		taupe	40MEE306		MHK-MEEH20006K*	
		anthracite	40MEE305		MHK-MEEH20005K*	

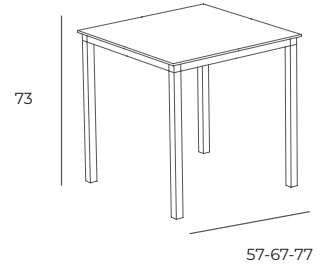
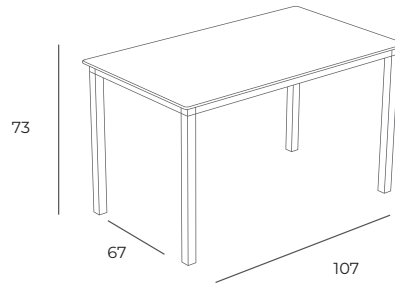

name	info	leg colour	leg reference	€ pata/leg	table reference	€ mesa/table
MONACO 70X70						
 COMPACT	white	40MOT04	121,00 €	MHK-MOTC07004	203,00 €	
	sand	40MOT08		MHK-MOTC07008		
	taupe	40MOT06		MHK-MOTC07006		
	anthracite	40MOT05		MHK-MOTC07005		
	moka	40MOT07		MHK-MOTC07007		
MONACO 80X80						
 COMPACT	white	40MOT14	141,00 €	MHK-MOTC08004	281,00 €	
	sand	40MOT18		MHK-MOTC08008		
	taupe	40MOT16		MHK-MOTC08006		
	anthracite	40MOT15		MHK-MOTC08005		
	moka	40MOT17		MHK-MOTC08007		
MONACO 120X80						
 COMPACT	white	40MOT104	163,00 €	MHK-MOTH12004K*	393,00 €	
	sand	40MOT108		MHK-MOTH12008K*		
	taupe	40MOT106		MHK-MOTH12006K*		
	anthracite	40MOT105		MHK-MOTH12005K*		
	moka	40MOT107		MHK-MOTH12007K*		

* Se entrega en KIT (desmontada). Entregue em KIT (desmontado). Delivered in KIT (disassembled). Livré en KIT (démonté).

COLORES TABLEROS
CORES TAMPOS
TOPS COLOUR RANGE
COULEURS PLATEAUX
 p. 17

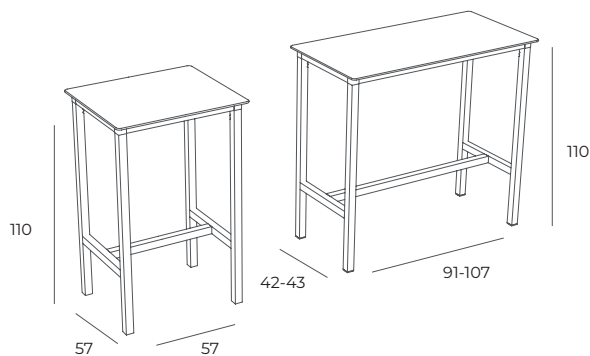

name	info	leg colour	leg reference	€ pata/leg	table reference	€ mesa/table
URBAN 70X70						
COMPACT		white	40URT19	227,00 €	MLK-URTC07009	309,00 €
		taupe	40URT17		MLK-URTC07007	
		anthracite	40URT15		MLK-URTC07005	
URBAN 104X55*						
COMPACT		white	40URT09	227,00 €	MLK-URTH10409	381,00 €
		taupe	40URT07		MLK-URTH10407	
		anthracite	40URT05		MLK-URTH10405	
URBAN 120X60 NEW						
COMPACT		white	40URT29	245,00 €	MLK-URTH12009	472,00 €
		taupe	40URT27		MLK-URTH12007	
		anthracite	40URT25		MLK-URTH12005	

* Hasta fin de existencias/Limitado ao stock existente/Up to end of stock/Jusqu' à fin de stocks.

COLORES TABLEROS
 CORES TAMPOS
 TOPS COLOUR RANGE
 COULEURS PLATEAUX
 p. 17



name	info	leg colour	leg reference	€ pata/leg	table reference	€ mesa/table
QUATRO FOLD 60X60						
	white	40QUA00	129,00 €	MHK-QUAC06000	201,00 €	
	sand	40QUA04		MHK-QUAC06004		
	taupe	40QUA03		MHK-QUAC06003		
	anthracite	40QUA01		MHK-QUAC06001		
	moka	40QUA02		MHK-QUAC06002		
QUATRO FOLD 70X70						
	white	40QUA00	129,00 €	MHK-QUAC07000	211,00 €	
	sand	40QUA04		MHK-QUAC07004		
	taupe	40QUA03		MHK-QUAC07003		
	anthracite	40QUA01		MHK-QUAC07001		
	moka	40QUA02		MHK-QUAC07002		
QUATRO FOLD 60Ø						
	white	40QUA00	129,00 €	MHK-QUAR06000	218,00 €	
	sand	40QUA04		MHK-QUAR06004		
	taupe	40QUA03		MHK-QUAR06003		
	anthracite	40QUA01		MHK-QUAR06001		
	moka	40QUA02		MHK-QUAR06002		
QUATRO FOLD 70Ø						
	white	40QUA00	129,00 €	MHK-QUAR07000	244,00 €	
	sand	40QUA04		MHK-QUAR07004		
	taupe	40QUA03		MHK-QUAR07003		
	anthracite	40QUA01		MHK-QUAR07001		
	moka	40QUA02		MHK-QUAR07002		
QUATRO FIX 60X60						
	taupe	40QUF03	109,00 €	MHK-QUFC06003	181,00 €	
	anthracite	40QUF01		MHK-QUFC06001		
QUATRO FIX 70X70						
	taupe	40QUF03	109,00 €	MHK-QUFC07003	191,00 €	
	anthracite	40QUF01		MHK-QUFC07001		
QUATRO FIX 80X80 (Pesos incluidos)						
	taupe	40QUF03	147,00 €	MHK-QUFC08003	287,00 €	
	anthracite	40QUF01		MHK-QUFC08001		

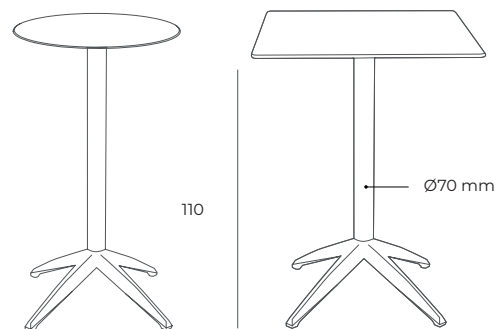

name	info	leg colour	leg reference	€ pata/leg	table reference	€ mesa/table
QUATRO HIGH FIX 60X60						
	white	40QUF10	159,00 €	MLK-QUFC06010	231,00 €	
	sand	40QUF14		MLK-QUFC06014		
	taupe	40QUF13		MLK-QUFC06013		
	anthracite	40QUF11		MLK-QUFC06011		
	moka	40QUF12		MLK-QUFC06012		
QUATRO HIGH FIX 70X70						
	white	40QUF10	159,00 €	MLK-QUFC07010	241,00 €	
	sand	40QUF14		MLK-QUFC07014		
	taupe	40QUF13		MLK-QUFC07013		
	anthracite	40QUF11		MLK-QUFC07011		
	moka	40QUF12		MLK-QUFC07012		
QUATRO HIGH FIX 60Ø						
	white	40QUF10	159,00 €	MLK-QUFR06010	248,00 €	
	sand	40QUF14		MLK-QUFR06014		
	taupe	40QUF13		MLK-QUFR06013		
	anthracite	40QUF11		MLK-QUFR06011		
	moka	40QUF12		MLK-QUFR06012		
QUATRO HIGH FIX 70Ø						
	white	40QUF10	159,00 €	MLK-QUFR07010	274,00 €	
	sand	40QUF14		MLK-QUFR07014		
	taupe	40QUF13		MLK-QUFR07013		
	anthracite	40QUF11		MLK-QUFR07011		
	moka	40QUF12		MLK-QUFR07012		

Set 4 pesos QUATRO Incluidos / Set 4 pesos QUATRO Incluído / Set 4 ballast QUATRO Included / Set 4 poids QUATRO inclus. Ref. 44025.

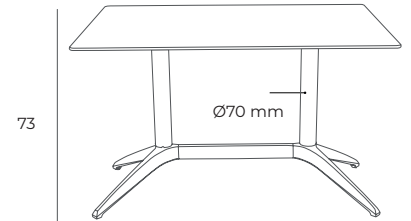

name	info	leg colour	leg reference	€ pata/leg	table reference	€ mesa/table
QUATRO DUO FIX 120X80						
	white	40QUF000	198,00 €	MHK-QUFH12000	428,00 €	
	taupe	40QUF003		MHK-QUFH12003		
	anthracite	40QUF001		MHK-QUFH12001		
	sand	40QUF004		MHK-QUFH12004		

NO INCLUIDO Set 4 pesos. NÃO INCLUI Conjunto de 4 pesos. NOT INCLUDED Set 4 ballast. NON INCLU Jeu de 4 poids.
 (Recomendable para mayor estabilidad/Recomendado para maior estabilidade/Recommended for greater stability/
 Recommandé pour plus de stabilité). Ref. 44025. **38,00 €**



name	info	leg colour	leg reference	€ pata/leg	table reference	€ mesa/table
ONE 70X70						
	white	42ONE10	115,00 €	MHK-ONEC07000	204,00 €	
	sand	42ONE15		MHK-ONEC07005		
	taupe	42ONE12		MHK-ONEC07002		
	anthracite	42ONE11		MHK-ONEC07001		

COLORES TABLEROS
 CORES TAMPOS
 TOPS COLOUR RANGE
 COULEURS PLATEAUX
 p. 17



name	info	leg colour	leg reference	€ pata/leg	table reference	€ mesa/table
RODAS 70X70						
		white	40BRO01		MHK-BROC07000	120,00 €
		taupe	40TRO00	38,00 €	MHK-TROC07000	
		anthracite	40ARO00		MHK-AROC07000	

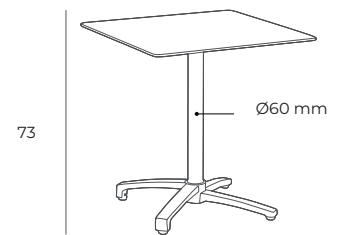

name	info	leg colour	leg reference	€ pata/leg	table reference	€ mesa/table
KOS 60X60						
		white	42KOS00		MHK-KOSC06000	221,00 €
		taupe	42KOS01	149,00 €	MHK-KOSC06001	
		anthracite	42KOS02		MHK-KOSC06002	
KOS 70X70						
		white	42KOS00		MHK-KOSC07000	231,00 €
		taupe	42KOS01	149,00 €	MHK-KOSC07001	
		anthracite	42KOS02		MHK-KOSC07002	
KOS 60Ø						
		white	42KOS00		MHK-KOSR06000	238,00 €
		taupe	42KOS01	149,00 €	MHK-KOSR06001	
		anthracite	42KOS02		MHK-KOSR06002	
KOS 70Ø						
		white	42KOS00		MHK-KOSR07000	264,00 €
		taupe	42KOS01	149,00 €	MHK-KOSR07001	
		anthracite	42KOS02		MHK-KOSR07002	

NO INCLUIDO Set 4 pesos. NÃO INCLUI Conjunto de 4 pesos. NOT INCLUDED Set 4 ballast. NON INCLU Jeu de 4 poids.
 (Recomendable para mayor estabilidad/Recomendado para maior estabilidade/Recommended for greater stability/
 Recommandé pour plus de stabilité). Ref. 44023. **30,00 €**

compact colours range

Colour	Ref.	Size												
		60x60	70x70	80x80	90x90	120x80	160x90	200x90	ø60	ø70	104x55* Urban	120x60 Urban	70x70 One	60x70**
		<input type="checkbox"/>	<input type="checkbox"/>	<input type="checkbox"/>	<input type="checkbox"/>	<input type="checkbox"/>	<input type="checkbox"/>	<input type="checkbox"/>	<input type="checkbox"/>	<input type="checkbox"/>	<input type="checkbox"/>	<input type="checkbox"/>	<input type="checkbox"/>	<input type="checkbox"/>
WHITE	010K00	✓	✓	✓	✓	✓	✓	✓	✓	✓	✓	✓	✓	✓
WHITE MARBLE	013K00	✓	✓	✓		✓					✓	✓	✓	✓
DARK OAK	093K00	✓	✓	✓		✓			✓	✓	✓	✓	✓	✓
OAK	092K00	✓	✓	✓		✓			✓	✓	✓	✓	✓	✓
TAUPE	020K00	✓	✓	✓	✓	✓	✓	✓	✓	✓	✓	✓	✓	✓
ANTHRACITE *	091K00	✓	✓	✓	✓	✓	✓	✓			✓	✓	✓	✓
BLACK MARBLE *	094K00	✓	✓	✓		✓					✓	✓	✓	✓
STONE	028K00	✓	✓	✓	✓	✓	✓	✓			✓	✓	✓	✓

* Utilizar estos colores en zonas con sombra.
 Não se recomendam cores escuras para zonas muito soalheiras.
 Dark colors are not recommended for very sunny areas.
 Les couleurs foncées ne sont pas recommandées pour les zones très ensoleillées.

tableros tampos tops plateaux

Size	Ref.	€
60X60	45K00C06000	72,00 €
70X70	45K00C07000	82,00 €
80X80	45K00C08000	140,00 €
90X90 MEET**	45K00C09000	174,00 €
120X80	45K00H12000	230,00 €
160X90 MEET**	45K00H16001	388,00 €
200X90 MEET**	45K00H20000	435,00 €
Ø60***	45K00R06000	89,00 €
Ø70***	45K00R07000	115,00 €
104X55 URBAN	45K00H10400	154,00 €
120x60 URBAN	45K00H12001	227,00 €
70X70 ONE	45K00C07001	89,00 €
60X70	45K00H06002	78,00 €
45X45 VILA*	45K00C04501	75,00 €

* White/Taupe/Anthracite
 ** White/Taupe/Anthracite/Stone
 *** White/Taupe/Oak/Dark Oak

Tablero/Tampo/Top/Plaqueaux →	45X45	60X60	70X70	80X80	90X90	120X60	120X80	160X90	200X90	Ø60	Ø70	104X55
Pie/Pé/Leg/Pied ↓	75,00 €	72,00 €	82,00 €	140,00 €	174,00 €	227,00 €	230,00 €	388,00 €	435,00 €	89,00 €	115,00 €	154,00 €
MEET 70X70	167,00 €		249,00 €									
MEET 80X80	182,00 €			322,00 €								
MEET 90X90	202,00 €				376,00 €							
MEET 120X80	205,00 €						435,00 €					
MEET 160X90	285,00 €							673,00 €				
MEET 200X90	399,00 €								834,00 €			
MONACO 70X70	121,00 €		203,00 €									
MONACO 80X80	141,00 €			281,00 €								
MONACO 120X80	163,00 €						393,00 €					
URBAN 70X70	227,00 €		309,00 €									
URBAN 104X55	227,00 €											381,00 €
URBAN 120x60	245,00 €					472,00 €						
RODAS	38,00 €		120,00 €									
QUATRO FOLD	129,00 €	201,00 €	211,00 €							218,00 €	244,00 €	
QUATRO FIX	109,00 €	181,00 €	191,00 €									
QUATRO FIX C/PESO	147,00 €			287,00 €								
QUATRO DUO FIX	198,00 €						428,00 €					
QUATRO HIGH FIX	159,00 €	231,00 €	241,00 €							248,00 €	274,00 €	
KOS	149,00 €	221,00 €	231,00 €							238,00 €	264,00 €	
VILA	81,00 €	156,00 €										

Tablero/Tampo/Top/Plaqueaux → 70X70

Pie/Pe/Leg/Pied ↓ 89,00 €

ONE 4 115,00 € **204,00 €**

loungé

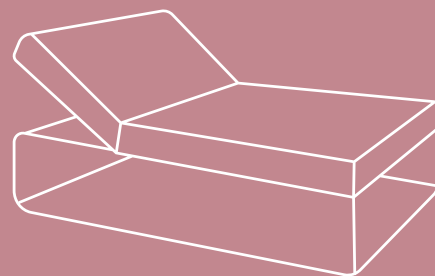

name	info	structure	Phifertex®	reference	€
LAGO					

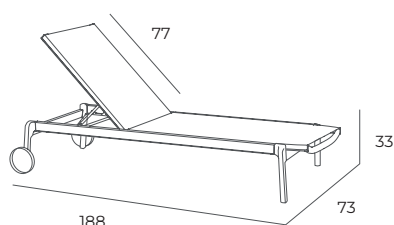

white	white
taupe	taupe
taupe	tweed olivo

MU-LAG00-010T11	
MU-LAG00-020T11	375,00 €
MU-LAG00-066T11	

name	info	structure	Phifertex®	reference	€
VILA					

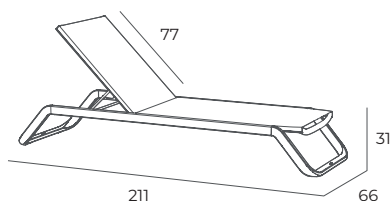

white	white
white	taupe
taupe	taupe
taupe	tweed olivo
anthracite	anthracite

MU-VLA00-010T11	
MU-VLA02-020T11	NEW
MU-VLA00-020T11	355,00 €
MU-VLA00-066T11	
MU-VLA00-091T11	

name	info	structure	Phifertex®	reference	€
VILA ARMS*					

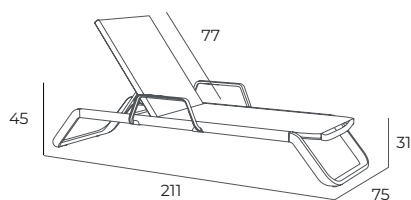

white	white
white	taupe
taupe	taupe
taupe	tweed olivo
anthracite	anthracite

MU-VLA01-010T11	
MU-VLA03-020T11	NEW
MU-VLA01-020T11	411,00 €
MU-VLA01-066T11	
MU-VLA01-091T11	

name	info	structure	Compact	reference	€
VILA TABLE					

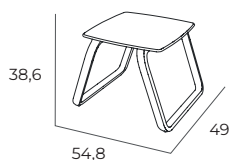

white	white
taupe	taupe
anthracite	anthracite

MAK-VLAC04505-010K00	
MAK-VLAC04506-020K00	
MAK-VLAC04507-091K00	156,00 €

* Hasta fin de existencias/Limitado ao stock existente/Up to end of stock/Jusqu'à fin de stocks.

name	info	colour	reference	€
------	------	--------	-----------	---

AQUA

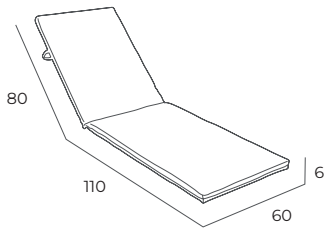

4 u.
Caja/Caixa/Box/Carton

white
taupe
beige

CTQT00681001P1-003T00	
CTQT00681001P1-020T00	144,00 €
CTQT00681001P1-001T00	

name	info	colour	reference	€
------	------	--------	-----------	---

NAUTIC

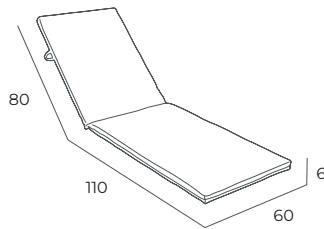

4 u.
Caja/Caixa/Box/Carton

white
taupe

CTQP07681001C1-010P07	
CTQP07681001C1-020P07	174,00 €

No utilizar productos abrasivos/Não utilizar produtos abrasivos /Do not use abrasive products /Ne pas utiliser de produit abrasif

name	info	colour	reference	€
------	------	--------	-----------	---

NANA

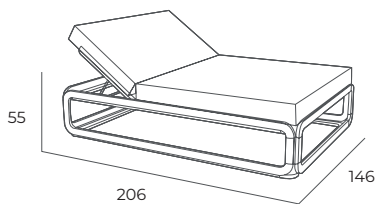

white
taupe

MQ-NAN00140X200BC	
MQ-NAN00140X200TP	2398,00 €

No utilizar productos abrasivos/Não utilizar produtos abrasivos /Do not use abrasive products /Ne pas utiliser de produit abrasif

name	info	structure colour	canopy colour	reference	€
------	------	------------------	---------------	-----------	---

IBIZA XL 180X200

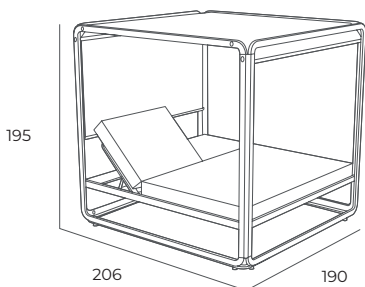

white	white
white	taupe
taupe	taupe

MQ-IBI01D00180X200BC-844D00	
MQ-IBI01D00180X200BC-807D00	3964,00 €
MQ-IBI01D00180X200TP-807D00	

Cortinas laterales / Cortinas laterais / Side curtains / Rideaux latéraux:

Daybed IBIZA XL	IGAD00DAY01	119,00 €/U.
-----------------	-------------	--------------------

Colores tejido / Cores tecido / Fabric colours / Couleurs toile:

Dralon: 844D00 WHITE / 807D00 TAUPE

AQUA / NAUTIC

ES: Guardar seco. No mantener a la intemperie en condiciones meteorológicas adversas.
 PT: Guardar seco. Evitar exposição sob intempérie, em condições meteorológicas adversas.
 EN: Store dry. Do not keep under adverse weather conditions.
 FR: Garder sec. Éviter toute exposition sous intempérie, ou conditions météorologiques dégradées.

MARINE SINGLE SOFA

Estructura/Estrutura/ Structure/Structure:

MF-MAR01-010A02	white	449,00 €
------------------------	-------	-----------------

+

SET 4 Cojines / Almofadas / Cushions / Coussins:

CPF-MARP07280P	461,00 €
-----------------------	-----------------

010P07 white	NAUTIC
--------------	--------

TOTAL	910,00 €
--------------	-----------------

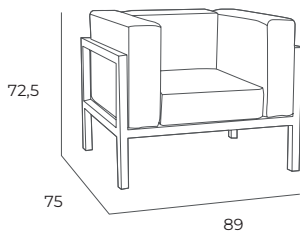
MARINE CORNER SOFA

Estructura/Estrutura/ Structure/Structure:

MF-MAR00-010A02	white	374,00 €
------------------------	-------	-----------------

+

SET 3 Cojines / Almofadas / Cushions / Coussins:

CPF-MARP07282P	351,00 €
-----------------------	-----------------

010P07 white	NAUTIC
--------------	--------

TOTAL	725,00 €
--------------	-----------------

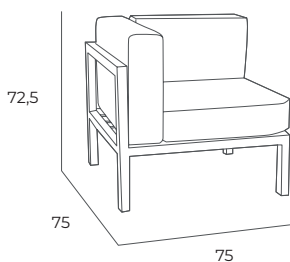

MARINE IN-BETWEEN SOFA

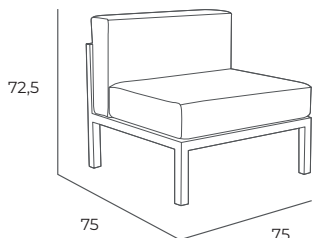

Estructura/Estrutura/ Structure/Structure:

MF-MAR04-010A02 white **294,00 €**

+

SET 2 Cojines / Almofadas / Cushions / Coussins:

CPF-MARP07283P **273,00 €**

010P07 white NAUTIC

TOTAL 567,00 €

MARINE POUF

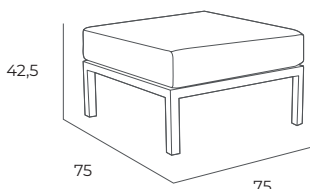

Estructura/Estrutura/ Structure/Structure:

MC-MAR00-010A02 white **215,00 €**

+

1 Cojin / Almofada / Cushion / Coussin:

CPP-MARP07284P **173,00 €**

010P07 white NAUTIC

TOTAL 388,00 €

MARINE TABLE

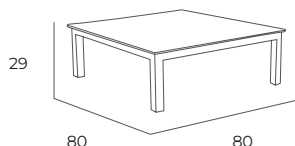

COMPACT

Mesa centro / Mesa centro / Centre table / Table centrale

MC-MAR00-010A02 white **215,00 €**

+

80X80 blanco/branco/white/blanc - taupe COMPACT

45K00C08000-010K00 white **140,00 €**

TOTAL 355,00 €



NAUTIC

ES: Guardar seco. No mantener a la intemperie en condiciones meteorológicas adversas.

No utilizar productos abrasivos.

PT: Guardar seco. Evitar exposição sob intempérie, em condições meteorológicas adversas.

Não utilizar produtos abrasivos.

EN: Store dry. Do not keep under adverse weather conditions.

Do not use abrasive products.

FR: Garder sec. Éviter toute exposition sous intempérie, ou conditions météorologiques dégradées.

Ne pas utiliser de produit abrasif

separadores space dividers séparateurs

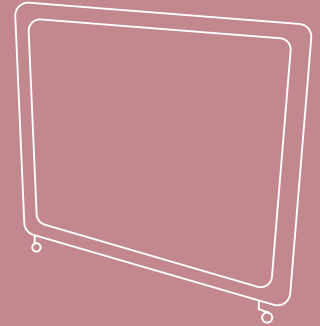

name	info	colour	reference	€
------	------	--------	-----------	---

SIENA MAXI METHACRYLATE

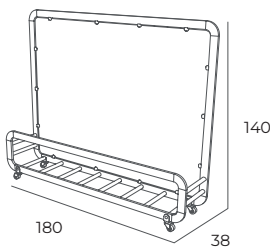

SIENA: Methacrylate.
Se sirve montado
É servido montado
Served assembled
Livré monté

white	MO-MSIE052B
taupe	MO-MSIE05T
anthracite	MO-MSIE05A

839,00 €



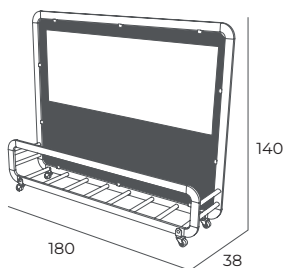





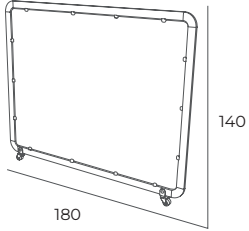

SIENA MAXI OLEFIN

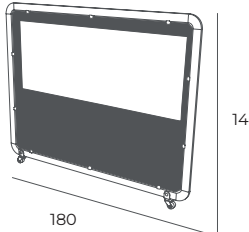

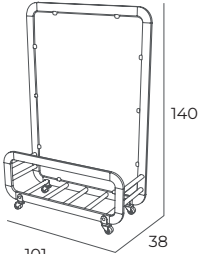
SIENA: Olefin.
Kit montaje
Kit montagem
Assembly kit
Kit de montage

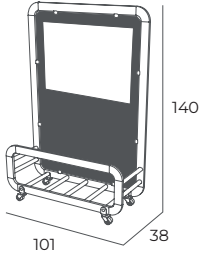
white	MO-VO10SIE051B - 112010
taupe	MO-VO10SIE05T - 101010
anthracite	MO-VO10SIE05A - 110010

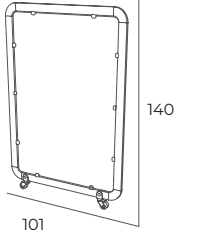
608,00 €

name	info	colour	reference	€
SIENA MAXI METHACRYLATE				
 <p>180</p> <p>140</p>	 <p>SIENA: Methacrylate. Se sirve montado É servido montado Served assembled Livre monté</p>	white	MO-MSIE032B	506,00 €
		taupe	MO-MSIE03T	
		anthracite	MO-MSIE03A	
SIENA MAXI OLEFIN				
 <p>180</p> <p>140</p>	 <p>SIENA: Olefin. Kit montaje Kit montagem Assembly kit Kit de montage</p>	white	MO-VO10SIE031B - 112010	326,00 €
		taupe	MO-VO10SIE03T - 101010	
		anthracite	MO-VO10SIE03A - 110010	
SIENA MINI METHACRYLATE*				
 <p>101</p> <p>38</p> <p>140</p>	 <p>SIENA: Methacrylate. Se sirve montado É servido montado Served assembled Livre monté</p>	white	MO-MSIE062B	625,00 €
		taupe	MO-MSIE06T	
		anthracite	MO-MSIE06A	
SIENA MINI OLEFIN				
 <p>101</p> <p>38</p> <p>140</p>	 <p>SIENA: Olefin. Kit montaje Kit montagem Assembly kit Kit de montage</p>	white	MO-VO10SIE061B - 112010	499,00 €
		taupe	MO-VO10SIE06T - 101010	
		anthracite	MO-VO10SIE06A - 110010	
SIENA MINI METHACRYLATE*				
 <p>101</p> <p>140</p>	 <p>SIENA: Methacrylate. Se sirve montado É servido montado Served assembled Livre monté</p>	white	MO-MSIE042B	377,00 €
		taupe	MO-MSIE04T	
		anthracite	MO-MSIE04A	

name	info	colour	reference	€
SIENA MINI OLEFIN				
	<p>SIENA: Olefin. Kit montaje Kit montagem Assembly kit Kit de montage</p>	white	MO-VO10SIE041B - 112010	290,00 €
		taupe	MO-VO10SIE04T - 101010	
		anthracite	MO-VO10SIE04A - 110010	

name	colour	reference	€
JARDINERA · JARDINEIRA · FLOWERPOT · JARDINIÈRE			
	white	MO-JAR04	115,00 €
	black	MO-JAR03	

name	reference	€
RUEDA · RODA · WHEEL · ROUE		
	Con freno/ Com freio With brake/ Avec frein	MO-SIE41 27,00 €
	Sin freno/ Sem freio Without brake/ Sans frein	MO-SIE40 20,00 €

name	colour	reference	€
PERNIO INDIVIDUAL · DOBRADIÇA INDIVIDUAL · INDIVIDUAL FITTINGS · JOINT FLEXIBLE INDIVIDUEL			
	white	MO-SIE53B	20,00 €
	taupe	MO-SIE53T	
	anthracite	MO-SIE53A	

name	colour	reference	€
PERNIO PARA PARED · DOBRADIÇA PARA PAREDE · WALL FITTINGS · JOINT FLEXIBLE POUR MUR			
	white	MO-SIE52B	25,00 €
	taupe	MO-SIE52T	
	anthracite	MO-SIE52A	

name	reference	€
VINILO DECORATIVO · VINIL DECORATIVO · DECORATIVE VINYL · VINIL PERSONALISE		
	MO-SIE90 MINI	Consultar precio Consultar preço Ask for prices Prix s / demande
	MO-SIE91 MAXI	

parasoles guarda-sóis parasols

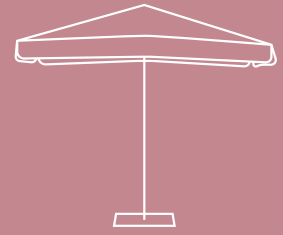

tube ø48 mm



tube ø48 mm



tube ø48 mm

name	info	structure colour	fabric	€
EOLO PURETI				



4 varillas/varetas
ribs/baleines (20x14mm)

Registered design
Nº. 007003710

1 u. caja/caixa/box/carton



ALUMINIUM

Base/Pied:
Cube / Fix / Fast Click / Round
Mould / Bond / Flat / Canto

NEW



3 X 3

structure colour	fabric	€
white	SGAO10C3002720P	337,00 €
taupe	SGAO10C3002820P	337,00 €
anthracite	SGAO10C3002620P	337,00 €



2,5 X 2,5

structure colour	fabric	€
white	SIAO10C2501720P	285,00 €
taupe	SIAO10C2501820P	285,00 €
anthracite	SIAO10C2501620P	285,00 €



2 X 2

structure colour	fabric	€
white	SPAO10C2002721P	260,00 €
taupe	SPAO10C2002821P	260,00 €
anthracite	SPAO10C2002621P	260,00 €

name	info	structure colour	fabric	€
EOLO SUNBRELLA				



tube ø48 mm



tube ø48 mm



tube ø48 mm

NEW

4 varillas/varetas
ribs/baleines (20x14mm)

1 u. caja/caixa/box/carton

ALUMINIUM

Base/Pied:
Cube / Fix / Fast Click / Round
Mould / Bond / Flat / Canto



3 X 3

structure colour	fabric	€
white	SGAD24C3002771P	597,00 €
taupe	SGAD24C3002871P	597,00 €
anthracite	SGAD24C3002671P	597,00 €



2,5 X 2,5

structure colour	fabric	€
white	SIAD24C2502771P	559,00 €
taupe	SIAD24C2502871P	559,00 €
anthracite	SIAD24C2502671P	559,00 €



2 X 2

structure colour	fabric	€
white	SPAD24C2002770P	457,00 €
taupe	SPAD24C2002870P	457,00 €
anthracite	SPAD24C2002670P	457,00 €

name		info	structure colour	fabric	€
EOLO 3x3		<p>NEW</p> <p>4 varillas/varetas ribs/baleines (20x14mm)</p> <p>Registered design N° . 007003710</p> <p>1 u. caja/caixa/box/carton</p> <p>OLEFIN FIBER 190g</p> <p>ALUMINIUM Base/Pied: Cube / Fix / Fast Click / Round Mould / Bond / Flat / Canto</p>	OLEFIN 190 GRS		
	white		SGAO10C3002740P	337,00 €	
	taupe		SGAO10C3002840P	337,00 €	
	anthracite		SGAO10C3002640P	337,00 €	
	white		SGAO10C3002721P	337,00 €	
	taupe		SGAO10C3002821P	337,00 €	
	anthracite		SGAO10C3002621P	337,00 €	

name		info	structure colour	fabric	€
EOLO 2,5x2,5		<p>4 varillas/varetas ribs/baleines (20x14mm)</p> <p>Registered design N° . 007003710</p> <p>1 u. caja/caixa/box/carton</p> <p>OLEFIN FIBER 190g</p> <p>ALUMINIUM Base/Pied: Cube / Fix / Fast Click / Round Mould / Bond / Flat / Canto</p>	OLEFIN 190 GRS		
	white		SIAO10C2502740P	285,00 €	
	taupe		SIAO10C2502840P	285,00 €	
	anthracite		SIAO10C2502640P	285,00 €	
	white		SIAO10C2502721P	285,00 €	
	taupe		SIAO10C2502821P	285,00 €	
	anthracite		SIAO10C2502621P	285,00 €	

name		info	structure colour	fabric	€
EOLO 2X2		<p>4 varillas/varetas ribs/baleines (20x14mm)</p> <p>Registered design N° . 007003710</p> <p>1 u. caja/caixa/box/carton</p> <p>OLEFIN FIBER 190g</p> <p>ALUMINIUM Base/Pied: Cube / Fix / Fast Click / Round Mould / Bond / Flat / Canto</p>	OLEFIN 190 GRS		
	white		SPA010C2002740P	260,00 €	
	taupe		SPA010C2002840P	260,00 €	
	anthracite		SPA010C2002640P	260,00 €	
	white		SPA010C2002720P	260,00 €	
	taupe		SPA010C2002820P	260,00 €	
	anthracite		SPA010C2002620P	260,00 €	

name	info	structure colour	fabric	€
FLEXO 3x3				

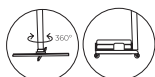
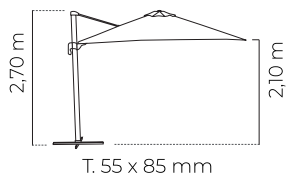

Sistema estabilizador
Système stabilisateur
Stabilizer system

Cruceta incluida
Crossover incluido
Crossing included
Croix incluse

4 varillas/varetas
ribs/baleines (20x14mm)

Registered design
Nº . 007003710

1 u. caja/caixa/box/carton



ALUMINIUM

Base/Pied:
Slab /Kit Flexo

OLEFIN 190 GRS

	white	SGAO10C3005021P	869,00 €
	black	SGAO10C3005020P	869,00 €
	taupe	SGAO10C3005022P	869,00 €

name	info	structure colour	fabric	€
RIO 4X4				

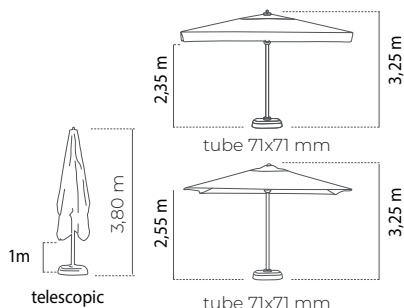

8 varillas/varetas
ribs/baleines (20x35x1,5 mm)

1 u. caja/caixa/box/carton



ALUMINIUM

Base/Pied:
**Kit Cross Rio / Fix Rio
Fast Click Rio**

OLEFIN 250 GRS

	white	SGAO20C4000240P	1.450,00 €
	anthracite	SGAO20C4000440P	1.450,00 €
	white	SGAO20C4000220P	1.450,00 €
	anthracite	SGAO20C4000420P	1.450,00 €

name	info	structure colour	fabric	€
FORMENTERA 3X3				

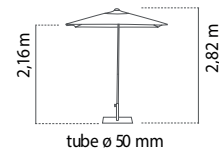
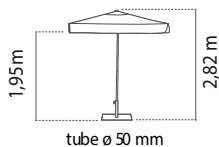

8 varillas/varetas
ribs/baleines (30x20mm)

1 u. caja/caixa/box/carton



ALUMINIUM

Base/Pied:
**Cube / Fix / Fast Click
Bond / Flat / Canto**

OLEFIN 190 GRS

	white	SGAO10C3000240P	546,00 €
	anthracite	SGAO10C3000540P	546,00 €
	white	SGAO10C3000220P	546,00 €
	anthracite	SGAO10C3000520P	546,00 €



name	info	structure colour	fabric	€
FORMENTERA 3,5X3,5				

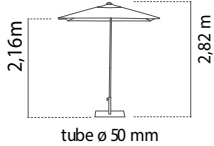
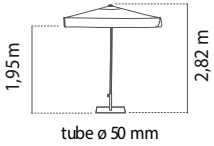

8 varillas/varetas ribs/baleines (30x20mm)
1 u. caja/caixa/box/carton



ALUMINIUM

Base/Pied:
Kit Cross / Cube / Fix
Fast Click / Canto

OLEFIN 190 GRS

	white	SGAO10C3500140P	724,00 €
	anthracite	SGAO10C3500340P	724,00 €
	white	SGAO10C3500120P	724,00 €
	anthracite	SGAO10C3500320P	724,00 €



name	structure colour	reference	€
RIO	WHITE 4X4	SGAP11C4000340P	2.199,00 €
RIO	ANTHRACITE 4X4	SGAP11C4000440P	2.199,00 €
FORMENTERA	WHITE 3,5X3,5	SGAP11C3500142P	1.084,00 €
FORMENTERA	ANTHRACITE 3,5X3,5	SGAP11C3500342P	1.084,00 €
FORMENTERA	WHITE 3X3	SGAP11C3000242P	819,00 €
FORMENTERA	ANTHRACITE 3X3	SGAP11C3000542P	819,00 €

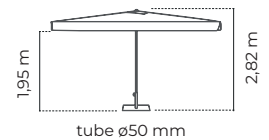
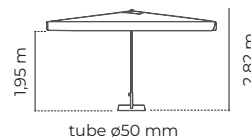
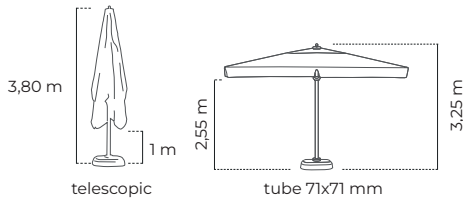

canalón caleira gutter gouttières

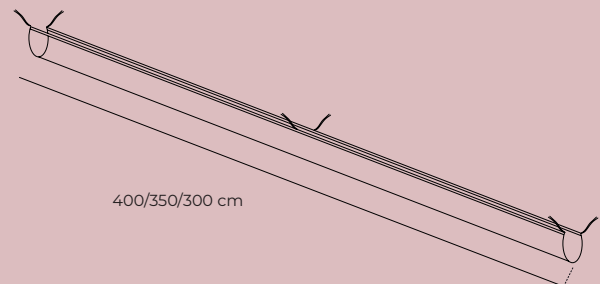

Canalones de unión impermeable. Protege la terraza de la lluvia uniendo dos parasols. Canalón de PVC, varillas de aluminio y cintas con velcro de ajuste.

Caleiras de união impermeável. Proteja a esplanada da chuva, unindo dois guarda-sóis. Caleiras em PVC, varetas de alumínio e tira de velcro de ajustar.

Gutter of waterproof join. Protects your terrace from the rain by joining two parasols. PVC gutters, aluminium ribs and fastener velcro tape.

Gouttières d'union imperméables. Protège la terrasse de la pluie, en assemblant deux parasols. Gouttières en PVC, baleines en aluminium et bande en velcro pour ajuster.

400X400 Ref. IGAP00C40002	165,00 €
350X350 Ref. IGAP00C35002	165,00 €
300X300 Ref. IGAP00C30002	165,00 €

name	info	structure colour	fabric	€
VIGO GREY 3X2				

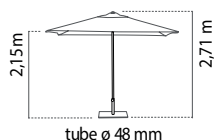

6 varillas/varetas
ribs/baleines (19X13mm)
1 u. caja/caixa/box/carton



ALUMINIUM
Base/Pied:
Cube / Fast Click / Fix / Round
Mould / Bond / Flat / Canto



grey

OLEFIN 190 GRS

SGAO10H3000020P

317,00 €

name	info	structure colour	fabric	€
VIGO GREY 3				



8 varillas/varetas
ribs/balaines (19X13 mm)
1 u. baleines/caixa/box/carton



ALUMINIUM
Base/Pied:
Cube / Fast Click / Fix / Round
Mould / Bond / Flat / Canto



grey

OLEFIN 190 GRS

SIAO10O3000820P

265,00 €

name	info	structure colour	fabric	€
JAVA 2X2				



8 varillas/varetas
ribs/baleines (17x22 mm)
1 u. caja/caixa/box/carton



WOOD
Base/Pied:
Cube / Round / Flat



wood

OLEFIN 190 GRS

SPMO10C2000220P

289,00 €



name	info	structure colour	fabric	€
JAVA 3X3				



8 varillas/varetas ribs/baleines (17x35 mm)
1 u. caja/caixa/box/carton



WOOD
Base/Pied:
Canto 70Ø



wood

OLEFIN 190 GRS

SGMO10C3000220P

675,00 €

JAVA 3				
---------------	--	--	--	--



8 varillas/varetas ribs/baleines (17x22 mm)
1 u. caja/caixa/box/carton



WOOD
Base/Pied:
Cube / Fix / Fast Click / Round
Bond / Flat / Canto



wood

OLEFIN 190 GRS

SIMO10C3000720P

345,00 €

MADEIRA 3				
------------------	--	--	--	--

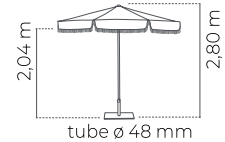

8 varillas/varetas ribs/baleines (17x22 mm)
1 u. caja/caixa/box/carton



WOOD
Base/Pied:
Cube / Fix / Fast Click / Round
Bond / Flat / Canto



wood

OLEFIN 190 GRS

SIMO10C3000750P

399,00 €



FARO INOX 2X2*				
-----------------------	--	--	--	--

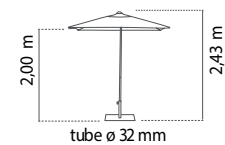

4 varillas/varetas ribs/baleines (12,5 mm)
1 u. caja/caixa/box/carton



INOX
Base/Pied:
Round / Flat
Fit t. Ø40



inox

OLEFIN 190 GRS

SPIO10C2000320P

199,00 €

* Hasta fin de existencias/Limitado ao stock existente/Up to end of stock/Jusqu'à fin de stocks.

name	info	structure colour	fabric	€
PALMA GREY 2,5				

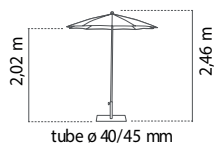

8 varillas/varetas
ribs/baleines (Ø8 mm) F.V.

1 u. caja/caixa/box/carton



grey

OLEFIN 190 GRS

SIAO10O2500000P

268,00 €

ALUMINIUM

Base/Pied:
Round / Mould / Flat

MENORCA 2,5				
--------------------	--	--	--	--

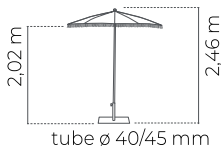

8 varillas/varetas
ribs/baleines (Ø8 mm) F.V.

1 u. caja/caixa/box/carton



grey

OLEFIN 190 GRS

SIAO10O2500006P

299,00 €

ALUMINIUM

Base/Pied:
Round / Mould / Flat

TENERIFE INOX 2				
------------------------	--	--	--	--

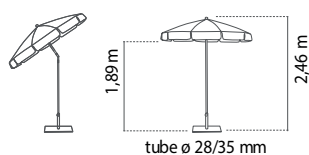

10 varillas/varetas
ribs/baleines (Ø6 mm) F.V.
4 u. caja/caixa/box/carton



inox

OLEFIN 190 GRS

SPIO10D2005310P

250,00 €

INOX

Base/Pied:
Round / Mould / Flat
Fit t. Ø40

ONS SAND 2				
-------------------	--	--	--	--

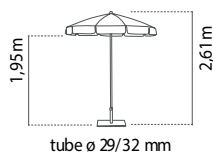

10 varillas/varetas
ribs/baleines (Ø6 mm) F.V.
1 u. caja/caixa/box/carton



sand

OLEFIN 190 GRS

SPA010D2000110T

131,00 €

ALUMINIUM

Base/Pied:
Round / Flat
Fit t. Ø40



name	info	structure colour	fabric colour	fabric	€
NEW TOSCANA SAND 2					

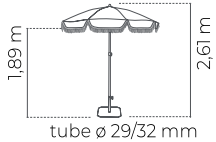
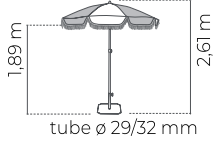

10 varillas/varetas
ribs/baleines (Ø6 mm) F.V.,
1 u. caja/caixa/box/carton
Base/Pied:
Round / Flat
Fit t. Ø40



structure colour	fabric colour	fabric	€
sand	olivo / sand	SPAO10D2000150T-O011010	175,00 €
sand	sky blue / sand	SPAO10D2000150T-O012010	
sand	sand / sand	SPAO10D2000150T-103010	

Olefin 190 grs

MANILA NATURAL 2



10 varillas/varetas
ribs/baleines (Ø6 mm) F.V.
4 u. caja/caixa/box/carton



brown

SPSZ02D2000001T

89,00 €

UPF50+

Base/Pied:
Round / Flat
Fit t. Ø40

**funda parasol
capa de guarda-sol
parasol cover
housses parasol**

- Funda parasol (poliéster 210 gr.)
- Capa de guarda-sol (poliéster 210 gr.)
- Parasol cover (polyester 210 gr.)
- Housses parasol (polyester 210 gr.)



400X400 Ref. 31P18C40000	91,00 €
FORMENTERA 350X350 FLEXO 300X300 Ref. 31P18C35000	91,00 €
FORMENTERA/VIGO/JAVA 300X300 Ref. 31P18C30000	91,00 €
EOLO / VIGO / JAVA Ref. 31P18C25000	75,00 €

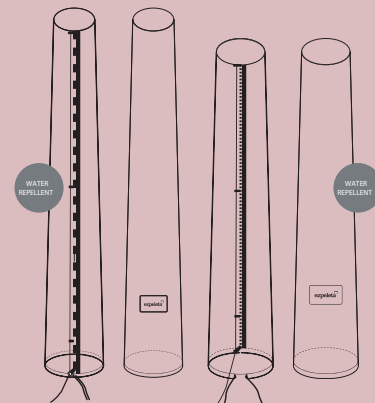



Olefin



SOLUTION DYED - COLOUR FASTNESS: 7-8/8 - 100% RECYCLABLE

Alta solidez de los colores a la radiación UV (7/8). Se trata de un tejido fabricado con hilo de polipropileno que ha sido tintado en masa, en su proceso inicial. Esto le otorga una gran resistencia a la luz solar ya que el color queda fijado en el hilo del tejido con mayor intensidad que en otros procesos. Dependiendo del color varía la durabilidad de la intensidad de los colores a la exposición solar.

Certificación UV standard 801 con la puntuación UPF 80, que garantiza la protección de la piel de los efectos nocivos de los rayos UV. Repelente al agua - resistente a las manchas - 100% reciclable.

Alta resistência das cores face à radiação UV. Ao ser um tecido fabricado com fio de polipropileno tingido em massa no seu processo inicial, esta característica confere-lhe uma maior resistência à luz solar o que se deve essencialmente ao facto de a cor permanecer fixa ao fio com maior intensidade do que em outros processos de pigmentação. A durabilidade da intensidade das cores, varia dependendo da cor e da exposição solar.

Certificação UV standard 801 com factor de proteção UPF 80, que garante a proteção da pele dos efeitos nocivos dos raios UV. Repelente à água - anti-manchas - 100% reciclável

High resistance of colours to UV radiation (7/8). The fabric is made from polypropylene fabric mass-dyed during the initial process. This provides high resistance to sunlight because the colour is set in the thread of the fabric more intensely than in other processes. Depending on the color, the durability of color intensity varies when exposed to sunlight.















UV standard 801 certification rating UPF 80, that guarantees skin protection against nocive effects of UV rays on the skin. Water repellent - stain resistance - 100% recyclable.

Haute résistance des couleurs face à la radiation solaire. Il s'agit ici d'une toile fabriquée à partir d'un fil en polypropylène qui a été teinté en masse, depuis son processus initial. Ceci lui confère une haute résistance à la lumière solaire, étant donné que la teinte reste fixée sur le fil avec une plus grande intensité en comparaison avec d'autres processus de pigmentation. Selon la couleur choisie, la durabilité de l'intensité de celle-ci varie en fonction de l'exposition au soleil.

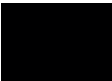
Certification UV standard 801 avec un facteur de protection UPF 80, qui garantie une protection de la peau face aux effets nocifs des rayons UV. Deperlante - resistant aux tâches - 100% recyclable.

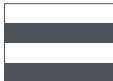
TEJIDO/ TECIDO/ FABRIC/ TOILE

Olefin 190 gr

 WHITE 112010	 SAND 103010	 NAVY 117010	 BLUE STRIPE 125010
 TAUPE 101010*	 ANTHRACITE 110010	 TAUPE STRIPE 115010	 GREEN STRIPE 124010
 BLACK 102010	 MOKA 109010	 ANTHRACITE STRIPE 116010	
 SKY BLUE 122010	 OLIVO 121010	 ICE 123010	

TEJIDO/ TECIDO/ FABRIC/ TOILE

Olefin 250 gr

 WHITE 212020	 SAND 203020	 ANTHRACITE 210020
 TAUPE 201020	 BLACK 202020	

Disponemos de tejido 100% poliéster tintado en masa sólo para pedidos con logotipo. / We can supply 100% polyester fabric, machine dyed only for orders with a logo. / Disponemos de um tecido 100% poliéster tingido em massa que apenas estará disponível para pedidos de personalização (serigrafia). / Nous avons à disposition un tissu 100% polyester teinté à la masse pour des commandes personnalisées (im pression).



sunbrella™



CONTRACT 2024

Tejido exclusivamente con fibras acrílicas teñidas en masa desde el núcleo del mismo hilo para garantizar su resistencia a la decoloración frente a los rayos UV. Acabado repelente al agua, resistente al moho y antimanchas que protege el tejido y hace que su mantenimiento sea muy sencillo.

Garantía de 5 años frente a la abrasión, la aparición de bolitas, la decoloración y la pérdida de tensión.

Cuenta con el sello de Recomendación de la Skin Cancer Foundation que garantiza la protección de la piel de los efectos nocivos de los rayos UV.

Tecido exclusivamente com fibras acrílicas tingidas em massa a partir do núcleo do próprio fio para garantir a sua resistência à descoloração contra os raios UV. O acabamento repelente à água, ao mofo e às manchas protege o tecido e facilita a sua manutenção.

5 anos de garantia contra abrasão, borboto, descoloração e perda de tensão.

Com o selo de Recomendação da Skin Cancer Foundation que garante a proteção da pele contra os efeitos nocivos dos raios UV.

The fabric is exclusively crafted from acrylic fibers, dyed thoroughly within the core of the yarn to ensure resistance against UV-induced fading. Its water-repellent, mold-resistant, and stain-repellent finish safeguards the fabric, simplifying maintenance.

It is backed by a 5-year warranty against abrasion, pilling, fading, and tension loss.

Endorsed by the Skin Cancer Foundation seal, guaranteeing protection against the harmful effects of UV rays on the skin.

Tissu exclusivement en fibres acryliques teinté à la masse depuis son processus initial, afin de garantir une haute résistance à la décoloration due aux rayons UV. Toile déperlante, résistante aux moisissures, anti-tâches qui facilite ainsi son entretien.

Toile garantie 5 ans, contre l'abrasion, les bouloches, decolation et pertes de tension.

Certifiée est recommandée par la Skin Cancer Fondation qui garantit la protection de la peau aux effets nocifs des rayons UV.

TEJIDO/ TECIDO/ FABRIC/ TOILE

Sunbrella



Dralon



Tejido tintado en floca, solidez 5-6 sobre 8. En zonas de alta radiación y sobreexposición solar los colores oscuros pierden intensidad antes de los 6 meses, para estas zonas recomendamos colores claros como el blanco o el crudo.

Tecido tingido em bando, solidez de 5-6 em 8. Em áreas de alta radiação e sobre exposição ao sol, as cores escuras perdem intensidade antes dos 6 meses, para essas áreas recomendamos cores claras como branco ou cru.

Fabric dyed in the fiber, color fastness rating 5-6 out of 8. In zones with excessive sunlight exposure, dark colors may lose intensity within less than 6 months. For such areas, we recommend light colors such as white or beige.

Tissu teint avec flochage, solidité 5-6 sur 8. Dans les zones de fort rayonnement et de surexposition solaire, les couleurs sombres perdent de leur intensité après 6 mois d'utilisation. Pour ces zones nous recommandons des couleurs claires, comme l'écrú ou le blanc.

Telajes / Panos / Fabrics / Tissus

Parasol	Size	Ref.	€
EOLO SUNBRELLA	300x300	96AD24C300017	460,00 €
EOLO PURETI	300x300	96AO10C300P2	265,00 €
EOLO	300x300	96AO10C300012	265,00 €
EOLO	300x300	96AO10C300014	265,00 €
EOLO SUNBRELLA	250x250	96AD24C250017	412,00 €
EOLO PURETI	250x250	96AO10C250P2	190,00 €
EOLO	250x250	96AO10C250012	190,00 €
EOLO	250x250	96AO10C250014	190,00 €
EOLO SUNBRELLA	200x200	96AD24C200017	320,00 €
EOLO PURETI	200x200	96AO10C200P2	165,00 €
EOLO	200x200	96AO10C200012	165,00 €
EOLO	200x200	96AO10C200014	165,00 €
FARO	200x200	96AO10C2000120	133,00 €
FLEXO	300x300	96AO10C300502	310,00 €

Parasol	Size	Ref.	€
FORMENTERA	350x350	96AO10C350012	428,00 €
FORMENTERA	350x350	96AO10C350014	428,00 €
FORMENTERA/JAVA	300x300	96AMO10C30002	265,00 €
FORMENTERA	300x300	96AMO10C30004	265,00 €
JAVA	200x200	96MO10C200002	133,00 €
JAVA	Ø300	96MO10O30002	168,00 €
MADEIRA	Ø300	96MO10O30005	245,00 €
PALMA	Ø250	96AO10O25000	110,00 €
RIO	400x400	96AO20C40002	667,00 €
RIO	400x400	96AO20C40004	667,00 €
TENERIFE	Ø200	96AIO10D20001	154,00 €
ONS	Ø200	96AIO10D20001	154,00 €
VIGO	300x200	96AO10H30002	179,00 €
VIGO	Ø300	96AO10O30002	168,00 €

Telajes / Panos / Fabrics / Tissus

Waterproof

Parasol	Size	Ref.	€
RIO	400x400	96AP11C4004	818,00 €
FORMENTERA	350x350	96AP11C35004	524,00 €
FORMENTERA	300x300	96AP11C3004	403,00 €

confecciones



Con volante con fugavientos
Com bambinela com fugaventos
With valance with airvent
Avec volants soufflet



Sin volante con fugavientos
Sem bambinela com fugaventos
Without valance with airvent
Sans volant avec soufflet



Con volante sin fugavientos
Com bambinela sem fugaventos
With valance without airvent
Avec volants sans soufflet



Sin volante sin fugavientos
Sem bambinela sem fugaventos
Without valance without airvent
Sans volant sans soufflet



Con volante sin fugavientos con flecos
Com bambinela sem fugaventos com franjas
With valance without airvent with fringes
Avec volants sans soufflet et avec des franges



Sin volante sin fugavientos con flecos
Sem bambinela sem fugaventos com franjas
Without valance without airvent with fringes
Sans volant sans soufflet avec des franges

name	info	colour	base pole	kg.	parasol	€
------	------	--------	-----------	-----	---------	---

Peso de cemento/polipropileno / Peso de cimento/polipropileno
Concrete/polypropylene weight / Dalle en ciment

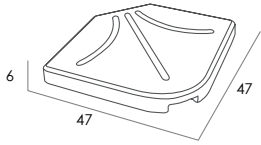

SLAB	BEC047BC03	White		100 kg (4 u.)	Flexo W.	52,00 €/u. 208,00 € X4
	BEC047TP00	Taupe	NEW	100 kg (4 u.)	Flexo T.	
	BEC047NG02	Anthracite		100 kg (4 u.)	Flexo A.	

Base Flexo con ruedas + piedras / Base Flexo com rodas + pedras
Flexo base with wheels + stones / Pied Flexo avec roues + dalles

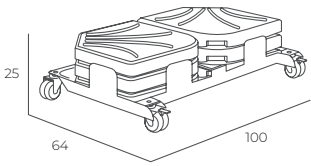

KIT FLEXO	BSH990BCK	White		165 Kg.	Flexo W.	702,00 €
	BSH990TPK	Taupe		165 Kg.	Flexo T.	
	BSH990ANK	Anthracite		165 Kg.	Flexo A.	

Base con ruedas + piedras / Base com rodas + pedras / Wheels base + stones / Pied de parasol roues + dalles

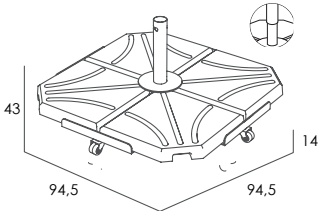

KIT CROSS RIO	BSRDBC6350K	White		100 + 10 kg	Rio	558,00 €/u.
	BSRDAN6350K	Anthracite		100 +10 kg	Rio	

KIT CROSS	BSRDBC6000K	White	Ø 57 mm	100 + 10 kg	Formentera W.	558,00 €/u.
	BSRDAN6000K	Anthracite	Ø 57 mm	100 + 10 kg	Formentera A.	

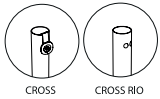

Base cemento. Ruedas / Base cimento. Rodas / Concrete base. Wheels / Pied de parasol en ciment. Roues

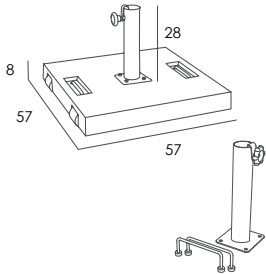

CUBE	BEC570BC00	White	Ø 57 mm	50 kg	Eolo, Formentera, Vigo, Java 2x2, Java 3, Madeira	199,00 €/u.
	BEC570GR00	Grey	Ø 57 mm	50 kg		
KIT 2 ASAS + TUBO INOX					52CUBEK	199,00 €

Base hierro / Base ferro / Iron base / Pied de parasol en fer

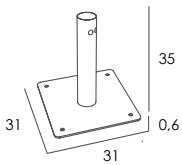

FIX RIO	BSC310BC63501	White		10 kg	Rio	142,00 €/u.
	BSC310AN63500	Anthracite		10 kg	Rio	

Base hierro / Base ferro / Iron base / Pied de parasol en fer

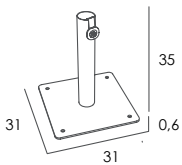

FIX	BSC310GR6000	Grey	Ø 60 mm	10 kg.	Eolo, Formentera, Vigo, Java 3, Madeira	142,00 €/u.
	BSC310BC6000	White	Ø 60 mm	10 kg.		
	BSC310AN6000	Anthracite	Ø 60 mm	10 kg.		
	BSC310TP6000	Taupe	Ø 60 mm	10 kg.		

Base fast-click de empotrar / Base fast-click de encastrar
Fast-click base to fix / Pied de parasol fast-click pour encastrer

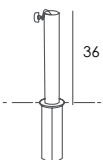

FAST_CLICK RIO	BIFC63500	INOX			Rio	257,00 €
FAST_CLICK	BIFC6000	INOX	Ø 60 mm		Formentera	257,00 €
	BIFC5500	INOX	Ø 55 mm		Eolo, Vigo, Java 3, Madeira	

name	info	colour	base pole	kg.	parasol	€	
Base cemento / Base cemento / Concrete base / Pied de Parasol en ciment							
	ROUND*	BER048TP01	Taupe	Ø 48 mm	25 Kg.	Eolo, Vigo, Java 2x2, Java 3, Madeira, Faro, Palma, Menorca, Tenerife, Ons, New Toscana, Manila	75,00 €
	Base cemento/polipropileno. Ruedas / Base cemento/polipropileno. Rodas Concrete/polypropylene base. Wheels/ Pied en ciment/polypropylène. Roues						
	MOULD*	BER055GR00	Grey	Ø 55 mm	38 kg	Eolo, Vigo, Palma, Menorca, Tenerife	169,00 €
	Base de cemento con carcasa de polipropileno / Base de cemento com revestimento em polipropileno. Cement base with polypropylene casing / Base en ciment revêtit de polypropylène.						
	BOND	BPC523GR6000	Grey	Ø 60 mm	35 Kg.	Eolo, Vigo, Formentera 3x3, Java 3, Madeira	89,00 €
		BPC523BC6000	White	Ø 60 mm	35 Kg.		
		BPC523TP6000	Taupe	Ø 60 mm	35 Kg.		
		BPC523AN6000	Anthracite	Ø 60 mm	35 Kg.		
Base hierro / Base ferro / Iron base / Pied de parasol en fer							
	FLAT	BSC625OX60000	Rust	Ø 60 mm	18 kg.	Java 3, Madeira	89,00 €
		BSC625OX4500	Rust	Ø 45 mm	18 kg.	Java 2X2	
		BSC625GR40030	Grey	Ø 40 mm	18 kg.	Faro, Tenerife, Ons, Palma, Menorca, New Toscana, Manila	
		BSC625GR6000	Grey	Ø 60 mm	18 kg.	Vigo	
		BSC625BC6000	White	Ø 60 mm	18 kg.	Eolo, Formentera 3x3	
		BSC625AN6000	Anthracite	Ø 60 mm	18 kg.	Eolo, Formentera 3x3	
	BSC625TP6000	Taupe	Ø 60 mm	18 kg.	Eolo		
Base hierro / Base ferro / Iron base / Pied de parasol en fer							
	CANTO	BSC625BC6010	White	Ø 60 mm	35 kg.	Eolo, Formentera	175,00 €
		BSC625GR6010	Grey	Ø 60 mm	35 kg.	Vigo	
		BSC625AN6010	Anthracite	Ø 60 mm	35 kg.	Eolo, Formentera	
		BSC625TP6010	Taupe	Ø 60 mm	35 kg.	Eolo, Java 3	
		BSC625OX6010	Rust	Ø 60 mm	35 kg.	Java 3, Madeira	
		BSC625OX7010	Rust	Ø 70 mm	35 kg.	Java 3x3	
CANTO	Rueda con freno/ Roda com freio Wheel with brake/ Roue avec frein		MO-SIE41K (kit 4 U.)		108,00 €		
Base hierro/ Base ferro/ Iron base/ Pied de parasol en fer							
	FIT	BSO500BC4002	White	Ø 40 mm	12 kg.	Ons, New Toscana	70,00 €
		BSO500OX4000	Rust	Ø 40 mm	12 kg.	Manila	
		BSO500GR4003	Grey	Ø 40 mm	12 kg.	Faro	
		BSO500GR4503	Grey	Ø 45 mm	12 kg.	Tenerife	

datos logísticos
dados logísticos
logistic data
données logistiques

name	ref.	kg/u.	CBM m/u.	pallet	truck	20" container	40" container
SILLONES/ CADEIRAS/ ARMCHAIRS/ FAUTEUILS							
TRENA ARMCHAIR	MN-TRE00	4,73 Kg.	0,07	32 u. / 120 x 100 x 200 cm	832 u.	320 u.	704 u.
TRENA CHAIR	MS-TRE00	4,30 Kg.	0,06	40 u. / 120 x 100 x 200 cm	1040 u.	400 u.	880 u.
TRENA STOOL	MT-TRE00	4,39 Kg.	0,06	40 u. / 120 x 100 x 200 cm	1040 u.	400 u.	880 u.
NOON ARMCHAIR	MN-NON00	4,39 Kg.	0,06	40 u. / 120 x 100 x 200 cm	1040 u.	400 u.	880 u.
BAKE WOOD	MN-BAK20	4,40 Kg.	0,06	40 u. / 120 x 100 x 200 cm	1040 u.	400 u.	880 u.
BAKE WOOD PAD	MN-BAK2	5,00 Kg.	0,08	30 u. / 120 x 100 x 200 cm	780 u.	300 u.	660 u.
BAKE	MS-BAK	4,40 Kg.	0,06	40 u. / 120 x 100 x 200 cm	1040 u.	400 u.	840 u.
BAKE PAD	MS-BAK1	5,00 Kg.	0,08	30 u. / 120 x 100 x 200 cm	780 u.	300 u.	630 u.
HOP	MN-HOP00	4,50 Kg.	0,07	50 u. / 120 x 100 x 236 cm	1300 u.	500 u.	1050 u.
ROD	MN-ROD	5,20 Kg.	0,07	40 u. / 120 x 100 x 220 cm	1040 u.	400 u.	840 u.
ROD PAD	MN-ROD1	5,60 Kg.	0,07	30 u. / 120 x 100 x 200 cm	780 u.	300 u.	630 u.
FADO	MN-FAD00	4,80 Kg.	0,06	50 u. / 120 x 100 x 236 cm	1300 u.	500 u.	1050 u.
ATTIC	MT-ATT00	4,80 Kg.	0,07	40 u. / 120 x 100 x 220 cm	1040 u.	400 u.	840 u.
TOWN ARMCHAIR	MN-TOW00	4,70 Kg.	0,06	50 u. / 120 x 100 x 236 cm	1300 u.	500 u.	1050 u.
TOWN CHAIR	MS-TOW00	4,10 Kg.	0,06	50 u. / 120 x 100 x 236 cm	1300 u.	500 u.	1050 u.
TOWN ARMCHAIR PAD	MN-TOW10	5,70 Kg.	0,06	30 u. / 120 x 100 x 200 cm	780 u.	300 u.	630 u.
TOWN CHAIR PAD	MS-TOW10	5,10 Kg.	0,06	30 u. / 120 x 100 x 200 cm	780 u.	300 u.	630 u.
PARK ARMCHAIR	MN-PAR00	5,10 Kg.	0,06	50 u. / 120 x 100 x 236 cm	1300 u.	500 u.	1050 u.
PARK CHAIR	MS-PAR00	4,50 Kg.	0,06	50 u. / 120 x 100 x 236 cm	1300 u.	500 u.	1050 u.
DOCK	MN-DOC00	3,90 Kg.	0,04	50 u. / 120 x 100 x 236 cm	1300 u.	500 u.	1050 u.
LAND	MN-LAN00	3,50 Kg.	0,08	40 u. / 120 x 100 x 210 cm	1040 u.	400 u.	840 u.
MONACO	MN-MON01	3,70Kg.	0,07	40 u. / 120 x 100 x 210 cm	1040 u.	400 u.	840 u.
SICILIA	MN-SIC00	4,30 Kg.	0,07	40 u. / 120 x 100 x 230 cm	1040 u.	400 u.	840 u.



name	kg/u.	CBM m/u.	pallet	truck	20" container	40" container
MESAS / TABLES						
MONTADA/ASSEMBLED						
MEET 70X70	13,00 Kg.	0,17	20 u. / 120 x 100 x 220 cm	520 u.	180 u.	440 u.
MEET 80X80	14,00 Kg.	0,18	20 u. / 120 x 100 x 220 cm	520 u.	180 u.	440 u.
KIT (DESMONTADA/DISASSEMBLED)						
MEET 90X90	15,00 Kg.	0,19	18 u. / 120 x 100 x 210 cm	468 u.	162 u.	396 u.
MEET 120X80	15,50 Kg	0,21	18 u. / 120 x 100 x 210 cm	468 u.	162 u.	396 u.
MEET 160X90	19,00 Kg	0,25	18 u. / 165 x 116 x 210 cm	288 u.	108 u.	252 u.
MEET 200X90	24,50 Kg	0,30	16 u. / 205 x 116 x 210 cm	195 u.	75 u.	180 u.
MONTADA/ASSEMBLED						
MONACO 70X70	10,80 Kg.	0,17	15 u. / 120 x 105 x 210 cm	360 u.	135 u.	315 u.
MONACO 80X80	11,30 Kg.	0,18	15 u. / 120 x 105 x 210 cm	360 u.	135 u.	315 u.
KIT (DESMONTADA/DISASSEMBLED)						
MONACO 120X80	14,20 Kg.	0,21	18 u. / 120 x 100 x 220 cm	468 u.	162 u.	396 u.
MONTADA/ASSEMBLED						
ONE 70X70	13,10 Kg.	0,18	15 u.. / 120 x 100 x 190 cm	390 u.	135 u.	350 u.
BOX (DESMONTADA/DISASSEMBLED -EXPORT/ISLAS)						
ONE 70X70	13,10 Kg.	0,18	25 u.. / 120 x 85 x 200 cm	825 u.	275 u.	625 u.
BOX (DESMONTADA/DISASSEMBLED)						
URBAN 70X70	15,00 Kg.	0,16	13 u. / 120 x 80 x 220 cm	429 u.	143 u.	325 u.
URBAN 104X55	14,10 Kg.	0,16	13 u. / 120 x 80 x 220 cm	429 u.	143 u.	325 u.
URBAN 120X60	15,20 Kg.	0,21	18 u. / 128 x 125 x 220 cm	468 u.	162 u.	396 u.
MONTADA/ASSEMBLED						
RODAS 70X70	11,50 Kg.	0,11	25 u. / 120 x 100 x 236 cm	650 u.	225 u.	550 u.
BOX (DESMONTADA/DISASSEMBLED - EXPORT/ISLAS)						
QUATRO FOLD 60X60	8,50 Kg.	0,08	10 u. / 120 x 80 x 200 cm	380 u.	110 u.	250 u.
QUATRO FOLD 70X70	10,30 Kg.	0,13	10 u. / 120 x 80 x 200 cm	380 u.	110 u.	250 u.
QUATRO FOLD Ø60	7,30 Kg.	0,08	10 u. / 120 x 80 x 200 cm	380 u.	110 u.	250 u.
QUATRO FOLD Ø70	8,80 Kg.	0,13	10 u. / 120 x 80 x 200 cm	380 u.	110 u.	250 u.
QUATRO FIX 60X60	8,50 Kg.	0,08	10 u. / 120 x 80 x 200 cm	380 u.	110 u.	250 u.
QUATRO FIX 70X70	10,30 Kg.	0,13	10 u. / 120 x 80 x 200 cm	380 u.	110 u.	250 u.
QUATRO FIX 80X80	12,30 Kg.	0,10	10 u. / 120 x 85 x 200 cm	320 u.	100 u.	240 u.



name	kg/u.	CBM m/u.	pallet	truck	20" container	40" container
MESAS / TABLES						
BOX (DESMONTADA/DISASSEMBLED - EXPORT/ISLAS)						
QUATRO HIGH FIX 60X60	9,70 Kg.	0,10	10 u. / 120 x 85 x 200 cm	320 u.	100 u.	240 u.
QUATRO HIGH FIX 70X70	10,80 Kg.	0,10	10 u. / 120 x 85 x 200 cm	320 u.	100 u.	240 u.
QUATRO HIGH FIX Ø60	8,90 Kg.	0,10	10 u. / 120 x 85 x 200 cm	320 u.	100 u.	240 u.
QUATRO HIGH FIX Ø70	9,60 Kg.	0,10	10 u. / 120 x 85 x 200 cm	320 u.	100 u.	240 u.
QUATRO DUO FIX 120X80	17,90 Kg.	0,19	10 u. / 125 x 85 x 210 cm	260 u.	100 u.	230 u.
KIT (DESMONTADA/DISASSEMBLED)						
QUATRO FOLD 60X60	8,50 Kg.	0,08	16 u. / 120 x 100 x 200 cm	416 u.	144 u.	352 u.
QUATRO FOLD 70X70	10,30 Kg.	0,13	16 u. / 120 x 100 x 200 cm	416 u.	144 u.	352 u.
QUATRO FOLD Ø60	7,30 Kg.	0,08	16 u. / 120 x 100 x 200 cm	416 u.	144 u.	352 u.
QUATRO FOLD Ø70	8,80 Kg.	0,13	16 u. / 120 x 100 x 200 cm	416 u.	144 u.	352 u.
QUATRO FIX 60X60	8,50 Kg.	0,08	16 u. / 120 x 100 x 200 cm	416 u.	144 u.	352 u.
QUATRO FIX 70X70	10,30 Kg.	0,13	16 u. / 120 x 100 x 200 cm	416 u.	144 u.	352 u.
QUATRO FIX 80X80	12,30 Kg.	0,10	16 u. / 120 x 100 x 200 cm	416 u.	144 u.	352 u.
QUATRO HIGH FIX 60X60	9,70 Kg.	0,10	16 u. / 120 x 100 x 200 cm	416 u.	144 u.	352 u.
QUATRO HIGH FIX 70X70	10,80 Kg.	0,10	16 u. / 120 x 100 x 200 cm	416 u.	144 u.	352 u.
QUATRO HIGH FIX Ø60	8,90 Kg.	0,10	16 u. / 120 x 100 x 200 cm	416 u.	144 u.	352 u.
QUATRO HIGH FIX Ø70	9,60 Kg.	0,10	16 u. / 120 x 100 x 200 cm	416 u.	144 u.	352 u.
QUATRO DUO FIX 120X80	17,90 Kg.	0,19	10 u. / 125 x 85 x 210 cm	260 u.	100 u.	230 u.
BOX (DESMONTADA/DISASSEMBLED - EXPORT/ISLAS))						
KOS 60X60	8,60 Kg.	0,17	10 u. / 120 x 80 x 210 cm	330 u.	110 u.	250 u.
KOS 70X70	10,40 Kg.	0,17	10 u. / 120 x 80 x 210 cm	330 u.	110 u.	250 u.
KOS Ø60	7,60 Kg.	0,17	10 u. / 120 x 80 x 210 cm	330 u.	110 u.	250 u.
KOS Ø70	9,00 Kg.	0,17	10 u. / 120 x 80 x 210 cm	330 u.	110 u.	250 u.
KIT (DESMONTADA/DISASSEMBLED)						
KOS 60X60	8,60 Kg.	0,17	15 u. / 120 x 100 x 210 cm	390 u.	135 u.	330 u.
KOS 70X70	10,40 Kg.	0,17	15 u. / 120 x 100 x 210 cm	390 u.	135 u.	330 u.
KOS Ø60	7,60 Kg.	0,17	15 u. / 120 x 100 x 210 cm	390 u.	135 u.	330 u.
KOS Ø70	9,00 Kg.	0,17	15 u. / 120 x 100 x 210 cm	390 u.	135 u.	330 u.

name		kg/u.	CBM m/u.	pallet	truck	box	40" container
LOUNGE							
LAGO MU-LAG00		12,50 Kg.	0,18	20 u. / 212 x 80 x 200 cm	380 u.	212,8 x 56,8 x 80 cm (2 uds)	320 u.
VILA MU-VIL00		11,40 Kg.	0,18	20 u. / 212 x 75 x 220 cm	380 u.	212,8 x 40 x 75,1 cm (2 uds)	320 u.
VILA ARMS MU-VIL01		13,90 Kg.	0,20	20 u. / 212 x 75 x 230 cm	380 u.	212,8 x 56,8 x 80 cm (2 uds)	320 u.
VILA TABLE MAK-VLACO450		4,30 Kg.	0,10	60 u. / 120 x 100 x 220 cm	1560 u.	48 x 45 x 13 cm (2 uds)	1320 u.
COJINES / ALMOFADAS / CUSHIONS / COUSSINS							
681 AQUA		3,5 Kg.	0,09	24 u. / 120 x 80 x 206 cm	792 u.	114 x 48,5 x 64,5 cm	600 u.
681 NAUTIC		3,90 Kg.	0,07	24 u. / 120 x 80 x 206 cm	792 u.	114 x 48,5 x 64,5 cm	600 u.
NANA		65 Kg.	0,47	2 u. / 214 x 90 x 170 cm	30 u.	210 x 151 x 42 cm	26 u.
IBIZA XL		96 Kg.	1,55	2 u. / 214 x 75 x 220 cm	38 u.	226 x 200 x 35 cm	32 u.
MARINE INDIVIDUAL		11,5 Kg.	0,4 0,3	6 u. / 120 x 100 x 207 cm 8 u. / 120 x 100 x 220 cm	84 u.	120 x 50,3 x 46,5 cm 100 x 49 x 49 cm	80 u.
MARINE ESQUINERO		9,35 Kg.	0,3 0,2	6 u. / 120 x 100 x 207 cm 12 u. / 120 x 100 x 195 cm	96 u.	114 x 48,5 x 64,5 cm 113 x 48,5 x 62,3 cm	96 u.
MARINE INTERMEDIO		8,08 Kg.	0,3 0,2	6 u. / 120 x 100 x 207 cm 12 u. / 125 x 80 x 205 cm	114 u.	114 x 48,5 x 64,5 cm 77 x 62 x 90,8 cm	96 u.
POUF MARINE		7,65 Kg.	0,2 0,1	10 u. / 120 x 100 x 190 cm 16 u. / 125 x 80 x 205 cm	160 u.	114 x 48,5 x 64,5 cm 77 x 62 x 90,8 cm	130 u.
SIENA SYSTEM							
MONTADA/ASSEMBLED							
MO-MSIE05		32 Kg.	0,38	4 u. / 160 x 120 x 200 cm	64 u.	153 x 43 x 188 cm	40 u.
MO-VO10SIE05		31 Kg.	0,26	4 u. / 160 x 120 x 200 cm	64 u.	153 x 43 x 188 cm	40 u.
MO-MSIE06		19 Kg.	0,38	4 u. / 160 x 120 x 160 cm	64 u.	153 x 43 x 188 cm	40 u.
MO-VO10SIE06		18 Kg.	0,26	4 u. / 160 x 120 x 160 cm	64 u.	153 x 43 x 188 cm	40 u.
MO-MSIE03		15 Kg.	0,38	20 u. / 212 x 75 x 200 cm	320 u.	122 x 45 x 161 cm	236 u.
MO-VO10SIE03		12 Kg.	0,26	20 u. / 212 x 75 x 200 cm	320 u.	122 x 45 x 161 cm	236 u.
MO-MSIE04		15 Kg.	0,38	40 u. / 212 x 75 x 200 cm	640 u.	122 x 45 x 161 cm	472 u.
MO-VO10SIE04		12 Kg.	0,26	40 u. / 212 x 75 x 200 cm	640 u.	122 x 45 x 161 cm	472 u.
PARASOLES / GUARDA-SÓIS / PARASOLS							
EOLO	300X300	8,20 Kg.	0,04	40 u. / 120 x 80 x 245 cm	1320 u.	227 x 14 x 14 cm	1000 u.
EOLO	250x250	6,00 Kg.	0,04	40 u. / 120 x 80 x 245 cm	1320 u.	227 x 14 x 14 cm	1000 u.
EOLO	200X200	5,30 Kg.	0,04	40 u. / 120 x 80 x 187 cm	1320 u.	173 x 14 x 14 cm	1000 u.

name		kg/u.	CBM m/u.	pallet	truck	box	40" container
PARASOLES / GUARDA-SÓIS / PARASOLS							
FLEXO	300x300	33,00 Kg.	0,20	20 u. / 258 x 116 x 160 cm	200 u.	258 x 45 x 18 cm	160 u.
RIO	400x400	36,00 Kg.	0,30	-	120 u.	380 x 28 x 28 cm	120 u.
FORMENTERA	300x300	15,00 Kg.	0,15	25 u. / 291 x 116 x 130 cm	200 u.	291 x 22,5 x 22,5 cm	200 u.
FORMENTERA	350x350	18,00 Kg.	0,15	25 u. / 291 x 116 x 130 cm	200 u.	291 x 22,5 x 22,5 cm	200 u.
VIGO 3x2	300x200	10,00 Kg.	0,05	24 u. / 120 x 80 x 203 cm	792 u.	189 x 17 x 17 cm	600 u.
VIGO 3	ø 300	10,00 Kg.	0,05	24 u. / 120 x 80 x 174 cm	792 u.	160 x 17,5 x 17,5 cm	600 u.
JAVA 2X2	200x200	6,50 Kg.	0,04	24 u. / 120 x 80 x 177 cm	792 u.	162 x 15 x 15 cm	600 u.
JAVA 3X3	300x300	21,00 Kg.	0,15	25 u. / 291 x 116 x 160 cm	200 u.	291 x 22,5 x 22,5 cm	200 u.
JAVA 3	ø 300	10,00 Kg.	0,05	24 u. / 120 x 80 x 176 cm	792 u.	162 x 17,5 x 17,5 cm	600 u.
MADEIRA 3	ø 300	10,00 Kg.	0,05	24 u. / 120 x 80 x 176 cm	792 u.	162 x 17,5 x 17,5 cm	600 u.
FARO	200x200	3,60 Kg.	0,03	40 u. / 120 x 80 x 181 cm	1320 u.	167 x 13,5 x 13,5 cm	1000 u.
PALMA	ø 250	4,55 Kg.	0,03	40 u. / 120 x 80 x 184 cm	1320 u.	169 x 14 x 14 cm	1000 u.
TENERIFE	ø 200	1 u. 6,00 Kg. 4 u. 24,00 Kg.	0,05	96 u. / 149 x 100 x 139 cm	1728 u.	149 x 16 x 20 cm	1536 u.
ONS	ø 200	4,55 Kg.	0,04	40 u. / 120 x 80 x 183 cm	1320 u.	168 x 16 x 16 cm	1000 u.
TOSCANA	ø 200	3,00 Kg.	0,04	40 u. / 120 x 80 x 185 cm	1320 u.	175 x 14,5 x 14,5 cm	1000 u.
MANILA	ø 200	3,75 Kg.	0,09	48 u. / 120 x 80 x 160 cm	1584 u.	136 x 30 x 22 cm	1200 u.
MENORCA	ø 250	4,55 Kg.	0,03	40 u. / 120 x 80 x 184 cm	1320 u.	169 x 14 x 14 cm	1000 u.

BASES / PIEDS

SLAB	25 Kg. (1 u.)	0,015	40 u. / 120 x 105 x 88 cm	960 u.	50 x 50 x 6 cm	800 u.
KIT CROSS	110 Kg.	0,14 0,015	8 u. / 120 x 100 x 105 cm 40 u. / 120 x 105 x 88 cm	100 u.	80 x 80 x 23 cm 50 X 50 X 6 cm	80 u.
KIT FLEXO	172 Kg.	0,15 0,015	10 u. / 120 x 100 x 145 cm 40 u. / 120 x 105 x 88 cm	112 u.	100 x 67 x 23 cm 50 x 50 x 6 cm	96 u.
CUBE	50 Kg.	0,035	20 u. / 125 x 80 x 105 cm	480 u.	72 x 62 x 8 cm	480 u.
FIX	10 Kg.	0,035	45 u. / 120 x 100 x 175 cm	1170 u.	32 x 32 x 37,2 cm	945 u.
FAST CLICK	10 Kg.	0,012	80 u. / 120 x 80 x 155 cm	2640 u.	14 x 14 x 65 cm	2000 u.
ROUND	25 Kg.	0,032	40 u. / 114 x 114 x 125 cm	880 u.	60 x 54 x 10 cm	800 u.
MOULD	38 Kg.	0,051	16 u. / 120 x 80 x 125 cm	512 u.	70 x 61 x 12 cm	384 u.
BOND	35 Kg.	0,025	20 u. / 120 x 80 x 93 cm	660 u.	64 x 55 x 10 cm	480 u.
FLAT	18 Kg.	0,025	40 u. / 125 x 80 x 145 cm	1240 u.	62,7 x 62,7 x 6,5 cm	960 u.
CANTO	35 Kg.	0,025	20 u. / 125 x 80 x 130 cm	620 u.	62,7 x 62,7 x 6,5 cm	480 u.
FIT	12 Kg.	0,017	60 u. / 120 x 80 x 157 cm	1980 u.	51,8 x 51,5 x 6,5 cm	1440 u.



condiciones generales (es)

condições gerais (pt)

general conditions (en)

conditions générales (fr)

CONDICIONES GENERALES (ES)

Esta tarifa de precios y condiciones generales de venta sustituyen a todas las anteriores y serán aplicadas a partir de Enero de 2024.

PORTES:

Península (ES/PT)

- Para pedidos superiores a 1000 euros, portes pagados.
- Para pedidos entre 600 euros e inferiores 1000 euros, 70 euros de portes.
- Para pedidos inferiores a 600 euros, 100 euros de portes.

Islas (Canarias/Islands Baleares/Andorra)

- Para pedidos superiores a 1500 euros, portes pagados
- Consultar precio para pedidos de importe inferior a 1500 euros

Repuestos (ES/PT) ,Península – 30€ / Islas Consultar

Para Export consultar precio

Los precios incluidos en esta tarifa NO incluyen el I.V.A. o cualquier otro tipo de impuesto, que sería añadido a los mismos de acuerdo a la legislación vigente y al país al que se facturen los productos. Consultar descuentos.

Ezepeleta se reserva el derecho de revisar la tarifa en cualquier momento en caso de fluctuaciones en los costes de las materias primas, laborales u otros factores.

PEDIDOS:

Todos los pedidos deben tramitarse por escrito acorde a la nomenclatura para cada producto en la tarifa de precios y deben estar firmado o sellado por el comprador y verificado por el responsable comercial, dando así su conformidad al pedido

La venta se considerará confirmada únicamente con la aceptación por escrito del pedido por parte del comprador. Cualquier pedido verbal, incluso telefónico, sólo será efectivo si es confirmado por escrito a Ezepeleta. Ezepeleta podrá discrecionalmente rechazar los pedidos del Comprador en el caso de incumplimiento de esta condición. En caso de aceptación de un pedido por parte de Ezepeleta con indicación de pago anticipado de una parte o de la totalidad del importe del pedido, el contrato se considerará celebrado y la producción no comenzará hasta la recepción del pago solicitado.

Los pedidos denominados “especiales”, esto es, pedidos que no son producto de catálogo y su fabricación se realiza de un modo no estandarizado, tendrán que abonar el 50% del importe en el momento de la confirmación para que Ezepeleta inicie la producción.

VARIACIONES EN EL ASPECTO DE LOS PRODUCTOS:

Los productos mostrados en este documento podrán eventualmente sufrir pequeñas variaciones en su aspecto o acabados, producidas cuando existan por el ánimo de Ezepeleta de mejorar de forma constante los mismos. En la medida de lo posible, Ezepeleta intentará tanto que dichas variaciones sean poco significativas como que se informe al cliente acerca de la existencia de las mismas antes de los pedidos o en la confirmación de éstos. Ezepeleta no aceptará sin embargo reclamaciones por este concepto.

NUEVOS PRODUCTOS DISPONIBLES:

Nuestro personal comercial está permanentemente informado de nuevas incorporaciones a nuestra gama de productos. Rogamos por tanto les consulten en todos aquellos casos en los que no encuentren el producto que buscan en este catálogo.

IMÁGENES, LOGOTIPO E INFORMACIÓN GRÁFICA:

Todas las imágenes realizadas por Ezepeleta, incluido su logotipo e información gráfica son propiedad de Ezepeleta y no pueden ser utilizadas, reproducidas, modificadas o publicadas on-line sin el previo consentimiento por escrito por parte de Ezepeleta. Los clientes que obtengan dicha autorización deben mantener los nombres de los productos como indica Ezepeleta en sus catálogos y publicarlos bajo la marca Ezepeleta.

RECLAMACIONES Y DEVOLUCIONES:

- 1.- Las **incidencias en el transporte** cuando se perciban eventuales degradaciones en los productos o los bultos a la recepción de la mercancía, deberán hacerse constar en el albarán del transportista o CMR y notificarlo a Ezepeleta antes de transcurridas **48 horas laborables desde la recepción**. En caso de que no se cumpla ninguno de estos requisitos, no se aceptará la reclamación.
- 2.- Las reclamaciones de la mercancía por **NO conformidad** con la entrega deberán realizarse antes de transcurridos 8 días hábiles desde la fecha de recepción.
- 3.- Cuando ocurran **reclamaciones ajenas al transporte** que den lugar a devolución de mercancía, una vez recibidos en Ezepeleta los productos objeto de reclamación, y en el caso de que dicha reclamación sea finalmente aceptada, Ezepeleta abonará al cliente los portes en los que haya incurrido para el envío de los productos, procediendo asimismo a hacerse cargo de las acciones necesarias para corregir los defectos y reenviar los productos al cliente. Siempre que la devolución se origine por motivos no imputables a Ezepeleta el abono se efectuará por el 90% del valor total de la mercancía reflejado en factura. En este caso los portes correrán a cargo del cliente.

GARANTÍA:

Ezepeleta garantiza sus productos según la legislación vigente siempre cuando hayan sido utilizados en condiciones normales.

+ INFO: www.ezepeleta.com

CONDIÇÕES GERAIS (PT)

Estas tabelas de preços e condições gerais de venda, substituirão todas as anteriores e aplicam-se a partir de Janeiro de 2024.

PORTES:

Península (ES/PT)

- Para pedidos superiores a 1000 euros, portes pagos.
- Para pedidos entre 600 e 1000 euros, 70 euros de portes.
- Para pedidos inferiores a 600 euros, 100 euros de portes.

Ilhas (Canarias/Islands Baleares/Andorra)

- Para pedidos superiores a 1500 euros, portes pagos
- Para pedidos inferiores a 1500 euros, preço de portes sob consulta

Repastos (ES/PT), Península – 30€ / Ilhas – Sob Consulta

Exportação – Sob consulta

Os preços incluídos nesta tabela NÃO incluem o I.V.A ou qualquer outro tipo de imposto, que seria acrescentado aos mesmos de acordo com a legislação em vigor e com o país para o qual são faturados os artigos. Consultar os descontos.

A Ezepeleta reserva-se o direito de rever a tabela de preços em qualquer momento em caso de flutuações nos custos laborais, das matérias primas ou outros fatores.

ENCOMENDAS:

Todas as encomendas deverão ser processadas por escrito de acordo com a referência de cada produto indicado na tabela de preços e deverão ser assinadas ou carimbadas pelo comprador e verificadas pelo gestor comercial, dando assim a sua concordância à encomenda.

A venda apenas será validada com a aceitação por escrito da encomenda por parte do comprador. Qualquer ordem verbal, incluindo telefónica, só terá efeito se formalizada por escrito à Ezepeleta. A Ezepeleta poderá, a seu critério, rejeitar as encomendas do comprador em caso de incumprimento destas condições. Em caso de aceitação de uma encomenda por parte da Ezepeleta com indicação de pagamento antecipado de parte ou da totalidade do valor da encomenda, o contrato apenas será considerado concluído e a produção não terá início, até à recepção do pagamento solicitado.

Para as encomendas consideradas “especiais”, ou seja, pedidos que não são produtos de catálogo e são fabricados de forma não padronizada, será obrigatório o pagamento de 50% do valor no momento da confirmação para que a Ezepeleta inicie a produção

ALTERAÇÕES NO ASPETO DOS ARTIGOS:

Os artigos descritos neste documento poderão eventualmente sofrer alterações mínimas no seu aspeto ou acabamento, resultado da vontade da EZPELETA de melhorar continuamente os mesmos. Na medida do possível, a EZPELETA tentará que ditas alterações sejam pouco significativas e que o cliente seja informado da existência das mesmas antes do envio dos pedidos ou aquando da confirmação dos mesmos. A EZPELETA não aceitará, no entanto, reclamações com base neste conceito.

NOVOS ARTIGOS DISPONÍVEIS:

A nossa equipa comercial está permanentemente informada das novas introduções na nossa gama de produtos. Pedimos portanto que consulte a nossa equipa sempre que não encontrar o artigo que procura neste catálogo.

IMAGENS, LOGOTIPO E INFORMAÇÃO GRÁFICA:

Todas as imagens realizadas pela Ezepeleta, incluindo o seu logotipo e informação gráfica são propriedade da Ezepeleta e não podem ser utilizadas, reproduzidas, modificadas ou publicadas online sem prévio consentimento por escrito por parte da Ezepeleta. Os clientes que obtenham dita autorização devem manter os nomes dos produtos como indica a Ezepeleta nos seus catálogos e publicá-los com a marca Ezepeleta.

RECLAMAÇÕES E DEVOLUÇÕES:

- 1.- As **incidências relativas ao transporte**, sempre que se detetem degradações nos produtos ou nas embalagens no momento da sua receção, devem indicar-se na guia do transportador ou CMR e comunicar-se à Ezepeleta num prazo máximo de **48 horas úteis após a receção**. Caso não se cumpra nenhum destes requisitos, a reclamação não será aceite.
- 2.- As reclamações de mercadoria por **NO conformidade** na entrega devem fazer-se até 8 dias úteis após a data de receção.
- 3.- No caso de **reclamações alheias ao transporte** e que dêem lugar à devolução da mercadoria, logo que a Ezepeleta receba os artigos objetos da reclamação e, caso esta reclamação seja finalmente aceite, a Ezepeleta creditará ao cliente os custos suportados para o envio dos produtos. E, por conseguinte, procederá à realização das ações necessárias para a correção dos defeitos e ao reenvio dos produtos ao cliente. Sempre que se realize uma devolução por motivos não imputáveis à Ezepeleta a nota de crédito far-se-á por 90% do valor total da mercadoria refletido na fatura. Neste caso os portes são por conta do cliente.

GARANTIA:

A Ezepeleta garante os seus produtos ao abrigo da legislação vigente sempre que utilizados em condições normais.

+ INFO: www.ezepeleta.com

GENERAL CONDITIONS (EN)

This price list and general sales conditions replace all previous ones and will be applied from January 2024.

SHIPPING:

Peninsula (Spain/Portugal)

- For orders exceeding 1000 euros, free shipping.
- For orders between 600 euros and below 1000 euros, shipping cost is 70 euros.
- For orders below 600 euros, shipping cost is 100 euros.

Islands (Canary Islands/Balearic Islands/Andorra)

- For orders exceeding 1500 euros, free shipping.
- For orders below 1500 € must be consulted.

Export shipping must be consulted

The prices within this list exclude VAT and any other taxes, which will be added according to the legislation of the client's country. Please consult the discounts list. Ezepeleta reserves the right to review the price list at any time, in case of fluctuations of the raw material cost, labour costs and/or other factors.

ORDERS:

All orders must be processed in writing according to the nomenclature for each product in the price list and must be signed or stamped by the buyer and verified by the sales representative, confirming the buyer's agreement to the order.

The sale will be considered confirmed only upon the Buyer's written acceptance of the order. Any verbal order, even if by phone, will only be effective if confirmed in writing to Ezepeleta. Ezepeleta may at its discretion reject the Buyer's orders in case of non-compliance with this condition. In case Ezepeleta accepts an order with the indication of prepayment of a part or the total amount of the order, the contract will be considered concluded, and production will not commence until the requested payment is received.

Orders labeled as "special," meaning those not catalog products and produced in a non-standardized manner, will require 50% payment at the time of confirmation for Ezepeleta to commence production.

CHANGES IN THE PRODUCTS ASPECT:

The products shown on this price list can undergo minimal changes in their aspect or finishing as a consequence of the continuous improvement that Ezepeleta wants to achieve.

Our designers will try to minimize these changes as much as possible, and will make an effort to inform our clients when they place their orders, or before we send the goods. Ezepeleta will not accept any complaints based on this matter. Ezepeleta reserves the right to review the price list at any time, in case of fluctuations of the raw material cost, labour costs and/or other factors.

NEW PRODUCTS AVAILABLE:

Our sales team is always informed about the introduction of new products. So we ask you to please consult with our sales representatives if you can't find the product you need in this catalogue.

IMAGES, LOGO AND GRAPHIC INFORMATION:

All images made by Ezepeleta, including its logo and graphic information are the property of Ezepeleta and may not be used, reproduced, modified or published on-line without the prior written consent of Ezepeleta. Customers who obtain such authorisation must keep the names of the products as indicated by Ezepeleta in their catalogues and publish them under the Ezepeleta brand name.

COMPLAINTS AND RETURNS:

1- **Eventual discrepancies**, missing or damaged goods, found while unloading, in the packaging or in the product, must be duly noted on the delivery note or CMR and timely reported in writing to Ezepeleta, not later than **48 hours after reception**. If those conditions are not complied, Ezepeleta will not accept the complaint.

2- Any **lack of conformity** upon receipt of the goods must be communicated no later than 8 working days since the date of reception.

3- In case of **complaint not related to transport** and gives rise to the return of goods, they will be analyzed as soon as Ezepeleta receives them, and if the complaint is accepted, the shipping costs will be credited. And therefore, Ezepeleta will take all the necessary corrective measures to return the goods in perfect conditions to the client. Whenever a client returns goods for reasons not imputable to Ezepeleta, the credit of these goods will be up to 90% of the value reflected in the invoice. In this case, the shipping costs will be at the client's account.

GUARANTEE:

Products are guaranteed, according to the law, against all manufacturing defect when used in ordinary conditions.

+ INFO: www.ezepeleta.com

CONDITIONS GÉNÉRALES (FR)

Ces tarifs et conditions générales de vente remplacent toutes les précédentes et seront applicables à partir de Janvier 2024.

EXPÉDITION:

Péninsule (ES/PT)

- Pour les commandes supérieures à 1000 euros, frais de port payés.
- Pour les commandes comprises entre 600 euros et moins de 1000 euros, 70 euros de frais de port.
- Pour les commandes inférieures à 600 euros, 100 euros de frais de port.

Îles (Îles Canaries/Îles Baléares/Andorre)

- Pour les commandes supérieures à 1500 euros, frais de port payés
- Consulter le prix pour les commandes inférieures à 1500 euros

Pièces détachées (ES/PT), Péninsule – 30 € / Consulter le prix pour des envois îles (Îles Canaries/Îles Baléares/Andorre);

Pour l'exportation, prix sur demande

Les prix indiqués sur ces tarifs sont des prix PVP hors taxe, qui n'incluent ni TVA ou tout autre type d'impôt, qui devront être contemplés à posteriori selon la législation de chaque pays. Concernant les remises, veuillez contacter notre département commercial.

Ezepeleta se réserve le droit de modifier le tarif à tout moment, sans avis préalable en raison d'une augmentation du prix de la matière première, du coût de la main d'oeuvre et/ou autres facteurs.

COMMANDES:

Toute commande doit être traitée par écrit selon la référence de chaque produit figurant dans la grille tarifaire, et doit être signée ou cachetée par l'acheteur et vérifiée par le responsable commercial, donnant ainsi son accord. La vente ne sera considérée et confirmée qu'avec l'acceptation écrite de la commande par l'acheteur. Toute commande verbale, y compris téléphonique, ne sera validée que si celle-ci est confirmée par écrit à Ezepeleta. Ezepeleta pourra, à sa volonté, refuser les commandes de l'acheteur en cas de non-respect de ces conditions. En cas d'acceptation d'une commande par Ezepeleta avec indication de paiement anticipé d'une partie ou de la totalité du montant, le contrat sera considéré comme conclu et la production ne commencera qu'après réception du paiement demandé.

Les commandes dites « spéciales », c'est-à-dire les commandes qui ne sont pas des produits du catalogue et qui sont fabriquées de manière non standardisée, un acompte de 50 % devra être versé lors de la confirmation, afin qu'Ezepeleta puisse commencer la production.

VARIATIONS QUANT À L'ASPECT DES PRODUITS:

Les produits décrits sur ce document pourront éventuellement présenter quelques petites variations au niveau de leur aspect ou finitions réalisées par Ezepeleta, avec comme principal objectif une amélioration de ceux-ci. Dans la mesure du possible, EZEPELETA fera en sorte que ces éventuelles variations soient peu significatives et que celles-ci soient immédiatement informées auprès de nos clients avant toute commande ou lors de la confirmation de celle-ci. EZEPELETA n'acceptera aucun cas, aucune réclamation basée sur ce motif.

IMAGES, LOGO ET INFORMATION GRAPHIQUE:

Toutes les images réalisées par Ezepeleta, toute comme le logo et l'information graphique sont propriétés d'Ezepeleta et ne peuvent pas être utilisées, reproduites, modifiées ou reproduites sur la Web sans au préalable une autorisation écrite de notre groupe. Le client en ayant obtenu l'autorisation est également tenu de maintenir les noms des produits comme indiqué sur le catalogue d'Ezepeleta et de les publier avec la marque Ezepeleta.

NOUVEAUX PRODUITS DISPONIBLES:

Notre département commercial est continuellement informé de l'introduction de nouveautés au sein de notre collection. Nous vous invitons ainsi à les consulter pour tout type de situation où vous ne trouveriez le produit recherché sur ce catalogue.

RÉCLAMATIONS ET DÉVOLUTIONS:

1- **Les incidences liées au transport** : toutes dégradations constatées lors du déchargement sur le produit ou sur l'emballage, devront faire l'objet d'une réserve sur le bon de transport ou CMR, et, devront être communiquées à Ezepeleta sous un délai de **48H ouvrées après réception**. Si ces conditions ne sont pas appliquées, toute réclamation ne pourra être traitée et acceptée par EZEPELETA.

2- Les réclamations concernant une **non-conformité** de marchandise lors de la livraison, celles-ci devront être émises sous un délai de 8 jours ouvrés après réception.

3- Lorsque les **réclamations ne sont pas liées au transport** et peuvent donner lieu à un retour de la marchandise, celles-ci ne seront acceptées que si autorisation préalable écrite de la part d'Ezepeleta. Dans le cadre d'un retour accepté par Ezepeleta, celui-ci donnera lieu à un avoir envers le client des frais de ports encourus pour la livraison des produits chez Ezepeleta, qui, par la suite procédera aux actions nécessaires pour corriger tout défaut et ainsi renvoyer les produits au client. Cependant, et face à toute situation où la dévolution de la marchandise est liée à une situation non imputable à Ezepeleta, dès réception de celle-ci, un avoir sera réalisé à hauteur de 90% du montant total facturé lors de l'expédition et dans le cas précis, les frais de ports liés à la dévolution, seront à la charge du client, sauf si accord au préalable par notre département commercial.

TERMES DE GARANTIE:

Nos produits sont garantis au terme de la loi, contre les défauts de fabrication, dans des conditions normales d'utilisation, pour une durée de 2 ans date d'achat. Tous défauts de qualité doivent être communiqués par écrit et accompagnés d'une photo du produit défectueux à notre département commercial pour ouverture d'une procédure SAV.

